



International Business Machines Corporation

Information Products Division

Form No. S544-4212-1

Printed in USA

P/N 1432631

7/89

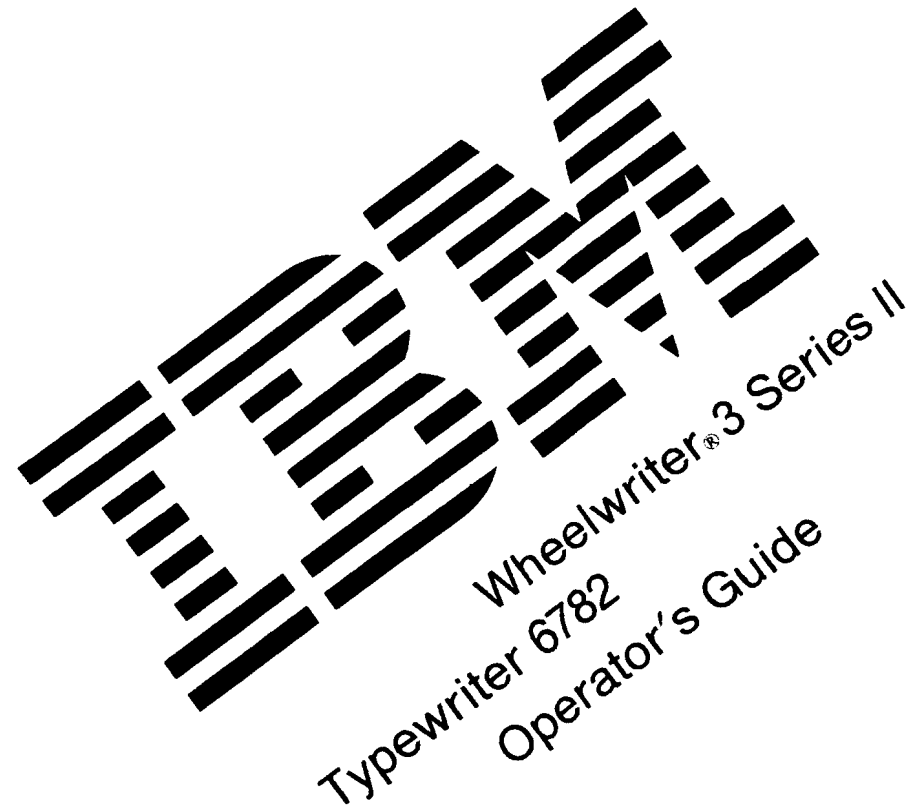

S544-4212-01

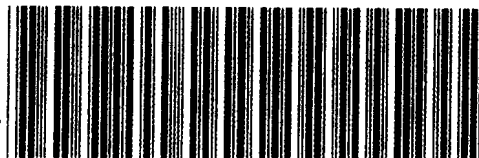

Second Edition (February 1988)

The following paragraph does not apply to the United Kingdom or any country where such provisions are inconsistent with local law:

INTERNATIONAL BUSINESS MACHINES CORPORATION PROVIDES THIS PUBLICATION "AS IS" WITHOUT WARRANTY OF ANY KIND, EITHER EXPRESS OR IMPLIED, INCLUDING, BUT NOT LIMITED TO, THE IMPLIED WARRANTIES OF MERCHANTABILITY OR FITNESS FOR A PARTICULAR PURPOSE. Some states do not allow disclaimer of express or implied warranties in certain transactions, therefore, this statement may not apply to you.

This publication could include technical inaccuracies or typographical errors. Changes are periodically made to the information herein; these changes will be incorporated in later editions of the publication. IBM may make improvements and/or changes in the product(s) described in this publication at any time.

Publications are not stocked at the address below. For copies, contact your IBM Authorized Dealer.

You can send comments or suggestions using the form in the back of this manual. If the form has been removed, simply address your comments to the IBM Corporation, Dept. F98/962-3, 740 New Circle Road N.W., Lexington, KY 40511, USA. Information you supply may be used by IBM without obligation. You may, of course, use it yourself. Necessary changes will be made in later editions of the manual.

References to IBM products, programs, or services do not imply that IBM intends to make them available outside the United States.

© Copyright International Business Machines Corporation 1987, 1988.
All Rights Reserved.

FCC Notice

The IBM Wheelwriter® 3 Series II Typewriter 6782 generates and uses radio frequency energy. If the typewriter is not installed and used in accordance with the installation instructions, operating instructions, and service manual, it may interfere with radio or television reception. This typewriter has been tested and found to comply with the limits for a Class B computing device pursuant to Subpart J of Part 15 of FCC rules, which are designed to provide reasonable protection against such interference when operated in a residential area.

If this typewriter interferes with radio or television reception, which can be determined by switching the typewriter off and on, the user is encouraged to try one or more of the following:

- Move the receiving antenna on the radio or television.
- Relocate the typewriter in relation to the radio or television.
- Plug the typewriter into a different electrical outlet from the radio or television.

If necessary, consult your IBM Authorized Dealer. If anyone other than an IBM Authorized Dealer modifies the typewriter and it causes interference, the user is responsible for correcting the interference.

Safety Information

This machine has additional insulation which provides extra protection against the risk of electric shock and does not rely on grounding. This machine has a nongrounding-type (2-wire) power cord because grounding is not necessary.

For continued protection against the risk of electric shock and personal injury:

- Connect the machine only to an outlet of the correct voltage. The voltage your machine will accept is indicated on the machine.
- Make sure the machine is turned off (O) before you connect or disconnect the power cord or interconnecting cables.
- Do not use the machine in an area where it can become wet.
- Keep hair and personal articles away from moving parts in the machine to avoid the possibility of getting them caught.
- Refer service or repair to qualified service personnel.
- There may be some increased risks of electric shock and personal injury during disassembly and servicing of this machine. Professional service personnel should understand this and take necessary precautions.
- The safety features of some parts may not always be obvious. Therefore, replacement parts must have the identical or equivalent characteristics as the original parts.
- The maintenance information for this machine has been written for the professional service person and is not intended to be used by others.

About Your Typewriter

Congratulations! You are about to experience typing with your new IBM Wheelwriter® Series II Typewriter.

The IBM Wheelwriter® Series II Typewriter is designed with special features such as Automatic Centering and Underlining. These features are designed to make your typing jobs easier, faster, enjoyable, and more productive.

This typewriter is like having three typewriters in one. You can type in either pica, elite, or micro elite. Also, you have a choice of single, one-and-one-half, double, or triple spacing.

Just tell your IBM Wheelwriter® Series II Typewriter what you want it to do!

The following option is available for your typewriter:

- Soundhood

The typewriter can also be upgraded to other models. For more information, contact your IBM Authorized Dealer.

Contents

Basic Operations	1-1
Parts of the Typewriter	1-1
Keyboard Height Adjust Levers	1-2
Inserting Paper	1-3
Moving Paper	1-4
Removing Paper	1-4
Line Space Key	1-5
Shift and Lock Keys	1-5
Typematic (Repeat) Keys	1-6
Page End Indicator and Scale	1-7
Cardholder	1-8
Printwheels	1-9
Automatic Pitch Selection	1-10
Margin/Pitch Scale	1-11
Standard Margins and Tabs	1-12
Margins	1-13
Tabs	1-14
Correction Memory	1-15
Advanced Operations	2-1
Code Key	2-1
Centering	2-2
Underlining	2-4
Special Characters	2-5
Impression Control	2-5
Caps Key	2-6
One-Half Backspace	2-7
Problem Determination	3-1
Problem Determination Index	3-1
Beeper and Light Signals	3-2
Erase Problems	3-3
Typewriter Problems	3-4
Typing Problems	3-5
Reference	4-1
Ordering Procedures for IBM Supplies	4-1
Typestyle Samples	4-1
Printwheel Application Recommendations	4-4

Printwheels	4-6
Ribbon Cassette System	4-8
Ribbon Application Recommendations	4-10
Ribbon Cassette Reorder Numbers	4-11
Care and Maintenance	4-12
Serial Number	4-12
Index	X-1

Basic Operations

Parts of the Typewriter

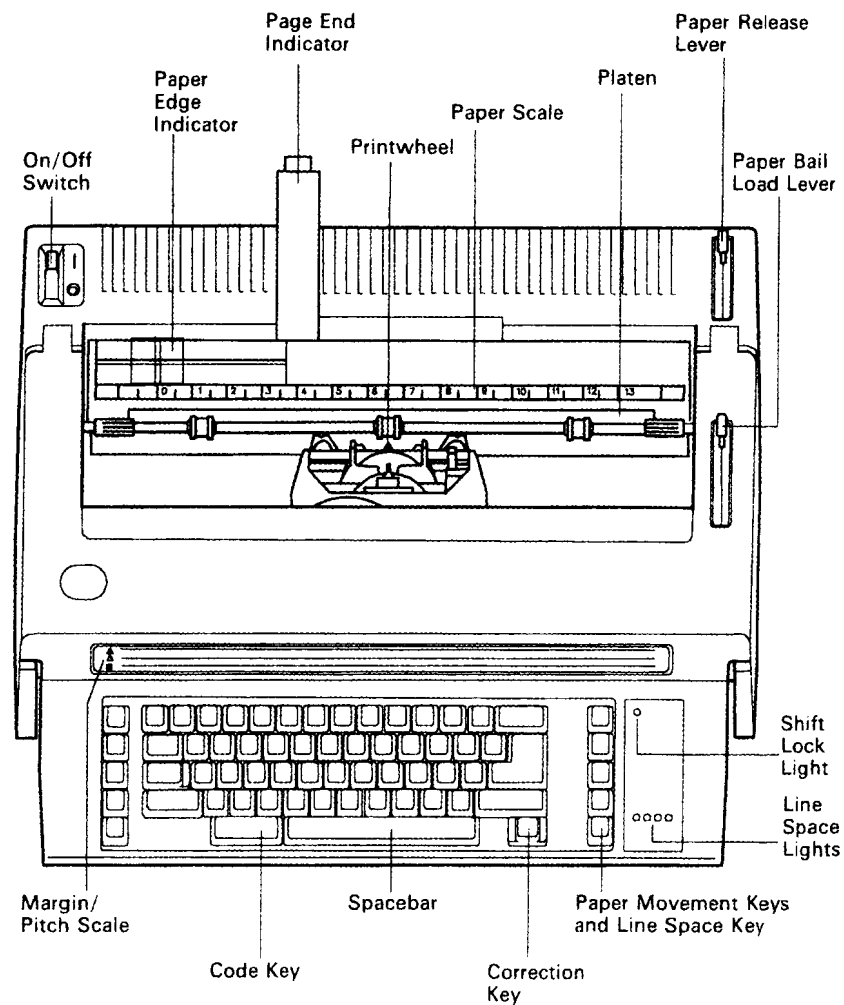

Keyboard Height Adjust Levers

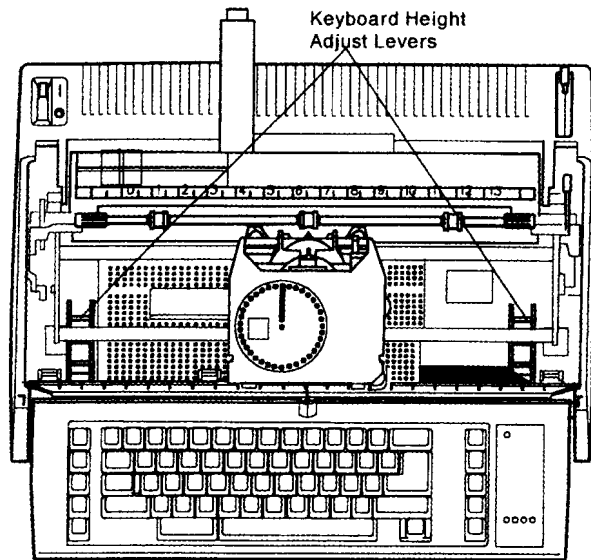

The keyboard can be raised or lowered to the most comfortable position by using the keyboard height adjust levers. There are three positions: low, medium, high.

1. Use the **Spacebar** to move the carrier to the center of your typewriter.
2. Turn the typewriter off.
3. Raise the top cover.
4. Locate the two blue keyboard height adjust levers. They are located on the inside of the typewriter on the right and left sides of the bottom panel.
5. Push down on the levers and slide them to the desired position until they lock into place.
 - When the levers are all the way forward, the keyboard is in the *high* position.
 - When the levers are in the middle, the keyboard is in the *medium* position.
 - When the levers are all the way back, the keyboard is in the *low* position.
6. Make sure that you have both levers locked into the same position.

Inserting Paper

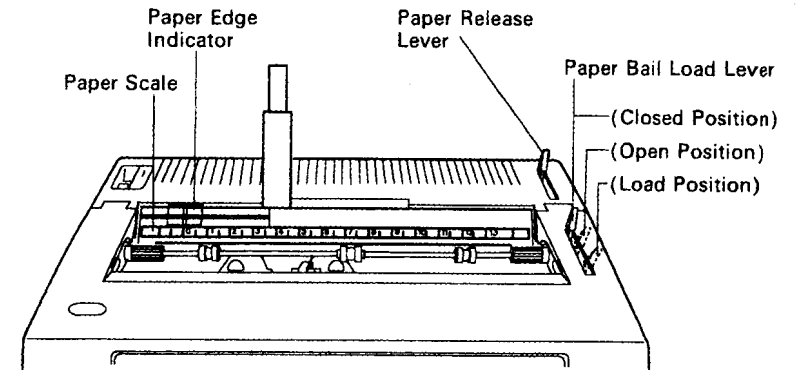

The typewriter has a paper bail load lever to assist you in loading the paper semiautomatically. The lever has three positions: closed, open, and load.

1. Make sure the typewriter is turned on.
2. Push the paper release lever all the way to the back of the typewriter.
3. Align the center of the paper edge indicator with the vertical line to the left of zero (0) on the paper scale.
4. Align the left edge of the paper with the vertical line in the center of the paper edge indicator.
5. Pull the paper bail load lever all the way forward to the load position. When the paper begins to feed, let go of the paper bail load lever.
 - The paper feeds to approximately one inch from the top of the paper.
6. Push the paper bail load lever all the way back until the paper bail holds the paper against the platen.

Note: When inserting loose carbon copies (five maximum), pull the paper release lever forward. Insert the copies, then push the lever all the way back.

Moving Paper

You have four keys to move your paper up or down in the typewriter:
Paper Up, **Paper Down**, **Micro Up**, and **Micro Down**.

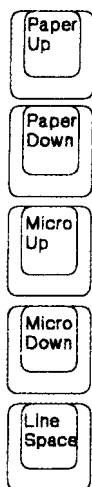

- Press **Paper Up** to move the paper up one-half line.
- Press **Paper Down** to move the paper down one-half line.
- Press **Micro Up** to move the paper up 1/48 of an inch.
- Press **Micro Down** to move the paper down 1/48 of an inch.

Removing Paper

1. Pull the paper bail load lever toward you.
2. Pull the paper release lever toward you.
3. Remove the paper.
4. Push the paper release lever back.
5. Push the paper bail load lever back.

Note: You may also press and hold down the **Paper Up** key or pull the paper bail load lever forward several times to remove paper.

Line Space Key

Your typewriter lets you choose four line space settings: 1, 1½, 2, or 3. Line spacing is the amount of space between the lines of type. The **Line Space** indicator lights tell you which line spacing you are using.

Press the **Line Space** key to set the line spacing. Keep pressing the key until the desired **Line Space** light is on.



Shift and Lock Keys

Use the **Shift** and **Lock** keys to type uppercase characters (all capitals).

The **Lock** key allows you to type continuously in uppercase without pressing the **Shift** key each time. A **Shift Lock** light comes on to let you know that Shift Lock is on.

Locking Shift

Press **Lock**.

- The **Shift Lock** light comes on.
- *All* characters print in uppercase.

Unlocking Shift

Press either the left or right **Shift** key to unlock the **Lock** key.

- The **Shift Lock** light goes off.

Typematic (Repeat) Keys

Typematic (repeat) keys have both a single and a repeat action. Any of these keys can be touched briefly for a single action, or held down for repeat action.

Asterisk/8
Backspace
Carrier Return
Correction Key
Micro Down
Micro Up
Paper Down
Paper Up
Period
Plus/Equal
Question Mark/Slash
Spacebar
Underline/Hyphen
X, x

For example, if you press the letter **X**, an **X** prints on your paper. If you hold down the **X** key for more than one-half second, **X** prints repeatedly until you release the key.

Page End Indicator and Scale

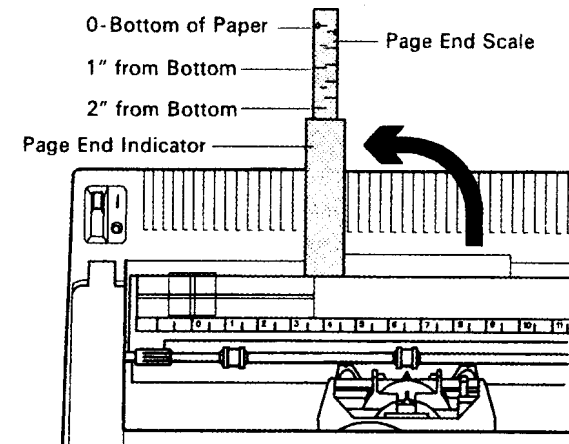

1. Raise the page end indicator until it is straight up.
2. Pull the page end scale all the way out until it locks into place.
 - As you type, the top of the paper comes out of the typewriter and moves up to the lines on the scale.
 - The lines on the scale tell you approximately how much space remains to the bottom of 27.9 cm (11 in) paper.
 - The left side of the scale is marked in inches. The right side is marked in centimeters.

Cardholder

The cardholder holds paper, cards, and envelopes against the platen.

The printwheel pointer shows the position where the next character will print.

The top red portion (A) of the cardholder indicates the base of the typing line. As you type, the bottom of each character rests just above the line, as shown below.

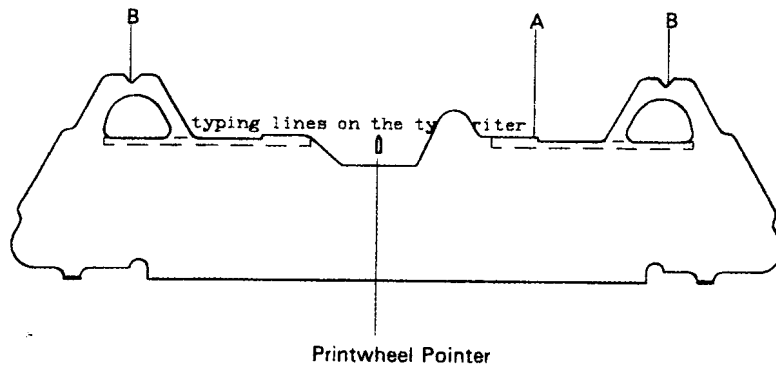

You may use the notches (B) to draw vertical lines.

- Hold a pencil or pen against one of the notches while pressing **Paper Up** or **Paper Down** to move the paper.

Printwheels

Printwheel Identification

Your typewriter uses an IBM Cartridge Printwheel II. Printwheels are available in many different typestyles and pitches. See pages 4-1 through 4-3 for typestyle samples and a list of typestyles. You can choose from three different pitches as shown in the chart on the following page.

The illustration below shows where to find the typestyle, pitch, and reorder number on the printwheel.

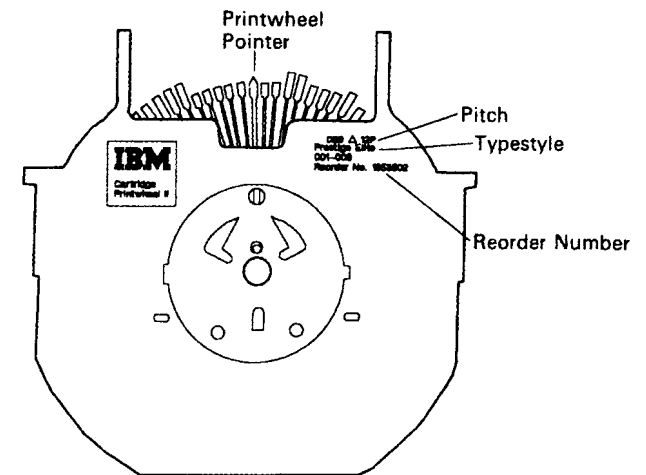

Choosing a Printwheel

A printwheel in 10 or 12 pitch is recommended for use while you are learning to use your typewriter. All examples or practices in this manual are illustrated in 12 pitch.

Storing and Handling Printwheels

The printwheel petals can be damaged by paper clips, staples, or other objects. When printwheels are not being used, always store them in a clean, flat area.

Automatic Pitch Selection

The correct pitch is automatically selected by the typewriter when you install a printwheel. The pitch determines the number of characters typed per horizontal inch.

The following table summarizes printwheel pitches with print examples of each pitch.

Pitch (Type Size)	Characters Per Inch	Pitch Symbol	Print Example
10P (Pica)	10	▲	This is a sample.
12P (Elite)	12	△	This is a sample.
15P (Micro Elite)	15	■	This is a sample.

Lines Per Vertical Inch

A printwheel for 10 or 12 pitch prints six lines per vertical inch.

A printwheel for 15 pitch prints eight lines per vertical inch.

Margin/Pitch Scale

The typewriter has three margin scales: 10▲, 12△, and 15■. When typing, use the scale line that matches the pitch symbol on your printwheel.

- For 10▲ pitch (pica) type, use the upper scale.
- For 12△ pitch (elite) type, use the middle scale.
- For 15■ pitch (micro elite) type, use the lower scale.

An orange pointer moves along the scale on your typewriter to show the position of the next character to print.

The margin/pitch scale also contains centering marks. When the left edge of the paper lines up with zero on the margin/pitch scale:

- marks the approximate center of paper 215.90 mm (8.50 in) wide.
- ! marks the approximate center of paper 210 mm (8.27 in) wide.

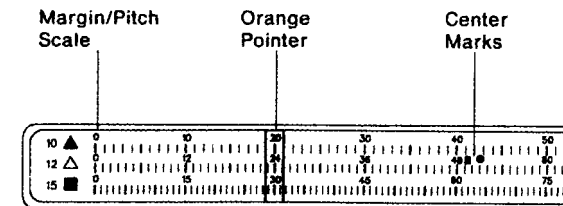

Standard Margins and Tabs

Every time you turn your typewriter off and on, standard margins and tabs are set automatically. *Leave your typewriter turned on to save your own margins and tabs.*

	10 Pitch	12 Pitch	15 Pitch
Left margin	10	12	15
Right margin	70	84	105

Standard tabs are set every one-half inch in 10 and 12 pitch, and *approximately* every one-half inch in 15 pitch.

Margins

Setting the Left Margin

1. Press **Spacebar** or **Backspace** to move the carrier to the desired left margin position.
2. Press **LMar**.

Setting the Right Margin

1. Press **Spacebar** or **Backspace** to move the carrier to the desired right margin position.
2. Press **RMar**.
 - To check the right margin setting, space toward the right margin and listen for a beep. You should hear the beep approximately five spaces before the right margin setting.

Releasing the Left Margin

1. Return the carrier to the left margin.
2. Press **MarRel**.
3. Backspace through the left margin.
 - To set a new left margin, backspace to the desired position, then press **LMar**. The old margin is eliminated automatically.

Note: *Leave your typewriter turned on to save your margins.*

Tabs

Setting a Tab

1. Press **Spacebar** or **Backspace** to move the carrier to the desired tab position.
2. Press **TSet**.
3. Repeat these steps to set each additional tab. You can set a maximum of 18 tabs.

Clearing a Tab

1. Press **Tab** to move the carrier to the tab you want to clear.
2. Press **TClr**.
3. Repeat the steps to clear each individual tab.

Clearing All Tabs

Press and hold down **TClr** while you press **CRtn**.

- The carrier returns to the left margin.
- All tabs are cleared.
- The carrier may be at any position to clear all tabs.

Note: Leave your typewriter turned on to save your tab settings.

Correction Memory

Your typewriter has a one-line correction memory which remembers the line you are typing, up to 72 characters.

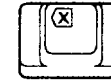

Correction
Key

Press the **Correction** key.

- The character is automatically erased.

Erasing a Character Farther Back on the Same Line

You can erase an incorrect character farther back on the same line without erasing the correct characters.

1. Press **Backspace** to move the carrier to the incorrect character.
2. Press the **Correction** key.
 - The character is automatically erased.
3. Type the correct character.

Erasing Characters on Another Line

You cannot erase a character on another line automatically. Remember, the one-line memory is erased when you press **CRtn**, **Tab**, **Code** + **Bksp 1/2**, or when you use the paper movement keys.

1. Position the carrier at the incorrect character.
 - Press **Paper Up**, **Paper Down**, **Spacebar**, or **Backspace**.
2. Press the **Correction** key.
 - The printwheel spins.
3. Type the incorrect character *just like you typed it the first time*.
 - The typewriter erases the character you just typed.

Centering

You can automatically center words between the left and right margins or at any point.

Centering between the Left and Right Margins

1. Start at the left margin by pressing **CRtn**.
 - The carrier must be positioned at the left margin.
2. Hold down **Code** while you press **C (Ctr)**.
 - The carrier moves to the center point between the margins.
 - The printwheel spins.
3. Type the words you want centered.
 - As you type, the carrier backs up without printing.
 - If you center more than 72 characters, the typewriter beeps once and ignores any additional characters you type.
 - If you make an error, press the **Correction** key and type the correct character.
4. Hold down **Code** while you press **C**.
 - The centered words print.

Note: The centered words also print when you press **Tab** or **CRtn**.

Centering at Any Other Point

1. Press **Tab** or **Spacebar** to position the carrier at the desired center point.
2. Hold down **Code** while you press **C (Ctr)**.
 - The printwheel spins.
3. Type the words you want centered.
 - As you type, the carrier backs up without printing.
 - If you center more than 72 characters, the typewriter beeps once and ignores any additional characters you type.
 - If you make an error, press the **Correction** key and type the correct character.
4. Hold down **Code** while you press **C**.
 - The centered words print.

Note: The centered words also print when you press **Tab** or **CRtn**.

Helpful Hints

To cancel centered characters before they print:

1. Press the **Correction** key until the carrier stops moving forward.
2. Hold down **Code** while you press **C**, **Tab**, or **CRtn**.
 - Nothing prints; centering is canceled.
 - Pressing the **Correction** key after typing nonprinting key-strokes like **Paper Up** or **Code + U (Undin)** moves the centering point forward one space.

Note: Centered information cannot be erased automatically.

Underlining

The Automatic Underlining function lets you automatically underline characters, words, or lines as you type.

Turning Underlining On

Hold down **Code** while you press **U (UndIn)**.

- The printwheel spins.
- Everything you type will be underlined until you turn Underlining off.

Turning Underlining Off

Hold down **Code** while you press **U**.

- The printwheel spins.
- The typewriter stops underlining.

Centering and Underlining at the Same Time

1. Position the carrier at the desired centering point.
2. Hold down **Code** while you press **C**.
3. Hold down **Code** while you press **U**.
4. Type the words to be centered and underlined.
5. When you are finished typing, hold down **Code** while you press **U**, then hold down **Code** while you press **C**.

Special Characters

Your typewriter has four special characters that you can print by using the **Code** key: **§**, **¶**, ², ³. You can print these characters without changing the printwheel.

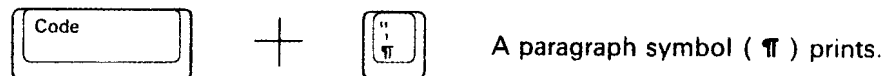

Impression Control

The impression control can be set for two positions: normal and heavy.

The impression control is set to normal when you turn the typewriter on.

- To set the impression control to heavy, hold down **Code** while you press **Q**. The impression becomes heavy.
- To set the impression control to normal, hold down **Code** while you press **Q**. The impression returns to normal.

Note: For higher quality corrections, use the same impression setting that you used to type the text.

Caps Key

The Caps function allows you to type capital letters while typing numbers and lowercase punctuation without using the **Shift** or **Lock** key.

Turning Caps On

1. Make sure the **Shift Lock** light is turned off.
2. Hold down **Code** while you press **N (Caps)**.
 - All letters are typed in uppercase (capital letters).
 - All numbers and punctuation are typed in lowercase.

Turning Caps Off

Hold down **Code** while you press **N (Caps)**.

- All letters return to lowercase.

Helpful Hints

- The **Shift Lock** light must be turned off before Caps can be turned on.
- While Caps is turned on, press the **Shift** key to type uppercase symbols (on the numbers row) and uppercase punctuation marks.

One-Half Backspace

The carrier moves back *one-half* space when you hold down **Code** while you press the **Backspace (Bksp 1/2)** key. Use **Bksp 1/2** when you want to insert an extra character in a word.

1. Erase the entire word, starting from right to left.
2. Hold down **Code** while you press **Bksp 1/2**.
 - The carrier moves back one-half space.
3. Type the word.
4. Hold down **Code** while you press **Bksp 1/2**.
 - The carrier moves back one-half space to reposition the carrier to the normal spacing.
5. Press **Spacebar** or the paper movement keys to move the carrier to the original typing position.

Problem Determination

How to Use This Chapter

If you have a problem while using your typewriter, use this section to help you solve the problem. Before you call for service:

1. Locate your problem in this index.
2. Turn to the page referenced.
3. Complete as many steps as needed to correct the problem.
 - Try using the typewriter after completing each step.
4. If you cannot correct the problem or need help completing the steps, call your IBM Authorized Dealer.

Problem Determination Index

Beeper and Light Signals	3-2
Beeper Signals Three Times	3-2
Beeper Signals Six Times and One or More Lights Blink	3-2
All Lights Stay On or Blink Continuously/No Lights Come On ..	3-2
Erase Problems	3-3
Correction Key Does Not Erase All of the Character or	
Correction Leaves Shadow	3-3
Typewriter Problems	3-4
Typewriter Dead (No Lights Come On)	3-4
Typewriter Operates Hot	3-4
Typewriter Too Noisy	3-4
Typing Problems	3-5
Characters Do Not Print	3-5
Characters Spaced Incorrectly or Wrong Characters Print	3-5
Characters Print Too Lightly	3-6
Line Spacing Aligns Incorrectly or Paper Feeds Incorrectly ..	3-6

Beeper and Light Signals

Beeper Signals Three Times

Wait until the typewriter stops printing, then continue typing. You were typing faster than the typewriter could accept your typing.

Beeper Signals Six Times and One or More Lights Blink

1. Make sure the printwheel, ribbon cassette, and correction tape are installed correctly.
2. Turn the typewriter off, wait at least 30 seconds, then turn the typewriter on again. If the same thing happens, install another printwheel.
3. Turn the typewriter off, wait at least 30 seconds, then turn the typewriter on again. If the same thing happens, call for service.
 - Tell your service person which lights are blinking when you place the call.

All Lights Stay On or Blink Continuously/No Lights Come On

Turn the typewriter off, wait at least 30 seconds, then turn the typewriter on again. If all the lights still stay on, call for service.

If no lights come on, see "Typewriter Dead (No Lights Come On)" on page 3-4.

Erase Problems

Correction Key Does Not Erase All of the Character or Correction Leaves Shadow

1. Make sure the ribbon and correction tape cassettes are *fastened* together correctly. (See page 4-9 in the Reference section.)
 - Make sure the center latch is latched securely.
 - Make sure the gray tabs are pressed in.
2. Make sure the ribbon and correction tape cassettes are *installed* in the typewriter correctly.
3. Try a lighter impression setting.
4. Try plain bond paper.
5. Try a new correction tape.
6. Look for folds in the paper.
7. Look for objects under the typewriter.
8. Make sure the typewriter is on a level surface.

Typewriter Problems

Typewriter Dead (No Lights Come On)

1. Make sure the typewriter cord is plugged into the back of the typewriter and also into a wall outlet.
2. Make sure the extension cord, if you are using one, is plugged into the typewriter cord and the wall outlet.
3. Turn the typewriter off, wait at least 30 seconds, then turn the typewriter on again.
4. Look to see if any other equipment plugged into the same wall outlet operates.
5. Make sure the wall outlet does not turn off with the room lights.

Typewriter Operates Hot

1. Make sure nothing is blocking the top, rear, or bottom typewriter vents.
2. Make sure the typewriter is at least three inches away from the wall on all sides and is not near a heater.

Typewriter Too Noisy

1. Make sure the cover and soundhood (if attached) are snapped down tightly.
2. Move any objects touching the typewriter cover or objects inside or under the typewriter.
3. Check the typing table or desk. (Metal tables can make the typewriter sound noisy.)

Typing Problems

Characters Do Not Print

1. Press down firmly on both sides of the ribbon cartridge.
2. Turn the typewriter off, wait at least 30 seconds, then turn the typewriter on again.
 - Try typing again.
3. Make sure the ribbon is installed correctly.
4. Make sure the printwheel is installed correctly.
 - Look at the printwheel for broken parts.
5. Make sure the platen is latched down at both ends.
 - Pull the paper release lever all the way toward you.
 - Push down firmly on each end of the platen. Then push the paper release lever all the way back.

Characters Spaced Incorrectly or Wrong Characters Print

1. Turn the typewriter off, wait at least 30 seconds, then turn the typewriter on again.
 - Try typing again.
2. Try a new printwheel.
3. Look for objects in the path of the carrier.

Characters Print Too Lightly

1. Make sure the ribbon is installed correctly.
2. Look for folds in the ribbon or paper.
3. Change the impression control. (Hold down **Code** while you press **Q**.)
4. Try a new ribbon.
5. Try plain bond paper.
6. Try a new printwheel.
7. Make sure the platen is latched down at both ends.
 - Pull the paper release lever all the way toward you.
 - Push down firmly on each end of the platen. Then push the paper release lever all the way back.

Line Spacing Aligns Incorrectly or Paper Feeds Incorrectly

1. Look for labels, paper, or objects inside the typewriter or caught under the platen.
2. Look at the number of carbon copies being used (five maximum).
3. When inserting loose carbon copies, pull the paper release lever forward. Insert the copies, then push the lever all the way back.
4. Make sure the platen is latched down at both ends.
 - Pull the paper release lever all the way toward you.
 - Push down firmly on each end of the platen. Then push the paper release lever all the way back.

Reference

Use this chapter to learn how to:

- Order IBM supplies for the typewriter.
- Remove and install the ribbon and printwheel in the typewriter.
- Take care of your typewriter.

This chapter also contains recommendations for ribbons and printwheels for various applications.

Ordering Procedures for IBM Supplies

To order IBM supplies, contact an IBM Authorized Dealer or call IBM Direct at 1-800-IBM-2468. In Canada, call IBM Direct at 1-800-465-1234.

Typestyle Samples

The IBM Cartridge Printwheel II is designed for use with IBM Wheelwriter® Typewriters and IBM Wheelprinters. The protective cartridge makes installation easy and protects the printwheel from damage. The wide variety of typestyles and sizes allows you to select one for readability, emphasis, or space requirements to make your work look the way you want.

The order number listed is for the American Standard Character Set. Personal computer, foreign language, and symbol character sets are also available.

- ▲ = 10 pitch
- △ = 12 pitch
- = 15 pitch

Note: Because of the differences between printed and typewritten impressions, the typestyle samples on the following pages should be used only as a guide.

Typestyle Samples and Pitches

10 Pitch

▲ Advocate 1353845	IBM's variety of attractive type
▲ Artisan 10 1353520	IBM's variety of attractive type
▲ Bookface Academic 1353844	IBM's variety of attractive type
▲ Courier 10 1353511	IBM's variety of attractive type
▲ Delegate 1353843	IBM's variety of attractive type
▲ Manifold 1353846	IBM'S VARIETY OF ATTRACTIVE TYPE
▲ OCR-A 1353246	IBM's variety of attractive type
▲ OCR-B 1353247	IBM's variety of attractive type
▲ Pica 1353829	IBM's variety of attractive type
▲ Presentor 1353015	IBM's variety of attractive type
▲ Prestige Pica 1353503	IBM's variety of attractive type
▲ P&P #3 OCR 1353054	IBM's variety of attractive type
▲ Rhetoric 1353736	IBM'S VARIETY OF ATTRACTIVE TYPE
▲ 1403 OCR 1353075	IBM'S VARIETY OF ATTRACTIVE TYPE

12 Pitch

△ Adjutant 1353047	IBM's variety of attractive typestyles suit
△ Artisan 12 1353050	IBM's variety of attractive typestyles suit
△ Auto Elite 1353080	IBM's variety of attractive typestyles suit
△ Courier 12 1353523	IBM's variety of attractive typestyles suit
△ Courier 12 Italic 1353890	<i>IBM's variety of attractive typestyles suit</i>
△ Dual Gothic 1353055	IBM's variety of attractive typestyles suit

12 Pitch (continued)

△ Elite 1353861	IBM's variety of attractive typestyles suit
△ Large Elite 1353017	IBM's variety of attractive typestyles suit
△ Letter Gothic 1353514	IBM's variety of attractive typestyles suit
△ Light Italic 1353764	<i>IBM's variety of attractive typestyles suit</i>
△ Olde World 1353875	IBM's variety of attractive typestyles suit
△ Prestige Elite 1353502	IBM's variety of attractive typestyles suit
△ Scribe 1353982	IBM's variety of attractive typestyles suit
△ Script 1353778	<i>IBM's variety of attractive typestyles suit</i>

15 Pitch

■ Courier 15 1353796	IBM's variety of attractive typestyles suit many
■ Gothic 15 1353719	IBM's variety of attractive typestyles suit many
■ Prestige 15 1353655	IBM's variety of attractive typestyles suit many

Printwheel Application Recommendations

Typestyle	1-3 Carbon Copies	3-5 Carbon Copies	Stencils
10 Pitch:			
Advocate	A	A	A
Artisan 10	A	A	A
Bookface Academic	B	C	B
Courier 10	A	A	B
Delegate	A	A	B
Manifold	A	A	B
Pica	A	A	A
Prestige Pica	A	B	B
Rhetoric	B	C	B
Rhetoric Presentor	B	C	B
Symbol 10	B	C	C
12 Pitch:			
Adjutant	A	A	B
Artisan 12	A	A	B
Auto Elite	A	A	A
Courier 12	A	A	B
Courier 12 Italic	A	A	B
Dual Gothic	A	B	B
Elite	A	A	A
Large Elite	A	A	A
Letter Gothic	A	A	B
Light Italic	A	A	A
Olde World	A	C	NR
Prestige Elite	A	B	A
Scribe	A	A	A
Script	B	C	C
Symbol 12	C	C	C

Ratings:

A - Good; B - Fair; C - Marginal; NR - Not Recommended
(Based on proper selection of ribbon, carbon paper, and stencils)

Printwheel Application Recommendations (continued)

Typestyle	1-3 Carbon Copies	3-5 Carbon Copies	Stencils
15 Pitch:			
Courier 15	A	B	B
Gothic 15	B	C	B
Prestige 15	A	B	A
Symbol 15	C	C	C

Ratings:

A - Good; B - Fair; C - Marginal
(Based on proper selection of ribbon, carbon paper, and stencils)

Note: There are three symbol printwheels: Symbol 10, Symbol 12, and Symbol 15. For best results, use a symbol printwheel that matches the pitch of your regular printwheel. For example, use Symbol 15 with 15-pitch typestyles.

Printwheels

Removing the Printwheel

CAUTION

To prevent unwanted carrier motion, make sure the paper bail is against the platen.

1. Pull the print hammer all the way toward you and hold it.
2. While you are holding the print hammer, grasp the printwheel tab.
3. Lift the printwheel straight up and out of the slot. Be careful not to scratch the ribbon.
4. Release the print hammer.

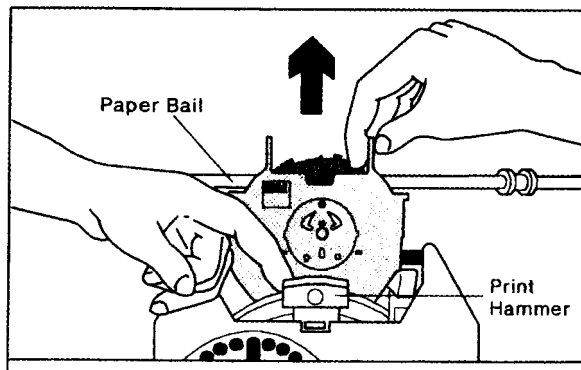
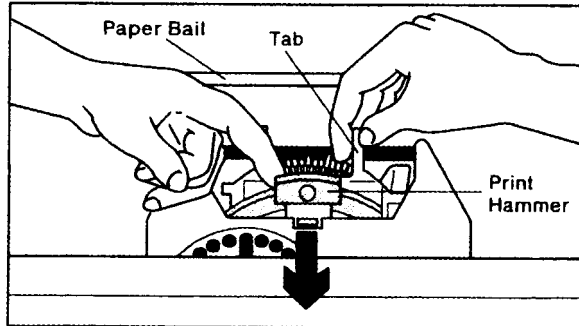

Installing the Printwheel

Important: Remove the yellow shipping seal from the center of a new printwheel before you install it.

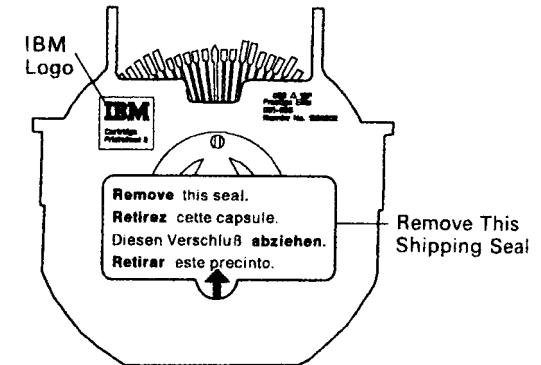

CAUTION

To prevent unwanted carrier motion, make sure the paper bail is against the platen.

1. Hold the printwheel so the letters IBM are in the upper left corner.
2. Pull the print hammer all the way toward you and hold it.
3. While you are holding the print hammer, lower the printwheel into the slot. Be careful not to scratch the ribbon.
4. After the printwheel touches the bottom of the slot, release the print hammer.
5. Press the **Code** key:
 - The printwheel spins.

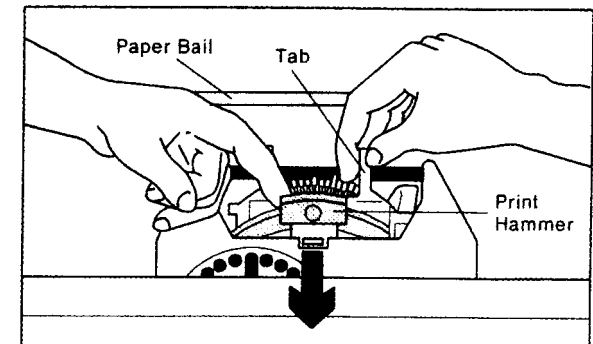

Ribbon Cassette System

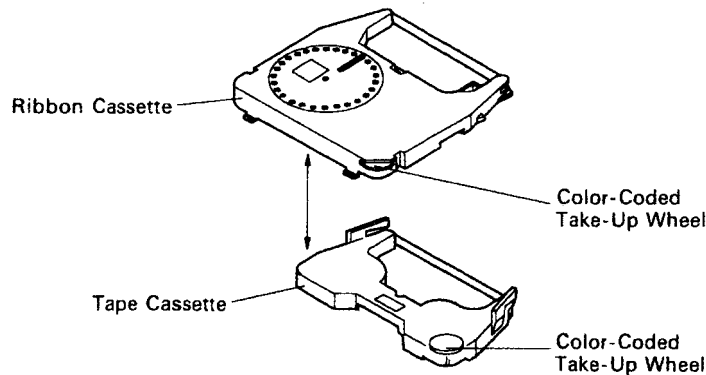

The ribbon and tape cassettes fasten together. Each type of ribbon and tape cassette has a color-coded take-up wheel. In most cases the wheel color helps you match the ribbon to the correction tape. (See "Ribbon Cassette Reorder Numbers" on page 4-11.) The color also tells you which type of ribbon you are using.

Removing the Cassettes

1. Space or tab to the center of your typewriter.
2. Raise the typewriter cover.
3. Make sure the paper bail is against the platen.
4. Push the release lever until the cassettes release.
5. Lift the cassettes up and out of the typewriter.

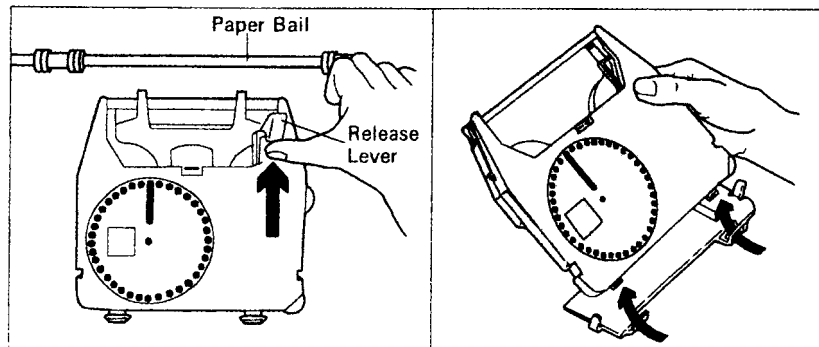

Installing the Cassettes

1. After you remove the cassettes from your typewriter, press on the top of the center latch, slide the cassettes apart and throw away the used cassette.
2. Slide the ribbon cassette onto the tape cassette.
 - Be sure the center latch latches onto the correction tape.
3. Press the gray tabs (on both ends of the correction tape) to be sure the tape and ribbon cassettes are latched together.
4. *Before* installing the ribbon in the typewriter, tighten any slack in the ribbon by turning the take-up wheels to move the color-coded leaders past the center.
5. Install the cassettes in your typewriter.
6. Push down on the upper right corner of the ribbon cassette to snap it into place.

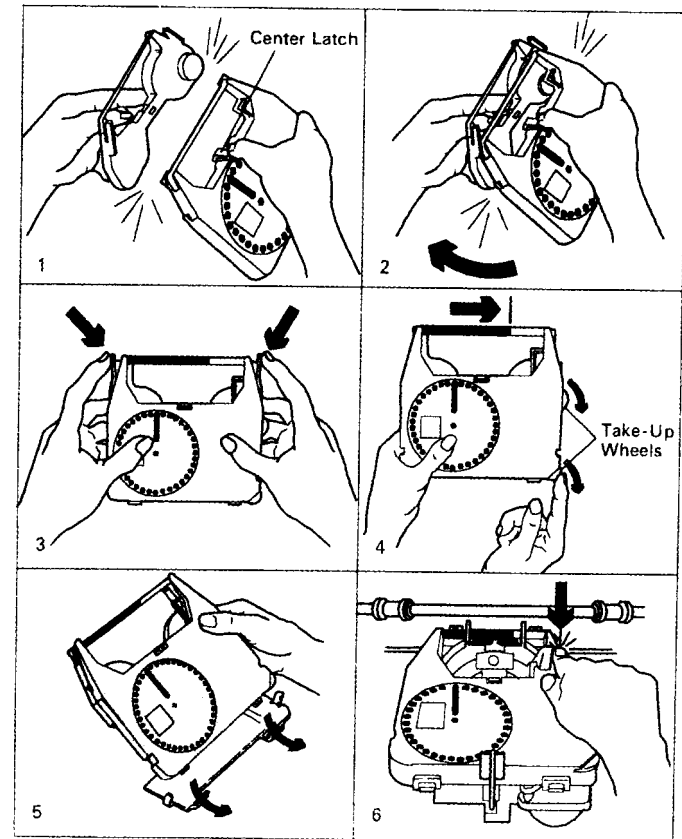

Ribbon Application Recommendations

Typing Applications	Multi-purpose Ribbon Cassette	High Yield Correctable Ribbon Cassette	Fabric Ribbon Cassette	Superior Write Correctable Ribbon Cassette
Legal Correspondence	●	●	NR	●
Executive Correspondence	●	●	NR	●
General Correspondence	●	●	●	●
Hard-to-Image Originals ¹	●	NR	●	●
OCR	●	NR	NR	NR
Speech Writing ²	●	NR	●	●
Negotiable Instruments – (checks, stocks, and so on)	●	NR	●	NR
Erasable Bond ¹	●	NR	NR	●
Quality of Original				
1 - 3 Carbons	Good	Good	Good	Good
3 - 5 Carbons	Fair	Marginal	Fair	Fair

● = Recommended

NR = Not Recommended

¹ The receptivity of the surface of these materials varies widely and care must be used in the selection of a specific material to be typed on. typestyle, impression control and ribbon to produce the best result. The IBM Easystrike® Superior Write Correctable Ribbon is recommended for most hard-to-image applications. However, there are some special coated or treated surfaces where the multipurpose ribbon must be used. When in doubt, prepare samples first.

² Best results with Rhetoric and other large typestyle printwheels are obtained by using the IBM Easystrike® Multipurpose Ribbon.

Ribbon Cassette Reorder Numbers

Use the table below to find the reorder number for the matching cassettes you need.

Ribbon	Wheel Color	Correction Tape	Wheel Color
IBM Easystrike® High Yield Correctable Ribbon Cassette ³ <i>Reorder Number:</i> 1299845 (black only)	Orange	IBM Easystrike® Lift-Off Tape Cassette <i>Reorder Number:</i> 1337765	Orange
IBM Easystrike® Correctable Ribbon Cassette <i>Reorder Numbers:</i> 1337761 (black) 1337762 (brown) 1337763 (blue)	Orange	IBM Easystrike® Lift-Off Tape Cassette <i>Reorder Number:</i> 1337765	Orange
IBM Easystrike® Superior Write Correctable Ribbon Cassette ⁴ <i>Reorder Number:</i> 1380999 (black only)	Purple	IBM Easystrike® Lift-Off Tape Cassette <i>Reorder Number:</i> 1337765	Orange
IBM Easystrike® Multi-purpose Ribbon Cassette <i>Reorder Number:</i> 1337764 (black only)	Blue	IBM Easystrike® Cover-Up Tape Cassette <i>Reorder Number:</i> 1337766	Blue
IBM Easystrike® Fabric Ribbon Cassette <i>Reorder Number:</i> 1356000 (black only)	Red	None	None

³ Long-life correctable film ribbon; recommended for general correspondence.

⁴ Recommended for bold and dark print, especially on difficult-to-image papers.

Care and Maintenance

Cleaning the Typewriter Cover

Important: Use only a damp cloth and mild detergent to clean the typewriter cover and keybuttons. Certain cleaning fluids may be harmful. *Do not use IBM cleaning fluid.*

Serial Number

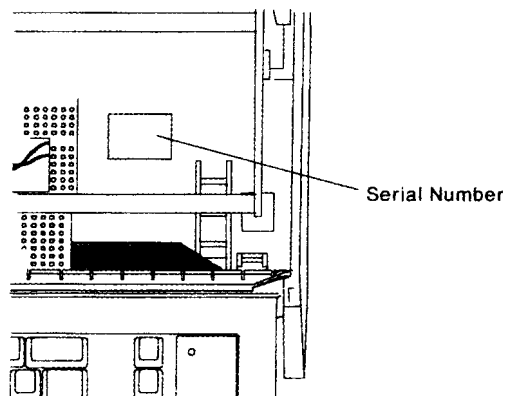

To locate the serial number on your typewriter, look on the right of the inside bottom cover. The serial number (S/N) is shown on the voltage label.

Index

A

automatic pitch selection 1-10

B

Backspace key 2-7

Bksp 1/2 2-7

blinking light signals 3-2

C

C (Ctr) key 2-2

Caps key 2-6

cardholder 1-8

care and maintenance 4-12

centering 2-2

centering marks 1-11

characters per horizontal inch 1-10

cleaning the typewriter cover 4-12

clearing tabs 1-14

Code key 2-1

Correction key 1-15

correction memory 1-15

D

drawing vertical lines 1-8

E

erasing

automatically 1-15

farther back on the same line 1-15

on another line 1-15

F

function keys 2-1

I

impression control 2-5

inserting paper 1-3

installing printwheels 4-7

installing ribbon cassettes 4-9

K

keyboard height adjust lever 1-2

L

latching cassettes together 4-9

left margin, releasing 1-13

line space key 1-5

line space lights 1-5

lines per vertical inch 1-10

LMar key 1-13

Lock key 1-5

M

maintenance and care 4-12

margin/pitch scale 1-11

margins

releasing the left 1-13

setting 1-13

standard 1-12

MarRel key 1-13

Micro Down key 1-4

Micro Up key 1-4

moving and removing paper 1-4

O

on/off switch 1-1

one-half backspace 2-7

ordering supplies 4-1

P

- page end indicator 1-7
- page end scale 1-7
- paper
 - inserting 1-3
 - moving and removing 1-4
- paper bail load lever 1-3
- Paper Down** key 1-4
- paper edge indicator 1-3
- paper movement keys 1-4
- paper release lever 1-3
- paper scale 1-3
- Paper Up** key 1-4
- parts of the typewriter 1-1
- pitch selection, automatic 1-10
- pitch symbols 1-11
- print hammer 4-6
- printwheel 1-10
 - applications 4-4
 - choosing 1-9
 - identification 1-9
 - installing 4-7
 - pitch table 1-10
 - pointer 1-8
 - removing 4-6
 - storing and handling 1-9
- problem determination
 - beeper and light signals 3-2
 - erase 3-3
 - index 3-1
 - typewriter 3-4
 - typing 3-5

R

- removing ribbon cassettes 4-8
- removing the printwheel 4-6
- repeat (typematic) keys 1-6
- ribbon
 - applications 4-10
 - cassette system 4-8
 - installing 4-9

- latching cassettes together 4-9
- removing 4-8
- reorder numbers 4-11
- ribbon release lever 4-8
- RMar** key 1-13

S

- safety information iv
- samples, typestyles 4-1
- scale, margin/pitch 1-11
- serial number 4-12
- setting tabs 1-14
- Shift** key 1-5
- Shift Lock** light 1-5
- special characters 2-5
- standard margins and tabs 1-12
- supplies, ordering procedures 4-1

T

- Tab** key 1-14
- tabs
 - clearing 1-14
 - clearing all 1-14
 - setting 1-14
 - standard 1-12
- TClr** key 1-14
- TSet** key 1-14
- typematic (repeat) keys 1-6
- typestyle samples 4-1

U

- U (UndIn)** key 2-4
- underlining 2-4

IBM Wheelwriter® 3 Series II Typewriter 6782
Operator's Guide
Order Number S544-4212-1

Reader's Comment Form

You may use this form to communicate your comments about this publication, with the understanding that IBM may use or distribute whatever information you supply in any way it believes appropriate without incurring any obligation to you.

1. Did you find the book well organized?
Yes No
2. Was the content of the book accurate and complete?
Yes No
3. Was the book easy to use?
Yes No
4. What can we do to improve the book?

5. What is your job title?

Questions or comments about supplies, service, applications, and so on will slow response time considerably. Please refer those questions or comments to your IBM Authorized Dealer or IBM Direct.

Note: Please direct all requests for copies of IBM publications to your IBM Authorized Dealer. Publications are not stocked at the location to which this form is addressed.



NO POSTAGE
NECESSARY
IF MAILED
IN THE
UNITED STATES



BUSINESS REPLY MAIL
FIRST CLASS PERMIT NO. 123 LEXINGTON, KY 40511

POSTAGE WILL BE PAID BY ADDRESSEE

International Business Machines Corporation
Department F98, Building 962-3
740 New Circle Road, N.W.
Lexington, Kentucky 40511

Fold Here

Cut Along Line

Canadian Department of Communications (DOC) Compliance Statement

This equipment does not exceed Class B limits per radio noise emissions for digital apparatus, set out in the Radio Interference Regulation of the Canadian Department of Communications. Operation in a residential area may cause unacceptable interference to radio and TV reception requiring the owner or operator to take whatever steps are necessary to correct the interference.

The above statement applies only to those machines used in Canada.

Avls de conformité aux normes du ministère des Communications du Canada

Cet équipement ne dépasse pas les limites de Classe B d'émission de bruits radioélectriques pour les appareils numériques, telles que prescrites par le Règlement sur le brouillage radioélectrique établi par le ministère des Communications du Canada. L'exploitation faite en milieu résidentiel peut entraîner le brouillage des réceptions radio et télé, ce qui obligerait le propriétaire ou l'opérateur à prendre les dispositions nécessaires pour en éliminer les causes.

Cet avis ne s'applique qu'aux machines utilisées au Canada.

Tape

Please Do Not Staple

Tape

Free Manuals Download Website

<http://myh66.com>

<http://usermanuals.us>

<http://www.somanuals.com>

<http://www.4manuals.cc>

<http://www.manual-lib.com>

<http://www.404manual.com>

<http://www.luxmanual.com>

<http://aubethermostatmanual.com>

Golf course search by state

<http://golfingnear.com>

Email search by domain

<http://emailbydomain.com>

Auto manuals search

<http://auto.somanuals.com>

TV manuals search

<http://tv.somanuals.com>