

### Service Center

**USA**  
**AVC Tech, INC.**  
777 Mark Street,  
Wood Dale, IL 60191  
Tel : 800-568-0060 or 630-595-0123  
Fax :800-784-9422 or 630-595-2345  
e-mail :peterlee@hyundaimonitor.com

**GERMANY**  
**Hyundai Imagequest Europe GMBH**  
Geheimrat Hummel Platz 2  
65239, Hochheim, Germany  
Tel : 49 6146 904 418  
Fax : 49 6146 904 410  
E-mail: service@hyundaiq.de  
URL: www.hyundaiit.com

**NEWZEALAND**  
**Vantex Technology Distribution Ltd**  
635 Great South Road,  
Penrose, Auckland.  
Tel : 64 9 571 0775  
Fax : 64 9 571 0776  
e-mail : kimmw@vantex.co.nz

**AUSTRALIA**  
**Thomas Electronics ESG Pty Ltd.**  
3 Sheridan Close  
Milperra NSW 2214, Australia  
Tel : 61 2 8723 6528  
Fax : 61 2 8723 6588  
E-mail: leanne\_crawford@thomas.com.au

**JAPAN**  
**Hyundai ImageQuest Japan., Ltd**  
7th FL, Dai-Bldg, 1-3-3  
Uchisaiwai - Cho Chiyoda - Ku  
Tokyo, Japan 100-0011  
Tel : 81 03 5157 2286  
Fax : 81 03 5157 2268  
E-mail: pjkim@hyundaiq.co.jp

[www.hyundaiIT.com](http://www.hyundaiIT.com)

## User's Guide

# Digital LCD TV

MODELS : E260D | E320D | E370D  
E261D | E321D | E371D



## FCC Information

### User Instructions

The Federal Communications Commission Radio Frequency Interference Statement includes the following warning :

**NOTE :** This equipment has been tested and found to comply with the limits for a Class B digital device pursuant to Part 15 of the FCC Rules.

These limits are designed to provide reasonable protection against harmful interference in a residential installation. This equipment generates, uses, and can radiate radio frequency energy and, if not installed and used in accordance with the instructions, may cause harmful interference to radiocommunications. However, there is no guarantee that interference will not occur in a particular installation.

If this equipment does cause harmful interference to radio or television receptions, which can be determined by turning the equipment off and on, the user is encouraged to try to correct the interference by one or more of the following measures :

- Reorient or relocate the receiving antenna.
- Increase the separation between the equipment and receiver.
- Connect the equipment into an outlet on a circuit different from that to which the receiver is connected.
- Consult the dealer or an experienced radio/TV technician for assistance.

### User Information

Changes or modifications not expressly approved by the party responsible for compliance could void the user's authority to operate the equipment. Connecting of peripherals requires the use of grounded shielded signal cables.

## Important Tip

### Image Retention Effect (Image Sticking)

#### 1. Cause :

- Image Retention Effect may come from displaying a still picture in certain period of time with at a certain area continuously, as the feature of LCD panel. This is caused due to brightness degradation. Many LCD manufacturers are trying to overcome this limitation.

#### 2. Prevention

- To avoid this matter, use the product after reducing brightness and contrast, especially when a still image is displaying for a long time. (Contrast 50/Brightness 50 - [See 34 page](#))  
Once image retention occurs, use the mode that displays more motion pictures. It will help reduce this matter.

#### 3. Solution

- The temporary image sticking would decrease with displaying Full-White pattern during 10 hours.  
\* The permanent image sticking could not take off under the latest technology.  
This method may be used to eliminate a temporary retained image that occurs after displaying a still image for a certain period of time. Since it may take several minutes to several hours to remove image sticking, it is recommendable to display motion pictures during 2~3 minutes every hour when keeping displaying a still image. As image sticking is influenced by the brightness of a still image being displayed and its display time, it is recommended that you reduce the brightness of the screen when displaying a still image for a long time.

\* Image Sticking does not come under the warranty.



## Image Sticking Precaution

### When watching a still Image within motion pictures and Wide/4:3 screen

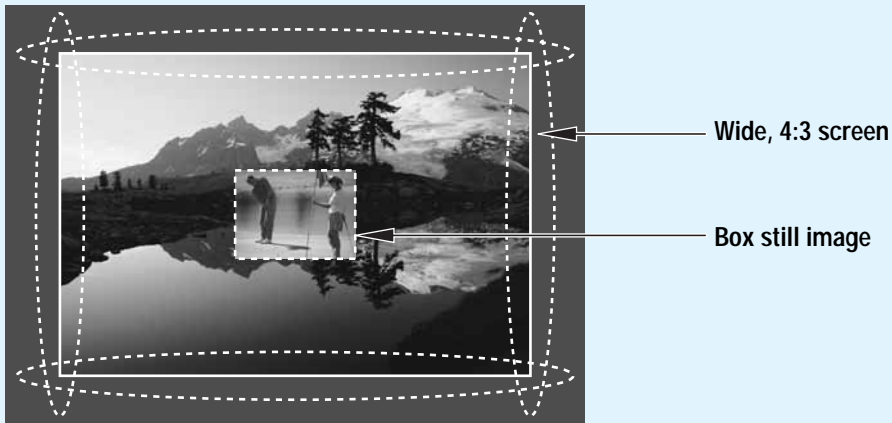

#### 1. Note :

- When the central area of the screen and the screen edges are fixed, the different brightness level of the edges may cause image retention on the edges when watching for a long time
- This phenomenon is the same matter to other LCD manufacturers. Please do not watch a still image for a long time.
- If you watch a still image for a long time, this may damage your TV.

\* This matter does not come under the warranty.

## Features

### Integrated HDTV

An HDTV has a built-in ATSC digital tuner. It does not need a separate set-top box to receive over-the-air DTV signal.

### Dual Scan/Multi-Viewing

You can program analog TV broadcasting and digital TV broadcasting automatically at the same time for multi-viewing.

### A Wide Array of Screen Settings

You can choose different screen settings depending on the type of program you are watching or the surrounding conditions (the outside weather conditions). You can switch among Standard, and Mild options or you can configure the screen settings for yourself.

### A Wide Array of Sound Settings

You can choose an optimal sound setting for the type of program you are watching. You can switch among custom Standard, movies, Music, and Speech options or you can configure the sound settings for yourself.

### Favorite Channel Memory

You can memorize the channels you are watching frequently.

### SRS TrueSurround XT

You can enjoy dynamic and surround sound with ordinary speakers.

### Dolby Digital

When receiving digital broadcast signal, you can enjoy dynamic and surround sound with two ordinary speakers just like Dolby Digital 5.1.

### A Variety of Aspect Ratios

You can adjust the screen size at your preference.



# Table of Contents

## General Information

Safety Precaution .....	5
Contents of the Package .....	9
Products Sold Separately .....	9
Parts Names and Functions .....	10
Remote Control .....	14

## Connections

How to Watch Both Analog and Digital Broadcasts with a Single Antenna .....	16
Before Connecting the Video/Audio Connections to External Devices... ..	17
How to Connect a VCR/Cable Receiver .....	18
How to Connect a SET TO Box or DVD Player .....	19
How to Connect a Camcorder/Game Player .....	20
How to Connect to a PC .....	21
HDMI Connection .....	23
How to Connect an External Visual Device .....	25
How to Use Digital Sound .....	26

## Channel Setup

How to Select Tuner Mode .....	27
How to Store Channels Automatically .....	28
How to Add/Erase Channels Manually .....	29
How to Set Channel Edit and Favorite Channels .....	30
How to See Signal Strength .....	31
How to the Input Mode .....	32

## Picture Setup

How to Select the Picture Mode .....	33
How to Set the Desired Picture .....	34
How to Select the Aspect Ratio .....	35

## Sound Setup

How to Select the Audio Mode .....	36
How to Adjust the Desired Audio Mode .....	37
How to Use the Automatic Volume Control .....	38
How to Listen to SRS TruSurround XT (Surround) .....	39

How to Set Audio Language .....	40
How to Set the Digital Audio Output .....	41

## Function Setup

How to Set Auto Lock .....	42
How To Set Block Program .....	44
How to View Closed Captions .....	46
How to Set EPG View .....	49

## Setup

How to the Set Date/Time .....	50
How to the Set Power on Time .....	51
How to the Set Power off Time .....	52
How to the Set Sleep Time .....	53
How to Choose Menu Language .....	54
How to Set Menu Opacity .....	55
How to Set Emergency Alert .....	56
How to Set Geometry In PC Mode .....	57

## Appendix

Glossary .....	58
Troubleshooting .....	61
Care and Cleaning .....	63
Product Specifications .....	64



# Safety Precaution

The contents of this section are provided for the safety of users and their property. Please read the instructions carefully before using.

## Outdoor Antenna Grounding

If an outside antenna or cable system is connected to the TV, be sure the antenna or cable system is grounded so as to provide some protection against voltage surges and built-up static charges. Section 810 of the National Electrical Code, ANSI/NFPA No.70-1984, provides information about proper grounding of the mast and supporting structure, grounding of the lead-in wire to an antenna discharge unit, size of grounding conductors, location of antenna discharge unit, connection to grounding electrodes, and requirements for the grounding electrode.

### Example of Grounding According to National Electrical Code Instruction

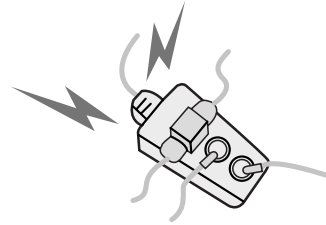
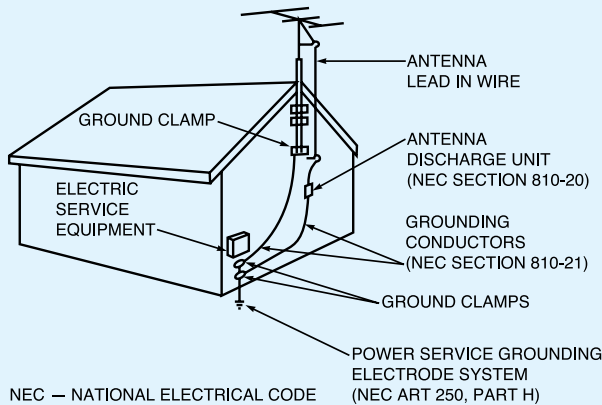

**Do not connect multiple electrical appliances to a single outlet.**  
- It may cause a fire due to overheating from the outlet.

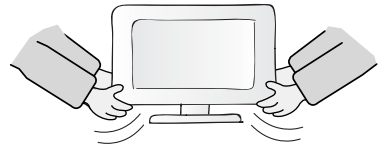

**Make sure to remove the speakers before moving the TV with speakers mounted on it.**  
- When the speakers are detached from the unit while carrying it, this may cause damage to the unit or personal injury.

**Do not use or store a flammable spray or inflammable things near the TV.**

- They may cause explosion or fire.

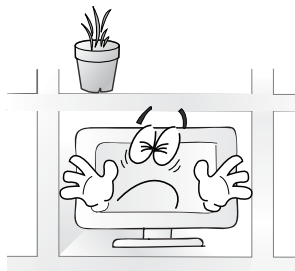

**Do not install the TV in a bookshelf, closet, or a place where there is poor air circulation.**

- Fire may be caused due to the rise of internal temperature.

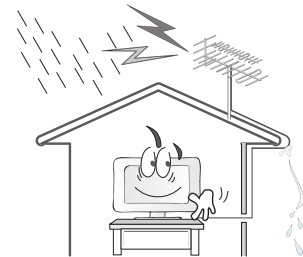

**Any necessary action such as making the antenna cable loop at the entrance of the building should be taken to prevent rainwater on the outdoor antenna cable from possibly running into the indoor.**

- If raindrop gets into the LCD TV, it may cause a fire or an electric shock.



If there is a persistent accumulation of dusts or water on the plug, please make sure to wipe it off using a dry cloth.

- It may cause a fire or an electric shock.

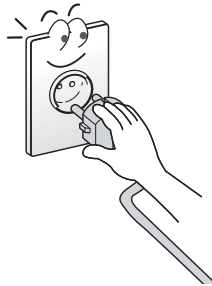

Firmly plug in the power cord so that it does not pull out.

- An unstable connection may cause fire.

Do not use a damaged power cord or plug, or loose outlet.

- It may cause electric shock or fire.

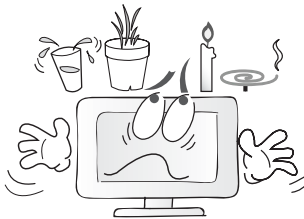
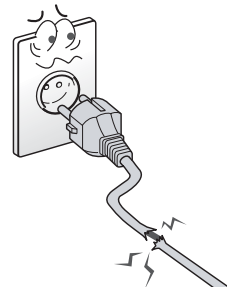

Do not put a water bowl, vase, candle, bug repellent, smoke, cigarette, plants, or heavy thing on the TV.

- It may cause electric shock or fire and also heavy things may cause injury when they fall.

Do not install in a place where there is oil, smoke, excessive humidity, or where water may be sprinkled on it.

- This may cause electric shock or fire.

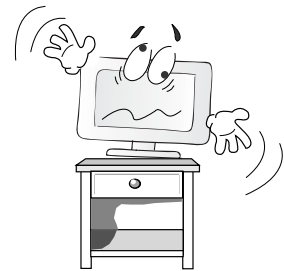

Do not install on an unstable place or small support.

- This may cause the TV to fall, resulting in serious injury to a child or adult.

Never attempt to open, fix, or modify your TV.

- When there is a need for fixing, call a service center. Fire or electric shock may be caused.



Do not put a metallic object like chopstick, wire, or puncher or inflammables like paper or a match in a vent, headphone jack, or AV jacks of the TV.

- Electric shock or fire may be caused.

When the TV produces abnormal noise, burning smell, or smoke, unplug the TV immediately and call a service center.

- Electric shock or fire may be caused.





## Safety Precaution .....Continued from previous page

The contents of this section are provided for the safety of users and their property.  
Please read the instructions carefully before using.

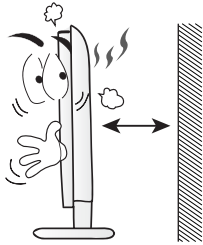

Keep the TV at least 10cm away from the wall for ventilation.

- Fire may be caused due to the rise of inner temperature.



Do not place any heat sources such as radiators and heat registers, etc. near the TV.

- It may cause a fire.

Do not block ventilating slits with a table cloth.

- Blocking the ventilation slits may produce inner heat increase, resulting in a fire.

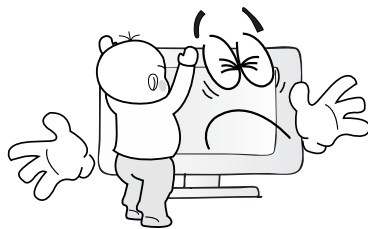

Do not allow children to climb or play on the TV.

- If it falls over on children, it may cause serious injury.

Do not place toys and cookies, etc. on the TV, which may attract children's attention.

- If it falls over on children, it may cause serious injury.

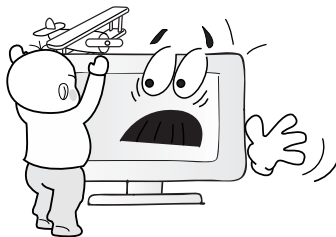

When cleaning the TV, make sure to disconnect the power plug and use a dry, soft cloth for a cleanup.

- Please avoid using chemicals such as wax, benzene, alcohol, thinner, mosquito spray, air freshener, lubricant or synthetic detergent.

Unplug when you do not use your TV for a long time.

- If dust is stacked on the TV, electric shock or fire may be caused from heat, fire, or deterioration of insulation.

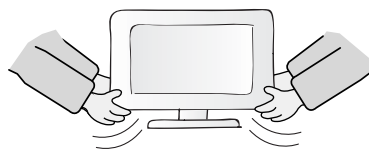

When moving the TV, two or more people are advised to carry it.

- Injury or damage may be caused when the TV falls.

Never touch the power plug or outlet with wet hands.

- This may cause electric shock.

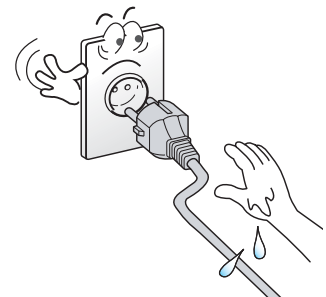

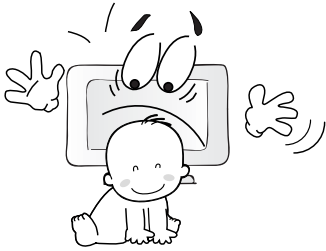

**Do not install the product on the floor.**  
- If it falls over, your child may be injured.

**Unplug the product during lightning or thunderstorms and never touch the antenna cable.**

- It may cause a fire or an electric shock.

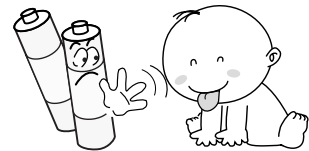
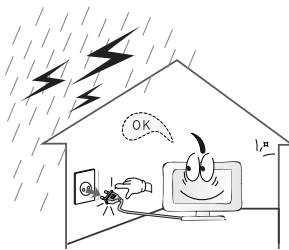

**Keep the remote control batteries out of sight and out reach of children.**

- If your child swallows a battery, see your doctor immediately.

**When replacing batteries, make sure to match the batteries to the (+) and (-) marks in the battery compartment.**

- Mismatching of polarities may result in internal damage to batteries, fire due to leakage or contamination.

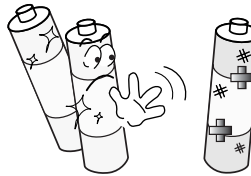
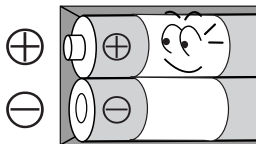

**In the event of damaging or dropping the product, switch off the power and remove the plug.**

- Using a damaged product may cause an electric shock or a fire.  
- Contact your local service center.

**Always use the standard batteries and avoid using old batteries together with new ones.**

- Otherwise it may result in internal damage to batteries, fire due to leakage or contamination.

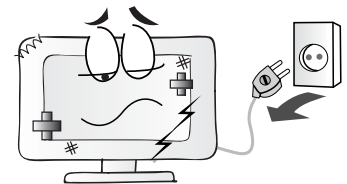

**Before moving the product, ensure to switch off the power and unplug all the electrical cords and the external connection cords such as an antenna cable and other source connections, etc.**

- An electrical cord(s) may be damaged, resulting in a fire or an electrical shock.

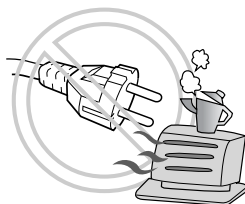

**Consult a service center or customer service for inside cleaning about once a year.**

- When dust is piled inside the TV for long time, fire or malfunction may be caused.

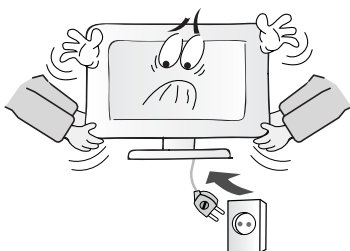

**Ensure the power cord doesn't trail across any hot objects like a heater.**

- This may cause a fire or an electric shock.





# Contents of the Package

When opening the package, please ensure to check the following accessories provided.

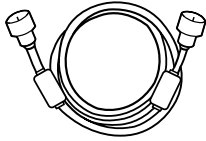

Antenna Cable  
(coaxial cable)

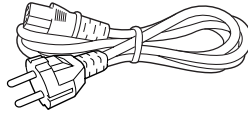

Power Cord

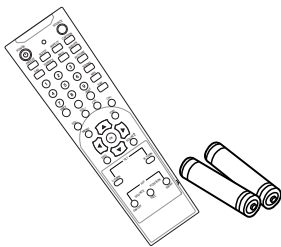
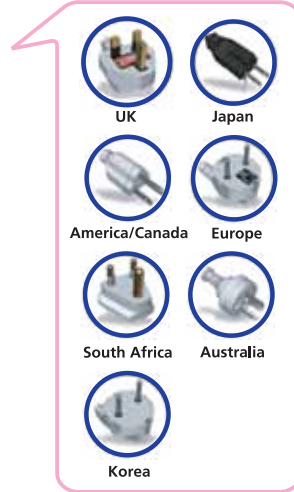

Remote Control & 2 batteries  
(1.5V AAA)

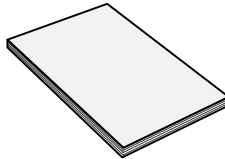

User's Guide

# Products Sold Separately

If you want to purchase separately sold products, consult a service center, electronics shops, or parts seller.



HDMI cable

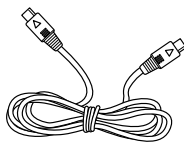

S-video Cable

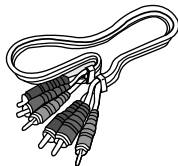

Component Cable  
(Y, Pb, Pr)

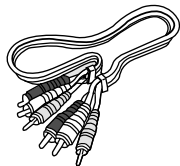

Composite Cable  
(Video/Audio)

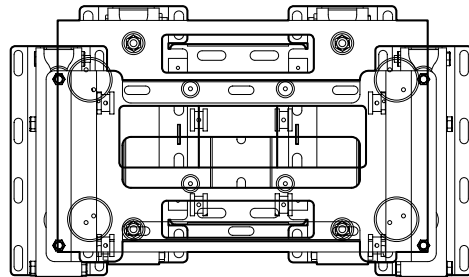

Wall Mounting Support

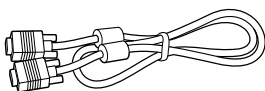

PC signal Cable (D-SUB)

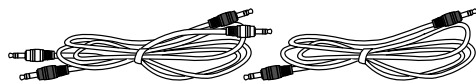

Audio Cable (DVD)

Audio Cable (PC)

# Parts Names and Functions

## Front View - E260D/E320D/E370D

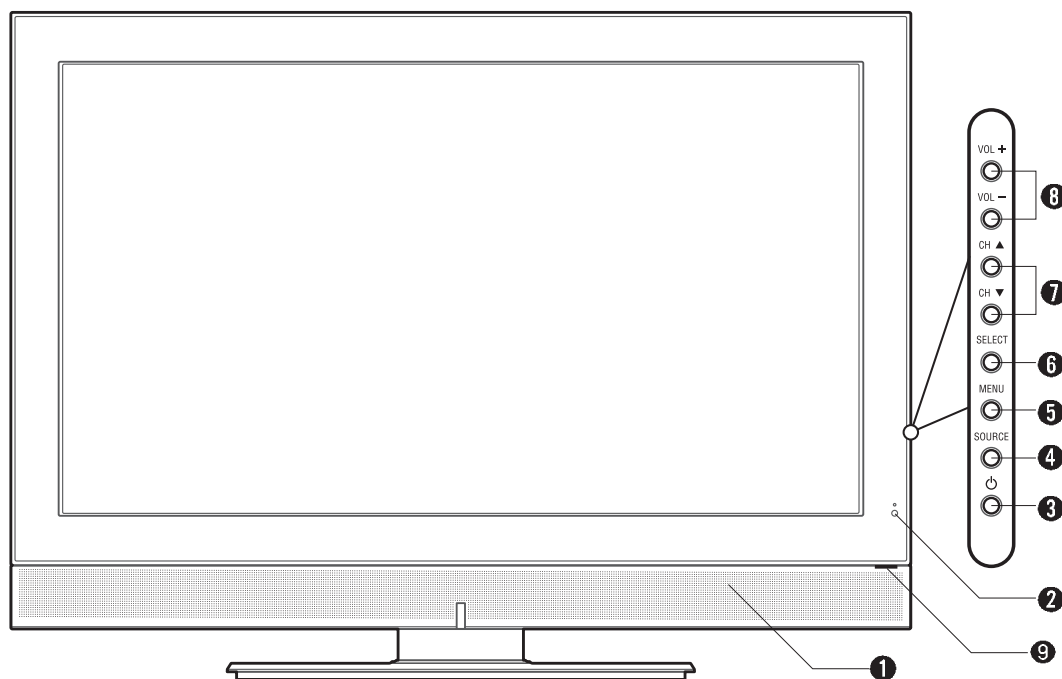

\* This product image may be a bit different from the actual product.

### ❶ Speaker

### ❷ Remote sensor and power LED.

- Point the remote control toward here.
- It displays standby or operation status.

- Power Indicator Status -

Indicator	Status
Red	Standby
Green	Power on

### ❸ Power button

Use this button to turn on or off the TV.

### ❹ Source button

Use this button to switch among inputs connected to the TV.

### ❺ Menu button

Use this button to display or exit from menus.

### ❻ Select button

Use this button to select each item of menu.

### ❼ Channel buttons

Use these buttons to change channels. These buttons also serve as the cursor of Down and Up buttons when in Menu mode.

### ❽ Volume buttons

Use these buttons for your desired sound level. These buttons also serve as the cursor of Select/Adjust when in Menu mode.

### ❾ Power switch - For E370D Model Only

Use this switch to turn on/off power.



## Rear View - E260D/E320D/E370D

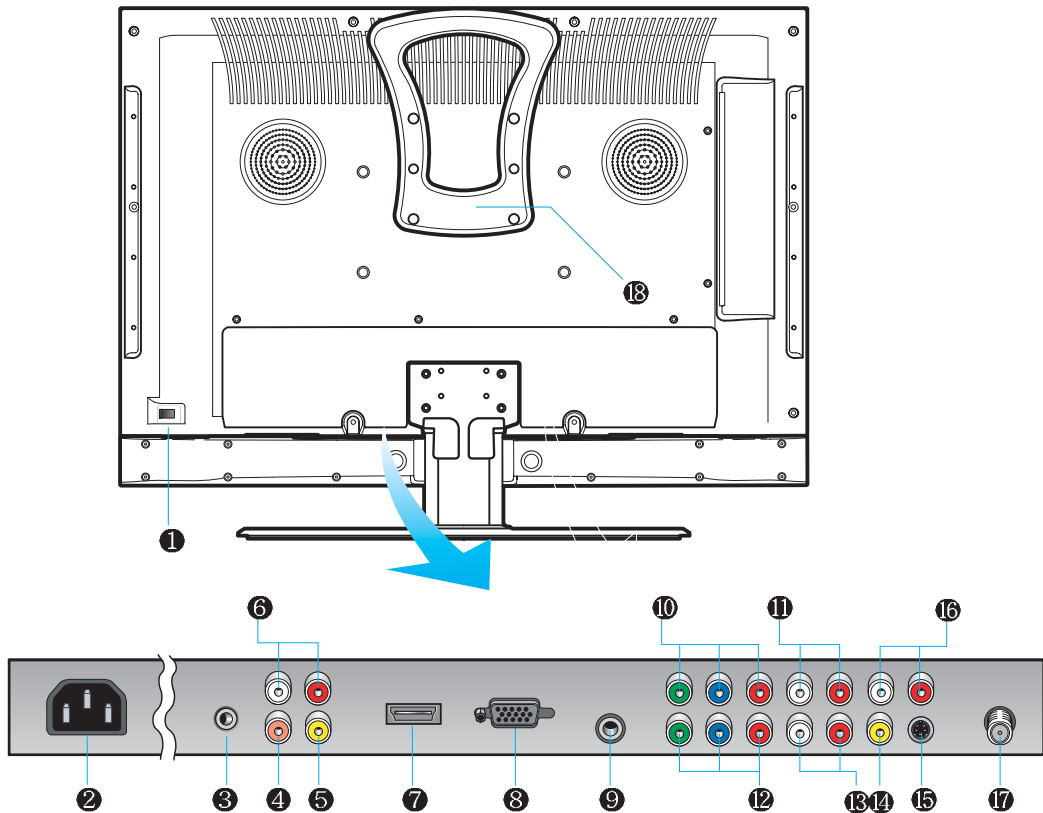

\* This product image may be a bit different from the actual product.

- ❶ Power Switch - *For E260D/E320D Only*  
use this switch to turn on/off power
- ❷ Power(AC) Input terminal  
Connect the power cord to this terminal.
- ❸ RS-232 input terminal  
Connect to the RS-232 terminal of a PC to check its service.
- ❹ S/PDIF optical digital audio output terminal
- ❺ Video output terminal
- ❻ Audio output terminal
- ❼ HDMI input terminal
- ❽ D-SUB input terminal
- ❾ D-SUB Audio input terminal
- ❿ Component 1 Video input terminal
- ⓫ Component 1 Audio input terminal
- ⓬ Component 2 Video input terminal
- ⓭ Component 2 Audio input terminal
- ⓮ Video input terminal
- ⓯ S-Video input terminal
- ⓰ S-Video/Video Audio input terminal
- ⓱ Antenna (Analog/DTV) input terminal
- Ⓜ Handle - *For E260D Only*

Front View - E261D/E321D/E371D

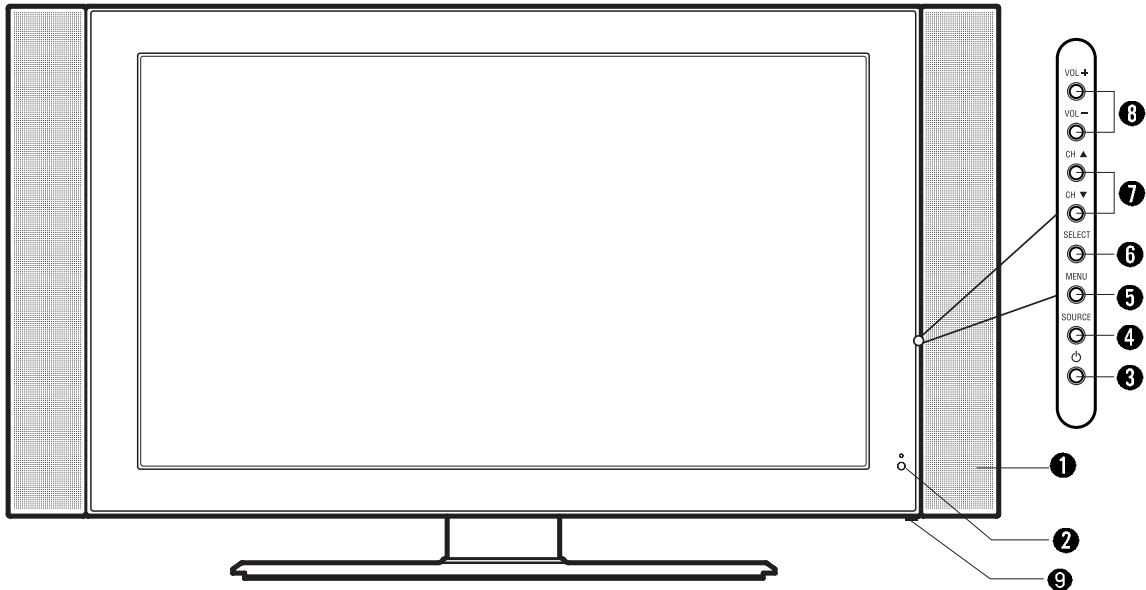

\* This product image may be a bit different from the actual product.

**1 Speaker**

**2 Remote sensor and power LED.**

- Point the remote control toward here.
- It displays standby or operation status.

- Power Indicator Status -

Indicator	Status
Red	Standby
Green	Power on

**3 Power button**

Use this button to turn on or off the TV.

**4 Source button**

Use this button to switch among inputs connected to the TV.

**5 Menu button**

Use this button to display or exit from menus.

**6 Select button**

Use this button to select each item of menu.

**7 Channel buttons**

Use these buttons to change channels. These buttons also serve as the cursor of Down and Up buttons when in Menu mode.

**8 Volume buttons**

Use these buttons for your desired sound level. These buttons also serve as the cursor of Select/Adjust when in Menu mode.

**9 Power switch - For E371D Model Only**

Use this switch to turn on/off power.



## Rear View - E261D/E321D/E371D

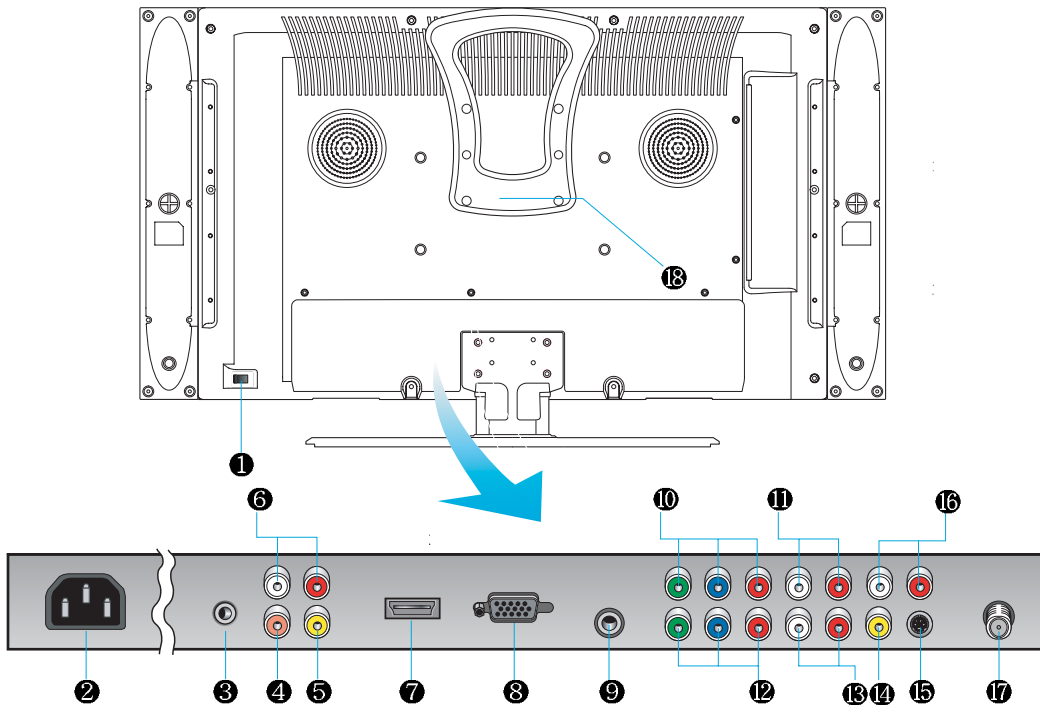

\* This product image may be a bit different from the actual product.

- ❶ Power Switch - *For E261D/E321D Only* use this switch to turn on/off power
- ❷ Power(AC) Input terminal  
Connect the power cord to this terminal.
- ❸ RS-232 input terminal  
Connect to the RS-232 terminal of a PC to check its service.
- ❹ S/PDIF optical digital audio output terminal
- ❺ Video output terminal
- ❻ Audio output terminal
- ❼ HDMI input terminal
- ❽ D-SUB input terminal
- ❾ D-SUB Audio input terminal
- ❿ Component 1 Video input terminal
- ⓫ Component 1 Audio input terminal
- ⓬ Component 2 Video input terminal
- ⓭ Component 2 Audio input terminal
- ⓮ Video input terminal
- ⓯ S-Video input terminal
- ⓰ S-Video/Video Audio input terminal
- ⓱ Antenna (Analog/DTV) input terminal
- Ⓜ Handle - *For E261D Only*



# Remote Control

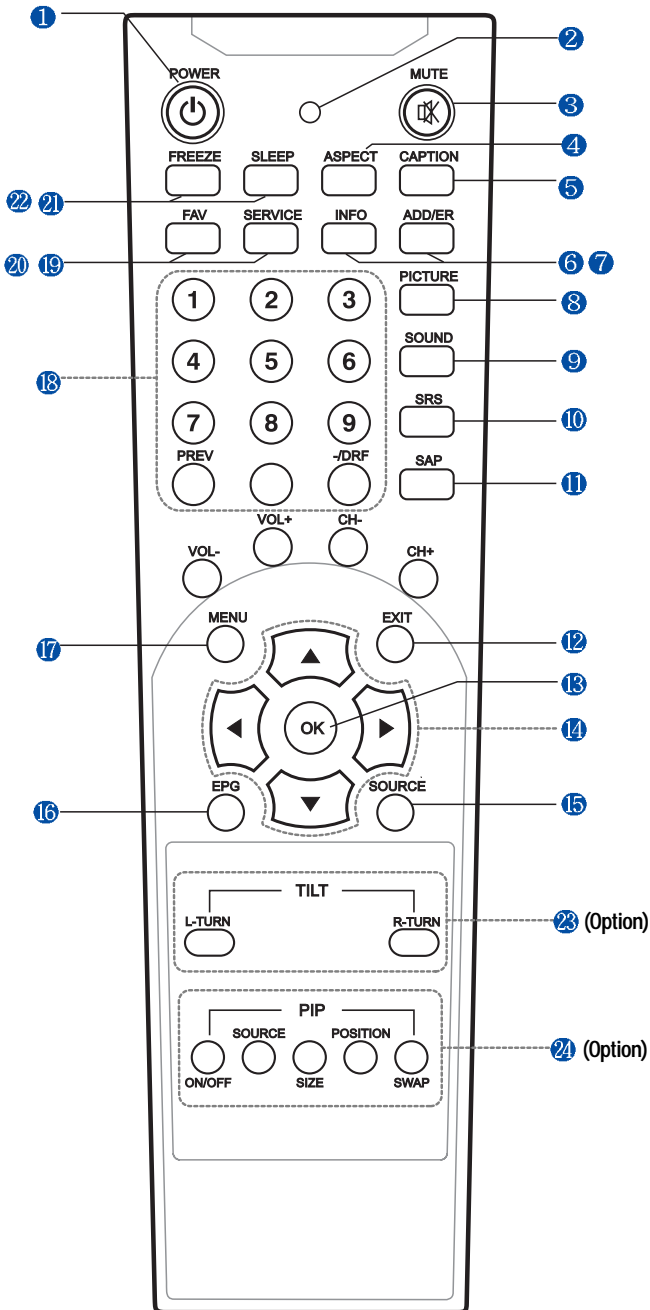

1. POWER/STANDBY
2. POWER LED
3. MUTE
4. ASPECT
5. CAPTION
6. ADD/ERASE  
Use this button to add or erase channels.
7. INFORMATION  
Use this button to display resolution or various program
8. PICTURE
9. SOUND
10. SRS  
Use this button to select 3D surround sound.
11. SAP  
Use this button to listen in a foreign language
12. EXIT  
Use this button to end the OSD
13. MENU SELECTION  
Use this button to select menu item
14. LEFT/RIGHT MOVE/ADJUST  
Use these buttons to move between menu items or to adjust each item.
15. SOURCE  
Use this button to select External input
16. EPG  
Use this button to see digital broadcast information
17. MENU  
Use this button to call the OSD to the screen.
18. NUMERIC KEYS
19. SERVICE  
return to factory setting
20. FAVORITE  
use this button when watching your favorite channel.



- 21. SLEEP
- 22. FREEZE

- Option -

- 23. TILT

- 24. PIP

- ON/OFF

: Use this button for PIP on/off

- Source

: Use this button to select the source of sub-picture.

- SIZE

: Use this button to select the size of sub-picture.

- POSITION

: Use this button to select the position of sub-picture.

- SWAP

: Use this button to swap main and sub-picture.

## How to Insert Batteries in Remote Control

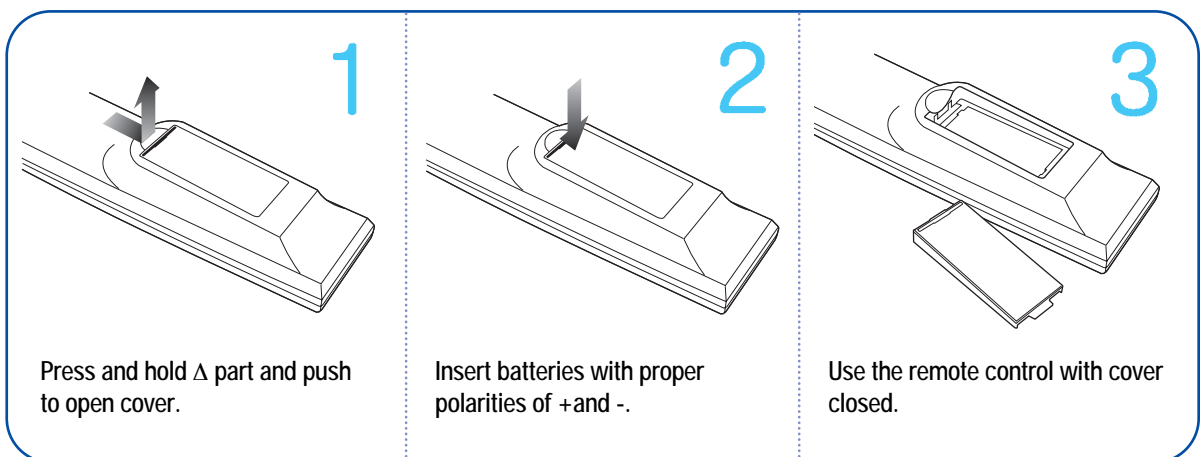

\* Battery type :1.5V/AAA

# How to Watch Both Analog and Digital Broadcasts with a Single Antenna

You can watch both analog and digital broadcasts by connecting a single antenna.

## Connection Method

- ➔ Make sure that the antenna cable is connected to ANT (ATV/DTV).
- Antenna or Cable service without a cable box connections
- For optimum picture quality, adjust antenna direction if need,

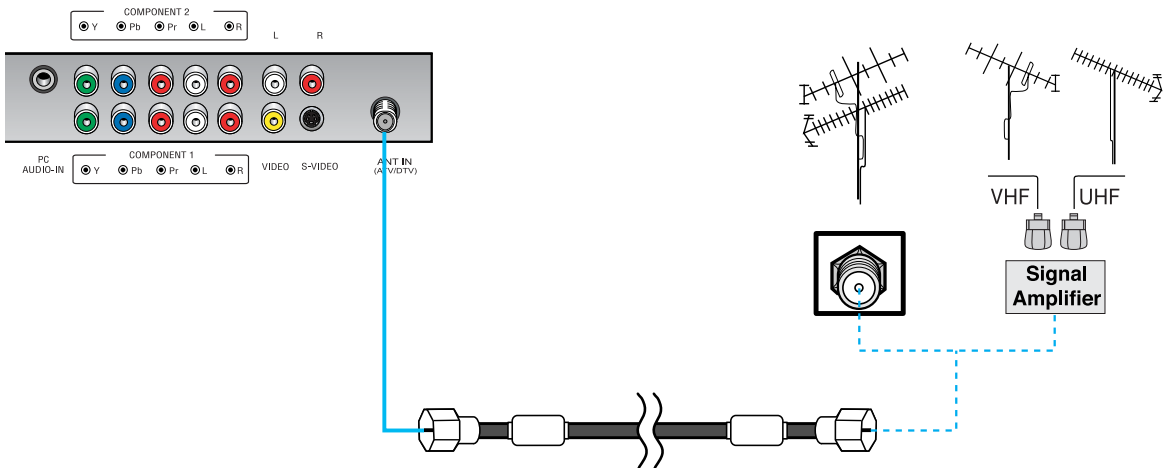

**TIP**

- When inserting a 75  $\Omega$  ohm coaxial cable into the input connection, ensure the wire tip not to bend.
- If you experience poor signal reception, we recommend you purchase a signal amplifier for better picture quality.

## How to Watch

1 Turn on TV to activate Auto Channel (See page 28) to memorize the available channels.

2 Press SOURCE INPUT on remote control until showing TV banner on the bottom side.



3 Press button or CH- CH+ button to select the desired channels.

Ex.) When you want to watch Digital channel, press Number, -/DRF buttons.



## Before Connecting the Video/Audio Connections to External Devices...

Please make sure to read the following information on connection to enjoy best picture quality.

### Video/Audio connectors

Types of video/audio cable :

① HDMI ② 15-Pin D-Sub ③ COMPONENT ④ S-VIDEO ⑤ COMPOSITE

*Best picture quality is displayed in the following order.*

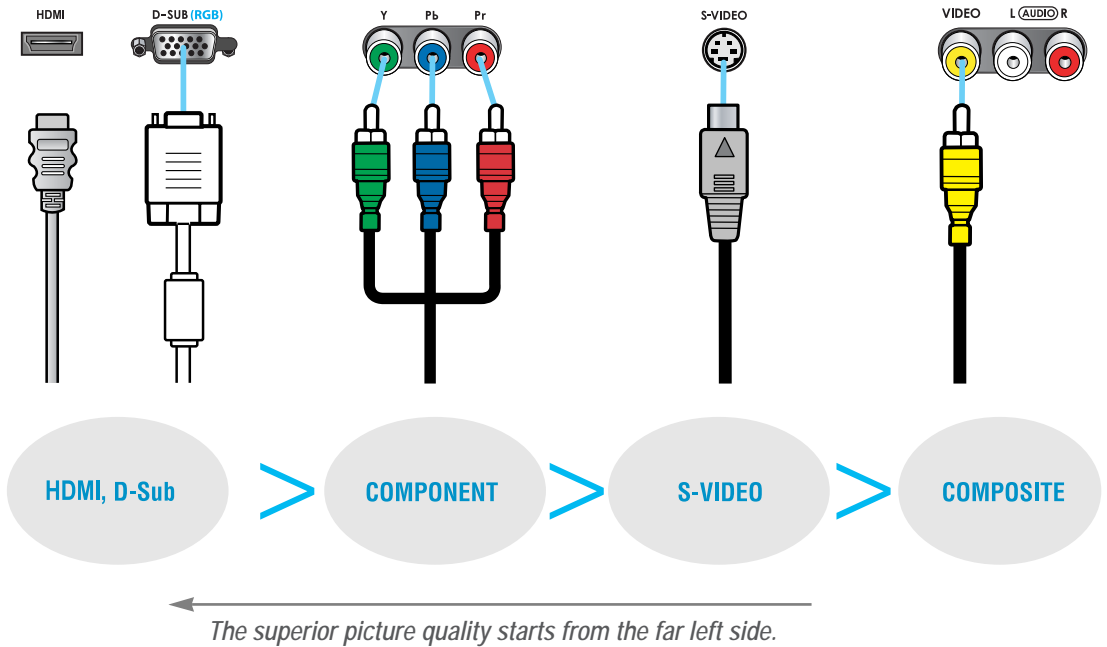

#### TIP

- When connecting an external device, ensure to read the connecting device's manual. The location or the number of the terminals on the external device may be different depending on its model.
- Connect a **HDMI** connection to the output of DVD, cable receiver or satellite receiver. Connecting a **HDMI** connection to a PC may result in a message, "Unknown Signal".
- Do not power on until all necessary connections are made. If power is given before connections completed, this may damage the product.
- Make sure to match the cable in color with the terminal.
- Make sure to check the type of terminals to be connected.

# How to Connect a VCR/Cable Receiver

## Connection Method

- 1 Connect the Video cable or S-Video cable between Video/S-Video output terminal of VCR or Cable receiver and Video/S-Video input terminal of TV. (Connect the jacks to terminals in the same color.)
- 2 Connect the Audio cable (Left: white, Right: red) between Audio output terminal of VCR or cable receiver and Audio input terminal of TV. (Connect the jacks to terminals in the same color.)

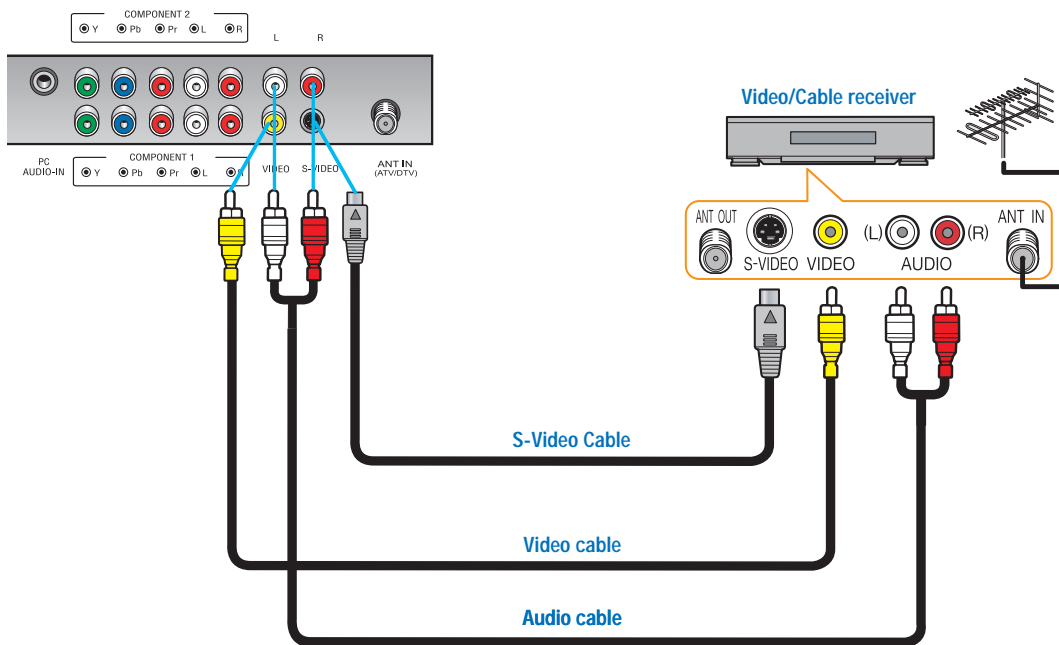

## How to Watch

- 1 Turn on TV and press **SOURCE**  on remote control until showing AV1(CVBS) or AV1(S-Video) banner on the bottom side.

AV1(Video)

AV1(S-Video)

For more information, read the user's guide of VCR or cable receiver.

**TIP**

To enjoy better picture quality, use the S-Video cable rather than the composite cable.



## How to Connect a SET-TOP BOX or DVD Player

### Connection Method

- 1 Connect the Video cable (Y, Pb, Pr) between output terminals (Y, Pb, Pr) of DTV receiver or DVD player and the input terminals (Y, Pb, Pr) of DTV/DVD (480i/480p/720p/1080i) on the rear of TV. (Connect the jacks to terminal in the same color.)
- 2 Connect the Audio cable between Audio output terminal of DTV receiver or DVD player and Audio input terminal for DTV/DVD Audio on the rear of TV. (Connect the jacks to terminals in the same color.)

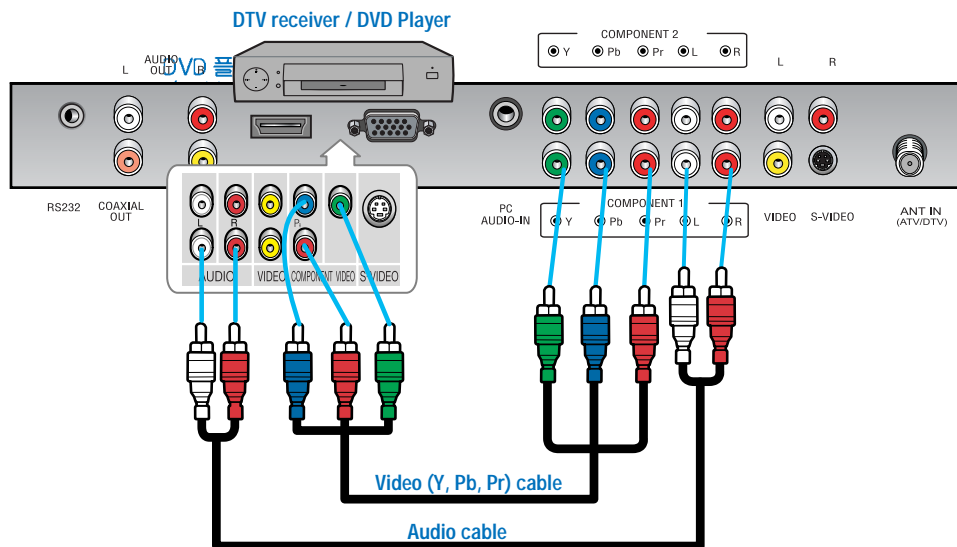

### How to Watch

- 1 Turn on TV and press  on remote control until showing YPbPr1 or YPbPr2 banner on the bottom side

YPbPr1

YPbPr2

For more information, read the user's guide of DTV receiver or DVD player.

### TIP

- Output terminal mark (Y, Pb, and Pr) of DVD player may be indicated as Y, B-Y, R-Y/Y-Cb-Cr /Y-Pb-Pr according to the type of DVD player models.
- If your DVD player or Set Top Box supports **HDMI** /D-SUB, see Connecting to a PC (page 19) for connection. You can enjoy more clear picture quality.

# How to Connect a Camcorder/Game Player

## Connection Method

- 1 Connect the Video/S-Video cable between Video/S-Video output terminal of Camcorder/Game player and Video/S-Video input terminal of TV. (Connect cables and terminal in the same colors.)
- 2 Connect the Audio cable (Left-white, Right-red) between Audio output terminal of Camcorder/Game player and Audio input terminal of TV. (Connect the jacks to terminals in the same color.)

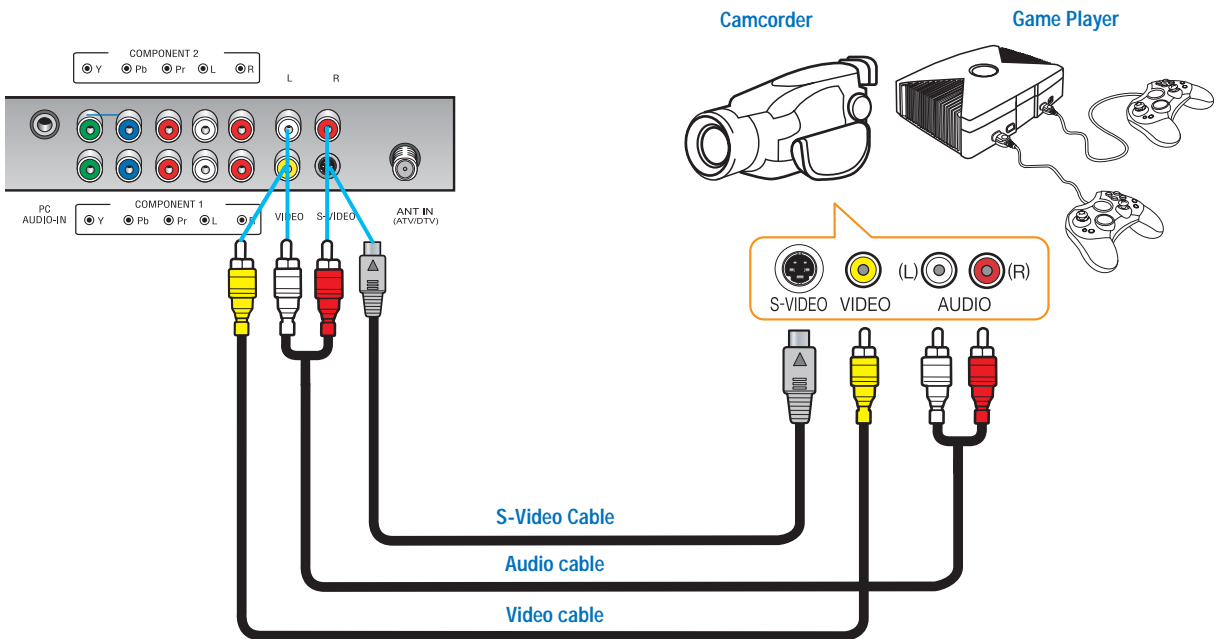

## How to Watch

- 1 Turn on TV and press **SOURCE** on remote control until showing AV1(CVBS) or AV1(S-Video) banner on the bottom side.

AV1(Video)

AV1(S-Video)

For more information, read the user's guide of Game player or Camcorder.



# How to Connect to a PC

## Connection Method

- 1 Connect the PC signal cable (15-pin D-sub) between the output terminal of PC and the D-sub input terminal of TV.
- 2 Connect the Audio cable between Audio output terminal of PC and Audio input terminal for PC on the rear of TV. (Connect the jacks to terminals in the same color.)

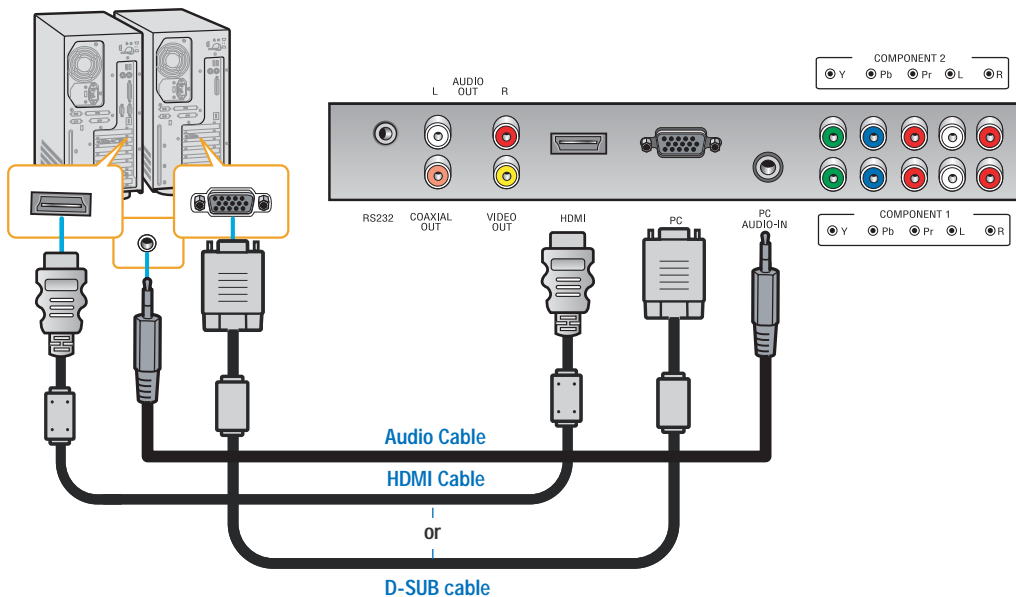

## When Using as a PC Monitor

- 1 Turn on TV and press  on remote control until showing HDMI or VGA banner on the bottom side.

HDMI

VGA

### TIP

- If you use the **HDMI** connection, you can enjoy better picture quality.
- This product supports Plug-and-Play function.
- We recommend the above method if the DVD player or set top box supports DTV signal with **HDMI/D-Sub** (15 pin) cable for the better picture quality.
- If you input an unsupported resolution in PC or **HDMI** mode, the screen won't be displayed properly.



## Resolutions Supported in PC

Resolution	Horizontal frequency	Vertical frequency
640 x 480	31.47	59.94
	37.50	75.00
720 x 400	31.47	70.08
800 x 600	37.88	60.32
	46.88	75.00
1024 x 768	48.36	60.00
	56.50	70.10
	60.02	75.03



## HDMI Connection

HDMI \*1 (High Definition Multi media Interface) is the first all digital consumer electronics A/V interface that supports uncompressed standard. The HDMI terminal supports both video and audio information. To the HDMI\*1 input terminal, you can connect an EIA/CEA-861/861B\*2 compliant consumer electronic device, such as a Set Top Box or DVD player with HDMI or DVI output terminal. Input a High-bandwidth Digital Content Protection (HDCP) high-definition picture source to this HDMI terminal, so you can display the high-definition pictures on this TV in the digital form.

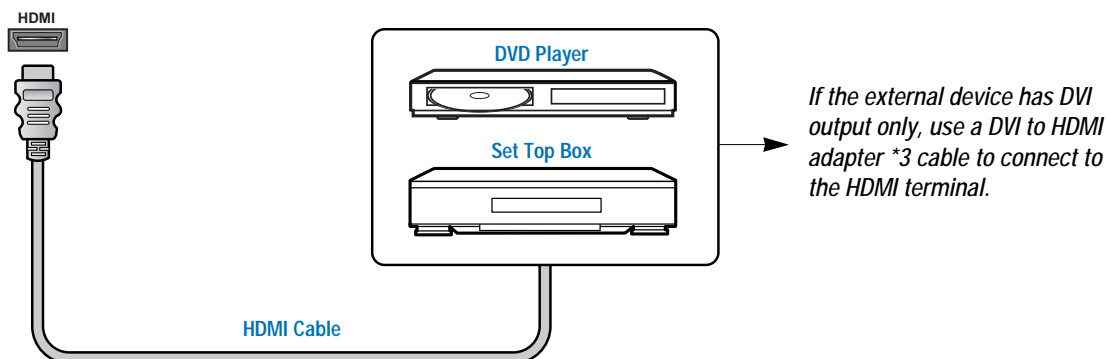

### Compatible VIDEO Signal

Resolution	No. of dots(HXV)	Vertical scanning frequency(Hz)
1080i	1920 X 1080i	59.94/60
480p	720 X 480p	59.94/60
	640 X 480p	59.94/60
720p	1280 X 720p	59.94/60

This input terminal is not intended for use with computers.

Compatible sampling frequency of AUDIO signal through HDMI (L.PCM) : 48kHz / 44.1kHz / 32 kHz

Notes:

- This HDMI connector is Type A.
- If you connect an equipment without a digital output terminal, connect to the COMPONENT VIDEO, S VIDEO or VIDEO input terminal on the TV so you can enjoy an analog signal.
- The DIGITAL IN terminal can only be used with 1080i, 480i or 480p picture signals. Set the Digital Set -Top -Box DIGITAL OUT terminal Output setting to 1080i, 480i or 480p. For detailed information, refer to the Digital Set -Top -Box instruction manual. If you cannot display the picture because your Digital Set -Top -Box does not have a DIGITAL OUT terminal Output setting, use the component Video Input (or the S Video Input or Video Input). In this case the picture will be displayed as an analog signal.

## How to Watch

- 1 Turn on TV and Press  on remote control until showing HDMI banner on the bottom side.



### TIP

- \*1 HDMI, the HDMI logo and High-Definition Multimedia Interface are trademarks or registered trademarks of HDMILicensing LLC.
- \*2 EIA/CEA-861/861B profiles compliance covers profiles for transmission of uncompressed digital video including high bandwidth digital content protection.



# How to Connect an External Visual Device

You can connect your TV to other visual device to watch TV program at the same time.

## Connection Method

- 1 Connect the Composite Video cable between Video input terminals of an external device and the Video output terminals for Video on the rear of TV. (Connect the jacks to terminals in the same color.)
- 2 Connect the Audio cable between Audio input terminal (Left-white, Right-red) of an external device and Audio output terminal for Video on the rear of TV. (Connect the jacks and terminals in the same color.)
- 3 For more information, read the user's guide of an external device.

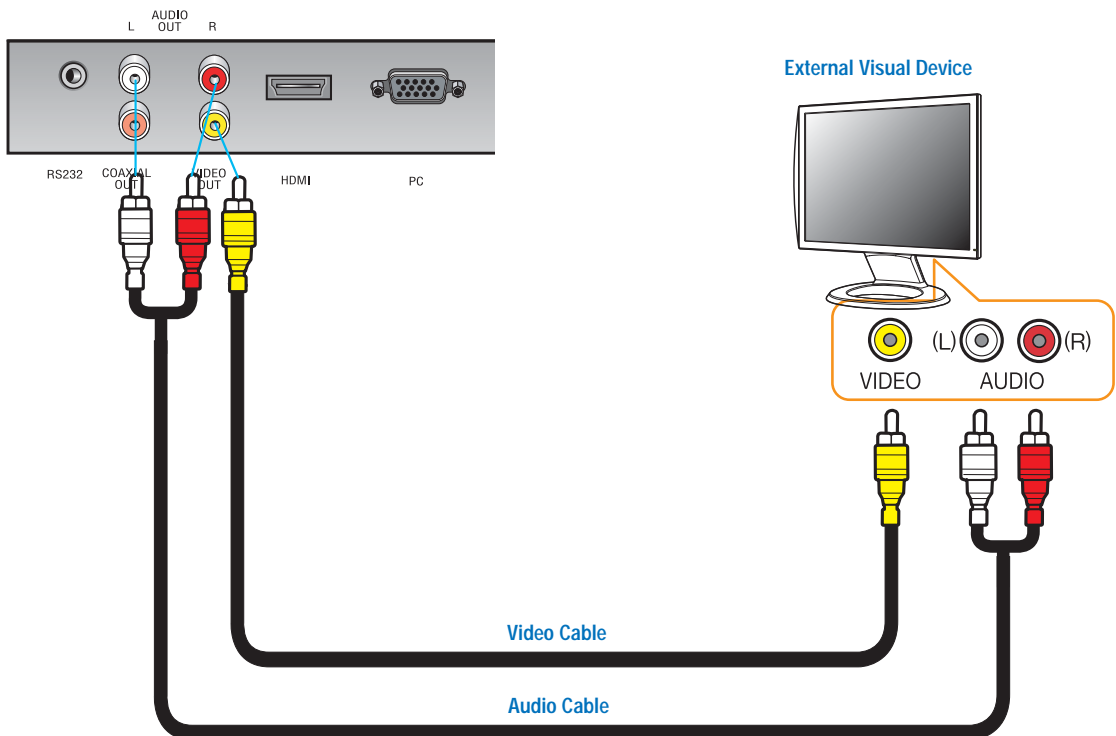

Video and Audio outputs are available only when watching an Analog TV, Digital TV or VCR. This is not supported in the Input Mode of Component, HDMI /D-SUB or S-Video.

# How to Use Digital Sound

## Connection Method

- 1 Connect the coaxial cable to the digital audio output terminal for coaxial cable or SPDIF optical digital audio output terminal on the rear of TV.
- 2 Select Digital Sound Output. (See page 40~41)
- 3 For more information, read the user's guide of the external sound device.

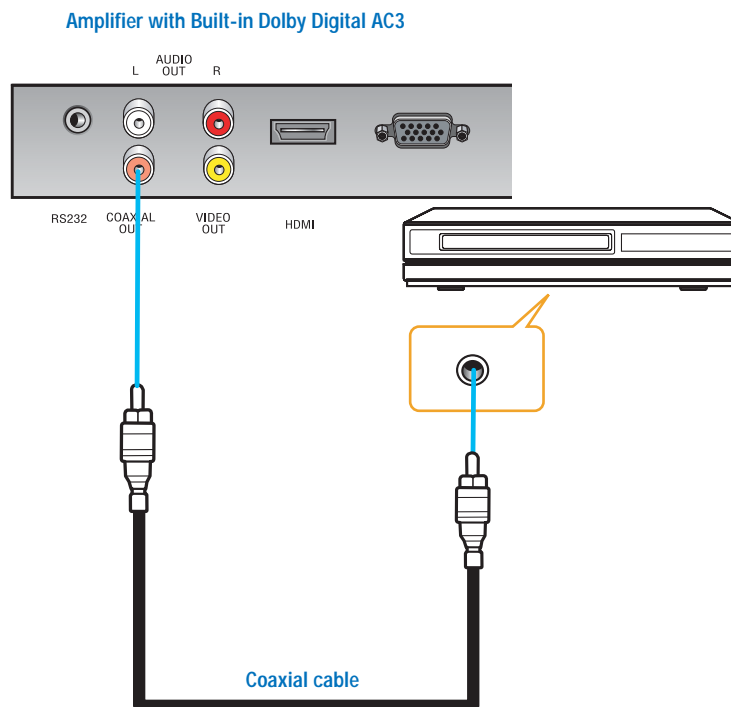



# How to Select TUNER MODE

You can choose the RF-input between off-air and cable.



Press Menu button.  
Menu items appear on the screen.

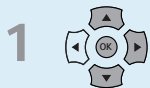

Press up or down button to move to "channel"  
Press or buttons to select "channel"

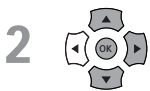

Press up or down button to move to Tuner Mode  
Press or buttons to select Tuner Mode

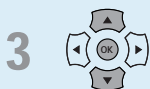

Press up or down button to move to Air / Cable  
and Press button to select item you want.



Press MENU button after the setting is done,  
and Menu goes to the previous menu.  
If the EXIT button is pressed, the menu will disappear.



# How to Store Channels Automatically

- Your TV can memorize and store all of the available analog/digital broadcast signals for both "off-air" (antenna) and cable channels.
- Before your television can begin memorizing the available channels, make sure to specify the type of the signal source (antenna or cable) connected to your TV.



Press Menu button.  
Menu items appear on the screen.

1



Press Up or Down button to move to "channel".  
Press **OK** or **▶** button to select "channel".



2



Press Up or Down button to move to "AUTO SCAN".  
Press **OK** or **▶** button to select "AUTO SCAN".



3



Press **OK** button and Auto Scan is Activated



**TIP**

- In the middle of AUTO SCAN, if you press **OK** button once, AUTO SCAN is interrupted. Press the Menu button to exit. Then the original channel is returned.
- If you have changed the connection of an antenna or cable, perform AUTO SCAN again.



# How to Add/Eraser Channels Manually

Users can add or erase the desired channels.



Press channel buttons or the number buttons on remote control to view the channels that will be added or erased.



- To Add Channel  
Add the channel by pressing the ADD/ERASE button.

Channel Added

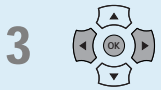

- To Delete Channel  
Press the ADD/ERASE button to erase the channel  
Press Left and Right buttons to set 'YES/NO'.



Press button to set.

Channel Deleted



# How to Set Channel Edit and Favorite Channels

Users can store frequently watched channels to quickly access a preferred channel.



Press Menu button.  
Menu items appear on the screen.

1



Press Up or Down button to move to "channel".  
Press **OK** button or **▶** to select "channel".



2



Press Up or Down button to move to "channel edit".  
Press **OK** button or **▶** to select "channel edit".



3



Press **OK** button to "select".

You can channel and Favorite-channels by pressing add/erase, Up/Down, left/right and **OK** buttons.



Press MENU or exit button after the setting is done, and you can save the channels you select.



The Favorite function is available only with remote control.



# How to See Signal Strength

The function is only for DTV channel.



Press menu button.  
menu items appear on the screen.

1



Press Up or Down button to move to "channel".  
Press **OK** or **▶** button to select "channel".

2



Press Up or Down button to move to "signal strength".  
Press **OK** or **▶** button to select "signal strength"  
then the signal strength of antenna appears  
on the screen.



Press Menu button after the setting is done.  
menu goes to the previous menu  
If the Exit button is pressed, the menu will disappear.



# How to Set The Input Mode



Press Menu button.  
Menu items appear on the screen.

1



Press Up or Down button to move to "channel".  
Press **OK** or **▶** button to select "channel".



2



Press Up or Down button to move to "external input".  
Press **OK** or **▶** button to select "external input".



3



Press left or right button to set input mode  
Whenever press left/right button to set input mode  
Changes in following order.  
⇒ TV(Air/Cable) ⇒ AV1(CVBS) ⇒ AV1(S-Video)  
⇒ YPbPr1 ⇒ YPbPr2 ⇒ HDMI ⇒ VGA



Press Menu button after the setting is done, and Menu goes to the previous Menu.  
If the Exit button is prested, the menu will disappear.

You can set the input mode quickly using the remote control press the **SOURCE** button

Whenever press this button, the input mode changes if following order  
⇒ TV(Air/Cable) ⇒ AV1(CVBS) ⇒ AV1(S-Video) ⇒ YPbPr1  
⇒ YPbPr2 ⇒ HDMI ⇒ VGA



# How to Select the Picture Mode

Users can automatically adjust the picture mode according to the input mode.



Press Menu button.  
Menu items appear on the screen.

1



Press Up or Down button to move to picture.  
Press **OK** or **▶** button to select picture.

2



Press Up or Down button to move to picture mode  
Press **OK** or **▶** button to select

3



Whenever you press Up or Down button, the mode changes in following order.  
⇒ Custom ⇒ Standard ⇒ Mild ⇒ Vivid



Press MENU button after the setting is done,  
and Menu goes to the previous menu.  
If the EXIT button is pressed, the menu will disappear.



**CUSTOM** : When the user wants to directly set the values ➔ [See the next page](#)

**STANDARD** : Most video contents are appropriate to this mode.

**MILD** : Soft display.

**VIVID**: Clear and Vivid display

## PICTURE

How to Directly Select Picture Mode :  Press Picture button.

- Whenever press this button the mode changes in following arder. ⇒ Custom ⇒ Standard ⇒ Mild ⇒ VIVID.







- The adjustment of Contrast, Brightness, Sharpness, Saturation and Tint is allowed only in the Custom mode.



# How to Set the Desired Picture



Users can manually adjust their desired picture.



- MENU**  



Press Menu button.  
Menu items appear on the screen.
- 1** 

Press Up or Down button to move to picture.  
Press  or  button to select picture.
- 2** 

Press Up or Down button to move to picture mode  
Press  button or  to select picture mode
- 3** 

Press Up or Down button to move to custom and  
Press  button to make a selection
- 4** 

Press Up or Down button to move to "Brightness".  
Press  or  button to select "Brightness".
- 5** 

Press Left or Right button to adjust.
- EXIT**  

Press MENU button after the setting is done,  
and Menu goes to the previous menu.  
If the EXIT button is pressed, the menu disappears.



**BRIGHTNESS** : Adjust the brightness of the entire picture.  
**SATURATION** : Adjust colors into deeper or lighter colors.  
**CONTRAST** : Adjust the brightness and darkness of object and background.  
**SHARPNESS** : Adjust clarity of outline of objects.  
**TINT** : Adjust colors naturally.  
**COLOR TEMP** : Whenever You Press left or right button, the mode changes in following order NORMAL ⇄ WARM ⇄ COOL  
**DNR** : Reuce the Digital Noise in the DTV mode.

**TIP** SHARPNESS, TINT are not applied to PC and HDMI modes.

PICTURE



# How to Select the Aspect Ratio

Users can manually adjust size of the screen.



Press Aspect button.  
Menu items appear on the screen.

Whenever you press Aspect button,  
the mode changes in following order.

⇒ WIDE ⇒ NORMAL ⇒ ZOOM

## AUTO (This is applied in digital broadcasting input mode only.)

The screen size automatically changes according to a signal source received  
(General broadcast → 4:3, Wide broadcast → 16:9)

### WIDE

General broadcast picture is adjusted  
to 16:9.



### Normal

4:3 general picture size



### ZOOM

Picture enlarged to 16:9 format, letter  
box format.



# How to Select the Audio Mode

Users can adjust sound mode automatically as they want.



Press Menu button.  
Menu items appear on the screen.

1



Press Up or Down button to move to sound .  
Press **OK** or **▶** button to select sound .



2



Press Up or Down button to move to sound mode  
Press **OK** or **▶** button to select sound mode.



3



Mode is selected.  
Whenever you press Up or Down button,  
the mode changes in following order.  
⇒ CUSTOM ⇒ STANDARD ⇒ MOVIES  
⇒ MUSIC ⇒ SPEECH



Press MENU button after the setting is done, and Menu goes to the previous menu.  
If the EXIT button is pressed, the menu will disappear.

- CUSTOM : When the user wants to set the value. ➔ See the next page
- STANDARD : General sound mode. This fits most audio contents.
- MOVIES : For enjoying vivid sound.
- SPEECH : For enjoying clear sound.
- MUSIC : For enjoying original sound.

How to Directly Select Sound Mode :  Press SOUND button.

Users can select ⇒ Custom ⇒ Standard ⇒ Movies ⇒ Music ⇒ Speech



# How to Adjust the Desired Audio Mode

Users can adjust sound mode manually as they want.



Press Menu button.  
Menu items appear on the screen.

1



Press Up or Down button to move to sound.  
Press **OK** or **▶** button to move to sound.

2



Press Up or Down button to move to sound mode  
Press **OK** or **▶** to select.

3



Press Up or Down button to move to custom.  
and press **OK** button to make a selection.

4



Press Up or Down to select items.  
(Table, Boss and blance)

5



Press **OK** or **▶** button to select items  
Move between the items listed using UP or Down button.  
Adjust the level of the item selected using  
Left or Right button.



Press MENU button after the setting is done,  
and Menu goes to the previous menu.  
If the EXIT button is pressed, the menu disappears.

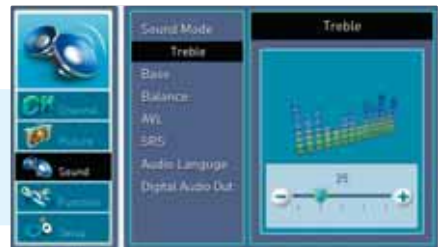

TREBLE: Adjusts the range size of high sound.















BASS: Adjusts the range size of low sound.

BALANCE : Adjusts the balance of left and right speakers.



# How to Use the Automatic Volume Control

With this Automatic Volume Level Control, everything you watch will always maintain the volume level that you decide. Basically it is set to "off"

<p>MENU </p>	<p>Press Menu button. Menu items appear on the screen.</p>	
<p><b>1</b> </p>	<p>Press Up or Down button to move to sound . Press  or  button to select sound .</p>	
<p><b>2</b> </p>	<p>Press Up or Down button to move to AVL. Press  or  button to select AVL.</p>	
<p><b>3</b> </p>	<p>Press  or  button to set to on/off. Press  button to set to on/off.</p>	
<p>EXIT </p>	<p>Press MENU button after the setting is done, and Menu goes to the previous menu. If the EXIT button is pressed, the menu will disappear.</p>	

SOUND

**TIP** If the SRS TruSurround XT function is activated, the AVL is disabled.



# How to Listen to SRS TruSurround XT (Surround)

Users can enjoy spectacular 3D sound.



Press Menu button.  
Menu items appear on the screen.

1



Press Up or Down button to move to sound.  
Press or button to select sound.

2



Press Up or Down button to move to SRS.  
Press or button to select SRS.

3



Press Left and Right buttons to set to  
OFF/Tresurround XT.



Press MENU button after the setting is done, and Menu goes to the previous menu.  
If the EXIT button is pressed, the menu will disappear.



SOUND















is a trademark of SRS Labs, Inc.  
TruSurround XT technology is incorporated under  
license from SRS Labs, Inc.

**TIP**

The SRS TruSurround XT function is activated only when the audio input signal is Stereo.

# How to Set Audio Language

While watching a digital program, you can listen to foreign language if the program is supported with foreign language.

	<p>Press Menu button. Menu items appear on the screen.</p>	
<p><b>1</b></p> 	<p>Press Up or Down button to move to sound . Press  or  button to select sound .</p>	
<p><b>2</b></p> 	<p>Press Up or Down button to move to 'AUDIO LANGUAGE'. Press  or  button to select 'AUDIO LANGUAGE'.</p>	
<p><b>3</b></p> 	<p>Whenever you press Left or Right button, the mode shifts in following order. ⇒ ENGLISH ⇒ FRANCE ⇒ SPANISH</p>	
	<p>Press MENU button after the setting is done, and Menu goes to the previous menu. If the EXIT button is pressed, the menu will disappear.</p>	

SOUND

**How to Directly Select Audio Language :** Press the  button.

- Whenever you press this button, the mode shifts ⇒ MONO ⇒ STEREO ⇒ SAP in order when receiving analog signals.
- You can select one of the languages listed you prefer when receiving digital signals.

**TIP** - If you want to see language information while watching a digital channel, press the  button to display language information that is currently received.



# How to Set the Digital Audio Output

The digital audio output terminal allows you to enjoy digital sound. (For more details, see page 24)



Press Menu button.  
Menu items appear on the screen.

1



Press Up or Down button to move to sound .  
Press or button to select sound.



2



Press Up or Down button to move to "DIGITAL AUDIO OUT"  
Press or buttons to select Digital Audio out.



3



Whenever you press Left or Right button, the mode shifts in following order.  
⇒ Dolby ⇒ PCM



Press MENU button after the setting is done,  
and Menu goes to the previous menu.  
If the EXIT button is pressed, the menu will disappear.

Manufactured under license from Dolby Laboratories.  
"Dolby Digital" and the double-D symbol are trademarks of Dolby Laboratories.

# How to Set Auto Lock

This function is used to prevent from using the control buttons on the front top of the TV or from connecting external devices to the TV. You make sure to set a PIN number to use this function.



Press Menu button.  
Menu items appear on the screen.

1



Press Up or Down button to move to function .  
Press **OK** or **▶** button to select function .

2



Press Up or Down buttons to move to "AUTO LOCK".  
Press **OK** or **▶** button to select "AUTO LOCK".

3

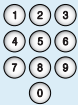

Then the Enter PIN number window appears.  
The default is 4 digits (0-0-0-0).

4



**- To set Blocking :**  
Press Up or Down button to move to "SET BLOCKING".  
Press **OK** or **▶** button to select "SET BLOCKING"

5



Press Up or Down button to move to 'ON/OFF'.  
Press **OK** button to make a selection.

6



**- To set Channel blocking :**  
Press Up or Down button to move to "CHANNEL BLOCKING".  
Press **OK** button to select "CHANNEL BLOCKING".

7



Then the AUX BLOCK items appear.  
Press Up or Down button to move to the item you want.  
Press **OK** button to set to 'LOCK/UNLOCK'.  
If the item is set to ON, such item is disabled.

Continued on next page .....





Continued from previous page..... (Set the Lock External Signal function.)

8



- To update DTV rating :  
Press Up or Down button to move to "DTV Rating".  
Press **OK** button to select "DTV Rating".



9



- To set setup code :  
Press Up or Down button to select "SETUP CODE".  
Press **OK** button to select "SETUP CODE"  
Then the Enter PIN number window appears.



10

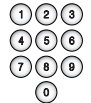

Enter a 4- digit PIN number.  
When the Confirm PIN number window appears,  
enter the PIN number again



Press MENU button after the setting is done,  
and Menu goes to the previous menu.  
If the EXIT button is pressed,  
the menu will disappear.



FUNCTION



- If you forgot your PIN number, Enter a 4-digit number (2-5-0-1) in the pin number window.

## How To Set Block By Rating

This(V-Chip) is used to block program viewing based on the ratings sent by the broadcasting station. The default setting is to allow all programs to be viewed. Viewing can be blocked by the type of program and by the categories chosen to be blocked.

### V-Chip rating and categories

Rating guidelines are provided by broadcasting stations. Most television programs and television movies can be blocked by TV Rating and/or Individual Categories. Movies that have been shown at the theaters or direct-to-video movies use the Movie Rating System (MPAA) only.

#### Ratings for Movies previously shown in theaters :

Movie Ratings :	- Blocking Off	(Permits all programs)
	- G	(General audience)
	- PG	(Parental guidance suggested)
	- PG-13	(Parents strongly cautioned)
	- R	(Restricted)
	- NC-17	(No one 17 and under admitted)
	- X	(Adult only)

*If you set PG-13 : G and PG movies will be available , PG-13, R, NC-17 and X will be blocked.*

#### Ratings for Television programs including made-for-TV movies :

- TV-G	(General audience)
- TV-PG	(Parental guidance suggested)
- TV-14	(Parents strongly cautioned)
- TV-MA	(Mature audience only)
- TV-Y	(All children)
- TV-Y7	(Children 7 years older)

TV Rating Children : - Age	(applies to TV-Y, TV-Y7)
- Fantasy Violence	(applies to TV-Y7)

TV Rating General : - Age	(applies to TV-G, TV-PG, TV-14, TV-MA)
- Dialogue-sexual dialogue	(applies to TV-PG, TV-14)
- U Language-adult language	(applies to TV-PG, TV-14, TV-MA)
- Sex-sexual situations	(applies to TV-PG, TV-14, TV-MA)
- Violence	(applies to TV-PG, TV-14, TV-MA)

*Continued on next page .....*





..... Continued from previous page.



Press Menu button.  
Menu items appear on the screen.

1



Press Up or Down button to move to Auto Lock.  
Press **OK** or **▶** button to select Auto Lock.  
The message "Enter PIN" will appear.

2

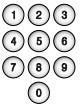

Enter your 4-digit PIN number.

3



Press Up or Down button to move to  
"BLOCK BY RATING" and press **OK** buttons  
to make a selection.  
The new screen will appear.

4



Press Up/Down and left/right buttons to  
select the items (MPAA and TV Parental midlines)

5



Press up/down and left/right buttons  
to select the item  
Press **OK** button to make a selection.



Press MENU button after the setting is done,  
and Menu goes to the previous menu.  
If the EXIT button is pressed,  
the menu will disappear.





# How to View Closed Captions

Choices in the closed caption menu are : CC Mode, Priority (Analog caption or Digital caption), and Option.

## 1. CC MODE :

ON : Captioning information is always shown, when available.

OFF : No captioning information is displayed.

## 2. PRIORITY :

You can choose whether the TV uses digital or analog captions for digital TV programs that have both or either.

- ANALOG (CAPTION) : You can select a closed caption mode, which is the mode, or source, used for displaying captioning information for analog channels or digital channels, if available.

### • CAPTION :

The form for the words that scroll across the bottom of the TV screen : usually the audio portion of the program provided for the hearing impaired.

CC 1 : For video related information that can be displayed. Script can be in any language.

CC 2/3/4 : Other modes used for video related information.

### • TEXT :

The term for the words that appear in a large black frame and almost cover the entire screen : Usually message provided by the broad caster.

T 1 : Blanks out a large portion of the picture on the television screen, and display program guide or any other information currently being transmitted.

T 2/3/4 : other modes that display information and blank out a large portion of the picture of the TV screen.

- DIGITAL (CAPTION) : You can select a closed caption, service mode(1-6) for digital channels.

The service modes support MPEG-2 based transport sources Service 1 and Service2 are the primary and secondary languages, respectively.

Service3 and service4.5.6 are additional caption sources that may be available.

*Continued on next page .....*



..... Continued from previous page.

### 3. OPTION :

Customized closed captioning for the digital caption by choosing the settings for the following options :

#### 1) cc Background

**COLOR :** Set the color of the cc Background AUTO -> BLACK -> WHITE -> RED -> GREEN -> BLUE -> YELLOW -> MARGENTA -> CYAN

**OPACIFY :** Specify the opacity for the - AUTO -> SOLED -> FIASHUNG -> TRANSLUCENT -> TRANSPARE

#### 2) Caption Text

**CAPTION SIZE :** Set the size of the words - AUTO -> SMALL -> STANDARD -> LARGE

**CAPTION STYLE :** Set the style of the words - AUTO -> STYLE1 -> STYLE2 -> STYLE3 -> STYLE4 -> STYLE5 -> STYLE6 -> STYLE7.

**TEXT COLOR :** Choose a color for the text - AUTO -> BLACK -> WHITE -> RED -> GREEN -> BLUE -> YELLOW -> MARGENTA -> CYAN

**TEXT OPACIFY :** Specify the opacity for the text - AUTO -> SOLED -> FIASHUNG -> TRANSLUCENT -> TRANSPARENT

**EDGE STYLE :** Select Edge style for the text - AUTO -> NONE -> RASIED -> DEPRESSED -> UNIFORM -> DROP -> SHADOW

**EDGE COLOR :** Select Edge color for the text - AUTO -> BLACK -> WHITE -> RED -> GREEN -> BLUE -> YELLOW -> MARGENTA -> CYAN

**ITALIC :** Convert the text in to italic - AUTO -> ON -> OFF

**UNDERLINE :** Add the underline to the text - AUTO -> ON -> OFF



Press Menu button.  
Menu items appear on the screen.

1



Press Up or Down button to move to function and press **OK** or **▶** to select function.

2



Press Up and Down buttons to move to "CAPTION" and press **OK** or **▶** button to make a selection.

3



Display MODE is highlighted.  
Press Left and Right buttons to select "OFF" or ALWAYS ON".  
Sub menu item are activated.

4



Press Up or Down button to move the item.  
Press Left or Right button to select the item.



5



- To select caption option  
Press Up or Down button to move to caption option.  
Press **OK** or **▶** button to select caption option.



6



Press left/right buttons to select Auto/Option and  
press **OK** to select make a selection.  
If caption option selected options, CC Background and  
caption Text are highlighted When selecting the  
CC Background and caption text, press **OK** button.



7



Press Up or Down button to move between the items  
(cc Background and Caption text)  
Press left/right **OK** buttons to select the item



8



Then you can choose the CC Background  
and caption text by pressing up/down  
and left/Right buttons.



Press MENU button after the setting is done,  
and Menu goes to the previous menu.  
If the EXIT button is pressed,  
the menu will disappear.





# How to Set the EPG View

- This service is only for DTV Model.



Press Menu button.  
Menu items appear on the screen.

1



Press Up or Down button to move to function.  
Press **OK** or **▶** button to select function.



2



Press Up or Down button to move to EPG View  
Press **OK** or **▶** button to select EPG View



3





















Press **OK** or **▶** button to see the EPG  
Then you can get information on the broadcast time and program.



Press MENU button after the setting is done,  
and Menu goes to the previous menu.  
If the EXIT button is pressed, the menu will disappear.

# How to Set Date / Time

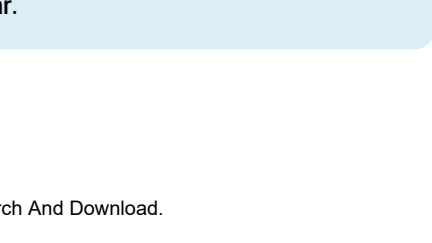
- Yes can automatically turn on or off the TV at a present time, To do this, you must set the time it you wish to use the automatic on or off timers

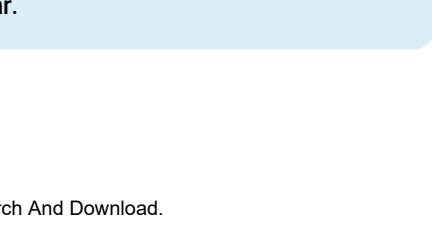
	<p>Press Menu button. Menu item appear on the screen.</p>	
<p><b>1</b></p> 	<p>Press Up or Down button to move to setup Press <b>OK</b> or <b>▶</b> button to select setup</p>	
<p><b>2</b></p> 	<p>Press Up or Down button to move to "DATE/TIME" Press <b>OK</b> or <b>▶</b> button to select "DATE/TIME"</p>	
<p><b>3</b></p> 	<p>Press Up or Down button to move to manual manually. Press <b>OK</b> button to set the current "DATE/TIME" Press Up/Down and Left/Right buttons to set year, month, day, Hour, Minute and AM/PM</p>	
<p><b>4</b></p> 	<p>After setting, Press <b>OK</b> or <b>▶</b> button to exit</p>	
<p><b>5</b></p> 	<p>"AUTO" is only for DTV mode. If you select "AUTO", Press <b>OK</b> or <b>▶</b> button to select function</p>	
<p><b>6</b></p> 	<p>Press Up/Down or left/right buttons to timezone Whenever you press the buttons, timezone is changed in following order Pacific ↔ Mountain ↔ Central ↔ Eastern ↔ Alaska ↔ Hawaii ↔ Atalantic</p>	
<p><b>7</b></p> 	<p>Press Up or Down button to move to "DAYLIGHT SAVING" Press <b>OK</b> or <b>▶</b> button to select "DAYLIGHT SAVING"</p>	
<p><b>8</b></p> 	<p>Press Up or Down button to select observe/Do not observe Press <b>OK</b> or <b>▶</b> button to make a selection.</p>	
<p><b>EXIT</b></p> 	<p>Press MENU button after the setting is done, and Menu goes to the previous menu. If the EXIT button is pressed, the menu will disappear.</p>	

SETUP



# How to Set Power on Time



Press Menu button.  
Menu items appear on the screen.



1



Press Up or Down button to move to setup.  
Press **OK** or **▶** button to select setup.



2



Press Up/Down button to select power on time  
Press **OK** or **▶** button to select power on time.

3



Press **OK** button to activate power on time  
whenever you press left and right button,  
the mode shifts in following order  
OFF ⇌ DAILY ⇌ ONCE

If you select once or daly in the "ACTIVATE"  
You can set time and channel



4



Press up/down button to select Time  
Press **OK** button to set Time  
Press Left or Right button to move between Hour,  
minute and AM/PM and Press up or down buttons  
to set Hour, minute and AM/PM



5



Press Up/Down buttons to select channel  
Press **OK** button to set channel.  
Press numeric key to set channel number  
Press **OK** button to set.



Press menu button after the setting is done,  
and Menu goes to the previous menu.  
If the EXIT button is pressed,  
the menu will disappear.

# How to Set Power Off Time

MENU  
○

Press Menu button.  
Menu items appear on the screen.



1



Press Up or Down button to move to setup  
Press **OK** or **▶** button to select setup.



2



Press Up/Down button to move to power off time  
Press **OK** or **▶** button to select power off time.

3



Press **OK** button to activate power off time  
whenever you press left and right button, the mode  
shift in following order  
OFF ⇌ DAILY ⇌ ONCE



If you select once or daly in the "ACTIVATE"  
You can set time.

4



Press Up/Down buttons to select time  
Press **OK** button to set time.  
Press Left or Right button to move between  
Hour, minute and AM/PM  
Press Up or Down buttons to set  
Hour, minute and AM/PM.  
Press **OK** button to set

EXIT  
○

Press MENU button after the setting is done,  
and Menu goes to the previous menu.  
If the EXIT button is pressed, the menu will disappear.





# How to Set Sleep Time



Press Menu button.  
Menu items appear on the screen.



1



Press Up or Down button to move to setup  
Press or button to select setup.



2



Press Up or Down button to move to sleep time  
Press or button to set sleep time.

3



Press up or down button to set sleep time  
whenever you press up or down button the mode  
shifts in following order  
OFF ⇌ 15 MINUTES ⇌ 30 MINUTES ⇌ 60 MINUTES  
⇌ 90 MINUTES ⇌ 120 MINUTES

4



Press button to set.



Press MENU button after the setting is done,  
and Menu goes to the previous menu.  
If the EXIT button is pressed, the menu will disappear.

How to Directly Set the sleep timer : Press the button.

- Whenever press this button, the mode shifts off ⇌ 15 ⇌ 30 ⇌ 60 ⇌ 90 ⇌ 120 minutes



# How to Choose Menu Language

Users can select their language preference in order to display main menus and sub menus, etc.



Press Menu button.  
Menu items appear on the screen.

1



Press Up or Down button to move to setup.  
Press **OK** or **▶** button to select setup.



2



Press up/down button to move to menu language.  
Press **OK** or **▶** button to select menu language.



3



Press **◀** or **▶** button to set language  
Whenever you press Left or Right button,  
the mode shifts in following order.  
⇒ ENGLISH ⇒ FRANÇAIS ⇒ ESPAÑOL ⇒



Press MENU button after the setting is done, and Menu goes to the previous menu.  
If the EXIT button is pressed, the menu will disappear.



# How to Set Menu Opacity

Users can select their language preference in order to display main menus and sub menus, etc.



Press Menu button.  
Menu items appear on the screen.

1



Press Up or Down button to move to setup .  
Press **OK** or **▶** button to select setup

2



Press Up or Down button to move to move to menu opacity  
Press **OK** or **▶** button to select menu opacity

3



Press left or right to set menu opacity you want.



Press MENU button after the setting is done, and Menu goes to the previous menu.  
If the EXIT button is pressed, the menu will disappear.



# How to Set Emergency Alert



Press Menu button.  
Menu items appear on the screen.

1



Press Up or Down button to move to setup .  
Press **OK** or **▶** button to select setup



2



Press Up or Down button to move to Emergency Alert.  
Press **OK** or **▶** button to select Emergency Alert.



3



Press Up or Down button to move to Low/medium  
Press left or right button to select present/discard.



Press MENU button after the setting is done, and Menu goes to the previous menu.  
If the EXIT button is pressed, the menu will disappear.



# How to Set the Geometry in PC Mode

This function is only available in PC mode.



Press Menu button.  
Menu item appear on the screen.



1



Press Up or Down button to move to setup.  
Press **OK** or **▶** button to select setup.



2



Press Up or Down buttons to move to "PC".  
Press **OK** or **▶** button to select "PC".

3



Press Up or Down button to move to position.  
Press **OK** or **▶** button to select position.



4



Press Up and Down buttons to adjust V-position .  
Press **◀** or **▶** button to adjust H-position.  
After setting press **OK** button to exit

5



Press Up and Down buttons to move to "RESET" .  
Press **OK** or **▶** button to adjust H/V-position auto .



Press MENU button after the setting is done, and Menu goes to the previous menu.  
If the EXIT button is pressed, the menu will disappear.

**H. POSITION** : To adjust the horizontal position of the picture.

**V. POSITION** : To adjust the vertical position of the picture.

**TIP**

If the display input signal (resolution) has been changed, the picture will be automatically optimized.

# Glossary 1

- Component video** Component video is sent through three cables: two color shade (chrominance) signals and one brightness (luminance) signal. Component video achieves greater color accuracy than composite video or S-VIDEO by splitting chrominance into two separate portions.
- Composite video** Composite video is sent through a single cable. Composite video combines the color shade (chrominance) and brightness (luminance) information into one video signal.
- S-VIDEO** S-VIDEO requires a single cable, which carries the brightness (luminance) and color (chrominance) signals of the picture separately. S-VIDEO provides better resolution than composite video, which carries the signals together.
- 480i** Provides 480 lines of resolution. Displays images using interlaced scanning, which first transmits all the odd lines on the TV screen and then the even lines.
- 480p** Provides 480 lines of resolution. Displays images using progressive scanning, which transmits each line from top to bottom.
- 720p** Provides 720 lines of resolution. Displays images using progressive scanning, which transmits each line from top to bottom.
- 1080i** Provides 1080 lines of resolution. Displays images using interlaced scanning, which first transmits all the odd lines on the TV screen and then the even lines. 1080i is one of the formats used by HDTV (High Definition TV).
- Digital television (DTV)** A new technology for transmitting and receiving broadcast television signals. DTV provides higher resolution and improved sound quality over analog television.
- HDTV(High Definition TV)** HDTV is a new kind of digital TV, creating a high quality picture, high definition. The HDTV provides a theater-like screen with an aspect ratio of 16:9. Supports 720p or higher.
- SDTV(Standard Definition TV)** SDTV is a new kind of standard definition digital TV, having a range of lower resolution than the HDTV. Supports 480i.
- Cable Broadcast Receiver (Converter)** A device that receives cable broadcasting. Connecting it to your TV set allows you to watch a various channels.
- Satellite Broadcasting** Provides crisp picture and clear audio quality throughout the country via a satellite.
- VHF/UHF** VHF (Very High Frequency) is the part of the frequency spectrum from 30 to 300 megahertz. UHF (Ultra High Frequency) is the part of the frequency spectrum from 300 to 3,000 megahertz.



## Glossary 2

- DVD** DVD (Digital Versatile Disc) is an optical disc that can store a huge volume of multimedia such as video, game, and audio application, etc.
- Coaxial Cable** Coaxial cable is the kind of rounded copper cable, which is generally used for TV antenna.
- Aspect ratio** Refers to the ratio between the width and height of the screen. This TV has a 16:9 (widescreen) aspect ratio, as opposed to a 4:3 aspect ratio.
- Picture Mode** Picture Mode features the optimal picture quality. There are Standard-Dynamic-Movie-Mild- Custom features in order. "CUSTOM" allows you to adjust Contrast, Brightness, Sharpness, Color and Tint.
- Sound Mode** Sound Mode features the optimal sound quality. There are Standard-News-Music-Sports- Custom features in order. "CUSTOM" allows you to adjust high frequency sound, middle frequency sound and low frequency sound.
- Digital Broadcasting** Video and Audio signals digitized and transmitted by broadcasting companies complying with the new digital television standard developed by the ATSC (Advanced Television System Committee). Digital Broadcasting technology provides multimedia services including a variety of additional services as well as high-definition quality picture.
- Analog Broadcasting** ATSC-based Video and Audio signals transmitted by broadcasting companies.
- SRS TruSurround TX** A well-recognized 3D sound technology developed by US SRS Labs, Inc. This technology delivers the ultimate audio experience only with two speakers as if through multi-channel speakers.
- Dolby Digital** Formerly known as AC-3, Dolby Digital is a digital audio coding technique that reduces the amount of data needed to produce high quality sound.
- Mono** Audio signals are produced through a single channel. It is difficult to experience a spectacular sound since audio signals are reproduced with a single speaker.
- Stereo** Audio signals are produced through two channels. A spectacular sound is reproduced with two separated speakers.
- Widescreen** Term given to picture displays with a wider aspect ratio than NTSC 4:3. Digital HDTV is 16:9 widescreen. Most motion pictures also have a widescreen aspect ratio, some even wider than 16:9.
- External source** Refers source signals that come from other external devices such as a VCR, camcorder and DVD player, etc. than a TV set.

## Glossary 3

- MTS** A bilingual service provided when an overseas film, foreign drama or overseas news, etc. is aired. You can select one of two choices: mother tongue and foreign language. Or you can listen to both languages at the same time.
- DVI** Digital Visual Interface is a specification for digital signals. This interface using TMDS transmission reduces the loss of signal, allowing to enjoy a clear and crisp image.
- HDMI** HDMI (High-Definition Multimedia Interface) is the first and only industry-supported, uncompressed, all-digital audio/video interface. HDMI provides an interface between any audio/video source, such as a set-top box, DVD player, or A/V receiver and an audio and/or video monitor, such as a digital television (DTV), over a single cable.
- Virtual channels** There is a new numbering system for DTV channels. The system, called the "DTV virtual channels," gives a number for each DTV program service, and almost always uses the analog NTSC channel number as the first number for that station. The use of virtual channels allows stations to use the same channel number "brand" for both NTSC and DTV. The printed listing services have not yet changed their format to show only the DTV virtual channel numbering system. So in the example, the station is using RF Channel 38 for DTV and is transmitting DTV programs with virtual channel numbers 15.n. The 15.n is short hand for 15.1, and 15.2 and 15.3, etc., as there can be more than one DTV program lineup from the station. So, 15.1 is the first DTV program lineup, 15.2 is the second, 15.3 is the third. Some DTV stations may have only one virtual channel, others perhaps as many as six.



# Troubleshooting

## Installation Problems

Symptom	Possible solution
How can I install an antenna?	Refer to page 16.
TV screen is not clear after installing an indoors antenna.	Indoors antenna may experience poor reception due to surrounding buildings. Please install an outdoors antenna or wireless antenna.
How can I view cable broadcasting?	Please install a cable broadcasting receiver (Converter).

## Picture Problems

Symptom	Possible solution
Neither picture nor sound comes up.	Check whether power is on. Check whether the power is cut or whether power cord is properly connected. Try to plug another product's power cord to the outlet the TV is plugged into.
Picture turns on slowly after power is on.	This symptom is not a malfunction. This delay is designed to prevent the distorted and noisy picture when power is on. However, if the picture does not appear more than 5 minutes after power is on, call a service center.
Picture is distorted or frozen while watching digital broadcasting.	This symptom may be caused by weak reception. Contact your local station or cable company.
Input Source information only appears on black screen.	Check whether your TV is properly connected to external devices.
Poor reception on some channels.	Check whether you selected proper channels. Try re-orienting your antenna.
Black and white on some channels.	Check other channels for black and white screen. Adjust colour.
TV won't turn on.	Ensure the power cord is plugged.
Screen is too bright or too dark.	Adjust brightness.



**Auto On does not work.**

Ensure to use the remote control or power button on the product to turn off your TV. If you unplug the power cord, the stand-by consumption power becomes 0 (zero), which causes the programmed time to be erased.

**After setting the time, I turned TV off and turn it on. The programmed information has been erased.**

Ensure to use the remote control or power button on the product to turn off your TV. If you unplug the power cord, the stand-by consumption power becomes 0 (zero), which causes the programmed time to be erased.

## Sound Problems

Symptom	Possible solution
Too much noise occurs.	Check whether the audio setting is in the Stereo mode. In the Stereo mode, the sound may be distorted in the area where experiences poor reception or is located far away from a TV broadcasting station.
No sound while viewing a cable channel	Make sure an audio or audio/video component is securely inserted into the appropriate jacks. Check other channels for sound. Check the volume settings on the cable broadcasting receiver.
Picture is OK but sound does not come out.	Try to press volume up/volume down buttons of your remote control. Try to press MUTE buttons of your remote control.
One of the speakers does not produce sound.	Select sound balance and make proper adjustment. (Page 37) Check the speaker connection cables.

## General



## Care and Cleaning

### Cabinet Cleaning

Wipe a soft dry cloth.

Do not use inflammables like Benzene or Thinner, or wet clothes.  
Do not scratch the panel of LCD with a fingernail or pointed object.



### Screen Cleaning

Clean the screen with a soft cloth moistened in mild glass detergent and dry with a soft cloth.

Never use any solvent on the screen such as Acetone, Benzene, or Thinner, etc.

### Cleaning Inside

When the inside needs to be cleaned, contact a service center or distribution agent where the item is purchased.

It is recommended cleaning is complete before the rainy season.

## Product Specifications - E260D/E320D/E370D

Model		E260D	E320D	E370D
Input	S-Video	1EA (A/V audio common)	1EA (A/V audio common)	1EA (A/V audio common)
	Video (RCA)	1EA (Audio included)	1EA (Audio included)	1EA (Audio included)
	Component(Y/Cb/Cr)	2EA (Audio included)	2EA (Audio included)	2EA (Audio included)
	Antenna	1EA	1EA	1EA
	PC Connection jack	D-SUB	D-SUB	D-SUB
	Max. resolution	1024 X 768 @ 75 Hz	1024 X 768 @ 75 Hz	1024 X 768 @ 75 Hz
	Audio	L/R	L/R	L/R
	HDMI-HDCP	1EA	1EA	1EA
Memory Slot	No	No	No	
Output	Video	1EA	1EA	1EA
	Audio	2EA (L/R, SPDIF)	2EA (L/R, SPDIF)	2EA (L/R, SPDIF)
TV/Video	Analog	NTSC M / FM	NTSC M / FM	NTSC M / FM
	Digital	ATSC	ATSC	ATSC
	Video system	Component, S-Video, Composite, PC, HDMI	Component, S-Video, Composite, PC, HDMI	Component, S-Video, Composite, PC, HDMI
Power	Supply	AC 100 - 240 V, 50/60 Hz	AC 100 - 240 V, 50/60 Hz	AC 100 - 240 V, 50/60 Hz
	Consumption power	Typical 130W	Typical 150W	Typical 170W
	Stand-by power	Under 5W	Under 5W	Under 5W
Dimension (W x D x H mm - Stand included)		684 x 194 x 541.5	806 x 229 x 617	939 x 350 x 728
Weigh (Stand included)		12.6 Kg	17.0 Kg	26.6Kg
Control type		Remote control, Key control	Remote control, Key control	Remote control, Key control

- The above specifications may be subject to change without prior notice.



## Product Specifications - E261D/E321D/E371D

Model		E261D	E321D	E371D
Input	S-Video	1EA (A/V audio common)	1EA (A/V audio common)	1EA (A/V audio common)
	Video (RCA)	1EA (Audio included)	1EA (Audio included)	1EA (Audio included)
	Component(Y/Cb/Cr)	2EA (Audio included)	2EA (Audio included)	2EA (Audio included)
	Antenna	1EA	1EA	1EA
	PC Connection jack	D-SUB	D-SUB	D-SUB
	Max. resolution	1024 X 768 @ 75 Hz	1024 X 768 @ 75 Hz	1024 X 768 @ 75 Hz
	Audio	L/R	L/R	L/R
	HDMI-HDCP	1EA	1EA	1EA
Memory Slot	No	No	No	
Output	Video	1EA	1EA	1EA
	Audio	2EA (L/R, SPDIF)	2EA (L/R, SPDIF)	2EA (L/R, SPDIF)
TV/Video	Analog	NTSC M / FM	NTSC M / FM	NTSC M / FM
	Digital	ATSC	ATSC	ATSC
	Video system	Component, S-Video, Composite, PC, HDMI	Component, S-Video, Composite, PC, HDMI	Component, S-Video, Composite, PC, HDMI
Power	Supply	AC 100 - 240 V, 50/60 Hz	AC 100 - 240 V, 50/60 Hz	AC 100 - 240 V, 50/60 Hz
	Consumption power	Typical 130W	Typical 150W	Typical 170W
	Stand-by power	Under 5W	Under 5W	Under 5W
Dimension (W x D x H mm - Stand included)		815 x 194 x 476.5	965 x 229 x 551	1090 x 310 x 627
Weigh (Stand included)		12.6 Kg	17.0 Kg	26.6Kg
Control type		Remote control, Key control	Remote control, Key control	Remote control, Key control

- The above specifications may be subject to change without prior notice.



## Free Manuals Download Website

<http://myh66.com>

<http://usermanuals.us>

<http://www.somanuals.com>

<http://www.4manuals.cc>

<http://www.manual-lib.com>

<http://www.404manual.com>

<http://www.luxmanual.com>

<http://aubethermostatmanual.com>

Golf course search by state

<http://golfingnear.com>

Email search by domain

<http://emailbydomain.com>

Auto manuals search

<http://auto.somanuals.com>

TV manuals search

<http://tv.somanuals.com>