

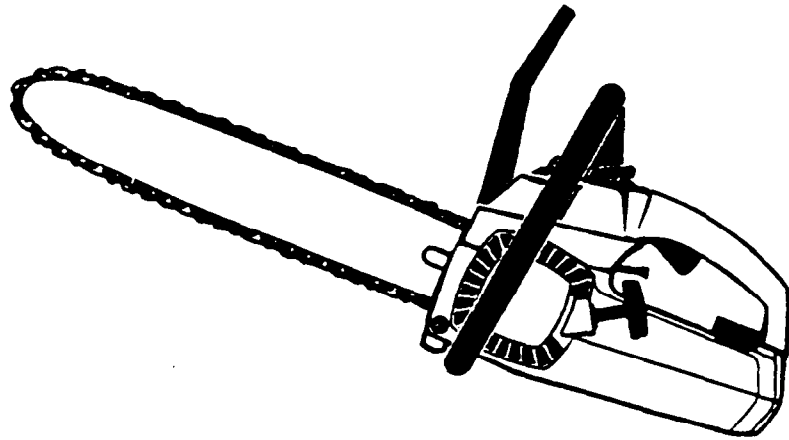

Operator's Manual  
Model: 23 Compact



- Safety Rules
- Assembly
- Operation
- Care and Maintenance

**WARNING:**

Read and follow all Safety Rules and Operating Instructions before first use of this product. Failure to do so can result in serious injury.

Husqvarna Forest & Garden Co.  
9006-J Perimeter Woods Drive  
Charlotte, NC 28216

530-083873 (9/24/95)

# SAFETY RULES

Look for this symbol  to point out important safety precautions. It means: Attention! Become alert! Your safety is involved.

**⚠ WARNING:** Always disconnect spark plug wire when making repairs except carburetor adjustments.

Because a chain saw is a high-speed wood-cutting tool, special safety precautions must be observed to reduce risk of accidents. Careless or improper use of this tool can cause serious injury.

## PLAN AHEAD

- Restrict the use of your saw to adult users who understand and can follow safety rules, precautions, and operating instructions found in this manual.

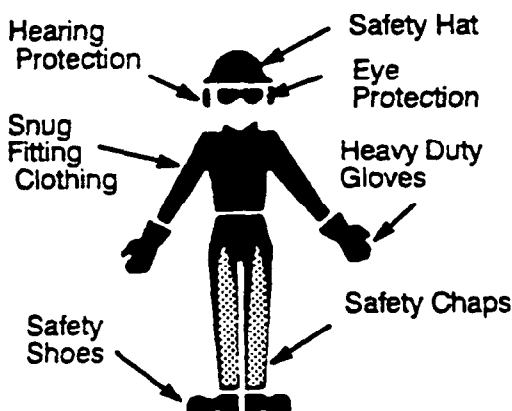

- Wear protective gear. Always use steel-toed safety footwear with non-slip soles; snug-fitting clothing; heavy-duty, non-slip gloves; eye protection such as non-fogging, vented goggles or face screen; an approved safety hard hat; and sound barriers (ear plugs or mufflers) to protect your hearing. Users should have hearing checked regularly as chain saw noise can damage hearing. Secure hair above shoulder length.
- Keep all parts of your body away from the chain when the engine is running.
- Keep children, bystanders, and animals a minimum of 30 feet (10 Meters) away from work area or when starting.
- Do not handle or operate a chain saw when you are fatigued, ill, or upset, or if you have taken alcohol, drugs, or medication. You must be in good physical condition and mentally alert. If you have any condition that might be aggravated by strenuous work, check with your doctor.
- Do not start cutting until you have a clear work area, secure footing, and, if you are felling a retreat path.

## OPERATE YOUR SAW SAFELY

- Do not operate with one hand as serious injury to the operator, helpers; by-

standers may result. A chain saw is intended for two-handed use.

- Operate only in a well-ventilated outdoor area.
- Do not operate from a ladder or in a tree, unless you are specifically trained.
- Make sure the chain will not make contact with any object while starting the engine. Never try to start the saw when the guide bar is in a cut.
- Do not put pressure on the saw at the end of the cut. Applying pressure can cause you to lose control when the cut is completed.
- Stop engine before setting saw down.
- Do not operate a chain saw that is damaged improperly adjusted, or not completely and securely assembled. Always replace handguard immediately if it becomes damaged, broken or is otherwise removed.

## MAINTAIN YOUR SAW IN GOOD WORKING ORDER

- Have all chain saw service performed by a qualified service dealer with the exception of the items listed in the maintenance section of this manual. For example, if improper tools are used to remove or hold the flywheel when servicing the clutch, structural damage to the flywheel can occur and cause the flywheel to burst.
- Make certain the saw chain stops moving when the throttle trigger is released. For correction, refer to "Carburetor Adjustments."
- Keep the handles dry, clean, and free of oil or fuel mixture.
- With the engine stopped, hand carry the chain saw with muffler away from your body, and guide bar and chain to the rear, and covered with a scabbard.
- Keep caps and fasteners securely tightened.
- Never modify your saw in any way. Use only Husqvarna accessories and replacement parts as recommended.

## HANDLE FUEL WITH CAUTION

- Do not smoke while handling fuel or while operating the saw.
- Eliminate all sources of sparks or flame in areas where fuel is mixed or poured.
- Mix and pour fuel in an outdoor area and use an approved, marked fuel container. Wipe up all fuel spills.
- Move at least 10 feet (3 meters) from fueling site before starting engine.
- Turn the engine off and let saw cool in a non-combustible area, not on dry leaves, straw, paper, etc. Slowly remove fuel cap and refuel unit.
- Store the unit in a cool, dry well-ventilated space where fuel vapors cannot reach sparks or open flames from water heaters, electric motors or switches, furnaces, etc.

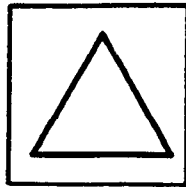

**⚠ WARNING:** This chain saw can be dangerous! Careless or improper use can cause serious or even fatal injury.



Read and understand the Operator's Manual before using the chain saw.



Always use two hands when operating the chain saw.

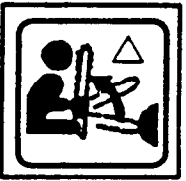

**⚠ WARNING:** Contacting the guide bar tip with any object should be avoided; tip contact may cause the guide bar to move suddenly upward and backward, which may cause serious injury.



Measured maximum kickback value, with and without chain brake, for the bar and chain combination on the label.

## GUARD AGAINST KICKBACK

**⚠ WARNING:** Rotational Kickback can occur when the moving chain contacts an object at the upper portion of the tip of the guide bar. Contact at the upper portion of the tip of the guide bar can cause the chain to dig into the object, which stops the chain for an instant. The result is a lightning fast, reverse reaction which kicks the guide bar up and back toward the operator.

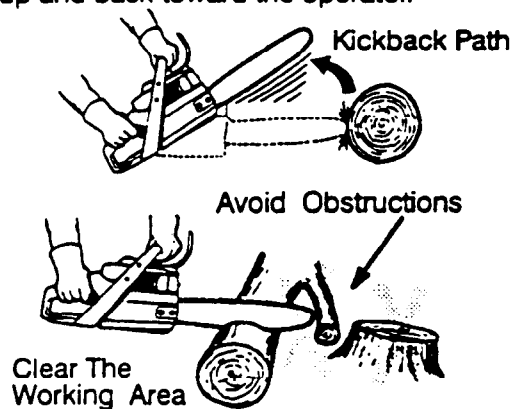

Pinch-Kickback and Pull-In occur when the chain is suddenly stopped by being pinched, caught, or by contacting a foreign object in the wood. This sudden stopping of the chain results in a reversal of the chain

force used to cut wood and causes the saw to move in the opposite direction of the chain rotation. Pinch-Kickback drives the saw straight back toward the operator. Pull-In pulls the saw away from the operator.

## REDUCE THE CHANCE OF KICKBACK

- Recognize that kickback can happen. With a basic understanding of kickback, you can reduce the element of surprise which contributes to accidents.
- Never let the moving chain contact any object at the tip of the guide bar.
- Keep the working area free from obstructions such as other trees, branches, rocks, fences, stumps, etc. Eliminate or avoid any obstruction that your saw chain could hit while cutting.
- Keep saw chain sharp and properly tensioned. A loose or dull chain can increase the chance of kickback. Follow manufacturer's chain sharpening and maintenance instructions. Check tension at regular intervals, but never with engine running. Make sure the bar clamp nuts are securely tightened.
- Begin and continue cutting at full speed. If the chain is moving at a slower

speed, there is greater chance of kickback occurring.

- Use extreme caution when re-entering a cut.
- Do not attempt cuts starting with the tip of the bar (plunge cuts).
- Watch for shifting logs or other forces that could close a cut and pinch or fall into chain.
- Use the specified Reduced-Kickback Guide Bar and Low-Kickback Chain.

#### Avoid Pinch-Kickback:

- Be extremely aware of situations or obstructions that can cause material to pinch the top of or otherwise stop the chain.
- Do not cut more than one log at a time.
- Do not twist the saw as the bar is withdrawn from an undercut when bucking.

#### Avoid Pull-In:

- Always begin cutting with the engine at full speed and the saw housing against wood.
- Use wedges made of plastic or wood. Never use metal to hold the cut open.

### MAINTAIN CONTROL

Stand to the left of the saw

Thumb on underside of handlebar

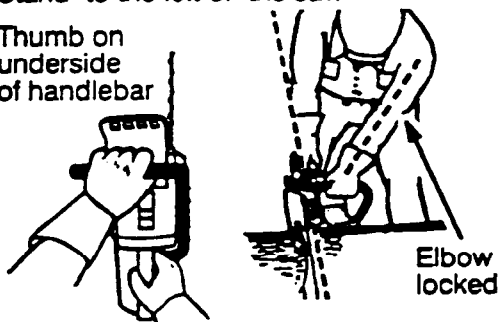

Never reverse hand positions

- A good, firm grip on the saw with both hands will help you maintain control. Don't let go. Grip the rear handle with your right hand whether you are right or left handed. Keep the fingers of your left hand around, and your left thumb under the front handlebar. Keep your left arm straight with the elbow locked.
- Position your left hand on the front handlebar so it is in a straight line with your right hand on the rear handle when making bucking cuts. Stand slightly to the left side of the saw to keep your body from being in a direct line with the cutting chain.
- Stand with your weight evenly balanced on both feet.
- Do not overreach. You could be drawn or thrown off balance and lose control.
- Do not cut above shoulder height. It is difficult to maintain control of saw above shoulder height.

### KICKBACK SAFETY FEATURES

**▲ WARNING:** The following features are included on your saw to help reduce hazard of kickback; however, such features will not totally eliminate this danger. Do not rely only on safety devices. Follow all safety rules to help avoid kickback and other forces which can result in serious injury.

- **Handguard:** designed to reduce the chance of your left hand contacting the chain if your hand slips off the front handlebar.
- **Position of front and rear handlebars,** designed with distance between handles and "in-line" with each other. The spread and "in-line" position of the hands provided by this design work together to give balance and resistance in controlling the pivot of the saw back toward the operator if kickback occurs.
- **Reduced-Kickback Guide Bar,** designed with a small radius tip which reduces the size of the kickback danger zone on the bar tip. This type bar has been demonstrated to significantly reduce the number and seriousness of kickbacks when tested in accordance with ANSI B175.1.

Reduced Kickback Symmetrical Guide Bar

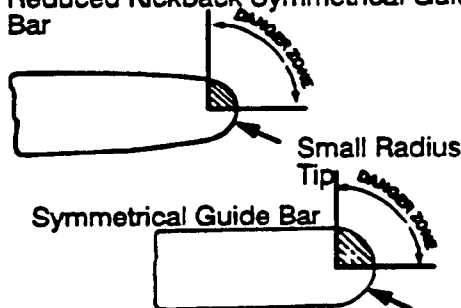

Large Radius Tip

- **Low-Kickback Chain,** has met kickback performance requirements when tested on a representative sample of chain saws below 3.8 cubic inch displacement specified in ANSI B175.1.

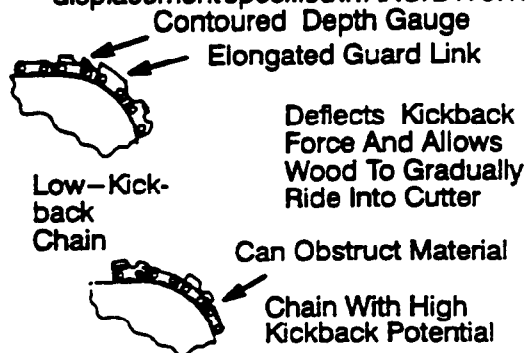

**ANSI B175.1-1991 "American National Standard for Power Tools – Gasoline Powered Saw – Safety Requirements."**

## CHAIN BRAKE & CKA ANGLE

**⚠ WARNING:** The effectiveness of a chain brake in reducing operator injuries has not yet been fully determined. We cannot represent that a chain brake is an effective safety device to prevent or reduce the hazard of injuries resulting from kickback. **DO NOT ASSUME THAT THE CHAIN BRAKE WILL PROTECT YOU IN THE EVENT OF A KICKBACK.** Instead, use the saw properly and carefully to avoid kickback. Reduced-Kickback bars and Low-Kickback chains reduce the hazard of kickback and are recommended. Repairs on a chain brake should be made by an Authorized Service Dealer.

**⚠ WARNING:** Computed kickback angle (CKA) listed on your saw and listed in the CKA table below represents angle of

kickback your bar and chain combinations will have when tested in accordance with CSA and ANSI standards. When purchasing replacement bar and chain, considerations should be given to the lower CKA values. Lower CKA values represent safer angles to the user, higher values indicate more angle and higher kick energies. Computed angles represented in the non-activated column indicate total energy and angle associated without activation of the chain brake during kickback. Activated angle represents chain stopping time relative to activation angle of chain brake and resulting kick angle of saw.

The following guide bar and chain combinations meet kickback requirements of CSA Z62.1, Z62.3, & ANSI B175.1 Use of bar and chain combinations other than those listed is not recommended and may not meet the CKA requirements per standard.

**Computed kickback angle (CKA) Table**

MODEL	BAR		CHAIN P/N	CKA without chain brake
	P/N	Length		
23 Compact	5018540-52	14"	6081001-29	43.8°

**NOTE:** This saw complies with Federal OSHA regulations for commercial logging.

**SAFETY NOTICE:** Exposure to vibrations through prolonged use of gasoline powered hand tools could cause blood vessel or nerve damage in the fingers, hands, and joints of people prone to circulation disorders or abnormal swellings. Prolonged use in cold weather has been linked to blood vessel damage in otherwise healthy people. If symptoms occur such as numbness, pain, loss of strength, change in skin color or texture, or loss of feeling in the fingers, hands, or joints, discontinue the use of this tool and seek medical attention. An anti-vibration system does not guarantee the avoidance of these problems. Users who operate power tools on a continual and regular basis must monitor closely their physical condition and the condition of this tool.

**SPECIAL NOTICE:** Your saw is equipped with a temperature limiting muffler and spark arresting screen which meets the requirements of California Codes 4442 and 4443. All U.S. forest land and the states of California, Idaho, Maine, Minnesota, New Jersey, Oregon, and Washington require many internal combustion engines to be equipped with a spark arrestor screen by law. If you operate a chain saw where such regulations exist, you are legally responsible for maintaining these parts. Failure to do so is a violation of the law. Refer to SERVICE section.

If you need assistance, contact your Authorized Service Dealer or call the 1-800 number listed on the back of this manual.

## ASSEMBLY

Do not be alarmed by a rattle in your unit. This is a normal sound from the fuel filter in the empty fuel tank. You may also smell gasoline or see oil residue on the muffler. This is normal from the testing and carburetor adjustment process while the unit was manufactured.

**⚠ WARNING:** Recheck each assembly step if the saw is received assembled. Always wear gloves when handling the chain. The chain is sharp and can cut you even when it is not moving!

### ATTACHING THE BAR & CHAIN

(If not already attached)

- Loosen and remove the bar clamp.
- Remove and recycle plastic shipping spacer.

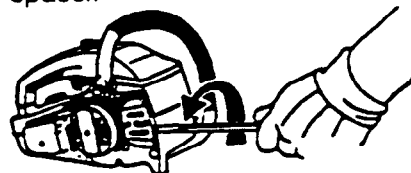

- An adjusting pin and screw is used to adjust the tension of the chain. It is very important when assembling the bar, that the pin located on the adjusting screw aligns into a hole in the bar. Turning the screw will move the adjustment pin up and down the screw. Locate this adjustment before you begin mounting the bar onto the saw. See illustration below.

- Turn the adjusting screw to move adjusting pin to the back. Further adjustment may be necessary as you mount the bar.
- Mount the bar as illustrated.
- Slide the bar toward the back.
- Use the illustration of the chain to determine the proper direction.
- Place the chain onto the sprocket located behind the clutch drum.
- Start at the top of the bar and fit chain into groove around the guide bar.
- Pull the bar forward until the chain is snug in the groove of the bar.
- Hold guide bar against the saw frame and install the bar clamp. Make sure the adjusting pin is aligned with the hole in the bar. Remember this pin moves the bar forward and backward to adjust chain tension.
- Replace the bar clamp nuts and tighten finger tight. Once the chain is tensioned you will need to tighten bar clamp nuts.

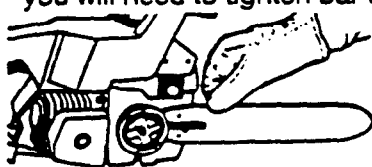

Mount the Bar

Tip of Bar →



Proper chain direction

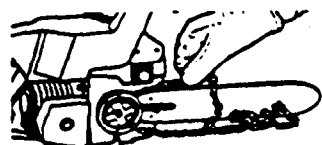

Place chain onto the sprocket

### CHAIN TENSION (Including units with chain already installed)

**NOTE:** When adjusting chain tension, make sure the bar nuts are finger tight only. Attempting to tension the chain when the bar nuts are tight will cause damage.

### Checking the tension:

Move chain around the bar. If the chain does not rotate, it is too tight. If too loose, the chain will sag below the bar.

### Adjusting the tension:

Chain tension is very important. Chain stretches during use. This is especially true during the first few times you use your saw. Always check chain tension each time you use and refuel your saw.

You can adjust the chain tension by loosening the bar clamp nuts and turning the adjusting screw 1/4 of a turn while lifting up on the bar.

- If chain is too tight, turn adjusting screw 1/4 turn counterclockwise.
- If chain is too loose, turn adjusting screw 1/4 turn clockwise.
- Lift up the tip of the bar and tighten the bar clamp nuts with the combination screwdriver/wrench.
- Recheck chain tension.



Chain moves freely

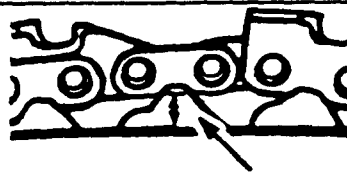

Lifts only 1/8 of an inch from bar.

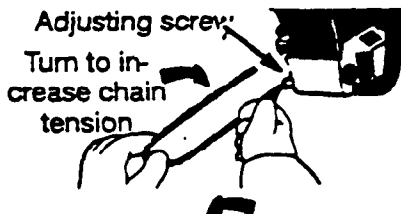

Adjusting screw:  
Turn to increase chain tension

Turn to decrease chain tension

## FUEL & LUBRICATION

### FUELING ENGINE

This engine is certified to operate on unleaded gasoline. Before operation, gasoline must be mixed with a good quality 2-cycle air-cooled engine oil. We recommend Husqvarna brand 50:1 oil. If you do not use this oil, use a good quality 2-cycle air-cooled oil designed to be mixed at a ratio of 32:1 (A 32:1 ratio is obtained by mixing 4 ounces of oil with each gallon of unleaded gasoline). When mixing fuel follow the instructions printed on the container. Always read and follow the safety rules under "Handle Fuel with Caution".

### BAR AND CHAIN LUBRICATION

The bar and chain require continuous lubrication. Lubrication is provided by the automatic oiler system when the oil tank is kept filled. Lack of oil will quickly ruin the bar and chain. Too little oil will cause overheating shown by smoke coming from the chain and/or discoloration of the bar.

In freezing weather oil will thicken, making it necessary to thin bar and chain oil with a small amount (5 to 10%) of #1 Diesel Fuel or kerosene. Bar and chain oil must be free flowing.

Husqvarna bar and chain oil is formulated to protect your unit against excessive wear

from heat and friction, and resists high temperature thinning.

- Never use waste oil.
- Stop the engine before removing caps.

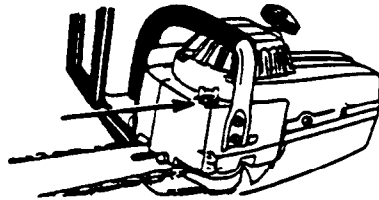

Fill the oil tank each time the fuel tank is filled

- Pull the starter rope quickly with your right hand until the engine attempts to start, then push the choke to the OFF position.
- Pull the starter rope quickly with your right hand until the engine starts.
- Allow the engine to run for approximately five seconds. Then, release the throttle trigger.

## IGNITION SWITCH

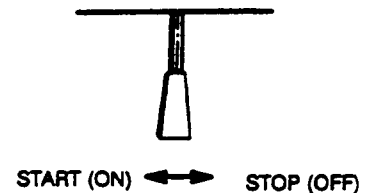

## STARTING

**⚠ WARNING:** The chain must not move at idle speed. If the chain moves refer to **CARBURETOR ADJUSTMENT**. Avoid contact with the muffler. A hot muffler can cause serious burns.

To stop the engine move the switch to the STOP or OFF position.

To start the engine hold the saw firmly as shown below.

- Move switch to the START or ON position.
- Push saw away with your right hand while pulling starter rope with your left hand. (Never reverse hand positions)

Hold saw firmly while pulling starter rope.

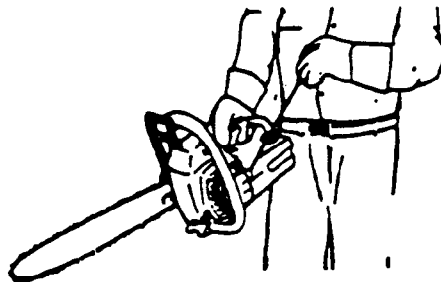

## Important points to remember

When pulling the starter rope, do not use the full extent of the rope as this can cause the rope to break. Do not let starter rope snap back. Hold the handle and let the rope rewind slowly.

For cold weather starting, start the unit at full choke; allow the engine to warm up before squeezing the throttle trigger. Do not cut material with the choke/fast idle lever at the FULL position.

For cold engine or warm engine after running out of fuel.

- Position choke to the FULL position.
- Squeeze and hold the throttle trigger.

## CHOKE

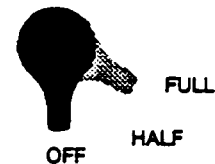

For a warm engine:

- Position choke to the OFF position.
- Pull the starter rope quickly with your right hand until the engine starts.
- Squeeze and release the throttle trigger to allowing engine to idle.

**Difficult starting or flooded engine:**

The engine may be flooded with too much fuel if it has not started after 10 pulls.

Flooded engines can be cleared of excess fuel by following the warm engine starting procedure listed above. Insure the ignition switch is in the ON or START position.

Starting could require pulling the starter rope handle many times depending on how badly the unit is flooded. If engine fails to start refer to the troubleshooting chart.

## CHAIN BRAKE

- This saw is equipped with a chain brake designed to stop the chain if kickback occurs.
- The chain brake is activated if the front hand guard is pushed forward, either manually or by centrifugal force.
- If the brake is already activated, it is disengaged by pulling the front hand guard back toward the front handle as far as possible.
- When cutting with the saw, the chain brake must be disengaged.

## Braking function control

Chain brake must be checked before each use. Engage the chain brake with the saw at idle. Accelerate to full throttle momentarily. If

chain moves have chain brake repaired by Authorized Service Dealer before use.

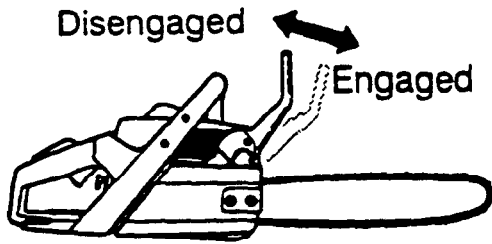

## CUTTING METHODS

### IMPORTANT POINTS

- Cut wood only. Do not cut metal, plastics, masonry, non-wood building materials, etc.
- Stop the saw if the chain strikes a foreign object. Inspect the saw and repair parts as necessary.
- Keep the chain out of dirt and sand. Even a small amount of dirt will quickly dull a chain and increase the possibility of kick-back.
- Practice cutting a few small logs using the following techniques to get the "feel" of using your saw before you begin a major sawing operation.
- Squeeze the throttle trigger and allow the engine to reach full speed before cutting.
- Begin cutting with the saw frame against the log.
- Keep the engine at full speed the entire time you are cutting.
- Allow the chain to cut for you. Exert only light downward pressure.
- Release the throttle trigger as soon as the cut is completed, allowing the engine to idle. If you run the saw at full throttle without a cutting load, unnecessary wear can occur.
- To avoid losing control when cut is complete, do not put pressure on saw at end of cut.
- Stop the engine before setting the saw down.

### TREE FELLING TECHNIQUES

**WARNING:** Do not cut near buildings or electrical wires if you do not know the direction of tree fall, at night since you will not be able to see well, or during bad weather such as rain, snow, or strong winds. as fall is unpredictable.

Carefully plan your sawing operation in advance. You need a clear area all around the tree so you can have secure footing. Check for broken or dead branches which can fall on you causing serious injury.

Natural conditions that can cause a tree to fall in a particular direction include:

- The wind direction and speed.
- The lean of the tree. The lean of a tree might not be apparent due to uneven or sloping terrain. Use a plumb or level to determine the direction of tree lean.

- Weight and branches on one side.
  - Surrounding trees and obstacles.
- Look for decay and rot. If the trunk is rotted, it can snap and fall toward the operator.

Make sure there is enough room for the tree to fall. Maintain a distance of 2-1/2 tree lengths from the nearest person or other objects. Engine noise can drown out a warning call.

Remove dirt, stones, loose bark, nails, staples, and wire from the tree where cuts are to be made.

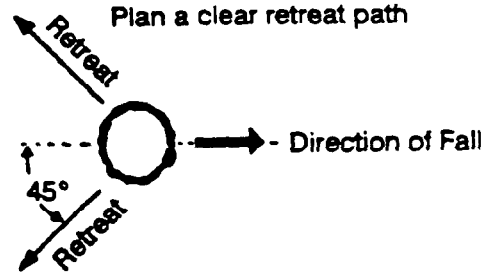

### FELLING LARGE TREES

(6 inches in diameter or larger)

The notch method is used to fell large trees. A notch is cut on the side of the tree in the desired direction of fall. After a felling cut is made on the opposite side of tree, the tree will tend to fall into the notch.

#### NOTCH CUT AND FELLING THE TREE

- Make notch cut by cutting the top of the notch first. Cut through 1/3 of the diameter of the tree. Next complete the notch by cutting the bottom of the notch. See illustration. Once the notch is cut remove the notch of wood from the tree.
- After removing the cutout of wood, make the felling cut on the opposite side of the notch. This is done by making a cut about two inches higher than the center of the notch. This will leave enough uncut wood between the felling cut and the notch to form a hinge. This hinge will help prevent the tree from falling in the wrong direction.

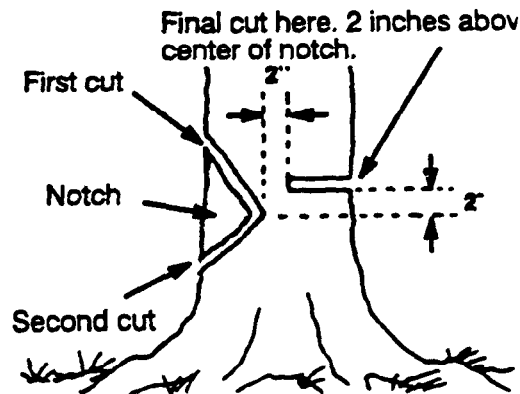

**NOTE:** Before felling cut is complete, use wedges to open the cut when necessary to



Hinge holds tree on stump and helps control fall

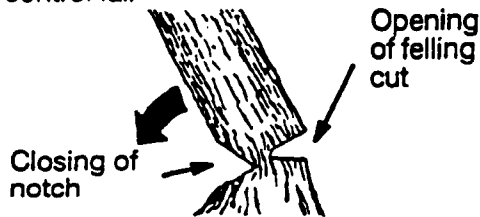

control the direction of fall. Use wood or plastic wedges, but never steel or iron, to avoid kickback and chain damage.

- Be alert to signs that the tree is ready to fall: cracking sounds, widening of the felling cut, or movement in the upper branches.
- As tree starts to fall, stop saw, put it down, and get away quickly on your planned retreat path.
- Be extremely cautious with partially fallen trees that may be poorly supported. When a tree doesn't fall completely, set the saw aside and pull down the tree with a cable winch, block and tackle, or tractor. To avoid injury, do not cut down a partially fallen tree with your saw.

## CUTTING A FALLEN TREE (BUCKING)

Bucking is the term used for cutting a fallen tree to the desired log length.

**⚠ WARNING:** Do not stand on the log being cut. Any portion can roll causing loss of footing and control. Do not stand downhill of the log being cut.

### Important points

- Cut only one log at a time.
- Cut shattered wood very carefully; sharp pieces of wood could be flung toward operator.
- Use a sawhorse to cut small logs. Never allow another person to hold the log while cutting and never hold the log with your leg or foot.
- Do not cut in an area where logs, limbs, and roots are tangled. Drag the logs into a clear area before cutting by pulling out exposed and cleared logs first.

## TYPES OF CUTTING USED FOR BUCKING

**⚠ WARNING:** If saw becomes pinched or hung in a log, don't try to force it out. You can lose control of the saw resulting in injury and/or damage to the saw. Stop the saw, drive a wedge of plastic or wood into the cut until the saw can be removed easily. Restart the saw and carefully reenter the cut. Do not attempt to restart your saw when it is pinched or hung in a log.

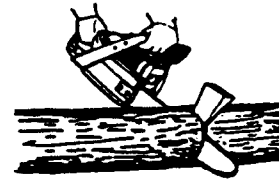

Turn saw OFF and use a plastic or wooden wedge to force cut open.

**Overcutting** begins on the top side of the log with the saw against the log. When overcutting use light downward pressure.

### Overcutting



### Undercutting

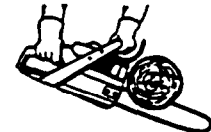

**Undercutting** involves cutting on the underside of the log with top of saw against the log. When undercutting use light upward pressure. Hold saw firmly and maintain control. The saw will tend to push back toward you.

**⚠ WARNING:** Never turn saw upside down to undercut. The saw cannot be controlled in this position.

First cut on pressure side of log

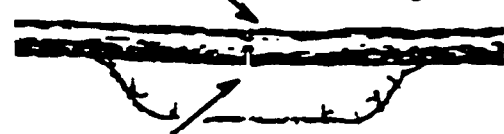

Second cut

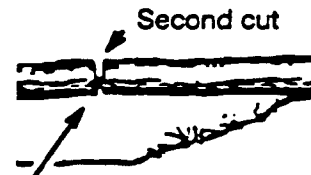

First cut on pressure side of log

## BUCKING WITHOUT A SUPPORT

- Overcut through 1/3 of the diameter of the log.
- Roll the log over and finish with a second overcut.
- Give special attention to logs under strain to prevent the saw from pinching. Make the first cut on the pressure side to relieve the stress on the log.

## BUCKING USING A LOG OR SUPPORT STAND

- Remember your first cut is always on the pressure side of the log.
- Your first cut should extend 1/3 of the diameter of the log.
- Finish with your second cut.

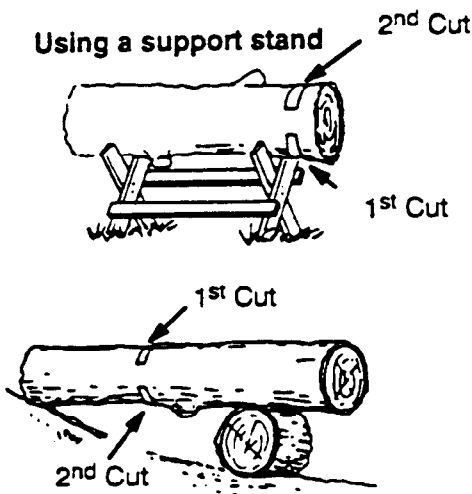

collar from the trunk of the tree.

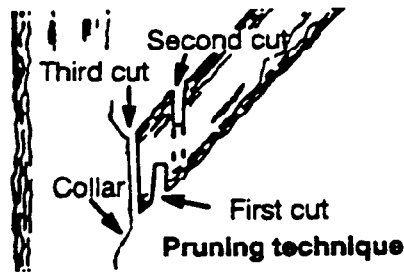

## LIMBING AND PRUNING

**WARNING:** Never climb into a tree to limb or prune. Do not stand on ladders, platforms, a log, or in any position which can cause you to lose your balance or control of the saw.

### IMPORTANT POINTS

- Watch out for springpoles. Use extreme caution when cutting small size limbs. Slender material may catch the saw chain and be whipped toward you or pull you off balance.
- Be alert for springback. Watch out for branches that are bent or under pressure. Avoid being struck by the branch or the saw when the tension in the wood fibers is released.
- Frequently clear branches out of the way to avoid tripping over them.

### LIMBING

- Always limb a tree after it is cut down. Only then can limbing be done safely and properly.
- Leave the larger limbs underneath the felled tree to support the tree as you work.
- Start at base of the felled tree and work toward the top, cutting branches and limbs. Remove small limbs with one cut.
- Keep the tree between you and the chain as much as possible.
- Remove larger, supporting branches with the 1/3, 2/3 cutting techniques described in the bucking section.
- Always use an overcut to cut small and freely hanging limbs. Undercutting could cause limbs to fall and pinch saw.

### PRUNING

**WARNING:** Limit pruning to limbs shoulder height or below. Do not cut if branches are higher than your shoulder. Get a professional to do the job.

- Make your fist cut 1/3 of the way through the bottom of the limb.
- Next make a 2nd cut **all the way through the limb**. Then cut a third overcut leaving a 1 to 2 inch

## SERVICE

We recommend all service and adjustments not listed in this manual be performed by an Authorized Service Dealer.

### MAINTENANCE SCHEDULE

#### Check For:

Fuel Mixture Level	Before each use
Bar Lubrication . . .	Before each use
Chain Tension . . . .	Before each use
Chain Sharpness . . .	Before each use
Damaged parts . . . .	Before each use
Loose caps . . . . .	Before each use
Loose fasteners . . .	Before each use

#### Inspect and Clean:

Bar . . . . .	Before each use
Complete saw . . . .	After each use
Air filter . . . . .	Every 5 hours *
Spark arrestor . . . .	Every 25 hours *

Replace spark plug . . . . . Yearly

Replace fuel filter . . . . . Yearly

\* Hours of Operation

### AIR FILTER

**CAUTION:** Do not clean filter in gasoline or other flammable solvent to avoid creating a fire hazard or producing harmful evaporative emissions.

A dirty air filter decreases engine performance and increases fuel consumption and harmful emissions. Always clean after every 5 hours of operation.

#### Cleaning the air filter:

- Clean the cover and the area around it to keep dirt and sawdust from falling into the carburetor chamber when the cover is removed.
- Remove the parts as illustrated.
- Wash the filter in soap and water.

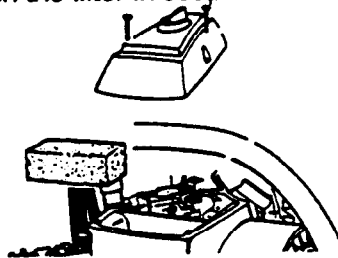

### BAR MAINTENANCE

If your saw cuts to one side, has to be forced through the cut, or been run with an improper amount of bar lubrication it may be necessary to service your bar. A worn bar will

damage your chain and make cutting difficult.

Replace your bar if bent or the inside rails of the bar are worn.

- Clean the oil holes and bar groove after each 5 hours of operation
- Remove sawdust from bar groove periodically with a wire or putty knife.

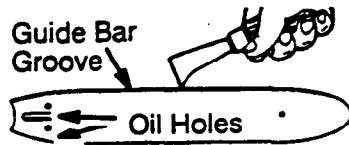

## CARBURETOR ADJUSTMENTS

Carburetor adjustment is critical and if done improperly can permanently damage your unit. We recommend you contact an Authorized Service Dealer for adjustments.

**IDLE SPEED ADJUSTMENT:** Turn the Idle Speed Screw clockwise until it stops. Now turn the screw counterclockwise 4-1/2 turns. This should allow the engine to run without the chain turning. If the chain moves at idle speed, do not use your unit. Contact an Authorized Service Dealer. Idle speed is correct when engine runs without stalling and chain does not turn.

**MIXTURE ADJUSTMENTS:** Your Carburetor includes limiter caps (Plastic caps on the mixture screws), do not force the screws beyond the stops of the limiter caps or damage will occur. Do not remove these caps. Small adjustments will affect your unit. Do not adjust more than 1/16th turn without checking performance.

## CHAIN SHARPENING

Chain sharpening is a complicated task that requires special tools. We recommend you refer chain sharpening to a professional chain sharpener. If you choose to perform your own chain sharpening, call our toll-free helpline and order a free chain sharpening guide. (See the back page of this manual for the toll-free phone number.)

## IGNITION TIMING

Ignition timing is fixed and nonadjustable.

## MUFFLER/SPARK ARRESTOR

Remove and inspect the spark arrestor screen. Clean with a wire brush. Replace damaged or worn parts.

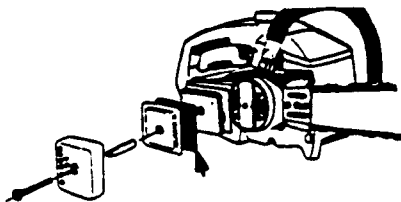

## SPARK PLUG

Replace the spark plug yearly. Use RCJ8Y Plug. Gap = .025"

## STORAGE

**WARNING:** Stop engine and allow to cool, and secure the unit before storing or transporting in a vehicle. Store unit and fuel in an area where fuel vapors cannot reach sparks or open flames from water heaters, electric motors or switches, furnaces, etc. Store unit with all guards in place. Position so that any sharp object cannot accidentally cause injury to passersby. Store the unit out of reach of children.

- Clean the unit before storing. Pay particular attention to the air intake area, keeping it free of debris. Use a mild detergent and sponge to clean the plastic surfaces and labels.
- Before storing, drain all fuel from the unit. Start engine and allow to run until it stops.

**CAUTION:** It is important to prevent gum deposits from forming in essential fuel system parts such as the carburetor, fuel filter, fuel hose, or fuel tank during storage. Alcohol blended fuels (called gasohol or using ethanol or methanol) can attract moisture which leads to fuel mixture separation and formation of acids during storage. Acidic gas can damage the engine.

## TROUBLE SHOOTING

Engine will not start.

- Ignition switch off.
- Engine flooded.
- Fuel tank empty.
- Spark plug not firing.
- Fuel not reaching carburetor.

Engine will not idle properly.

- Carburetor requires adjustment.
- Crankshaft seals worn.

Engine will not accelerate, lacks power, or dies under a load.

- Air filter dirty.
- Spark plug fouled.
- Carburetor requires adjustment.

Engine smokes excessively.

- Too much oil mixed with gasoline

# HUSQVARNA

## FOREST & GARDEN CO.

### WARRANTY STATEMENT

Effective 02/95

#### **SECTION 1: LIMITED WARRANTY**

Husqvarna Forest & Garden Company ("Husqvarna") warrants Husqvarna product to the original purchaser to be free from defective material and workmanship from the date of purchase for the "Warranty Period" of the product as set forth below:

**Lifetime Warranty:** All tiller tines, trimmer shafts, ignition coils and modules on hand held product.

**2 Year Warranty:** Riding lawn mowers, yard and garden tractors, walk behind mowers, tillers, trimmers, brushcutters, snow blowers, hand held blowers, hedge trimmers, and electrical products for noncommercial, nonprofessional, noninstitutional, or nonincome producing use, except as herein stated.

Emission control system components necessary to comply with CARB-95 and EPA regulations, except for those components which are part of engine systems manufactured by third party engine manufacturers for which the purchaser has received a separate warranty with product information supplied at time of purchase.

**1 Year Warranty:** Chain saws, clearing saws and backpack blowers for noncommercial, nonprofessional, noninstitutional, or nonincome producing use. Trimmer models 120, 125, 122, 132, 232, and 235 used for commercial purposes.

**90 Day Warranty:** Any Husqvarna product used for rental, commercial, institutional, professional, or income producing use except as otherwise provided herein.

**30 Day Warranty:** Husqvarna bow guide and replacement parts.

#### **SECTION 2: HUSQVARNA'S OBLIGATIONS UNDER THE WARRANTY**

Husqvarna will repairing or replace defective components without charge for parts or labor if a component fails because of a defect in material or workmanship during the warranty period.

#### **SECTION 3: ITEMS NOT COVERED BY THIS WARRANTY**

The following items are not covered by this warranty:

- (1) Normal customer maintenance items which become worn through normal regular use, including, but no limited to, belts, blades, blade adapters, bulbs, filters, guide bars, lubricants, rewind springs, saw chain, spark plugs, starter ropes, and tines;
- (2) Natural discoloration of material due to ultraviolet light.
- (3) Engine and drive systems not manufactured by Husqvarna; these items are covered by the respective manufacturer's warranty as provided in writing with the product information supplied at the time of purchase; all claims must be sent to the appropriate manufacturer;
- (4) Lawn and garden attachments are covered by a third party which gives a warranty, all claims for warranty should be sent to the manufacturer; and
- (5) Emission Control System components necessary to comply with CARB-95 and EPA regulations which are manufactured by third party engine manufacturer.

#### **SECTION 4: EXCEPTIONS AND LIMITATIONS**

This warranty shall be inapplicable to defects resulting from the following:

- (1) Accident, abuse, misuse, negligence, and neglect, including stale fuel, dirt, abrasives, moisture, rust, corrosion, or any adverse reaction due to incorrect storage or use habits;
- (2) Failure to operate or maintain the unit in accordance with the Owner's/Operator's manual or instruction sheet furnished by Husqvarna.
- (3) Alterations or modifications that change the intended use of the product or affects the product's performance, operation, safety, or durability, or causes the product to fail to comply with any applicable laws; or
- (4) Additional damage to parts or components due to continued use occurring after any of the above.

REPAIR OR REPLACEMENT AS PROVIDED UNDER THIS WARRANTY IS THE EXCLUSIVE REMEDY OF THE CONSUMER. HUSQVARNA SHALL NOT BE LIABLE FOR ANY INCIDENTAL OR CONSEQUENTIAL DAMAGES FOR BREACH OF ANY EXPRESS OR

IMPLIED WARRANTY ON THESE PRODUCTS EXCEPT TO THE EXTENT PROHIBITED BY APPLICABLE LAW. ANY IMPLIED WARRANTY OF MERCHANTABILITY OR FITNESS FOR A PARTICULAR PURPOSE ON THESE PRODUCTS IS LIMITED IN DURATION TO THE WARRANTY PERIOD AS DEFINED IN THE LIMITED WARRANTY STATEMENT. HUSQVARNA RESERVES THE RIGHT TO CHANGE OR IMPROVE THE DESIGN OF THE PRODUCT WITHOUT NOTICE, AND DOES NOT ASSUME OBLIGATION TO UPDATE PREVIOUSLY MANUFACTURED PRODUCTS.

Some states do not allow the exclusion of incidental or consequential damages, or limitations on how long an implied warranty lasts, so the above limitations or exclusions may not apply to you. This warranty gives you specific legal rights, and you may also have other rights which vary from state to state.

## **SECTION 5: CUSTOMER RESPONSIBILITIES**

The product must exhibit reasonable care, maintenance, operation, storage, and general upkeep as written in the maintenance section of the Owner's/Operator's manual. Should an operational problem or failure occur, the product should not be used, but delivered as is to an authorized Husqvarna dealer for evaluation. Proof of purchase, as explained in section 6, rests solely with the customer.

## **SECTION 6: PROCEDURE TO OBTAIN WARRANTY CONSIDERATION**

It is the Owner's and Dealer's responsibility to make certain that the Warranty Registration Card is properly filled out and mailed to Husqvarna Forest & Garden Company. This card should be mailed within ten (10) days from the date of purchase to in order to confirm the warranty and to facilitate post-sale service.

Proof of purchase must be presented to the authorized Husqvarna dealer in order to obtain warranty service. This proof must include date purchased, model number, serial number, and complete name and address of the selling dealer.

To obtain the benefit of this warranty, the product believed to be defective must be delivered to an authorized Husqvarna dealer in a timely manner, no later than thirty (30) days from date of the operational problem or failure. The product must be delivered at the owner's expense. Pick-up and delivery charges are not covered by this warranty. An authorized Husqvarna dealer can be normally located through the "Yellow Pages" of the local telephone directory or by calling 1-800-HUSKY62 for a dealer in your area.



HUSQVARNA FOREST & GARDEN COMPANY  
9006-J PERIMETER WOODS DRIVE  
CHARLOTTE, NC 28216

**FOR CALIFORNIA RESIDENTS ONLY WHEN  
SEEKING SERVICE IN CALIFORNIA**

**CALIFORNIA EMISSION CONTROL  
WARRANTY STATEMENT**

**YOUR WARRANTY RIGHTS AND OBLIGATIONS**

The California Air Resources Board and  Husqvarna Forest & Garden AB are pleased to explain the emissions control system warranty on your 1995 lawn and garden equipment engine. In California, new utility and lawn and garden equipment engines must be designed, built, and equipped to meet the State's stringent anti-smog standards. Husqvarna must warrant the emission control system on your lawn and garden equipment engine for the periods of time listed below provided there has been no abuse, neglect, or improper maintenance of your lawn and garden equipment engine.

Your emission control system includes parts such as the carburetor and the ignition system.

Where a warrantable condition exists, Husqvarna will repair your lawn and garden equipment engine at no cost to you. Expenses covered under warranty include diagnosis, parts, and labor.

**MANUFACTURER'S WARRANTY COVERAGE --**

The 1995 and later utility and lawn and garden equipment engines are warranted for two years. If any emission related part on your engine (as listed above) is defective, the part will be repaired or replaced by Husqvarna.

**OWNER'S WARRANTY RESPONSIBILITIES --**

As the lawn and garden equipment engine owner, you are responsible for the performance of the required maintenance listed in your Owner's Manual. Husqvarna recommends that you retain all receipts covering maintenance on your lawn and garden equipment engine, but Husqvarna cannot deny warranty solely for the lack of receipts or for your failure to ensure the performance of all scheduled maintenance.

As the lawn and garden equipment engine owner, you should be aware that Husqvarna may deny you warranty coverage if your lawn and garden equipment engine or a part of it has failed due to abuse, neglect, improper maintenance, unapproved modifications, or the use of parts not made or approved by the original equipment manufacturer.

You are responsible for presenting your lawn and garden equipment engine to a Husqvarna authorized repair center as soon as a problem exists. Warranty repairs should be completed in a reasonable amount of time, not to exceed 30 days.

If you have any questions regarding your warranty rights and responsibilities, you should contact your nearest authorized service center or call Husqvarna at 1-800-487-5962.

**WARRANTY COMMENCEMENT DATE --**

The warranty period begins on the date the lawn and garden equipment engine is delivered.

**LENGTH OF COVERAGE --**

Husqvarna warrants to the initial owner and each subsequent purchaser that the engine is free from defects in materials and workmanship which cause the failure of a warranted part for a period of two years.

## **WHAT IS COVERED--**

### **REPAIR OR REPLACEMENT OF PARTS--**

Repair or replacement of any warranted part will be performed at no charge to the owner at an approved Husqvarna servicing center.

If you have any questions regarding your warranty rights and responsibilities, you should contact your nearest authorized service center or call Husqvarna at 1-800-487-5962.

### **WARRANTY PERIOD--**

Any warranted part which is not scheduled for replacement as required maintenance, or which is scheduled only for regular inspection to the effect of "repair or replace as necessary" shall be warranted for 2 years. Any warranted part which is scheduled for replacement as required maintenance shall be warranted for the period of time up to the first scheduled replacement point for that part.

### **DIAGNOSIS--**

The owner shall not be charged for diagnostic labor which leads to the determination that a warranted part is defective if the diagnostic work is performed at an approved Husqvarna servicing center.

### **CONSEQUENTIAL DAMAGES--**

Husqvarna may be liable for damages to other engine components caused by the failure of a warranted part still under warranty.

## **WHAT IS NOT COVERED--**

All failures caused by abuse, neglect, or improper maintenance are not covered.

### **ADD-ON OR MODIFIED PARTS--**

The use of add-on or modified parts can be grounds for disallowing a warranty claim. Husqvarna is not liable to cover failures of warranted parts caused by the use of add-on or modified parts.

## **HOW TO FILE A CLAIM--**

If you have any questions regarding your warranty rights and responsibilities, you should contact your nearest authorized service center or call Husqvarna at 1-800-487-5962.

## **WHERE TO GET WARRANTY SERVICE--**

Warranty services or repairs shall be provided at all Husqvarna authorized service centers.

## **MAINTENANCE, REPLACEMENT AND REPAIR OF EMISSION RELATED PARTS--**

Any Husqvarna approved replacement part used in the performance of any warranty maintenance or repair on emission related parts will be provided without charge to the owner if the part is under warranty.

## **EMISSION CONTROL WARRANTY PARTS LIST--**

1. Carburetor
2. Ignition System
  - a. Spark Plug, covered up to maintenance schedule.
  - b. Ignition Module

## **MAINTENANCE STATEMENT--**

The owner is responsible for the performance of all required maintenance as defined in the owners manual.

## Free Manuals Download Website

<http://myh66.com>

<http://usermanuals.us>

<http://www.somanuals.com>

<http://www.4manuals.cc>

<http://www.manual-lib.com>

<http://www.404manual.com>

<http://www.luxmanual.com>

<http://aubethermostatmanual.com>

Golf course search by state

<http://golfingnear.com>

Email search by domain

<http://emailbydomain.com>

Auto manuals search

<http://auto.somanuals.com>

TV manuals search

<http://tv.somanuals.com>