

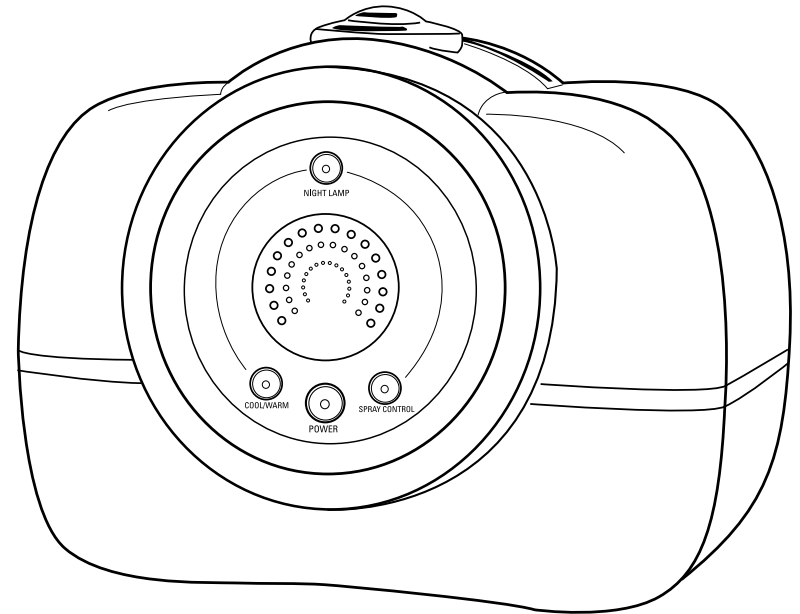

USE & CARE INSTRUCTIONS



pureguardian™ 120-Hour Ultrasonic Digital Humidifier

Model No. H4600

3-Year Limited Warranty

www.guardiantechnologies.com

1.866.603.5900

REV0411

English E - 1

French F - 1

Spanish S - 1

Date Purchased

month _____

year _____

READ AND SAVE THIS MANUAL PRODUCT SPECIFICATIONS AND PARTS

SPECIFICATIONS

Model Number: H4600
 Humidifying Mode: Combination
 Power Supply: 120V 60Hz
 Power Consumption: 140W
 Maximum Humidity Capacity: High Mist - 1.4 gallons/24 hours; Low Mist - 0.5 gallons/24 hours
 Tank Capacity: 2.4 gallons
 Successive Humidity Hours: Up to approximately 120 hours depending on environmental conditions
 Dimensions: Width - 10 inches; Length - 15 inches; Height - 12 inches
 Weight: 8.2 pounds (not including packaging)

PARTS

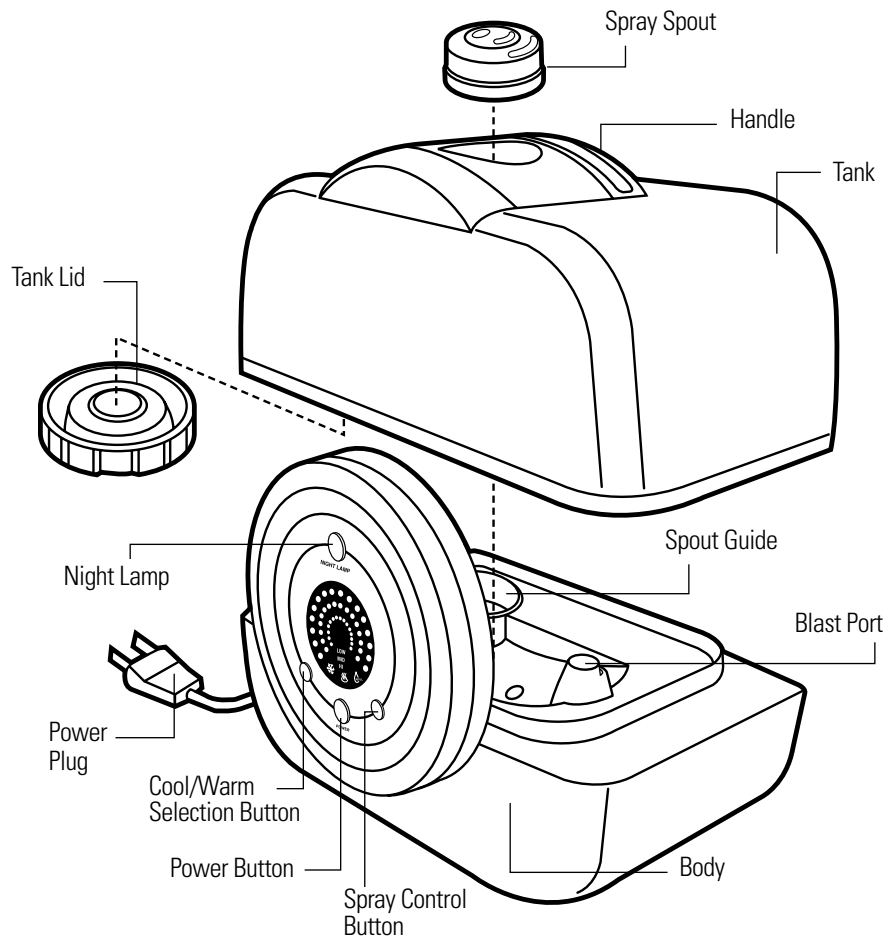

READ AND SAVE THIS MANUAL CONTROL PANEL BUTTON FUNCTIONS

Night Light/Lamp •
 Provides a soft ring of blue light with ON/OFF switch.

Cool/Warm •
 Select humidifying temperature based on need. Warm humidity will use more power, but will humidify room quicker.

Power •
 Turns humidifier ON/OFF.

Spray Control •
 Adjusts spray between low, medium and high.

Level of Spray Indicator Lights •
 As spray is adjusted from low to high, the arches of lights get higher and higher.

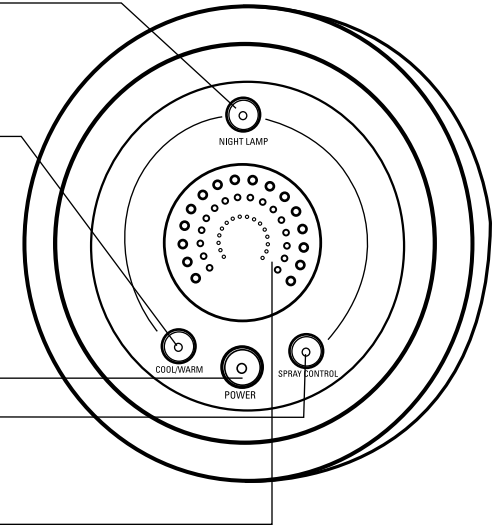

FUNCTIONS AND FEATURES

Warm or Cold Humidification Selection

Select humidifying temperature based on need. Warm humidity will use more power but will humidify your room quicker.

Water Shortage Indicator

When the unit is low on water the Refill LED on the front panel will light up, and the unit will shut off. Simply add more water to continue use. Unit will automatically resume running when water tank has been refilled.

Spray Volume Adjustment

The spray volume or amount of mist that is produced by the unit can be adjusted based on need. It can be changed from low to high by pressing the SPRAY CONTROL button on the front panel.

Silver Clean Technology

Unlike other humidifiers that grow slimy mold and mildew, the pureguardian™ Ultrasonic Humidifier uses Silver Clean™ technology embedded in the tank to fight the growth of mildew and mold on the surface of the water tank.

WARNINGS



This product should be used only in accordance with the specifications outlined in this manual. Usage other than what has been specified here may result in serious injury.

- Disassembly, repair or remodeling by an unauthorized person may result in serious harm.
- Do not use if plug is damaged or loose.
- Keep this product out of the reach of children and pets.
- Be careful not to put water in the humidity spout.
- Before filling or cleaning the unit, make sure it is unplugged.
- Once the humidifier has been turned on, do not move it.
- Do not remove the water tank from the unit while it is on.
- Do not handle the plug with wet hands.
- Do not excessively bend, twist or pull the power cord.
- Avoid placing this product where the humidity spout is pointed directly at an object.
- Do not inhale the mist/vapor expelled from the product.
- Do not place this product on a sloped or unstable surface.
- When not in use, unplug the unit.
- Do not fill the water tank with hot or boiling water.
- Do not use this product in direct sunlight or near a gas stove or heater.
- If the water tank becomes cracked or damaged do not use.
- Do not keep this product running for an extended period of time.
- Do not clean the unit or water tank with detergents or chemicals of any kind.
- Do not use this product near any other electronic device.
- Do not cover the spray spout at any time during use.
- Do not use this product near a sink.
- Do not drink water from tank.
- Do not place this product on an absorbent surface.
- Children cannot recognize the hazards associated with the usage of electrical appliances. For this reason always supervise children when they are near the humidifier.
- If the mist comes in contact with the floor prior to evaporating, the floor surface may be damaged. We do not accept any liability for damage in the case of the unit being placed incorrectly.
- The use of water additives, such as ethereal/essential oils, fragrances, eucalyptus, water conditioners etc. will damage the appliance materials and as a consequence the whole unit. Any use of such additives will void the manufacturer's warranty.
- **IMPORTANT:** Neither humans nor animals can hear the high frequency vibrations.

Failure to comply with the warnings listed above may result in electric shock or serious injury.

DIRECTIONS FOR USE

Make sure the unit is unplugged.

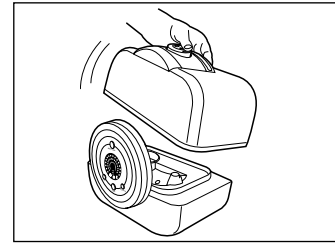

1. Separate the tank from the body of the unit.

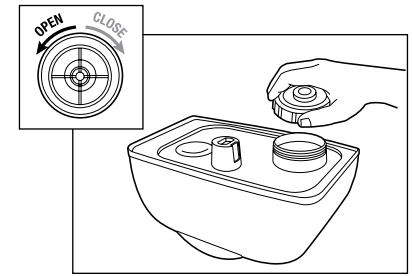

2. Open the tank lid, turning it to the left.

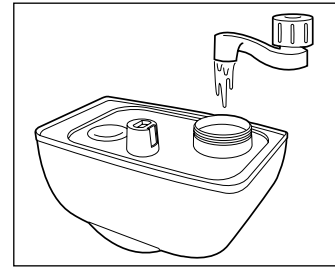

3. Pour cool, clean water directly into the tank.

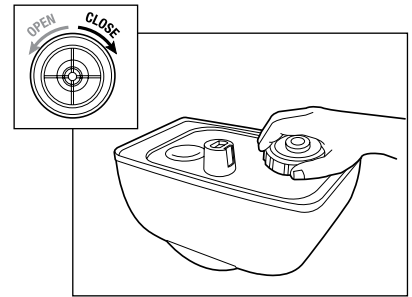

4. Close the tank lid, turning it to the right.

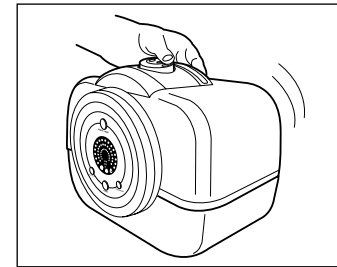

5. Attach the tank to the body of the unit and plug in.

DIRECTIONS FOR USE

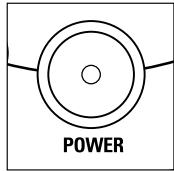

- 6. Power Button**
Before turning on make sure there is water in the unit. Press the POWER button.

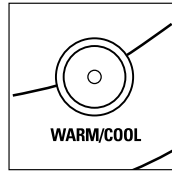

- 7. Cool or Warm Humidification Button**
Press to select cool or warm mist. Water temperature is maintained at room temperature for cool setting and 80 degrees for warm.

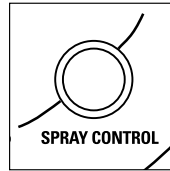

- 8. Spray Control Button**
When you press the Spray Control button there are three options:
Press once for LOW
Press twice for MEDIUM
Press three times for HIGH
*Lights get higher as spray increases.



- 9. Night Light Feature**
Press the Night Lamp button at the top of the unit to illuminate the night light feature.



- 10. Water Refill Button**
When the Water Refill button lights up it is time to refill the water tank.

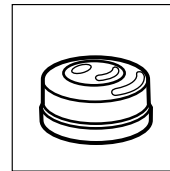

- 11. Humidity Spout Direction**
Broaden mist in two different directions throughout the room.

MAINTENANCE

- Always unplug the unit before servicing it in any way.
- The water temperature of the water remaining in the unit after use may be high.
- Do not submerge the unit in the water, or allow water to enter the inside of the unit.

INSIDE THE BODY OF THE UNIT

Pour excess water out of the unit, but do not allow it to enter the blast port. Wash out the unit with fresh water using the cleaning brush and a soft cloth as needed.

OUTER SURFACE OF THE UNIT

Wipe the surface of the unit with a soft, damp cloth if needed.

WATER TANK

If water spots remain in the water tank, wipe the inside down with a soft cloth. Do NOT use soap or detergents.

ULTRASONIC DISK

Remove the tank (Fig. 1) and use ONLY the enclosed cleaning brush to regularly remove build up and deposits from the disk area (Fig. 2).

**Diluted white vinegar will help to prevent this build up.

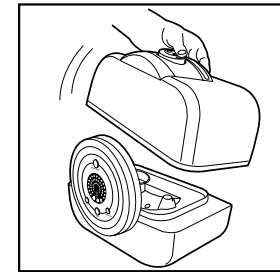

(Fig. 1)

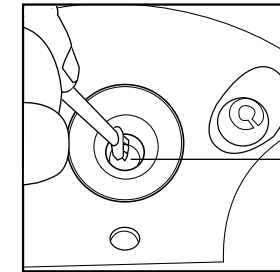

(Fig. 2)

*Clean the disk with the brush only. No other cleaning tool should be used. BRUSH ONLY. (Fig. 2)

• Ultrasonic Disk

STORAGE

- Clean and fully dry the inside and outside of the unit before storing it.
- DO NOT leave water in the unit.
- Store in a cool, dry place.

TROUBLESHOOTING GUIDE

PROBLEM	SOLUTION
Water vapor and humidity are not produced.	Power Plug: Unplug and then try again. Power Failure: When the power is returned, try again. Tank Installation: Make sure the tank is correctly attached.
Air blows but water vapor is not produced.	Excessive Water: Remove a certain amount of water from the tank. The desired humidity is lower than the current temperature: Increase the desired humidity. Detergent residue in tank: Wash the tank out and try again.
Humidity level is low.	The surface of the ultrasonic disk is dirty: Clean the disk. (Page E-7) The water in the unit is too cold: Replace with cool, but not cold water. Damage on the ultrasonic disk: Exchange the disk.
Warm humidity is not produced.	It may take 10-15 minutes before warm humidity is created.
The humidity has a bad smell.	Poor maintenance or dirty water: Clean the product thoroughly, and fill it with fresh water. (Page E-7)
White dust is forming on nearby furniture.	Hard water may deposit a certain amount of dust. Dust in the air also settles because of added humidity in the room. Use distilled water if this becomes a nuisance. * Decalcification Filter (FLTDC) available at www.guardiantechnologies.com or through Customer Service 1.866.603.5900.

LIMITED WARRANTY

To the consumer, Guardian Technologies LLC warrants this product to be free of defects in materials or workmanship commencing upon the date of the original purchase. Save your original sales receipt to validate start of warranty period.

If this product should become defective within the warranty period, we will repair or replace any defective parts free of charge. The complete machine must be delivered pre-paid to any authorized Guardian Technologies LLC warranty service center. Please include complete information on the problem, day of purchase, copy of original sales receipt and your name, address and telephone number. If you are not near a warranty station, call the factory for assistance in the US and Canada at 1.866.603.5900. Use only genuine Guardian Technologies replacement parts.

The warranty does not include unusual wear, damage resulting from accident, or unreasonable use of the product. This warranty does not cover unauthorized repairs. This warranty gives you specific legal rights and you may also have other rights (other rights may vary from state to state in the U.S.A.).

We consider the registration process important to ensuring superior service to our customers, however submitting this card to Guardian Technologies LLC is optional and does not affect your rights to utilize this warranty according to the conditions stated above. If you have any questions or comments about our product call toll free at: **1.866.603.5900**, or send comments to:

**ATTN: Customer Service
Guardian Technologies LLC
7700 St. Clair Avenue
Mentor, Ohio 44060**

Product warranty can also be registered online at www.guardiantechnologies.com.



This product has been tested and complies with the requirements for Federal Communications Commission, Part 18 for Radio/TV/ Communication interference. Although tested, it may affect these devices. If the humidifier is found to interfere, separate the device and/or the humidifier. Conduct only the user maintenance found in this manual. Other maintenance and servicing can cause harmful interference and can void the required FCC compliance.

Guardian Technologies LLC
7700 St Clair Avenue | Mentor, Ohio 44060
1.866.603.5900 | www.guardiantechnologies.com

Free Manuals Download Website

<http://myh66.com>

<http://usermanuals.us>

<http://www.somanuals.com>

<http://www.4manuals.cc>

<http://www.manual-lib.com>

<http://www.404manual.com>

<http://www.luxmanual.com>

<http://aubethermostatmanual.com>

Golf course search by state

<http://golfingnear.com>

Email search by domain

<http://emailbydomain.com>

Auto manuals search

<http://auto.somanuals.com>

TV manuals search

<http://tv.somanuals.com>