

# iHome®

Model iP51  
**The Home System  
For Your iPhone/iPod®**

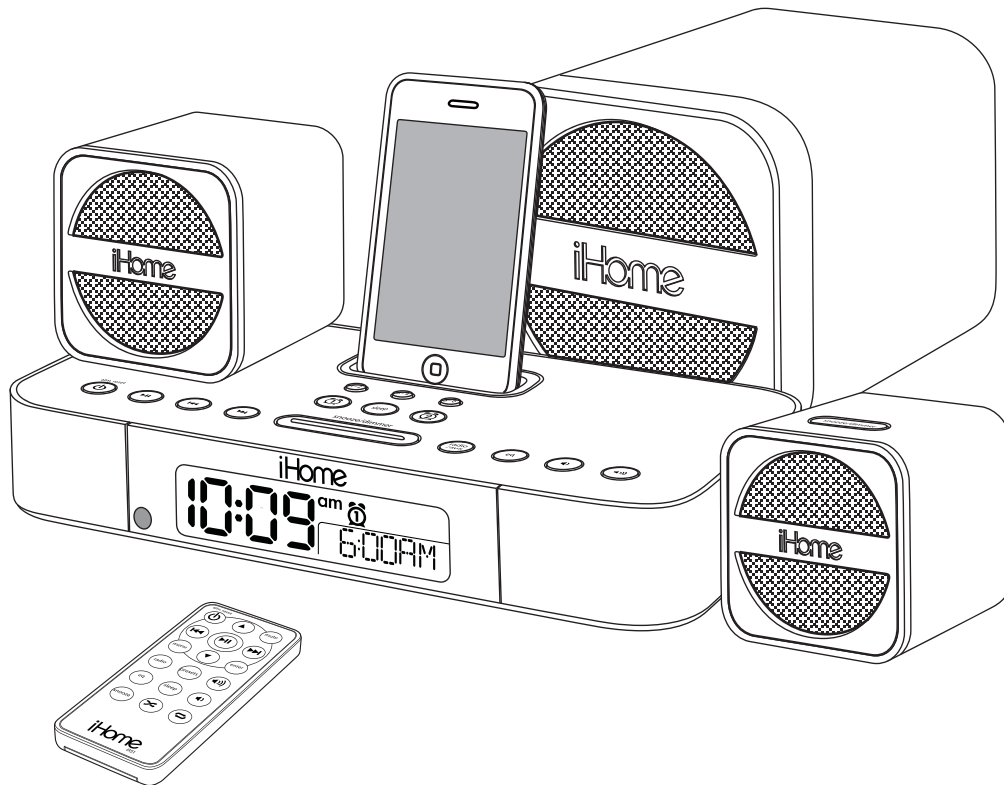

**Questions? Visit [www.ihomeaudio.com](http://www.ihomeaudio.com)**

Download from [www.Somanuals.com](http://www.Somanuals.com). All Manuals Search And Download.

# Table of Contents

<b>Caution Information</b> .....	1
<b>A Consumer Guide to product Safety</b> .....	2-3
Safety Instructions	
FCC Information	
Batteries information	
<b>Quick Start</b> .....	4-5
<b>Controls and Indicators</b> .....	6
<b>Using the iP51</b> .....	7-9
<b>Replacing iP51 Backup Batteries</b> .....	9
Install/Replace Backup Battery	
<b>Using The Remote Control Unit</b> .....	10
<b>Troubleshooting</b> .....	11-12
<b>Warranty Information</b> .....	13

## Maintenance

- Place the unit on a level surface away from sources of direct sunlight or excessive heat.
- Protect your furniture when placing your unit on a natural wood and lacquered finish. A cloth or other protective material should be placed between it and the furniture.
- Clean your unit with a soft cloth moistened only with mild soap and water. Stronger cleaning agents, such as Benzine, thinner or similar materials can damage the surface of the unit.



## CAUTION

**RISK OF ELECTRIC SHOCK  
DO NOT OPEN**



**CAUTION:** TO REDUCE THE RISK OF ELECTRIC SHOCK, DO NOT REMOVE COVER (OR BACK). NO USER-SERVICEABLE PARTS INSIDE. REFER SERVICING TO QUALIFIED SERVICE PERSONNEL.

**WARNING:** TO REDUCE THE RISK OF FIRE OR ELECTRIC SHOCK, DO NOT EXPOSE THIS APPLIANCE TO RAIN OR MOISTURE.



The lightning flash with arrowhead symbol, within an equilateral triangle, is intended to alert the user of the presence of uninsulated “dangerous voltage” within the product’s enclosure that may be of sufficient magnitude to constitute a risk electric shock to persons.



The exclamation point within an equilateral triangle is intended to alert the user of the presence of important operating and maintenance (servicing) instructions in the literature accompanying the appliance.

Caution Marking and rating plate was located at bottom enclosure of subwoofer.

**WARNING:** DANGER OF EXPLOSION IF BATTERY IS INCORRECTLY REPLACED.  
REPLACE ONLY WITH THE SAME OR EQUIVALENT TYPE.

**AVERTISSEMENT:** DANGER D’EXPLOSION LORSQUE LA BATTERIE N’EST PAS  
REPLACÉE CORRECTEMENT.  
REPLACER UNIQUEMENT AVEC DES BATTERIES IDENTIQUES OU D’UN TYPE ÉQUIVALENT.

**CAUTION:** To prevent electric shock, match wide blade of plug to wide slot. Fully insert.

**CAUTION:** To reduce the risk of fire, do not place any heating or cooking product beneath this unit

# IMPORTANT SAFETY INSTRUCTIONS



1. Read these Instructions.
2. Keep these Instructions.
3. Heed all Warnings.
4. Follow all instructions.
5. Do not use this apparatus near water.
6. Clean only with a dry cloth.
7. Do not block any ventilation openings. Install in accordance with the manufacturer's instructions.
8. Do not install near any heat sources such as radiators, heat registers, stoves, or other apparatus (including amplifiers) that produce heat.
9. Do not defeat the safety purpose of the polarized or grounding - type plug. A polarized plug has two blades with one wider than the other. A grounding type plug has two blades and a third grounding prong. The wide blade or the third prong are provided for your safety. When the provided plug does not fit into your outlet, consult an electrician for replacement of the obsolete outlet.
10. Protect the power cord from being walked on or pinched particularly at plugs, convenience receptacles, and the point where they exit from the apparatus.
11. Only use attachments/accessories specified by the manufacturer.
12. Use only with a cart, stand, tripod, bracket, or table specified by the manufacturer, or sold with the apparatus. When a cart is used, use caution when moving the cart/apparatus combination to avoid injury from tip-over.
13. Unplug this apparatus during lightning storms or when unused for long periods of time.
14. Refer all servicing to qualified service personnel. Servicing is required when the apparatus has been damaged in any way, such as power-supply cord or plug is damaged, liquid has been spilled or objects have fallen into the apparatus, the apparatus has been exposed to rain or moisture , does not operate normally, or has been dropped.
15. The apparatus shall not be exposed to dripping or splashing and that no objects filled with liquids, such as vases, shall be placed on apparatus.
16. Main plug is used as disconnect device and it should remain readily operable during intended use. In order to disconnect the apparatus from the mains completely, the mains plug should be disconnected from the mains socket outlet completely.
17. Battery shall not be exposed to excessive heat such as sunshine and fire.
18. Excessive sound pressure from earphones and headphone can cause hearing loss.
19. The marking plate was located at bottom enclosure of the main unit

## CAUTION

Danger of explosion if battery is incorrectly replaced. Replace only with the same or equivalent type.

## FCC Information

This device complies with part 15 of the FCC Rules. Operation is subject to the condition that this device does not cause harmful interference.

This equipment complies with the limits for a Class B digital device as specified in Part 15 of FCC Rules. These limits provide reasonable protection against radio and TV interference in a residential area.

However, your equipment might cause TV or radio interference even when it is operating properly. To eliminate interference you can try one or more of the following corrective measures:

- Reorient or relocate the receiving antenna.
- Increase the distance between the equipment and the radio or TV.
- Use outlets on different electrical circuits for the equipment and the radio or TV.

Consult your dealer or an experienced radio/television technician if the problem still exists.

Modifying or tampering with your system's internal components can cause a malfunction and might invalidate the system's warranty and void your FCC authorization to operate it.

This Class B digital apparatus complies with Canadian ICES-003.

Cet appareil digital de classe B est compatible avec l'ICES-003 canadien.

## BATTERY INFORMATION

### For Models Requiring Lithium Battery

Warning :

- Lithium batteries can explode or cause burns if disassembled, shorted, recharged, exposed to water, fire, or high temperatures & not handled appropriately.
- Do not place loose batteries in a pocket, purse, or other container containing metal objects, mix with used or other battery types, or store with hazardous or combustible materials.
- Store in cool, dry, ventilated area.
- Follow applicable laws and regulations for transport and disposal.

### For Models Requiring More Than One Battery

- Do not mix with used or other battery types/brands
- Do not heat above 75C (167F)
- Replace all cells at the same time
- Do not expose contents to water
- Do not open batteries
- Do not charge or recharge
- Do not dispose of in fire
- Do not install backwards

**Questions? Visit [www.ihomeaudio.com](http://www.ihomeaudio.com)  
For any other questions: 1-877-446-6301 Toll Free**

# Quick start:

## 1: subwoofer

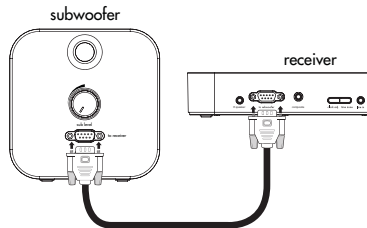

Connect the provided connector cable from the back of the subwoofer to the back of the receiver and tighten screws.

## 2: speakers

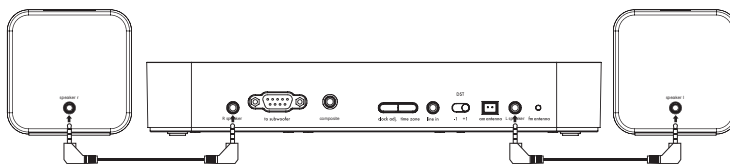

Attach a speaker cable from the right speaker (R speaker) and left speaker (L speaker) jacks on the back of the receiver to the jack on the back of each matching speaker.

## 3: antenna

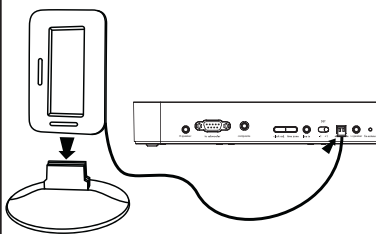

Snap the AM antenna into the provided stand, then plug the antenna cable into the socket on the back of the iP51. Move the antenna 12" away.

## 4: power

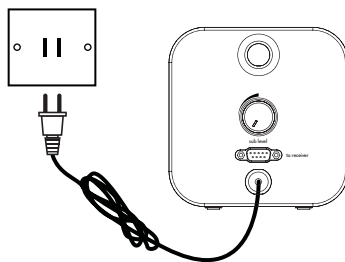

Plug the AC cable on the back of the iP51 subwoofer into a working wall socket

## 5: backup batteries

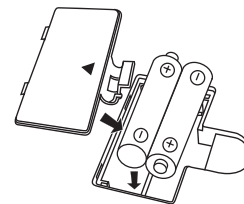

Remove the battery compartment door on the bottom of the receiver and insert 2 AA batteries (match + and - polarity to diagram in compartment). Replace door.

# Quick start:

## 6:inserts

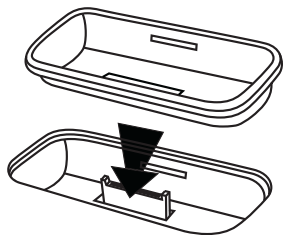

Select the insert that matches your iPhone/iPod (see table below) and place in the universal dock.

## 7:iPhone/iPod

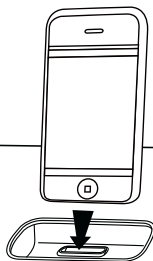

Insert iPhone/iPod into the dock (iPhone/iPod must not be in a skin or case). The iPhone/iPod will charge while docked. To play, press the Play Button on the iPod to select iPhone/iPod mode and play the iPhone/iPod.

## 8:radio

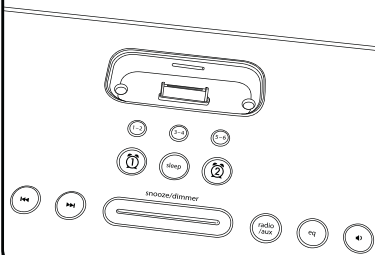

Press the Radio/Aux button as needed to select AM/FM band. Press the Forward or Reverse Button to tune in a station. See page 5 for programming presets.

## 9:time



- Move the DST switch on back of unit to +1 or -1 (adds or subtracts an hour)
- Press & hold the Time Zone button on back until the display flashes
- Press the 9 or : Button to select your time zone
- Press the Time Zone button again.

Table 1: Selecting an Insert

Use this insert	iPhone 3G Insert 15	iPod touch 2G insert 16	iPod nano 4G insert 17
For this iPhone/iPod	iPhone 3G	iPod Touch 2G	iPod nano 4G

**NOTE:** If you do not have an insert for your iPhone/iPod, please visit [www.ihomeaudio.com](http://www.ihomeaudio.com) or call iHome toll free at 877-446-6301 to purchase one.

# Controls and Indicators

## RECEIVER (top panel)

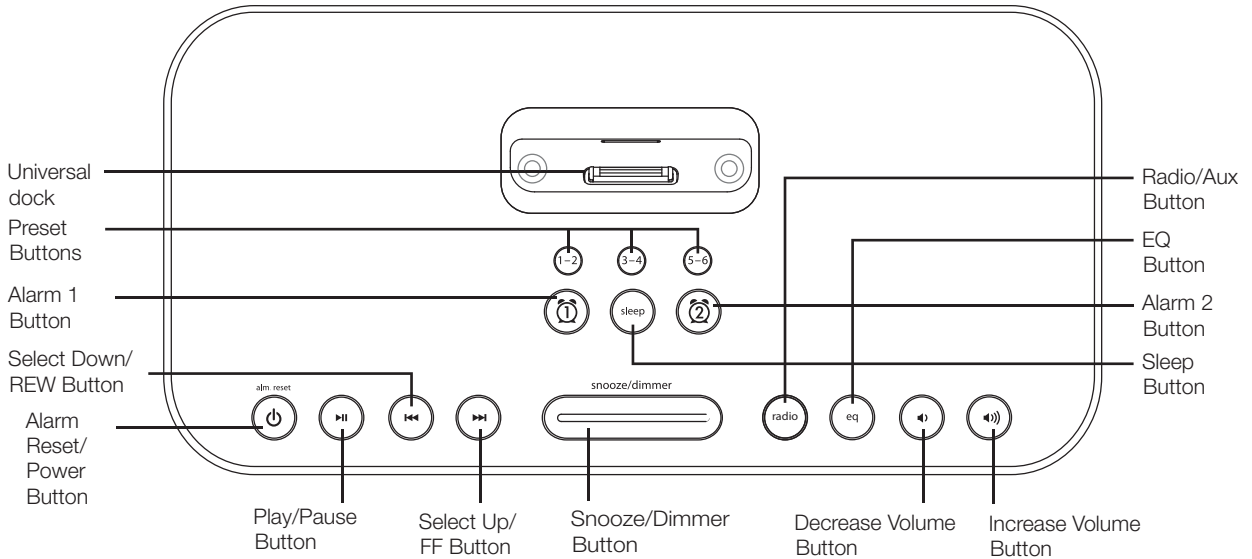

## RECEIVER (rear panel)

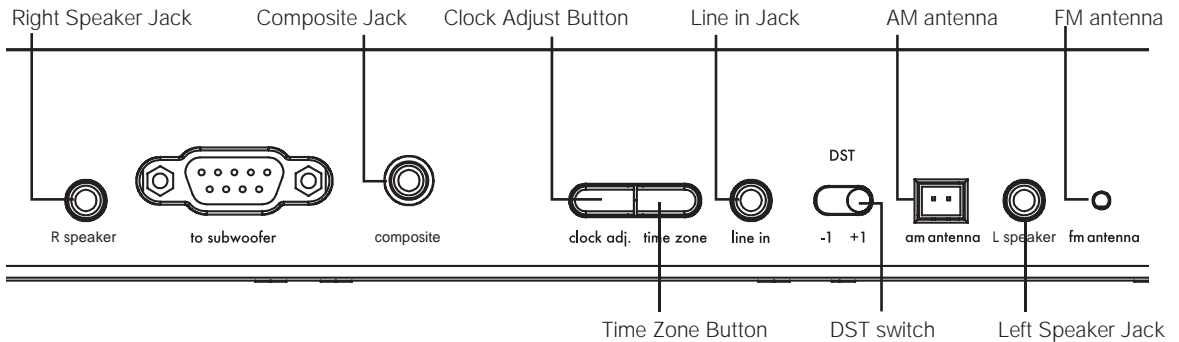



## Connections

### Connecting the Subwoofer to the Receiver

1. The iP51 comes with a connector cable to connect the Subwoofer to the Receiver. DO NOT USE THIS CABLE TO CONNECT ANY OTHER DEVICE, SUCH AS A COMPUTER. DOING SO WILL DAMAGE YOUR UNIT.
2. Attach one end of the cable to the Subwoofer and tighten the screws until firmly attached.
3. Attach the other end of the cable to the Receiver and tighten screws until firmly attached.

### Connecting the Stereo Speakers to the Receiver

1. The iP51 comes with two sets of audio cables (short and long) so you can set up the speakers to match your setting and preferences.
2. Plug one end of an audio cable into the jack on the back of the Speaker and the other end into the matching speaker jack on the back of the Receiver. **NOTE:** The Right Speaker has a Snooze/Dimmer switch and must be connected to the matching right speaker jack to operate snooze/dimmer functions from the speaker.

### Connecting and setting up the antennas

1. Snap the AM antenna into the provided stand, then plug antenna cable into AM antenna plug on rear of receiver. Antenna should be kept 12 inches from unit.
2. Extend FM antenna and locate for best reception. Do not alter antenna wire.

### Connecting iP51 to Power Source

1. Once you've made all your connections, plug the power cable from the Subwoofer into a standard 120v wall socket. Unit must be plugged in for the receiver to charge iPhone/iPod.

## Setting the Time Zone

The iP51 clock is preset to U.S. Eastern Standard Time. It is simple to adjust the unit for your location.

1. Depending on your location and whether or not Daylight Saving Time (DST) is in effect, set the DST Switch located on the back of the unit to +1 to add one hour or to -1 to subtract one hour.
2. Press and hold the Time Zone Button located on the back of the unit until Time Zone Indicator at the lower part of the display flashes. Press the ◀ or ▶ Button to select your time zone.
3. Press the Time Zone Button again. You will hear two beeps confirming your setting and exit the Time Zone Setting mode.
4. If the time displayed is not correct, please see Setting Clock and Calendar below to set the clock.

## Setting the Clock & Calendar

1. Press and hold the Clock Adj Button located on the back of the unit until the time display flashes. Press the ◀ or ▶ Button to adjust the time (hold for a few seconds to advance or reverse rapidly). Remember to set the correct AM or PM hour. An icon to the right of the time display indicates AM or PM.
2. Press the Clock Adj Button again. The year will flash in the lower part of the display. Press the ◀ or ▶ Button until the current year is displayed.
3. Press the Clock Adj Button again. The date will flash. Press the ◀ or ▶ Button until the current date is displayed.
4. Press the Clock Adj Button once more. Two beeps will sound to confirm your settings and you will exit Clock and Calendar Setting mode.

## Using your iPhone/iPod

Playing and charging your iPhone/iPod

- Insert the proper insert for your iPhone/iPod (see table on page 5), then gently dock iPhone/iPod in the dock. When docked, your iPhone/iPod will charge until fully charged while the iP51 is connected to an AC outlet. This unit will not overcharge the iPhone/iPod. If you dock an iPhone/iPod while the iPhone/iPod is in play mode, the iP51 will automatically switch to iPhone/iPod mode and play your music.
- If iPhone/iPod is not playing when docked, press the **▶|| Button** to play the iPhone/iPod, and again to pause.
- Press the **◀** or **▶** buttons to adjust iP51 volume up or down. Use the Sub Level Knob on the subwoofer to adjust bass volume level.
- Press the EQ button to cycle through the EQ (tone) settings: treble, bass, 3D sound effect, and balance. Press the **◀◀** or **▶▶** Button to adjust the EQ settings.
- Press the **⏻** Button to turn the iP51 and iPhone/iPod off.

## Using the AM/FM Radio

- Make sure the AM antenna is properly attached and both AM and FM antennas are extended/located for best reception.
- Press the **Radio/Aux button**. By default, the FM band is selected, but the unit will revert to the last band in use (AM or FM). Press the **Radio/Aux button** to toggle between FM and AM bands.
- To tune a station**, press the **◀◀** or **▶▶** Button until the desired frequency appears (hold either button for faster selection; the unit will scan to the next station with clear reception).
- To save a station as a preset**, tune in the desired station then hold the desired preset button for about two seconds until you hear a confirmation beep. You can save up to 12 presets (6 AM and 6 FM). To change a preset, follow the same steps for saving a preset.
- To listen to a preset station in radio mode**, press the **Radio/Aux button** to select the desired radio band (AM or FM), then press the desired preset button. The unit will tune to the preset station assigned in the selected band.



## Using the Line-in Jack

- Use an audio patch cord (**available at [www.ihomeaudio.com](http://www.ihomeaudio.com)**) to play nondocking iPhone/iPod models or other audio devices through the iP51 Line-in Jack (one end in the device's line out or headphones jack, the other in the iP51 line in jack). Press the **Radio/Aux Button** until LINE IN appears in the display. You can now play your device.

## Using the Dimmer

- During normal operation, press the **Dimmer Button** to cycle through brightness display settings to the one you prefer.

## Using the Composite Jack

To output iPhone/iPod video signal from the iP51 to your TV, connect it to your TV system with a composite video cable (not included). Plug one end into your TV video/audio-in jack(s) and the other end to the composite video out jack located on the back of the iP51. Turn on your TV and select the input for the AV-in jack signal. Playing video from your iPhone or iPod will output the video signal to your TV.

### Setting the Alarms

1. Press and hold the Ⓜ or Ⓜ Button until the alarm time display flashes. Press the ⏪ or ⏩ Button to set the alarm time (hold for a few seconds to advance or reverse rapidly). Remember to set the correct AM or PM wake time.
2. Press the Ⓜ or Ⓜ Button again. The currently selected alarm frequency will flash. Press the ⏪ or ⏩ Button to select to wake to the alarm for 7 days (everyday), 5 days (week days) or 2 days (weekends). Make sure the calendar is properly set for accurate wake frequency.
3. Press the Ⓜ or Ⓜ Button again. The current wake source display will flash. Press the ⏪ or ⏩ Button to select iPhone/iPod, Playlist, Radio or Buzzer to wake to.
4. Press the Ⓜ or Ⓜ Button again or wait for 10 seconds. The alarm is now armed, indicated by the numbered alarm clock icon.

**NOTE:** To wake to playlist mode, first create a playlist named 'ihome' on your iPhone/iPod.

### Arming and Disarming Alarms (Turn Alarm Function On and Off)

1. Alarms are automatically armed when set, indicated by the alarm icon. Press the Ⓜ or Ⓜ Button to arm or disarm the alarms.

### Resetting the Alarm to Come on the Next Day

1. When the alarm is sounding, press the ⏸ Button to stop the alarm and reset it to come on the following day at the same time.

### Snooze

1. Press and hold Snooze Button to adjust snooze timer from 1 to 30 minutes.
2. Press the Snooze Button after the alarm sounds. The alarm will be silenced and come on again 9 minutes later. Snooze can be pressed several times during the 1 hour alarm cycle.

### Sure Alarm

The iP51 has a sure alarm feature. If backup batteries are installed, the buzzer alarm will sound in the event of a power failure. If your iPhone/iPod has no sound for 20 seconds or is not present, the iP51 will switch to buzzer alarm automatically.

## Replacing iP51 Backup Batteries

### Install/Replace Backup Battery

The iP51 uses a backup battery system to provide continuous clock settings in the event of a power failure. If the Battery Low Icon located on the right of the display is flashing, it is time to replace the backup batteries. Please make sure the AC adaptor is connected, otherwise all settings may be lost during battery replacement.

- Open the battery compartment cover located on the bottom of the main receiver unit. Insert 2 "AA" batteries as indicated. We recommend the use of alkaline batteries for longer life.
- Please make sure the AC cord is connected; otherwise all settings may be lost during battery replacement.

### Batteries information:

- Do not mix old and new batteries.
- Do not mix alkaline, standard (carbon -zinc) or rechargeable (nickel-cadmium) batteries.

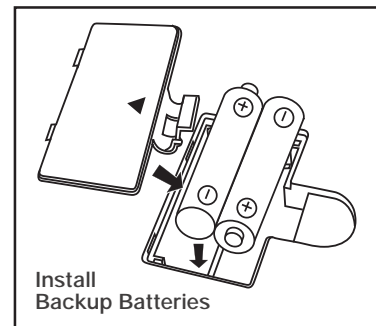

# Using The Remote Control Unit

## OPERATING THE REMOTE CONTROL

The Remote Control controls basic functions on the iP51 and certain iPhone/iPod functions when the iPhone/iPod is docked in the iP51. For best results, aim remote control towards the receiver.

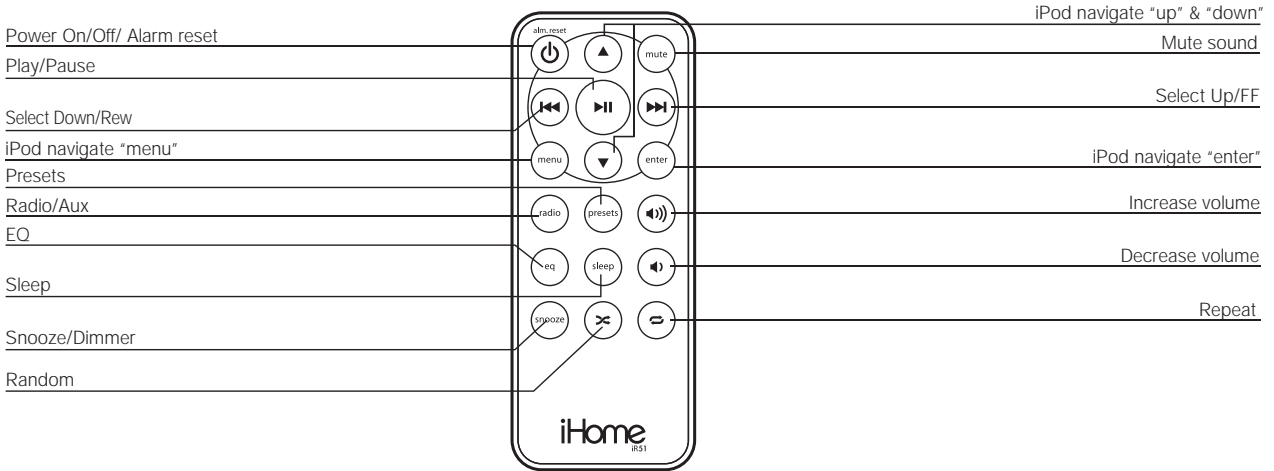

## Install/Replace the Remote Control Battery

The remote control battery is already installed at the factory. When the remote control stops operating or its range seems reduced, replace the battery with a new one.

1. The battery door is located on the back end of the unit.
2. Press to release the battery door latch.
3. Insert 1 "CR2032" 3-volt lithium battery. Make sure the polarity (the + and - side of the battery) is correct.
4. Replace the battery door back in the remote control.

### NOTE: PLEASE DISCARD BATTERIES PROPERLY

#### Warning :

- Lithium batteries can explode or cause burns if disassembled, shorted, recharged, exposed to water, fire, or high temperatures & not handled appropriately.
- Do not place loose batteries in a pocket, purse, or other container containing metal objects, mix with used or other battery types, or store with hazardous or combustible materials.
- Store in cool, dry, ventilated area.
- Follow applicable laws and regulations for transport and disposal.

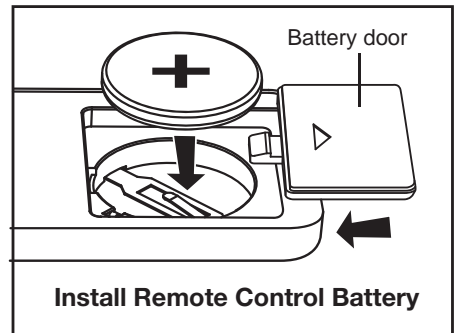

## Troubleshooting

Symptom	Possible Problem	Solution
Unit doesn't respond (no power)	Subwoofer power cord isn't plugged into a wall outlet	Plug the AC cord into a wall outlet
	Wall outlet is not functioning	Plug another device into the same outlet to confirm the outlet is working. Test any switches that may control the outlet
	Subwoofer is not connected to receiver	Make sure connector cable from subwoofer to receiver is connected properly
iPhone/iPod does not dock properly	Using no or wrong iPhone/iPod insert	Make sure the dock insert is the proper fit for your iPhone/iPod
	iPhone/iPod not installed properly	Remove your iPhone/iPod from the dock and check for obstruction on the connectors in the dock and on your iPhone/iPod. Then reseat it in the dock.
Battery Low icon always flashing	Batteries are weak	Replace with new batteries
	Batteries were not installed properly	Check to make sure the polarity ( + and – ends) matches the diagram in the battery compartment
iPhone/iPod does not respond to the unit	iPhone/iPod is not docked properly	Remove your iPhone/iPod from the dock and check for obstruction on the connectors in the dock and on your iPhone/iPod. Then reseat it in the dock.
	Your iPhone/iPod software is outdated	Upgrade software on your iPhone/iPod via iTunes. Visit <a href="http://Apple.com">Apple.com</a> for details.
	iPhone/iPod is locked up	Please make sure your iPhone/iPod is working properly before docking into the unit. Please refer to your iPhone/iPod manual for details.
	Using 1 <sup>st</sup> or 2 <sup>nd</sup> generation iPhone/iPod or other devices.	iP51 cannot control those iPhone/iPod or other devices.
iPhone/iPod does not come on immediately	If your iPhone/iPod is not used for some time, it may enter deep sleep mode	Wake up iPhone/iPod (see your iPhone/iPod manual for details)

## Troubleshooting

Symptom	Possible Problem	Solution
iPhone/iPod didn't charge up	iPhone/iPod is not docked properly	Remove your iPhone/iPod from the dock and check for obstruction on the connectors in the dock and on your iPhone/iPod. Then reset it in the dock.
	iPhone/iPod is locked up/ frozen	Please make sure your iPhone/iPod is working properly before docking into the unit. Please refer to your iPhone/iPod manual for details.
	iPhone/iPod battery has problem	
Sound is distorted	Volume level is set too high	Decrease the volume on both subwoofer and receiver
	Sound source is distorted	If the iPhone/iPod original sound source (MP3) is of poor quality, distortion and noise are easily noticed with high-power speakers. Try a different audio source such as a music CD.
		If you are using an external sound source like older generation of iPhone/iPod or other audio device, try reducing the output volume on the device itself.
		Try adjusting EQ settings on your iPhone/iPod/iP51/sound source.
Remote Control didn't work	Remote Control is out of range	Move closer to unit
	Remote control battery is dead/weak	Replace current battery with new battery

# Limited 1 Year Warranty Information

---

iHome Products, a division of SDI Technologies Inc. (hereafter referred to as SDI Technologies), warrants this product to be free from defects in workmanship and materials, under normal use and conditions, for a period of one year from the date of original purchase.

Should this product fail to function in a satisfactory manner, it is best to first return it to the store where it was originally purchased. Should this fail to resolve the matter and service still be required by reason of any defect or malfunction during the warranty period, SDI Technologies will repair or, at its discretion, replace this product without charge (except for a \$20.00 charge for handling, packing, return UPS/postage, and insurance). This decision is subject to verification of the defect or malfunction upon delivery of this product to the Factory Service Center listed below. The product must include proof of purchase, including date of purchase. The fee for service without proof of purchase is \$50.00.

Before returning this product for service, please first replace the batteries (if applicable) with fresh ones, as exhausted or defective batteries are the most common cause of problems encountered.

If service is still required:

1. Remove the batteries (if applicable) and pack the unit in a well padded, heavy corrugated box.
2. Enclose a photocopy of your sales receipt, credit card statement, or other proof of the date of purchase, if within the warranty period.
3. Enclose a check or money order payable to the order of SDI Technologies, for the sum of \$20.00 (\$50.00 without proof of purchase).
4. Send the unit prepaid and insured, to the Factory Service Center listed below.

Consumer Repair Department  
SDI Technologies Inc.  
1330 Goodyear Drive  
El Paso, TX 79936-6420

## Disclaimer of Warranty

NOTE: This warranty is valid only if the product is used for the purpose for which it was designed. It does not cover (i) products which have been damaged by negligence or willful actions, misuse or accident, or which have been modified or repaired by unauthorized persons; (ii) cracked or broken cabinets, or units damaged by excessive heat; (iii) damage to digital media players, CD's or tape cassettes (if applicable); (iv) the cost of shipping this product to the Factory Service Center and its return to the owner.

This warranty is valid only in the United States of America and does not extend to owners of the product other than to the original purchaser. In no event will SDI Technologies or any of its affiliates, contractors, resellers, their officers, directors, shareholders, members or agents be liable to you or any third party for any consequential or incidental damages, any lost profits, actual, exemplary or punitive damages. (Some states do not allow limitations on implied warranties or exclusion of consequential damages, so these restrictions may not apply to you.) This warranty gives you specific legal rights, and you may also have other rights which vary from state to state.

Your acknowledgment and agreement to fully and completely abide by the above mentioned disclaimer of warranty is contractually binding to you upon your transfer of currency (money order, cashier's check, or credit card) for purchase of your SDI Technologies product.

© 2009 SDI Technologies, Inc. All rights reserved

**Questions? Visit [www.ihomeaudio.com](http://www.ihomeaudio.com)  
For any other questions: 1-877-446-6301 Toll Free**

## Free Manuals Download Website

<http://myh66.com>

<http://usermanuals.us>

<http://www.somanuals.com>

<http://www.4manuals.cc>

<http://www.manual-lib.com>

<http://www.404manual.com>

<http://www.luxmanual.com>

<http://aubethermostatmanual.com>

Golf course search by state

<http://golfingnear.com>

Email search by domain

<http://emailbydomain.com>

Auto manuals search

<http://auto.somanuals.com>

TV manuals search

<http://tv.somanuals.com>