

iHome™

Model iH82
**The Portable System
For Your iPod®**

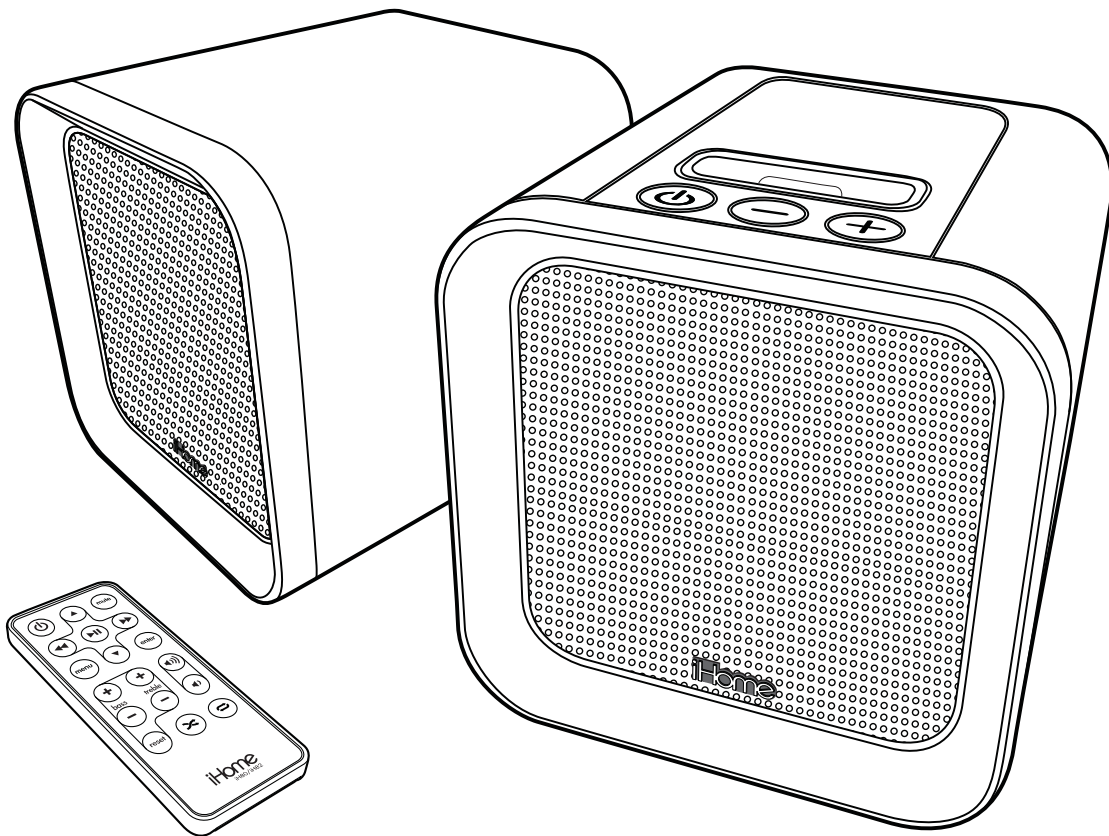

Questions? Visit www.ihomeaudio.com

Download from www.Somanuals.com. All Manuals Search And Download.

Table of Contents

Caution Information	1
Quick Start	2
Controls and Indicators	3
Replacing iH82 Batteries	4-5
Install/Replace Battery	
Using the iH82	5-7
Troubleshooting	8-9
Solucionando problemas	10-11
A Consumer Guide to product Safety	13
Safety Instructions	
Warranty Information	14

Package Contents

Congratulations on your iH82 home sound system for the iPod. Before you set up your unit, please check to see that the package contains the following items:

- 1 Main Unit
- 1 Extension Speaker
- 1 Speaker Cable
- 1 AC Adaptor
- 1 remote control with 1 CR2032 battery
- 3 iPod inserts
- 1 audio patch cord



CAUTION
RISK OF ELECTRIC SHOCK
DO NOT OPEN



CAUTION: TO REDUCE THE RISK OF ELECTRIC SHOCK, DO NOT REMOVE COVER (OR BACK). NO USER-SERVICEABLE PARTS INSIDE. REFER SERVICING TO QUALIFIED SERVICE PERSONNEL.

WARNING: TO REDUCE THE RISK OF FIRE OR ELECTRIC SHOCK, DO NOT EXPOSE THIS APPLIANCE TO RAIN OR MOISTURE.



The lightning flash with arrowhead symbol, within an equilateral triangle, is intended to alert the user of the presence of uninsulated “dangerous voltage” within the product’s enclosure that may be of sufficient magnitude to constitute a risk electric shock to persons.



The exclamation point within an equilateral triangle is intended to alert the user of the presence of important operating and maintenance (servicing) instructions in the literature accompanying the appliance.

The symbols above are located on the bottom of the unit.

WARNING: DANGER OF EXPLOSION IF BATTERY IS INCORRECTLY REPLACED.
REPLACE ONLY WITH THE SAME OR EQUIVALENT TYPE.

AVERTISSEMENT: DANGER D’EXPLOSION LORSQUE LA BATTERIE N’EST PAS
REPLACÉE CORRECTEMENT.
REEMPLACER UNIQUEMENT AVEC DES BATTERIES IDENTIQUES OU D’UN TYPE ÉQUIVALENT.

CAUTION: To prevent electric shock, match wide blade of plug to wide slot. Fully insert.

CAUTION: To reduce the risk of fire, do not place any heating or cooking product beneath this unit

iH82 quick start

1: power: AC or batteries

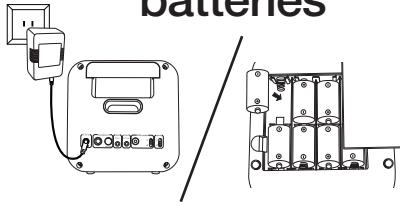

To charge and play iPod, attach AC adaptor plug to jack on back of the main unit and plug the other end into a working AC outlet. For portable play, open battery door located on the bottom of the iH82. Install 8 "C" batteries (match + and - polarity in diagram).

2: Extension Speaker

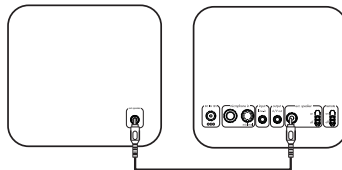

Connect the main unit & external speaker using included speaker cable. Move Extension Speaker switch on back of main unit to ON

3: inserts

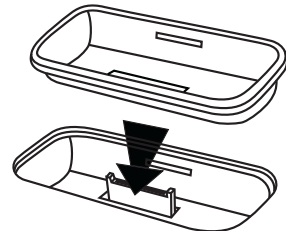

Select the dock insert for your iPod® model from the table below and place insert in dock.
Never dock an iPod without a correct insert in place.

4: iPod



Insert iPod into dock (iPod must not be in a "skin" or case). Press the Power On/Off (play) Button on the main unit to play your iPod.

Table 1: Selecting an Insert

ALWAYS USE CORRECT INSERT TO DOCK YOUR iPod

iPod nano Insert 8	iPod with video (30 GB) Insert 9	iPod with video (60,80 GB) Insert 10
iPod 1G and 2G nano	thin (30 GB) iPod with video	thick (60,80 GB) iPod with video

THIS UNIT DOES NOT CHARGE OR CONTROL 3G iPod

Main Unit Top Panel

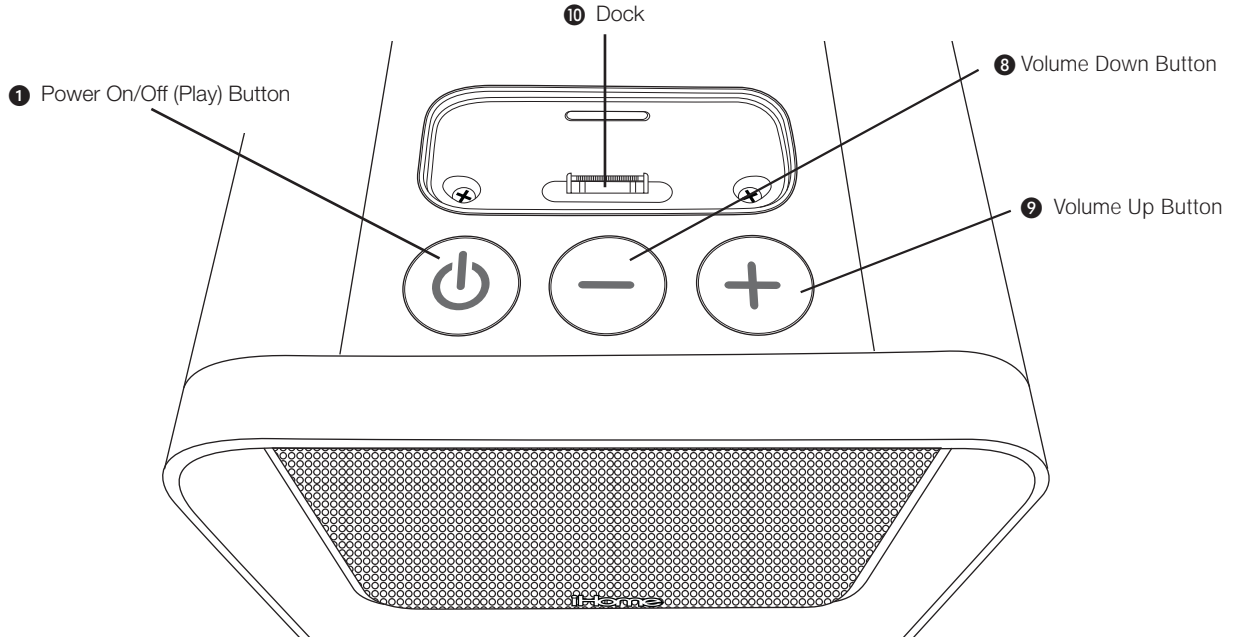

Main Unit Rear Panel

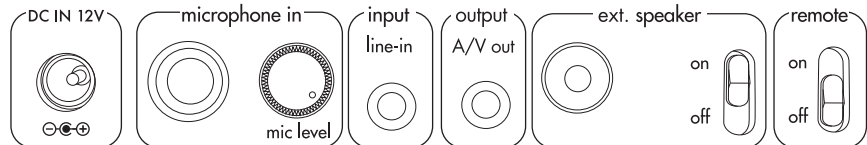

External Speaker Rear Panel

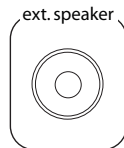

Installing/Replacing iH82 Batteries

Installing/Replacing Batteries

1. Open the battery compartment cover located on the bottom of the main unit.
2. Insert 8 "C" batteries, checking that the + and - ends of the batteries match the drawing inside the battery compartment. We recommend the use of alkaline batteries for longer life.
3. Close the compartment cover.

Batteries information:

- Do not mix old and new batteries.
- Do not mix alkaline, standard (carbon-zinc) or rechargeable batteries.
- Make sure you dispose of batteries properly (see your local regulations).

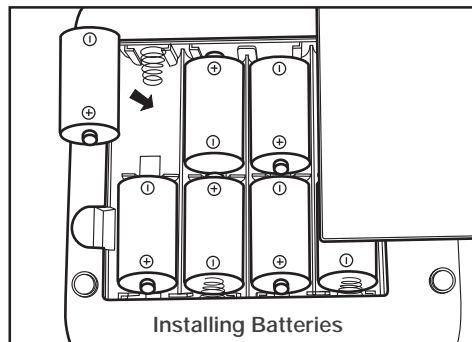

Using The Remote Control

Installing/Replacing the Remote Control Battery

The remote control battery is already installed at the factory. When the remote control stops operating or its range seems reduced, it is time to replace the battery with a new one.

1. The battery door is located on the back end of the remote.
2. Slide the battery door open and remove old battery.
3. Insert a CR2032 battery, checking that the + and - sides of the battery match the drawing inside the battery compartment.
4. Replace the battery door.

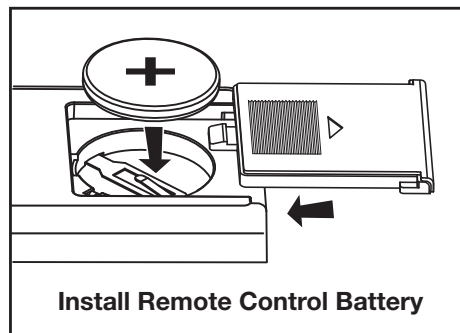

Note: Make sure you dispose of all batteries properly (see your local regulations).

OPERATING THE REMOTE CONTROL

The Remote Control controls basic functions on the main unit and certain iPod® functions when the iPod® is docked in the main unit. For best results, aim remote control towards the main unit.

Using The Remote Control

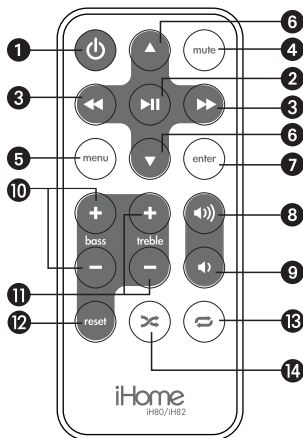

- 1 Power On/Off Button: Turns iH82 ON or OFF
- 2 Play/Pause Button : Plays track. In play mode, press to pause
- 3 Fwd/Rev Button: Skip to previous or next track, or HOLD to scan current playing track
- 4 Mute Button: Toggles sound ON or OFF
- 5 Menu Button: Press to access iPod Menu functions
- 6 Up/Down Button: Press Up or Down to scroll iPod menu
- 7 Enter Button: Press to select iPod menu function
- 8 Volume + Button: Raises volume level
- 9 Volume - Button: Lowers volume level
- 10 Bass +/- Buttons: Press to increase/reduce Bass
- 11 Treble +/- Buttons: Press to increase/reduce Treble
- 12 Reset Button: Press to reset Bass and Treble to default setting
- 13 Repeat Button: Press for repeat play (press again to repeat all)
- 14 Random Button: Press for random play

Using the iH82

Placing iPod Insert and Docking Your iPod

Your iH82 comes with 3 inserts to ensure your iPod fits properly in the dock on top of the unit.

To place an insert:

1. Select the insert for your iPod (see table on page 2). Using the correct insert ensures the proper fit for your iPod for best performance.
2. Gently press the iPod insert into the dock.
3. With insert in place, carefully place your iPod into the dock. The iPod must not be in a case or "skin".

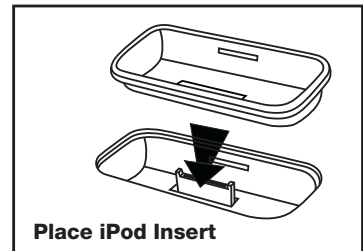

Connect AC Adaptor

Connect the AC adaptor plug into the jack on the back of the system, then plug the AC adaptor into the wall outlet.

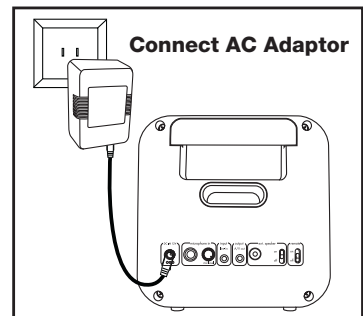

To check for iPod compatibility

iH82 is an advanced system and supports most updated iPod features. To have your iPod working properly with iH82, please update your iPod firmware with the latest version at www.apple.com.

Charging your iPod

Note: Please make sure you are using the correct insert for your iPod (see Placing iPod Insert) and that it is properly docked into the main unit. Failure to do so may damage your iPod.

1. While your iPod is docked in the unit and the unit is connected to AC power, it recharges until fully charged. Your iPod will not charge when operating on battery power. Note that other non-docking iPods will NOT charge.

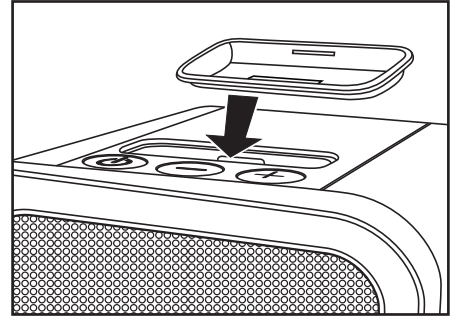

Listening to iPod

1. If you dock an already playing iPod, the iH82 will automatically turn on and you will hear the music playing from your iPod. Note: If the playing song/music loudness is too low on the iPod itself, the iH82 may not detect the iPod is in play mode.
2. When the iPod is docked and in standby mode, press the Power On/Off Button on the main unit or the remote control to play the iPod.
3. Press the iPod Play/Pause Button on the remote control to pause play; press again to resume play.
4. Press the Volume+ and Volume- Buttons on the main unit or the remote control to adjust the system volume.
5. Press the Bass or Treble +/- Buttons on the remote control to adjust the tone to your liking. Press the EQ reset button to reset Bass or Treble to default setting.
6. Press the Mute Button on the remote control to mute the main unit output. Press the Mute again or volume +/- button to resume listening
7. Press the FWD or REV Buttons on the remote control to go to the next or previous track. Press and hold while a track is playing for high speed forward or reverse music search of the current track.
8. Press the Random or Repeat Button on the remote control to set iPod play mode to play tracks randomly or to repeat the current track
9. Press the Menu, Enter, Up or Down buttons on the remote control to control your iPod just like pressing the same controls on your iPod.
10. To turn off the iH82, press the Power on/off Button on the main unit or remote control. Your iPod will continue charging while in the dock (provided the iH80 is connected by AC adaptor to working outlet).

Listening to non-docking iPod or other portable audio devices

If you are using an iPod without a docking port or other MP3 player or audio device, you can play it through the iH82 via the Line-in Jack.

1. Plug one end of the audio patch cord (included) into the headphone or line-out jack on your audio device and the other end of the patch cord into the iH82 Line-in Jack located on the back of the main unit.

Using iH82 as a PA/Karaoke system

The iH82 includes a PA/Karaoke feature. To use it, connect a Microphone with a standard 1/4" phono plug (mic and cable not included) to the MIC jack located on the back of the main unit then speak or sing into it. Use the Level knob to adjust the MIC volume to get the right balance between your voice and iPod volume.

Operating the Remote On/Off Switch

To save battery power on the main unit, switch off the Remote Switch located on the back of the iH82 for longer battery life. Doing so disables the remote.

A/V Output Jack Operation

To output iPod audio video signal from the iH82 to your TV, connect the iH82 to your TV system with an iPod AV cable (not included). Plug one end into your TV video/audio-in jack(s) and the other end to the A/V output jack located on the back of the main unit. Turn on your TV and select the input for the AV-in jack signal. Playing video from your iPod will output signal to your TV.

Troubleshooting

Symptom	Possible Problem	Solution
Unit not responding (no power)	AC adaptor isn't plugged to a wall outlet or the connector is not plugged into the power supply jack on the back of the unit	Make sure the AC adaptor is plugged into a working AC outlet and connected properly to the back of the iH80. If the outlet is controlled by a switch, make sure the switch is on
	Wall outlet is not functioning	Plug another device into the same outlet to confirm the outlet is working
	Batteries are weak	Replace with new batteries
	Batteries were not installed properly	Check to make sure the polarity (+ and – ends) matches the diagram in the battery compartment
iPod does not dock properly	Using no insert or wrong iPod insert	Make sure the dock insert is the proper fit for your iPod
	iPod not docked properly	Remove your iPod from the dock and check for obstruction on the connectors in the dock and on your iPod. Then reseal it in the dock.
iPod does not respond to the unit	iPod is not installed properly	Remove your iPod from the dock and check for obstruction on the connectors in the dock and on your iPod. Then reseal it in the dock.
	Your iPod software is too old	Upgrade software on your iPod. For details visit http://www.apple.com/ipod/download
	iPod is locked up	Please make sure your iPod is working properly before docking into the unit. Please refer to your iPod manual for details.
	Using 1 st or 2 nd generation iPod or other devices.	iH82 cannot control those iPods or other devices.

Troubleshooting

Symptom	Possible Problem	Solution
iPod didn't charge up	iPod is not docked properly	Remove your iPod from the dock and check for obstruction on the connectors in the dock and on your iPod. Then reseat it in the dock.
	iPod is locked up/ frozen	Please make sure your iPod is working properly before docking into the unit. Please refer to your iPod manual for details.
	iPod battery has problem	
	The iH80 only charges your iPod while connected to the AC adaptor (not on batteries). AC adaptor isn't plugged into a wall outlet or the connector is not plugged into the power supply jack on the back of the unit	Plug the AC adaptor into a working wall outlet and plug the connector into the supply jack on the iH82. Check that all connections are secure. If there is a power switch for the outlet make sure it is on.
Sound is distorted	Volume level is set too high	Decrease the volume on the iH82
	Sound source is distorted	If the iPod original sound source (MP3) is of poor quality, distortion and noise are easily noticed with high-power speakers. Try a different audio source such as a music CD.
		If you are using an external sound source like older generation of iPod or other audio device, try reducing the output volume on the device itself.
		Try adjusting EQ settings on your iPod/iH80/sound source.
Crackling/distorted sound	Low/not enough battery power may affect amplifier	In order, try: lowering the volume/EQ, running on AC adaptor rather than batteries, replacing the batteries
Remote control doesn't work	Remote control is out of range	Move closer to iH82
	Remote control battery is dead/weak	Replace current battery in remote with new battery

Solucionando problemas

Síntoma	Causa	Solución
La unidad no funciona (no circula corriente eléctrica)	El adaptador de AC no está conectado al tomacorriente o el conector no está conectado a la ficha en la parte posterior de la unidad	Conecte el adaptador de AC al tomacorriente y también conecte el conector a la ficha en la parte posterior de la unidad
	El tomacorriente no funciona	Coloque otro aparato en ese mismo tomacorriente para confirmar si el que no funciona es el tomacorriente
	Las baterías están gastadas	Reemplace las baterías
El iPod no encastra correctamente	No ha colocado el encastre del iPod, o está utilizando el encastre incorrecto.	Verifique que el encastre sea el apropiado para su iPod
	El iPod no encastra correctamente	Quite el iPod del encastre y retire la posible obstrucción del encastre o de su iPod. Vuelva a colocar el iPod dentro del encastre.
El ícono de batería baja está destellando	Las baterías están gastadas	Reemplace las baterías
	Las baterías no están instaladas correctamente	Verifique que la polaridad de las baterías (- y +) se encuentren de acuerdo al diagrama del compartimiento de baterías.
El iPod no se comunica con la unidad	El iPod no está instalado correctamente	Quite el iPod del encastre y verifique posibles obstrucciones del encastre o de su iPod. Vuelva a colocar el iPod dentro del encastre.
	Su software es obsoleto	Renueve su software. Para mayor información, diríjase a http://www.apple.com/ipod/download
	El iPod no responde	Verifique que su iPod funcione correctamente antes de conectarlo a la unidad. Refiérase al manual de su iPod para más detalles.
	Usted tiene un iPod de primera o segunda generación, un Shuffle u otro tipo de aparato	El iH82 no puede controlar estos otros aparatos
Los botones/controles no funcionan		

Solucionando problemas

Síntoma	Causa	Solución
El iPod no carga	El iPod no está instalado correctamente	Quite el iPod del encastre y retire la posible obstrucción del encastre o de su iPod. Vuelva a colocar el iPod dentro del encastre.
	El iPod está trabado/no responde	Por favor asegúrese de que su iPod funcione correctamente antes de colocarlo en el encastre. Refiérase al manual de su iPod para mayor información.
	La batería del iPod podría tener algún inconveniente	
El sonido sale distorsionado	El volumen se encuentra muy alto	Baje el volumen
	El sonido sale distorsionado de la unidad	Si el sonido original de su iPod era de pobre calidad, las distorsiones y ruidos se harán más notables con los parlantes de alta potencia. Pruebe utilizar otra fuente de audio como un CD.
		Si está utilizando un iPod de primeras generaciones o un Shuffle, intente bajar el volumen de su aparato. También intente apagar el amplificador de bajos
Interferencia/sonido distorsionado	La batería gastada o baja puede afectar el sonido del amplificador	En este orden, intente: bajar el volumen/EQ, utilizar la unidad con un adaptador AC en vez de con batería, reemplace las baterías.
El control remoto no funciona	Las baterías están gastadas	Reemplace las baterías por nuevas

IMPORTANT SAFETY INSTRUCTIONS

When used in the directed manner, this unit has been designed and manufactured to ensure your personal safety. However, improper use can result in potential electrical shock or fire hazards. Please read all safety and operating instructions carefully before installation and use, and keep these instructions handy for future reference. Take special note of all warnings listed in these instructions and on the unit.

1. **Water and Moisture** – The unit should not be used near water. For example: near a bathtub, washbowl, kitchen sink, laundry tub, swimming pool or in a wet basement.
2. **Ventilation** – The unit should be situated so that its location or position does not interfere with its proper ventilation. For example, it should not be situated on a bed, sofa, rug or similar surface that may block ventilation openings. Also, it should not be placed in a built-in installation, such as a bookcase or cabinet, that may impede the flow of air through the ventilation openings.
3. **Heat** – The unit should be situated away from heat sources such as radiators, heat registers, stoves or other appliances (including amplifiers) that produce heat.
4. **Power Sources** – The unit should be connected to a power AC adaptor of the type described in the operating instructions or as marked on the appliance.
5. **Power-Cord Protection** – Power AC adaptor cords should be routed so that they are not likely to be walked on or pinched by items placed upon or against them. It is always best to have a clear area from where the cord exits the unit to where it is plugged into an AC outlet.
6. **Cleaning** – The unit should be cleaned only as recommended. See the Maintenance section of this manual for cleaning instructions.
7. **Objects and Liquid Entry** – Care should be taken so that objects do not fall and liquids are not spilled into any openings or vents located on the product.
8. **Attachments** – Do not use attachments not recommended by the product manufacturer.
9. **Lightning and Power Surge Protection** – Unplug the unit from the wall outlet and disconnect the antenna or cable system during a lightning storm or when it is left unattended and unused for long periods of time. This will prevent damage to the product due to lightning and power-line surges.
10. **Overloading** – Do not overload wall outlets, extension cords, or integral convenience receptacles as this can result in a risk of fire or electric shock.
11. **Damage Requiring Service** – The unit should be serviced by qualified service personnel when:
 - A. the power supply cord or plug has been damaged.
 - B. objects have fallen into or liquid has been spilled into the enclosure.
 - C. the unit has been exposed to rain.
 - D. the unit has been dropped or the enclosure damaged.
 - E. the unit exhibits a marked change in performance or does not operate normally.
12. **Antenna** – Do not connect an external antenna to the unit (other than that provided).
13. **Periods of Nonuse** – If the unit is to be left unused for an extended period of time, such as a month or longer, the power cord should be unplugged from the unit to prevent damage or corrosion.
14. **Servicing** – The user should not attempt to service the unit beyond those methods described in the user's operating instructions. Service methods not covered in the operating instructions should be referred to qualified service personnel.
15. **Replacement Parts** – When replacement parts are required, be sure the service technician has used replacement parts specified by the manufacturer or have the same characteristics as the original part. Unauthorized substitutions may result in fire, electric shock, or other hazards.
16. **Safety Check** – Upon completion of any service or repairs to this product, ask the service technician to perform safety checks to determine that the product is in proper operating condition.

Questions? Visit www.ihomeaudio.com
For any other questions: 1-800-288-2792 Toll Free

Limited 90-Day Warranty Information

iHome Products, a division of SDI Technologies Inc. (hereafter referred to as SDI Technologies), warrants this product to be free from defects in workmanship and materials, under normal use and conditions, for a period of 90 days from the date of original purchase.

Should this product fail to function in a satisfactory manner, it is best to first return it to the store where it was originally purchased. Should this fail to resolve the matter and service still be required by reason of any defect or malfunction during the warranty period, SDI Technologies will repair or, at its discretion, replace this product without charge (except for a \$15.00 charge for handling, packing, return UPS/postage, and insurance). This decision is subject to verification of the defect or malfunction upon delivery of this product to the Factory Service Center listed below. The product must include proof of purchase, including date of purchase. The fee for service without proof of purchase is \$30.00.

Before returning this product for service, please first replace the batteries (if applicable) with fresh ones, as exhausted or defective batteries are the most common cause of problems encountered.

If service is still required:

1. Remove the batteries (if applicable) and pack the unit in a well padded, heavy corrugated box.
2. Enclose a photocopy of your sales receipt, credit card statement, or other proof of the date of purchase, if within the warranty period.
3. Enclose a check or money order payable to the order of SDI Technologies, for the sum of \$15.00 (\$30.00 without proof of purchase).
4. Send the unit prepaid and insured, to the Factory Service Center listed below.

Consumer Repair Department
SDI Technologies Inc.
1330 Goodyear Drive
El Paso, TX 79936-6420

Disclaimer of Warranty

NOTE: This warranty is valid only if the product is used for the purpose for which it was designed. It does not cover (i) products which have been damaged by negligence or willful actions, misuse or accident, or which have been modified or repaired by unauthorized persons; (ii) cracked or broken cabinets, or units damaged by excessive heat; (iii) damage to digital media players, CD's or tape cassettes (if applicable); (iv) the cost of shipping this product to the Factory Service Center and its return to the owner.

This warranty is valid only in the United States of America and does not extend to owners of the product other than to the original purchaser. In no event will SDI Technologies or any of its affiliates, contractors, resellers, their officers, directors, shareholders, members or agents be liable to you or any third party for any consequential or incidental damages, any lost profits, actual, exemplary or punitive damages. (Some states do not allow limitations on implied warranties or exclusion of consequential damages, so these restrictions may not apply to you.) This warranty gives you specific legal rights, and you may also have other rights which vary from state to state. Your acknowledgment and agreement to fully and completely abide by the above mentioned disclaimer of warranty is contractually binding to you upon your transfer of currency (money order, cashier's check, or credit card) for purchase of your SDI Technologies product.

**Questions? Visit www.ihomeaudio.com
or call 1-800-288-2792 Toll Free**

Free Manuals Download Website

<http://myh66.com>

<http://usermanuals.us>

<http://www.somanuals.com>

<http://www.4manuals.cc>

<http://www.manual-lib.com>

<http://www.404manual.com>

<http://www.luxmanual.com>

<http://aubethermostatmanual.com>

Golf course search by state

<http://golfingnear.com>

Email search by domain

<http://emailbydomain.com>

Auto manuals search

<http://auto.somanuals.com>

TV manuals search

<http://tv.somanuals.com>