

GLC 2200 Wiring Connector Kit

3A2992B

EN

Used to interface the GLC2200 Lubrication Controller to pump and pump accessories. For professional use only.

Not approved for use in explosive atmospheres or hazardous locations.

Kit Nos.:

Single Connector Kit: 24P686

Multiple (5) Connectors Kit: 24P687

Kits are rated IP65.



Important Safety Instructions

Read all warnings and instructions in this manual and the GLC 2200 Lubrication Controller instruction manual included with your unit. Save these instructions.

Instructions

Connector Installation

1. Remove 2 to 3 inches of the outer insulation from one end of a user supplied cable (a) as shown in FIG. 1.

NOTE: The cable should contain multicolored wires to ensure easy and accurate component installation.

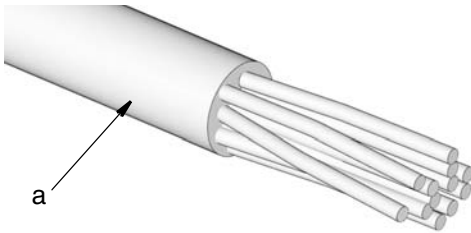

FIG. 1

2. Strip each wire (b) to be crimped so approximately 0.08 - 0.012 inches (2- 3 mm) of bare wire (c) is showing as shown in FIG. 2.

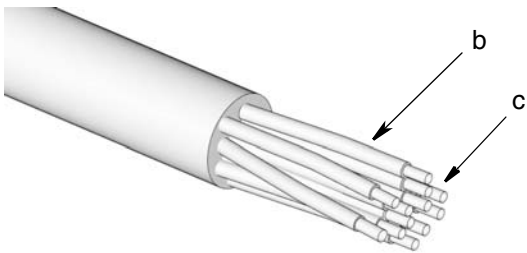

FIG. 2

3. Insert one of the pins into the appropriately sized slot of the hand crimp tool.

NOTE:

- A hand crimp tool is available from Graco. Order part number 16T671.
- The pin must be placed all the way into the crimper in the correct orientation.

4. (See FIG. 2) Insert stripped end (c) of wire (b) into pin. The edge of the insulation should be about 0.05 - 0.09 inches (1.2- 2.2 mm) into the pin.

NOTE: To ensure proper fit, ensure that the bare wire and the insulator are crimped separately.

- If the insulation is too deep, the pin will not make contact with the wire.
 - If the insulation is not deep enough, the pin may not fit inside the connector properly.
5. Firmly squeeze the crimp tool to crimp and secure the pin to the wire.
 6. Repeat steps 3 - 5 until all wires are crimped with pins.
 7. Insert pins into connector. When looking at the connector, be sure you are plugging in pins in the correct side. Refer to FIG. 3 for correct orientation and pin locations. Use the Wiring Key provided on page 4 to identify related components.

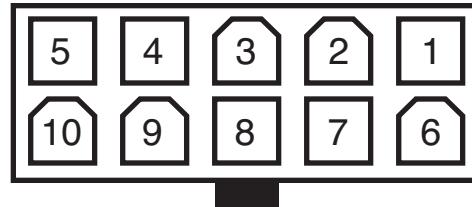

FIG. 3

NOTE:

- The second column of the Wiring Key Table is provided for the user to record the wire color assigned to each component.
- There are 10 available PIN locations in the connector. Only use the pin locations necessary for your installation. Refer to the Connector Identification Label and Wiring Key provided on page 4.

Component Wiring

1. Before connecting wires to components verify the Connector end of the cable is NOT plugged into the GLC2200 controller.
2. Remove 2 to 3 inches of the outer insulation (a) from bare end of the cable as shown FIG. 4.

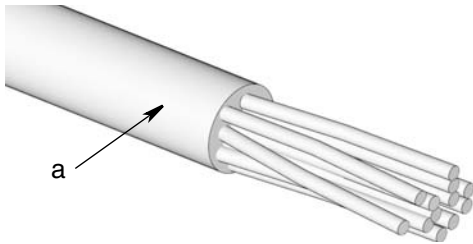

FIG. 4

3. Strip each wire (b) you are using for the installation as shown in FIG. 5.

NOTE: It is not necessary to strip all of the wires; only strip the wires needed for your installation.

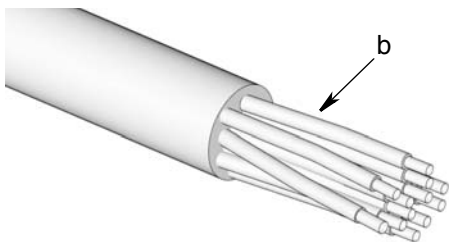

FIG. 5

4. Using the Wiring Key Table, connect components to wires matching each wire color and pin location.

Verify all negative and positive wire colors are correctly assigned.

NOTE: The second column of the Wiring Key Table is provided for the user to record the wire color assigned to each component.

5. Plug connector into the GLC2200 unit matching pin numbers to Connector Identification Label.

NOTE: The connector can only be plugged into the GLC2200 one way. The clip (c) should be facing down when the connector is correctly oriented.

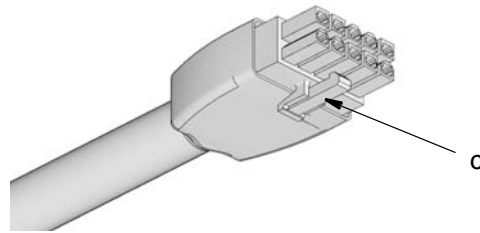

FIG. 6

Wiring Diagram

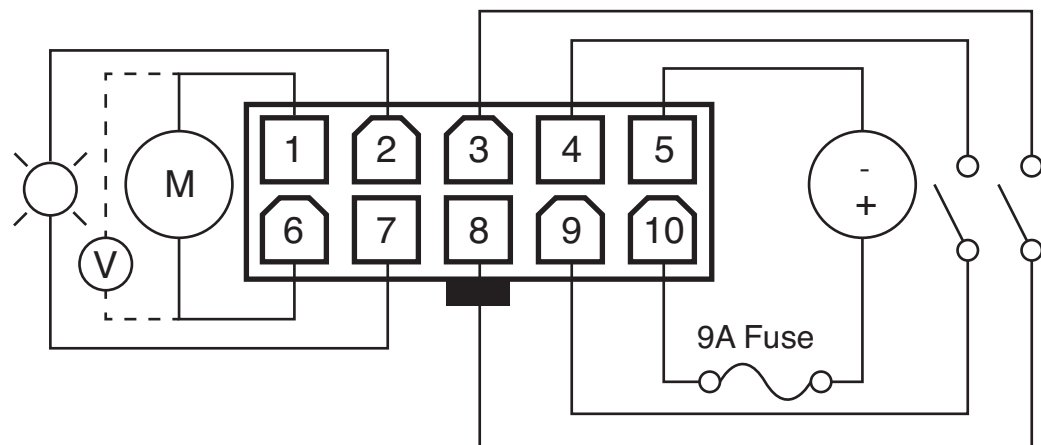

FIG. 7

M = Motor pump power or solenoid
 V = Electric vent valve for injector-based systems

Wiring Key

| Pin | Wire Color* | Description | +/- |
|-----|-------------|-----------------------|-----|
| 1 | | Pump | - |
| 2 | | Alarm | - |
| 3 | | Low Level | - |
| 4 | | Pressure Cycle Switch | - |
| 5 | | Voltage Input | - |
| 6 | | Pump | + |
| 7 | | Alarm | + |
| 8 | | Low Level | + |
| 9 | | Pressure Cycle Switch | + |
| 10 | | Voltage Input | + |

* Use this column to record the wire color assigned to each component used for your installation.

Connector Identification Label

(Adhered to GLC2200 controller)

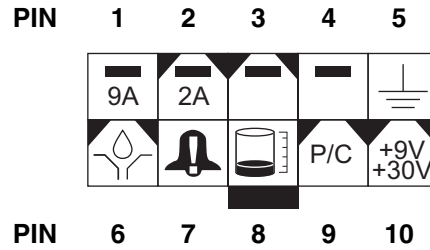

Parts

| Ref | Description | Qty | |
|-----|--|--------|--------|
| | | 24P686 | 24P687 |
| 1 | PIN, socket, 18-24 AWG, crimp, gold | 12 | 60 |
| 2 | CONNECTOR, receptacle, dual, 10 position | 1 | 5 |

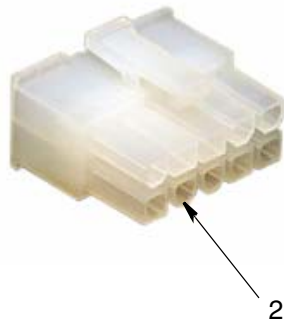
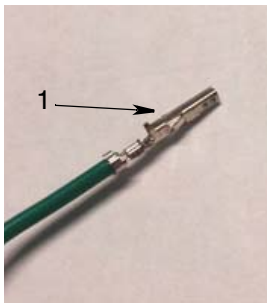

Accessories

Crimping Tool - 16T671



All written and visual data contained in this document reflects the latest product information available at the time of publication. Graco reserves the right to make changes at any time without notice.

For patent information, see www.graco.com/patents.

Original instructions. This manual contains English. MM 3A2992

Graco Headquarters: Minneapolis
International Offices: Belgium, China, Japan, Korea

GRACO INC. AND SUBSIDIARIES • P.O. BOX 1441 • MINNEAPOLIS MN 55440-1441 • USA

Copyright 2012, Graco Inc. All Graco manufacturing locations are registered to ISO 9001.

www.graco.com

December 2013

Download from Www.Somanuals.com. All Manuals Search And Download.

Free Manuals Download Website

<http://myh66.com>

<http://usermanuals.us>

<http://www.somanuals.com>

<http://www.4manuals.cc>

<http://www.manual-lib.com>

<http://www.404manual.com>

<http://www.luxmanual.com>

<http://aubethermostatmanual.com>

Golf course search by state

<http://golfingnear.com>

Email search by domain

<http://emailbydomain.com>

Auto manuals search

<http://auto.somanuals.com>

TV manuals search

<http://tv.somanuals.com>