







Operation



GH™ 200 Sprayer

309548 Rev. C

		 5.5 HP	 6.5 HP		 CSA/UL	
233940	✓	✓				
233941	✓	✓				✓
233942	✓	✓		✓		
233943	✓	✓			✓	
245693				✓		
246126					✓	
246253		✓				
246311			✓			

3300 psi (227 bar, 22.7 MPa) Maximum Working Pressure

All models not available in all countries.



Read warnings and instructions.



..... 310548



..... 309639



..... 309277



..... 309553

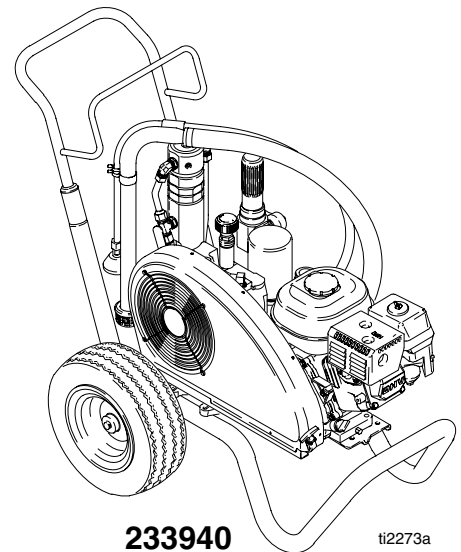

233940

ti2273a

Contents:

Controls	3
Setup	4
Startup	8
Cleanup	14
Pressure Relief	14
Troubleshooting	19

GRACO INC. P.O. BOX 1441 MINNEAPOLIS, MN 55440-1441
Copyright 2002, Graco Inc. is registered to I.S. EN ISO 9001

PROVEN QUALITY. LEADING TECHNOLOGY.



HO03

⚠ WARNING

Fire and explosion hazard: Solvent and paint fumes can ignite or explode.

To help prevent a fire and explosion:

- Use only in an extremely well ventilated area.
- Eliminate all ignition sources; such as pilot lights, cigarettes and plastic drop cloths (static arc hazard). Do not plug or unplug power cords or turn lights on or off in spray area.
- Ground Sprayer, object being sprayed, paint and solvent pails.
- Hold gun firmly to side of grounded pail when triggering into pail.
- Use only conductive airless paint hose.
- Do not use 1,1,1-trichloroethane, methylene chloride, other halogenated hydrocarbon solvents or fluids containing such solvents in pressurized aluminum equipment. Such use could result in a chemical reaction, with the possibility of explosion.
- Do not fill fuel tank while engine is running or hot.
- Do not flush with gasoline.
- Do not touch hot surfaces

Fluid injection and high pressure hazard: High pressure spray or leaks can inject fluid into the body.

To help prevent injection, always:

- Engage trigger safety latch when not spraying.
- Keep clear of nozzle and leaks.
- Never spray without a tip guard.
- Do **PRESSURE RELIEF** if you stop spraying or begin servicing sprayer.
- Do not use components rated less than sprayer *Maximum Working Pressure*.
- Never allow children to use this unit.

If high pressure fluid pierces your skin, the injury might look like "just a cut". But it is a serious wound! Get immediate medical attention.

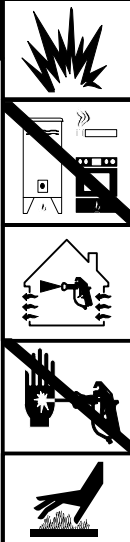

⚠ ADVERTÊNCIA

Perigo de incêndio e explosão: os solventes e os vapores da pintura poderão explodir ou incendiar.

Para ajudar a evitar incêndio e explosão:

- Utilize unicamente em áreas extremamente bem ventiladas.
- Elimine todas as fontes de ignição, tais como luzes piloto, cigarros e arcos de estática resultantes dos plásticos de proteção. Não ligue nem desligue os cabos de alimentação ou as luzes numa área de pulverização.
- Ponha em contato com a terra o pulverizador, o objeto a ser pulverizado, e os baldes de tinta e de solventes.
- Segure a pistola firmemente de encontro ao lado do balde em contato com a terra, quando estiver descarregando para dentro do mesmo.
- Utilize somente tubos flexíveis condutores para pintura a alta pressão.
- Não utilize 1,1,1-tricloroetano, cloreto de metileno, outros solventes de hidrocarbonetos halogenados ou líquidos contendo tais solventes em equipamento de alumínio pressurizado. Tal utilização poderá resultar numa reação química, com possibilidade de explosão.
- Nunca abasteça o depósito de combustível com o motor em funcionamento ou quente.
- Não faça a descarga com gasolina.
- Não toque em superfícies quentes.

Perigo de injeção de líquidos à alta pressão: a pulverização ou vazamentos à alta pressão podem injetar líquido no corpo.

Para ajudar a evitar injeção de líquido, faça sempre o seguinte:

- Engate o trinco de segurança do gatilho quando não estiver pulverizando.
- Mantenha-se afastado dos bocais e locais onde há vazamentos.
- Nunca pulverize sem que haja uma proteção na extremidade.
- **ALIVIE A PRESSÃO** quando parar de pulverizar e antes de iniciar a manutenção do pulverizador.
- Não utilize componentes com uma classificação inferior à do pulverizador *Pressão Máxima de Trabalho*.
- Nunca permita que crianças utilizem esta unidade.

Se o líquido a alta pressão penetrar na sua pele, o ferimento poderá parecer "simplesmente um corte". Mas é um ferimento grave! Procure o médico imediatamente.

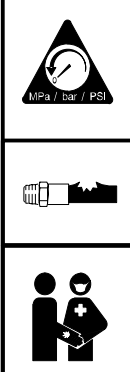

⚠ MISE EN GARDE

Danger d'incendie et d'explosion : les gaz de solvant et de peinture peuvent s'enflammer ou exploser.

Pour éviter les risques d'incendie et d'explosion :

- N'utiliser l'appareil que dans une zone extrêmement bien aérée.
- Éliminer toute source d'inflammation ; telle que veilleuses, cigarettes et arcs d'électricité statique créés par les toiles de peintre en plastique. Ne pas brancher et débrancher de cordons électriques, ou allumer et éteindre des lumières dans la zone de pulvérisation.
- Mettre à la terre le pulvérisateur, l'objet à pulvériser ainsi que les seaux de peinture et de solvants.
- Tenir le pistolet fermement contre la paroi d'un seau mis à la terre lorsqu'on pulvérise dans le seau.
- N'utiliser qu'un flexible pour peinture pulvérisée sans air.
- Ne jamais utiliser de trichloroéthane 1,1,1, de chlorure de méthylène, d'autres solvants à base d'hydrocarbures halogénés, ni de produits contenant de tels solvants dans un équipement sous pression en aluminium. Cela pourrait provoquer une réaction chimique avec risque d'explosion.
- Ne jamais remplir le réservoir d'essence lorsque le moteur est chaud ou en marche.
- Ne pas rincer avec de l'essence.
- Ne touchez pas les surfaces chaudes.

Danger d'injection de fluide et haute pression : la pulvérisation sous haute pression ou les fuites peuvent injecter des fluides dans le corps.

Pour éviter les risques d'injection, toujours :

- Bloquer le loquet de sécurité de la gâchette à la fin de la pulvérisation.
- Se tenir loin de la buse et des fuites.
- Ne jamais pulvériser sans anti-gouttes.
- **DÉCHARGER LA PRESSÃO** à la fin de la pulvérisation ou avant de réparer le pulvérisateur.
- Ne pas utiliser de composants dont la pression nominale est inférieure à la *pression maximale de service du système*.
- Ne jamais permettre aux enfants d'utiliser cet appareil.

Si un fluide haute pression perce la peau, la blessure peut paraître une "simple coupure" Mais il s'agit bien d'une lésion grave! Consulter immédiatement un médecin.



⚠ ADVERTENCIA

Peligro de incendio o explosión: Los gases de los disolventes y de la pintura pueden inflamarse o provocar una explosión.

Para prevenir incendios y explosiones:

- Use únicamente en un área muy bien ventilada.
- Suprima todas las fuentes de ignición; como luces piloto, cigarrillos y arcos estáticos de carpetas plásticas para protección contra pintura. No enchufe ni desenchufe cables de alimentación ni apague ni encienda las luces en un área de pulverización.
- Ponga a tierra el pulverizador, el objeto que recibe el chorro pulverizado, las cubetas de pintura y disolvente.
- Sostenga firmemente la pistola a un lado de la cubeta puesta a tierra cuando dispare dentro de ella.
- Use solamente mangueras para pintura conductora sin aire.
- No utilice nunca tricloroetano-1,1,1, cloruro de metileno ni otros disolventes a base de hidrocarburos halógenos o fluidos que contengan dichos disolventes en un equipo a presión de aluminio. El uso de estas sustancias puede provocar una intensa reacción química, con riesgos de explosión.
- Nunca llene el estanque de combustible mientras el motor esté en marcha o caliente.
- No toque las superficies calientes.

Peligro de inyección de fluido y alta presión: por la pulverización o las filtraciones a alta presión se pueden inyectar fluidos en el organismo.

Para prevenir la inyección en la piel, siempre:

- Enganche el seguro del gatillo cuando no use el pulverizador.
- No se acerque a la boquilla ni a las filtraciones.
- Nunca aplique fluido pulverizado sin un guardaboquilla.
- Realice el **ALIVIO DE PRESIÓN** si deja de pulverizar fluido o repara el pulverizador.
- No use componentes de capacidad nominal inferior a la *presión máxima de operación del pulverizador*.
- No permita que niños usen esta unidad.

Si fluido de alta presión le penetra la piel, la lesión podría parecer "sólo un corte". ¡Es una lesión seria! Consulte de inmediato al médico.

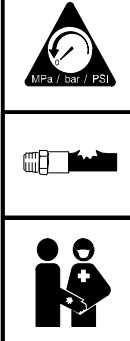

CONTROLS

Pump valve

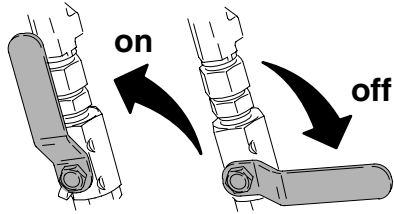

Pressure Control

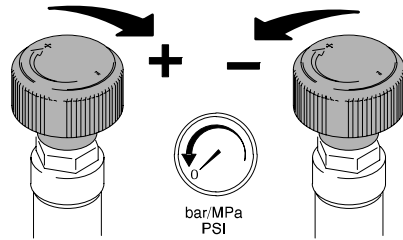

Drain Valve

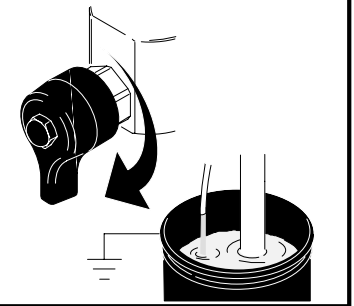
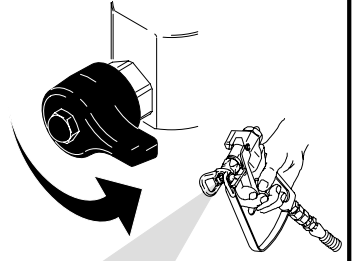

Trigger Lock

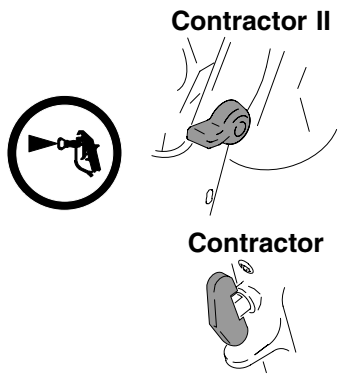
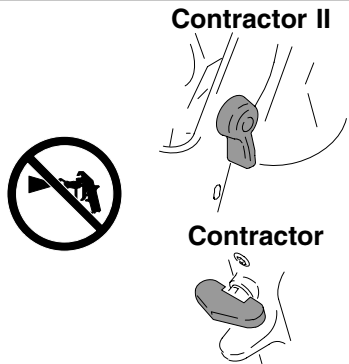

On/Off Switch

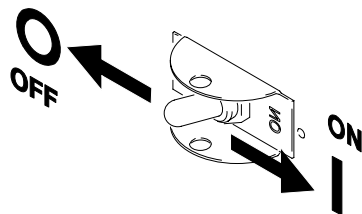

On/Off Switch



Engine Controls

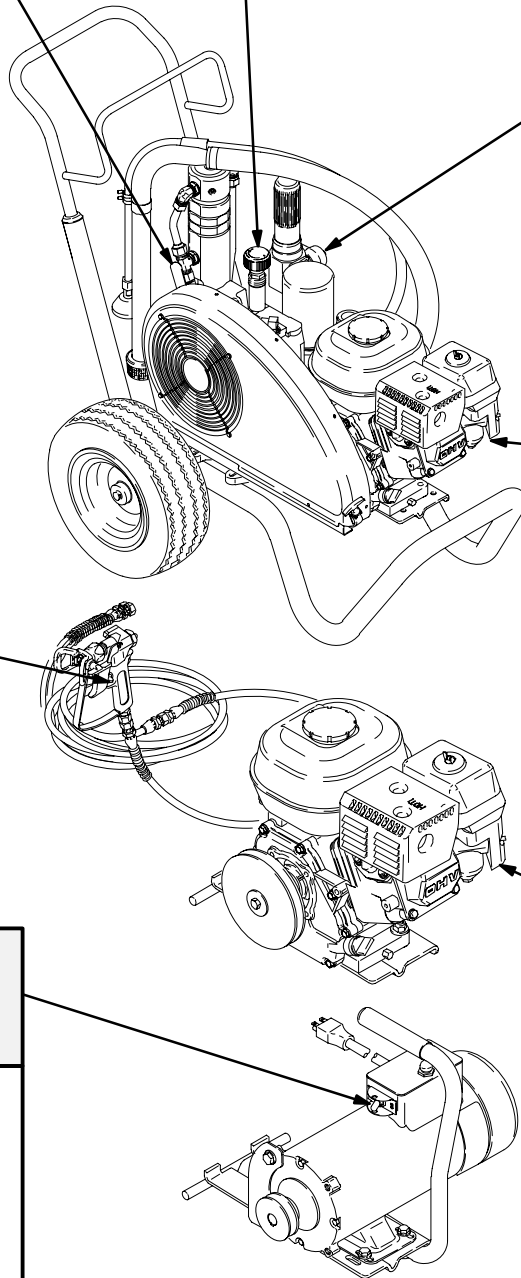
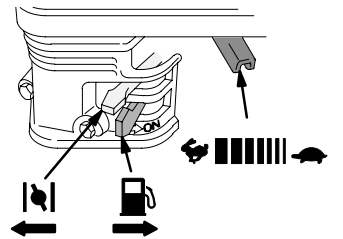

ti2267a

Setup

Unplug motor power cord or turn engine switch OFF.

Change Engine or Motor

1. Loosen motor clamp and swivel bracket. Lift strap.

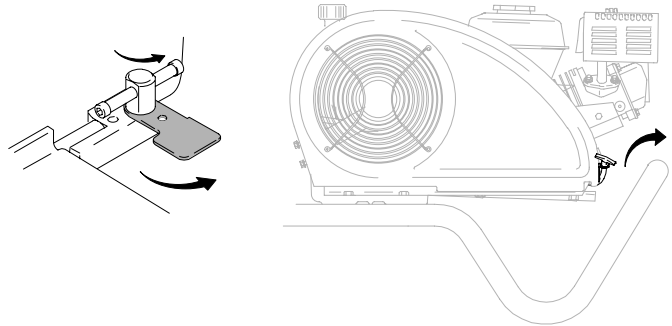

2.  **WARNING**
ADVERTENCIA **MISE EN GARDE**
ADVERTENCIA Lift belt guard.
Tilt engine/motor.
Remove engine/motor.

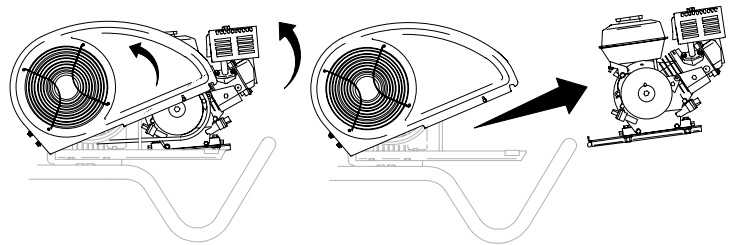
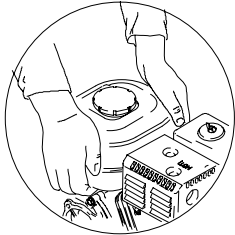

3. Tilt engine/motor. Install engine/motor. Lower belt guard.

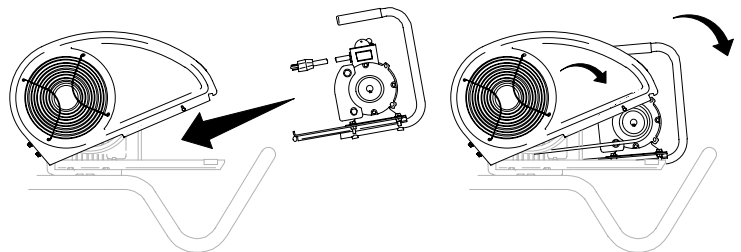

4. Swivel bracket and tighten motor clamp. Secure strap.

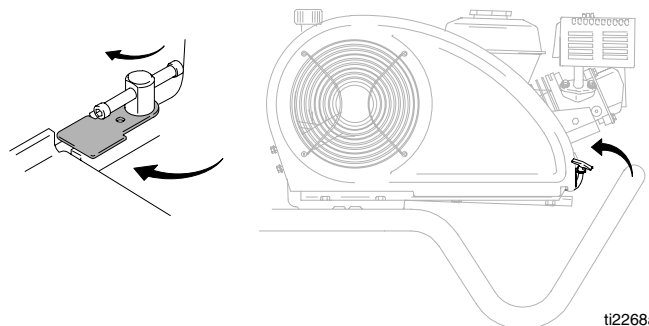

ti2268a

Complete Setup

1. Connect appropriate Graco high-pressure hose to sprayer. Tighten securely.

Note: Remove second gun port cap for multiple guns and repeat steps 1 – 4.

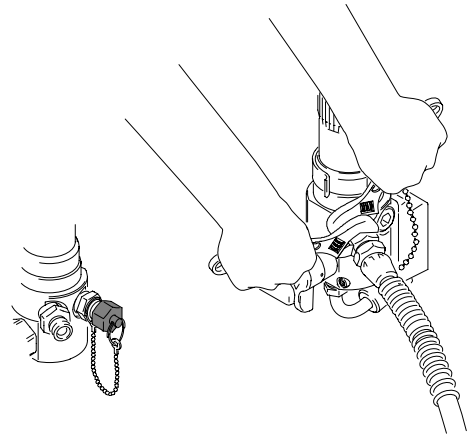

-
2. Connect other end of hose to gun.

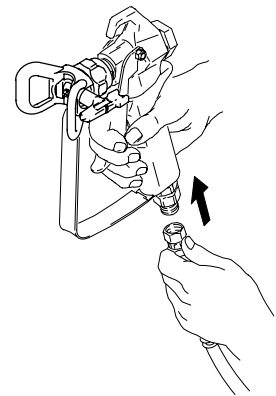

-
3. Tighten securely.

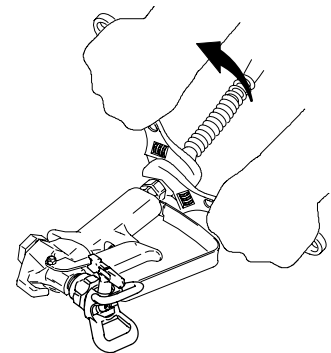

-
4. Remove tip guard.

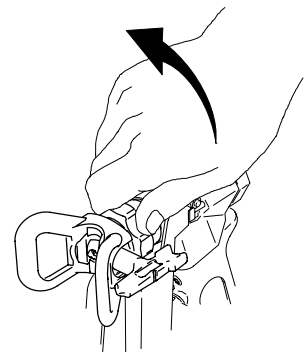

-
5. Install clean inlet strainer.

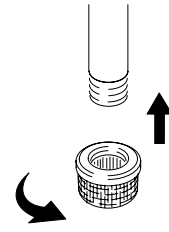

-
6. Fill throat packing nut with TSL to prevent premature packing wear. Do this each time you spray and store.

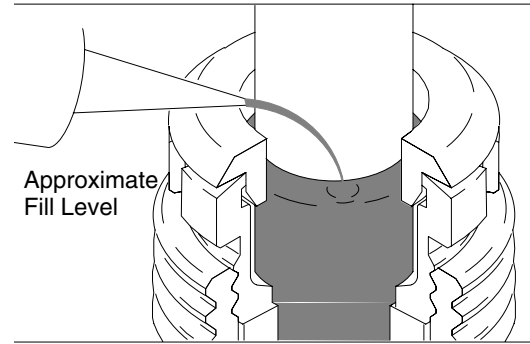

-
7. Check engine oil level. Add SAE 10W-30 (summer) or 5W-20 (winter), if necessary.

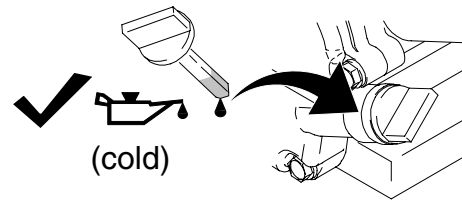

8. Fill fuel tank.

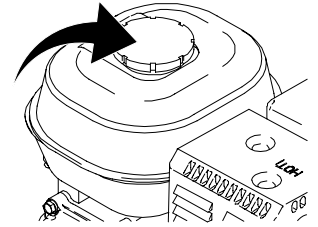

9. **Check hydraulic oil level.** Add *only* Graco Hydraulic Oil, Grade 6, 169236 (5 gallon/18.9 liter) or 207428 (1 gallon/3.8 liter). Hydraulic tank capacity is 1 gallon (3.8 liter).



Safe Range (cold)

10. Attach sprayer grounding clamp to earth ground.

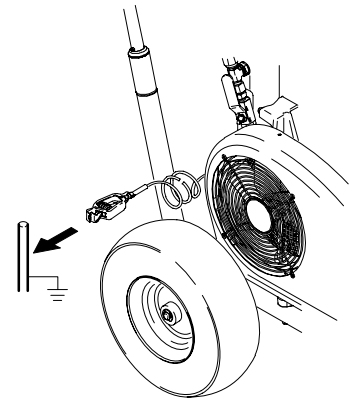
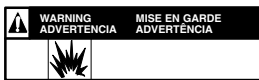

Startup

1. Place suction tube and drain tube in grounded metal pail partially filled with flushing fluid. Attach ground wire to pail and to earth ground.

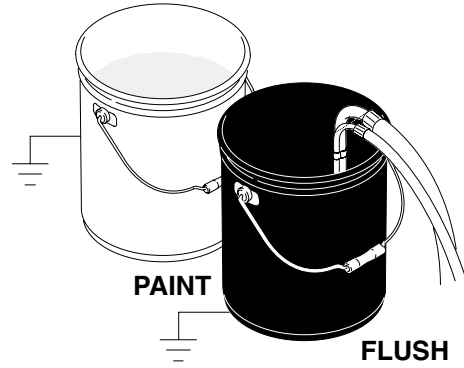

2. Turn prime valve down.
Turn pressure control counterclockwise to lowest pressure.

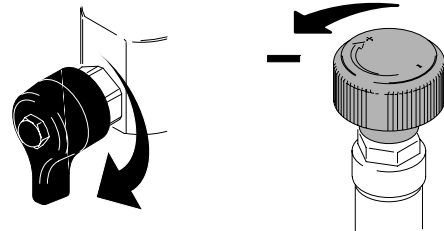

3. Set pump valve OFF.

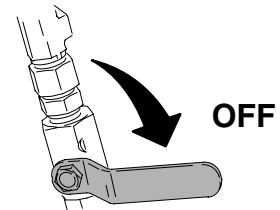

4. Start engine

a. Move fuel valve to open

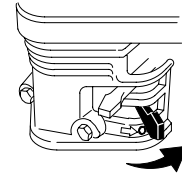

b. Move choke to closed

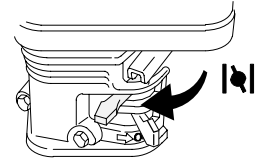

c. Set throttle to fast

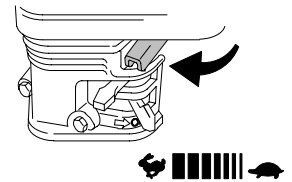

d. Set engine switch ON

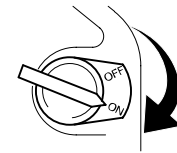

e. Pull starter cord

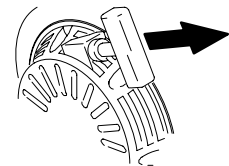

f. After engine starts, move choke to open

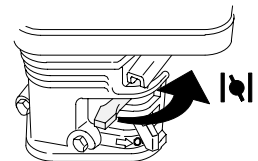

g. Set throttle to desired setting

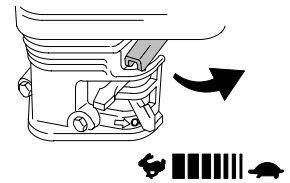

-
5. Set pump valve ON.
– Hydraulic motor is now active –

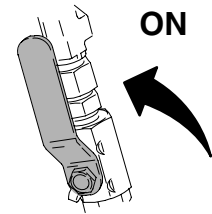

-
6. Increase pressure enough to start hydraulic motor stroking and allow fluid to circulate for 15 seconds; turn pressure down, turn prime valve horizontal.

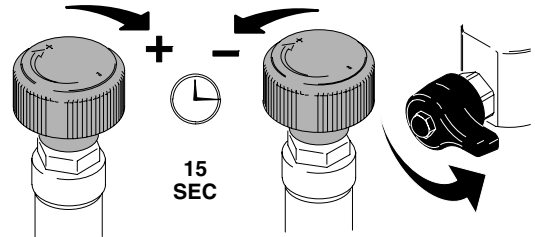

-
7. Take spray gun trigger safety OFF.

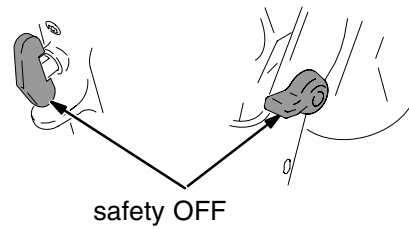

ti2870a

-
8. Hold gun against grounded metal flushing pail. Trigger gun and increase fluid pressure slowly until pump runs smoothly.

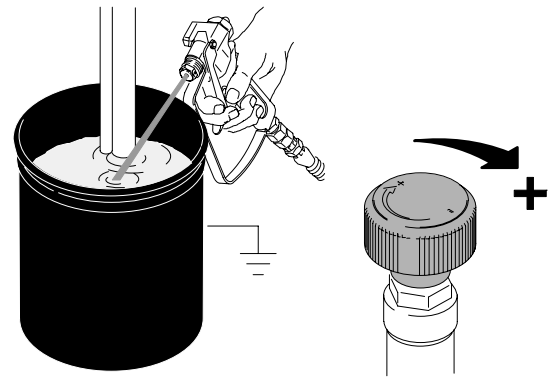

FLUSH



Inspect fittings for leaks. **Do not stop leaks with your hand or a rag!** If leaks occur, turn sprayer OFF immediately. Do **Pressure Relief in Cleanup, 1. – 3.** on page 14. Tighten leaky fittings. Repeat **Startup, 1. – 5.** If no leaks, continue to trigger gun until system is thoroughly flushed. Proceed to **6.**

-
9. Place siphon tube in paint pail.

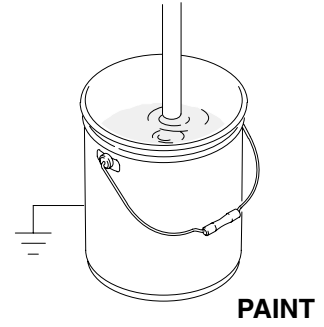

-
10. Trigger gun again into flushing fluid pail until paint appears.
Assemble tip and guard, page 13.

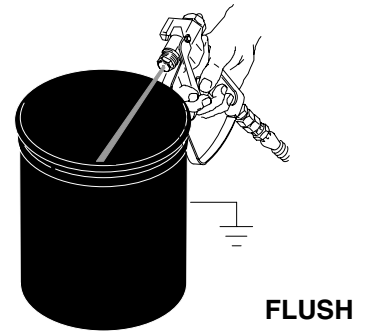

SwitchTip and Guard Assembly

1. Insert SwitchTip. Insert seat and OneSeal.

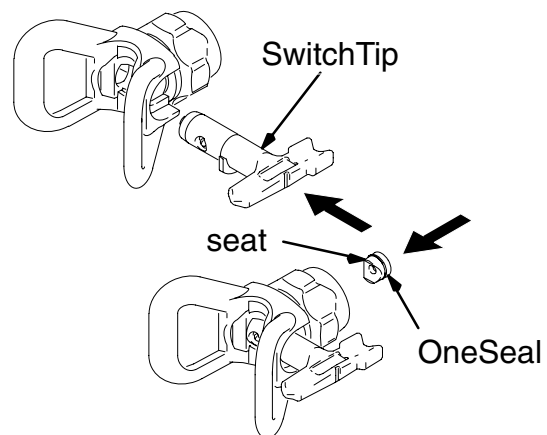

2. Screw assembly onto gun. Hand tighten.

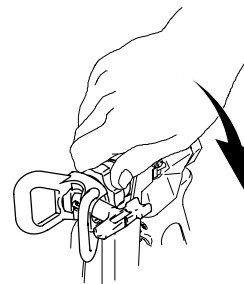

Clearing Tip Clogs

1. Release trigger, put trigger safety ON. Rotate SwitchTip. Take trigger safety OFF and trigger gun to clear the clog.

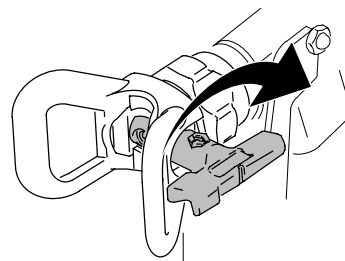

2. Put trigger safety ON, return SwitchTip to original position, take trigger safety OFF and continue spraying.

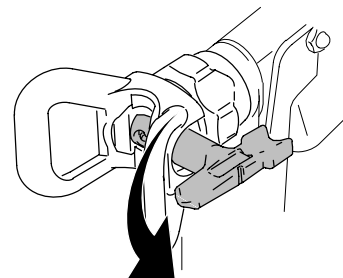

Cleanup



Pressure Relief

1. Set pump valve OFF.
Turn engine OFF.

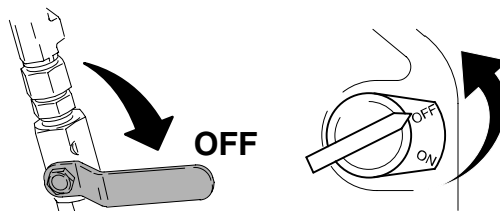

Pressure Relief

2. Turn pressure to lowest setting. Trigger gun to relieve pressure.

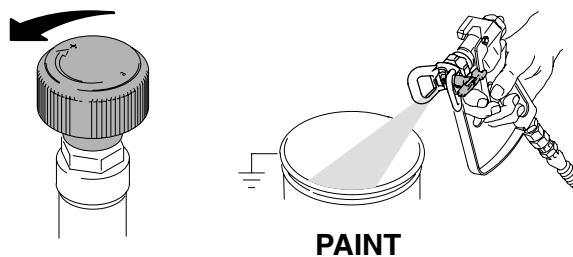

Pressure Relief

3. Turn prime valve down.

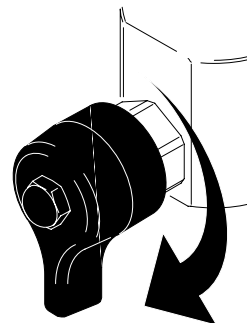

4. Remove guard and SwitchTip.

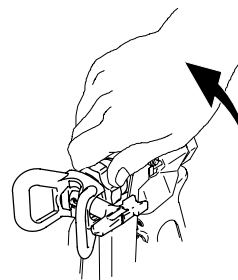

-
5. Unscrew bowl, remove filter. Assemble without filter. Clean filter.

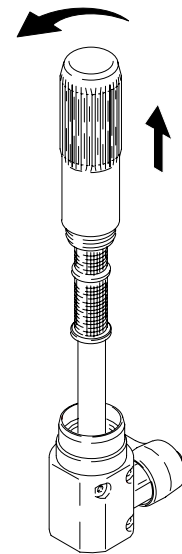

-
6. Clean filter, guard and SwitchTip in flushing fluid.



-
7. Remove siphon tube set from paint and place in flushing fluid.
Use water for water base paint and mineral spirits for oil base paint.

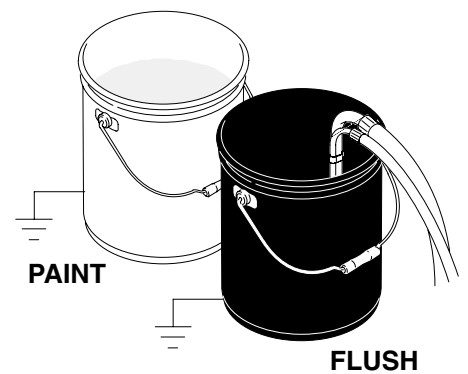

-
8. Turn engine **ON** and start engine. Set pump valve **ON**.

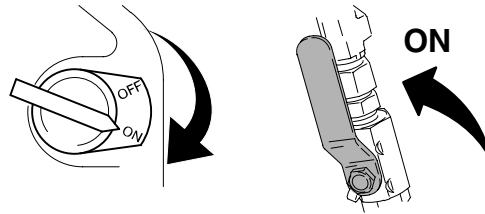

-
9. Turn prime valve horizontal.

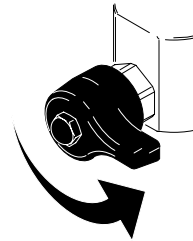

-
10. Hold gun against paint pail. Take trigger safety **OFF**.
Turn pressure control up until motor begins to drive pump.
Trigger gun until flushing fluid appears.

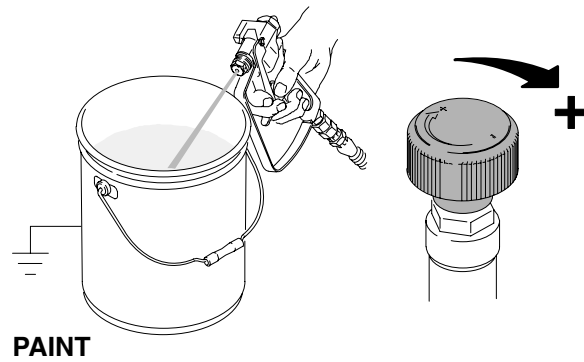

-
11. Move gun to flushing pail, hold gun against pail, trigger gun to thoroughly flush system. Release trigger and put trigger safety **ON**.

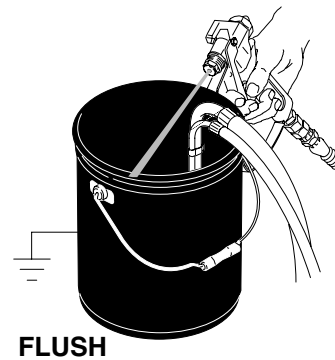

-
12. Turn prime valve down and allow flushing fluid to circulate for approximately 20 seconds to clean drain tube.

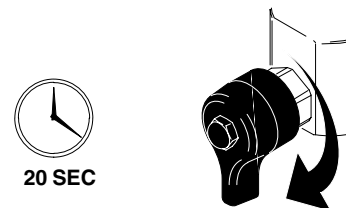

-
13. Raise siphon tube above flushing fluid and run sprayer for 15 to 30 seconds to drain fluid. Turn pump valve **OFF**. Turn engine **OFF**.

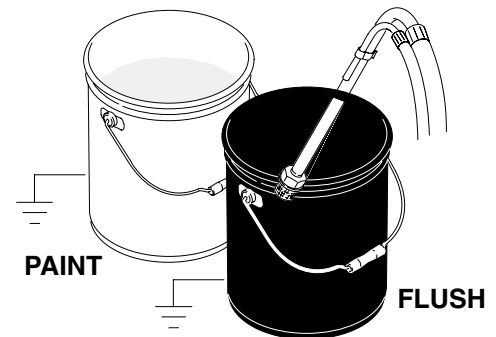

Caution: If flushing with water, do not leave water in sprayer. Flush again with mineral spirits, oil or Pump Armor and leave this protective coating in the sprayer to help prevent freezing or corrosion and increase sprayer life.

-
14. Make sure plastic center tube is tightened securely. Install filter bowl and filter. Hand tighten filter bowl. Hand tighten gun handle.

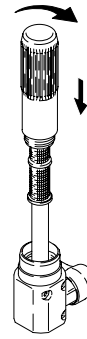

-
15. Wipe sprayer, hose and gun with a rag soaked in water or mineral spirits.

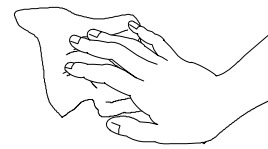

-
16. Clean tip, guard and gasket with a soft bristle brush to prevent part failure due to dried materials. Assemble parts and attach loosely onto gun.



Troubleshooting



To reduce risk of serious injury, when instructed to relieve pressure, do steps 1. – 3.; page 14.

PROBLEM	CAUSE	SOLUTION
Gas engine pulls hard (won't start)	Hydraulic pressure is too high	Turn hydraulic pressure knob counterclockwise to lowest setting
Gas engine does not start	Switch OFF, low oil, no gasoline	Consult engine manual, supplied
Gas engine doesn't work properly	Elevation	Consult engine manual, supplied. Refer to 6.5 HP Engine Repair Kit, 246311.
Gas engine operates, but displacement pump doesn't operate	Pump valve is OFF Pressure setting too low Displacement pump outlet filter (if used) is dirty or clogged Tip or tip filter (if used) is clogged Hydraulic fluid too low Belt worn or broken Hydraulic pump worn or damaged Dried paint seized paint pump rod Hydraulic motor not shifting	Set pump valve ON Increase pressure, page 10 Clean the filter Remove tip and/or filter and clean Shut off sprayer. Add fluid*. See page 7. Replace. See manual 310548. Bring sprayer to Graco distributor for repair Service pump. See manual 309277. Set pump valve OFF. Turn pressure down. Turn engine OFF. Pry rod up or down until hydraulic motor shifts. Manual 310548.
Displacement pump operates, but output is low on upstroke	Piston ball check not seating properly. Piston packings worn or damaged.	Service piston ball check. See manual 309277. Replace packings. See manual 309277.
Displacement pump operates but output is low on downstroke and/or on both strokes	Piston packings worn or damaged. Intake valve ball check not seating properly. Suction tube air leak	Tighten packing nut or replace packings. See manual 309277. Service intake valve ball check. See manual 309277. Tighten suction tube
Paint leaks and runs over side of wetcup	Loose wet-cup Throat packings worn or damaged	Tighten packing nut enough to stop leakage Replace packings. See manual 309277.
Excessive leakage around hydraulic motor piston rod wiper	Piston rod seal worn or damaged	Replace these parts. See manual 310548.
Fluid delivery is low	Pressure setting too low Displacement pump outlet filter (if used) is dirty or clogged Intake line to pump inlet is not tight Hydraulic motor is worn or damaged Large pressure drop in fluid hose	Increase pressure, page 10 Clean filter Tighten Bring sprayer to Graco distributor for repair Use larger diameter or shorter hose
The sprayer overheats	Paint buildup on hydraulic components	Clean
	Oil level is low	Fill with oil. See page 7.
Spitting from gun	Air in fluid pump or hose	Check for loose connections on siphon assembly, tighten, then reprime pump
	Loose intake suction	Tighten
	Fluid supply is low or empty	Refill supply container
Excessive hydraulic pump noise	Low hydraulic fluid level	Shut off sprayer. Add fluid*. See page 7.

*Check hydraulic fluid level often. Do not allow it to become too low. Use only Graco approved hydraulic fluid, page 7.

Graco Warranty

Graco warrants all equipment listed in this manual which is manufactured by Graco and bearing its name to be free from defects in material and workmanship on the date of sale by an authorized Graco distributor to the original purchaser for use. With the exception of any special extended or limited warranty published by Graco, Graco will, for a period of twelve months from the date of sale, repair or replace any part of the equipment determined by Graco to be defective. This warranty applies only when the equipment is installed, operated and maintained in accordance with Graco's written recommendations.

This warranty does not cover, and Graco shall not be liable for general wear and tear, or any malfunction, damage or wear caused by faulty installation, misapplication, abrasion, corrosion, inadequate or improper maintenance, negligence, accident, tampering, or substitution of non-Graco component parts. Nor shall Graco be liable for malfunction, damage or wear caused by the incompatibility of Graco equipment with structures, accessories, equipment or materials not supplied by Graco, or the improper design, manufacture, installation, operation or maintenance of structures, accessories, equipment or materials not supplied by Graco.

This warranty is conditioned upon the prepaid return of the equipment claimed to be defective to an authorized Graco distributor for verification of the claimed defect. If the claimed defect is verified, Graco will repair or replace free of charge any defective parts. The equipment will be returned to the original purchaser transportation prepaid. If inspection of the equipment does not disclose any defect in material or workmanship, repairs will be made at a reasonable charge, which charges may include the costs of parts, labor, and transportation.

Graco's sole obligation and buyer's sole remedy for any breach of warranty shall be as set forth above. The buyer agrees that no other remedy (including, but not limited to, incidental or consequential damages for lost profits, lost sales, injury to person or property, or any other incidental or consequential loss) shall be available. Any action for breach of warranty must be brought within two (2) years of the date of sale.

GRACO MAKES NO WARRANTY, AND DISCLAIMS ALL IMPLIED WARRANTIES OF MERCHANTABILITY AND FITNESS FOR A PARTICULAR PURPOSE IN CONNECTION WITH ACCESSORIES, EQUIPMENT, MATERIALS OR COMPONENTS SOLD BUT NOT MANUFACTURED BY GRACO. These items sold, but not manufactured by Graco (such as electric motors, gas engines, switches, hose, etc.), are subject to the warranty, if any, of their manufacturer. Graco will provide purchaser with reasonable assistance in making any claim for breach of these warranties.

In no event will Graco be liable for indirect, incidental, special or consequential damages resulting from Graco supplying equipment hereunder, or the furnishing, performance, or use of any products or other goods sold hereto, whether due to a breach of contract, breach of warranty, the negligence of Graco, or otherwise.

FOR GRACO CANADA CUSTOMERS

The parties acknowledge that they have required that the present document, as well as all documents, notices and legal proceedings entered into, given or instituted pursuant hereto or relating directly or indirectly hereto, be drawn up in English. Les parties reconnaissent avoir convenu que la rédaction du présente document sera en Anglais, ainsi que tous documents, avis et procédures judiciaires exécutés, donnés ou intentés à la suite de ou en rapport, directement ou indirectement, avec les procédures concernées.

ADDITIONAL WARRANTY COVERAGE

Graco does provide extended warranty and wear warranty for products described in the "Graco Contractor Equipment Warranty Program".

Graco Phone Number

TO PLACE AN ORDER, contact your Graco distributor, or call this number to identify the distributor closest to you:
1-800-690-2894 Toll Free.

*All written and visual data contained in this document reflects the latest product information available at the time of publication.
Graco reserves the right to make changes at any time without notice.*

Sales Offices: Minneapolis

International Offices: Belgium, Korea, Hong Kong, Japan

GRACO INC. P.O. BOX 1441 MINNEAPOLIS, MN 55440-1441

<http://www.graco.com>

PRINTED IN U.S.A. 309548, 7/2002 Revised 8/2004

Free Manuals Download Website

<http://myh66.com>

<http://usermanuals.us>

<http://www.somanuals.com>

<http://www.4manuals.cc>

<http://www.manual-lib.com>

<http://www.404manual.com>

<http://www.luxmanual.com>

<http://aubethermostatmanual.com>

Golf course search by state

<http://golfingnear.com>

Email search by domain

<http://emailbydomain.com>

Auto manuals search

<http://auto.somanuals.com>

TV manuals search

<http://tv.somanuals.com>