

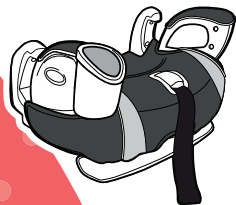

www.gracobaby.com

ARGOS™ 70

Child Restraint/Booster Seat
Owner's Manual



READ THIS MANUAL

Do not install or use this child restraint until you read and understand the instructions in this manual. FAILURE TO PROPERLY USE THIS CHILD RESTRAINT INCREASES THE RISK OF SERIOUS INJURY OR DEATH IN A SUDDEN STOP OR CRASH.

Table of Contents

1.0 Warnings to Parents and Other Users	4-5	7.0 Choosing an Appropriate Vehicle Seat Location	15
2.0 Registration Information	6	7.1 Vehicle Seat Location Requirements	15
2.1 Register Your Child Restraint	6	7.2 Vehicle Seat Belt Requirements	16
2.2 For Recall Information	6	7.3 SAFE Vehicle Seat Belt Systems	16
2.3 If You Need Help	7	7.4 For Built-in Harness Only	17
3.0 Useful Information	7	7.5 WITH or WITHOUT Built-in Harness	18
3.1 Certification	7	7.6 To Install Locking Clip	19
3.2 Child Restraint Useful Life	7	7.7 UNSAFE Vehicle Belt Systems	20-21
3.3 Second Hand Child Restraint	7	8.0 LATCH	22
4.0 Features	8-9	8.1 What is LATCH?	22-23
5.0 WARNINGS	10-11	8.2 LATCH System	24
6.0 Height and Weight Limitations	12	9.0 Using Child Restraint WITH Built-in Harness	25-27
6.1 WITH Built-in Harness	12		
6.2 WITHOUT Built-in Harness	13		
6.3 WITHOUT Back Support	14		

Table of Contents (cont.)

10.0 Securing the Child Restraint in Your Vehicle	28	19.0 Securing Child in Vehicle Belt with Shoulder Belt Positioning Clip	50-53
10.1 Using a Child Restraint WITH a Built-in Harness	28	20.0 Using the Tether	54
10.2 With a Vehicle Lap or Lap/shoulder belt	28-29	20.1 Storing LATCH and Tether.	55
10.3 With LATCH	30-31	21.0 Airplane Use	56
11.0 Securing Your Child in the Child Restraint	32-34	22.0 Accessories	57
12.0 Adjust Head Support/Harness Straps	35	22.1 Body Support and Harness Covers	57
13.0 Check Harness System	36	23.0 Recline Foot	58
14.0 Harness Removal.	37-41	24.0 Care and Maintenance	59
15.0 Using Your Child Restraint WITHOUT Built-in Harness	42-44	25.0 To Remove Head Support and Seat Covers.	60-61
16.0 Securing Child & Booster Seat in Vehicle	45	26.0 Replacement Parts, Warranty and Owners Manual Storage	64
17.0 Adjusting Head Support in Booster Mode	46		
18.0 Removing Back Support	47-49		

1.0 Warnings to Parents and Other Users

WARNING

NEVER PLACE THIS CHILD RESTRAINT IN A VEHICLE SEATING LOCATION THAT HAS A FRONT AIR BAG. If an air bag inflates, it can hit the child and child restraint with great force and cause serious injury or death to your child. Refer to your vehicle owner's manual for information about side air bags and child restraint installation.



WARNING

Failure to properly use this child restraint increases the risk of serious injury or death in a sharp turn, sudden stop or crash. Your child's safety depends on you installing and using this child restraint correctly.

Even if using this child restraint seems easy to figure out on your own, it is very important to **READ THE OWNER'S MANUAL** and the vehicle owner's manual.

Your child's safety depends on:

1. **Choosing the correct mode of use** for the child restraint depending on your child's size.
2. **Inserting the harness straps** (if needed) in the proper slots for your child.
3. **Selecting a suitable location** for the child restraint in your vehicle.
4. **Properly routing the vehicle seat belt or LATCH.**
5. **Properly securing the child restraint in the vehicle** using a seat belt designed to restrain both the child restraint and your child or by using **LATCH**. Many seat belts are **NOT** safe to use with this child restraint, even though they can easily be threaded through or around the child restraint!
6. **Properly securing your child** in the child restraint.

2.0 Registration Information

Model Number: _____

Manufactured in: _____

Purchase Date: _____

2.1 Register Your Child Restraint

Please fill in the above information. The model number and manufactured in (date) can be found on a label on the child restraint. Fill out the prepaid registration postcard attached to the harness and mail it today.

Child restraints could be recalled for safety reasons. You must register this restraint to be reached in a recall. Send your name, address, and the restraint's model number and manufacturing date to:

Graco Children's Products Inc.
150 Oaklands Blvd. Exton, PA, 19341
or call 1-800-345-4109
or register online at:
<http://www.gracobaby.com/carseatregistration>

2.2 For Recall Information

Call the U.S. Government's Vehicle Safety Hotline at: 1-888-327-4236 (TTY:1-800-424-9153), or go to <http://www.NHTSA.gov> or contact Graco:

1-800-345-4109 or www.gracobaby.com

Download from [Www.Somanuals.com](http://www.Somanuals.com), All Manuals Search And Download.

2.3 If You Need Help

Please contact our Customer Service Department with any questions you may have concerning parts, use, or maintenance. When you contact us, please have your product's model and manufactured in (date) ready so that we may help you efficiently. These numbers can be found on a label on the child restraint.

USA: 1-800-345-4109 or www.gracobaby.com

3.0 Useful Information

3.1 Certification

THIS CHILD RESTRAINT CONFORMS to all applicable Federal Motor Vehicle Safety Standards and is certified for use in motor vehicles.

It is certified for use in Aircraft only when used with the built-in harness. When used as a booster without the harness, this restraint is not certified for use in aircraft.

3.2 Child Restraint Useful Life

STOP using child restraint and throw it away after the date **MOLDED** into the child restraint.

Look for the date molded into the seat in the location shown.

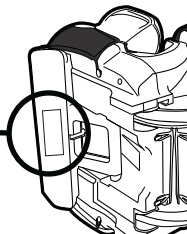

3.3 Second Hand Child Restraint

Graco Children's Products Inc. advises against loaning or passing along a child restraint.

4.0 Features

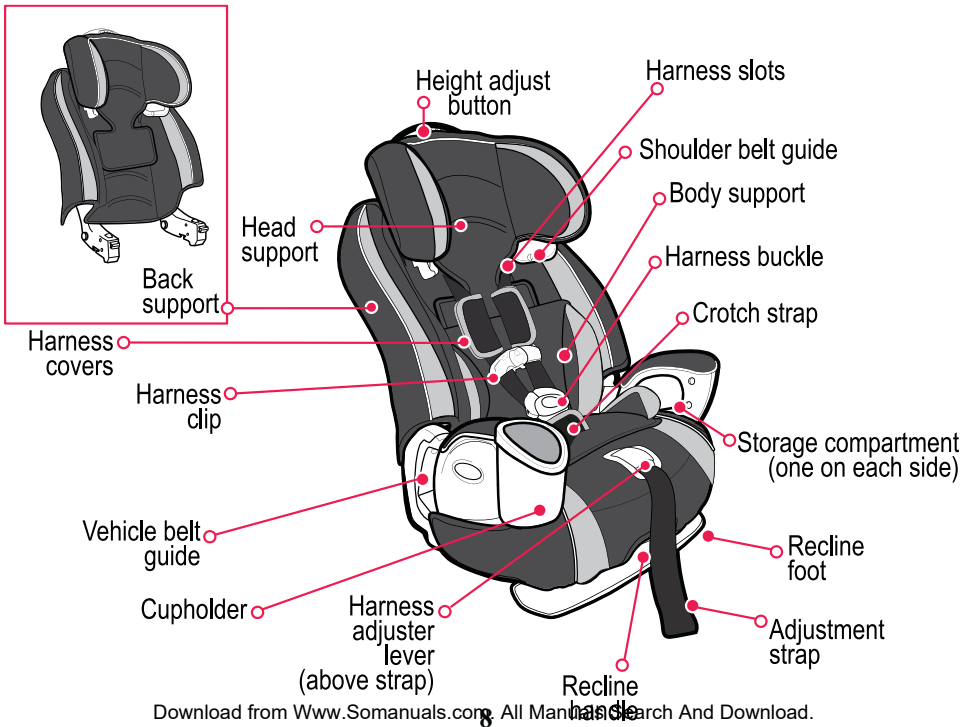

The locking clip is stored on the back of the child restraint. You will need to use it with certain types of vehicle seat belts.

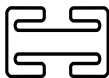

United States Federal Motor Vehicle Safety Standards have defined a new system for installing child restraints in vehicles. The system is called **LATCH** (Lower Anchors and Tethers for Children). **LATCH** may ONLY be used IN PLACE of vehicle belt if vehicle is equipped with **LATCH** anchor points. Please refer to vehicle owners manual for **LATCH** locations in vehicles.

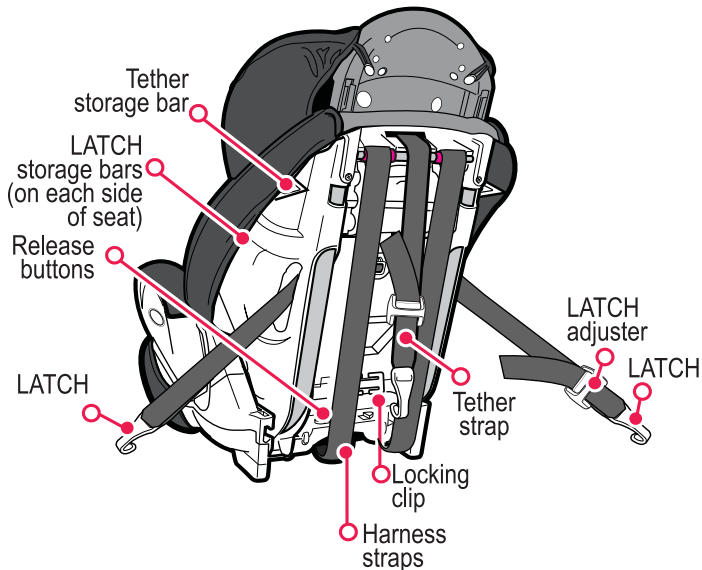

5.0 WARNINGS

- **NO CHILD RESTRAINT CAN GUARANTEE PROTECTION FROM INJURY.**

However, proper use of this child restraint reduces the risk of serious injury or death to your child.

- **DO NOT INSTALL OR USE THIS CHILD RESTRAINT UNTIL YOU READ AND UNDERSTAND THE INSTRUCTIONS IN THIS MANUAL AND IN YOUR VEHICLE OWNER'S MANUAL. DO NOT**

let others install or use the child restraint unless they understand how to use it.

- **FAILURE TO PROPERLY USE THIS CHILD RESTRAINT INCREASES THE RISK OF SERIOUS INJURY OR DEATH IN A SHARP TURN, SUDDEN STOP OR CRASH.**

Your child can be injured in a vehicle even if you are not in a crash. Sudden braking and sharp turns can injure your child if the child restraint is not properly installed or if your child is not properly secured in the child restraint.

- **DO NOT** use locking clip in booster mode.

- According to accident statistics, **CHILDREN ARE SAFER WHEN PROPERLY RESTRAINED IN REAR VEHICLE SEATING POSITIONS, RATHER THAN FRONT SEATING POSITIONS.** For a vehicle with a front passenger air bag, refer to your vehicle owner's manual as well as these instructions for child restraint installation.

- **NEVER LEAVE YOUR CHILD UNATTENDED.**

• **NEVER LEAVE A CHILD RESTRAINT UNSECURED IN YOUR VEHICLE.** An unsecured child restraint can be thrown around and may injure occupants in a sharp turn, sudden stop or crash. Remove it or make sure that it is securely belted in the vehicle. If not using **LATCH** and tether, make sure **LATCH** and tether connectors are properly stored on back of seat.

• **REPLACE THE CHILD RESTRAINT AFTER AN ACCIDENT OF ANY KIND.** An accident can cause damage to the child restraint that you cannot see.

• **DO NOT MODIFY YOUR CHILD RESTRAINT** or use any accessories or parts supplied by other manufacturers.

• **NEVER USE CHILD RESTRAINT IF IT HAS DAMAGED OR MISSING PARTS.** Do not use a cut, frayed or damaged child restraint harness, **LATCH** belt or vehicle seat belt.

• **THE CHILD RESTRAINT CAN BECOME VERY HOT IF LEFT IN THE SUN.** Contact with these parts can burn your child's skin. Always touch the surface of any metal or plastic parts before putting your child in the child restraint.

• **NEVER GIVE THIS CHILD RESTRAINT** to someone else without also giving them this manual.

• **NEVER USE A SECOND-HAND CHILD RESTRAINT** or a child restraint whose history you do not know.

DO NOT USE THIS child restraint without properly assembling it.

6.0 Height and Weight Limitations

⚠ WARNING

FAILURE TO USE CHILD RESTRAINT IN A MANNER APPROPRIATE FOR YOUR CHILD'S SIZE MAY INCREASE THE RISK OF SERIOUS INJURY OR DEATH. Instructions for the use of this child restraint differ greatly depending on the size of your child. Be sure you are using the child restraint in the correct mode and with the correct features for your child.

6.1 WITH Built-In Harness

Your child must meet all requirements:

- Weight: 20 to 70 lbs (mass between 9 and 31.8 kg)
- Height: 27 to 52 inches (69 and 132 cm) in height
- At least one year old and can sit upright unassisted
- The harness straps must be **EVEN** with or just **ABOVE** the child's shoulders.

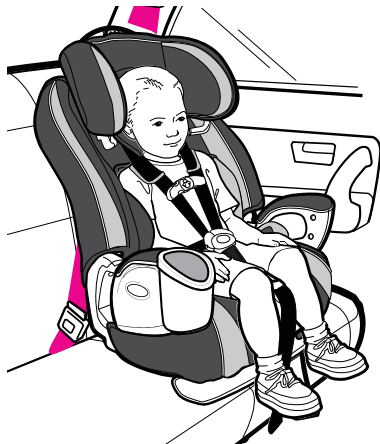

6.2 WITHOUT Built-in Harness

Your child must meet all requirements:

- Weight: 30 to 100 lbs
(mass between 13.6 and 45 kg)
- Height: 38 to 57 inches
(96 and 145 cm) in height
- Approximately 3-10 years of age
- The shoulder belt **MUST** lie across child's shoulder as shown and the lap portion of the belt is positioned low on the child's hips.
- Child's ears are **BELOW** top of head support. If tops of ears are above top of head support, child is too large for seat.

If child is between 30 and 70 lbs (13.6 and 31.8 kg) and shoulders are below the shoulder belt guides, we highly recommend use of the built-in harness for as long as possible (up to 70 lbs (31.8 kg)).



6.3 WITHOUT Back Support

Your child must meet all requirements:

- Weigh between 40 and 120 lbs.
(mass between 18 and 54.4 kg),
- and are between 40 and 57 inches
(101 and 145 cm) in height,
- Approximately 4-10 years of age
- The shoulder belt **MUST** lie across child's shoulder as shown and the lap portion of the belt is positioned low on the child's hips.

When sitting on the booster seat, your child's ears should be below the top of the vehicle seat cushion / head support.

Your Graco booster seat can be used with or without the back support as long as all requirements are met.

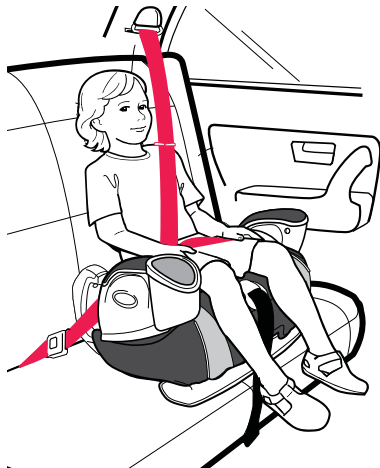

7.0 Choosing an Appropriate Vehicle Seat Location

7.1 Vehicle Seat Location Requirements

⚠ WARNING

IMPROPER PLACEMENT OF THE CHILD RESTRAINT INCREASES THE RISK OF SERIOUS INJURY OR DEATH.

Some seating positions in your vehicle may not be safe for this child restraint. Some vehicles do not have any seating positions that can be used safely with the child restraint. If you are not sure where to place the child restraint in your vehicle, consult your vehicle owner's manual or call Graco Children's Products Inc., 1-800-345-4109.

• **Children are safer when properly restrained in rear vehicle seating positions.** Whenever possible secure the child restraint in the center position of the seat directly behind the front seats. However, this position is sometimes equipped with a lap belt only and cannot be used when this child restraint is used without the built-in harness.



• **The vehicle seat must face forward.** Do not use child restraints on rear-facing or side-facing vehicle seats.



7.2 Vehicle Seat Belt Requirements

WARNING

MANY SEAT BELT SYSTEMS ARE NOT SAFE TO USE WITH THE CHILD RESTRAINT. THE VEHICLE SEAT BELT MUST BE DESIGNED TO HOLD THE CHILD RESTRAINT

TIGHTLY AT ALL TIMES. Pay careful attention to these systems; some of the seat belts that are not safe to use look very much like seat belts that are safe to use. If you are unsure, consult your vehicle owner's manual or call Graco Children's Products Inc., 1-800-345-4109.

7.3 SAFE Vehicle Seat Belt Systems

THE FOLLOWING BELT SYSTEMS CAN BE USED WITH YOUR CHILD RESTRAINT, IF the seat location meets all other requirements of these instructions and those in your vehicle owner's manual. **LATCH** can be used in place of the following vehicle belt systems if your vehicle is equipped with **LATCH** anchor points. Please refer to vehicle owners manual for **LATCH** locations.

7.4 For Built-in Harness Only

- **Lap Belts - Manually Adjusted**

When buckled, the belt is tightened manually by pulling on the excess belt.

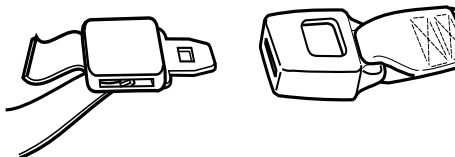

- **Lap Belts with Automatic Locking Retractor (ALR)**

The automatic locking retractor will not permit the lap belt to lengthen once it is buckled. Tighten the belt by feeding the belt back into the retractor while pushing down hard on the child restraint.

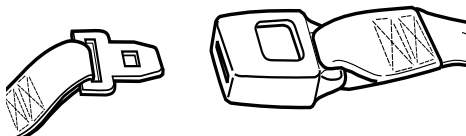

7.5 With OR Without Built-in Harness

- **Combination Lap/Shoulder Belt with Locking Latch Plate**

Once it is buckled, this type of belt has a latchplate that will not allow the lap portion of the belt to loosen. Belt is tightened by pulling hard on the shoulder portion of the vehicle belt while pushing down hard on the child restraint.

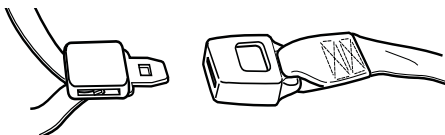

- **Combination Lap/Shoulder Belt with Sliding Latch Plate** This belt has a latchplate that slides freely along the belt.

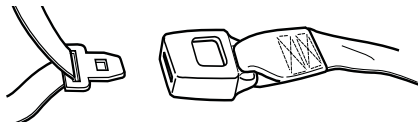

- This belt **MUST** be converted to prevent movement of the lap portion of the belt. You must use the locking clip provided with the child restraint, unless your vehicle's seat belt can be converted in another way as described in your vehicle owner's manual.

When using booster seat WITHOUT the built-in harness, locking clip is **NOT** to be used.

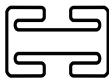

Locking clip

7.6 To Install Locking Clip

1. Tighten the buckled belt by pushing down hard on the child restraint and pulling hard on the shoulder belt.
2. While pushing down on seat, pinch the two straps together behind the buckle tongue. Unbuckle the belt without allowing it to slip.
3. Attach locking clip to lap and shoulder belts as shown ❶.
4. Re buckle belt. Check that lap belt does not move by pulling hard. If belt loosens or lengthens, repeat procedure.

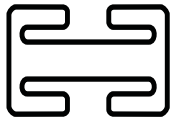

Remove locking clip when not using child restraint. Store under it's tab on the rear of seat.

Test installation to see if child restraint is secure.

If not secure, additional belt tightening may be required:

- Unbuckle vehicle seat belt.
- Hold belts together and remove locking clip.
- Shorten length of lap belt portion slightly by pulling belt through latch plate. Re-attach locking clip.
- Buckle vehicle seat belt. Press child restraint further down into vehicle seat cushion to help buckle vehicle seat belt. Test installation to see if child restraint is secure. If not secure, repeat above steps until secure.

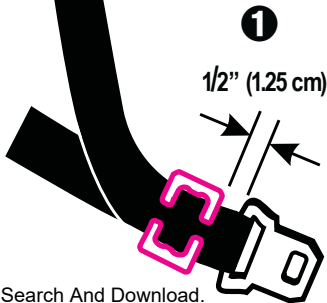

7.7 UNSAFE Vehicle Belt Systems

DO NOT USE ANY OF THE FOLLOWING SYSTEMS TO SECURE THE CHILD RESTRAINT. **LATCH** can be used **IN PLACE OF** the following unsafe belt systems if your vehicle is equipped with **LATCH** anchor points. Please refer to the vehicle owners manual for **LATCH** locations. **NEVER USE** unsafe belt systems.

- **Lap Belts with Emergency Locking Retractor (ELR)**

This lap belt stays loose and can move until it locks in a crash or sudden stop.

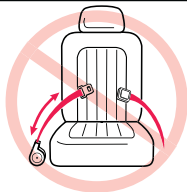

- **Combination Lap/Shoulder Belt with Retractor**

Each strap has a retractor at one end and is attached to the latch plate at the other end.

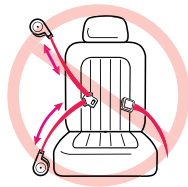

- **Passive Restraint - Lap or Shoulder Belt Mounted on Door**



- **Passive Restraint -
Lap Belt with Motorized Shoulder Belt**

DO NOT use vehicle belts that are attached to the door in any way or that move along a track to automatically surround the passenger when the door is closed.

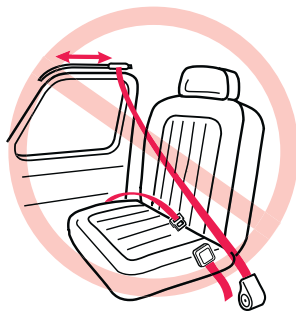

- **Lap Belts Forward of Seat Crease**

Vehicle seat belts located forward of seat crease may not securely hold child restraint. Check vehicle owner's manual or see vehicle dealer for car seat installation requirements.

- *If approved for use with child restraint, install child restraint and check for secure installation by pulling child restraint front to back. If child restraint slides forward, DO NOT use these seat belts.*

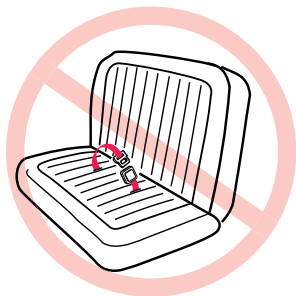

8.0 LATCH

8.1 What is LATCH?



United States Federal Motor Vehicle Safety Standards have defined a new system for installing child restraints in vehicles. The system is called **LATCH**.

LATCH stands for: **L**ower **A**nchors and **T**ethers for **C**hildren.

LATCH in the vehicle consists of a top tether anchor point and two lower anchor points.

Some vehicle owner manuals use the term **ISOFIX** to identify the new child restraint anchor system. This child restraint with **LATCH** can also be used in vehicle seating positions equipped with **ISOFIX**.

Newer vehicles have one or more seating positions with **LATCH** anchor points. If vehicle is equipped with **LATCH**, the vehicle lower anchor points may be visible at the vehicle seat crease. If not visible, they may be marked with this symbol .

CHECK vehicle owner's manual for vehicle top tether anchor locations. They may be identified using one of the anchor symbols as shown  .

ONLY use **LATCH** on a child restraint in a seating position recommended by vehicle manufacturer.

NOTE: Some vehicle manufacturers have lower maximum weight ratings for **LATCH** anchors, so you must consult your vehicle owner's manual or call the vehicle manufacturer to confirm the limits on your vehicle's **LATCH** anchors.

Use vehicle belt (not **LATCH** connectors) for installations with children weighing more than 48 pounds (21.7 kg).

See your vehicle owner's manual for exact locations, anchor identification, and requirements for use with a child restraint.

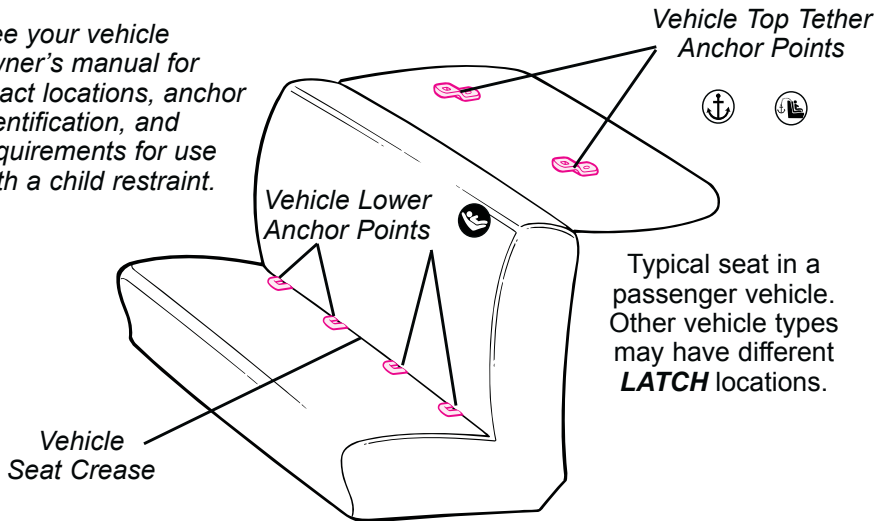

8.2 LATCH System

LATCH consists of a permanently attached lower anchor belt and a top tether strap.

ONLY use **LATCH** in a seating position recommended by vehicle manufacturer.

LATCH lower vehicle anchor points are defined as 11 inches from the center of one **LATCH** anchor to the center of another **LATCH** anchor. If allowed by your Vehicle Owners Manual, the center seating position may be used if the anchor spacing is 11" or greater.

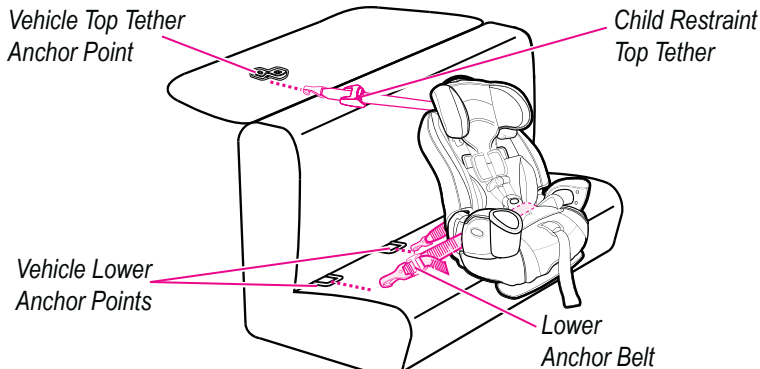

9.0 Using Child Restraint WITH Built-in Harness

⚠ WARNING

FAILURE TO PROPERLY ADJUST THE HARNESS STRAPS FOR YOUR CHILD INCREASES THE RISK OF SERIOUS INJURY OR DEATH IN THE EVENT OF A SHARP TURN,

SUDDEN STOP OR CRASH. Snugly adjust the belts provided with this child restraint around your child. A snug strap should not allow any slack. It lies in a relatively straight line without sagging. It does not press on the child's flesh or push the child's body into an unnatural position.

1. Loosen the harness straps by lifting the harness adjuster lever **1** at front of seat near the adjustment strap and pulling the straps toward you **2**.

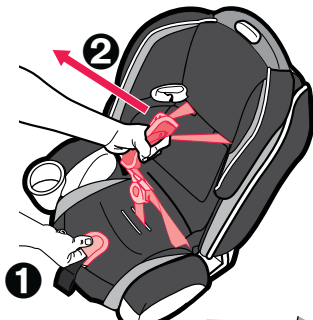

2. Open harness clip **3**.

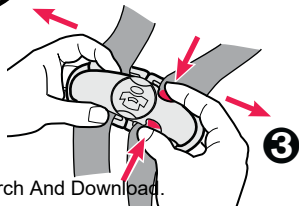

3. Unbuckle harness straps ④.

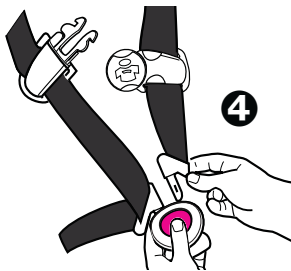

4. **Check the crotch strap:** Choose the position that is closest to but not under your child.

To change crotch strap position, push crotch belt up through the bottom ⑤ of the child restraint and grab it from the top to pull out ⑥.

Reinsert crotch strap in the desired position. Make sure crotch strap is not twisted when reinserting into slot. Pull up on it to make sure it is secure.

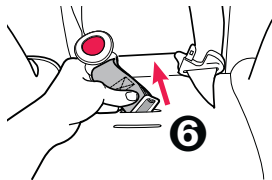
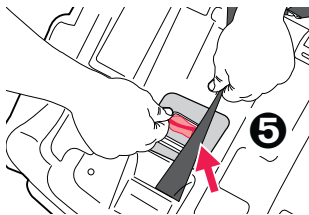

5. Pull on harness to make sure it is secure 7.

REMEMBER to check the shoulder straps and crotch strap position as your child grows and reposition them depending on your child's size. The harness straps must be even with or just above the shoulders.

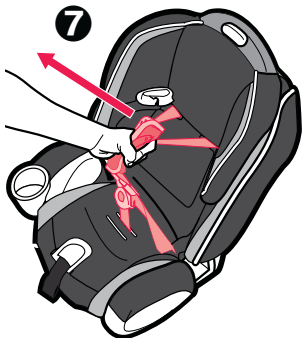

10.0 Securing the Child Restraint in Your Vehicle

WARNING

FAILURE TO PROPERLY SECURE THE CHILD RESTRAINT IN THE VEHICLE INCREASES THE CHILD'S RISK OF SERIOUS INJURY OR DEATH IN THE EVENT OF A SHARP

TURN, SUDDEN STOP OR CRASH. Carefully follow these instructions and those in your vehicle owner's manual to be sure your child restraint is properly positioned and held tightly at all times.

10.1 Using a Child Restraint WITH a Built-in Harness

10.2 With a Vehicle Lap or Lap/shoulder Belt:

Lower anchors must be stored when using vehicle belt.

See Section 20.1, Storing LATCH, page 55.

1. Place the child restraint firmly against the back of a forward-facing vehicle seat.
2. Thread the seat belt through the belt slot openings:

For Lap/Shoulder belt

For Lap-only belt

3. Buckle the vehicle belt. The vehicle belt should not be twisted.

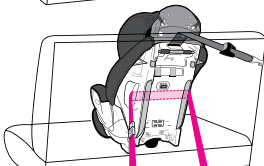
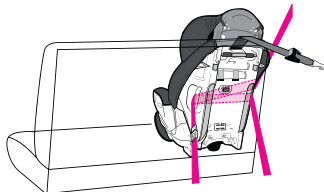

4. Tighten vehicle seat belt

Push down hard with your knee or free hand in the middle of the child restraint **1**. Then pull and tighten the vehicle belt.

For more information on how to tighten the belt for your seat belt system, see Section 7.0 Choosing an Appropriate Vehicle Seat Location, p.15, or your vehicle owner's manual.

5. If a vehicle top tether anchor is available, secure the tether to hold seat in place.

See Section 20.0 Using the Tether, page 54.

When not using the tether, hook it on the tether storage bar on the rear of the seat, see page 55.

6. Safety Check for Secure Installation

Perform this test every time you drive with your child.

Twist and pull child restraint forward and to both sides to make sure the vehicle belt does not lengthen or loosen and the child restraint does not easily move. The child restraint should not move side to side or forward more than 1 inch (2.5 cm). **2**. If child restraint is loose or not secure, repeat procedure

OR find another location for the child restraint, see Section 7.0 Choosing an Appropriate Vehicle Seat Location, p. 15.

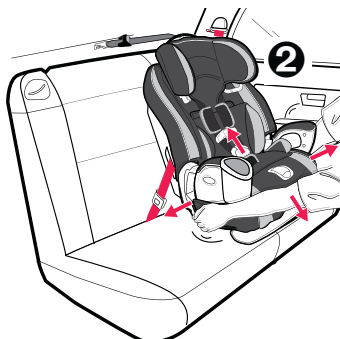
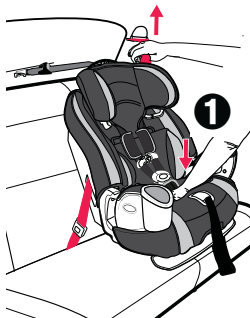

10.3 With LATCH

Use vehicle belt (not **LATCH** connectors) for installations with children weighing more than 48 pounds (21.7 kg). NOTE: Some vehicle manufacturers have lower maximum weight ratings for **LATCH** anchors, so you must consult your vehicle owner's manual or call the vehicle manufacturer to confirm the limits on your vehicle's **LATCH** anchors.

1. Unhook **LATCH** from storage bars on the sides of the seat. For ease of installation, extend **LATCH** to its maximum length.
2. Place the child restraint firmly against the back of a forward-facing vehicle seat.
3. Hook **LATCH Connectors** to vehicle lower anchors **1**. Pull firmly on Connectors to be sure they are attached. **Belt must lay flat and not be twisted.**
4. Tighten **LATCH** by pushing down hard on child restraint and pulling the adjustment belt **2**.
5. If you need to remove **LATCH** to readjust, push button on **LATCH** buckle **3** to loosen strap.

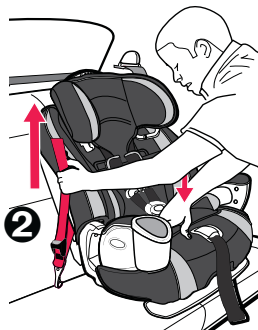
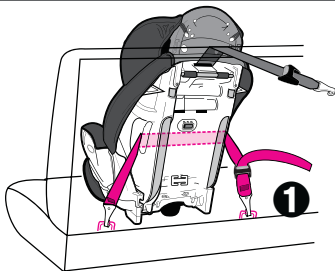

6. **NEVER** put two **LATCH** connectors on one vehicle **LATCH** anchor unless specifically allowed by the vehicle manufacturer ④.



7. All **LATCH** seating positions have **tether anchors**. Secure the top of the seat using the tether strap. See Section 20.0 Using the Tether, page 54.

8. Safety Check for Secure Installation

Perform this test every time you drive with your child.

Twist and pull child restraint forward and to both sides to make sure the **LATCH** belt does not lengthen or loosen and the child restraint does not easily move. The child restraint should not move side to side or forward more than 1 inch (2.5 cm). ⑤. If child restraint is loose or not secure, repeat procedure **OR** find another location for the child restraint, see Section 7.0 Choosing an Appropriate Vehicle Seat Location, p. 15.



11.0 Securing Your Child in the Child Restraint

⚠ WARNING

FAILURE TO PROPERLY SECURE YOUR CHILD IN THE CHILD RESTRAINT INCREASES THE RISK OF SERIOUS INJURY OR DEATH IN THE EVENT OF A SHARP TURN, SUDDEN STOP

OR CRASH. In a crash, the child restraint provides NO protection for your child unless the harness straps are properly secured. Follow these instructions carefully to properly secure your child.

- **ADJUST THE HARNESS SYSTEM SNUGLY EVERY TIME** you place your child in the child restraint.

- Avoid bulky clothing.

1. Place child in child restraint with child's back flat against back of child restraint.

2. Place harness straps over child's shoulders and insert tongues into buckle until they click into place **1**.

CHECK that straps are not twisted.

CHECK that harness is securely latched by pulling up on straps.

DO NOT use child restraint if harness does not latch.



3. Fasten harness clip ②. Position harness clip at middle of child's chest, level with armpits.

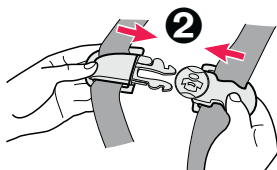

4. Tighten the harness straps by pulling the adjustment strap on the front of the seat ③.



5. The harness straps must be even with or just above the shoulders ④.

To adjust head support/harness strap height see *page 35*.

6. Make sure straps are flat and snug against child's shoulders and thighs.

You should not be able to pinch ⑤ the harness straps. A snug strap should not allow any slack. It lies in a relatively straight line without sagging. It does not press on the child's flesh or push the child's body into an unnatural position.

CHECK that child's ears are **BELOW** top of head support. If tops of ears are above top of head support, child is too large for harnessed use.



12.0 Adjusting Head Support/Harness Straps

When using with built-in harness always use one of the bottom 4 height positions.

BEFORE adjusting the head support height, have your child lean forward slightly.

Squeeze the red adjustment handle ① on top of seat and pull head support up until it snaps into one of the bottom 4 height positions ②.

To lower, squeeze red adjustment handle and push down.

CHECK to make sure it is securely snapped into one of the bottom 4 height positions by pulling up on head support.

The harness straps must be even with or just above the shoulders as shown by dotted line ③.

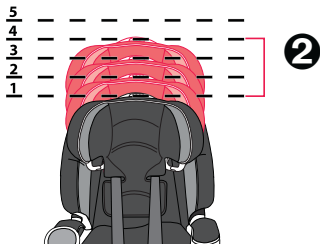
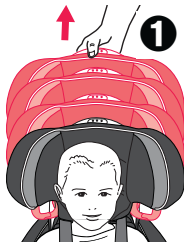

13.0 Check Harness System

⚠ WARNING

To prevent serious injury or death:

- Keep harness straps snug and positioned on shoulders with harness clip at arm pit level.
- Do not use strap covers, blankets, cushions, or padding under harness straps or child unless provided by Graco.
- Child should be dressed in clothing that does not interfere with buckling the harness.

- **20 to 70 lbs (mass between 9 and 31.8 kg)**
and at least one year old.
Harness straps/head support must be at or just above shoulders.

To adjust head support/harness strap height see
page 35.

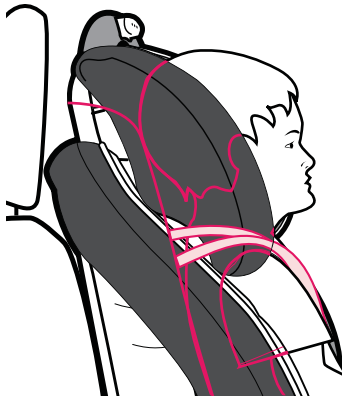

14.0 Harness Removal

To use without built in harness:

1. Remove harness straps.

Open harness clip and harness buckle ❶.

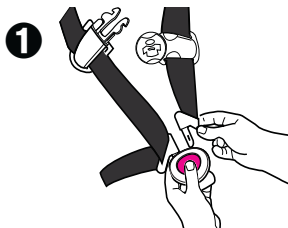

2. Face the rear of the seat and remove the belt straps from metal junction plate ❷ as shown .

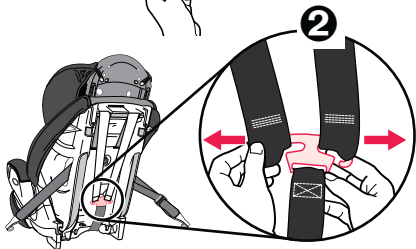

3. Remove crotch strap by pushing the strap retainer ❸ on bottom of seat, up through slot.

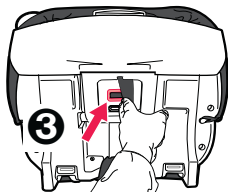

4. Grab the crotch strap buckle and pull it completely out **4**.

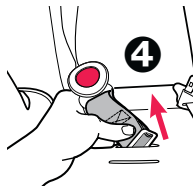

5. Pull on the adjustment strap **5** on the front of the seat to lock the metal junction plate into place.

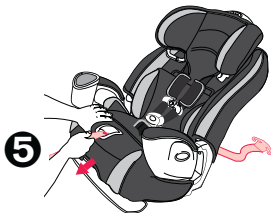

6. Grab hold of the shoulder straps **6** and pull them out of their slots on the seat pad.
Remove body support and crotch pad.

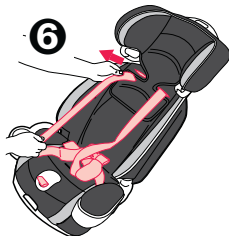

7. On the rear of the seat, detach 2 lower seat pad elastic straps from hooks as shown in ⑦.

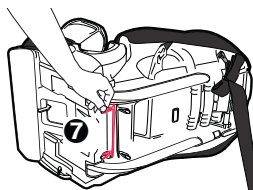

8. Also detach the elastic straps that are threaded through the vehicle belt guides on the sides of the seat as shown in ⑧. Repeat on other side.

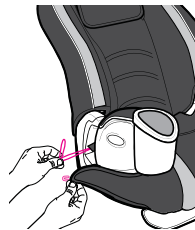
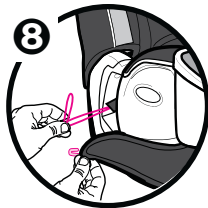

9. Pull the seat pad out of the way to reveal the red buttons as shown in the seating area ⑨. Slide the buttons to release the back support from the base and lower it into a flat position. Hold the back support to avoid it from falling back and hitting something.

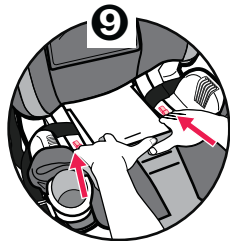
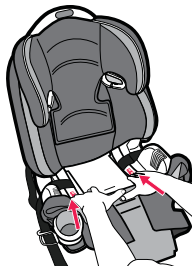

10. Remove harness straps from arms as shown in 10.

Store the body support, harness covers, crotch pad cover and harness straps in safe place for future use.

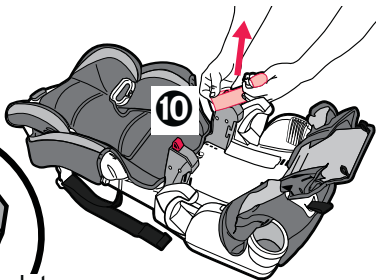
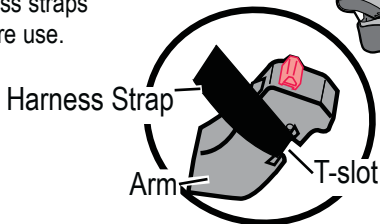

11. Move seat pad fabric out of the way then raise seat back so that both arms LOCK into the gutters 11.

You should hear a CLICK when the arms lock into the gutters.

MAKE sure to keep the gutters clear of any obstructions.

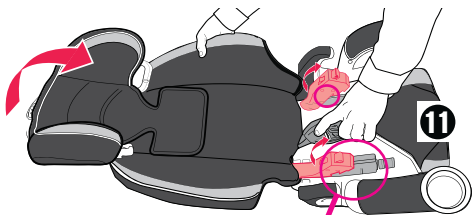

**KEEP
GUTTERS CLEAR**

12. Tuck seat pad in between the gap of the back support and seat area of the booster seat to allow 2 elastic straps to show at the rear of the seat.



13. Attach 2 seat pad elastic straps onto the hooks on the rear of the child restraint as shown in 12.

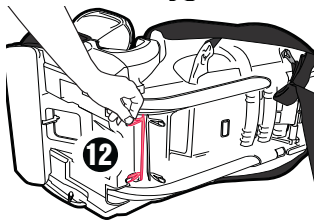

14. Pull elastic strap on the seat pad through the vehicle belt guide on side of seat and attach to hook as shown. Repeat on other side 13.

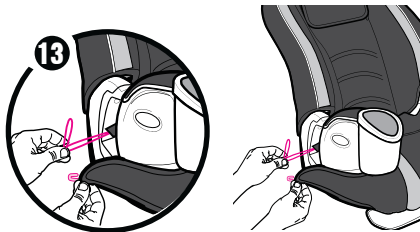

Reverse instructions to reinstall harness.
See Section 9.0, page 25-27 for the correct path for the harness.

15.0 Using Your Child Restraint WITHOUT Built-in Harness

⚠ WARNING

FAILURE TO PROPERLY SECURE YOUR CHILD IN THE CHILD RESTRAINT INCREASES THE RISK OF SERIOUS INJURY OR DEATH IN THE EVENT OF A SHARP TURN, SUDDEN STOP OR

CRASH. In a crash, the child restraint provides NO protection for your child unless the vehicle lap/shoulder belt is properly secured. Follow these instructions carefully to properly secure your child.

WARNING: Use only the vehicle lap and shoulder belt system when restraining the child in the booster seat. **LATCH** will not secure your child in the booster seat ❶.

Vehicle belts **MUST** lay flat against child and **MUST** not be twisted.

NEVER use a vehicle lap-only belt across front of child ❷.



INCORRECT

DO NOT use shoulder belt loose or positioned under arm ❸.

DO NOT place shoulder belt behind child's back ❹.



INCORRECT



INCORRECT

Lap portion of lap/shoulder belt **MUST** be low and snug on hips, just touching thighs.

DO NOT allow child to slide down in booster seat ❺.

If child will not keep vehicle belt properly positioned, **DO NOT** use this booster seat. Use a different child restraint system.

DO NOT position vehicle belt over top of the armrests ❻.



INCORRECT



INCORRECT

Vehicle seat headrest should not create a gap between vehicle seat and booster seat
⑦. The front of booster seat **MUST NOT** hang over front of vehicle seat ⑧.



INCORRECT



INCORRECT

16.0 Securing Child & Booster Seat in Vehicle

⚠ WARNING

Use only the vehicle lap and shoulder belt system when restraining the child in the booster seat.

1. Place booster seat firmly against the back of a forward-facing vehicle seat equipped with a lap/shoulder belt only.

2. Place child in booster seat with child's back flat against back of booster seat.

3. Position lap/shoulder belt through shoulder belt guide **1** not underneath shoulder belt guide **2**. Belt should pass over vehicle belt guide **3**. Fasten buckle and pull up on the shoulder belt to tighten.

4. If shoulder belt lies across child's neck, head or face, redirect belt over shoulder by adjusting the head support setting, *See page 46, Adjusting Head Support in Booster Mode.*

5. The shoulder belt **MUST** lie across child's shoulders in red zone as shown **4**.

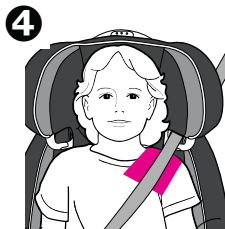

17.0 Adjusting Head Support in Booster Mode

BEFORE adjusting the head support height, have your child lean forward slightly.

Squeeze the red adjustment handle **1** on top of seat and pull back support up until it snaps into one of the 5 height positions **2**.

To lower, squeeze red adjustment handle and push down.

CHECK to make sure it is securely snapped into one of the 5 height positions by pulling up on head support.

The shoulder belt guides must be even with or just above the shoulders as shown by dotted line **3**.

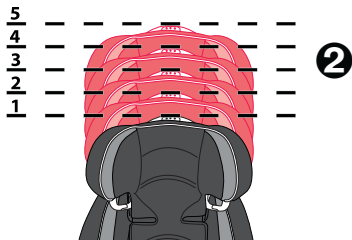
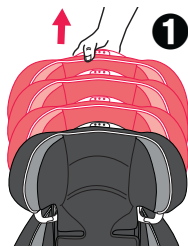

18.0 Removing Back Support

To use booster seat WITHOUT back support, remove harness straps if attached (see section 14.0 *Harness Removal*, p.37-41) then continue with the following steps:

1. Detach 2 lower elastic straps from rear of seat as shown ❶.

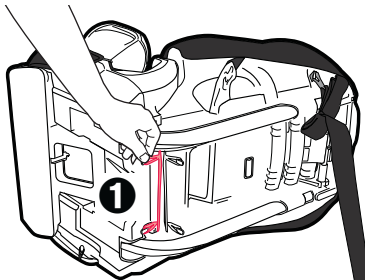

2. Detach elastic strap from the hooks on the seat pad as shown. Repeat on other side ❷.

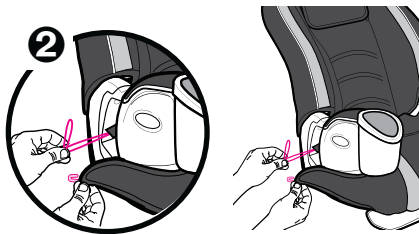

3. Pull the seat pad out of the way to reveal red buttons as shown in ③. Slide the buttons to release the back support from the base and lower it into a flat position.

When removing back support, you must support the back support when sliding the red buttons that disengage the back support from the base. Make sure all hands, fingers and other objects are not behind the back support when removing it.

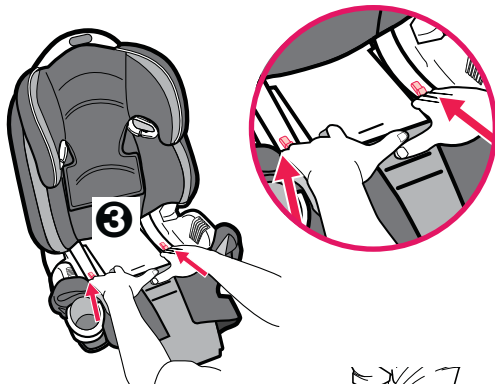

4. Move seat pad fabric out of the way and squeeze red buttons together to release back support from seat. Pull seat and back support apart ④.

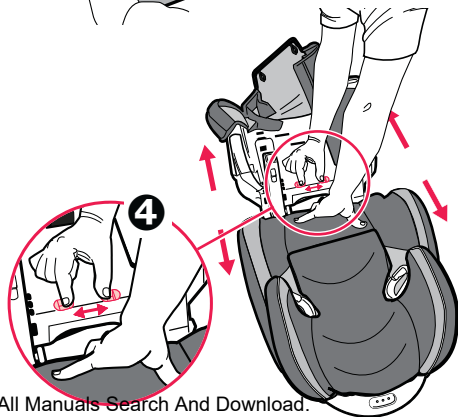

5. Once back support is separated **5**, store back support with all the harness straps, head support, body support and crotch pad cover in safe place.

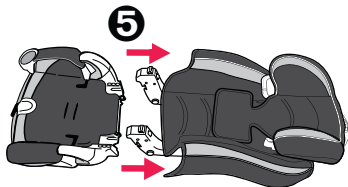

6. Reattach the elastic straps at the back of the seat **6** and through the vehicle belt guide on the sides of seat **7** as shown.

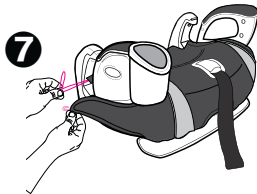
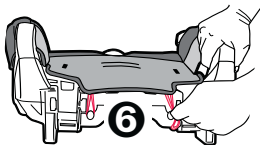

7. Seat is ready to install.

To reattach back support if needed, reverse steps from p. 51 to p. 49.

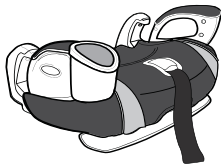

19.0 Securing Child in Vehicle with Shoulder Belt Positioning Clip

The shoulder belt **MUST** lie across child's shoulders in red zone as shown ❶.

If shoulder belt lies outside this zone, the shoulder belt positioning clip **MUST** be used.

To attach clip to booster seat:

1. Insert the loop end of strap through the slot on rear of seat exactly where shown ❷.

There is a slot on each side of booster seat, the shoulder belt positioning clip **MUST** be attached through the slot closest to where the vehicle shoulder belt lies across the child.

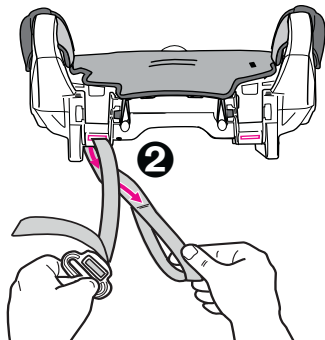
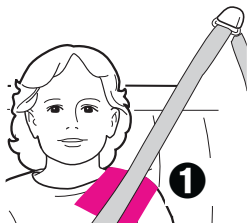

2. Pass the clip and the strap through the loop end ③ as shown and pull strap up.

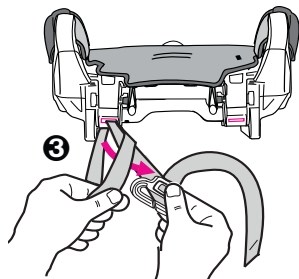

3. NOTE: Free end of strap ④ should face front of seat.

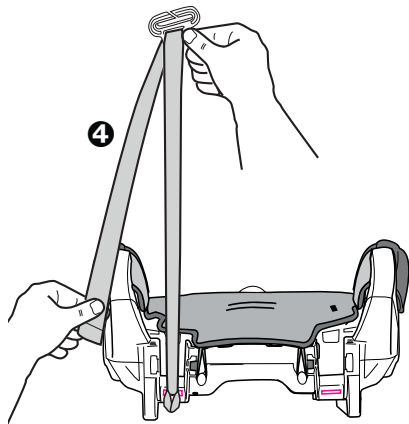

4. Slide the vehicle shoulder belt onto the clip as shown ⑤ and pull free end of strap down ⑥ to tighten clip against the child's shoulder.

The lap portion **MUST** pass through the vehicle belt guide and be positioned low on the hips. The belt **MUST NOT** be twisted.

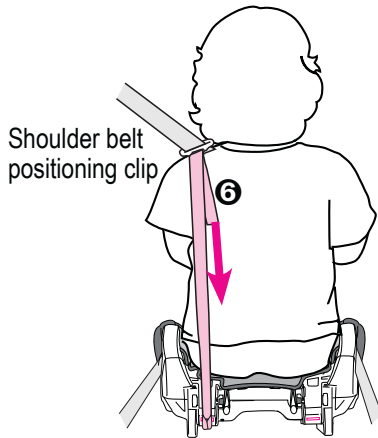
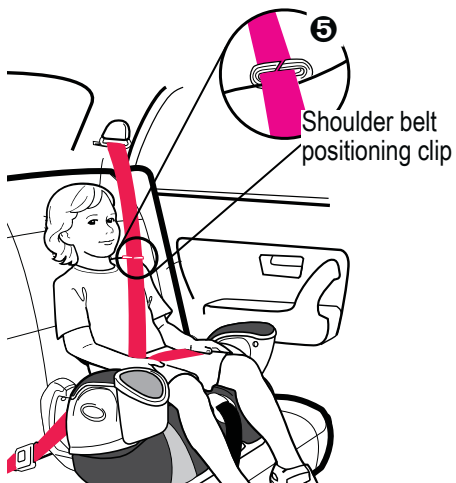

**REAR VIEW OF CHILD
SITTING IN SEAT**

5. Lap portion of lap/shoulder belt **MUST** be low and snug on hips, just touching thighs.

DO NOT allow child to slide down in booster seat ⑦.

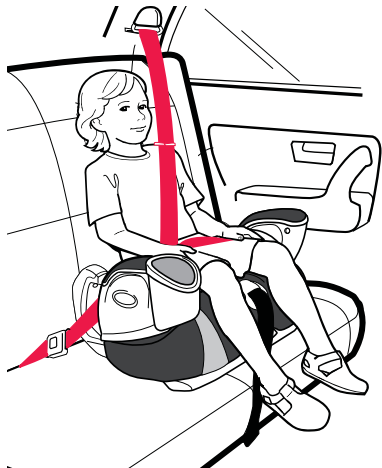

CORRECT



INCORRECT

20.0 Using the Tether

All **LATCH** seating positions have tether anchors. Always use tether if a vehicle tether anchor is available, check your vehicle owner's manual for the tether anchor location(s). If your vehicle is not equipped with a tether anchor, it may be possible to install one. Contact your vehicle dealership for the proper anchor location and installation.

You may purchase tether anchor parts kit by calling Graco Customer Service at 1-800-345-4109.

1. Check that tether is securely attached to child restraint.
2. Fasten tether clip to anchor point ❶.
3. Tighten adjustment belt to remove any slack ❷.
4. To loosen, push button while pulling on the belt as shown ❸.

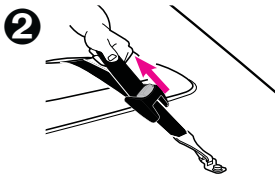
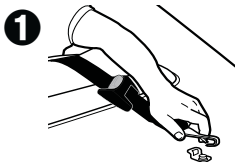

20.1 Storing Lower Anchors and Tether (LATCH)

1. For ease of storing, extend **LATCH** to its maximum length.

2. Locate the storage bars on back of child restraint **1**.

3. Fasten ends of tether and **lower anchors** onto their respective storage bars as shown **2**.

4. Tether and **lower anchors** storage should look like this when complete **2**.

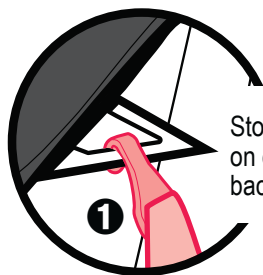

Storage bars located on each side at the back of the seat

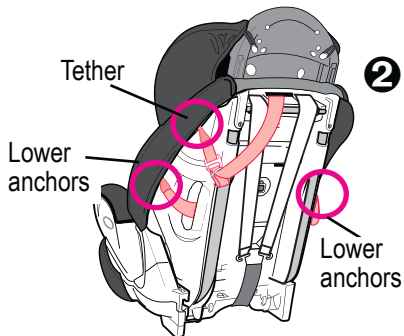

21.0 Airplane Use

This restraint is certified for use in Motor Vehicles.

It is certified for use in Aircraft **ONLY** when used with the built-in harness.

When used as a booster **WITHOUT** the harness, this restraint is NOT CERTIFIED for aircraft use because aircraft seats do not have a shoulder belt.

Important points to remember:

1. Airlines have some restrictions about the use of child restraints.
2. Install your car seat on an airplane in the same way it is installed in an automobile with a lap belt (see Section 10.1, Using Child Restraint WITH Built-in Harness, p. 28).
3. Check that the airplane seat belt holds the child restraint securely in place at all times.

22.0 Accessories (on certain models ONLY)

22.1 Body Support & Harness Covers

⚠ WARNING

To prevent ejection in sudden stop or crash:

- Never allow body support to bunch or fold behind child.
- Make sure that harness covers do not interfere with placement of the chest clip at armpit level.
- Body support is not to be used by children over 35lbs.

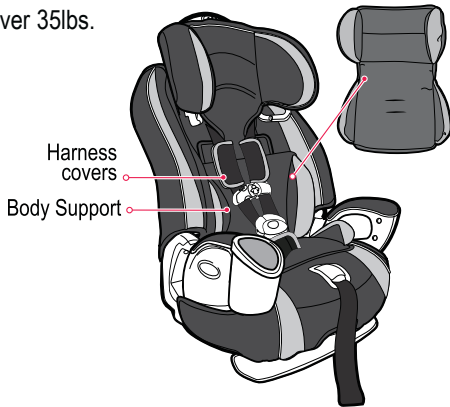

23.0 Recline Foot

Your child restraint has 3 recline positions: adjust recline foot before installing child restraint.

1. To recline seat, pull recline handle out **1** and tilt seat back **2** to extend foot as shown **3**.

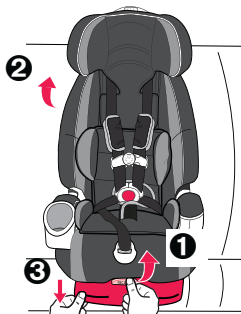

2. To set seat to upright position, pull recline handle out **4** and tilt seat forward **5** to retract foot **6**.

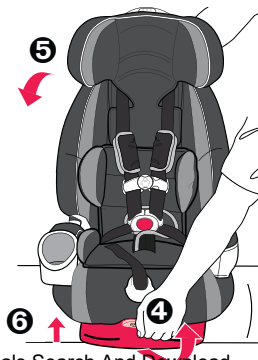

24.0 Care and Maintenance

- Continuous use of child restraint may cause damage to vehicle seat. Use a child restraint mat, towel or thin blanket to protect upholstery.
- Metal and plastic parts: clean with mild soap and cool water. No bleach or detergents.
- Harness straps and **LATCH** straps: spot clean with damp sponge. Do not immerse the straps in water. Doing so may weaken the straps.
- Buckle should fasten with a “click”, if not, rinse buckle with warm water. **DO NOT USE SOAPS or LUBRICANTS.** **DO NOT** use household detergents. Never lubricate buckle.
- If buckle or harness adjuster sticks or will not remain tight, check for foreign objects such as food, dirt, etc. Remove objects with tweezers and/or clean with a cotton swab. If you cannot get the harness to remain tight with the buckle securely locked, do not use this child restraint.

25.0 To Remove Head Support and Seat Covers

HEAD SUPPORT COVER: clean with a damp sponge using mild soap and cool water. If necessary, cover may be removed for cleaning.

1. Remove harness and crotch straps (see Section 14.0, Harness Removal, p.37-41).
2. Remove elastic loops from head support as indicated in ❶.
3. Remove head support cover as shown.
4. Machine wash cover in cold water on delicate cycle and drip-dry. **DO NOT USE BLEACH.**
5. To put the head support cover back on, reverse preceding instructions.

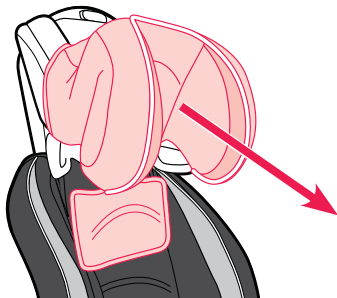
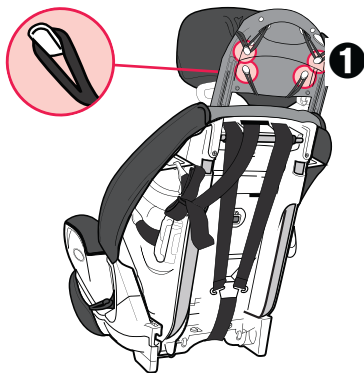

SEAT COVER: clean with a damp sponge using mild soap and cool water. If necessary, cover may be removed for cleaning.

1. Remove harness and crotch straps (see Section 14.0, Harness Removal, p.37-41).
2. Remove elastic loops from seat as indicated in ②.
3. Remove seat cover as shown.
4. Machine wash cover in cold water on delicate cycle and drip-dry. **DO NOT USE BLEACH.**
5. To put the seat cover back on, reverse preceding instructions.

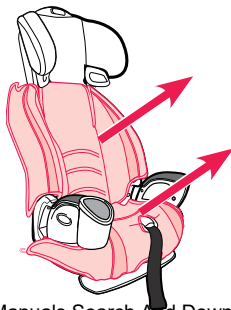
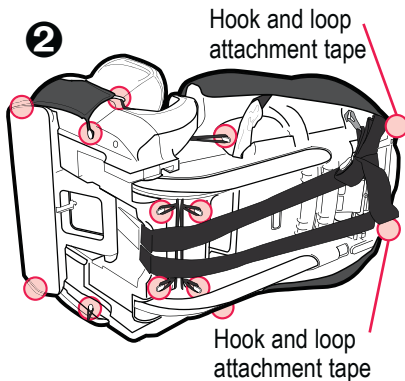

26.0 Replacement Parts, Warranty and Owner's Manual Storage

To purchase parts or accessories or for warranty information in the United States, please contact us at the following:

www.gracobaby.com

or

1-800-345-4109

Your Owner's Manual can be stored on the bottom of the seat inside the slot in the footrest as shown.

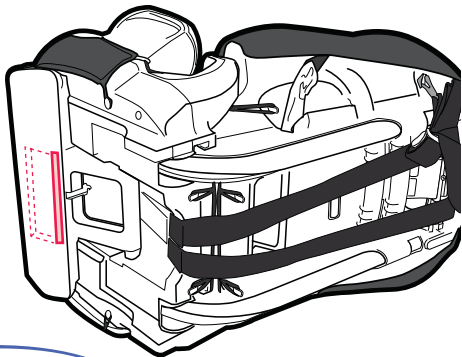

Free Manuals Download Website

<http://myh66.com>

<http://usermanuals.us>

<http://www.somanuals.com>

<http://www.4manuals.cc>

<http://www.manual-lib.com>

<http://www.404manual.com>

<http://www.luxmanual.com>

<http://aubethermostatmanual.com>

Golf course search by state

<http://golfingnear.com>

Email search by domain

<http://emailbydomain.com>

Auto manuals search

<http://auto.somanuals.com>

TV manuals search

<http://tv.somanuals.com>