

3 l
Art. 867

5 l
Art. 869

5 l
Art. 875

5 l
Art. 879 / 880

D Gebrauchsanweisung

Drucksprüher

GB Operating Instructions

Pressure Sprayer

F Mode d'emploi

Pulvérisateur à pression préalable / Pulvérisateur

NL Gebruiksaanwijzing

Drukspuit

S Bruksanvisning

Tryckspruta

I Istruzioni per l'uso

Irroratore a pressione

E Manual de instrucciones

Pulverizador a presión

P Instruções de utilização

Pulverizador de Pressão

DK Brugsanvisning

Tryksprøjte

GARDENA Pressure Sprayer

Welcome to the garden of GARDENA...



Please read these operating instructions carefully and observe the notes given. Use these operating instructions to familiarise yourself with the Pressure Sprayer, its proper use and the notes on safety.



For safety reasons, children and young people under 16 as well as anyone not familiar with these operating instructions should not use the Pressure Sprayer.

→ Please keep these operating instructions in a safe place.

Contents

1. Where to Use Your GARDENA Pressure Sprayer	10
2. For Your Safety	11
3. Assembly	12
4. Operation	13
5. Cleaning	15
6. Trouble-Shooting	15
7. Storage	16
8. Accessories	16
9. Technical data	16
10. Service	16

1. Where to Use Your GARDENA Pressure Sprayer

Intended purpose

The GARDENA Pressure Sprayer is intended for distributing solvent-free liquid pesticides ¹⁾, herbicides ¹⁾, fertilisers ¹⁾, window cleaners ¹⁾, and car wax ¹⁾ in domestic gardens and allotments. It must not be used in public places, parks, sport arenas, or in agriculture or forestry.

Compliance with the operating instructions provided by the manufacturer is a prerequisite for using the Pressure Sprayer correctly.

1) In accordance with the laws governing the use of pesticides and detergents, only authorised substances may be used (authorised specialist shop).

Caution!



Due to the risk of physical injury, the GARDENA Pressure Sprayer must not be used for spraying substances other than those specified by GARDENA. Do not use your Pressure Sprayer for spraying acids, disinfectants or water-proofing agents.

We recommend that you only use pesticides approved by the BBA (German Federal Biological Research Centre for Agriculture and Forestry). To our knowledge at the time of manufacturing the unit, the pesticides approved by the BBA will not damage the materials used to construct the Pressure Sprayer.

When spraying insecticides, herbicides and fungicides or other liquid plant protection products, you must comply with all special precautionary measures specified by the manufacturer of the product you are using.

2. For Your Safety

Danger of physical injuries:



- Never open the Pressure Sprayer or unscrew the nozzle when the Pressure Sprayer is still pressurised.
- To prevent injury, never connect the Pressure Sprayer to an air-compressor.
- Before pulling out the safety valve, the sprayer always has to be placed vertically.
- Before opening the sprayer, always release pressure completely by pulling out the safety valve.

Cleaning:



- Release the pressure after each use (ensuring that the Pressure Sprayer is always vertical), empty the container, clean it carefully and rinse with clear water. Then leave the pressure sprayer open and allow it to dry.

Do not dispose of residual fluids in the sewerage system (→ local disposal systems).

- Always clean the Pressure Sprayer before using a different product to avoid chemical reactions.

For cleaning the valves, the spray pipe and nozzle, operate the unit with clear water (if necessary, by adding some washing-up liquid).

- To prevent reactions with the products you are using, never use aggressive cleaning agents that contain solvent or petrol.
- When there is dirt on the container cap or the container, clean the container carefully around the thread and the thread O-ring.

Take care not to mix up the tanks and tank caps if you are using several Pressure Sprayers at the same time.

Operation:

- Inspect the Pressure Sprayer visually before each use.

Never leave your Pressure Sprayer unattended or for long periods when full and pressurised.

- Keep the unit out of the reach of children.

You are responsible for the safety of others.

- Operate the safety valve only when the sprayer is placed vertically.
- Keep your Pressure Sprayer away from heat sources and hot environments.

We recommend that you have your Pressure Sprayer thoroughly inspected (preferably at a GARDENA Service Centre) after using it for 5 years.

Storage:

Before storing, loosen the tank cap and always empty your Pressure Sprayer completely (also after cleaning with water). Store away from frost.

- If you use the permanent lock pay attention that you work very carefully. Never store your pressure sprayer with permanent lock.

3. Assembly

3.1. General Assembly Instructions for all Pressure Sprayers (Art. No. 867/869/875/879/880)

Mounting the spray tube in the hand valve:

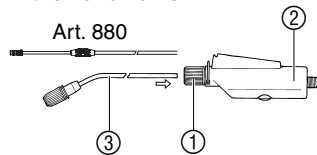

1. Unscrew the union nut ① on the hand valve ②.
2. Push the spray tube ③ all the way into the hand valve ②.
3. Tighten the union nut ① on the hand valve ② by hand (do not use pliers).

The sprayer tube of art. 880 is telescopic (min. / max. sprayer tube length 60 / 100 mm).

Attaching the spray hose to the hand valve:

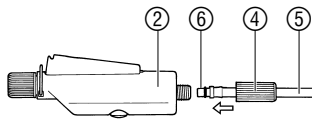

1. Push the long union nut ④ over the spray hose ⑤.
2. Push the spray hose ⑤ with connection nipple ⑥ into the hand valve ②.
3. Tighten the long union nut ④ on the hand valve ② by hand (do not use pliers).

3.2. Assembly Instructions for Pressure Sprayer Art. No. 869

Installing the filter and suction pipe:

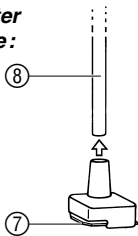

1. Shut the filter ⑦ and press firmly into the suction pipe ⑧.
2. Guide the suction pipe ⑧ through the eyelet at the pump tube ⑨ and press firmly into the opening in the container cap.

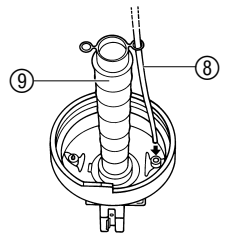

Attaching the spray hose to the container cap:

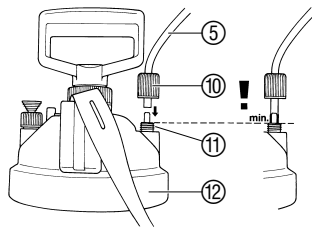

1. Push the short union nut ⑩ over the spray hose ⑤.
2. Push on the spray hose ⑤ so that it covers at least the beginning of the thread ⑪.
3. Screw the short union nut ⑩ onto the container cap ⑫ and tighten by hand (do not use pliers).

Attaching the shoulder strap:

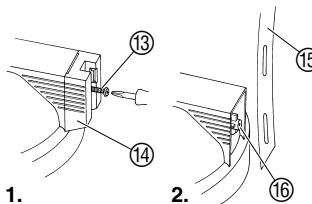

1. Unscrew the screw ⑬ using a screwdriver and remove the spray tube holder ⑭.
2. Put the shoulder strap ⑮ with the elongated hole over the plastic tube ⑯.
3. Reattach the spray tube holder ⑭ and screw in the screw ⑬ using a screwdriver.

1.

2.

3.3. Assembly Instructions for Pressure Sprayer Art. No. 875 / 879 / 880

Attaching the spray hose to the container cap:

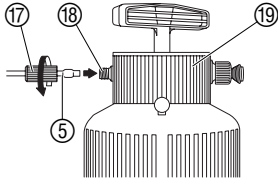

1. Push the short union nut ⑰ over the spray hose ⑤.
2. Push on the spray hose ⑤ so that it covers at least the beginning of the thread ⑱.
3. Screw the short union nut ⑰ onto the container cap ⑲ and tighten by hand (do not use pliers).

Attaching the shoulder strap:

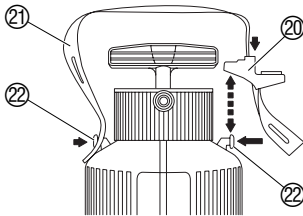

1. Remove the spray tube holder ⑳ from above (direction of the arrow).
2. Guide the shoulder strap ㉑ through the elongated hole of the spray tube holder ⑳ and attach it into the holder ㉒ of the container.
3. Press the spray tube holder back on until you hear it click into place.
4. Attach the shoulder strap on the other side of the holder ㉒.

4. Operation

4.1. Operating Instructions for Pressure Sprayer Art. No. 867 / 869

Filling the container:

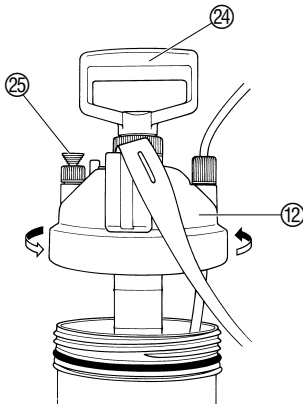

1. Mix the fluid well.
2. Unscrew the container cap ⑫.
3. Pour the fluid into the container up to the maximum mark (3 litres or 5 litres).
Please observe the safety and proportioning instructions provided by the manufacturer of the product you are going to spray.
4. Screw the container cap ⑫ back on and tighten by hand (do not use pliers).



Risk of injury!

→ **Never connect your Pressure Sprayer to an air compressor.**

5. Pull the pump lever ㉔ repeatedly (approx. 30 to 40 times) until the operating pressure has been reached.
Any excess pressure escapes through the safety valve ㉕.

4.2. Operating Instructions for Pressure Sprayer Art. No. 875/879/880

Filling the container:

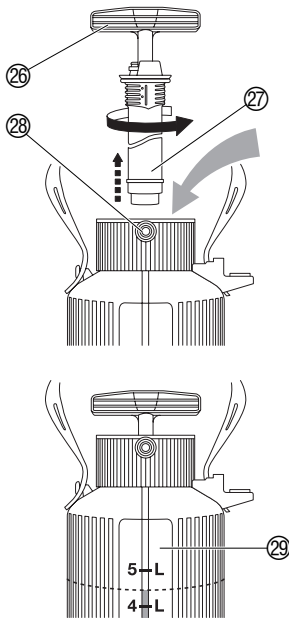

1. Mix the fluid well.
2. Press the pump handle ②⑥ down slightly, turn to the left and remove the pump ②⑦.
3. Pour the fluid into the container up to the maximum mark (5 litres).
Please observe the safety and proportioning instructions provided by the manufacturer of the product you are going to spray.
4. Tighten the pump again with the pump handle ②⑥ by hand (do not use pliers).



Risk of injury!

→ **Never connect your Pressure Sprayer to an air compressor.**

5. Unlock the pump handle ②⑥ by turning slightly to the left and pump the pump repeatedly (approx. 30 - 40 times) until the operating pressure is reached.
Any excess pressure escapes through the safety valve ②⑧.

The Pressure Sprayer Art. No. 879/880 features a window with a scale ②⑨ to help you measure out the appropriate dosage of fertilisers. The window also allows you to see how much fluid is left in the container.

4.3. General Operating Instructions for all Pressure Sprayers (Art. No. 867/869/875/879/880)

Spraying:

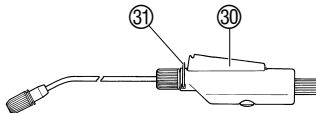

1. Press the operating switch ③⑩ on the handle.
The Pressure Sprayer begins spraying.
2. Release the operating switch ③⑩ on the handle.
The Pressure Sprayer stops spraying.

Setting the permanent lock:

→ Press the permanent lock ③⑪.

The operating switch ③⑩ is pressed down and stays down.

Adjusting the spray tube:

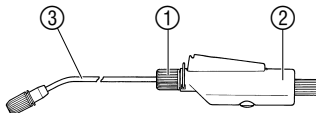

The spray tube can be swivelled 360° in the hand valve.

1. Unscrew the union nut ① on the hand valve ②.
2. Turn the spray tube ③ to the correct position.
3. Tighten the union nut ① on the hand valve ② by hand (do not use pliers).

Setting the spray jet:

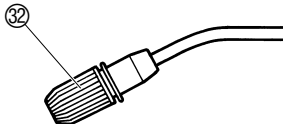

You can adjust the spray jet from full jet (nozzle closed) to a fine mist spray (nozzle open).

→ Open or close the spray nozzle ③⑫ according to the spray jet you require.

5. Cleaning

Cleaning the Pressure Sprayer:

Always clean your Pressure Sprayer after spraying.

→ Fill the Pressure Sprayer with clean water (the water may contain some washing-up liquid if necessary) and empty out the water by spraying it through the spray tube in the same way as when spraying a product.
This cleans the valves, the spray tube and the nozzles.

We recommend that you have your Pressure Sprayer thoroughly inspected (preferably at a GARDENA Service Centre) after using it for 5 years.

6. Trouble-Shooting

Cleaning the filter:

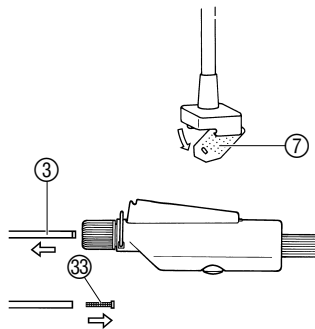

If the spray jet from the Pressure Sprayer is very weak you should clean the filter in the container.

Pressure Sprayer Art. No. 867/869

1. Unscrew the container cap.
2. Flip up the filter ⑦ and rinse under running water.
3. Close the filter ⑦ and screw the container cap back on.

Pressure Sprayer Art. No. 875/879/880

Remove the filter ③③ from the spray tube ③ and clean it.

Problem	Possible Cause	Remedy
Pump does not build up pressure.	Container cap is not airtight.	→ Fasten the container cap as tight as it will go (Art. 867/869).
	Safety valve is loose.	→ Tighten the safety valve.
	Hose connection at the container and hand valve is not tight.	→ Tighten the hose connections at the container and hand valve.
	Continuous lock enabled on handle.	→ Take off the permanent lock at the hand valve.
Pressure Sprayer does not spray although there is sufficient pressure or only sprays with a weak spray jet.	Nozzle is blocked.	→ Clean the nozzle.
	Filter is blocked.	→ Clean the filter in the container (Art. 867/869). Clean the filter in the spray tube (Art. 875/879/880).
It is difficult to open and close the container.	Container pressure too high.	→ Release the container pressure completely by means of the safety valve. Grease the container O-ring with acid-free grease (Art. 867/869).

If you have any other problems with your Pressure Sprayer please contact GARDENA Customer Service.

7. Storage

Storing your Pressure Sprayer:

1. Clean the Pressure Sprayer (refer to 5. Cleaning).
2. Keep your Pressure Sprayer in a place protected from frost.

8. Accessories

GARDENA Weedkiller Cone	Prevents spray mist from blowing away.	Art. No. 894
GARDENA Extension Lance	For extending the spray tube.	Art. No. 897
GARDENA Telescopic Tube	Telescopic extension for the spray tube	Art. No. 899

9. Technical data

	Art. No. 867	Art. No. 869 / 875 / 879	Art. No. 880
Max. capacity	3 l (5 pints approx.)	5 l (8 pints approx.)	5 l (8 pints approx.)
Spray tube length	36 cm	36 cm	60/100 cm
Hose length	150 cm	150 cm	150 cm
Permissible working pressure	3 bar	3 bar	3 bar
Permissible operating temperature	40 °C	40 °C	40 °C

10. Service

Warranty

GARDENA guarantees this product for 2 years (from date of purchase). This guarantee covers all serious defects of the unit that can be proved to be material or manufacturing faults. Under warranty we will either replace the unit or repair it free of charge if the following conditions apply:

- The unit must have been handled properly and in keeping with the requirements of the operating instructions.
- Neither the purchaser or a non-authorised third party have attempted to repair the unit.

This manufacturer's guarantee does not affect the user's existing warranty claims against the dealer/seller.

If you have any problems with your Pressure Sprayer, please contact our Customer Service or return the defective unit together with a short description of the problem directly to one of the GARDENA Service Centres listed on the back of this leaflet.

Product Liability

We expressly point out that, in accordance with the product liability law, we are not liable for any damage caused by our units if it is due to improper repair or if parts exchanged are not original GARDENA parts or parts approved by us, and, if the repairs were not carried out by a GARDENA Service Centre or an authorised specialist. The same applies to spare parts and accessories.

Deutschland / Germany

GARDENA
Manufacturing GmbH
Service Center
Hans-Lorenser-Straße 40
D-89079 Ulm
Produktfragen:
(+49) 731 490-123
Reparaturen:
(+49) 731 490-290
service@gardena.com

Argentina

Argensem® S.A.
Calle Colonia Japonesa s/n
(1625) Loma Verde
Escobar, Buenos Aires
Phone: (+54) 34 88 49 40 40
info@argensem.com.ar

Australia

Nylex Consumer Products
50-70 Stanley Drive
Somerton, Victoria, 3062
Phone: (+61) 1800 658 276
spare.parts@nylex.com.au

Austria / Österreich

GARDENA
Österreich Ges.m.b.H.
Stettnerweg 11-15
2100 Korneuburg
Tel.: (+43) 22 62 7 45 45 36
kundendienst@gardena.at

Belgium

GARDENA Belgium NV/SA
Sterrebeekstraat 163
1930 Zaventem
Phone: (+32) 2 7 20 92 12
Mail: info@gardena.be

Brazil

Palash Comércio e
Importação Ltda.
Rua Américo Brasiliense,
2414 - Chácara Sto Antonio
São Paulo - SP - Brasil -
CEP 04715-005
Phone: (+55) 11 5181-0909
eduardo@palash.com.br

Bulgaria

DENEX LTD.
2 Luis Ahalier Str. - 7th floor
Sofia 1404
Phone: (+359) 2 958 18 21
office@denex-bg.com

Canada

GARDENA Canada Ltd.
100 Summerlea Road
Brampton, Ontario L6T 4X3
Phone: (+1) 905 792 93 30
info@gardenacanada.com

Chile

Antonio Martinic y Cia Ltda.
Cassillas 272
Centro de Cassillas
Santiago de Chile
Phone: (+56) 2 20 10 708
garfar_cl@yahoo.com

Costa Rica

Compania Exim
Euroiberoamericana S.A.
Los Colegios, Moravia,
200 metros al Sur del Colegio
Saint Francis - San José
Phone: (+506) 297 68 83
exim_euro@racsa.co.cr

Croatia

KLIS d.o.o.
Stanciceva 79
10419 Vukovina
Phone: (+385) 1 622 777 0
gardena@klis-trgovina.hr

Cyprus

FARMOKIPIKI LTD
P.O. Box 7098
74, Digeni Akritia Ave.
1641 Nicosia
Phone: (+357) 22 75 47 62
condam@spidernet.com.cy

Czech Republic

GARDENA spol. s r.o.
Řipská 20a, č.p. 1153
627 00 Brno
Phone: (+420) 800 100 425
gardena@gardenabrn.cz

Denmark

GARDENA Norden AB
Salgsafdeling Danmark
Box 9003
S-200 39 Malmö
info@gardena.dk

Finland

Habitec Oy
Martinkyläntie 52
01720 Vantaa

France

GARDENA
PARIS NORD 2
69, rue de la Belle Etoile
BP 57080
ROISSY EN FRANCE
95948 ROISSY CDG CEDEX
Tél. (+33) 0826 101 455
service.consommateurs@
gardena.fr

Great Britain

GARDENA UK Ltd.
27-28 Brenkley Way
Bleazard Business Park
Seaton Burn
Newcastle upon Tyne
NE13 6DS
info@gardena.co.uk

Greece

Agropik
Psomadopoulos S.A.
Ifaistou 33A
Industrial Area Koropi
194 00 Athens Greece
V.A.T. EL093474846
Phone: (+30) 210 66 20 225
service@agropik.gr

Hungary

GARDENA
Magyarország Kft.
Késmárk utca 22
1158 Budapest
69, rue de la Belle Etoile
BP 57080
ROISSY EN FRANCE
95948 ROISSY CDG CEDEX
Tél. (+33) 0826 101 455
service.consommateurs@
gardena.fr

Iceland

O. Johnson & Kaaber
Tunguhalsi 1
110 Reykjavik
ooj@ojk.is

Ireland

Michael McLoughlin & Sons
Hardware Limited
Long Mile Road
Dublin 12

Italy

GARDENA Italia S.p.A.
Via Donizetti 22
20020 Lainate (Mi)
Phone: (+39) 02.93.94.79.1
info@gardenaitalia.it

Japan

KAKUICHI Co. Ltd.
Sumitomo Realty &
Development Kojimachi
BLDG., 8F
5-1 Nibanncyo, Chiyoda-ku
Tokyo 102-0084
Phone: (+81) 33 264 4721
m_ishihara@kaku-ichi.co.jp

Luxembourg

Magasins Jules Neuberg
Grand Rue 30
Boîte postale 12
L-2010 Luxembourg
Phone: (+352) 40 14 01
info@neuberg.lu

Netherlands

GARDENA Nederland B.V.
Postbus 50176
1305 AD ALMERE
Phone: (+31) 36 521 00 00
info@gardena.nl

Neth. Antilles

Jonka Enterprises N.V.
Sta. Rosa Weg 196
P.O. Box 8200
Curaçao
Phone: (+599) 9 767 66 55
pgm@jonka.com

New Zealand

NYLEX New Zealand Limited
Building 2, 118 Savill Drive
Mangere, Auckland
Phone: (+64) 9 270 1806
lena.chapman@nylex.com.au

Norway

GARDENA Norden AB
Salgskontor Norge
Karihaugveien 89
1086 Oslo
info@gardena.no

Poland

GARDENA Polska Sp. z o.o.
Szymanów 9 d
05-532 Baniocha
Phone: (+48) 22 727 56 90
gardena@gardena.pl

Portugal

GARDENA Portugal Lda.
Recta da Granja do Marquês
Edif. GARDENA Algueirão
2725-596 Mem Martins
Phone: (+351) 21 922 85 30
info@gardena.pt

Romania

MADEX INTERNATIONAL SRL
Soseaua Odaii 117-123,
Sector 1,
Bucureşti, RO 013603
Phone: (+40) 21 352 76 03
madex@ines.ro

Russia / Россия

АО АМІДА ТТЦ
ул. Мосфильмовская 66
117330 Москва
Phone: (+7) 095 956 99 00
amida@col.ru

Singapore

Hy-Ray PRIVATE LIMITED
40 Jalan Pemimpin
#02-08 Tat Ann Building
Singapore 577185
Phone: (+65) 6253 2277
hyray@singnet.com.sg

Slovak Republic

GARDENA Slovensko, s.r.o.
Parónska cesta 17
851 04 Bratislava
Phone: (+421) 263 453 722
info@gardena.sk

Slovenia

Silk d.o.o.
Brodišče 15
1236 Trzin
Phone: (+386) 1 580 93 00
gardena@silk.si

South Africa

GARDENA
South Africa (Pty.) Ltd.
P.O. Box 11534
Vorna Valley 1686
Phone: (+27) 11 315 02 23
sales@gardena.co.za

Spain

GARDENA IBÉRICA S.L.U.
C/Basauri, nº 6
La Florida
28023 Madrid
Phone: (+34) 91 708 05 00
atencioncliente@gardena.es

Sweden

GARDENA Norden AB
Försäljningskontor Sverige
Box 9003
200 39 Malmö
info@gardena.se

Switzerland / Schweiz

GARDENA (Schweiz) AG
Bitziberg 1
8184 Bächenbülach
Phone: (+41) 848 800 464
info@gardena.ch

Turkey

GARDENA / Dost Diş Ticaret
Müessilik A.Ş. Sanayi
Çad. Adil Sokak No. 1
Kartal - Istanbul
Phone: (+90) 216 38 93 939
info@gardena-dost.com.tr

Ukraine / Украина

ALTSEST JSC
4 Petropavlivska Street
Petropavlivska
Borschahivka Town
Kyivo Svyatoshyh Region
08130, Ukraine
Phone: (+380) 44 459 57 03
upyr@altsest.kiev.ua

USA

Melnor Inc.
3085 Shawnee Drive
Winchester, VA 22604
Phone: (+1) 540 722-9080
service_us@melnor.com

879-20.960.05/0706

© GARDENA
Manufacturing GmbH
D-89070 Ulm
http://www.gardena.com

Free Manuals Download Website

<http://myh66.com>

<http://usermanuals.us>

<http://www.somanuals.com>

<http://www.4manuals.cc>

<http://www.manual-lib.com>

<http://www.404manual.com>

<http://www.luxmanual.com>

<http://aubethermostatmanual.com>

Golf course search by state

<http://golfingnear.com>

Email search by domain

<http://emailbydomain.com>

Auto manuals search

<http://auto.somanuals.com>

TV manuals search

<http://tv.somanuals.com>