

FRIGIDAIRE

All about the

Installation

of your

Split Type Room Air Conditioner

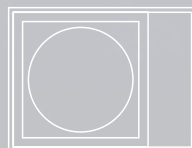

Model(indoor/outdoor):
FRS093LW1/FRS093LC1
FRS123LW1/FRS123LC1

Safety precautions

This appliance must be installed by a qualified licensed HVAC technician in accordance with all applicable codes. All electrical connections should be performed by a licensed electrician.

DANGER! Avoid Serious Injury or Death

1. Do not attempt to install the split air conditioner by yourself.
2. This air conditioner contains no user-serviceable parts. Always call an authorized Electrolux servicer for repairs.
3. When moving the air conditioner, always call an authorized Electrolux servicer for disconnection and re-installation.
4. Do not insert or place fingers or objects into the air discharge area in the front of the indoor unit.
5. Do not insert or place fingers or objects into the air discharge area in the outdoor unit.
6. Do not start or stop the air conditioner by unplugging the power cord or turning off the power at the electrical box.
7. Do not cut or damage the power cord.
8. If the power cord is damaged it should only be replaced by an authorized Electrolux servicer.
9. In the event of a malfunction (sparks, burning smell, etc.) immediately stop the operation, disconnect the power cord, and call an authorized Electrolux servicer.
10. Do not operate the air conditioners with wet hands
11. Do not pull on the power cord.
12. Do not drink any water that is drained from the air conditioners.

CAUTION! Avoid Injury or damage to the unit or other property

1. Provide occasional ventilation during use. Do not direct airflow at fireplaces or other heat related sources as this could cause flare ups or make units run excessively.
2. Do not climb on or place objects on the outdoor unit.
3. Do not hang objects off the indoor unit.
4. Do not place containers containing water on the indoor and/or outdoor units.
5. Turn off the air conditioner at the power source when it will not be used for an extended period of time.
6. Periodically check the condition of the outdoor unit's installation base for any damage.
7. Do not apply heavy pressure to the radiator fins of the indoor and/or outdoor units.
8. Operate the indoor unit with air filters in place.
9. Do not block or cover the intake grille, discharge area and outlet ports.
10. Ensure that any electrical/electronic equipment is one yard away from the indoor unit and outdoor unit.
11. Do not use or store flammable gases near the indoor and/or outdoor units.

To prevent injury to the user or other people and property damage, the following instructions must be followed.

Incorrect operation due to ignoring of instructions may cause harm or damage. The seriousness is classified by the following indications.

1. Connect with the power properly. Otherwise, it may cause electric shock or fire due to excess heat generation.
2. Always ensure effective grounding. No grounding may cause electric shock.
3. Disconnect the power if strange sounds, smell, or smoke comes from it. It may cause fire and electric shock.
4. Do not operate or stop the unit by switching on or off the power. It may cause electric shock or fire due to heat generation.
5. Do not operate with wet hands or in damp environment. It may cause electric shock.
6. Do not allow water to run into electric parts. It may cause failure of machine, electric shock or fire.
7. Do not use the power cord near flammable gas or combustibles, such as gasoline, benzene, thinner, etc. It may cause an explosion or fire.
8. Do not use the power cord close to heating appliances. It may cause fire and electric shock.

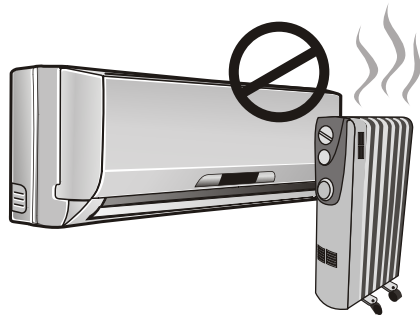

9. Do not damage or use an unspecified power cord. It may cause electric shock or fire.
10. Do not place heavy object on the power cord and ensure that the cord will not be compressed. There is danger of fire or electric shock.

11. Do not open the unit during operation. It may cause electric shock or injury.

12. Do not drink water drained from air conditioner. It contains contaminants and could make you sick.

13. Do not disassemble or modify unit. It may cause failure of appliance and electric shock.

14. When the air filter is to be removed, do not touch the metal parts of the unit. It may cause an injury.

15. When the unit is to be cleaned, switch off, and turn off the circuit breaker. Do not clean unit when power is on as it may cause fire, electric shock or injury.

16. Avoid direct exposure of occupants to air flow.

17. Turn off the main power switch when not using the unit for a long time.

18. The air conditioner may be dusted with an oil free cloth, or washed with a cloth dampened in a solution of warm water and mild dishwashing detergent. Rinse thoroughly and wipe dry. Wring excess water from cloth before wiping around controls.

19. Ensure that the installation bracket of the outdoor unit will not damage due to prolonged exposure. If bracket damages, there will be concern of damage due to falling of unit.

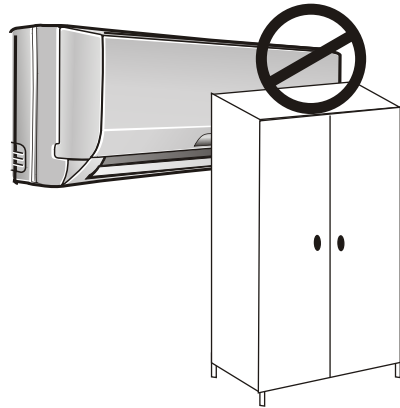
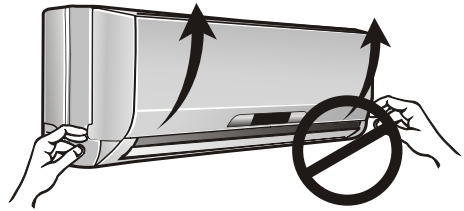

20. Always insert the filters securely. Clean filter once every two weeks. Operation without filters may cause failure.

21. Always install circuit breaker and a dedicated power circuit. No installation may cause fire and electric shock.

22. Do not place obstacles around air inlets or inside of air-outlet. It may cause failure of appliance or accident.

Choosing the installation site

Installation Warnings

1. Carefully read the installation manual before beginning.
2. Follow each step as shown.
3. Observe all local, state and national electric codes. This appliance must be installed by a qualified licensed HVAC technician in accordance with all applicable codes. All electrical connections should be performed by a licensed electrician.
4. Pay attention to danger and safety notices

Precautions for Installation

Installation at the following sites may cause problems. If you must inevitably install the unit at one of these sites, please consult your local distributor beforehand:

1. Sites with machine oil.
2. Sites with a high concentration of salinity, such as coastal areas.
3. Sites with sulfuric gas, such as hot water springs.
4. Sites with high frequency equipment, such as wireless equipment, welding machines and medical installations.
5. Sites with flammable gases or volatile material.
6. Sites with special environmental conditions.
7. Laundry rooms.

Indoor Unit

1. The unit must be installed at a site that does not obstruct the flow of air.
2. The site must support the weight of the indoor unit.
3. The site must be easily accessible for maintenance and replacement of the air filter.
4. The site must allow for the necessary space around the indoor unit, as shown in the sideward figure.
5. There should be at least 3 feet (1 meter) between the unit and radio or television devices. It is ideal that the unit be installed at the center.
6. It must be far from fire, smoke or flammable gases.
7. The indoor unit must be at least 7.5 feet (2.3 meters) from the ground.
8. The site must allow for the easy removal of the connector pipe and drain hose.
9. The unit must be installed at a site protected from direct sunlight.

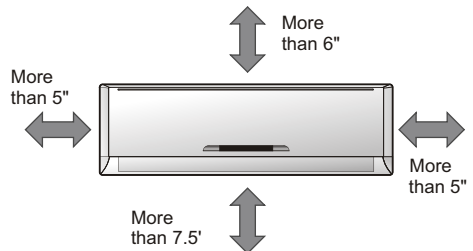

Outdoor Unit

1. The outdoor unit must be installed at a convenient site that is not exposed to strong winds. The site should be dry and well ventilated.
2. The site must support the weight of the outdoor unit and allow for vertical installation.
3. There must not be the possibility of increased noise and vibration at the site.
4. The unit must be installed at a site where the noise produced by its operation and air discharge does not disturb the neighbors or animals.
5. The site cannot have any leakage of flammable gases.
6. The site must provide enough space around the unit, as shown in the figure.
7. Children must not be able to access the installation site.

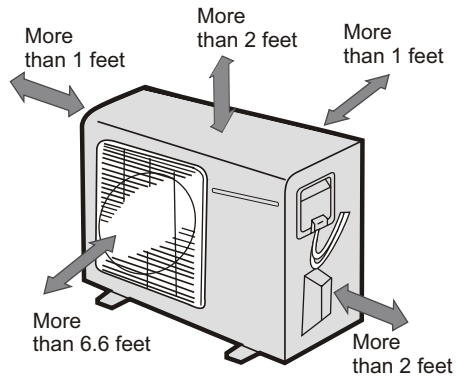

Parts list

NUMBER	PART NAME		QTY.	
1	Installation plate		1	
2	Clip anchor		10	
3	Self-tapping screw A #7 X 1"		8	
4	Seal		1	
5	Drain Joint		1	
6	Connecting cable		1	
7	Connecting pipe assembly	Liquid side	Ø1/4" (capacity ≤ 12000 Btu's)	1
			Ø3/8" (capacity > 12000 Btu's)	
		Gas side	Ø3/8" (capacity ≤ 9000 Btu's)	
			Ø1/2" (capacity ≤ 12000 Btu's)	
			Ø5/8" (capacity > 12000 Btu's)	
8	Remote controller		1	
9	Self-tapping screw B #7 X 3/4"		2	
10	Remote Controller holder		1	



Indoor unit

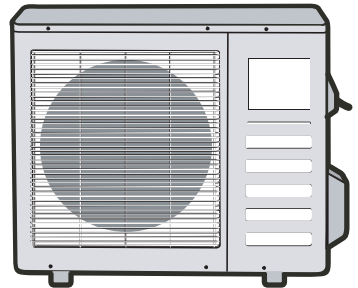
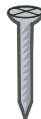
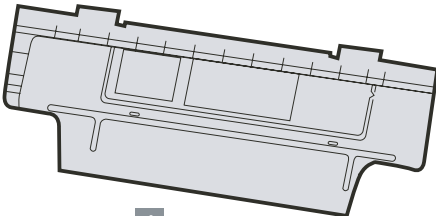
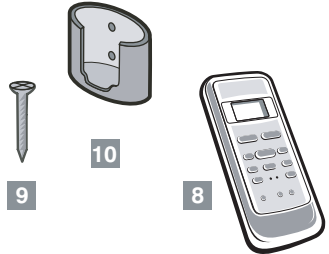

Outdoor unit

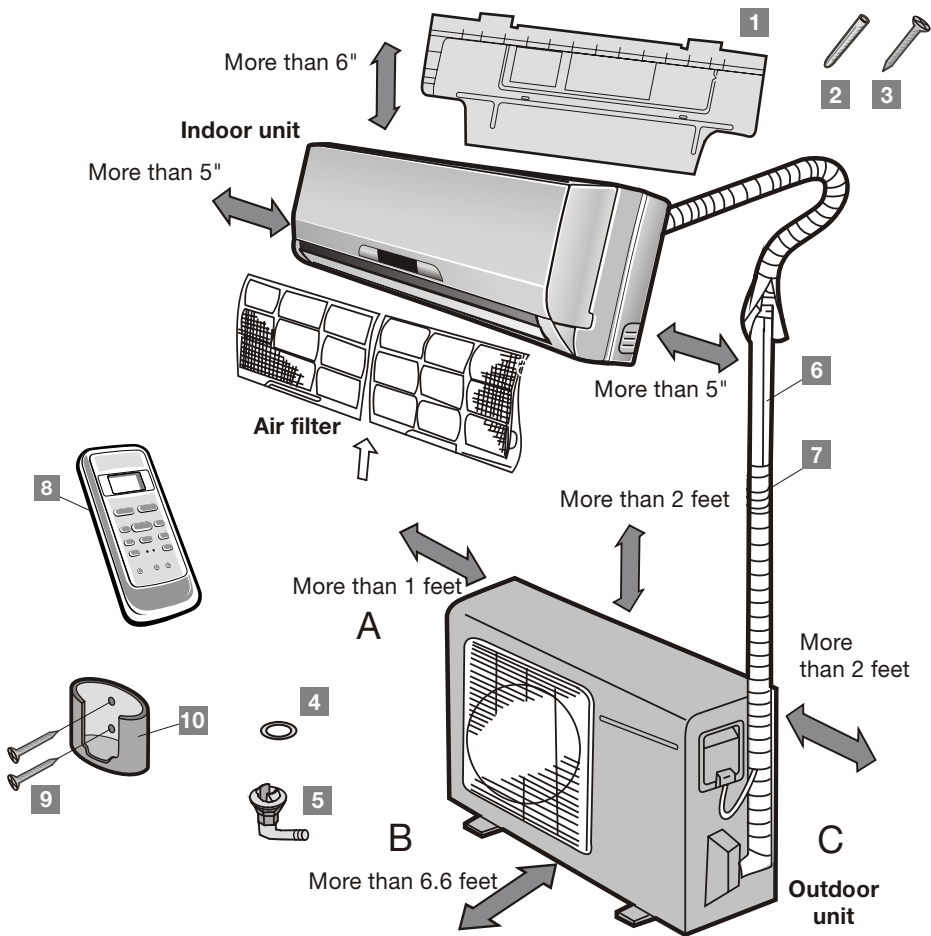

Attention

1. This illustration is for explanation purposes only.
2. Copper tubes must be insulated independently

Indoor unit installation

Installation plates and dimensions

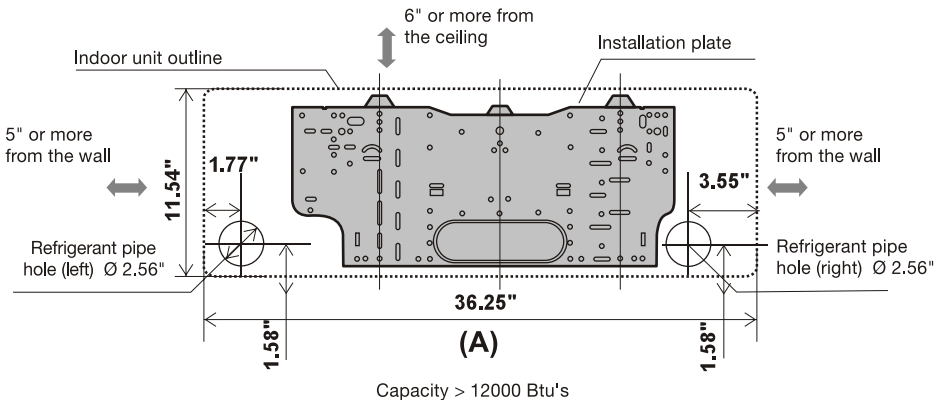
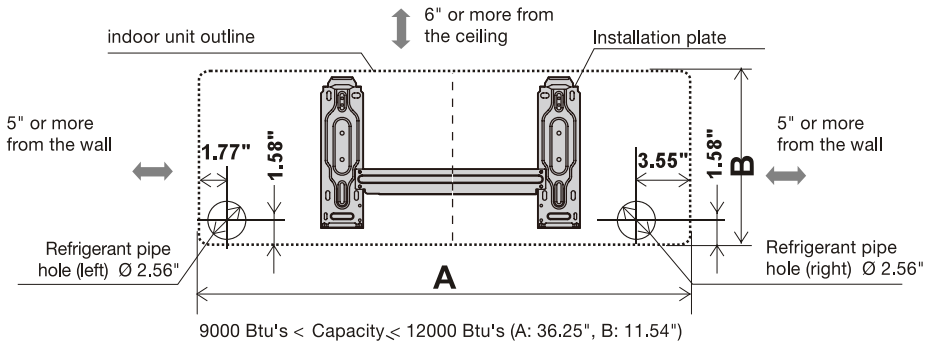
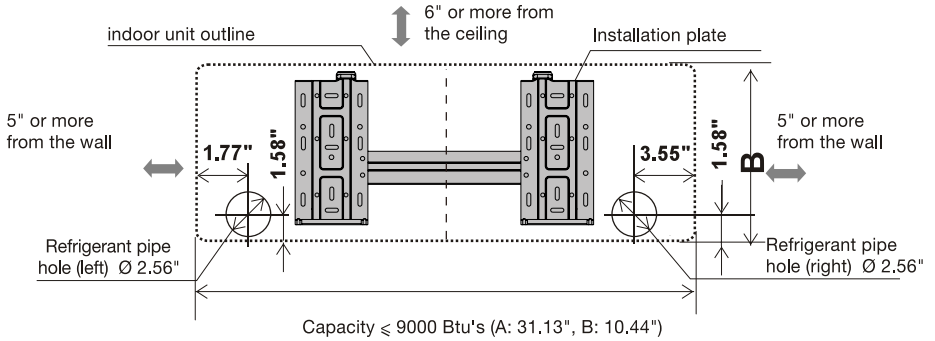

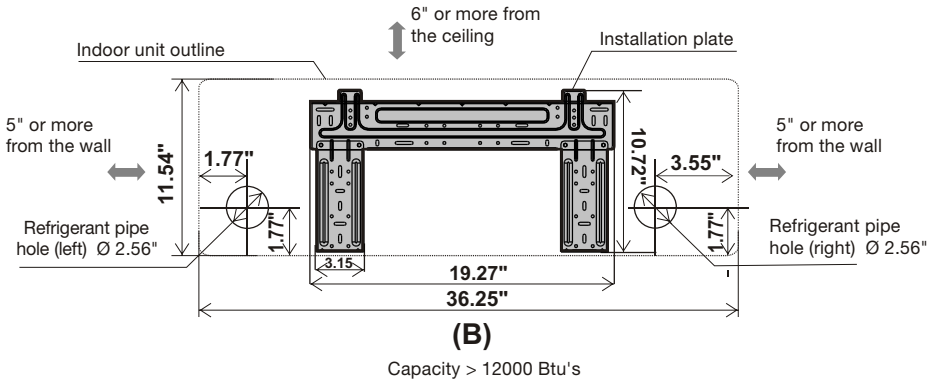

Fixing the Installation Plate

1. Install the installation plate horizontally over the structural parts on the wall using the spaces indicated on the plate, as shown in the figures above.
2. In the case of tiled, concrete or similar walls, create 0.2 inch diameter holes. Place anchorage supports for the appropriate assembly screws.
3. Fix the installation plate to the wall with eight A type screws.
4. At all times securing to the wall studs is recommended.

Attention

Fit the Installation Plate and drill holes in the wall according to the wall structure and corresponding mounting points on the installation plate (Dimensions are in "mm" unless otherwise stated).

Installation plate



Drilling the Hole

1. Determine the position of the hole for the pipes using the installation plate and drill the pipe hole so that it is tilted slightly downward.
2. Always use a pipe cover with an opening when drilling.

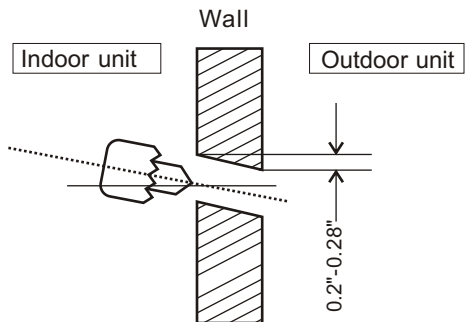

Connective pipe and drainage installation

Connective pipe

1. For the left-hand and right-hand piping, remove the pipe cover from the side panel. The pipe cover must be kept as it may be used when relocating the air conditioner to any other place.
2. For the rear-right-hand and rear-left-hand piping, install the piping as shown in the sideward figure. Bend the connective pipe to be laid at a height of 1.69 inches or less from the wall. Fix the end of the connective pipe.

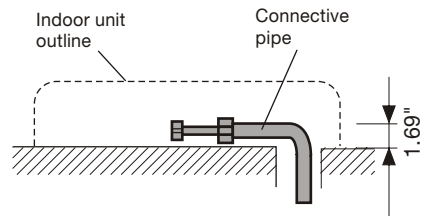
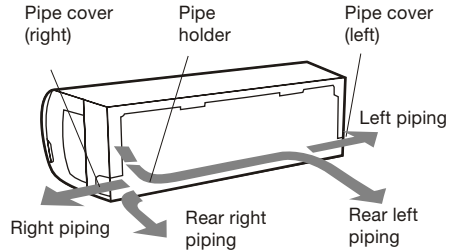

Drainage

1. Run the drain hose sloping downward. Do not install the drain hose as illustrated sideward.
2. When connecting extension drain hose, insulate the connecting part of extension drain hose with a shield pipe, do not let the drain hose slack.

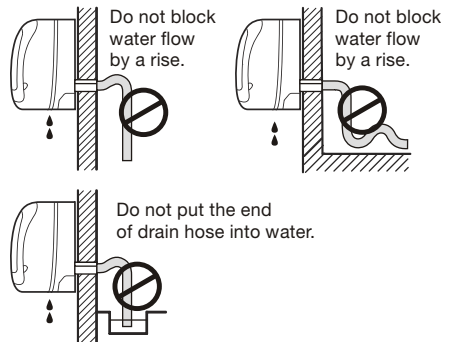

Fastening the Indoor Unit

1. Pass the piping through the hole in the wall.
2. Put the upper claw at the back of the indoor unit on the upper hook of the installation plate, move the indoor unit from side to side to see that it is securely hooked.

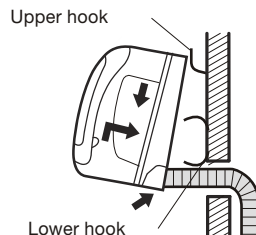

- Piping can easily be made by lifting the indoor unit with a cushioning material between the indoor unit and the wall. Get it out after finish piping.
- Push the lower part of the indoor unit up on the wall, Then move the indoor unit from side to side, up and down to check if it is hooked securely.

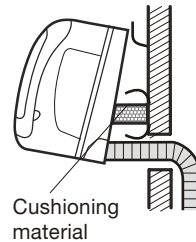

Piping and wrapping

- Bundle the tubing, connecting cable, and drain hose with tape securely and evenly as shown in the sideward figure.
- Because the condensed water from rear of the indoor unit is gathered in ponding box and is piped out of room, do not put anything else in the box.

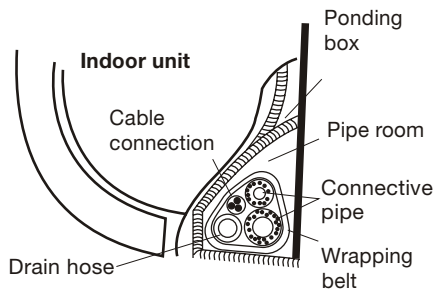

Attention

- Connect the indoor unit first, then the outdoor unit.
- Do not allow the piping to let out from the back of the indoor unit.
- Be careful not to let the drain hose slack.
- Both of the auxiliary piping should be heat insulation.
- Be sure that the drain hose is located at the lowest side of the bundle. Locating at the upper side may cause drain pan to overflow inside the unit.
- Never intercross nor intertwist the power wire with any other wiring.
- Run the drain hose sloped downward to drain out the condensed water smoothly.

Outdoor unit installation

1. Install the outdoor part of the unit on a rigid surface to avoid excess noise and vibration.
2. Direct the air vent toward an area without obstacles.
3. Install the unit at the site where it is exposed to as little wind as possible, especially in areas where it is frequently windy.
4. If the installation site is exposed to heavy winds, such as in coastal areas, place the unit along the widest part of the wall or use protective plates.
5. Be sure there is no obstacle which blocks radiating air, including shrubs or bushes.

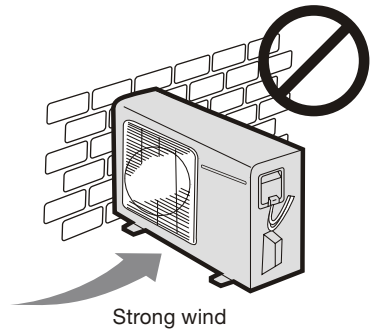
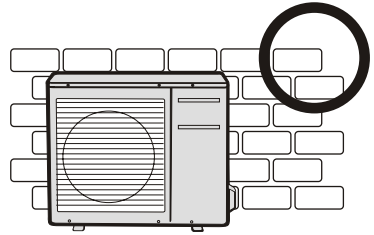

Settlement of outdoor unit

Anchor the outdoor unit tightly and horizontally on a concrete or rigid mount with a bolt and nut 0.39 inch or 0.32 inch diameter (Purchased separately).

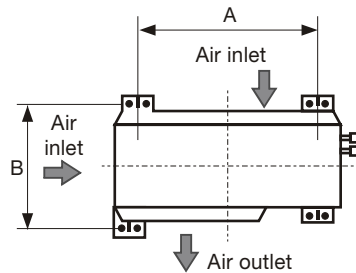

Outdoor unit dimension inch(WxHxD)	A (inch)	B (inch)
2.30'x1.76'x0.77'	1.50'	0.82'
2.25'x1.41'x0.85'	1.51'	0.91'
2.56'x1.77'x0.82'	1.80'	0.91'
2.49'x1.94'x0.94'	1.74'	0.95'
2.77'x2.28'x1.10'	1.84'	1.10'

Drain joint installation

Fit the seal into the drain elbow, then insert the drain joint into the base pan hole of outdoor unit, rotate 90° to securely assemble them. Connect the drain joint with an extension drain hose (Locally purchased), in case of the water draining off the outdoor unit during the heating mode or rainy season.

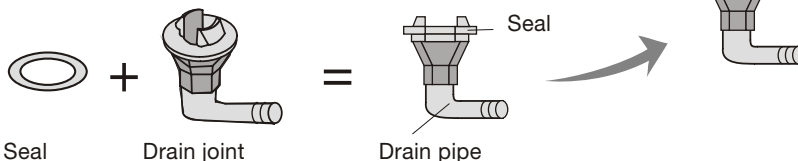
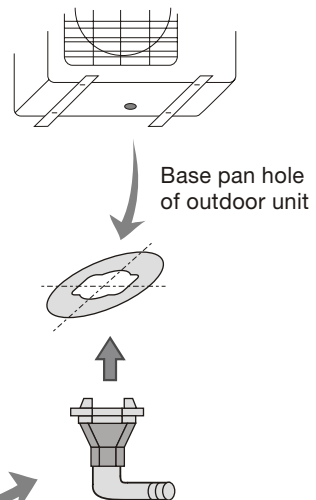

Refrigerant piping connection

Unit comes with 16.4 feet tubing bundle. It is not recommended to cut. If too long, loop for excess.

Note: Keep original bend so not kinking of the tube occurs.

Flaring work

Main cause for refrigerant leakage is due to defect in the flaring work.

Carry out correct flaring work using the following procedure:

1. Cut the pipes and the cable.
 - A) Use the piping kit accessory or pipes purchased locally.
 - B) Measure the distance between the indoor and the outdoor unit.
 - C) Cut the pipes a little longer than the measured distance.
 - D) Cut the cable 4.92 feet longer than the pipe length.
2. Burr removal
 - A) Completely remove all burrs from the cut cross section of pipe/tube.
 - B) Put the end of the copper tube/pipe in a downward direction as you remove burrs in order to avoid dropping burrs into the tubing.
3. Put nut on.

Remove flare nuts attached to indoor and outdoor unit, then put them on pipe/tube having completed burr removal. (It is not possible to put them on after flaring work)

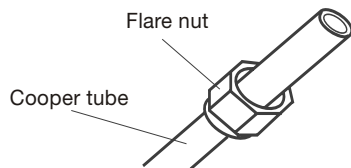
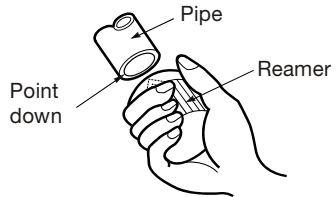
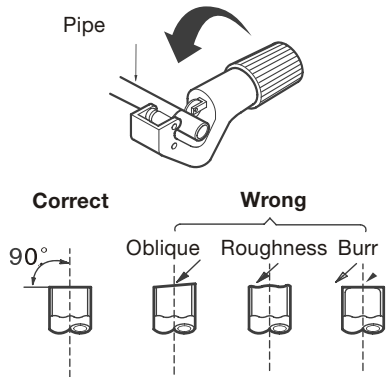

4. Flaring work.

Firmly hold copper pipe in a die in the dimension shown in the table below.

OUTER DIAMETER (inch)	A (inch)	
	Max.	Min.
1/4	0.051	0.028
3/8	0.063	0.039
1/2	0.071	0.039
5/8	0.095	0.087

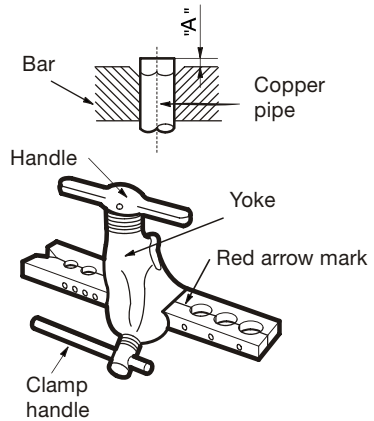

Connection Adjustment

1. Align the pipes to be connected.
2. Screw the flare nut with your fingers, and then tighten it with a spanner and torque wrench, as shown in the following figure.

Caution: Excessive twisting may break the nut, depending on the installation conditions.

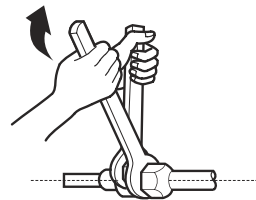
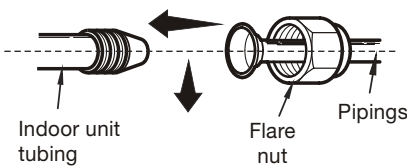

OUTER DIAMETER (inch)	TIGHTENING TORQUE (lbf-in)	ADDITIONAL TIGHTENING TORQUE (lbf-in)
1/4	139	174
3/8	260	304
1/2	434	477
5/8	651	694

Electrical work

Electric safety regulations for the initial Installation

1. If there is serious safety problem about the power supply, the technicians should refuse to install the air conditioner and explain to the client until the problem is solved.
2. Power voltage should meet the requirements in the following table.
3. Over current protection and circuit disconnect should meet the requirements in the following table and the applicable local and national electrical codes.
4. Ensure the air conditioner is grounded well.
5. According to the attached Electrical Connection Diagram located on the panel of the outdoor unit to connect the wire.
6. All wiring must comply with local and national electrical codes and be installed by qualified and skilled electricians.
7. An individual branch circuit used only for this air conditioner must be available. See the following table:

Electrical Data Table													
Capacity (BTU)	System Voltage Volts-Ph.-Freq	Operating Voltage (Min/Max)	Compressor		Outdoor Fan			Indoor Fan				MIN. Circuit Ampacity (MCA)	Max. Fuse/Circuit Breaker Amps(MOCP)
			RLA	LRA	FLA	HP	Output Watts	Volts	FLA	HP	Output Watts		
9K	115-1-60	103/127	7.1	40	0.8	0.03	23	35V-DC	0.7	0.027	20	13.6	15
12K	115-1-60	103/127	9.5	47	0.8	0.03	23	35V-DC	0.9	0.034	25	17.2	20

Connecting (Power and Control Cable)

- The main power is supplied to the outdoor unit. The field supplied connecting cable from the outdoor unit to indoor unit consists of four wires and provides the power for the indoor unit as well as the communication signal and ground between the outdoor and indoor unit.
- Consult local building codes, NEC (National Electrical Code) or CEC (Canadian Electrical Code) for special requirements.

Connect the cable to the indoor unit

1. The inside and outside connecting cable can be connected without removing the front grille.
2. Connecting cable between indoor unit and outdoor unit shall be approved polychloroprene sheathed flexible cord, type designation 16AWG or heavier cord.
3. Lift the indoor unit panel up, remove the electrical box cover by loosening the screw.
4. Ensure the colour of wires of outdoor unit and the terminal Nos. are the same to the indoors respectively.
5. Wrap those cables not connected with terminals with insulation tapes, so that they will not touch any electrical components. Secure the cable onto the control board with the cord clamp.

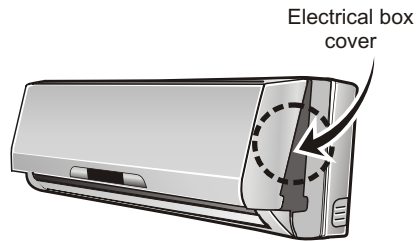

≤ 12000 btu's CABLE (Cooling model)

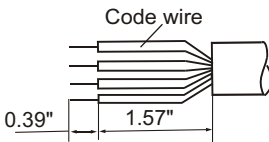

≤ 12000 btu's CABLE (Heating and cooling model)

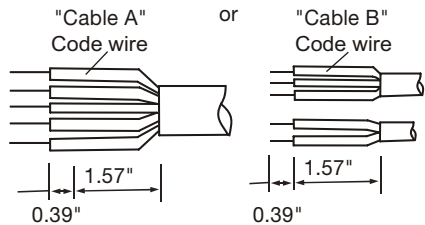

> 12000 btu's CABLE (Heating and cooling model)

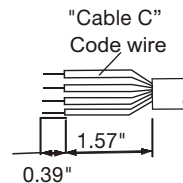

**9000 and 12000 Btu's
COOLING MODEL**

Terminal block of indoor unit

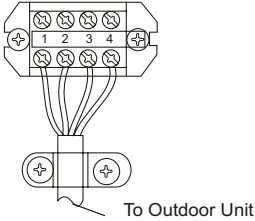

**9000 and 12000 Btu's
HEATING AND COOLING MODEL**

"Connector A" or "Connector B"

Terminal block of indoor unit

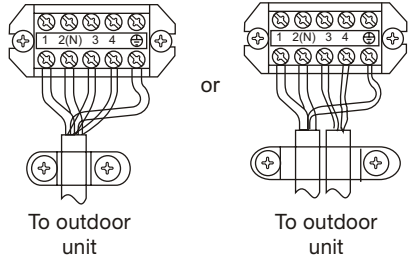

**18000 Btu's
HEATING AND COOLING MODE**

"Connector A"

Terminal block of indoor unit

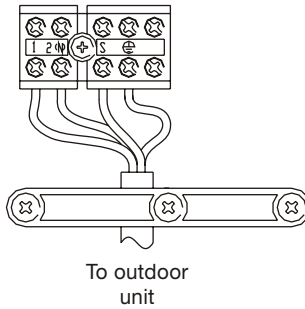

Connect the cable to the outdoor unit

1. Remove the electrical control board cover from the outdoor unit by loosening the screw.
2. Connect the connective cables to the terminals as identified with their respective matched numbers on the terminal block of indoor and outdoor units. The connective cable to power supply shall be approved polychloroprene sheathed flexible cord.
3. Secure the cable onto the control board with the cord clamp.
4. To prevent the ingress of water, form a loop of the connective cable as illustrated in the installation diagram of indoor and outdoor units.
5. Insulate unused cords (conductors) with PVC-tape. Process them so they could not touch any electrical or metal parts.

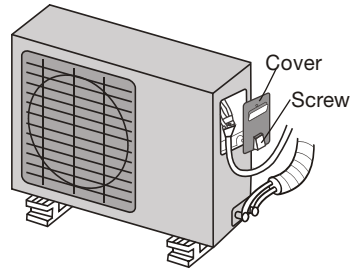

≤ 12000 btu's CABLE

(Heating and cooling model)

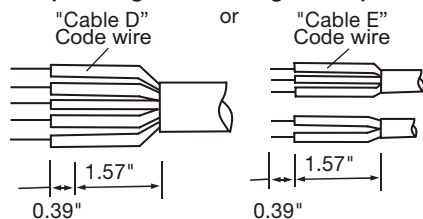

≤ 12000 btu's CABLE (Cooling model)

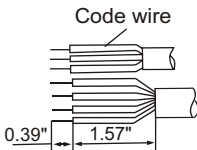

> 12000 btu's CABLE

(Heating and cooling model)

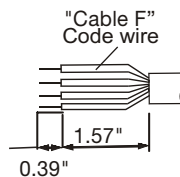

9000 and 12000 Btu's COOLING MODEL

Terminal block of outdoor unit

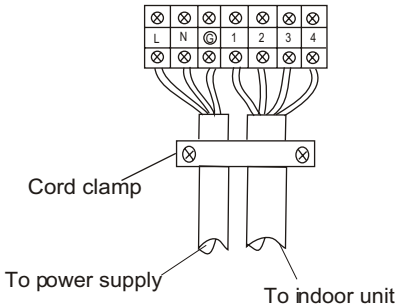

9000 and 12000 Btu's HEATING AND COOLING MODEL

"Conector A" or "Conector B"
Terminal block of outdoor unit

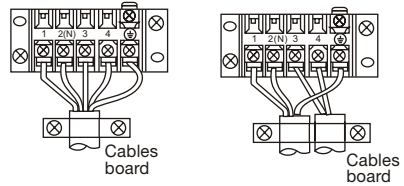

"Conector C" or "Conector D"
Terminal block of outdoor unit

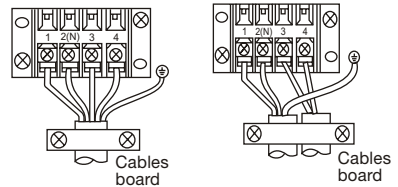

18000 Btu's HEATING AND COOLING MODEL

"Conector A" or "Conector B"

Terminal block of outdoor unit

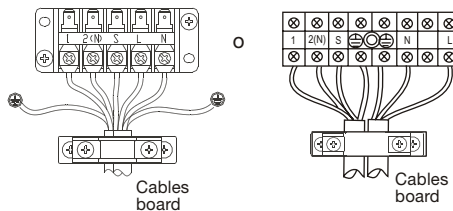

Caution

After the confirmation of the above conditions, prepare the wiring as follows:

1. Never fail to have an individual power circuit specifically for the air conditioner. As for the method of wiring, be guided by the circuit diagram posted on the inside of control cover.
2. The screws which fasten the wiring in the casing of electrical fittings are liable to come loose from vibrations to which the unit is subjected during the course of transportation. Check them and make sure that they are all tightly fastened. (If they are loose, it could cause burn-out of the wires.)
3. Specification of power source.
4. Confirm that electrical capacity is sufficient.
5. See to that the starting voltage is maintained at more than 90 percent of the rated voltage marked on the name plate.
6. Confirm that the cable thickness is as specified in the power source specification.
7. Always install an earth leakage circuit breaker in a wet or moist area.
8. The following would be caused by voltage drop: vibration of a magnetic switch, which will damage the contact point, fuse breaking, disturbance of the normal function of the overload protector.
9. The means for disconnection from a power supply shall be incorporated in the fixed wiring and have an air gap contact separation of at least 0.12 inch in each active (phase) conductors.

Air purging

Air and moisture in the refrigeration system have undesirable effects as indicated below:

1. Pressure in the system rises.
 2. Operating current rises.
 3. Cooling or heating(only for models with heating function) efficiency drops.
 4. Moisture in the refrigerant circuit may freeze and block capillary tubing.
 5. Water may lead to corrosion of parts in the refrigeration system.
- Therefore, the indoor unit and tubing between the indoor and outdoor unit must apply leakage test and be evacuated to remove any noncondensables and moisture from the system.

Air purging with vacuum pump

1. Check that each tube(both liquid and gas side tubes) between the indoor and outdoor units have been properly connected and all wiring for the test run has been completed. Remove the service valve caps from both the gas and the liquid side on the outdoor unit. Note that both the liquid and the gas side service valves on the outdoor unit are kept closed at this stage.
2. When relocating the unit to another place, perform evacuation using vacuum pump.
3. Pipe length and refrigerant amount:

Connective pipe length	Air purging	Additional amount of refrigerant to be charged
Less than 16.4'	Use vacuum pump.	————
16.4'~32.8'	Use vacuum pump.	R410A: 0.71ozs/ft*(Pipe length-16.4')

Caution in handling the packed valve integrated in the outlets of outdoor unit.

1. Operation of opening packed valve: Open the valve stem until it hits against the stopper. Do not try to open it further.
2. Operation of closing packed valve: Securely tighten the valve stem with a special tool. Then securely tighten the valve stem cap with a spanner or the like. Refer to tightening torque table in page 17 for valve stem cap tightening torque

Note: There is a charging port integrated in the low side outlet, but not in the high side outlet. The low side outlet is shown in the sketch map below.

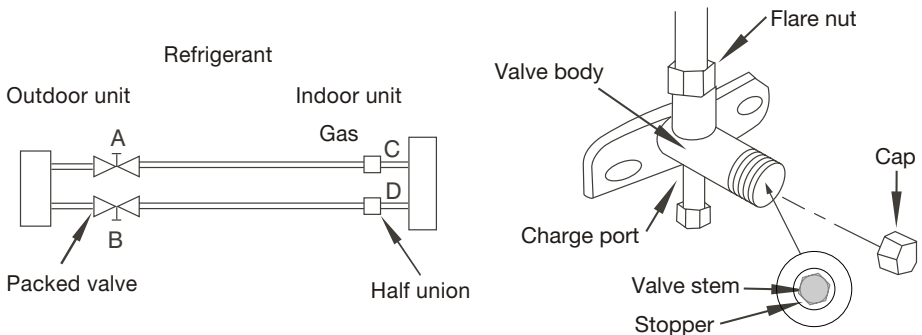

When using the vacuum pump

For method of using a manifold valve, refer to its operation manual.

1. Completely tighten the flare nuts at connection point A, B, C and D. Connect valve core removal tool to the charging port, then connect vacuum hose to valve core tool. Open the schrader valve.
Note: The schrader valve is inside the charging port.
2. Connect the other charge hose of manifold valve to the vacuum pump.
3. Fully open the handle Lo of the manifold valve.
4. Operate the vacuum pump to evacuate. After starting evacuation, slightly loose the flare nut of the Lo valve on the gas pipe side and check if the air is entering (Operation noise of the vacuum pump changes and a compound meter indicates 0 instead of minus), then tighten the flare nut. The procedure verifies if there are blocks inside the tubes.
5. Make evacuation for 15 minutes or more and check that the compound meter indicates $-7.6 \times 10^5 \mu\text{mHg}$ ($-1 \times 10^5 \text{Pa}$). After the evacuation is completed, fully close the handle Lo of the manifold valve and stop the operation of the vacuum pump.
6. Turn the stem of the packed valve B about 45° counterclockwise for 6~7 seconds after the gas comes out, then tighten the flare nut again. Make sure the pressure

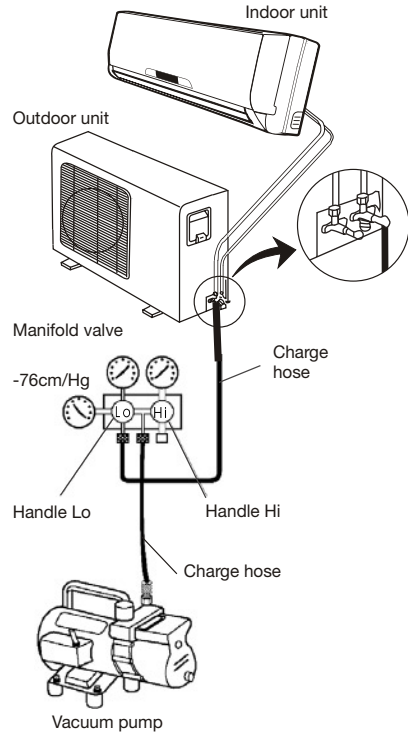

display in the pressure indicator is a little higher than the atmosphere pressure. This procedure verifies if the refrigerant goes through the tubes correctly.

7. Close the schrader valve, then remove the valve core tool. Replace the charging port cap.
8. Fully open the packed valve stems B and A.
9. Securely tighten the cap of the packed valve.

Electrical safety

Perform the electric safety check after completing installation:

1. Insulated resistance: The insulated resistance must be more than $2M\Omega$.
2. Grounding work: After finishing grounding work, measure the grounding resistance by visual detection and grounding resistance tester. Make sure the grounding resistance is less than 4Ω .
3. Electrical leakage check (performing during test running): During test operation after finishing installation, the serviceman can use the electric probe and multimeter to perform the electrical leakage check. Turn off the unit immediately if electrical leakage happens. Check and find out the solution ways till the unit operates properly.

Gas leak check

Soap water method

Apply a soap water or a liquid neutral detergent on the indoor unit connection or outdoor unit connections by a soft brush to check for leakage of the connecting points of the piping. If bubbles come out, the pipes have leakage point.

Leak detector

Use the leak detector to check for leakage.

Caution

A: Lo packed valve, B: Hi packed valve
C and D are ends of indoor unit connection.

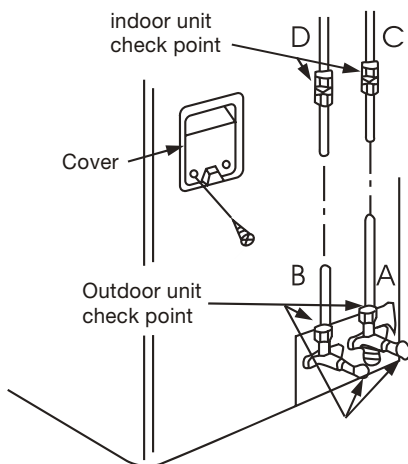

Test running

Perform test operation after completing gas leak check at the flare nut connections and electrical safety check.

1. Connect the power, press the ON/OFF button on the remote controller to turn the unit on.
2. Use the MODE button to select COOL, HEAT(Only for models with heating function), AUTO and FAN to check if all the functions work well.
3. When the ambient temperature is too low(lower than 63°F), the unit cannot be controlled by the remote controller to run in cooling mode, manual operation can be taken. Manual operation is used only when the remote controller is disable or maintenance necessary.

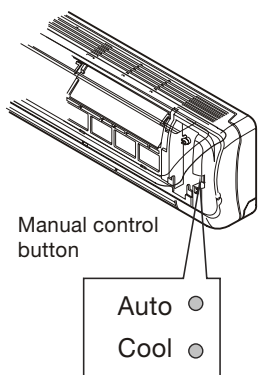
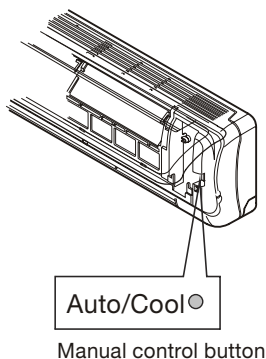
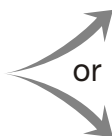
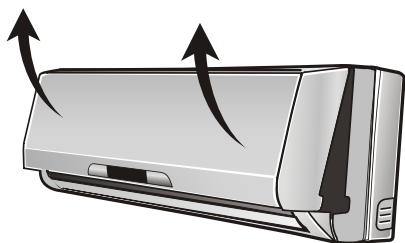

Preparing the device for operation

1. Contact a specialist to install the device.
2. Guarantee that the unit is appropriately fastened and complies with all of the aforementioned safety norms.
3. Before operating the air conditioner, ensure that the air filter is installed correctly.
4. If the unit has been out of use for a long period of time, it is recommended that the air filter be cleaned before use. During continuous use, clean the air filter every two weeks.
5. This air conditioner was designed for use under the following conditions:

MODE					
Cool		Heat*		Dehumidifier	
Temperature		Temperature		Temperature	
Indoor	Outdoor	Indoor	Outdoor	Indoor	Outdoor
63°F~90°F	64°F~109°F	63°F~86°F	19°F~75°F	63°F~90°F	52°F~109°F

* only for models with heating function

Attention

If air conditioner is used outside of the above conditions, certain safety protection features may come into operation and cause the unit to function abnormally. Room relative humidity should be less than 80%. If the air conditioner operates in excess of this figure, the surface of the air conditioner may attract condensation. Please set the horizontal louver to its maximum angle (vertically to the floor), and set HIGH fan mode. Optimum performance will be achieved within these operating temperature.

Free Manuals Download Website

<http://myh66.com>

<http://usermanuals.us>

<http://www.somanuals.com>

<http://www.4manuals.cc>

<http://www.manual-lib.com>

<http://www.404manual.com>

<http://www.luxmanual.com>

<http://aubethermostatmanual.com>

Golf course search by state

<http://golfingnear.com>

Email search by domain

<http://emailbydomain.com>

Auto manuals search

<http://auto.somanuals.com>

TV manuals search

<http://tv.somanuals.com>