

***Fahrenheit***

**STN 7.2inch Wide**

**CEILING MOUNT MONITOR**

**OWNER'S MANUAL**

**T-721CM**



**Auto  
signal sensing**

**CAUTION**

Any changes or modifications in construction of this device which are not expressly approved by the party responsible for compliance could void the user's authority to operate the equipment.

# Contents

We very thanks for your purchase.

Please read this user's Manual in detail and use the set properly.

Caution -----	3
Name and function of each part -----	4
For operating monitor -----	5
Picture control -----	6
Auto picture control	
Manual picture control	
Connections -----	7
Specifications -----	8

## Caution

Read this page in detail in order to protect people's health or assets.

- Driver never operates while driving.  
Driver may cause car accident by watching monitor while driving.
- Do not disassemble or remodel the device.
- Use proper volume while driving.
- When you set-up the device, get advice with qualified engineer.
- Do not watch monitor for long time under the condition of stopping engine.
- Do not drop or give strong impact to LCD Panel.
- Do not recharge, disassemble or heat the remote control battery.
- Keep remote control battery away from child.
- **Auto signal sensing** : The screen will be dark automatically if there is no input signal.

### ☞ Check Point

- 1 The range of preservation temperature for the device is from  $-20^{\circ}\text{C}$  to  $80^{\circ}\text{C}$   
Be cautious that the inside temperature of car may arise up to  $100^{\circ}\text{C}$  in summer time.
- 2 The TV picture may not be displayed normally when it is higher or lower than the using temperature.  
In this case, the screen will be back normal condition after minutes.  
The range of using temperature for the device is from  $0^{\circ}\text{C}$  to  $40^{\circ}\text{C}$ .
- 3 You can watch the best picture condition when you are in the front side.

## Name and function each part

### UNIT

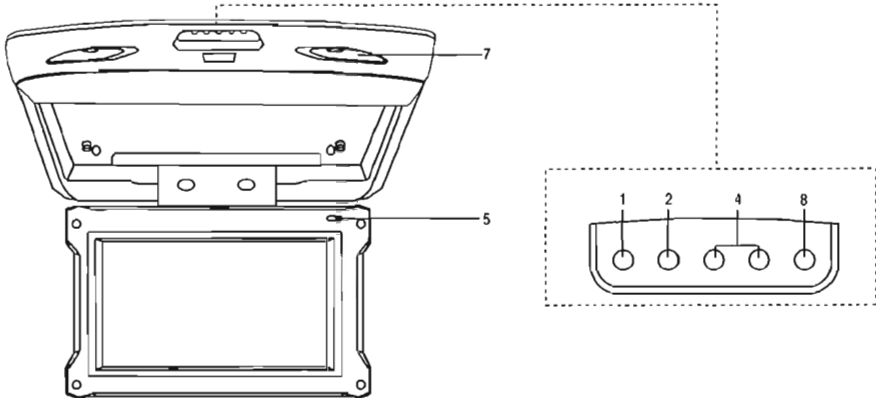

### Remote Control

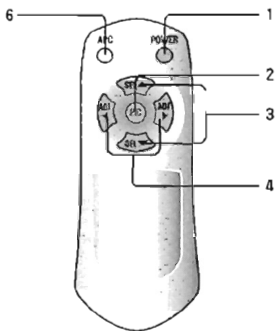

1. Power button.
2. Picture control.
3. Selection in each mode.
4. Adjustment in each mode.
5. Remote sensor.
6. Automatic picture control.
7. Lamp.  
Dome light
8. On/Off button.  
Press "On/Off" button to on the lamp,  
press "On/Off" button one more time  
to off the lamp.

## For operating monitor

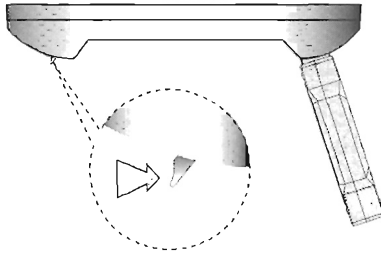

Eject monitor set by pressing **PUSH** button and then, adjust monitor set for your comfortable watching.

---

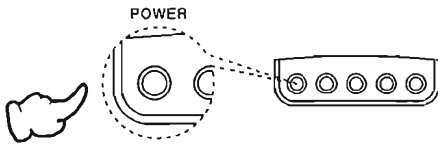

Press **POWER** button.  
Then picture is displayed.  
Press the **POWER** button one more time to off the power.

---

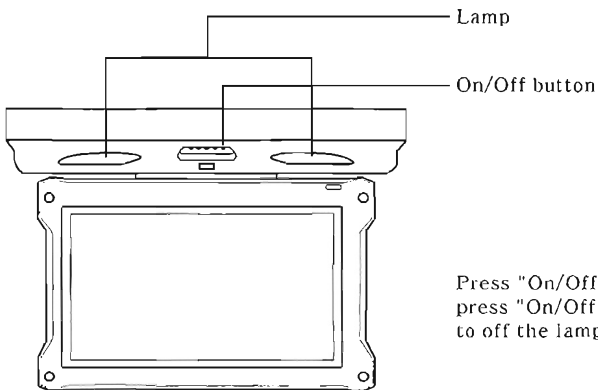

Press "On/Off" button to on the lamp,  
press "On/Off" button one more time  
to off the lamp.

---

# Picture control

## Auto picture control.



1. Whenever you press APC button, picture condition is to be changed as follows.

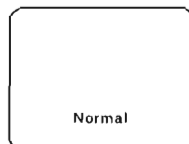
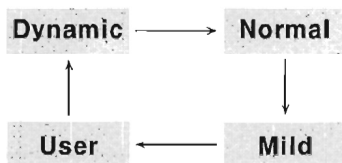

## Manual picture control.

### Contrast/Bright/Color/Tint selection.



1. Make Picture displayed by pressing PIC button.
2. Make the menu you want to adjust red-colored by pressing SEL ▲ or ▼ button.

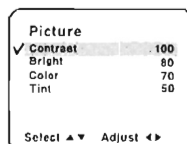

- The same function whenever pressing the button on the Monitor set.



3. Adjust the picture condition you want by pressing ADJ▶ or ◀ button.

The function of Brightness control is not installed.

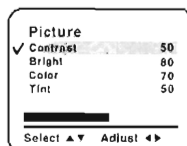

# Connections

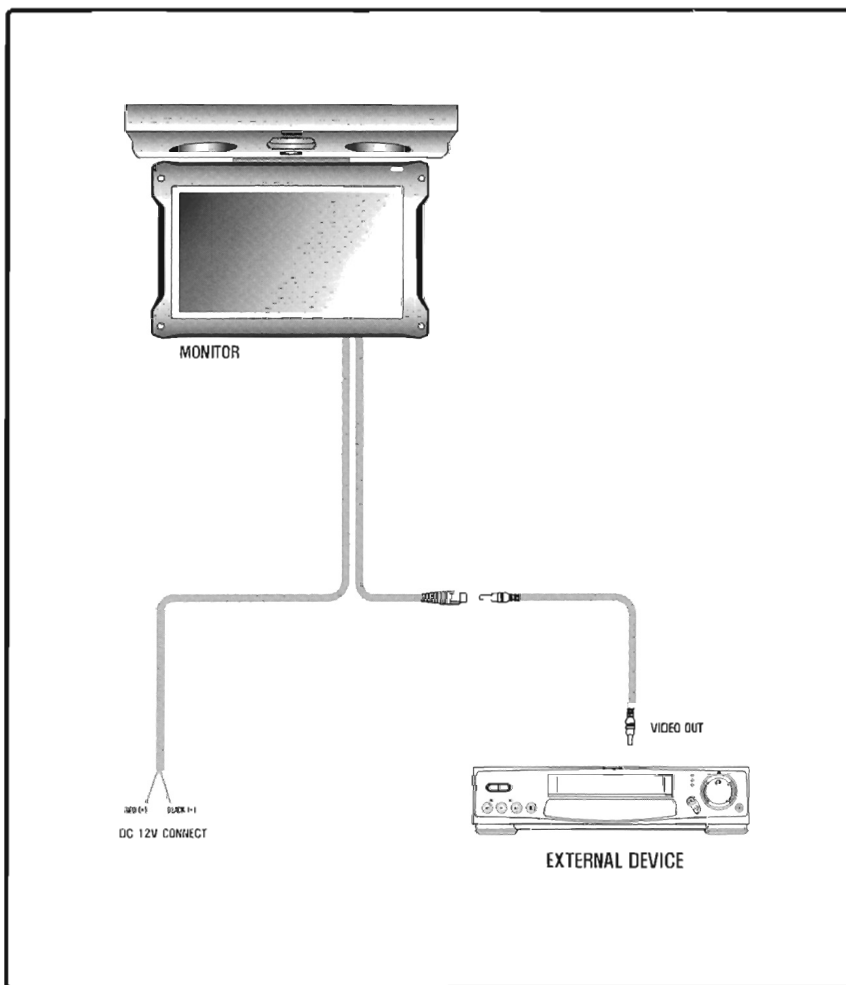

## Specifications

Model	T-721CM
Power Requirements	12V
Current Consumption	7W
Screen Size	7.2" STN LCD
Screen Format	16:9 Wide
Resolution Pixel	1440 X 234
Video Inputs	1
Dimensions	(W) 257.2 X (D) 267.2 X (H) 47.9 mm

**Note** : This equipment has been tested and found to comply with the limits for a Class A digital device, pursuant to part 15 of the FCC Rules. These limits are designed to provide reasonable protection against harmful interference when the equipment is operated in a commercial environment. This equipment generates, uses, and can radiate radio frequency energy and, if not installed and used in accordance with the instruction manual, may cause harmful interference to radio communications. Operation of this equipment in a residential area is likely to cause harmful interference in which case the user will be required to correct the interference at his own expense.



## Free Manuals Download Website

<http://myh66.com>

<http://usermanuals.us>

<http://www.somanuals.com>

<http://www.4manuals.cc>

<http://www.manual-lib.com>

<http://www.404manual.com>

<http://www.luxmanual.com>

<http://aubethermostatmanual.com>

Golf course search by state

<http://golfingnear.com>

Email search by domain

<http://emailbydomain.com>

Auto manuals search

<http://auto.somanuals.com>

TV manuals search

<http://tv.somanuals.com>