

OWNER'S MANUAL
RETAIN FOR FUTURE REFERENCE
TOLL FREE CUSTOMER SERVICE
1.888.800.1167

MODEL NUMBER: 51552B

SERIAL NUMBER:



APPLICATION STANDARD



ASSEMBLY
OPERATING INSTRUCTIONS
CONDITIONING GUIDELINES
WARRANTY
SERVICE



EVO TAHOE Home Gym

Adjustable Incline Bench

For future service or related questions.

Please staple your receipt and/or write in the name and phone number of the retail store where you purchased your EVO home gym.

Name:

Phone Number:

Receipt:

Open the boxes

You are now ready to open the boxes of your new equipment. Make sure to inventory all of the parts that are included in the boxes. Check the Parts List for a full count of the number of parts included for this product to be assembled properly. If you are missing any parts or have any assembly questions contact your local Smooth Retailer.

Gather your tools

Before starting the assembly of your unit, make sure that you have gathered all the necessary tools you may require to assemble the unit properly. Having all of the necessary equipment at hand will save time and make the assembly quick and hassle-free.

Clear your work area

Make sure that you have cleared away a large enough space to properly assemble the unit. Make sure space is flat, level and free from anything that may cause injury during assembly. After the unit is fully assembled, make sure there is a comfortable amount of free area around the unit for unobstructed operation.

Invite a friend

Some of the assembly steps may require heavy lifting. It is recommended that you obtain the assistance of another person when assembling this product.

| NUMBER | DESCRIPTION | QUANTITY | ORDER NUMBER |
|--------|------------------|----------|--------------|
| 201 | FRONT STABILIZER | 1 | 51552B-201 |
| 202 | MAIN FRAME | 1 | 51552B-202 |
| 203 | REAR STABILIZER | 1 | 51552B-203 |
| 204 | BACK BONE | 1 | 51552B-204 |
| 205 | SEAT ARM | 1 | 51552B-205 |
| 209 | BACK PAD | 1 | 51552B-209 |
| 210 | SEAT PAD | 1 | 51552B-210 |
| 214 | 2" SQ END CAP | 2 | 51552B-214 |
| 215 | 2" SQ END PLUG | 4 | 51552B-215 |

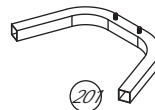

201

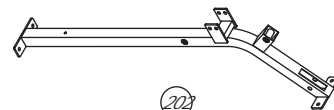

202

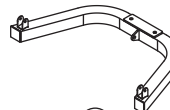

203



204

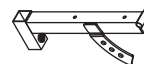

205

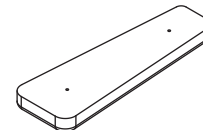

209

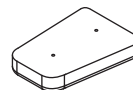

210

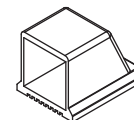

214



215

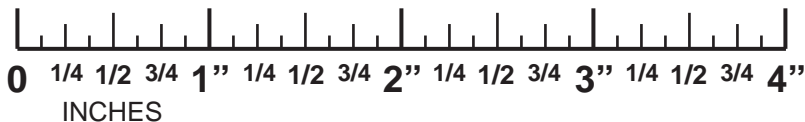

A MAJORITY OF THE LISTED HARDWARE IS ALREADY IN PLACE

| NUMBER | DESCRIPTION | QUANTITY | ORDER NUMBER |
|--------|---|----------|--------------|
| 220 | STOPPER | 1 | 51552B-220 |
| 221 | WHEEL | 2 | 51552B-221 |
| 222 | POP PIN | 2 | 51552B-222 |
| 225 | 1/2" STEEL BUSHING | 4 | 51552B-225 |
| 226 | 3/8" X 1/2" BUSHING | 2 | 51552B-226 |
| 227 | 1/2" X 4-1/4" HEX HEAD BOLT | 2 | 51552B-227 |
| 228 | 1/2" X 3-1/8" HEX HEAD BOLT | 2 | 51552B-228 |
| 229 | 3/8" X 2-3/4" HEX HEAD BOLT | 1 | 51552B-229 |
| 230 | 5/16" X 1-1/2" HEX HEAD BOLT | 2 | 51552B-230 |
| 231 | 3/8" X 2-3/4" HEX HEAD BOLT _(ALL THREADED) | 4 | 51552B-231 |
| 232 | 3/8" X 5/8" INNER HEX HEAD SCREW | 1 | 51552B-232 |
| 235 | 1/2" WASHER | 10 | 51552B-235 |
| 237 | 3/8" WASHER | 6 | 51552B-237 |
| 240 | 1/2" NYLON NUT | 6 | 51552B-240 |
| 241 | 3/8" NYLON NUT | 1 | 51552B-241 |
| 242 | 5/16" NYLON NUT | 2 | 51552B-242 |

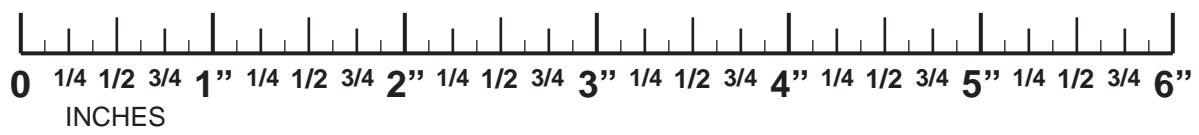
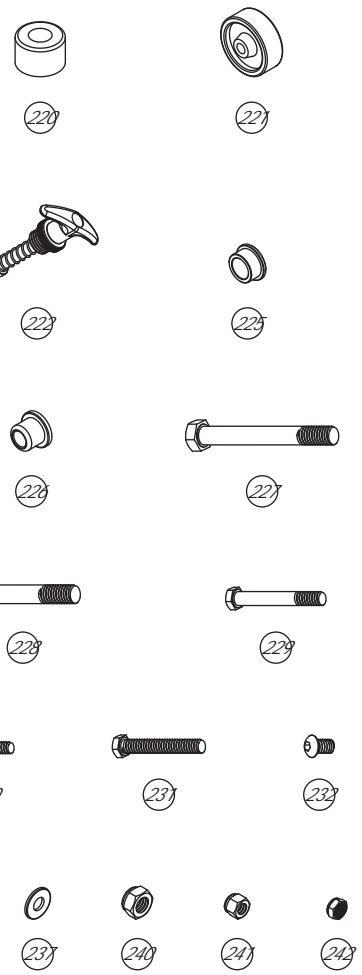

MANY PARTS SHOWN HAVE BEEN PRE-ASSEMBLED BY THE FACTORY

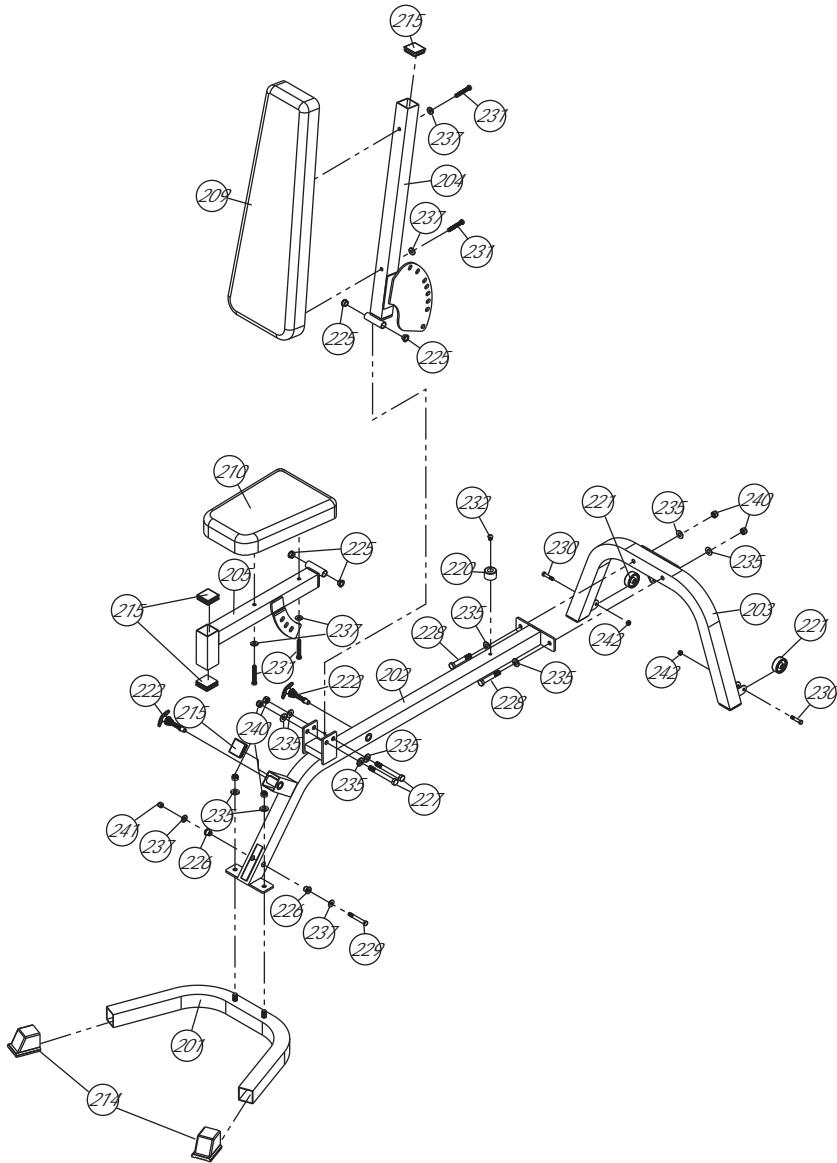

Step 1:

Cap Front Stabilizer (201) with 2" Sq End Caps (214). Place Front Stabilizer (201) on the floor.

Cap Main Frame (202) with 2" Sq End Plug (215). Attach Stopper (220) to Main Frame (202) using 3/8" x 5/8" Inner Hex Head Screw (232). Attach Main Frame (202) to Front Stabilizer (201) using two 1/2" Washers (235) and two 1/2" Nylon Nuts (240).

Attach Wheels (221) to the bracket on Rear Stabilizer (203) each using 5/16" x 1-1/2" Hex Head Bolts (230) and 5/16" Nylon Nut (242). Attach Rear Stabilizer (203) to Main Frame (202) using two 1/2" x 3-1/8" Hex Head Bolts (228), four 1/2" Washers (235) and two 1/2" Nylon Nuts (240).

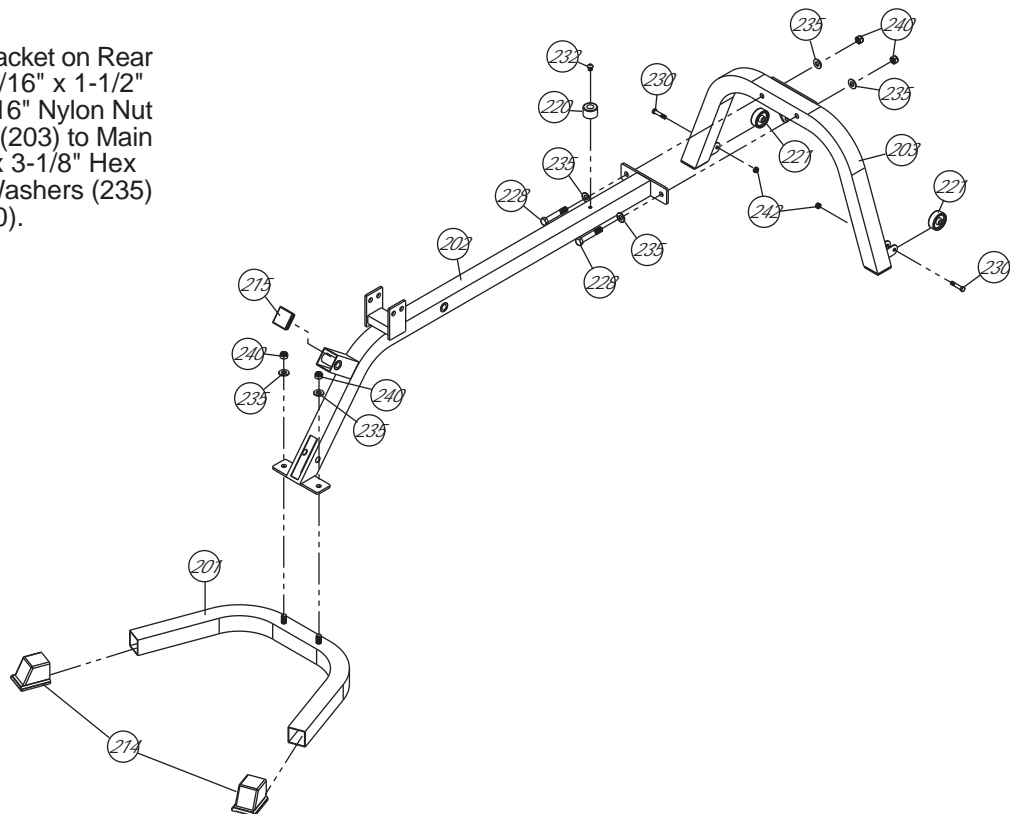

Step 2:

Cap Back Bone (204) with 2" Sq End Plug (215). Attach Back Pad (209) to Back Bone (204) using two 3/8" x 2-3/4" Hex Head Bolts (231) and two 3/8" Washers (237). Insert two 1/2" Steel Bushings (225) to the sleeve on Back Bone (204).

Attach Back Bone (204) to the bracket on Main Frame (202) using 1/2" x 4-1/4" Hex Head Bolt (227), two 1/2" Washers (235) and 1/2" Nylon Nut (240). Lock Back Bone (204) with Pop Pin (222).

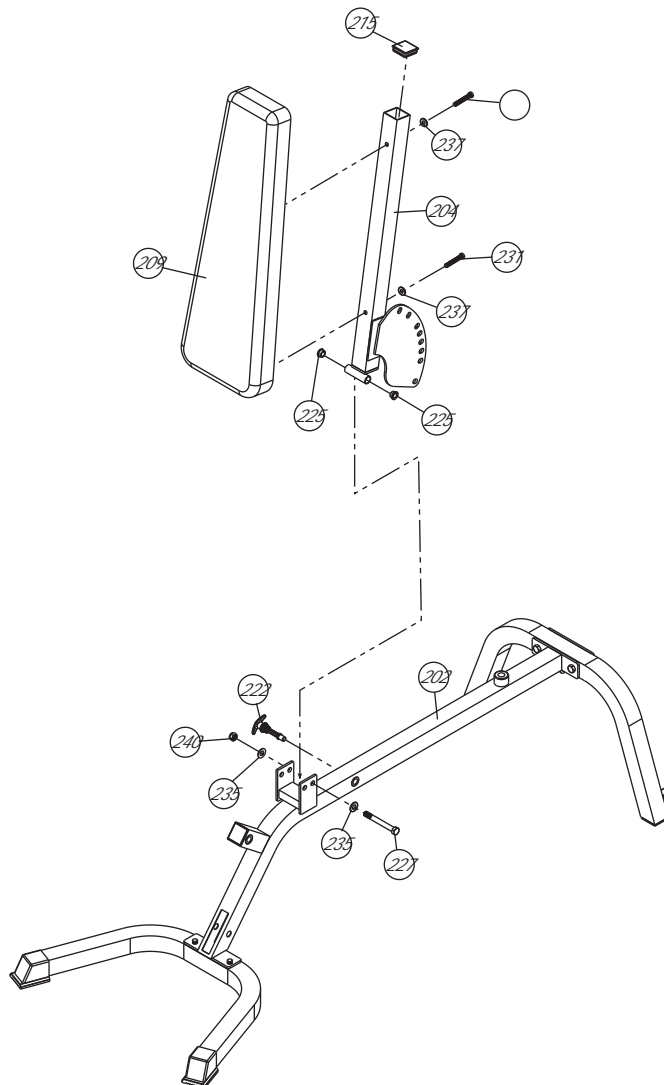

Step 3:

Attach Seat Pad (210) to Seat Arm (205) using two 3/8" x 2-3/4" Hex Head Bolts (231) and two 3/8" Washers (237). Insert two 1/2" Steel Bushing (225) to the sleeve on Seat Arm (205).

Attach Seat Arm (205) to the bracket on Main Frame (202) using 1/2" x 4-1/4" Hex Head Bolt (227), two 1/2" Washers (235) and 1/2" Nylon Nut (240). Lock Seat Arm (205) with Pop Pin (222). Insert 2" Sq End Plugs (215) into Seat Arm 205.

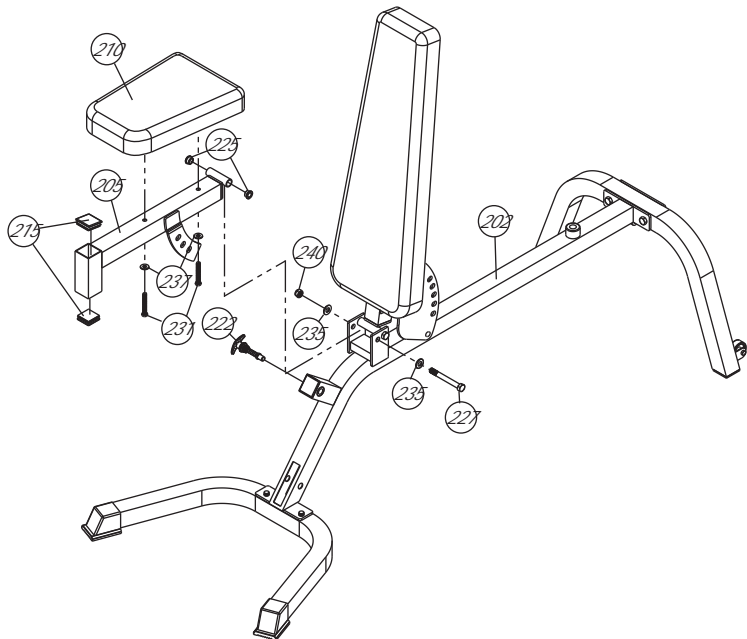

Warranty Coverage: Smooth Fitness, Inc. ("Smooth Fitness") warrants to the original purchaser that each new product to be free from defects in workmanship and material, under normal use and conditions.

Period of Coverage: The Warranty on this product runs for the period of the lifetime of the original purchaser. This is a Parts-only Warranty, labor is not included. Smooth Fitness reserves the right to inspect damaged parts for misuse.

It is recommended that the Original Receipt be kept with the product manual.

Remedy Provided by Smooth Fitness: Smooth Fitness will provide a replacement part free of charge if a defect is found during the Warranty period. You must pay any charges for shipping and handling outside of the Continental United States and for labor. To obtain service call your local Smooth Retailer.

Parts repaired or replaced pursuant to this Warranty shall be warranted for the unexpired portion of the Warranty applying to the original product. Any technical advice furnished before or after delivery in regard to the use or application of Smooth Fitness products is furnished without charge and on the basis that it represents Smooth Fitness' best judgment under the circumstances but that the advice is used at your sole risk.

Procedure for Obtaining Your Remedy Under This Warranty: To obtain service call your local Smooth Retailer. To help us assist you, please have the following information ready:

Model name or number from the cover of the manual;
Serial number located on the frame of the unit; and
The part description and the order number.

Limitations on Warranty: This Warranty will only apply to the original end user. This Warranty does not cover any problems, damages or failures that are caused by accident, improper assembly, failure to observe cautionary labels on the product, failure to operate the product correctly, abuse or freight damage. Smooth Fitness does not warrant against any damage or defects that may result from repair or alterations made to the product by an unauthorized repair facility.

This Warranty shall terminate if you sell or otherwise transfer this product. This Warranty does not apply to any product shipped or handled outside of the United States. This Warranty does not apply if the product is used for rental or commercial use. Consequential and incidental damages are not recoverable under this Warranty. (Some states do not allow the exclusion or limitation of incidental or consequential damages, so the above limitation or exclusion may not apply to you.)

THIS WARRANTY IS EXPRESSLY IN LIEU OF ALL OTHER EXPRESS WARRANTIES. ALL IMPLIED WARRANTIES, INCLUDING WARRANTIES OF MERCHANTABILITY OR FITNESS FOR ANY PARTICULAR PURPOSE, ARE LIMITED IN DURATION TO ONE (1) YEAR FROM THE EFFECTIVE DATE OF THIS WARRANTY. SMOOTH FITNESS IS NOT LIABLE FOR CONSEQUENTIAL OR INCIDENTAL DAMAGES RESULTING FROM ANY DEFECT IN PARTS NOR FOR ANY BREACH OF EXPRESS OR IMPLIED WARRANTIES. SMOOTH FITNESS' SOLE LIABILITY UNDER THIS WARRANTY IS LIMITED TO THE TERMS DESCRIBED IN THIS FORM.

THIS WARRANTY GIVES YOU SPECIFIC LEGAL RIGHTS, AND YOU MAY ALSO HAVE OTHER RIGHTS WHICH VARY FROM STATE TO STATE.

For assistance with assembly or to order replacement parts, simply call your local Smooth Retailer. To help them assist you, please have the following information ready:

Model name or number from the cover of the manual;
Serial number located on the frame of the unit; and
The part description and order number.

Warning

Before using this product, please consult your personal physician for a complete physical examination. Frequent and strenuous exercise should be approved by your doctor. If any discomfort should result from your use of this product, stop exercising and consult your doctor. Proper usage of this product is essential. Please read your manual carefully before exercising.

Please keep all children away from the equipment during use and when equipment is unattended.

Always wear appropriate clothing, including athletic shoes, when exercising. Do not wear loose clothing that could become caught during exercising.

Make sure that all bolts and nuts are tightened when equipment is in use. Periodic maintenance is required on all exercise equipment to keep it in good condition.

Before beginning

How you begin your exercise program depends on your physical condition. If you have been inactive for several years, or are severely overweight, you must start slowly and increase your time gradually, a few minutes per week.

Initially you may be able to exercise only for a few minutes in your target zone. However, your aerobic fitness will improve over the next six to eight weeks. Don't be discouraged if it takes longer. It's important to work at your own pace. Ultimately, you'll be able to exercise continuously for 30 minutes. And the better your aerobic fitness, the harder you will have to work to stay in your target zone. But remember these essentials:

>Contact your physician before starting a workout or training program. Have your doctor review your training and diet programs to advise you of a workout routine you should adopt.

>Begin your training program slowly with realistic goals that have been set by you and your doctor.

>Supplement your program with some type of aerobic exercise such as walking, jogging, swimming, dancing and/or bicycling.

Monitor your pulse frequently. If you do not have an electronic heart rate monitor, have your physician show you the proper way to manually check your pulse by using your wrist or neck. Establish your target heart rate based on your age and condition.

>Drink plenty of fluids during the course of your routine. You must replace the water content lost from excessive exercising to avoid dehydration. Avoid drinking large amounts of cold liquids. Fluids should be at room temperature when consumed.



The Surgeon General has determined that lack of physical activity is detrimental to your health.™

Finding your pulse

To make sure your heart is beating in its target zone, you'll need to know how to monitor your heart rate. The easiest way is to feel the pulse in the carotid artery on either side of your neck, between the windpipe and the large neck muscles. Count

the number of beats in ten seconds, then multiply by six. This gives you the number of beats per minute.

How fast should your heart beat during aerobic exercise? Fast enough to reach and stay in its

"target zone," a range of beats per minute that is largely determined by your age and physical condition. To determine your target zone, consult the chart we have provided.

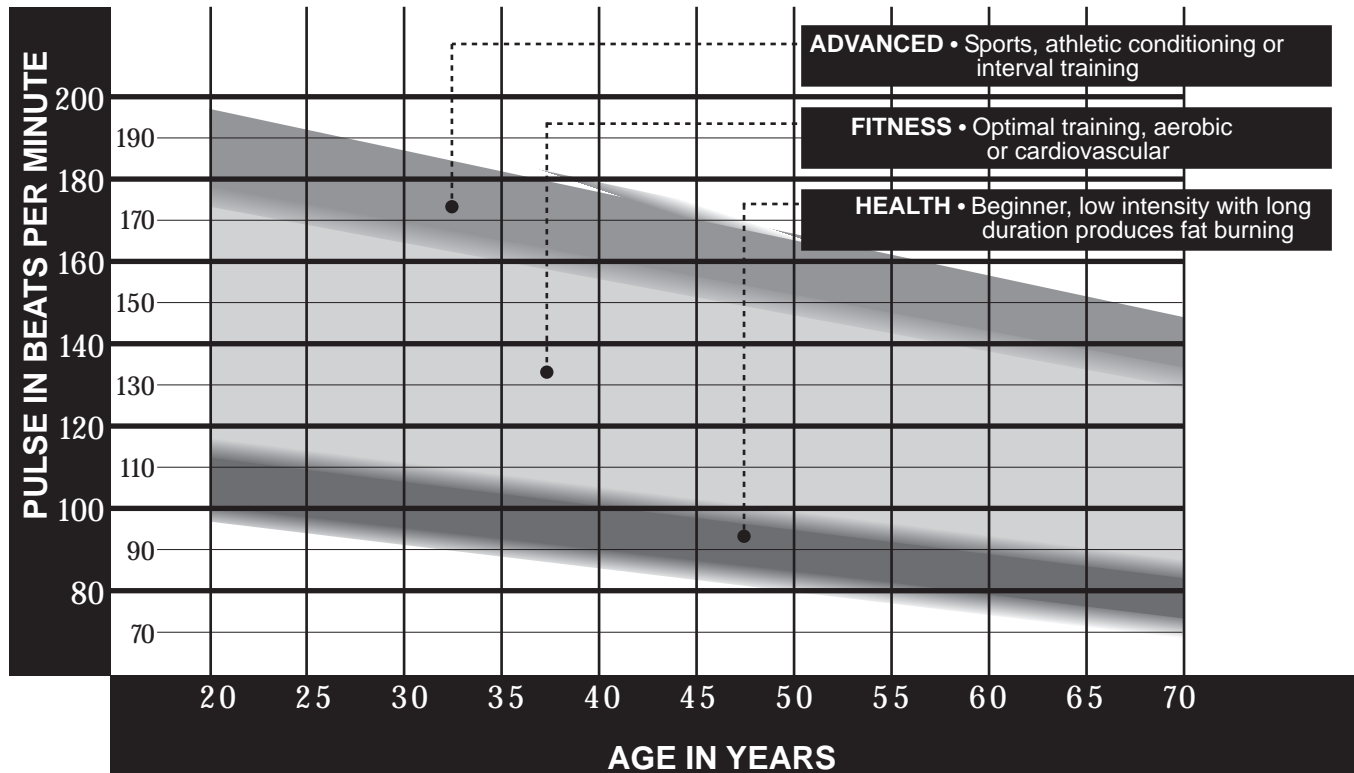

Aerobic exercise is any sustained activity that sends oxygen to your muscles via your heart and lungs. It will improve the fitness of your lungs and heart: your body's

most important muscle. Aerobic fitness is promoted by any activity that uses your large muscle groups - arms, legs or buttocks, for example. Your heart beats quickly and you

breath deeply. An aerobic exercise should be part of your entire exercise routine.

The exercise routine that is performed on this product will develop lower body muscle groups. These muscle groups are shown on the chart below.

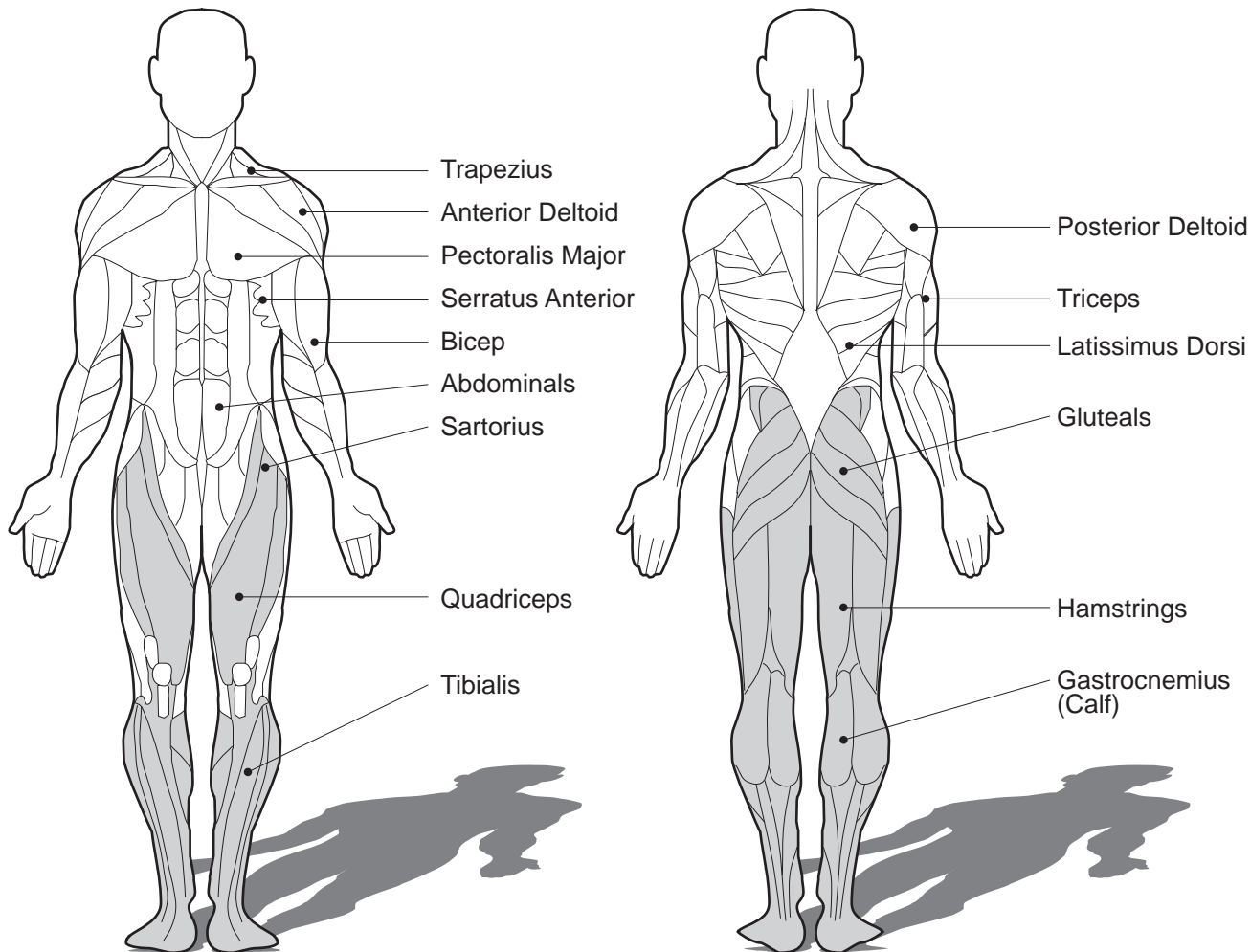

A successful exercise program consists of a warm-up, aerobic exercise, and a cool-down. Do the entire program at least two and preferably three times a week, resting for a day between workouts. After several months, you can increase your workouts to four or five times per week.

Warming up is an important part of your workout, and should begin every session. It prepares your body for more strenuous exercise by heating up and stretching out your muscles, increasing your circulation and pulse rate, and delivering more oxygen to your muscles. At the end of your workout, repeat these exercises to reduce sore muscle problems. We suggest the following warm-up and cool-down exercises:

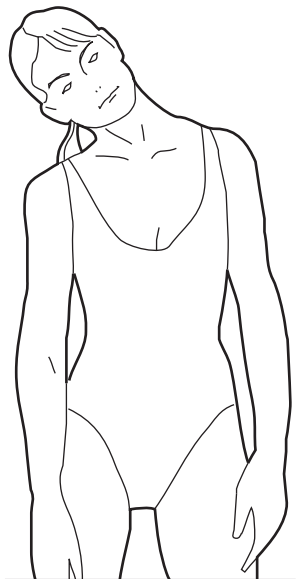

Head Roll

Rotate your head to the right for one count, feeling the stretch up the left side of your neck. Next, rotate your head back for one count, stretching your chin to the ceiling and letting your mouth open. Rotate your head to the left for one count, and finally, drop your head to your chest for one count.



Inner Thigh Stretch

Sit with the soles of your feet together with your knees pointing outward. Pull your feet as close into your groin as possible. Gently push your knees towards the floor. Hold for 15 counts.

Hamstring Stretch

Sit with your right leg extended. Rest the sole of your left foot against your right inner thigh. Stretch toward your toe as far as possible. Hold for 15 counts. Relax and then repeat with left leg extended.

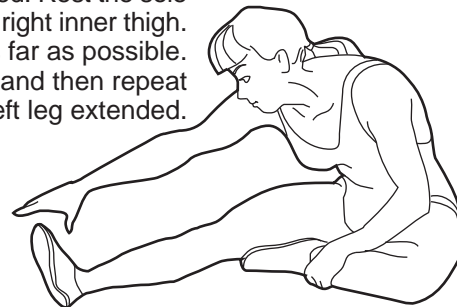

Shoulder Lift

Lift your right shoulder up toward your ear for one count. Then lift your left shoulder up for one count as you lower your right shoulder.

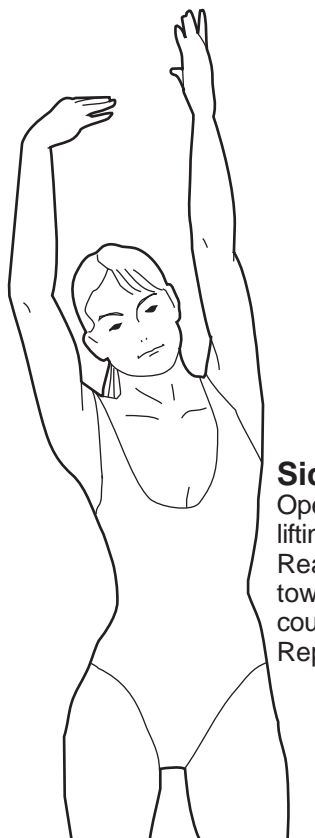

Side Stretch

Open your arms to the side and continue lifting them until they are over your head. Reach your right arm as far upward toward the ceiling as you can for one count. Feel the stretch up your right side. Repeat this action with your left arm.

Calf-Achilles Stretch

Lean against a wall with your left leg in front of the right and your arms forward. Keep your right leg straight and the left foot on the floor; then bend the left leg and lean forward by moving your hips toward the wall. Hold, then repeat on the other side for 15 counts.

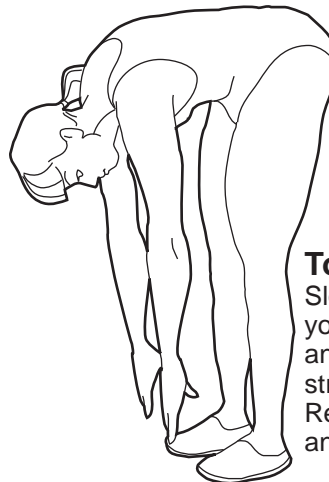
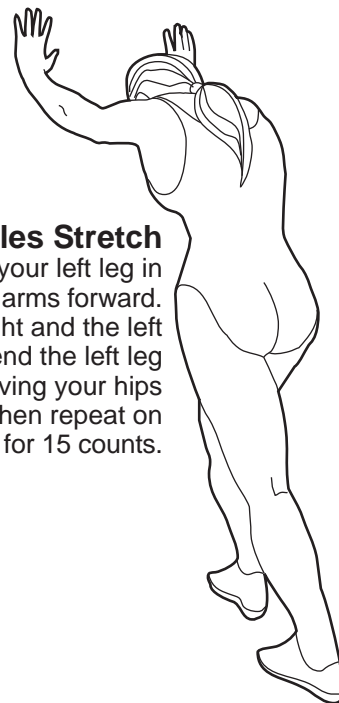

Toe Touch

Slowly bend forward from your waist, letting your back and shoulders relax as you stretch toward your toes. Reach down as far as you can and hold for 15 counts.



Smooth Fitness
717 Fellowship Road
Suite C
Mt. Laurel, NJ 08054

Copyright © 2002

Download from www.Somanuals.com. All Manuals Search And Download.

Free Manuals Download Website

<http://myh66.com>

<http://usermanuals.us>

<http://www.somanuals.com>

<http://www.4manuals.cc>

<http://www.manual-lib.com>

<http://www.404manual.com>

<http://www.luxmanual.com>

<http://aubethermostatmanual.com>

Golf course search by state

<http://golfingnear.com>

Email search by domain

<http://emailbydomain.com>

Auto manuals search

<http://auto.somanuals.com>

TV manuals search

<http://tv.somanuals.com>