

DENON

AV SURROUND AMPLIFIER

AVC-A1HD

AV SURROUND PRE-AMPLIFIER

AVP-A1HD

Owner's Manual [Upgrade version]

The owner's manual is organized in the following two volumes.

- [Original version]
- [Upgrade version] This version

NOTE

- Products that have been upgraded cannot be returned to the previous state.
- This model has been upgraded previously. This manual contains details of all of the upgrades. Therefore, you do not need any manuals other than the "Original version" and "Upgrade version" (this version).

□ Symbols used in this manual

AVC-A1HD

This symbol indicates contents for AVC-A1HD.

AVP-A1HD

This symbol indicates contents for AVP-A1HD.



This symbol indicates items described in the "Original version".

Contents

Getting Started

Accessories	2
Functions that are added/changed/deleted by this upgrade	2, 3
Changes to the Panel Display	4
Front Panel	4
Rear Panel	4
Part Names and Functions	5
Front Panel	5
Display	5
Remote Control Unit	6

Connections

Speaker Installation	6
Speaker Layout	6
Speaker Connections	7, 8
Connecting Equipment with HDMI connectors	9
Connections to Other Devices	9
External Power Amplifier	9

GUI Menu Operations

GUI Menu Map	10, 11
--------------	--------

Auto Setup

Auto Setup	12, 13
1 Auto Setup	14 ~ 21
2 Option	22
3 Parameter Check	22

Manual Setup

Speaker Setup	23
1 Speaker Configuration	23
2 Subwoofer Setup	24
3 Distance	24
4 Channel Level	24, 25
5 Crossover Frequency	25
6 THX Audio Setup	25

Audio Setup

1 EXT. IN Setup	26
2 2ch Direct/Stereo	26, 27
3 Auto Surround Mode	27
4 Manual EQ	27

Option Setup

1 Amp Assign (AVC-A1HD only)	28
1 Pre-out Assign (AVP-A1HD only)	29
2 XLR Out Polarity (AVP-A1HD only)	30
3 POA Setting (AVP-A1HD only)	30
2 Volume Control (AVP-A1HD : 4)	30
3 Source Delete (AVP-A1HD : 5)	30
4 GUI (AVP-A1HD : 6)	31
5 Quick Select Name (AVP-A1HD : 7)	31
6 Trigger Out 1 (AVP-A1HD : 8)	32
7 Trigger Out 2 (AVP-A1HD : 9)	32
8 Trigger Out 3 (AVP-A1HD : 10)	32
9 Trigger Out 4 (AVP-A1HD : 11)	32
10 Transducer Setup (AVP-A1HD : 12)	32
11 Digital Out (AVP-A1HD : 13)	33
12 Remote ID (AVP-A1HD : 14)	33
13 232C Port (1) (AVP-A1HD : 15)	33
14 Dimmer (AVP-A1HD : 16)	33
15 Setup Lock (AVP-A1HD : 17)	33
16 Maintenance Mode (AVP-A1HD : 18)	33
17 Firmware Update (AVP-A1HD : 19)	34
18 Add New Feature (AVP-A1HD : 20)	34

Surround Mode

HOMETHX CINEMA	35
Surround Playback of 2-channel Sources	35
Playing Multi-channel Sources (Dolby Digital, DTS, etc.)	35
Standard Playback	36
Surround Playback of 2-channel Sources	36
Playing Multi-channel Sources (Dolby Digital, DTS, etc.)	37

Parameters

Audio	38
1 Surround Parameters	38 ~ 40
2 Tone	40
3 Audyssey Settings	41, 42
4 A-DSX Soundstage	42, 43
5 RESTORER	43
6 Audio Delay	43

Information

Status	44
1 MAIN ZONE	44
2 ZONE2/3/4	44
Quick Select	44

Other Operations and Functions

Amp Assign / Multi-Zone Connections and Operations

(AVC-A1HD only)	46 ~ 61
-----------------	---------

Other Information

Troubleshooting

Specifications

Getting Started

Thank you for purchasing this DENON product. To ensure proper operation, please read this owner's manual carefully before using the product.

After reading them, be sure to keep them for future reference.

Accessories

Check that the following parts are supplied with the product.

- ① CD-ROM (Owner's manual)..... 1
- ② Setup microphone (DM-A409, Cord length: Approx. 6.0 m).... 1

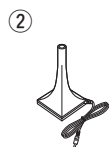

Note that the illustrations in this instructions are for explanation purposes and may differ from the actual unit.

Functions that are added/changed/deleted by this upgrade

When this product is upgraded, all settings return to the default settings. Reconfigure settings as required.

Additional functions

Audyssey Dynamic Volume®

Audyssey Dynamic Volume® is technology that solves the problem of large variations in volume level between television programs, commercials, and between the soft and loud passages of movies.

DENON LINK 4th (Jitter-free playback)

DENON LINK 4th adds high-quality playback of HD audio in addition to the outstanding performance of DENON LINK 3rd, high quality audio signal transmission technology developed by DENON.

By connecting an AV amplifier and Blu-ray Disc player that both support DENON LINK 4th with a DENON LINK cable (supplied with the Blu-ray Disc player) and HDMI cable (sold separately), you can control the Blu-ray Disc player using the master clock signal sent from the AV amplifier.

As D/A conversion is performed by the AV amplifier master clock, there are no effects of clock jitter from the HDMI transfer, enabling jitter free playback.

Sound localization becomes clearer, producing the clear sense of space in the sound images that can only be achieved from HD audio.

Audyssey DSX™

By connecting front height speakers to this unit and playing back through Audyssey DSX™, you can experience a more powerful playback expression in the height audio range. By connecting front wide speakers, you can experience a more powerful playback expression in the wide audio range.

Dolby Pro Logic IIz

Dolby Pro Logic IIz introduces a new dimension to Home Entertainment through the addition of a pair of front height channels. Compatible with stereo, 5.1-channel and 7.1-channel content, Dolby Pro Logic IIz provides enhanced spaciousness, depth and dimension to movies, concert video and video game playback while maintaining the full integrity of the source mix.

Dolby Pro Logic IIz identifies and decodes spatial cues that occur naturally in all content, directing this information to the front height channels, complementing the performance of left and right surround sound speakers. Content that is encoded Explanation of terms with Dolby Pro Logic IIz height channel information can be even more revealing, with perceptually discrete height channel information bringing an exciting new dimension to home entertainment.

Dolby Pro Logic IIz, with front height channels is also an ideal alternative for households that cannot support the placement of back surround speakers of a typical 7.1-channel system but may have bookshelf space available to support the addition of height speakers.

HDMI (Ver. 1.4a with 3D)

This unit can output 3D video signals input from a Blu-ray Disc player to a TV that supports a 3D system.

DTS Neo:X

This technology enables the playback of 2-channel source audio or 7.1/5.1 multi-channel source audio through a maximum 9.1 channel speakers, achieving an even broader sound field.

Changed Functions

Support for front height speakers and front wide speakers

Front height or front wide channels can be played back through the FH/FW/AMP ASSIGN-2 speaker terminals and the PRE OUT FH/FW terminals. This enables you to enjoy a maximum 9.3 channel surround playback.

Audyssey MultEQ® XT 32

Audyssey MultEQ® corrects both time and frequency response problems in the listening area so that every listener can enjoy music and movie with the optimum sounds. It performs a fully automated surround system setup. The unit is equipped Audyssey MultEQ® XT 32 that can correct much higher details, particularly in the bass range of the speakers. The high resolution correction reproduces much clearer surround sound.

Direct Mode function (Multi-channel)

When multi-channel signals are input, the signals are output directly without being mixed-down to 2 channels.

Surround Back function

When surround back speakers are used and a surround back signal is recorded in the input signal, audio is output automatically from the surround back speakers.

Web Control function

When this product is upgraded, previously saved contents cannot be called.

After completing the upgrade, reconfigure the settings.

For details on the web control operating procedures, see  page 61

 ,  page 63

.

Deleted Functions

Surround B speakers unsupported

As front height speakers and front wide speakers are now supported by this upgrade, surround B speakers can no longer be used.

Audyssey MultEQ® XT

As Audyssey MultEQ® XT 32 is supported by this upgrade, Audyssey MultEQ® XT is deleted.

DTS Neo:6

As DTS Neo:X is supported by this upgrade, DTS Neo:6 is deleted.

Night Mode function

In this upgrade, the night mode in which the volume can be set to low level for listening at nighttime is deleted. The same effect can be obtained from setting “Dynamic EQ®” and “Dynamic Volume®” in the GUI menu ( page 41) to “ON”.

Mic Select function

The Mic Select function is deleted when the product is upgraded. Only the supplied setup microphone (DM-A409) can be used.

For details on the items that are added/changed/deleted from the GUI menu, see “GUI Menu Map” ( page 10, 11).

Changes to the Panel Display

After completing the upgrade, labels are attached to the changed parts of the panel. For details of the changed parts, see the illustration below.

Front Panel

AVC-A1HD

AVP-A1HD

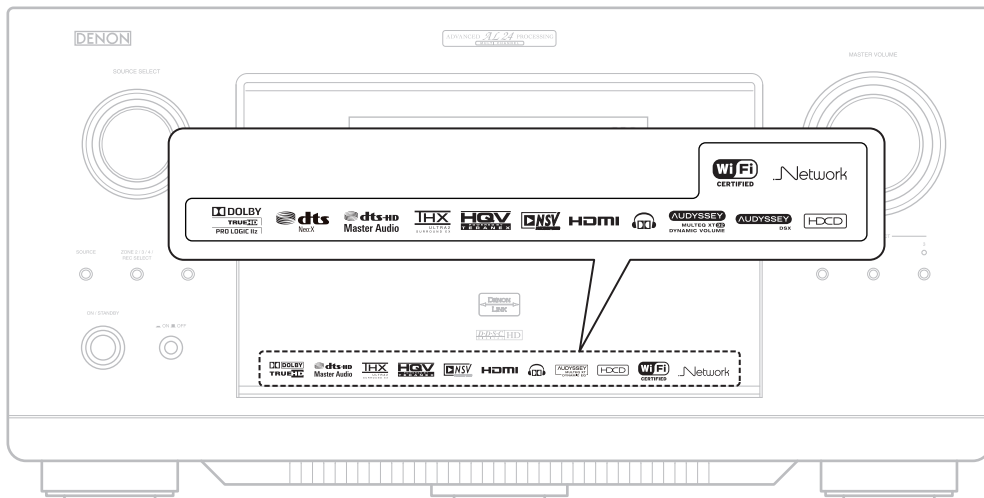

[With the door open]

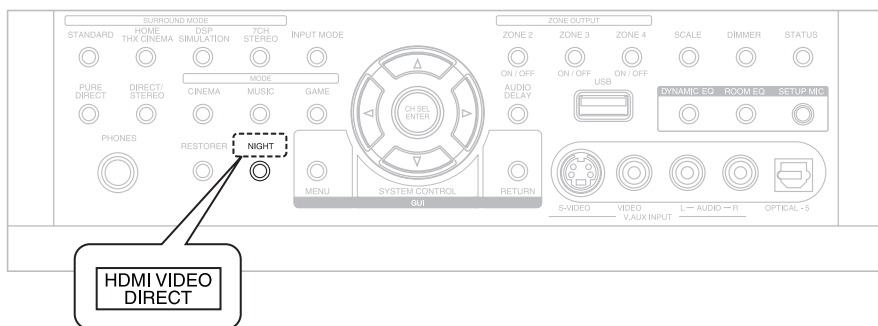

Rear Panel

AVC-A1HD

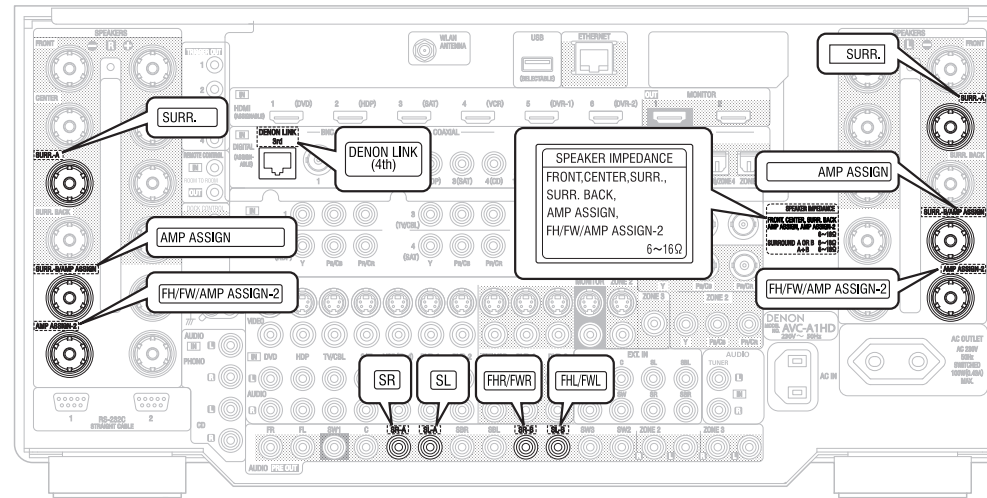

AVP-A1HD

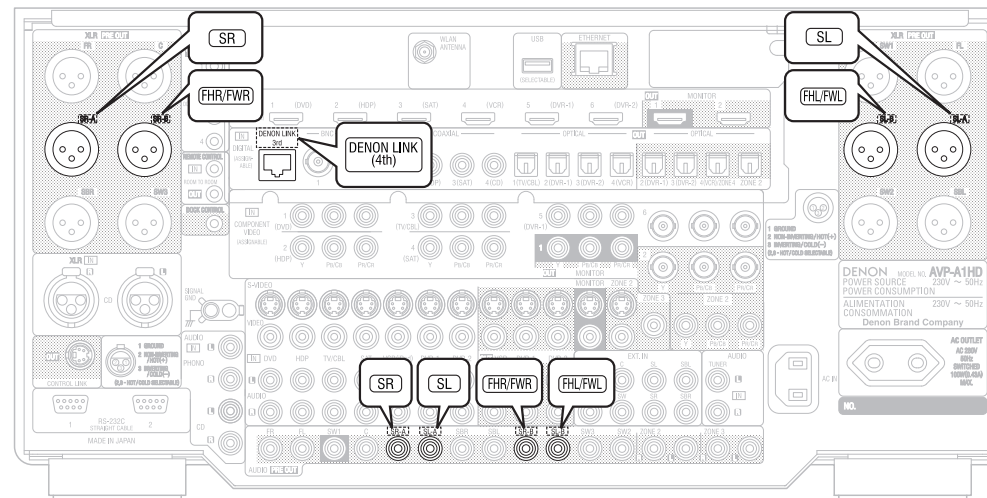

Part Names and Functions

Front Panel

When this unit is upgraded, the night mode cannot be set when the NIGHT button is pressed.

[With the door open]

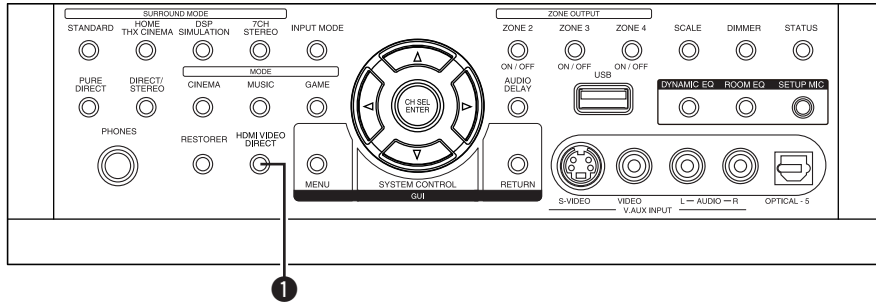

1 HDMI video direct button (HDMI VIDEO DIRECT)

When this button is pressed, video signals recorded on the BD or DVD are output directly. Video signals input from the HDMI IN terminal are output directly from the HDMI OUT terminal without being processed by this unit.



When the video direct function is on, temporary display in the GUI menu cannot be used.

Display

When the upgrade is performed, the sections highlighted in the illustration below do not light.

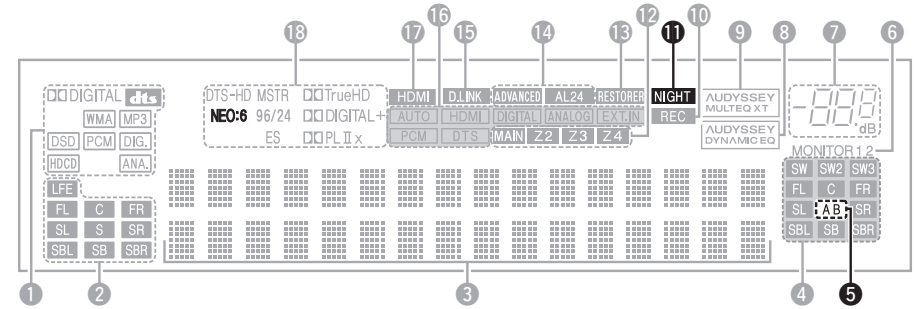

5 Surround speaker indicators

These light according to the settings of the surround A and B speakers.

11 NIGHT indicator

This lights when the night mode is selected.

NOTE

The NEO:6 indicator does not light after the upgrade because DTS NEO:X is supported.

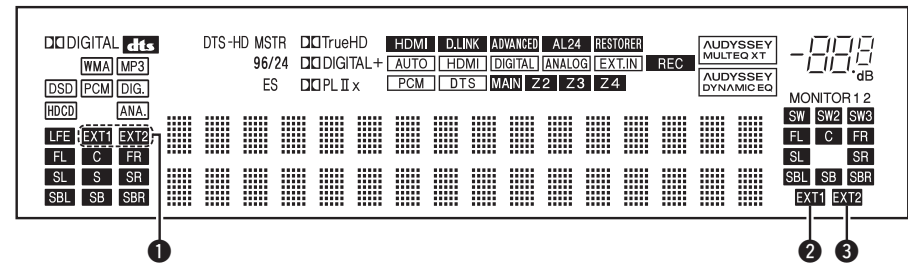

1 Input signal channel indicators

When there is 1 extension channel in the input signal, the EXT1 indicator lights. If there are two or more extension channels, the EXT1 and EXT2 indicators light.

2 Front height speaker indicator

This lights when audio signals are being output from the front height speakers.

3 Front wide speaker indicator

This lights when audio signals are being output from the front wide speakers.

Remote Control Unit

When this unit is upgraded, the night mode cannot be set when the NGT button is pressed.

■ Main remote control unit (RC-1067)

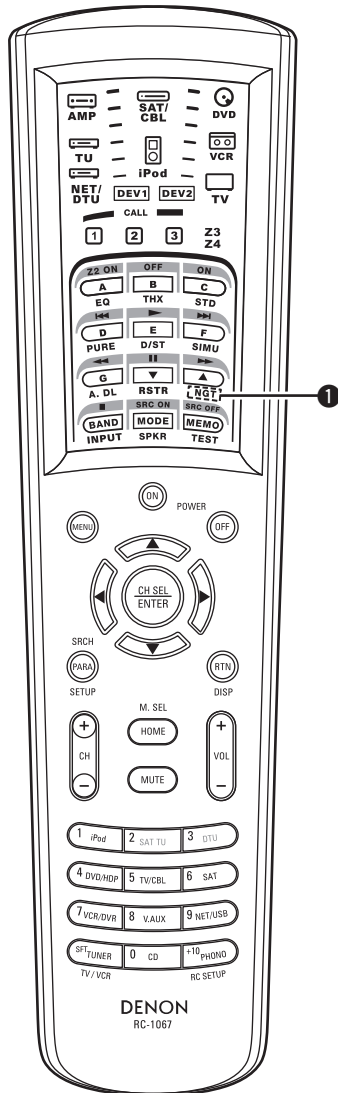

1 HDMI video direct button (NGT)

When this button is pressed, video signals recorded on the BD or DVD are output directly. Video signals input from the HDMI IN terminal are output directly from the HDMI OUT terminal without being processed by this unit.



When the video direct function is on, temporary display in the GUI menu cannot be used.

NOTE

When using 3D video devices that transmit radio communication signals (such as infrared signals etc) between the various units (such as the monitor, 3D glasses, 3D transmitter unit etc), the remote control unit may not operate due to interference from those radio communication signals. If this occurs, adjust the direction and distance of the 3D communication for each unit, and check that the remote control unit operation is not affected by these signals.

Connections

Speaker Installation

Speaker Layout

When this unit is upgraded, the speaker configurations supported by this unit change.

The table below shows a typical speaker configuration for the unit.

Configuration	Speaker		FRONT	CENTER	SURROUND		SURROUND BACK		FRONT HEIGHT		FRONT WIDE		SUBWOOFER (※2)
	L	R			L	R	L	R	1 only	L	R	L	
9.1-channels (※1)	○	○	○	○	○	○	○	○	-	○	○	-	○
7.1-channels	○	○	○	○	○	○	○	○	-	○	○	-	○
6.1-channels	○	○	○	○	○	○	○	○	○	-	-	-	○
5.1-channels	○	○	○	○	○	○	-	-	-	-	-	-	○
3.1-channels	○	○	○	-	-	-	-	-	-	-	-	-	○
2.1-channels	○	○	-	-	-	-	-	-	-	-	-	-	○
2-channels	○	○	-	-	-	-	-	-	-	-	-	-	-

※1 To perform the 9.1 channel playback using front height speakers or front wide speakers, a separate power amplifier (sold separately) is required.

※2 The unit can be connected to a maximum of 3 subwoofers.

Speaker Connections

When this unit is upgraded, the terminal names and connection methods change.

AVC-A1HD



- When using just one surround back speaker, connect it to the left channel (SBL).
- When using Subwoofer 2 or 3, set GUI menu "Manual Setup" – "Speaker Setup" – "Subwoofer Setup" (page 24).

※ L : Left
R : Right

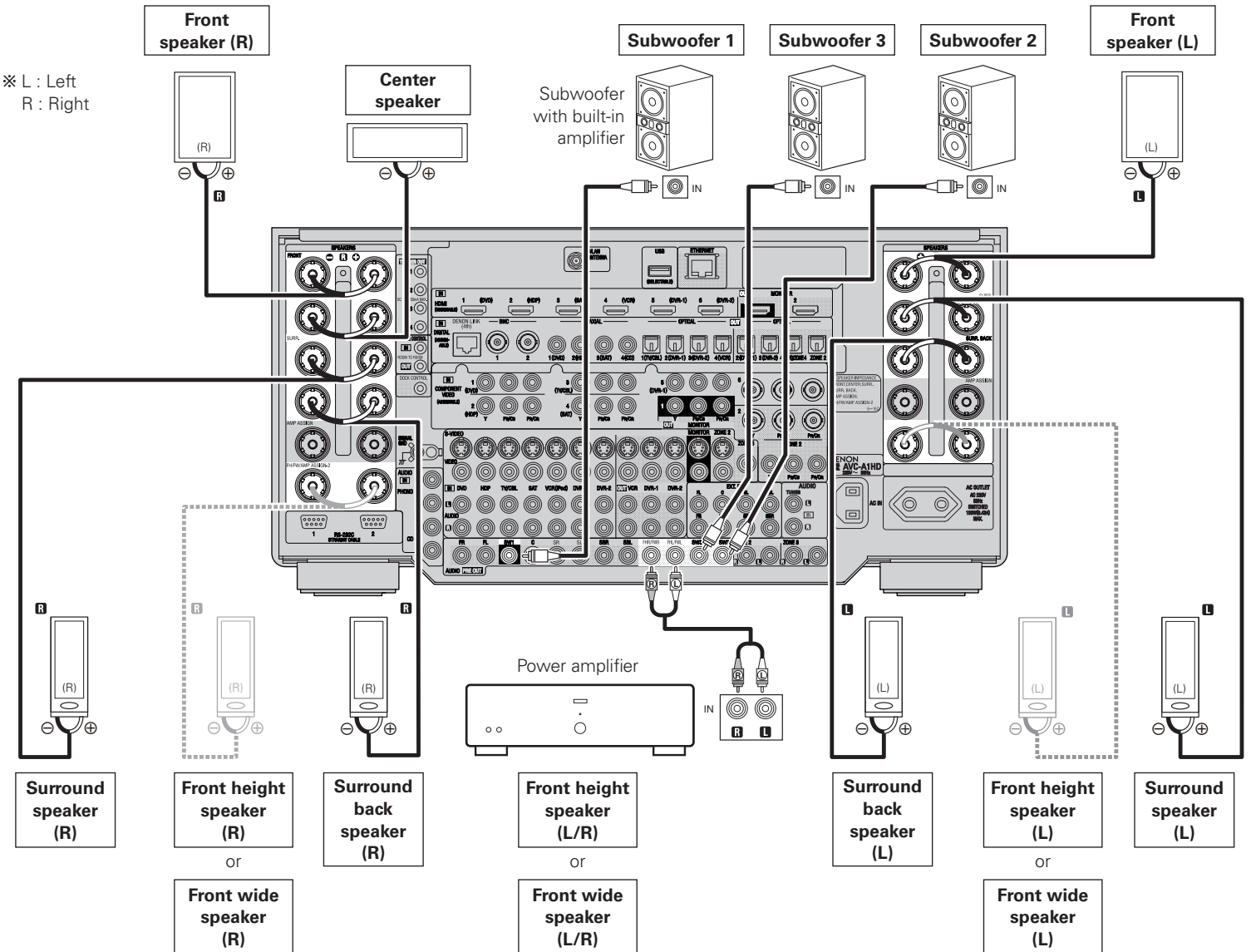

NOTE

It is not possible to use the front height speakers and front wide speakers simultaneously.

NOTE

It is not possible to use the front height speakers and front wide speakers simultaneously.

❑ Connecting the RCA pre-out terminal (Example : 9.3-channels)

※ L : Left
R : Right

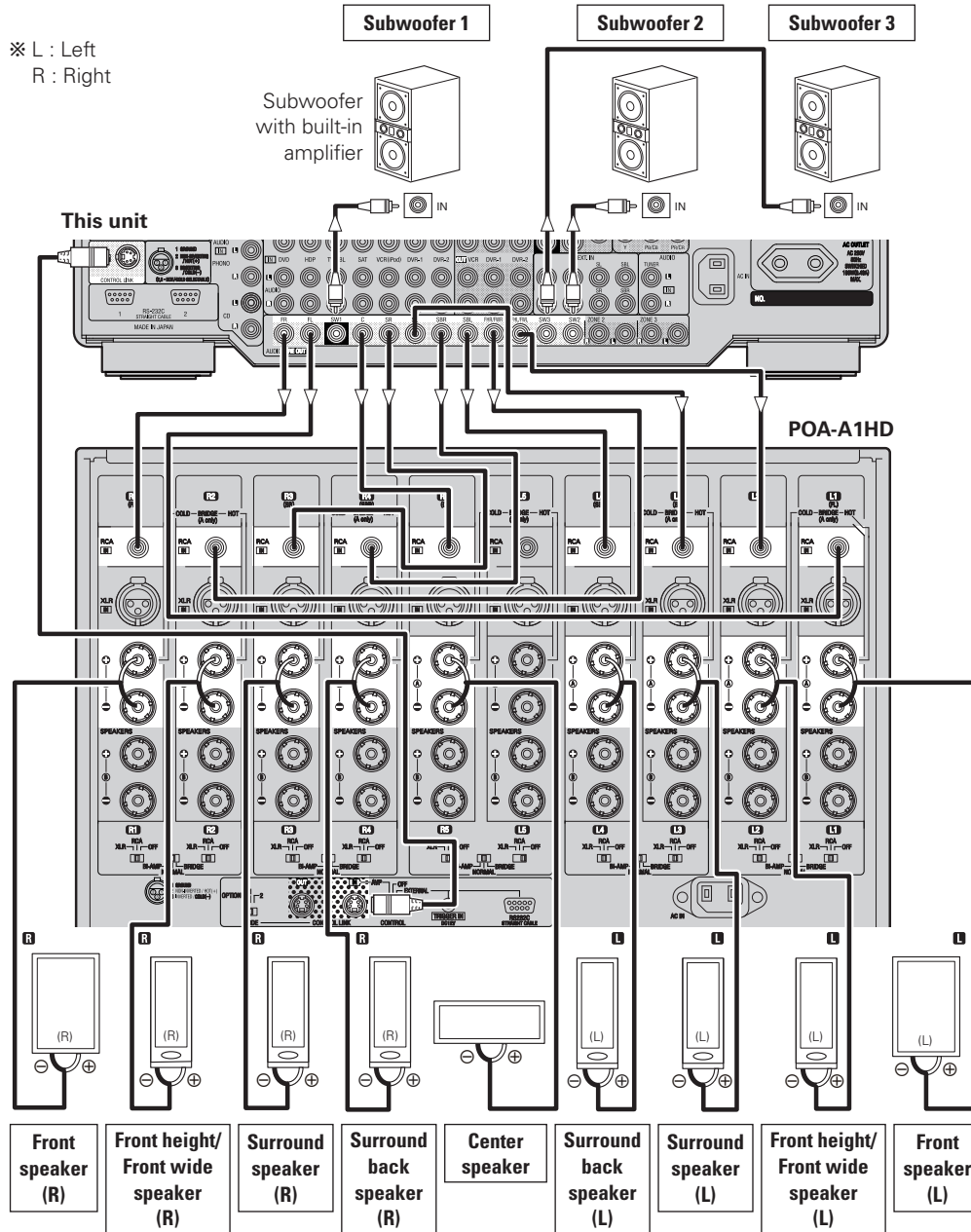

❑ Connecting the XLR pre-out terminal (Example : 9.3-channels)

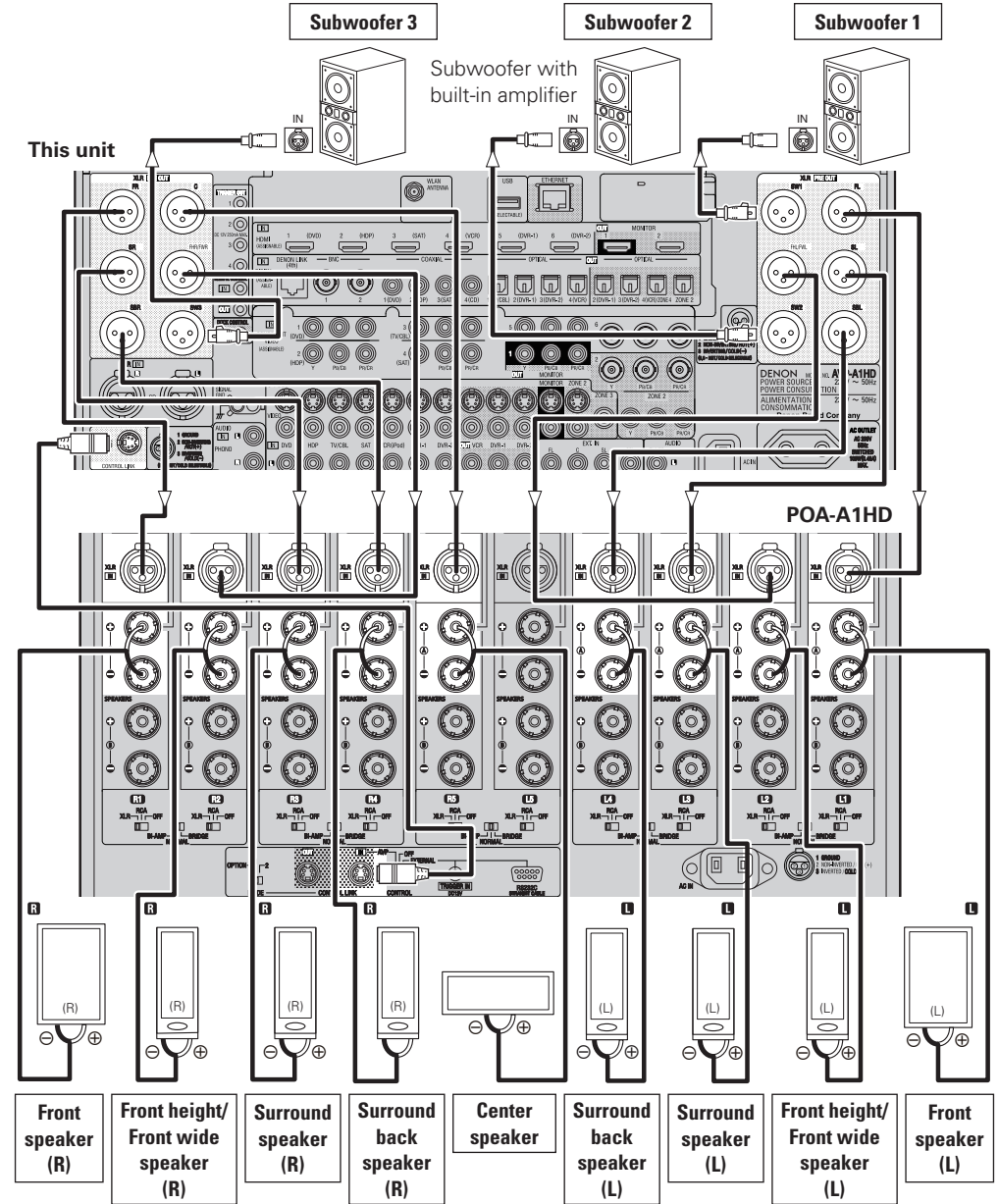

NOTE

The default AVP-A1HD balance model XLR pre-out terminal pin alignment is as shown.
 ① : GROUND ② : HOT ③ : COLD



Connecting Equipment with HDMI connectors

When this unit is upgraded, 3D video can be played back.

This unit supports input and output of 3D (3 dimensional) video signals of HDMI 1.4a. To play back 3D video, you need a TV and player that provide support for the HDMI 1.4a 3D function and a pair of 3D glasses.

NOTE

- When playing back 3D video, refer to the instructions provided in the manual of your playback device together with this manual.
- If you operate the menu while playing back 3D video content, the playback video is replaced by the menu screen. The playback video is not displayed behind the menu screen.
- This unit does not show the status display while playing back 3D video content.
- If 3D video with no 3D information is input, the menu screen and status display on this unit are displayed over the playback video.
- If 2D video is converted to 3D video on the television, the menu screen and status display on this unit are not displayed correctly. To view the menu screen and status display on this unit correctly, turn the television setting that converts 2D video to 3D video off.
- When computer resolution (e.g. VGA) video or 3D video contents are being played back, the status display cannot be displayed.
- When the menu is operated during playback of a computer resolution video (e.g. VGA) or 3D video contents, the playback video switches to the video in the menu screen.
- When a 3D compatible television and 3D incompatible television are connected at the same time, when you want to playback 3D video, switch the "Monitor Out" (page 31) setting to the terminals that the 3D compatible television is connected to before playing the content on the player.

Connections to Other Devices

External Power Amplifier

When this unit is upgraded, the terminal names and connection methods will change.

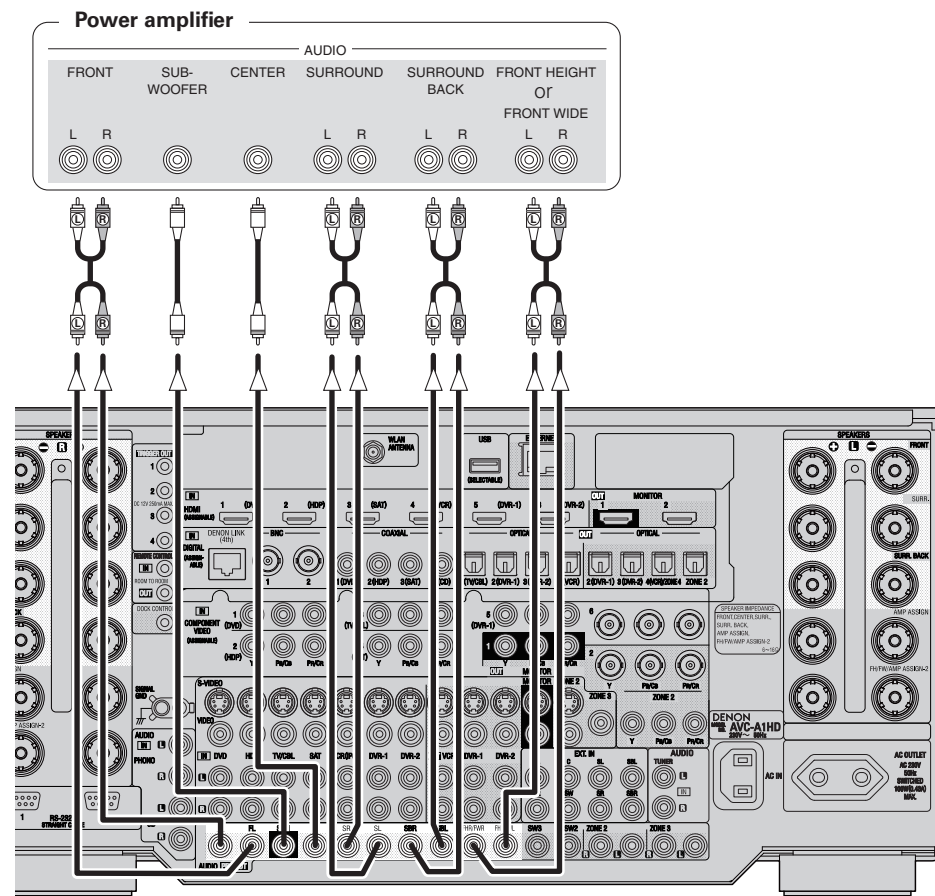

GUI Menu Operations

GUI Menu Map

AVC-A1HD

Information

(page 44)

- Status
 - MAIN ZONE
 - ZONE2/3/4
- Audio Input Signal
- HDMI Information
- Auto Surround Mode
- Quick Select
- Preset Station

Surround Mode

(page 35 ~ 37)

- STEREO
- DIRECT
- STANDARD
- DOLBY HEADPHONE
- (When using headphones)
- DOLBY PLIix, DOLBY PLII or DOLBY PL
- DOLBY PLIiz
- DTS-NEO:6
- DTS-NEO:X
- HOME THX CINEMA
- 7CH STEREO
- WIDE SCREEN
- SUPER STADIUM
- ROCK ARENA
- JAZZ CLUB
- CLASSIC CONCERT
- MONO MOVIE
- VIDEO GAME
- MATRIX

Auto Setup

(page 12 ~ 22)

- Auto Setup
 - STEP1 Preparation
 - STEP2 Detection & Measurement (main)
 - STEP3 Measurement (2nd - 8th)
 - STEP4 Calculation
 - STEP5 Check
 - STEP6 Store
 - Finish
- Option
 - Room-EQ
 - Direct Mode
 - Mic-Select
- Parameter Check

Source Select

- DVD, HDP, TV/CBL, SAT, VCR, DVR-1, DVR-2, V.AUX, CD, TUNER
 - Play (iPod)
 - Playback Mode (iPod)
 - Assign
 - Video

- NET/USB
 - Play
 - Playback Mode
 - Still Picture
 - Video
 - Input Mode
 - Rename
 - Source Level

- PHONO
 - Video
 - Input Mode
 - Rename
 - Source Level

Parameters

- Audio
 - Surround Parameters
 - Mode
 - Decoder
 - Cinema EQ
 - DRC
 - D.COMP
 - LFE
 - Center-Image
 - Center Gain
 - Panorama
 - Dimension
 - Center Width
 - Delay Time
 - Effect
 - Effect Level
 - Room Size
 - AFDM
 - SB CH Out
 - Height Gain
 - Subwoofer Att.
 - Subwoofer
 - Default
 - Tone
 - Tone Defeat
 - Bass
 - Treble
 - Front
 - Center
 - Surround
 - Surround Back
 - Front Height
 - Front Wide
 - Subwoofer
 - Room-EQ
 - Audyssey Settings
 - MultEQ® XT 32
 - Dynamic EQ®
 - Reference Level Offset
 - Dynamic Volume®
 - Setting
 - A-DSX Soundstage
 - Audyssey DSX™
 - Stage Width
 - Stage Height
 - RESTORER
 - Night-Mode
 - Audio Delay
 - Picture Adjust
 - Contrast
 - Brightness
 - Chroma Level
 - Hue
 - DNR
 - Enhancer
 - Sharpness

[Character color]

Blue characters : Changed or added
Red-characters : Deleted

Manual Setup

(page 23 ~ 28, 30 ~ 34, page 31, 33 ~ 37, 41)

- Speaker Setup (page 23 ~ 25)
 - Speaker Configuration
 - Front
 - Center
 - Subwoofer
 - Surround-A
 - Surround-B
 - Surround
 - Surround Back
 - Front Height
 - Front Wide
 - Subwoofer Setup
 - Distance
 - Channel Level
 - Mode
 - Surround
 - Start
 - Default
 - Crossover Frequency
 - THX Audio Setup
 - Surround-Speaker
- HDMI Setup (page 31)
- Audio Setup (page 26, 27)
 - EXT. IN Setup
 - Surround-Speaker
 - Subwoofer Level
 - 2ch Direct/Stereo
 - Downmix-Option
 - Auto Surround Mode
 - Manual EQ
- Network Setup (page 33 ~ 36)
- Zone Setup (page 37)
- Option Setup (page 28, 30 ~ 34)
 - Amp Assign
 - Volume Control
 - Source Delete
 - GUI
 - Screensaver
 - Wall Paper
 - Format
 - Text
 - Master Volume
 - NET/USB
 - iPod
 - Quick Select Name
 - Trigger Out 1
 - Trigger Out 2
 - Trigger Out 3
 - Trigger Out 4
 - Transducer Setup
 - Digital Out
 - Remote ID
 - 2Way-Remote
 - 232C Port (1)
 - Dimmer
 - Setup Lock
 - Maintenance Mode
 - Firmware Update
 - Add New Feature
- Language (page 41)

Information

(🔍 page 44)

- Status
 - MAIN ZONE
 - ZONE2/3/4
- Audio Input Signal
- HDMI Information
- Auto Surround Mode
- Quick Select
- Preset Station

Surround Mode

(🔍 page 35 ~ 37)

- STEREO
- DIRECT
- STANDARD
- DOLBY HEADPHONE
 - (When using headphones)
- DOLBY PLIix, DOLBY PLII or DOLBY PL
- DOLBY PLIIz
- DTS-NEO:6
- DTS NEO:X
- HOMETHX CINEMA
- 7CH STEREO
- WIDE SCREEN
- SUPER STADIUM
- ROCK ARENA
- JAZZ CLUB
- CLASSIC CONCERT
- MONO
- VIDEO GAME
- MATRIX

Auto Setup

(🔍 page 12 ~ 22)

- Auto Setup
 - STEP1 Preparation
 - STEP2 Detection & Measurement (main)
 - STEP3 Measurement (2nd - 8th)
 - STEP4 Calculation
 - STEP5 Check
 - STEP6 Store
 - Finish
- Option
 - Room-EQ
 - Direct Mode
 - Mic-Select
- Parameter Check

Source Select

(🔍 @page 44 ~ 48)

- DVD, HDP, TV/CBL, SAT, VCR, DVR-1, DVR-2, V.AUX, CD, TUNER
 - Play (iPod)
 - Playback Mode (iPod)
 - Assign
 - Video
 - Input Mode
 - Rename
 - Source Level
 - Input Att.
- NET/USB
 - Play
 - Playback Mode
 - Still Picture
 - Video
 - Input Mode
 - Rename
 - Source Level
- PHONO
 - Video
 - Input Mode
 - Rename
 - Source Level
 - Input Att.

Parameters

(🔍 page 38 ~ 43, @page 54)

- Audio
 - Surround Parameters
 - Mode
 - Decoder
 - Cinema EQ
 - DRC
 - D.COMP
 - LFE
 - Center-Image
 - Center Gain
 - Panorama
 - Dimension
 - Center Width
 - Delay Time
 - Effect
 - Effect Level
 - Room Size
 - AFDM
 - SB CH Out
 - Height Gain
 - Input Channel
 - Subwoofer Att.
 - Subwoofer
 - Default
 - Tone
 - Tone Defeat
 - Bass
 - Treble
 - Front
 - Center
 - Surround
 - Surround Back
 - Front Height
 - Front Wide
 - Subwoofer
 - Room-EQ
 - Audyssey Settings
 - MultEQ® XT 32
 - Dynamic EQ®
 - Reference Level Offset
 - Dynamic Volume®
 - Setting
 - A-DSX Soundstage
 - Audyssey DSX™
 - Stage Width
 - Stage Height
 - RESTORER
 - Night-Mode
 - Audio Delay
 - Picture Adjust
 - Contrast
 - Brightness
 - Chroma Level
 - Hue
 - DNR
 - Enhancer
 - Sharpness

[Character color]
Blue characters : Changed or added
Red-characters : Deleted

Manual Setup

(🔍 page 23 ~ 34, @page 31, 34 ~ 38, 43)

- Speaker Setup (🔍 page 23 ~ 25)
 - Speaker Configuration
 - Front
 - Center
 - Subwoofer
 - Surround-A
 - Surround-B
 - Surround
 - Surround Back
 - Front Height
 - Front Wide
 - Subwoofer Setup
 - Distance
 - Channel Level
 - Mode
 - Surround
 - Start
 - Default
 - Crossover Frequency
 - THX Audio Setup
 - Surround-Speaker
- HDMI Setup (🔍 @page 31)
- Audio Setup (🔍 page 26, 27)
 - EXT. IN Setup
 - Mode
 - Surround Back Input
 - Surround-Speaker
 - Subwoofer Level
 - Input Att.
 - 2ch Direct/Stereo
 - Downmix-Option
 - Auto Surround Mode
 - Manual EQ
- Network Setup (🔍 @page 34 ~ 37)
- Zone Setup (🔍 @page 38)
- Option Setup (🔍 page 28 ~ 34)
 - Pre-out Assign
 - XLR Out Polarity
 - POA Setting
 - Volume Control
 - Source Delete
 - GUI
 - Screensaver
 - Wall Paper
 - Format
 - Text
 - Master Volume
 - NET/USB
 - iPod
 - Quick Select Name
 - Trigger Out 1
 - Trigger Out 2
 - Trigger Out 3
 - Trigger Out 4
 - Transducer Setup
 - Digital Out
 - Remote ID
 - 2Way-Remote
 - 232C Port (1)
 - Dimmer
 - Setup Lock
 - Maintenance Mode
 - Firmware Update
 - Add New Feature
- Language (🔍 @page 43)

Auto Setup



When this unit is upgraded, the "Auto Setup" contents are returned to the default settings. When configuring the "Auto Setup" settings, refer to this version of the Owner's Manual instead of the "Original version".

The acoustic characteristics of the connected speakers and listening room are measured and the optimum settings are made automatically. This is called "Auto Setup".

To perform measurement, place the setup microphone in multiple locations all around the listening area. For best results, we recommend you measure in six or more positions, as shown in the illustration (up to eight positions).

- When performing Auto Setup, Audyssey MultEQ® XT 32/Dynamic EQ®/Dynamic Volume® functions become active (page 41, 42).
- To set up the speakers manually, use "Manual Setup" – "Speaker Setup" (page 23 ~ 25) on the menu.

NOTE

- Make the room as quiet as possible. Background noise can disrupt the room measurements. Close windows, silence cell phones, televisions, radios, air conditioners, fluorescent lights, home appliances, light dimmers, or other devices as measurements may be affected by these sounds.
- Cell phones should be placed away from all audio electronics during the measurement process as Radio Frequency Interference (RFI) may cause measurement disruptions (even if the cell phone is not in use).
- Do not unplug the setup microphone from the main unit until Auto Setup is completed.
- Do not stand between the speakers and setup microphone or allow obstacles in the path while the measurements are being made. This will cause inaccurate readings.
- Loud test sounds may be played during Auto Setup. This is part of normal operation. If there is background noise in room, these test signals will increase in volume.
- Operating the **MASTER VOLUME** knob or main remote control **VOL +/-** button during measurement cancels the measurement.
- Measurement cannot be performed when headphones are connected. Before performing Auto Setup, disconnect the headphone plug.

About setup microphone placement

- Measurements are performed by placing the setup microphone successively at multiple positions throughout the entire listening area, as shown in **[Example ①]**. For best results, we recommend you measure in six or more positions, as shown in the illustration (up to eight positions).
- Even if the listening environment is small as shown in **[Example ②]**, measuring at multiple points throughout the listening environment results in more effective correction.

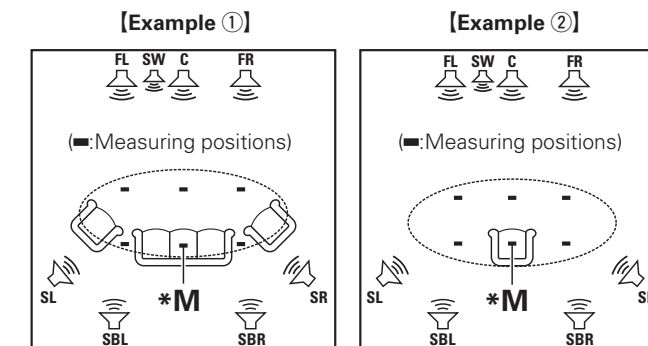

- | | |
|-------------------------------|--|
| FL : Front speaker (L) | SL : Surround speaker (L) |
| FR : Front speaker (R) | SR : Surround speaker (R) |
| C : Center speaker | SBL : Surround back speaker (L) |
| SW : Subwoofer | SBR : Surround back speaker (R) |

□ About the main listening position (*M)

The main listening position is the position where listeners would normally sit or where one would normally sit alone within the listening environment. Before starting Auto Setup, place the setup microphone in the main listening position. MultEQ® XT 32 uses the measurements from this position to calculate speaker distance, level, polarity, and the optimum crossover value for the subwoofer.

Before starting Auto Setup

1 Set up the subwoofer

If using a subwoofer capable of the following adjustments, set up the subwoofer as shown below.

- ❑ **When using a subwoofer with a direct mode**
Set the direct mode to "On" and disable the volume adjustment and crossover frequency setting.
- ❑ **When using a subwoofer without a direct mode**
Make the following settings:
 - **Volume** : "12 o'clock position"
 - **Crossover frequency** : "Maximum/Highest Frequency"
 - **Low pass filter** : "Off"
 - **Standby mode** : "Off"

2 Set up the microphone

Mount the setup microphone on a tripod or stand and place it in the main listening position.

When placing the setup microphone, adjust the height of the sound receptor to the level of the listener's ear.

When starting Auto Setup, always use the supplied setup microphone (DM-A409). Correct measurements cannot be taken if the setup microphone from the prior upgrade (DM-A505Z) is used.

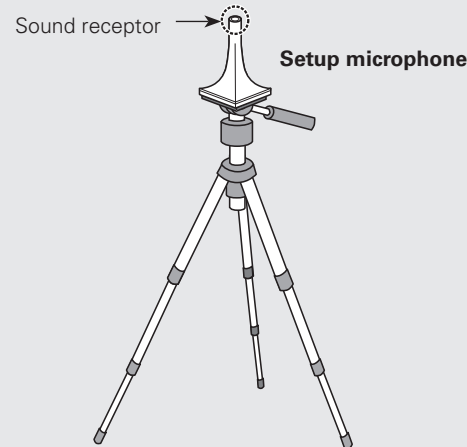

If you do not have a tripod or stand, set up the microphone on, for example, a seat without a back.

NOTE

- Do not hold the setup microphone in your hand during measurements.
- Avoid placing the setup microphone close to a seat back or wall as sound reflections may give inaccurate results.

3 Connect the setup microphone

Connect the setup microphone to the SETUP MIC jack of this unit.

When placing the setup microphone, adjust the height of the sound receptor to the level of the listener's ear.

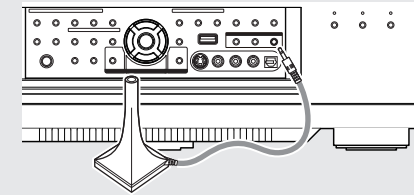

When the setup microphone is connected, the setup screen is displayed.

[Setup screen AVC-A1HD]

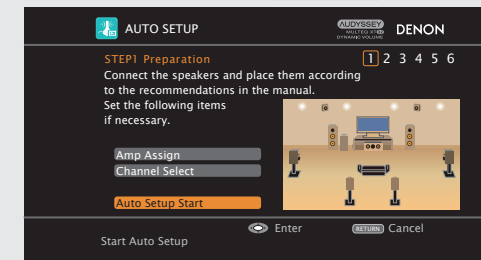

[Setup screen AVP-A1HD]

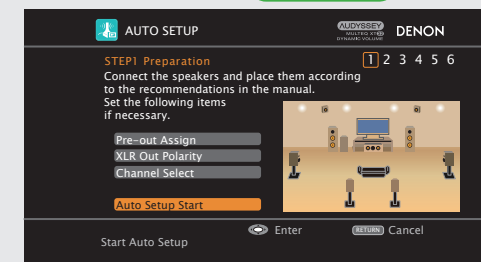

Auto Setup

Optimize settings for speakers in use.

GUI



Menu tree

Auto Setup

1 Auto Setup

2 Option

3 Parameter Check

1 Auto Setup

The settings are performed automatically.



[Auto Setup flow]

STEP1 Preparation page 14, 15



STEP2 Detection & Measurement (main) page 16, 17



STEP3 Measurement (2nd – 8th) page 18



STEP4 Calculation page 18



STEP5 Check page 19



STEP6 Store page 19



Finish page 20

STEP1 Preparation

- Configure the following settings as required.
- To start Auto Setup without configuring the following settings, perform step 4 only, and then proceed to step 2.

Amp Assign **AVC-A1HD**
Select the method for using the power amplifier in accordance with the connected speaker configuration.
Choose this when “Amp Assign” in the GUI menu is set to anything other than “Normal”.

Pre-out Assign **AVP-A1HD**
Change the pre-out terminal assignment.

XLR Out Polarity **AVP-A1HD**
Set to switch the XLR pre-out terminal polarity.

Channel Select **AVC-A1HD** **AVP-A1HD**
The measurement time can be shortened by selecting the speakers to be measured in advance. Please set if necessary.
When measuring 2 or 3 subwoofers, configure the “Channel Select” settings.



- “Front Height” is displayed when the “Amp Assign” – “Assign Mode” setting (page 28) in the GUI menu and the “Extension Channel” setting (page 28, 29) are set to “Front Height”.
- “Front Wide” is displayed when the “Amp Assign” – “Assign Mode” setting (page 28) in the GUI menu and the “Extension Channel” setting (page 28, 29) are set to “Front Wide”.

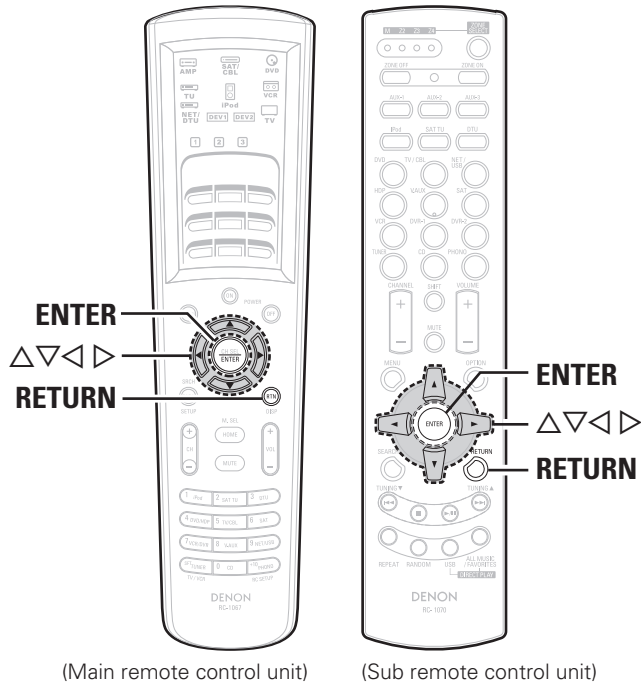
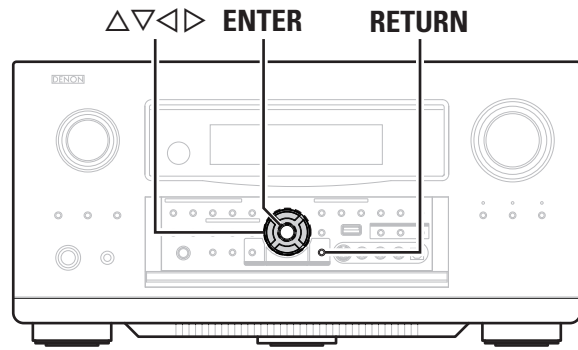

1 Configuring Various Settings

Use $\Delta \nabla \triangleleft \triangleright$ to select the item you want to set, and then press **ENTER**.

The menu screen of the selected setting is displayed.

[Setup screen **AVC-A1HD**]

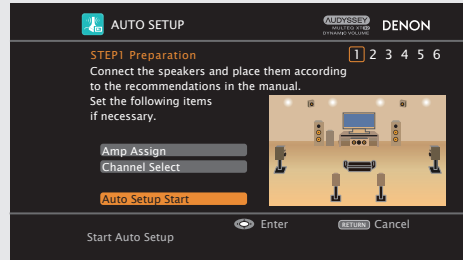

[Setup screen **AVP-A1HD**]



※ For details of the items that can be set, see page 28 ~ 30.

2 Press $\Delta \nabla \triangleleft \triangleright$ to set.

3 Press **RETURN** to return to the previous screen.

4 Start Auto Setup

Use $\Delta \nabla$ to select "Auto Setup Start" and then press **ENTER**.

Proceed to "STEP2 Detection & Measurement (main)" (page 16).

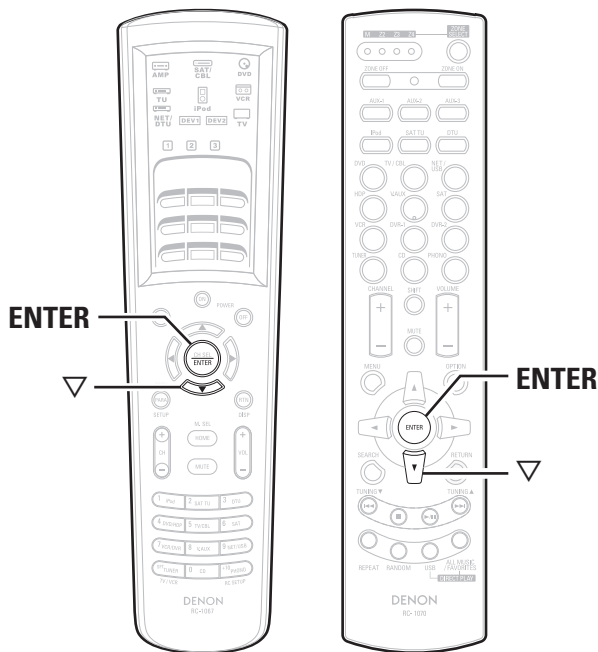
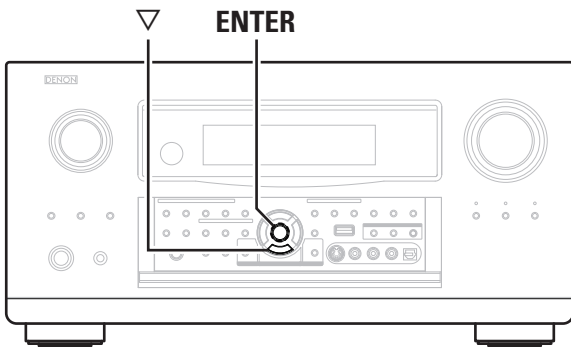

(Main remote control unit)

(Sub remote control unit)

STEP2 Detection & Measurement (main)

- In STEP 2, the subwoofer volume level and main listening position volume are measured.
- This step automatically checks the speaker configuration and speaker size, and calculates the channel level, distance, and crossover frequency. It also corrects distortion in the listening area.
- Install the supplied setup microphone to the main listening position.

1 Measuring the subwoofer volume level

Select “Measure” and then press ENTER.

Measure the subwoofer volume level.

- ※ When “Channel Select” – “Subwoofer” in the GUI menu is set to “Skip”, the subwoofer volume level is not measured.
- ※ When 2 or 3 subwoofers are used, measure the volume level of each.
- ※ After measuring the volume level of the subwoofer, if the following error message is displayed, adjust the subwoofer volume level using “Adjusting the subwoofer volume level” (☞ page 17).

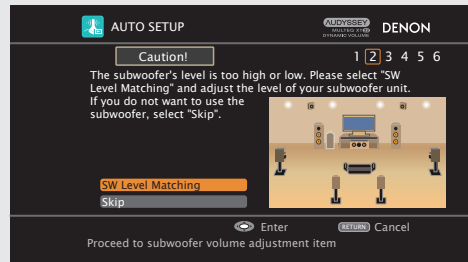

2 Perform measurement of the main listening position

When the subwoofer volume level measurement is completely, the connected speakers are detected automatically.

- ※ The measuring channel changes depending on the setting of “STEP1 Preparation” (☞ page 14).
- ※ It takes a few minutes for speaker measurement to complete.

3 The detected speakers are displayed.

- ※ The illustration below shows an example of when the front speakers, center speaker, subwoofer, surround speakers, surround back speakers and front height speakers have been detected.

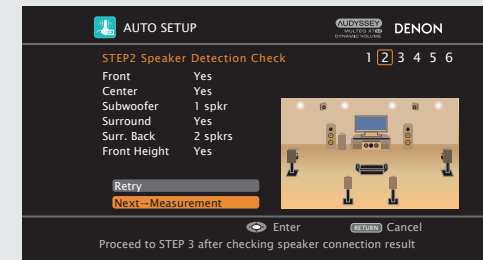

- ※ If a connected speaker is not displayed, the speaker may not be connected correctly. Check the speaker connection.
- ※ To re-measure, press ▽ to select “Retry”, and press ENTER.

4 Use ▽ to select “Next → Measurement” and then press ENTER.

Proceed to “STEP3 Measurement (2nd – 8th)” (☞ page 18).

NOTE

If “Caution!” is displayed on the television screen, see “Error messages” (☞ page 21). Check the related items, and implement the necessary measures. After resolving the error, perform Auto Setup again.

- ☐ **When measuring has stopped**
Press ENTER.

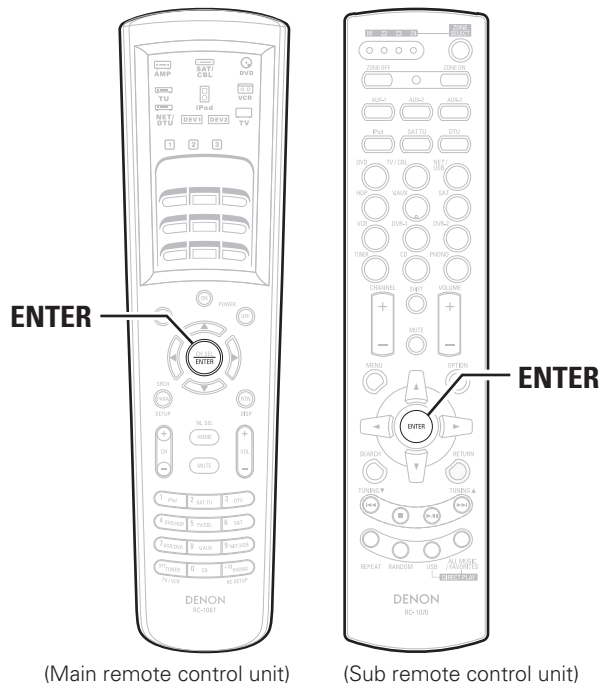
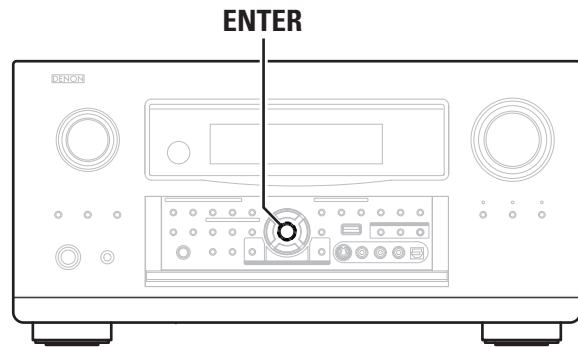

Adjusting the subwoofer volume level

The optimum subwoofer volume level is 75 dB.

During "Measuring the subwoofer volume level" (page 16), an error message is displayed when one level of subwoofers is outside the 72 to 78 dB range.

When using a subwoofer with built-in amplifier (active type), adjust the subwoofer volume so that the subwoofer level is within the 72 to 78 dB range.



When 2 or 3 subwoofers are used, adjust the volume level of each subwoofer so that their volume level will set between 72~78 dB.

1 Select "SW Level Matching" and then press ENTER.



2 Select "SW Test Start" and then press ENTER.

Measure the subwoofer volume level.

During measuring, a "Testing..." message is displayed.

When measurements are completed, the measurement level value is displayed.

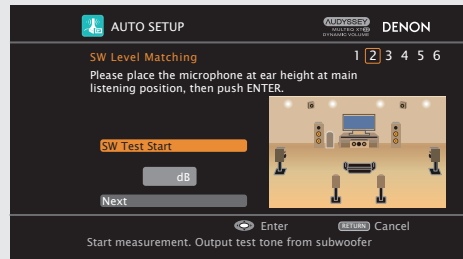

3 Adjust the subwoofer volume level of your subwoofer so that the level display is within the range of 72 to 78 dB.

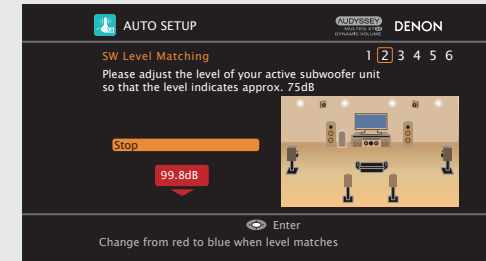

※ If the measured level is outside the 72 to 78 dB range, the level indicator is red.

※ When measuring stops, press **ENTER**.

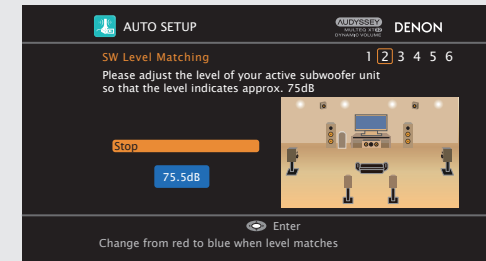

※ If the measured level is within the 72 to 78 dB range, the level indicator is blue.

4 When the measured level is within the 72 to 78 dB range, press ENTER.

5 Select "Next" and then press ENTER.

Proceed to step 2 of "STEP2 Detection & Measurement (main)" (page 16).

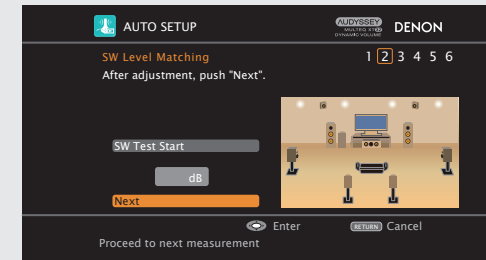

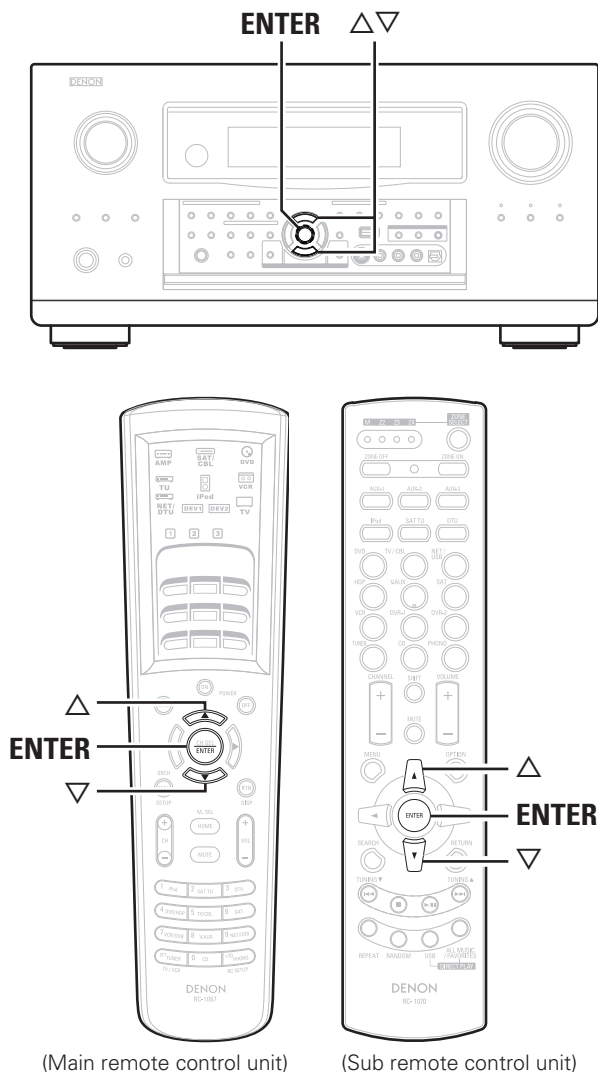

STEP3 Measurement (2nd – 8th)

- In STEP 3, you will perform measurements at multiple positions (two to eight positions) other than the main listening position. Measurements can be made in up to eight positions.
- You can achieve a more effective correction of distortion within the listening area by performing measurements at multiple positions.
- Move the provided set up microphone to the measurement point.

1 Move the setup microphone to position 2, use Δ / ∇ to select “Measure”, and then press ENTER.

The measurement of the second position starts.

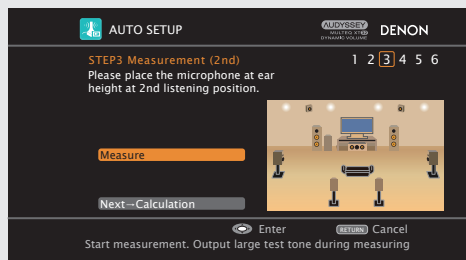

※ To omit measurements from the 2nd position onwards, press ∇ , select “Next → Calculation” and press **ENTER**. Proceed to “STEP4 Calculation”.

2 Repeat step 1, measuring positions 3 to 8.

When measurement of position 8 is completed, a “Measurements finished.” message is displayed.

※ To re-measure, press ∇ to select “Retry”, and press **ENTER**. Re-measure the previous point.

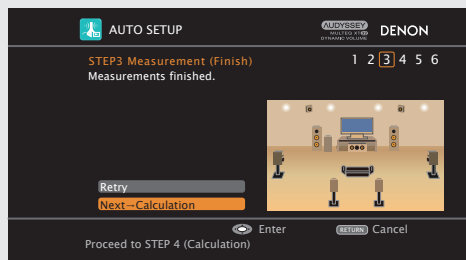

3 Use ∇ to select “Next → Calculation” and then press ENTER.

Proceed to “STEP4 Calculation” (page 18).

NOTE

If “Caution!” is displayed on the television screen, see “Error messages” (page 21). Check the related items, and implement the necessary measures. After resolving the error, perform Auto Setup again.

- When measuring has stopped**
Press **ENTER**.

STEP4 Calculation

In STEP 4, the measured results from STEP 2 and STEP 3 are analyzed.

When the measurements are completed, press ∇ to select “Next → Calculation”, and press ENTER.

The measured results from STEP 2 and STEP 3 are automatically analyzed, and the frequency response of each speaker in the listening room is determined.

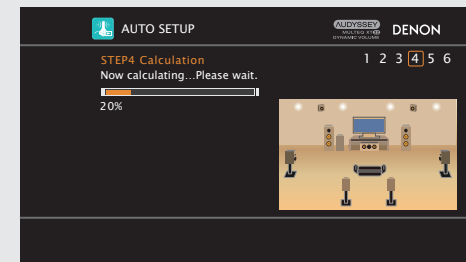

※ It takes a few minutes for analysis to complete. The time required for this analysis depends on the number of speakers connected. The more connected speakers there are, the longer it takes to perform analysis.

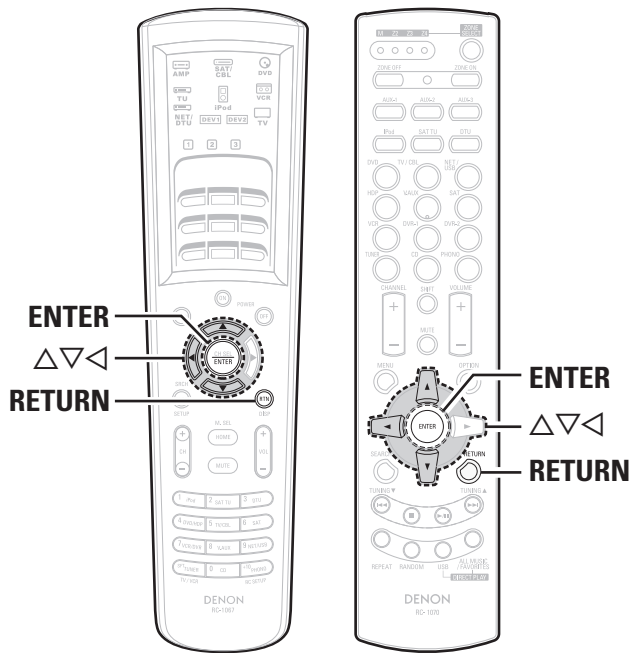
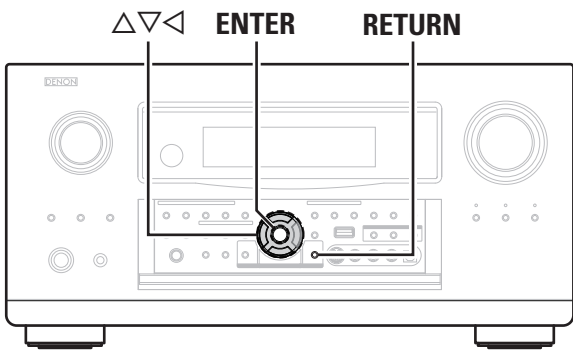

(Main remote control unit)

(Sub remote control unit)

STEP5 Check

In STEP 5, the results of the analysis from STEP 4 are confirmed.

1 Use **△▽** to select the item you want to check, and then press **ENTER**.



- ※ A value that is different to the measured distance may be set.
- ※ To check other items, press **RETURN** and select the item that you want to check.

2 Use **▽** to select “Next → Store” and then press **ENTER**.

Proceed to “STEP6 Store” (page 19).

NOTE

- If the result differs from the actual connection status, or if “Caution!” is displayed, see “Error messages” (page 21). Check the related items, and implement the necessary measures. After resolving the error, perform Auto Setup again.
- If the result still differs from the actual connection status after remeasurement or the error message still appears, it is possible that the speakers are not connected properly. Turn this unit off, check the speaker connections and repeat the measurement process from the beginning.
- If you change speaker positions or orientation, perform Auto Setup again to find the optimal equalizer settings.

STEP6 Store

In STEP 6, the measured results from STEP 2 and STEP 3 are saved.

Select “Store” and then press **ENTER**.
Save the measurement results.

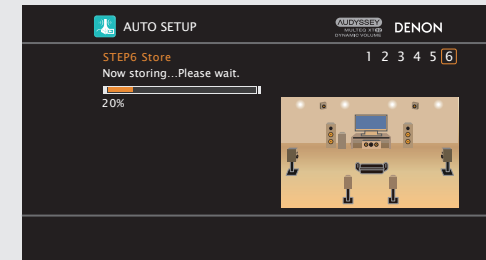
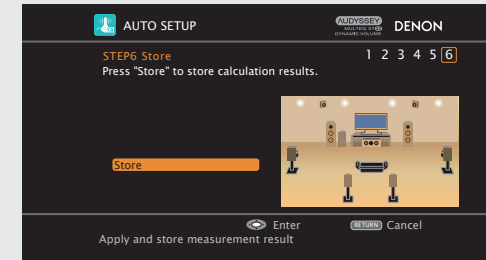

- ※ It takes approximately 20 seconds to finish saving the results.
- ※ If the measuring results are not to be saved, press **RETURN**. A message “Cancel auto setup?” will be displayed. Press **△** then select “Yes”. All the measured Auto Setup data will be erased.

NOTE

During saving of measurement results, be sure not to turn off the power.

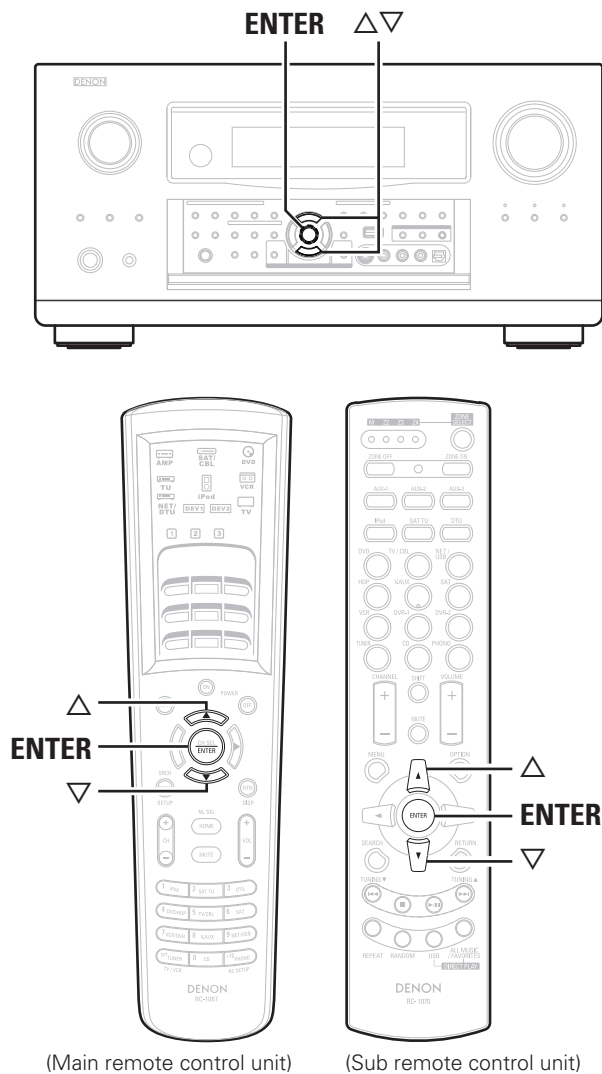

Finish

Auto Setup is complete.

1 Unplug the setup microphone from the unit's **SETUP MIC** jack.

2 Set **Audyssey Dynamic Volume®**.

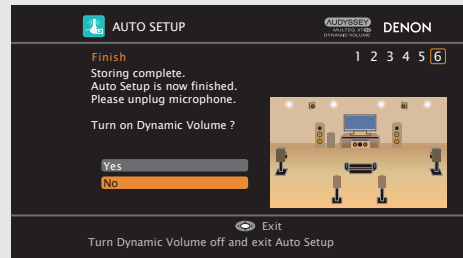

※ This feature adjusts the output volume to the optimal level while constantly monitoring the level of the audio input to the unit. Optimal volume control is performed automatically without any loss in the dynamism and clarity of the sound when, for example, the volume suddenly increases for commercials shown during television programs.

When turning Dynamic Volume® on
Use ▲ to select "Yes," and then press **ENTER**.
The unit automatically enters "Evening" mode.

When turning Dynamic Volume® off
Use ▼ to select "No," and then press **ENTER**.





NOTE

- After performing Auto Setup, do not change the speaker connections or subwoofer volume. In event of a change, perform Auto Setup again.
- After performing Auto Setup with two or three subwoofers, do not change the channel distances and levels of any of the subwoofers.

Error messages

NOTE

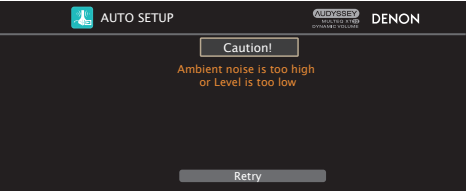
- An error message is displayed if Auto Setup could not be completed due to speaker placement, the measurement environment, etc. Check the related items, and implement the necessary measures. After resolving the error, perform Auto Setup again.
- If the result still differs from the actual connection status after remeasurement or the error message still appears, it is possible that the speakers are not connected properly. Turn this unit off, check the speaker connections and repeat the measurement process from the beginning.
- Be sure to turn off the power before checking speaker connections.

Examples	Error details	Measures
	<ul style="list-style-type: none"> • Correct measurement is not possible due to inappropriate subwoofer volume. 	<ul style="list-style-type: none"> • When using a subwoofer with built-in amplifier (active type), use "SW Level Matching" to adjust the subwoofer volume (page 17 "Adjusting the subwoofer volume level"). • When using a subwoofer without a built-in amplifier, select "Skip", and then press ENTER.
	<ul style="list-style-type: none"> • The connected setup microphone is broken, or a device other than the supplied setup microphone is connected. • Not all speakers could be detected. • The front L speaker was not properly detected. 	<ul style="list-style-type: none"> • Connect the included setup microphone to the SETUP MIC jack of this unit. • Check the speaker connections.
	<ul style="list-style-type: none"> • There is too much noise in the room for accurate measurements to be made. • Speaker or subwoofer sound is too low for accurate measurements to be made. 	<ul style="list-style-type: none"> • Either turn off any device generating noise or move it away. • Perform again when the surroundings are quieter. • Check the speaker installation and the direction in which the speakers are facing. • Adjust the subwoofer's volume.
	<ul style="list-style-type: none"> • The displayed speaker could not be detected. (The screen on the left indicates that the front right speaker cannot be detected.) 	<ul style="list-style-type: none"> • Check the connections of the displayed speaker.
	<ul style="list-style-type: none"> • The displayed speaker is connected with the polarity reversed. (The screen on the left indicates that the polarity phases of the front right speakers are reversed.) 	<ul style="list-style-type: none"> • Check the polarity of the displayed speaker. • For some speakers, this error message may be displayed even if the speaker is properly connected. If you are sure the connection is correct, press $\Delta \nabla$ to select "Skip", then press ENTER.

2 Option

Make direct mode settings.



Direct Mode

Select MultEQ® XT 32 use for DIRECT or PURE DIRECT mode.

[Selectable items] **ON** **OFF**

3 Parameter Check

Check Auto Setup measurement results.
This is displayed after the Auto Setup procedure is completed.



[Selectable items]

Spkr Config Check **Distance Check** **Ch. Level Check**
Crossover Check **EQ Check** **Restore**



- If "EQ Check" is selected, press Δ / ∇ to select equalizing curve ("Audyssey" or "Audyssey Flat") to be checked, and then press **ENTER** or \triangleright .
Use Δ / ∇ to switch the display between the different speakers.
- If "Restore" is selected, all settings are returned to the Auto Setup results (values initially calculated by MultEQ® XT 32) even if each setting was changed manually.

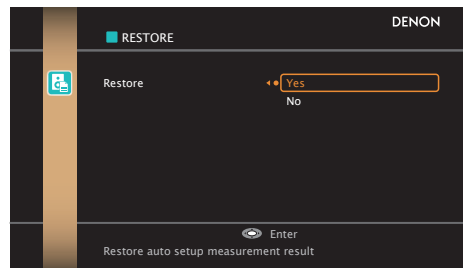
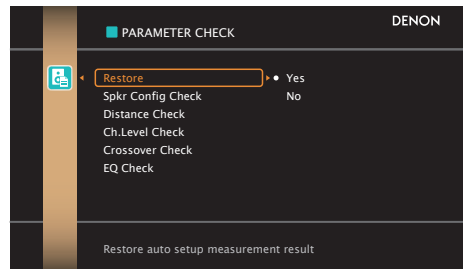

Manual Setup



Make detailed settings for various parameters.

When this unit is upgraded, the "Speaker Setup" contents are changed. When configuring the "Speaker Setup" settings, refer to this version of the Owner's Manual instead of the "Original version".

Speaker Setup

Use this procedure to set the speakers manually or if you wish to change the settings made with the Auto Setup procedure.



Menu tree

Manual Setup

Speaker Setup

1 Speaker Configuration

2 Subwoofer Setup

3 Distance

4 Channel Level

5 Crossover Frequency

6 THX Audio Setup

1 Speaker Configuration

Select speaker configuration and size. (bass reproduction capability)

Front

Select front speaker size.

[Selectable items] **Large** **Small**

Center

Select center speaker use and size.

[Selectable items] **Large** **Small** **None**

Subwoofer

Select subwoofer use.

[Selectable items] **Yes** **No**

Surround

Select surround speakers use and size.

[Selectable items] **Large** **Small** **None**

Surround Back

Select surround back speaker use and size.

[Selectable items] **Large** **Small** **None**
2spkrs **1spkr**

Front Height

Select front height speaker use and size.

[Selectable items] **Large** **Small** **None**

Front Wide

Select front wide speaker use and size.

[Selectable items] **Large** **Small** **None**

Large : Use a large speaker that can adequately play back low frequencies.

Small : Use a small speaker that has inadequate playback capacity for low frequencies.



- Select "Large" or "Small" not according to the physical size of the speaker but according to the low frequency reproduction capabilities based on the frequency set at "Crossover Frequency" (page 25).
- When "Front" is set to "Small", "Subwoofer" is automatically set to "Yes".
- If "Subwoofer" is set to "No", "Front" is automatically set to "Large".
- If "Surround" is set to "None", "Surround Back", "Front Height" and "Front Wide" are automatically set to "None".
- When using just one surround back speaker, connect it to the left channel (SBL).
- To take full advantage of the performance of the Home THX certified speaker systems, set the front, center and surround speaker size parameters to "Small" and the subwoofer to "Yes".
- "Front Height" can be set when the "Option Setup" - "Amp Assign" - "Assign Mode" setting (page 28) in the GUI menu is "Front Height", or the "Option Setup" - "Amp Assign" - "Extension Channel" setting (page 28, 29) is set to "Front Height".
- "Front Wide" can be set when the "Option Setup" - "Amp Assign" - "Assign Mode" setting (page 28) in the GUI menu is "Front Wide", or the "Option Setup" - "Amp Assign" - "Extension Channel" setting (page 28, 29) is set to "Front Wide".

2 Subwoofer Setup

Select subwoofer output configuration and bass signal for playback.

Configuration

Select number of subwoofers and configuration.

[Selectable items]

1SP **2SP L/R** **2SP MIX** **3SP L/R/LFE** **3SP MIX**

Subwoofer Configuration		Subwoofer Connector
1SP		SW1
2SP L/R	L	SW1
	R	SW2
2SP MIX	1	SW1
	2	SW2
3SP L/R/LFE	L	SW1
	R	SW2
	LFE	SW3
3SP MIX	1	SW1
	2	SW2
	3	SW3



When "2SP MIX" or "3SP MIX" is selected, "Subwoofer 1," "Subwoofer 2" and "Subwoofer 3" are each displayed.

Mode

Select bass signal for playing with the subwoofer.

[Selectable items] **LFE-THX-** **LFE+Main**



- THX recommends LFE-THX- mode so that bass interference is less likely to occur in the room.
- This can be set when the GUI menu "Speaker Configuration" – "Subwoofer" is set to "Yes".
- Play music or a movie source and select the mode offering the strongest bass.
- Select "LFE+Main" if you want the bass signals to always be produced from the subwoofer.

3 Distance

Set distance from listening position to speakers.
Before making the settings, measure the distance from the listening position to the different speakers.

Meters / Feet

Select unit for distance.

Step

Select step (smallest distance).

[Selectable items]

0.1m **0.01m** : Can be selected when "Meters" is set.

1ft **0.1ft** : Can be selected when "Feet" is set.

Default

Resets the settings to the default values.

Distance measurement

Select the speaker you want to set, then set the distance.
Set the value closest to the measured distance.

[Variable range]

0.00m ~ 18.00m : Display when "Meters" is set.

0.0ft ~ 60.0ft : Display when "Feet" is set.



Two surround back speakers are required to use the THX Ultra2 Cinema, THX Music mode and THX Games mode.
Set the surround back speakers so that the distance to the listening position is the same for both the left and right speakers.
It is also recommended that the deviations of the distance from the listening position to L and R channel speakers (front left (FL) and front right (FR), surround left (SL) and surround right (SR), surround back left (SBL) and surround back right (SBR)) is less than 60 cm (2 ft).

NOTE

Set the space between each speaker to less than 6.00 m (20.0 ft).

4 Channel Level

Adjust channel levels to obtain equal volume from all speakers.

Mode

Select test tone playback method.

[Selectable items] **Auto** **Manual**

Start

Output test tone.

[Variable range] **-12dB** ~ **0dB** ~ **+12dB**
OFF*

*: The subwoofer volume can be turned "OFF" by pressing ◀ when the subwoofer volume is "-12dB".

Default

Resets the settings to the default values.



Operating from the main remote control unit

Adjusting with the main remote control unit using the test tones is only possible in the "Auto" mode and only effective in the STANDARD (Dolby/DTS Surround) and HOME THX CINEMA modes. The adjusted levels for the different modes are automatically stored in the memory.

[Adjusting using test tones]

- 1 Press the **TEST** button.
Test tones are output from the various speakers.
- 2 Use the ◀ ▶ button to adjust so that the volume is equal for all speakers.
- 3 When the adjustments are completed, press the **TEST** button again.



- The level of each channel should be adjusted to 75 dB (Cweighted, slow meter mode) on a sound level meter at the listening position. If a sound level meter is not available adjust the channels by ear so the sound levels are the same. Because adjusting the subwoofer level test tone by ear is difficult, use a well known music selection and adjust for natural balance.
- Speakers set to "None" in the "Speaker Configuration" settings are not displayed.
- When "Channel Level" is adjusted, the adjusted values are set for all the surround modes. To adjust the channel level separately for the different surround modes, use the operation see  page 65 **AVC-A1HD**,  page 67 **AVP-A1HD**.

5 Crossover Frequency

Select crossover frequency from which subwoofer handles low range signal.

[Selectable items]

FIXED-THX- :

Setup when using a THX-certified speaker.

40Hz **60Hz** **80Hz** **90Hz** **100Hz** **110Hz** **120Hz** **150Hz**
200Hz **250Hz** :



Only the portion of the bass sound of the various speakers output from the subwoofer that has a frequency below the frequency set here is output.

Set this according to the low frequency reproduction capabilities of the speakers you are using.

Advanced :

Specify crossover frequency for each speaker.



- Please set all THX Certified speakers, set the "Speaker Configuration" for all speakers to "Small". We recommend using with the crossover frequency set to "FIXED-THX-", but depending on the speaker, setting it to a different frequency may improve frequency response near the crossover frequency.
- The "Crossover Frequency" can be set when there are speakers that have been set to "Small" at GUI menu "Speaker Configuration" or when "Subwoofer" is set to "Yes" ( page 23).
- At the "Advanced" settings, if the "Subwoofer Setup" ( page 24) setting is set to "LFE-THX-", GUI menu speakers for which "Speaker Configuration" is set to "Small" can be set. If set to "LFE+Main", the setting can be made regardless of the speaker size.
- For speakers set to "Small", sound below the crossover frequency is cut from the sound output. The cut bass sound is output from the subwoofer or front speakers.

6 THX Audio Setup

Set the speaker to play the optimal THX surround mode.

THX Ultra2 Subwoofer

Set when using a subwoofer compatible with THX Ultra2 standards or a subwoofer that can be properly played at low range.

[Selectable items] **Yes** **No**



Make these settings when "Yes" is selected for the subwoofer in the "Speaker Configuration" settings. This option is not available when "No" is selected ( page 23).

BGC (Boundary Gain Compensation)

If bass sound feels big compensate by lowering volume.

[Selectable items] **ON** **OFF**



- If the bass sound seems too strong:
Set "BGC" to "ON". This activates a filter that gently reduces very deep bass below 55 Hz to provide the flattest overall deep bass response. Select "ON" or "OFF" according to how strong you prefer the deep bass response to be.
- This can be set when the "THX Ultra2 Subwoofer" setting is set to "Yes".

SB Speaker Position

Set the distance between the left and right surround back speakers.

[Selectable items] **Under 0.3m** **0.3m – 1.2m** **Over 1.2m**



- When two surround back speakers have been set in "Speaker Configuration" ( page 23), set the distance of the speakers. This option is not available when "1spkr" is selected.
- This setting is necessary to achieve the optimum effect in the THX Surround EX, THX Ultra2 Cinema, THX Music mode and THX Games mode.

When this unit is upgraded, the "Audio Setup" contents are changed.
When configuring the "Audio Setup" settings, refer to this version of the Owner's Manual instead of the "Original version".

Audio Setup

Make settings for audio playback.

● Menu tree ●

Manual Setup

- Audio Setup
- 1 EXT. IN Setup
- 2 2ch Direct/Stereo
- 3 Auto Surround Mode
- 4 Manual EQ

1 EXT. IN Setup
AVC-A1HD

Setup playback method for analog signals inputted from external input connectors (EXT. IN).

Subwoofer Level

Set the subwoofer level for playback.
Select according to the player in use.

[Selectable items] 0dB +5dB +10dB +15dB



We recommend setting to "+15dB".

1 EXT. IN Setup
AVP-A1HD

Setup playback method for analog signals inputted from external input connectors (EXT. IN).

Mode

Select playback mode.

[Selectable items] DSP Analog

Surround Back Input

Select surround back channel input in combination with the connected player.

[Selectable items] Not Used SBL/SBR SB(SBL)



This can be set when "Mode" is set to "DSP".

Subwoofer Level

Set the subwoofer level for playback.
Select according to the player in use.

[Selectable items] 0dB +5dB +10dB +15dB



We recommend setting to "+15dB".

Input Att.

Setup when input level is too large and playback volume is distorted.

[Selectable items] OFF -6dB



This can be set when "Mode" is set to "DSP".

2 2ch Direct/Stereo

Make speaker settings for 2-channel mode playback.

Setting

To change the settings, select "Custom".

[Selectable items] Basic* Custom

*: Use the same settings as in "Speaker Setup".

Front

Select front speaker size.

[Selectable items] Large Small

Subwoofer

Select subwoofer use.

[Selectable items] Yes No

Subwoofer Mode

Select low range signal to be reproduced by subwoofer.

[Selectable items] LFE-THX- LFE+Main

Crossover

Select crossover frequency from which subwoofer handles low range signal.

[Selectable items]

THX 40Hz 60Hz 80Hz 90Hz 100Hz 110Hz 120Hz
150Hz 200Hz 250Hz

Distance FL

Set distance from listening position to front left speaker.

[Variable range] 0.00m ~ 18.00m

Distance FR

Set distance from listening position to front right speaker.

[Variable range] 0.00m ~ 18.00m

3 Auto Surround Mode

Make setting for memorizing surround mode setting for each input signal type.

[Selectable items] ON OFF



- The auto surround mode function lets you store in the memory the surround mode last used for playing the four types of input signals listed below.
 - Analog and PCM 2-channel signals
 - Dolby Digital and DTS 2-channel signals
 - Dolby Digital and DTS multi-channel signals
 - Multi-channel signals other than Dolby Digital and DTS (PCM, DSD, etc.)
- When playing in the PURE DIRECT mode, the surround mode does not change even if the input signal is changed.

4 Manual EQ

Adjust tonal quality for each speaker using graphic equalizer.

Adjust CH

Select speaker adjustment method.

[Selectable items] Each L/R All

Select the speaker and frequency band and adjust the level.

[Selectable items]

63Hz 125Hz 250Hz 500Hz 1kHz 2kHz 4kHz 8kHz
16kHz

[Variable range]

-20dB ~ 0dB ~ +6dB

Curve Copy

Copy MultEQ® XT 32's "Audyssey Flat" correction curve.

[Selectable items] Yes No





"Curve Copy" is displayed after the Auto Setup procedure has been performed.

Default

Resets the settings to the default values.

When this unit is upgraded, the "Option Setup" contents are changed.
 When configuring the "Option Setup" settings, refer to this version of the Owner's Manual instead of the "Original version".

Option Setup **AVC-A1HD** 

Make various other settings. 

● Menu tree ●

Manual Setup

- Option Setup
 - 1 Amp Assign
 - 2 Volume Control
 - 3 Source Delete
 - 4 GUI
 - 5 Quick Select Name
 - 6 Trigger Out 1
 - 7 Trigger Out 2
 - 8 Trigger Out 3
 - 9 Trigger Out 4
 - 10 Transducer Setup
 - 11 Digital Out
 - 12 Remote ID
 - 13 232C Port (1)
 - 14 Dimmer
 - 15 Setup Lock
 - 16 Maintenance Mode
 - 17 Firmware Update
 - 18 Add New Feature

Option Setup **AVP-A1HD** 

Make various other settings. 

● Menu tree ●

Manual Setup

- Option Setup
 - 1 Pre-out Assign
 - 2 XLR Out Polarity
 - 3 POA Setting
 - 4 Volume Control
 - 5 Source Delete
 - 6 GUI
 - 7 Quick Select Name
 - 8 Trigger Out 1
 - 9 Trigger Out 2
 - 10 Trigger Out 3
 - 11 Trigger Out 4
 - 12 Transducer Setup
 - 13 Digital Out
 - 14 Remote ID
 - 15 232C Port (1)
 - 16 Dimmer
 - 17 Setup Lock
 - 18 Maintenance Mode
 - 19 Firmware Update
 - 20 Add New Feature

1 Amp Assign **AVC-A1HD**

Change the assignment for the power amps.

Assign Mode

The places where the surround amplifier and surround back amplifier are used can be set freely according to the usage environment. This makes it possible to output sound to rooms other than the room (the MAIN ZONE) where surround playback is performed (multi-zone playback) or play the sound with high quality using the front speakers (bi-wiring/bi-amp connections).

[Selectable items]

Normal
 ZONE2
 ZONE3
 ZONE(MONO)
 Bi-Wiring
 Bi & ZONE2
 Bi & ZONE3
 Bi & ZONE(MONO)
 Bi-Amp
 ZONE2/ZONE3
 ZONE2/3(MONO)
 2CH Bi-Wiring
 2CH Bi-Amp
 Front Height
 Front Wide
 Free Assign



For details, see "Multi-Zone Settings with the Amp Assign Function" (page 46 ~ 61).

Extension Channel

Set the channel to add to the speaker system.

[Selectable items]

Front Height : Add front height channel to the speaker system.
 Front Wide : Add front wide channel to the speaker system.

1 Pre-out Assign

AVP-A1HD

Change the pre-out assignment.

Assign Mode

Setting "Free Assign" allows you to freely assign each pre-out to any channel, depending on the environment used.

[Selectable items] **Normal** **Free Assign**

Preout terminal	FL	FR	C	SL	SR	SBL	SBR	FHL/ FWL	FHR/ FWR	SW1	SW2	SW3
Pre-out Assign												
Normal	FL	FR	C	SL	SR	SBL	SBR	FHL	FHR	SW1	SW2	SW3
Free Assign	FL	FL	FL	FL	FL	FL	FL	FL	FL	FL	FL	FL
	FR	FR	FR	FR	FR	FR	FR	FR	FR	FR	FR	FR
	C	C	C	C	C	C	C	C	C	C	C	C
	SL	SL	SL	SL	SL	SL	SL	SL	SL	SL	SL	SL
	SR	SR	SR	SR	SR	SR	SR	SR	SR	SR	SR	SR
	SBL	SBL	SBL	SBL	SBL	SBL	SBL	SBL	SBL	SBL	SBL	SBL
	SBR	SBR	SBR	SBR	SBR	SBR	SBR	SBR	SBR	SBR	SBR	SBR
	FHL	FHL	FHL	FHL	FHL	FHL	FHL	FHL	FHL	FHL	FHL	FHL
	FHR	FHR	FHR	FHR	FHR	FHR	FHR	FHR	FHR	FHR	FHR	FHR
	FWL	FWL	FWL	FWL	FWL	FWL	FWL	FWL	FWL	FWL	FWL	FWL
	FWR	FWR	FWR	FWR	FWR	FWR	FWR	FWR	FWR	FWR	FWR	FWR
	SW1	SW1	SW1	SW1	SW1	SW1	SW1	SW1	SW1	SW1	SW1	SW1
SW2	SW2	SW2	SW2	SW2	SW2	SW2	SW2	SW2	SW2	SW2	SW2	
SW3	SW3	SW3	SW3	SW3	SW3	SW3	SW3	SW3	SW3	SW3	SW3	



- Channels that are set up in the GUI menu "Speaker Setup" – "Speaker Configuration" to "None" can be set up, but will not generate output.
- Pre-out terminals in ZONE2 and ZONE3 can not be allocated.

Extension Channel

Set the channel to add to the speaker system.

[Selectable items]

Front Height : Add front height channel to the speaker system.

Front Wide : Add front wide channel to the speaker system.

2 XLR Out Polarity

AVP-A1HD

Set to switch the XLR pre-out terminal polarity.

[Selectable channels]

Front L Front R Center Surround L Surround R

Surround Back L Surround Back R Front Height L

Front Height R Front Wide L Front Wide R Subwoofer 1

Subwoofer 2 Subwoofer 3

[Selectable items] XLR



XLR (INV)



3 POA Setting

AVP-A1HD

Set when connecting the receiver to a POA-A1HD.

POA LINK

Set when connecting the receiver to a POA-A1HD through a CONTROL LINK.

[Selectable items] OFF ON (Single) ON (Dual)

POA 1/POA 2

Set POA-A1HD for which the MODE select switch is set to "1" or "2".



See the POA-A1HD operating instructions.

Input Selector

Select the setup channel.

[Selectable items] L1 R1 L2 R2 L3 R3
L4 R4 L5 R5

Select the connector input to be used for each channel.

[Selectable items] RCA XLR OFF

Power Amp

Select the setup channel.

[Selectable items] L1/L2 L3/L4 L5/R5 R1/R2 R3/R4

Set the power amp usage for each channel.

[Selectable items] NORMAL BI-AMP BRIDGE (BTL)

LINK Check

Check CONTROL LINK.

2 Volume Control

AVC-A1HD

4 Volume Control

AVP-A1HD

Set the MAIN ZONE volume setting.

Volume Limit

Make a setting for maximum volume.

[Selectable items] OFF -20dB -10dB 0dB

Power On Level

This sets the volume set when the MAIN ZONE's power is turned on.

[Selectable items] Last ---dB -80dB ~ 18dB

Mute Level

This sets the amount of attenuation of the volume when the mute mode is set in the MAIN ZONE.

[Selectable items] Full -40dB -20dB

3 Source Delete

AVC-A1HD

5 Source Delete

AVP-A1HD

Remove input sources that are not used from the display.

[Selectable items] ON Delete

NOTE

- Input sources being used in the various zones cannot be deleted.
- Input sources set to "Delete" cannot be selected from GUI menu "Source Select" or using the **SOURCE SELECT** knob on the main unit or **SOURCE SELECT** button on the remote control unit.

4 GUI **AVC-A1HD**

6 GUI **AVP-A1HD**

Make GUI related settings.

Screensaver

Make screensaver settings.

Use the screensaver to prevent burn-in on the monitor screen.

[Selectable items] **ON** **OFF**



When "Screensaver" is set to "ON", the screensaver is activated if no operation is performed for about 3 minutes.

When $\Delta \nabla < \triangleright$, **ENTER** or **MENU** button is pressed, the screen saver is cleared and the corresponding operation is performed.

Wall Paper

Change the GUI background.

[Selectable items] **Picture** **Black** **Gray** **Blue**

Format

Select the video output signal format to match the monitor.

[Selectable items] **PAL** **NTSC**

NOTE

When a format other than the video format of the connected monitor is set, the picture will not be displayed properly. Use the procedure described below to change the video format.



Operating from the main unit

※ The GUI menu is not displayed when performing this setting.

- ① Press and hold the **AUDIO DELAY** and **RETURN** buttons for at least 3 seconds.
"Video Format" appears on the display.
- ② Use the $< \triangleright$ button to make the setting.
- ③ Press the **ENTER**, **MENU** or **RETURN** button to complete the setting.

```
*Video Format  
< PAL >
```

Text

Text information display.

[Selectable items] **ON** **OFF**

Master Volume

Master volume display during adjustment.

[Selectable items] **Bottom** **Top** **OFF**



When the master volume display is hard to see when superimposed on movie subtitles, set to "Top".

NET/USB, iPod

This sets the time the on-screen display is displayed when an operation is performed.

[Selectable items] **Always** **30s** **10s** **OFF**

5 Quick Select Name **AVC-A1HD**

7 Quick Select Name **AVP-A1HD**

Change "Quick Select" display name.
Up to 16 characters can be input.

[Input characters]

A ~ Z **a ~ z** **0 ~ 9** **! # % & ' () * + , - . / : ; < = " > ? @ [\]** (space)

6 Trigger Out 1 AVC-A1HD

8 Trigger Out 1 AVP-A1HD

Select the conditions to turn on the trigger out 1 with respect to the zone, input source, surround mode, HDMI monitor, etc. For details about the trigger out function, see [@page 22](#).

7 Trigger Out 2 AVC-A1HD

9 Trigger Out 2 AVP-A1HD

This sets the conditions to turn on the trigger out 2, in the same way as "Trigger Out 1" above.

8 Trigger Out 3 AVC-A1HD

10 Trigger Out 3 AVP-A1HD

This sets the conditions to turn on the trigger out 3, in the same way as "Trigger Out 1" above.

9 Trigger Out 4 AVC-A1HD

11 Trigger Out 4 AVP-A1HD

This sets the conditions to turn on the trigger out 4, in the same way as "Trigger Out 1" above.

[Selectable items] ON ---

Setting with Respect to the Zone

When the power of the zone turned on/off, the trigger out turns on.

Setting with Respect to the Input Source

When the input source set to on is selected, the trigger out turns on.



Associated with respect to the input source for zones set to "ON" at "Setting with Respect to the Zone".

Setting with Respect to the Surround Mode

When the surround mode set to on is selected, the trigger out turns on.



This is effective when the "MAIN ZONE" has been set to "ON" for the "Setting with Respect to the Zone" and the input source which is set to "ON" has been selected for the "Setting with Respect to the Input Source".

Setting with Respect to the Monitor

When the HDMI monitor set to on is selected, the trigger out turns on.



This is effective when the "MAIN ZONE" has been set to "ON" for the "Setting with Respect to the Zone" and the input source which is set to "ON" has been selected for the "Setting with Respect to the Input Source".

10 Transducer Setup AVC-A1HD

12 Transducer Setup AVP-A1HD

Settings when using transducer.



The Transducer Setup can be accessed through GUI menu "Speaker Setup" – "Subwoofer Setup" is "1SP", "2SP L/R" or "2SP MIX". The transducer signal is outputted from "SW3".

Level

[Variable range]

-12dB ~ 0dB ~ +12dB : Set the transducer level.

OFF : Turn the transducer output off.



When you adjust "Level", the adjusted value is set for all surround modes. To adjust the level for individual surround modes, use "Channel Level" ([@page 65](#) AVC-A1HD), ([@page 67](#) AVP-A1HD).

LPF

Set the upper limit of the low frequency output to the transducer.

[Selectable items]

40Hz 60Hz 80Hz 90Hz 100Hz 110Hz 120Hz
150Hz 200Hz 250Hz

11 Digital Out **AVC-A1HD**

13 Digital Out **AVP-A1HD**

Set usage of OPT4 OUT.

[Selectable items] **ZONE4 Select** **Rec Select**

NOTE

The ZONE4 operations cannot be performed when set to "Rec Select".

12 Remote ID **AVC-A1HD**

14 Remote ID **AVP-A1HD**

Set remote control ID.

Match the ID setting of the remote control unit and the receiver.

[Selectable items] **1** **2** **3** **4**



- When changing the remote ID, also change the AMP, iPod and NET/DTU modes of the main remote control unit at the same time (page 70 **AVC-A1HD**, page 72 **AVP-A1HD**).
- When changing the remote ID, also change the sub remote control unit at the same time (page 75 **AVC-A1HD**, page 77 **AVP-A1HD**).

13 232C Port (1) **AVC-A1HD**

15 232C Port (1) **AVP-A1HD**

Set when external controller or 2-way remote control unit (RC-7000CI and RC-7001RCI, sold separately) is connected.

[Selectable items]

Serial Control : Set when using an external controller.

2Way Remote : Set when using a 2-way remote control unit.

NOTE

In order to use a 2-way remote control (RC-7000CI or RC-7001RCI, sold separately), set "2Way Remote". In this case, the RS-232C terminal cannot be used for an external controller.

14 Dimmer **AVC-A1HD**

16 Dimmer **AVP-A1HD**

Adjust display brightness of the receiver.

[Selectable items] **Bright** **Dim** **Dark** **OFF**



Operating from the main unit

Press the **DIMMER** button.



15 Setup Lock **AVC-A1HD**

17 Setup Lock **AVP-A1HD**

Protect settings from inadvertent change.

[Selectable items] **ON** **OFF**



- When "Setup Lock" is set to "ON", the settings listed below can no longer be changed. Also, "SETUP LOCKED!" is displayed if you attempt to operate related buttons.
 - GUI menu operations
 - RESTORER
 - Parameters
 - MultEQ® XT 32
 - Channel Level
 - Audio Delay
- To cancel the setting, press the **MENU** button to re-display the "Setup Lock" screen, then change the setting to "OFF".

16 Maintenance Mode **AVC-A1HD**

18 Maintenance Mode **AVP-A1HD**

This sets the function for maintenance by a DENON service person or installer. (For professional use only.)

This function allows a DENON service person or installer to check the unit's status and make settings via the Internet.

NOTE

Only use this function if so instructed by a DENON service person or installer.

17 Firmware Update

AVC-A1HD

19 Firmware Update

AVP-A1HD

Update the firmware of the receiver.

Check for Update

You can check for firmware updates. You can also check approximately how long it will take to complete an update.

Start

Execute the update process.

When updating starts, the power indicator becomes red and the GUI screen is shut down.

The amount of update time which has elapsed is displayed during the update process.

When updating is complete the power indicator becomes green and normal status is resumed.

※ If the display reads as shown below, check the settings and network environment, then update again.

Display	Description
Updating failed	Updating failed.
Login failed	Failure to log into server.
Server is busy	Server is busy. Wait a while then try again.
Connection fail	Failure connecting to server.

18 Add New Feature

AVC-A1HD

20 Add New Feature

AVP-A1HD

Display the new functions which can be purchased for downloading to the unit and upgrade.

With this upgrade, the software is also upgraded so there is no need to use "Add New Feature".

This feature is used when there are further firmware upgrades.

When you purchase a new function and register your user information, "Registered" is displayed on this menu and you can proceed with the upgrade.

Upon completion of the upgrade, you can start using the new function.



When "Not Registered" is displayed on the Add New Feature screen, you cannot upgrade.

To use the upgrade function, you should purchase an upgrade package from the DENON website.

To purchase the package, you will need the ID number shown on this screen.

To display the ID number on the screen, hold the **▷** and **STATUS** buttons on the remote control unit down for 3 seconds or more.

Upgrade

Execute the upgrade process.

When upgrading starts, the power indicator becomes red and the GUI screen is shut down.

The amount of upgrade time which has elapsed is displayed during the upgrade process.

When upgrading is complete the power indicator becomes green and normal status is resumed.

※ If the upgrade is not successful, an error message identical to those in "Firmware Update" will appear on the display.

Upgrade Status

A list of the additional functions provided by the Upgrade will be displayed.

Notes concerning use of "Firmware Update" and "Add New Feature"

- In order to use these functions, you must have the correct system requirements and settings for a broadband Internet connection. For details, see @page 33 ~ 36 **AVC-A1HD**, @page 34 ~ 37 **AVP-A1HD**.
- Do not turn off the power until updating or upgrading is completed.
- Normally there is no need to use this function, aside from the cases described below.
 - Firmware Update : In the case of applying the latest firmware updates (free)
 - Add New Feature : In the case of future upgrades to add new functions to the receiver (payment required)
 - Information regarding the "Firmware Update" function and "Add New Feature" will be announced on the DENON web site each time related plans are defined.
- Even with a broadband connection to the Internet, approximately 1 hour is required for the updating/upgrading procedure to be completed. Once updating/upgrading starts, normal operations on the unit cannot be performed until updating/upgrading is completed. Furthermore, updating/upgrading the firmware may reset the backup data for the parameters, etc., set for the unit.
- When updating/upgrading the firmware, we recommend using wired connections (Ethernet cable).



Surround Mode

HOME THX CINEMA

THX surround sound mode to recreate the authentic sound of movie soundtracks.

Surround Playback of 2-channel Sources

[Selectable items]

PLIIx CINEMA PLII CINEMA Pro Logic PLIIz HEIGHT

Playing Multi-channel Sources (Dolby Digital, DTS, etc.)

[Selectable items]

HOME THX CINEMA :

This mode is for decoding the input signals according to their format and playing THX surround sound. The display when the HOME THX CINEMA mode is selected depends on the input signal and surround back output playback mode.

Input signal		Display
Dolby Digital Source	DOLBY DIGITAL (other than 2ch) / DOLBY DIGITAL EX / DOLBY DIGITAL Plus / DOLBY TrueHD	THX SURROUND EX
		THX Ultra2 Cinema
		THX Music Mode
		THX Games Mode
		THX Cinema
		PLIIx C+THX
DTS Surround Source	DTS (5.1ch) / DTS-ES Discrete 6.1 / DTS-ES Matrix 6.1 / DTS 96/24 / DTS-HD High Resolution Audio / DTS-HD Master Audio	PLIIz+THX
		ES MTRX6.1+THX
		ES DSCRT6.1+THX (*)
		THX Ultra2 Cinema
		THX Music Mode
		THX Games Mode
DVD-Audio, SACD	PCM (multi ch) / DSD (multi ch)	THX Cinema
		PLIIx C+THX
		PLIIz+THX
		THX SURROUND EX
		THX Ultra2 Cinema
		THX Music Mode
		THX Games Mode
		THX Cinema
		PLIIx C+THX
		PLIIz+THX

* : This is displayed when the input signal is "DTS-ES Discrete 6.1".



For details, see page 66.



Operating from the main unit or main remote control unit

Press the **HOME THX CINEMA** button on the main unit or the **THX** button on the main remote control unit.

Standard Playback

This is the standard mode for enjoying surround sound according to the program source.

To select these surround modes pressing the **STANDARD** button on the main unit or press the **STD** button on the main remote control unit. The mode switches each time the button is pressed. At this point, configure the "Audyssey DSX™" settings. For details, see page 42.

Surround Playback of 2-channel Sources

□ When using a surround back speaker

[Selectable items]

DOLBY PLIIx : This mode can be selected when a Dolby Pro Logic IIx decoder is used to play back 2-channel source in 6.1/7.1-channel surround sound including the surround back channel.
By adding the surround back channel, a stronger surround feeling is obtained compared to Dolby Pro Logic II.

DTS NEO:X : This mode can be selected when a DTS NEO:X decoder is used to play back 2-channel source in a maximum of 9.1 channel surround sound including the surround back channel.

□ When using a front height speaker

[Selectable items]

DOLBY PLIIz : This mode can be selected when a Dolby PLIIz decoder is used to play back 2-channel source in a maximum of 9.1 channel including the front height channel.
By adding a front height channel, the vertical expression is emphasized, improving the three-dimensionality of the sound.

DTS NEO:X : This mode can be selected when a DTS NEO:X decoder is used to play back 2-channel source in a maximum of 9.1 channel including the front height channel.

□ When using a front wide speaker

DTS NEO:X : This mode can be selected when a Dolby PLIIz decoder is used to play back 2-channel source in a maximum of 9.1 channel including the front wide channel.

□ When the surround back speakers, front height speakers and front wide speakers are not being used

[Selectable items]

DOLBY PLII : This mode can be selected when a Dolby Pro Logic II decoder is used to play back 2-channel source in 5.1-channel surround sound with a natural, realistic feel.

DTS NEO:X : This mode can be selected when a DTS NEO:X decoder is used to play back 2-channel source in 5.1-channel surround sound including the surround back channel.

DOLBY PLIIx or DOLBY PLII

- Cinema** : This mode is suited for movie sources.
- Music** : This mode is suited for music sources.
- Game** : This mode is suited for games.
- Pro Logic** : This mode can be selected when a DOLBY Pro Logic decoder is used to play 2-channel source in 4.1-channel surround sound (Left/Center/Right/Surround Mono). This can be selected when playing with a DOLBY PLII decoder. When this mode is selected, "DOLBY PL" is displayed.



Operating from the main unit

The "Cinema", "Music", or "Game" modes can be directly selected with the **CINEMA**, **MUSIC** or **GAME** button on the main unit.

DOLBY PLIIz

- Height** : This mode is the playback mode for Dolby PLIIz front height.

DTS NEO:X

- Cinema** : This mode is suited for movie sources.
- Music** : This mode is suited for music sources.
- Game** : This mode is suited for games.



Operating from the main unit

The "Cinema", "Music", or "Game" modes can be directly selected with the **CINEMA**, **MUSIC** or **GAME** button on the main unit.



Select the "Cinema", "Music", "Game" and "Pro Logic" modes at GUI menu "Parameters" – "Audio" – "Surround Parameters" – "Mode" (▶ page 38).

NOTE

- DTS NEO:X mode cannot be selected when the sampling frequency of the input signal is 32 kHz, 64 kHz and 128 kHz.
- DTS NEO:X cannot be selected when the input signal is DSD.

Playing Multi-channel Sources (Dolby Digital, DTS, etc.)

[Selectable items]

STANDARD :

This mode is for decoding the input signals according to their format and playing surround sound.

The display when the STANDARD mode is selected depends on the input signal and surround back output playback mode.

Input signal		Display
Dolby Digital Source	DOLBY DIGITAL (other than 2ch) / DOLBY DIGITAL EX	DOLBY DIGITAL
		DOLBY DIGITAL EX
		DOLBY DIGITAL+PLIIx CINEMA
		DOLBY DIGITAL+PLIIx MUSIC
DOLBY DIGITAL+NEO:X CINEMA		
DOLBY DIGITAL+NEO:X MUSIC		
DOLBY DIGITAL+NEO:X GAME		
DOLBY DIGITAL+PLIIz		
DOLBY DIGITAL Plus		DOLBY DIGITAL+
DOLBY TrueHD		DOLBY TrueHD
DTS Surround Source	DTS (5.1ch) / DTS-ES Discrete 6.1 / DTS-ES Matrix 6.1 / DTS 96/24	DTS SURROUND
		DTS+PLIIx CINEMA
		DTS+PLIIx MUSIC
		DTS+PLIIz
		DTS+NEO:X CINEMA
		DTS+NEO:X MUSIC
		DTS+NEO:X GAME
		DTS ES MTRX6.1 (*1)
		DTS ES DSCRT6.1 (*2)
		DTS 96/24 (*3)
	DTS-HD High Resolution Audio	DTS-HD HI RES
	DTS-HD Master Audio	DTS-HD MSTR

Input signal		Display
DVD-Audio, SACD	PCM (multi ch) / DSD (multi ch) (*4)	MULTI CH IN
		MULTI IN+Dolby EX
		MULTI IN+PLIIx CINEMA
		MULTI IN+PLIIx MUSIC
		MULTI IN+PLIIz
		MULTI CH IN 7.1
		MULTI IN+NEO:X CINEMA
		MULTI IN+NEO:X MUSIC
		MULTI IN+NEO:X GAME

*1 : This is displayed when the input signal is "DTS-ES Matrix 6.1" and the speaker configuration is 6.1 channel.

*2 : This is displayed when the input signal is "DTS-ES Discrete 6.1."

*3 : This is displayed when the input signal is "DTS 96/24"

*4 : DTS NEO:X cannot be selected when the input signal is DSD.



For details, see page 66 ~ 68.

NOTE

- DTS NEO:X mode cannot be selected when the sampling frequency of the input signal is 32 kHz, 64 kHz and 128 kHz.
- Audyssey DSX™ mode can be selected even when the **STANDARD** button is pressed.

Parameters



Parameters can be called out directly by pressing the **PARA** button on the main remote control unit.

**When this unit is upgraded, the "Audio" contents are changed.
When configuring the "Audio" settings, refer to this version of the Owner's Manual instead of the "Original version".**

Audio

Adjust various audio parameters.



Menu tree

Parameters

Audio

- 1 Surround Parameters
- 2 Tone
- 3 Audyssey Settings
- 4 A-DSX Soundstage
- 5 RESTORER
- 6 Audio Delay

1 Surround Parameters

Adjust surround sound parameters.
The adjustable parameters differ for the different surround modes (page 64, 65).

Mode

Select the mode according to the playback source.

- In the PLIIx or PLII mode

[Selectable items] **Cinema** **Music** **Game** **Pro Logic***

*: Can be selected in the PLII mode.

- In the DTS NEO:X mode

[Selectable items] **Cinema** **Music** **Game**



The "Music" mode is also effective for movie sources including a lot of stereo music.

- In the THX mode (for 2-channel sources)

[Selectable items]

Surround Back ON **Surround Back OFF** **THX Games Mode**

- In the THX mode (for Multi-channel sources)

[Selectable items]

THX Surr. EX **ES DSCRT** **ES MTRX**
PLIIx Cinema + THX **THX Ultra2 Cinema** **THX Music Mode**
THX Games Mode **THX Cinema** **Surround Back ON**

Decoder

Select this when playing analog, PCM or other 2 channel sources.
The signals are converted into multi channel signals using the decoders shown below and played in the Dolby Headphone mode.

- In the THX mode (for 2-channel sources)

[Selectable items]

PLIIx CINEMA **PLII CINEMA** **Pro Logic** **PLIIz**

- In the DOLBY HEADPHONE mode

[Selectable items]

PLII CINEMA **PLII MUSIC** **OFF**

Cinema EQ

Softens the treble range of movie soundtracks for better understanding.

[Selectable items] **ON** **OFF**

DRC

Compress dynamic range (difference between loud and soft sounds).

[Selectable items] **Auto** **Low** **Middle** **High** **OFF**



This can be set in the Dolby TrueHD mode.

D.COMP

Compress dynamic range (difference between loud and soft sounds).

[Selectable items] **OFF** **Low** **Middle** **High**



When playing DTS sources, this is only displayed for compatible software.

LFE

Adjust the low-frequency effects level (LFE).

[Variable range] **-10dB** ~ **0dB**



For proper playback of the different program sources, we recommend setting to the values below.

- Dolby Digital sources: "0 dB"
- DTS movie sources: "0 dB"
- DTS music sources: "-10 dB"

Center Gain

Assign center channel signal to front left and right channels for wider sound.

In DTS NEO:X mode, "Cinema" or "Game" is selected.

[Variable range] **0.0** ~ **1.0**

In DTS NEO:X mode, "Music" is selected.

[Variable range] **0.0** ~ **0.3** ~ **1.0**



This can be set when playing back a DTS NEO:X.

Panorama

Assign front L/R signal also to surround channels, for wider sound.

[Selectable items] **ON** **OFF**

Dimension

Shift sound image center to front or rear, to adjust playback balance.

[Variable range] **0** ~ **3** ~ **6**

Center Width

Assign center channel signal to front left and right channels for wider sound.

[Variable range] **0** ~ **3** ~ **7**

Delay Time

Adjust delay time to control sound stage size.

[Variable range] **0ms** ~ **30ms** ~ **300ms**

Effect

Switch effect signal for multi-surround speakers on and off.

[Selectable items] **ON** **OFF**

Effect Level

Adjust effect signal level.

[Variable range] **1** ~ **10** ~ **15**



Set to a lower level if the positioning and sense of phase of the surround signals seems unnatural.

Room Size

Determine size of acoustic environment.

[Selectable items]

Small **Medium small** **Medium** **Medium large** **Large**

NOTE

"Room Size" does not indicate the size of the room in which sources are played.

AFDM

Auto-select surround mode by source.

This function only works for software containing a special identification signal.

If the software being played is recorded in Dolby Digital EX, it is played in 6.1-channels. If not, it is played in 5.1-channels.

[Selectable items] **ON** **OFF**

Example : Playing Dolby Digital software (with EX flag)

- When "AFDM" is set to "ON", the surround mode is automatically set to the DOLBY D + PLIIx C mode.
- To play in the DOLBY DIGITAL EX mode, set "AFDM" to "OFF" and "SB CH Out" to "MTRX ON".



Some Dolby Digital EX sources do not include EX flags. If the playback mode does not switch automatically even when "AFDM" is set to "ON", set "SB CH Out" to "MTRX ON" or "PLIIx CINEMA".

SB CH Out (for Multi-channel sources)

Select playback mode for surround back channels.

[Selectable items]

ON *1 **MTRX ON** **PLIIx CINEMA** *2 **PLIIx MUSIC** *3 **OFF**

*1: Convert the 5.1-channel source of the DTS/DTS-HD input signals to the 7.1-channel output recommended by DTS and then play. This can be selected when playing the 5.1-channel source of DTS/DTS-HD.

*2: This can be selected when "Surround Back" is set to "2spkr" at the GUI menu "Manual Setup" – "Speaker Setup" – "Speaker Configuration" setting (page 23).

*3: This can be selected when "Surround Back" is set to "2spkr" or "1spkr" at the GUI menu "Manual Setup" – "Speaker Setup" – "Speaker Configuration" setting.



When using the surround back speaker, you can change the "SB CH Out" setting by pressing the STANDARD button.

SB CH Out (for 2-channel sources)

Determine whether to use surround back speakers.

[Selectable items] **ON** **OFF**

Height Gain

Control the front height channel volume.

[Selectable items] **Low** **Middle** **High**

NOTE

"Height Gain" is displayed for the following settings.

- When the "Speaker Setup" – "Speaker Configuration" – "Front Height" setting (page 23) is set other than "None".
- When surround mode is "PLIIz" or the PLIIz decoder is used.

Input Channel **AVP-A1HD**

Select channel using external input connectors (EXT. IN) for source being played.

[Selectable items] **8CH** **2CH**



Can be selected when GUI menu "Manual Setup" – "Audio Setup" – "EXT. IN Setup" – "Mode" is set to "DSP" (page 26).

Subwoofer Att.

Attenuate subwoofer level when using EXT. IN input.

[Selectable items] **ON** **OFF**



Set this to "ON" if the subwoofer channel level seems too high when playing Super Audio CD.

Subwoofer

Turn subwoofer output on and off.

[Selectable items] **ON** **OFF**

Default

Resets the settings to the default values.

2 Tone

Adjust the tonal quality of the sound.

Tone Defeat

Turn tone adjustments off.

[Selectable items] **ON** **OFF**

NOTE

- The tone cannot be adjusted when in the DIRECT, PURE DIRECT and HOME THX CINEMA mode.
- "Tone" cannot be set when "Dynamic EQ®" (page 41) is set to "ON".

Bass

Adjust bass for all channels together.

[Variable range] **-6dB ~ +6dB**

Treble

Adjust treble for all channels together.

[Variable range] **-6dB ~ +6dB**



"Bass" and "Treble" can be set when "Tone Defeat" is set to "OFF".

Front

Adjust each front channel tone.

[Selectable items] **Bass** **Treble**

[Variable range] **-6dB ~ +6dB**

Center

Adjust each center channel tone.

[Selectable items] **Bass** **Treble**

[Variable range] **-6dB ~ +6dB**

Surround

Adjust each surround channel tone.

[Selectable items] **Bass** **Treble**

[Variable range] **-6dB ~ +6dB**

Surround Back

Adjust each surround back channel tone.

[Selectable items] **Bass** **Treble**

[Variable range] **-6dB ~ +6dB**

Front Height

Adjust each front height channel tone.

[Selectable items] **Bass** **Treble**

[Variable range] **-6dB ~ +6dB**

Front Wide

Adjust each front wide channel tone.

[Selectable items] **Bass** **Treble**

[Variable range] **-6dB ~ +6dB**

Subwoofer

Adjust each subwoofer channel tone.

[Selectable items] **Bass**

[Variable range] **-6dB ~ +6dB**



This can be set individually for the separate surround mode other than PURE DIRECT, DIRECT and HOME THX CINEMA mode.

3 Audyssey Settings

Set Audyssey MultEQ® XT 32, Audyssey Dynamic EQ® and Audyssey Dynamic Volume®. These can be selected after Auto Setup has been performed.

For additional information on Audyssey technology, please see page 63.

MultEQ® XT 32

MultEQ® XT 32 corrects both time and frequency response problems in the listening area based on Auto Setup calibration. We recommend "Audyssey".

MultEQ® XT 32 is the prerequisite function for Dynamic EQ® and Dynamic Volume®.

[Selectable items]

Audyssey :Optimize the frequency response of all speakers.

Audyssey Byp. L/R :Optimize frequency response of speakers except front L and R speakers.

Audyssey Flat :Optimize frequency response of all speakers to flat response.

Manual :Apply frequency response set with "Manual EQ" (page 27).

OFF :Turn "MultEQ® XT 32" equalizer off.

Operating from the main unit or main remote control unit

Press the **ROOM EQ** button on the main unit or the **EQ** button on the main remote control.

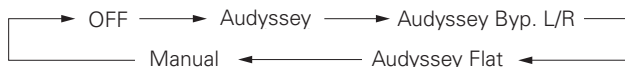

- When "Audyssey", "Audyssey Byp. L/R" or "Audyssey Flat" is selected, "AUDYSSEY MULTEQ XT" lights.
- After running Auto Setup, if the Speaker Configuration, Distance, Channel Level, and Crossover Frequency have changed without increasing the number of speakers measured, only "AUDYSSEY MULTEQ XT" lights.



- "Audyssey", "Audyssey Byp. L/R" and "Audyssey Flat" can be selected after the Auto Setup procedure has been performed.
- After performing "Auto Setup", the "MultEQ® XT 32" setting automatically becomes "Audyssey".
- If the settings of speakers for which "None" has been determined at "Auto Setup" are changed, "Audyssey", "Audyssey Byp. L/R" and "Audyssey Flat" cannot be selected. Either perform Auto Setup again, or return to the setting after running Auto Setup with "Auto Setup" – "Parameter Check" – "Restore" (page 22).
- When using headphones, "MultEQ® XT 32" is always set to "OFF".

Dynamic EQ®

Solve the problem of deteriorating sound quality as volume is decreased by taking into account human perception and room acoustics. Works with MultEQ® XT 32.

[Selectable items] **ON** **OFF**



Operating from the main unit

Press **DYNAMIC EQ** button.



- "Dynamic EQ®" can only be set when Auto Setup has been performed.
- After performing "Auto Setup", the "Dynamic EQ®" setting automatically becomes "ON".
- When "MultEQ® XT 32" is set to "OFF" or "Manual", "Dynamic EQ®" is automatically set to "OFF".
- Before running Auto Setup and after running Auto Setup, if the number of speakers has increased or you pressed **DYNAMIC EQ** button, "Run Audyssey" is displayed. In this case, either perform Auto Setup, or return to the setting after running Auto Setup with "Auto Setup" – "Parameter Check" – "Restore" (page 22).

NOTE

- "Dynamic EQ®" cannot be set in the following situations.
 - If "Auto Setup" fails to be completed.
 - After running Auto Setup, when the number of used speakers has increased from the number of measured speakers.
- When you set "Dynamic EQ®" to "ON", "Tone" (page 40) cannot be used.

Reference Level Offset

Audyssey Dynamic EQ® is referenced to the standard film mix level. It makes adjustments to maintain the reference response and surround envelopment when the volume is turned down from 0 dB. However, film reference level is not always used in music or other non-film content.

Dynamic EQ® Reference Level Offset provides three offsets from the film level reference (5 dB, 10 dB, and 15 dB) that can be selected when the mix level of the content is not within the standard.

[Selectable items]

0dB :This is the default setting and should be used when listening to movies (Film Ref).

5dB :Select this setting for content that has a very wide dynamic range, such as classical music.

10dB :Select this setting for jazz or other music that has a wider dynamic range. This setting should also be selected for TV content as that is usually mixed at 10 dB below film reference.

15dB :Select this setting for pop/rock music or other program material that is mixed at very high listening levels and has a compressed dynamic range.



Setting is enabled when "Dynamic EQ®" is "ON" (page 41).

Dynamic Volume®

Solve the problem of large variations in volume level between TV, movies and other content (between quiet passages and loud passages, etc.) by automatically adjusting to the user's preferred volume setting.

[Selectable items]

ON : Use Dynamic Volume®.
Dynamic Volume® effect will be at the level of the "Setting".

OFF : Do not use Dynamic Volume®.

Operating from the main unit

Press **DYNAMIC EQ** button.

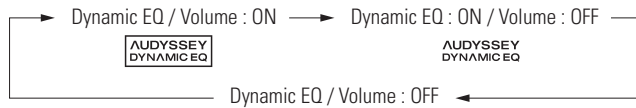

- "Dynamic Volume®" can only be set when Auto Setup has been performed.
- When "MultEQ® XT 32" is set to "OFF" or "Manual", "Dynamic Volume®" is automatically set to "OFF".
- Before running Auto Setup and after running Auto Setup, if the number of speakers has increased or you pressed **DYNAMIC EQ** button, "Run Audyssey" is displayed. In this case, either perform Auto Setup, or return to the setting after running Auto Setup with "Auto Setup" – "Parameter Check" – "Restore" (page 22).

NOTE

- "Dynamic Volume®" cannot be set in the following situations.
- If "Auto Setup" fails to be completed.
 - After running Auto Setup, when the number of used speakers has increased from the number of measured speakers.

Setting

Set Dynamic Volume® effect.

[Selectable items]

Midnight : Most adjustment to loudest and softest sounds.

Evening : Medium adjustment to loudest and softest sound.

Day : Least adjustment to loudest and softest sounds.



- Can be set when "Dynamic Volume®" (page 42) is set to "ON".
- **AUDYSSEY DYNAMIC EQ** is displayed when set to "Midnight", "Evening" or "Day".
- If "Dynamic Volume®" is set to "Yes" in Auto Setup (page 20), the setting is automatically changed to "Evening".
- "Setting" can only be set when Auto Setup has been performed.

NOTE

- "Setting" cannot be set in the following situations.
- If "Auto Setup" fails to be completed.
 - After running Auto Setup, when the number of used speakers has increased from the number of measured speakers.
 - If "Dynamic Volume®" setting is "OFF".

4 A-DSX Soundstage

Adjust Audyssey DSX™ setting and sound stage parameters.

Audyssey DSX™

Provides more immersive surround sound by adding the new channels.

[Selectable items]

ON-Height- : Turn on A-DSX processing for height expansion.

ON-Wide- : Turn on A-DSX processing for wide expansion.

OFF : Do not set Audyssey DSX™.

Operating from the main unit or main remote control unit

Press the **STANDARD** button on the main unit or **STD** button on the main remote control until "A-DSX" is shown in the display.

Stage Width

Adjust sound stage width when using front wide speakers.

[Variable range] **-10** ~ **0** ~ **+10**

Stage Height

Adjust sound stage height when using front height speakers.

[Variable range] **-10** ~ **0** ~ **+10**



- "Audyssey DSX™" can be set when you are using front height speakers or front wide speakers.
- "Audyssey DSX™" is only valid when using a center speaker.
- "Audyssey DSX™" is valid when surround mode is STANDARD mode other than PLIIz Height or DTS NEO:X.
- "A-DSX Soundstage" cannot be configured if the HD Audio source being played includes Front height and Front wide channels. In this case, the respective channels are played back using the input signals.

About Audyssey Dynamic Surround Expansion (A-DSX)

Audyssey DSX™ is a scalable system that adds new speakers to improve surround impression.

Starting with a 5.1 system Audyssey DSX™ first adds Wide channels for the biggest impact on envelopment. Research in human hearing has proven that information from the Wide channels is much more critical in the presentation of a realistic soundstage than the Back Surround channels found in traditional 7.1 systems. Audyssey DSX™ then creates a pair of Height channels to reproduce the next most important acoustical and perceptual cues. In addition to these new Wide and Height channels, Audyssey DSX™ applies Surround Envelopment Processing to enhance the blend between the front and surround channels.

5 RESTORER

This function restores compressed audio signals to how they were before compression and corrects the sense of volume of the bass and treble to obtain richer playback sound.

[Selectable items]

OFF

Mode1 (RESTORER 64)

Mode2 (RESTORER 96)

Mode3 (RESTORER HQ)

The default setting for "NET/USB" and "iPod" is "Mode3". All others are set to "OFF".



Operating from the main unit or main remote control unit

During playback, press the **RESTORER** button on the main unit or the **RSTR** button on the main remote control unit.

When set to something other than "OFF", "**RESTORER**" is displayed.

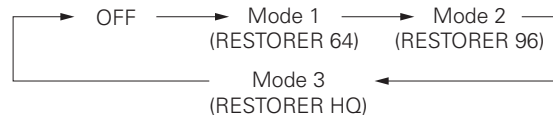

About the RESTORER function

- Such compressed audio formats as MP3, WMA (Windows Media Audio) and MPEG-4 AAC reduce the amount of data by eliminating signal components that are hard for the human ear to hear. The RESTORER function generates the signals eliminated upon compression, restoring the sound to conditions near those of the original sound before compression. It also corrects the sense of volume of the bass to obtain richer sound with compressed audio signals.
- This is displayed on the GUI menu and can be set when the input source is set to "NET/USB"; or when analog signals or PCM signals (fs = 44.1/48 kHz) are input.

6 Audio Delay

Compensate for mismatched timing between video and audio.

Delay audio.

This sets the delay time for audio signals.

[Variable range] **0ms** ~ **200ms**



Operating from the main unit or the main remote control unit

※ The GUI menu is not displayed when carrying out this setting.

- ① Press the **AUDIO DELAY** button on the main unit or **A. DL** button on the main remote control unit.
- ② Use the **◀▶** button to set.



- This cannot be adjusted when playing in the EXT. IN, DIRECT or STEREO mode (with "Crossover Frequency" set to "FIXED-THX-"; "Front" set to "Large"; "Tone Defeat" to "ON" and "MultEQ® XT 32" to "OFF").
- The adjustment range is 0 to 100 ms when the Auto Lipsync Correction function is activated.

Information

When this unit is upgraded, the "Status" or "Quick Select" contents are changed. To check items related to "Status" or "Quick Select", refer to this version of the Owner's Manual instead of the "Original version".

Status
Shows information about current settings.

● Menu tree ●

- Information
- Status
 - 1 MAIN ZONE
 - 2 ZONE2/3/4

1 MAIN ZONE
Shows information about settings for MAIN ZONE. The items displayed differ according to the input source.

- [Items to be checked]
- Select Source
 - Name
 - Surround Mode
 - Rec Select
 - Video Select
 - i/p Scaler
 - Input Mode
 - Source Level
 - MultEQ® XT 32
 - Dynamic EQ®
 - Dynamic Volume®
 - RESTORER etc.

2 ZONE2/3/4
Shows information about settings for multi-zone.

- [Items to be checked]
- Power
 - Select Source
 - Volume Level

Quick Select
Shows information about "Quick Select" settings.

● Menu tree ●

- Information
- Quick Select
 - Quick Select 1
 - Quick Select 2
 - Quick Select 3

- [Items to be checked]
- Select Source
 - Input Mode
 - MultEQ® XT 32
 - Dynamic EQ®
 - Dynamic Volume®
 - Auto Surround Mode setting
 - Volume Level
 - Name
- For instructions on storing settings at Quick Select 1 to 3, see @page 65 **AVC-A1HD**, @page 67 **AVP-A1HD**.

When the upgrade is performed, "Amp assignment settings" and "Multi-zone connection method" are returned to the default settings. When configuring the "Amp Assign/Multi-Zone Connections and Operations" settings, refer to this version of the Owner's Manual instead of the "Original version" .

This unit is compatible with the following types of playback:

- **Multi-zone playback (ZONE2 & ZONE3)**
- **Bi-amp playback (front speaker)**
- **Bi-wiring playback (front speaker)**

NOTE

- For bi-amp and bi-wiring playback, use speakers compatible with that type of connection.
- When conducting bi-amp or bi-wiring playback, remove the short-circuiting boards (or wires) from the speaker terminals.

Multi-Zone Settings with the Amp Assign Function

The amp assign function lets you assign the amplifiers for the different channels built into the this unit to the speaker outputs for the different zones.

Select the desired playback environment from among "Setting 1" to "Setting 16", then set the corresponding "Amp Assign" mode at GUI menu "Manual Setup" – "Option Setup" – "Amp Assign" (☞ page 28). Connect the speakers as described at "Speaker connections".



With "Setting 2" to "Setting 6," "Setting 8" to "Setting 10," "Setting 12" and "Setting 13", it is possible to switch the Amp Assign mode between the 9.1/7.1-channel mode and the multi-zone mode without changing the speaker connections.

Setting 1:

● 9.1-channel playback

Amp Assign mode : **Normal** (Settings for upgrade)

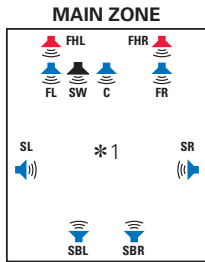

OR

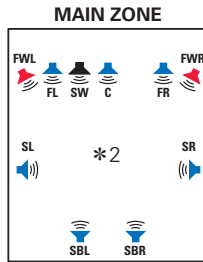

*1 : To connect front height speakers, select "Front Height" in "Manual Setup" – "Option Setup" – "Amp Assign" – "Extension Channel" settings (page 28, 29) in the GUI menu.

*2 : To connect front wide speakers, select "Front Wide" in "Manual Setup" – "Option Setup" – "Amp Assign" – "Extension Channel" settings (page 28, 29) in the GUI menu.

[Speaker abbreviations]

FL : Front speaker (L)
FR : Front speaker (R)
C : Center speaker
SW : Subwoofer

SL : Surround speaker (L)
SR : Surround speaker (R)
SBL : Surround back speaker (L)
SBR : Surround back speaker (R)

FHL : Front height speaker (L)
FHR : Front height speaker (R)
FWL : Front wide speaker (L)
FWR : Front wide speaker (R)

Speaker connections

☐ Speakers to connect to the speaker terminals

Speaker terminal	FRONT		CENTER	SURR.		SURR.BACK		AMP ASSIGN		FH/FW/ AMP ASSIGN-2	
	R	L		R	L	R	L	R	L	R	L
Speaker to connect	FR	FL	C	SR	SL	SBR	SBL				

☐ Power amps to connect to the pre-out terminals

Pre out terminal	FR	FL	C	SR	SL	SBR	SBL	FHR/FWR	FHL/FWL
Speaker to connect								FHR	FHL
								FWR	FWL

Audio output speakers

Speaker Amp Assign mode	FRONT		CENTER	SURR.		SURR. BACK		FRONT HEIGHT		FRONT WIDE		ZONE2		ZONE3	
	R	L		R	L	R	L	R	L	R	L	R	L	R	L
Normal	○	○	○	○	○	○	○	○	○						
	○	○	○	○	○	○	○			○	○				

Setting 2:

With this setting it is possible to switch between the following two playback modes.

● 9.1-channel playback

● Multi-zone playback

- 7.1-channel playback + ZONE2 stereo playback

Amp Assign mode: **ZONE2**

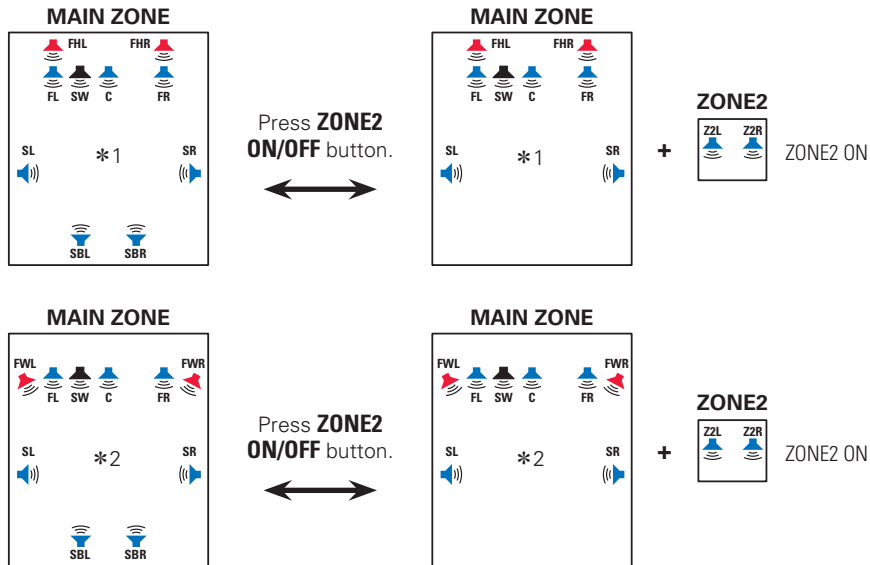

*1 : To connect front height speakers, select "Front Height" in "Manual Setup" – "Option Setup" – "Amp Assign" – "Extension Channel" settings (page 28, 29) in the GUI menu.

*2 : To connect front wide speakers, select "Front Wide" in "Manual Setup" – "Option Setup" – "Amp Assign" – "Extension Channel" settings (page 28, 29) in the GUI menu.

Speaker connections

❑ Speakers to connect to the speaker terminals

Speaker terminal	FRONT		CENTER	SURR.		SURR.BACK		AMP ASSIGN		FH/FW/ AMP ASSIGN-2	
	R	L		R	L	R	L	R	L	R	L
Speaker to connect	FR	FL	C	SR	SL	SBR	SBL			Z2R	Z2L

❑ Power amps to connect to the pre-out terminals

Pre out terminal	FR	FL	C	SR	SL	SBR	SBL	FHR/FWR	FHL/FWL
Speaker to connect								FHR	FHL
								FWR	FWL

Audio output speakers

Speaker Amp Assign mode	FRONT		CENTER	SURR.		SURR. BACK		FRONT HEIGHT		FRONT WIDE		ZONE2		ZONE3	
	R	L		R	L	R	L	R	L	R	L	R	L	R	L
ZONE2															
ZONE2 OFF	○	○	○	○	○	○	○	○	○	○					
ZONE2 ON	○	○	○	○	○			○	○			○	○		
	○	○	○	○	○					○	○	○	○		

Setting 3:

With this setting it is possible to switch between the following two playback modes.

- **9.1-channel playback**

- **Multi-zone playback**

- 7.1-channel playback + ZONE3 stereo playback

Amp Assign mode : **ZONE3**

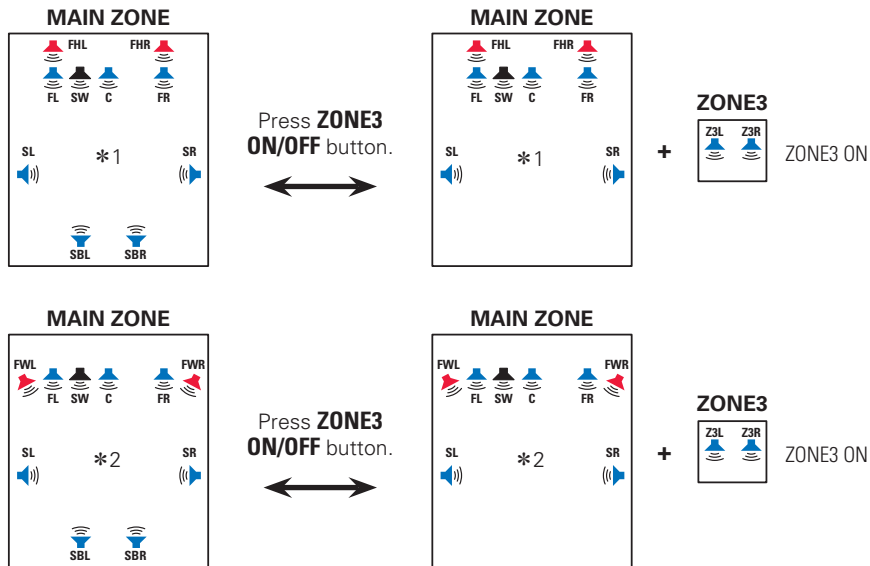

*1 : To connect front height speakers, select "Front Height" in "Manual Setup" – "Option Setup" – "Amp Assign" – "Extension Channel" settings (page 28, 29) in the GUI menu.

*2 : To connect front wide speakers, select "Front Wide" in "Manual Setup" – "Option Setup" – "Amp Assign" – "Extension Channel" settings (page 28, 29) in the GUI menu.

Speaker connections

Speakers to connect to the speaker terminals

Speaker terminal	FRONT		CENTER	SURR.		SURR.BACK		AMP ASSIGN		FH/FW/ AMP ASSIGN-2	
	R	L		R	L	R	L	R	L	R	L
Speaker to connect	FR	FL	C	SR	SL	SBR	SBL			Z3R	Z3L

Power amps to connect to the pre-out terminals

Pre out terminal	FR	FL	C	SR	SL	SBR	SBL	FHR/FWR	FHL/FWL
Speaker to connect								FHR	FHL
								FWR	FWL

Audio output speakers

Speaker / Amp Assign mode	FRONT		CENTER	SURR.		SURR. BACK		FRONT HEIGHT		FRONT WIDE		ZONE2		ZONE3	
	R	L		R	L	R	L	R	L	R	L	R	L	R	L
ZONE3															
ZONE3 OFF	○	○	○	○	○	○	○	○	○						
ZONE3 ON	○	○	○	○	○			○	○					○	○
	○	○	○	○	○					○	○			○	○

Setting 4:

With this setting it is possible to switch between the following two playback modes.

● 9.1-channel playback

● Multi-zone playback

- 7.1-channel playback + ZONE2 monaural playback + ZONE3 monaural playback

Amp Assign mode: **ZONE (MONO)**

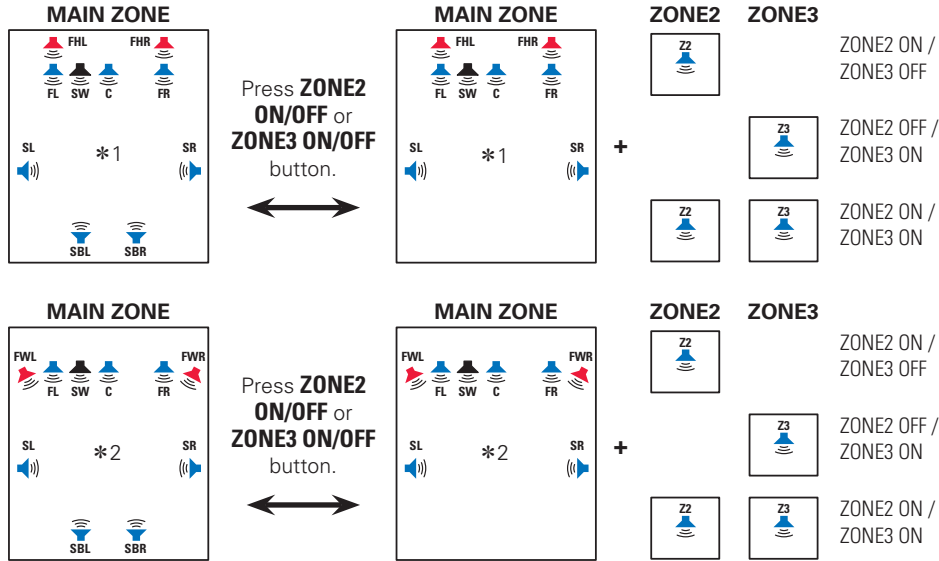

*1 : To connect front height speakers, select "Front Height" in "Manual Setup" – "Option Setup" – "Amp Assign" – "Extension Channel" settings (page 28, 29) in the GUI menu.

*2 : To connect front wide speakers, select "Front Wide" in "Manual Setup" – "Option Setup" – "Amp Assign" – "Extension Channel" settings (page 28, 29) in the GUI menu.

Speaker connections

❑ Speakers to connect to the speaker terminals

Speaker terminal	FRONT		CENTER	SURR.		SURR.BACK		AMP ASSIGN		FH/FW/ AMP ASSIGN-2	
	R	L		R	L	R	L	R	L	R	L
Speaker to connect	FR	FL	C	SR	SL	SBR	SBL			Z3 MONO	Z2 MONO

❑ Power amps to connect to the pre-out terminals

Pre out terminal	FR	FL	C	SR	SL	SBR	SBL	FHR/FWR	FHL/FWL
Speaker to connect								FHR	FHL
								FWR	FWL

Audio output speakers

Amp Assign mode	FRONT		CENTER	SURR.		SURR. BACK		FRONT HEIGHT		FRONT WIDE		ZONE2	ZONE3
	R	L		R	L	R	L	R	L	R	L	Monaural	Monaural
ZONE (MONO)													
ZONE2 OFF / ZONE3 OFF	○	○	○	○	○	○	○	○	○				
ZONE2 ON / ZONE3 OFF	○	○	○	○	○			○	○			○	
ZONE2 OFF / ZONE3 ON	○	○	○	○	○			○	○				○
ZONE2 ON / ZONE3 ON	○	○	○	○	○			○	○			○	○

Setting 5:

With this setting it is possible to switch between the following two playback modes.

● 9.1-channel playback

● Multi-zone playback

- 3.1-channel playback + ZONE2 stereo playback + ZONE3 stereo playback
- 3.1-channel playback + ZONE3 stereo playback
- 7.1-channel playback + ZONE2 stereo playback

Amp Assign mode : **ZONE2/ZONE3**

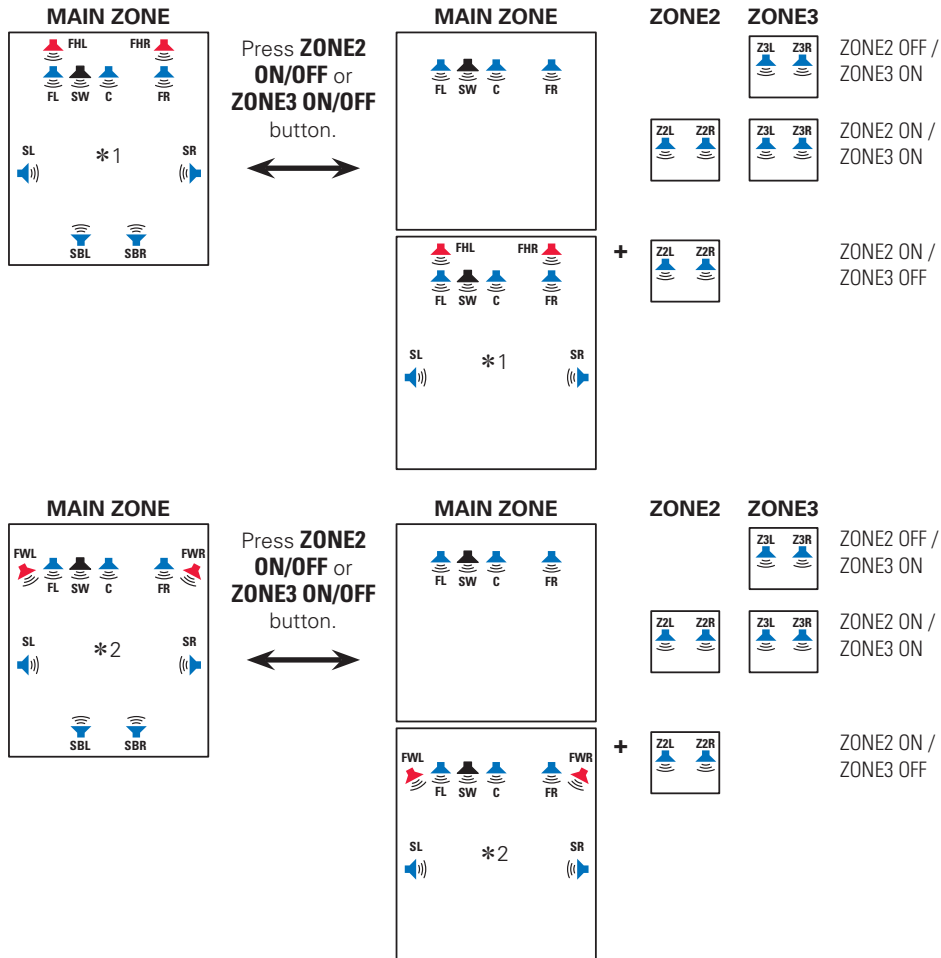

*1 : To connect front height speakers, select "Front Height" in "Manual Setup" – "Option Setup" – "Amp Assign" – "Extension Channel" settings (page 28, 29) in the GUI menu.

*2 : To connect front wide speakers, select "Front Wide" in "Manual Setup" – "Option Setup" – "Amp Assign" – "Extension Channel" settings (page 28, 29) in the GUI menu.

Speaker connections

❑ Speakers to connect to the speaker terminals

Speaker terminal	FRONT		CENTER	SURR.		SURR.BACK		AMP ASSIGN		FH/FW/ AMP ASSIGN-2	
	R	L		R	L	R	L	R	L	R	L
Speaker to connect	FR	FL	C	SR	SL	SBR	SBL	Z3R	Z3L	Z2R	Z2L

❑ Power amps to connect to the pre-out terminals

Pre out terminal	FR	FL	C	SR	SL	SBR	SBL	FHR/FWR	FHL/FWL
Speaker to connect								FHR	FHL
								FWR	FWL

Audio output speakers

Speaker Amp Assign mode	FRONT		CENTER	SURR.		SURR. BACK		FRONT HEIGHT		FRONT WIDE		ZONE2		ZONE3	
	R	L		R	L	R	L	R	L	R	L	R	L	R	L
ZONE2/ZONE3															
ZONE2 OFF / ZONE3 OFF	○	○	○	○	○	○	○	○	○						
ZONE2 ON / ZONE3 OFF	○	○	○	○	○			○	○			○	○		
ZONE2 OFF / ZONE3 ON	○	○	○											○	○
ZONE2 ON / ZONE3 ON	○	○	○									○	○	○	○

Setting 6:

With this setting it is possible to switch between the following two playback modes.

● 9.1-channel playback

● Multi-zone playback

- 3.1-channel playback + ZONE2 monaural playback + ZONE3 monaural playback
- 3.1-channel playback + ZONE3 monaural playback
- 7.1-channel playback + ZONE2 monaural playback

Amp Assign mode : **ZONE2/3 (MONO)**

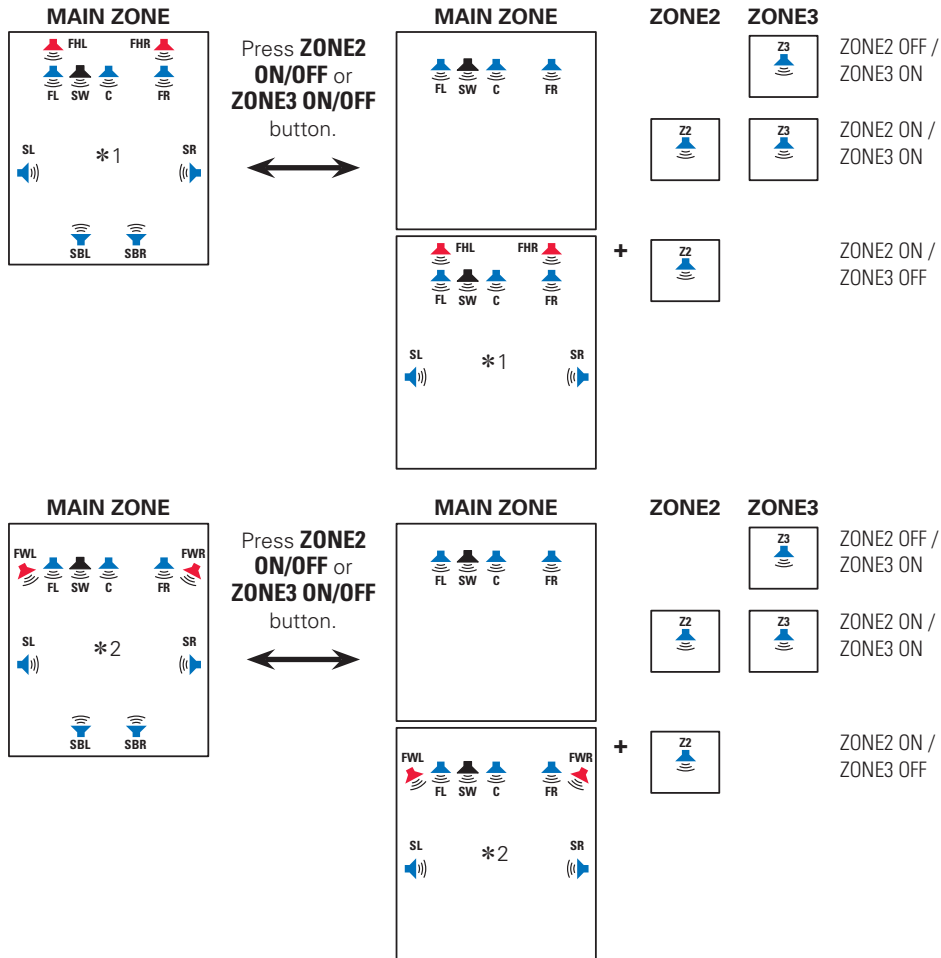

*1 : To connect front height speakers, select "Front Height" in "Manual Setup" – "Option Setup" – "Amp Assign" – "Extension Channel" settings (page 28, 29) in the GUI menu.

*2 : To connect front wide speakers, select "Front Wide" in "Manual Setup" – "Option Setup" – "Amp Assign" – "Extension Channel" settings (page 28, 29) in the GUI menu.

Speaker connections

❑ Speakers to connect to the speaker terminals

Speaker terminal	FRONT		CENTER	SURR.		SURR.BACK		AMP ASSIGN		FH/FW/ AMP ASSIGN-2	
	R	L		R	L	R	L	R	L	R	L
Speaker to connect	FR	FL	C	SR	SL	SBR	SBL	Z3 MONO	Z3 MONO	Z2 MONO	Z2 MONO

❑ Power amps to connect to the pre-out terminals

Pre out terminal	FR	FL	C	SR	SL	SBR	SBL	FHR/FWR	FHL/FWL
Speaker to connect								FHR	FHL
								FWR	FWL

Audio output speakers

Amp Assign mode	Speaker		CENTER	SURR.		SURR. BACK		FRONT HEIGHT		FRONT WIDE		ZONE2	ZONE3
	R	L		R	L	R	L	R	L	R	L	Monaural	Monaural
ZONE2/3 (MONO)													
ZONE2 OFF / ZONE3 OFF	○	○	○	○	○	○	○	○	○				
ZONE2 ON / ZONE3 OFF	○	○	○	○	○			○	○			○	
ZONE2 OFF / ZONE3 ON	○	○	○										○
ZONE2 ON / ZONE3 ON	○	○	○									○	○

Setting 7:

- Making bi-wiring connections for the FL and FR channels in the MAIN ZONE and conducting 9.1-channel playback (switching with other modes not possible)

Amp Assign mode : **Bi-Wiring**

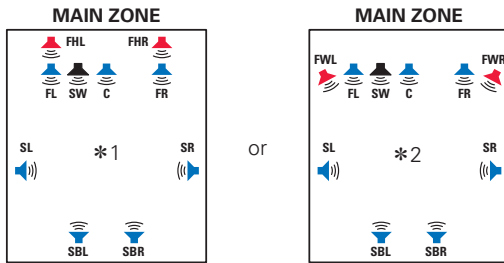

*1 : To connect front height speakers, select "Front Height" in "Manual Setup" – "Option Setup" – "Amp Assign" – "Extension Channel" settings (page 28, 29) in the GUI menu.

*2 : To connect front wide speakers, select "Front Wide" in "Manual Setup" – "Option Setup" – "Amp Assign" – "Extension Channel" settings (page 28, 29) in the GUI menu.

Speaker connections

Speakers to connect to the speaker terminals

Speaker terminal	FRONT		CENTER	SURR.		SURR.BACK		AMP ASSIGN		FH/FW/ AMP ASSIGN-2	
	R	L		R	L	R	L	R	L	R	L
Speaker to connect	FR	FL	C	SR	SL	SBR	SBL			FR	FL
											Bi-Wiring

Power amps to connect to the pre-out terminals

Pre out terminal	FR	FL	C	SR	SL	SBR	SBL	FHR/FWR	FHL/FWL
Speaker to connect								FHR	FHL
								FWR	FWL

Audio output speakers

Speaker Amp Assign mode	FRONT		CENTER	SURR.		SURR. BACK		FRONT HEIGHT		FRONT WIDE		ZONE2		ZONE3	
	R	L		R	L	R	L	R	L	R	L	R	L	R	L
Bi-Wiring	○	○	○	○	○	○	○	○	○						
	○	○	○	○	○	○	○			○	○				

Setting 8:

With this setting it is possible to switch between the following two playback modes.

● 9.1-channel playback

● Multi-zone playback

- Bi-wiring connection 7.1 channel playback + ZONE2 stereo playback

Amp Assign mode: **Bi & ZONE2**

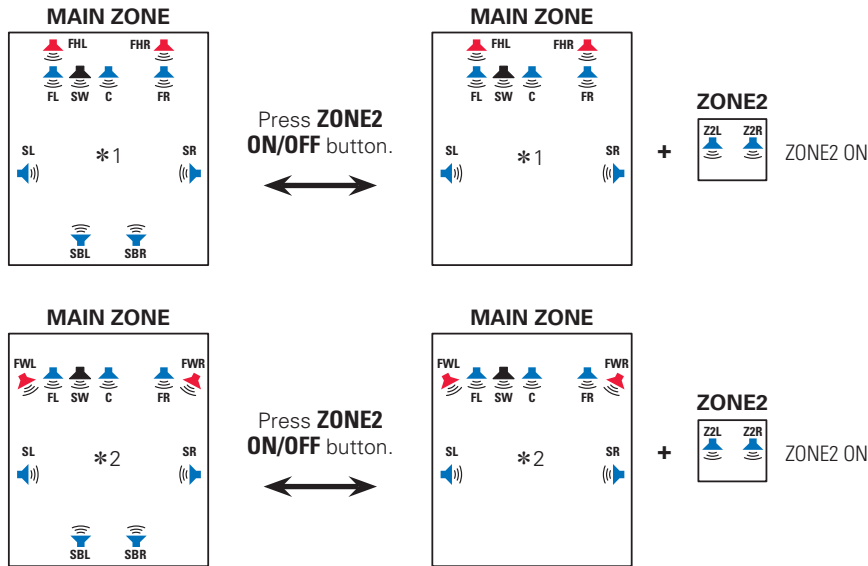

* 1 : To connect front height speakers, select "Front Height" in "Manual Setup" – "Option Setup" – "Amp Assign" – "Extension Channel" settings (page 28, 29) in the GUI menu.

* 2 : To connect front wide speakers, select "Front Wide" in "Manual Setup" – "Option Setup" – "Amp Assign" – "Extension Channel" settings (page 28, 29) in the GUI menu.

Speaker connections

❑ Speakers to connect to the speaker terminals

Speaker terminal	FRONT		CENTER	SURR.		SURR.BACK		AMP ASSIGN		FH/FW/ AMP ASSIGN-2		
	R	L		R	L	R	L	R	L	R	L	
Speaker to connect	FR	FL	C	SR	SL	SBR	SBL	FR	FL	Z2R	Z2L	
	Bi-Wiring											

❑ Power amps to connect to the pre-out terminals

Pre out terminal	FR	FL	C	SR	SL	SBR	SBL	FHR/FWR	FHL/FWL
Speaker to connect								FHR	FHL
								FWR	FWL

Audio output speakers

Speaker / Amp Assign mode	FRONT		CENTER	SURR.		SURR. BACK		FRONT HEIGHT		FRONT WIDE		ZONE2		ZONE3	
	R	L		R	L	R	L	R	L	R	L	R	L	R	L
Bi & ZONE2															
ZONE2 OFF	Bi-Wiring														
ZONE2 ON	Bi-Wiring														

Setting 9:

With this setting it is possible to switch between the following two playback modes.

- **9.1-channel playback**
- **Multi-zone playback**

- Bi-wiring connection 7.1 channel playback + ZONE3 stereo playback

Amp Assign mode: **Bi & ZONE3**

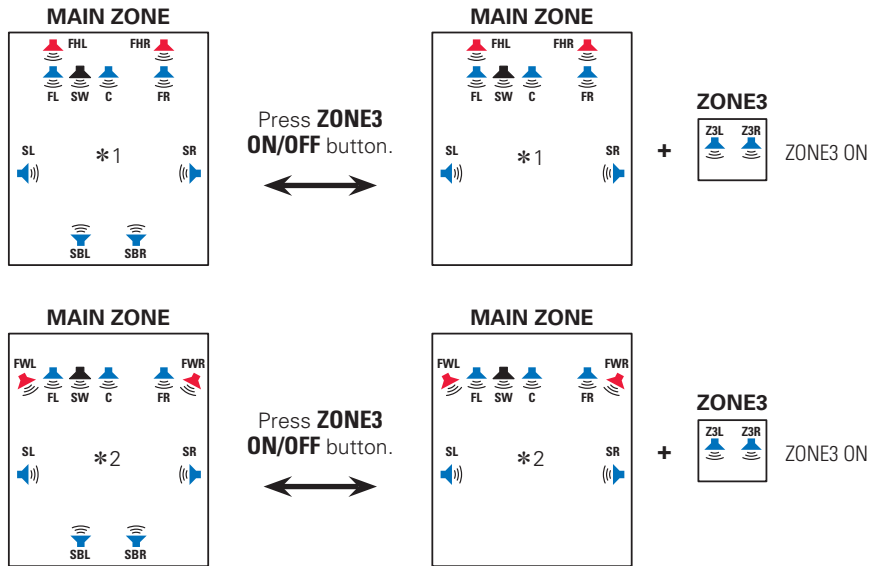

*1 : To connect front height speakers, select "Front Height" in "Manual Setup" – "Option Setup" – "Amp Assign" – "Extension Channel" settings (page 28, 29) in the GUI menu.

*2 : To connect front wide speakers, select "Front Wide" in "Manual Setup" – "Option Setup" – "Amp Assign" – "Extension Channel" settings (page 28, 29) in the GUI menu.

Speaker connections

Speakers to connect to the speaker terminals

Speaker terminal	FRONT		CENTER	SURR.		SURR.BACK		AMP ASSIGN		FH/FW/ AMP ASSIGN-2	
	R	L		R	L	R	L	R	L	R	L
Speaker to connect	FR	FL	C	SR	SL	SBR	SBL	FR	FL	Z3R	Z3L
	Bi-Wiring										

Power amps to connect to the pre-out terminals

Pre out terminal	FR	FL	C	SR	SL	SBR	SBL	FHR/FWR	FHL/FWL
Speaker to connect								FHR	FHL
								FWR	FWL

Audio output speakers

Speaker / Amp Assign mode	FRONT		CENTER	SURR.		SURR. BACK		FRONT HEIGHT		FRONT WIDE		ZONE2		ZONE3	
	R	L		R	L	R	L	R	L	R	L	R	L	R	L
Bi & ZONE3															
ZONE3 OFF	Bi-Wiring		○	○	○	○	○	○	○						
	○	○	○	○	○	○			○	○					
ZONE3 ON	○	○	○	○				○	○					○	○
	Bi-Wiring		○	○						○	○			○	○

Setting 10:

With this setting it is possible to switch between the following two playback modes.

● 9.1-channel playback

● Multi-zone playback

- 7.1-channel playback + ZONE2 monaural playback + ZONE3 monaural playback with bi-wiring connections

Amp Assign mode : **Bi & ZONE (MONO)**

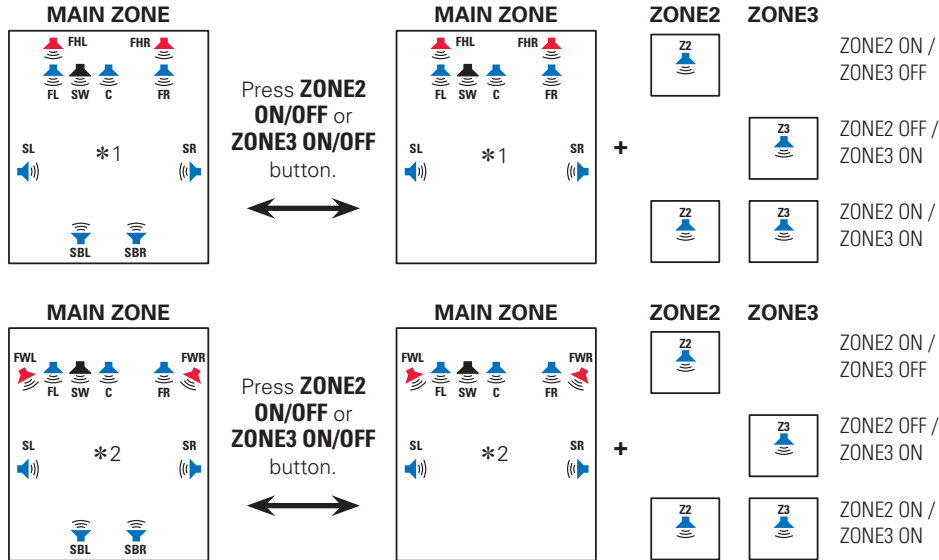

*1 : To connect front height speakers, select "Front Height" in "Manual Setup" – "Option Setup" – "Amp Assign" – "Extension Channel" settings (page 28, 29) in the GUI menu.

*2 : To connect front wide speakers, select "Front Wide" in "Manual Setup" – "Option Setup" – "Amp Assign" – "Extension Channel" settings (page 28, 29) in the GUI menu.

Speaker connections

□ Speakers to connect to the speaker terminals

Speaker terminal	FRONT		CENTER	SURR.		SURR.BACK		AMP ASSIGN		FH/FW/ AMP ASSIGN-2	
	R	L		R	L	R	L	R	L	R	L
Speaker to connect	FR	FL	C	SR	SL	SBR	SBL	FR	FL	Z3 MONO	Z2 MONO
	Bi-Wiring										

□ Power amps to connect to the pre-out terminals

Pre out terminal	FR	FL	C	SR	SL	SBR	SBL	FHR/FWR	FHL/FWL
Speaker to connect								FHR	FHL
								FWR	FWL

Audio output speakers

Amp Assign mode	Speaker		FRONT	CENTER	SURR.		SURR. BACK		FRONT HEIGHT		FRONT WIDE		ZONE2	ZONE3
	R	L			R	L	R	L	R	L	R	L		
Bi & ZONE (MONO)														
ZONE2 OFF / ZONE3 OFF	○ ○			○	○	○	○	○	○	○				
	Bi-Wiring			○	○	○	○	○			○	○		
ZONE2 ON / ZONE3 OFF	○ ○			○	○	○			○	○			○	
	Bi-Wiring			○	○	○					○	○		
ZONE2 OFF / ZONE3 ON	○ ○			○	○	○			○	○				○
	Bi-Wiring			○	○	○					○	○		○
ZONE2 ON / ZONE3 ON	○ ○			○	○	○			○	○			○	○
	Bi-Wiring			○	○	○					○	○		○

Setting 11:

- Making bi-amp connections for the FL and FR channels in the MAIN ZONE and conducting 9.1-channel playback (switching with other modes not possible)

Amp Assign mode : **Bi-Amp**

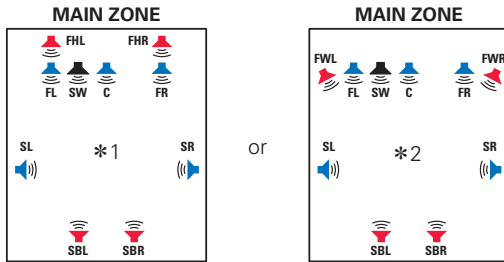

*1 : To connect front height speakers, select "Front Height" in "Manual Setup" – "Option Setup" – "Amp Assign" – "Extension Channel" settings (page 28, 29) in the GUI menu.

*2 : To connect front wide speakers, select "Front Wide" in "Manual Setup" – "Option Setup" – "Amp Assign" – "Extension Channel" settings (page 28, 29) in the GUI menu.

Speaker connections

Speakers to connect to the speaker terminals

Speaker terminal	FRONT		CENTER	SURR.		SURR.BACK		AMP ASSIGN		FH/FW/ AMP ASSIGN-2	
	R	L		R	L	R	L	R	L	R	L
Speaker to connect	FR	FL	C	SR	SL					FR	FL
	Bi-Amp										

Power amps to connect to the pre-out terminals

Pre out terminal	FR	FL	C	SR	SL	SBR	SBL	FHR/FWR	FHL/FWL
Speaker to connect						SBR	SBL	FHR	FHL
						SBR	SBL	FWR	FWL

Audio output speakers

Speaker Amp Assign mode	FRONT		CENTER	SURR.		SURR. BACK		FRONT HEIGHT		FRONT WIDE		ZONE2		ZONE3	
	R	L		R	L	R	L	R	L	R	L	R	L	R	L
Bi-Amp	○	○	○	○	○	○	○	○	○						
	○	○	○	○	○	○	○			○	○				

Setting 12:

With this setting it is possible to switch between the following two playback modes.

● 9.1-channel playback

● Switching between bi-wiring playback using speakers exclusively for 2-channel playback

Switching Surround Mode switching

Amp Assign mode : **2CH Bi-Wiring**

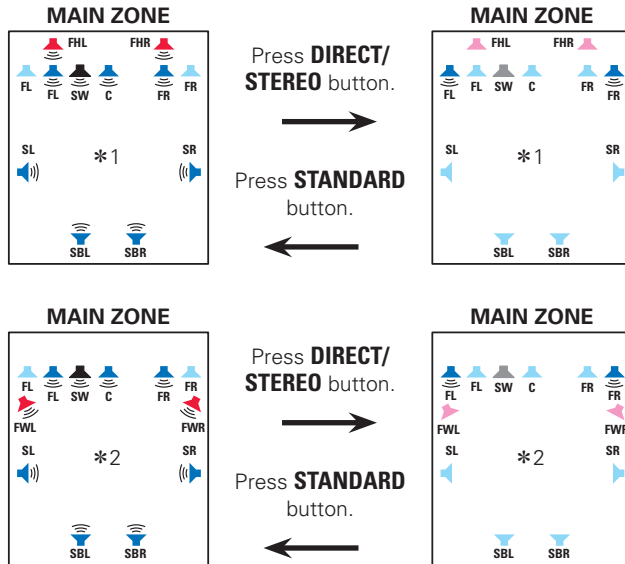

* 1 : To connect front height speakers, select "Front Height" in "Manual Setup" – "Option Setup" – "Amp Assign" – "Extension Channel" settings (page 28, 29) in the GUI menu.

* 2 : To connect front wide speakers, select "Front Wide" in "Manual Setup" – "Option Setup" – "Amp Assign" – "Extension Channel" settings (page 28, 29) in the GUI menu.

Speaker connections

□ Speakers to connect to the speaker terminals

Speaker terminal	FRONT		CENTER	SURR.		SURR.BACK		AMP ASSIGN		FH/FW/ AMP ASSIGN-2		
	R	L		R	L	R	L	R	L	R	L	
Speaker to connect	FR	FL	C	SR	SL	SBR	SBL	FR	FL	FR	FL	
									Bi-Wiring		Bi-Wiring	

□ Power amps to connect to the pre-out terminals

Pre out terminal	FR	FL	C	SR	SL	SBR	SBL	FHR/FWR	FHL/FWL
Speaker to connect								FHR	FHL
								FWR	FWL

Audio output speakers

Speaker / Amp Assign mode	FRONT		CENTER	SURR.		SURR. BACK		FRONT HEIGHT		FRONT WIDE		ZONE2		ZONE3	
	R	L		R	L	R	L	R	L	R	L	R	L	R	L
2CH Bi-Wiring															
For 2-channel playback	○	○													
	Bi-Wiring														
For multi channel playback	○	○	○	○	○	○	○	○	○	○					
	○	○	○	○	○	○	○			○	○				

Setting 13:

With this setting it is possible to switch between the following two playback modes.

● **9.1-channel playback**

● **Switching between bi-amp playback using speakers exclusively for 2-channel playback**

SwitchingSurround Mode switching

Amp Assign mode : **2ch Bi-Amp**

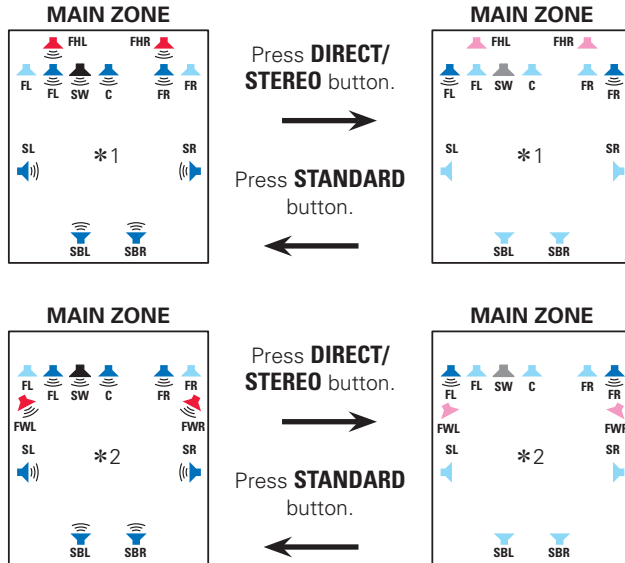

* 1 : To connect front height speakers, select "Front Height" in "Manual Setup" – "Option Setup" – "Amp Assign" – "Extension Channel" settings (page 28, 29) in the GUI menu.

* 2 : To connect front wide speakers, select "Front Wide" in "Manual Setup" – "Option Setup" – "Amp Assign" – "Extension Channel" settings (page 28, 29) in the GUI menu.

Speaker connections

❑ **Speakers to connect to the speaker terminals**

Speaker terminal	FRONT		CENTER	SURR.		SURR.BACK		AMP ASSIGN		FH/FW/ AMP ASSIGN-2	
	R	L		R	L	R	L	R	L	R	L
Speaker to connect	FR	FL	C	SR	SL	SBR	SBL	FR	FL	FR	FL
	Bi-Amp								Bi-Amp		

❑ **Power amps to connect to the pre-out terminals**

Pre out terminal	FR	FL	C	SR	SL	SBR	SBL	FHR/FWR	FHL/FWL
Speaker to connect								FHR	FHL
								FWR	FWL

Audio output speakers

Speaker / Amp Assign mode	FRONT		CENTER	SURR.		SURR. BACK		FRONT HEIGHT		FRONT WIDE		ZONE2		ZONE3	
	R	L		R	L	R	L	R	L	R	L	R	L	R	L
2ch Bi-Amp															
For 2-channel playback	○	○													
	Bi-Amp														
For multi channel playback	○	○	○	○	○	○	○	○	○	○					
	○	○	○	○	○	○	○			○	○				

Setting 14:

● 9.1 channel playback when front height speakers are connected to the speaker terminals of this unit

Amp Assign mode : **Front Height**

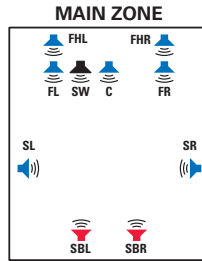

Speaker connections

Speakers to connect to the speaker terminals

Speaker terminal	FRONT		CENTER	SURR.		SURR.BACK		AMP ASSIGN		FH/FW/ AMP ASSIGN-2	
	R	L		R	L	R	L	R	L	R	L
Speaker to connect	FR	FL	C	SR	SL					FHR	FHL

Power amps to connect to the pre-out terminals

Pre out terminal	FR	FL	C	SR	SL	SBR	SBL	FHR/FWR	FHL/FWL
Speaker to connect						SBR	SBL		

Audio output speakers

Speaker / Amp Assign mode	FRONT		CENTER	SURR.		SURR. BACK		FRONT HEIGHT		FRONT WIDE		ZONE2		ZONE3	
	R	L		R	L	R	L	R	L	R	L	R	L	R	L
Front Height	○	○	○	○	○	○	○	○	○						

Setting 15:

● 9.1 channel playback when front wide speakers are connected to the speaker terminals of this unit

Amp Assign mode : **Front Wide**

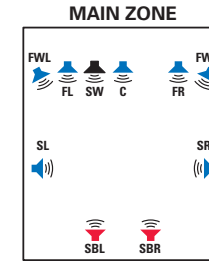

Speaker connections

Speakers to connect to the speaker terminals

Speaker terminal	FRONT		CENTER	SURR.		SURR.BACK		AMP ASSIGN		FH/FW/ AMP ASSIGN-2	
	R	L		R	L	R	L	R	L	R	L
Speaker to connect	FR	FL	C	SR	SL					FWR	FWL

Power amps to connect to the pre-out terminals

Pre out terminal	FR	FL	C	SR	SL	SBR	SBL	FHR/FWR	FHL/FWL
Speaker to connect						SBR	SBL		

Audio output speakers

Speaker / Amp Assign mode	FRONT		CENTER	SURR.		SURR. BACK		FRONT HEIGHT		FRONT WIDE		ZONE2		ZONE3	
	R	L		R	L	R	L	R	L	R	L	R	L	R	L
Front Wide	○	○	○	○	○	○	○			○	○				

Setting 16:

● Free assign

□ Amp Assign mode setting and speakers connected to the various speaker terminals

Speaker terminal Amp Assign mode	FRONT		CENTER	SURR.		SURR.BACK		AMP ASSIGN		FH/FW/ AMP ASSIGN-2	
	R	L		R	L	R	L	R	L	R	L
Free Assign	FL	FL	FL	FL	FL	FL	FL				
	FR	FR	FR	FR	FR	FR	FR				
	C	C	C	C	C	C	C				
	SL	SL	SL	SL	SL	SL	SL				
	SR	SR	SR	SR	SR	SR	SR				
	SBL	SBL	SBL	SBL	SBL	SBL	SBL				
	SBR	SBR	SBR	SBR	SBR	SBR	SBR				
	FHL*1	FHL*1	FHL*1	FHL*1	FHL*1	FHL*1	FHL*1				
	FHR*1	FHR*1	FHR*1	FHR*1	FHR*1	FHR*1	FHR*1				
	FWL*2	FWL*2	FWL*2	FWL*2	FWL*2	FWL*2	FWL*2				
	FWR*2	FWR*2	FWR*2	FWR*2	FWR*2	FWR*2	FWR*2				
	Z2L	Z2L	Z2L	Z2L	Z2L	Z2L	Z2L				
	Z2R	Z2R	Z2R	Z2R	Z2R	Z2R	Z2R				
Z3L	Z3L	Z3L	Z3L	Z3L	Z3L	Z3L					
Z3R	Z3R	Z3R	Z3R	Z3R	Z3R	Z3R					

*1 : Displayed when "Front Height" is selected in "Manual Setup" – "Option Setup" – "Amp Assign" – "Extension Channel" settings (☞ page 28, 29) in the GUI menu.

*2 : Displayed when "Front Wide" is selected in "Manual Setup" – "Option Setup" – "Amp Assign" – "Extension Channel" settings (☞ page 28, 29) in the GUI menu.

NOTE

The above is an example of the selectable channels when "Stereo" is set for the ZONE2 and ZONE3 channel setting. If "Mono" is selected, "Z2 (MONO)" and "Z3 (MONO)" are displayed.

Other Information

About Speaker Installation

This unit is compatible with Audyssey DSX™ (page 63), Dolby Pro Logic IIz (page 63) and DTS NEO:X (page 63), which offers an even wider and deeper surround sensation.

When using Audyssey DSX™, install front wide speakers or front height speakers.

When using Dolby Pro Logic IIz, install front height speakers.



Install the surround back speakers in a position 60 to 90 cm higher than ear level.

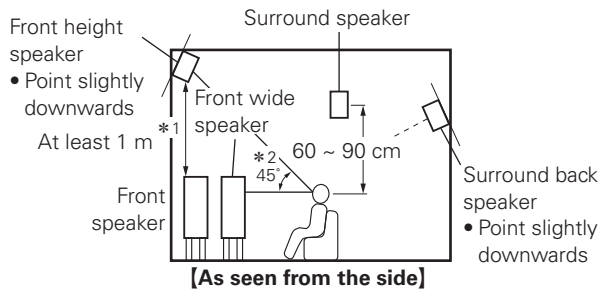

*1 : Recommended for Dolby Pro Logic IIz

*2 : Recommended for Audyssey DSX™

When surround back/front height/front wide speakers are installed

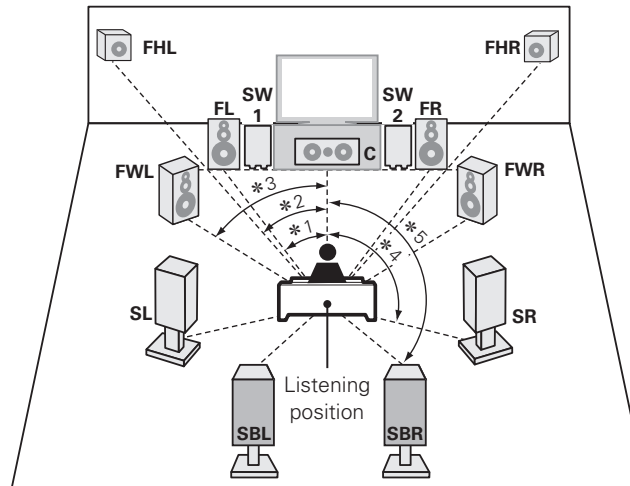

*1 22° ~ 30°

*2 22° ~ 45°

*3 55° ~ 60°

*4 90° ~ 110°

*5 135° ~ 150°

[Speaker abbreviations]

FL : Front speaker (L)

SBL : Surround back speaker (L)

FR : Front speaker (R)

SBR : Surround back speaker (R)

C : Center speaker

FHL : Front height speaker (L)

SW : Subwoofer

FHR : Front height speaker (R)

SL : Surround speaker (L)

FWL : Front wide speaker (L)

SR : Surround speaker (R)

FWR : Front wide speaker (R)

About DENON LINK 4th

DENON LINK 4th adds high-quality playback of HD audio in addition to the outstanding performance of DENON LINK 3rd, high quality audio signal transmission technology developed by DENON.

By connecting an AV amp and Blu-ray Disc player that both support DENON LINK 4th with a DENON LINK cable (supplied with the Blu-ray Disc player) and HDMI cable (sold separately), you can control the Blu-ray Disc player using the master clock signal sent from the AV amp. As D/A conversion is performed by the AV amp master clock, there are no effects of clock jitter from the HDMI transfer, enabling jitter free playback. Sound localization becomes clearer, producing the clear sense of space in the sound images that can only be achieved from HD audio.

Surround

This unit is equipped with a digital signal processing circuit that lets you play program sources in the surround mode to achieve the same sense of presence as in a movie theater.

Dolby Surround

Dolby Pro Logic IIz

This mode can be selected when a Dolby Pro Logic IIz decoder is used to play back 2-channel source in 7.1-channel surround sound with added front height channel.

By adding a front height channel, the vertical expression is emphasized, improving the three-dimensionality of the sound.



Manufactured under license from Dolby Laboratories. "Dolby," "Pro Logic" and the double-D symbol are trademarks of Dolby Laboratories.

DTS Surround

DTS NEO:X™ Surround

This matrix decoding technology uses the DTS NEO:X decoder to playback 2-channel source or 5.1/6.1/7.1 channel surround sources as a maximum of 11.1 channel surround sound.

There are 3 modes: "Music" suited for playing music, "Cinema" suited for playing movies, and "Game" which is optimized for playing games.



Manufactured under license under U.S. Patent No's: 5,956,674; 5,974,380; 5,978,762; 6,487,535; 6,226,616; 7,212,872; 7,003,467; 7,272,567; 7,668,723; 7,392,195; 7,930,184; 7,333,929; 7,548,853; 7,283,634 & other U.S. and worldwide patents issued and pending. DTS-HD, the Symbol, & DTS-HD and the Symbol together are registered trademarks & DTS-HD Master Audio is a trademark of DTS, Inc. Product includes software. ©DTS, Inc. All Rights Reserved.

Audyssey

Audyssey Dynamic EQ®

Dynamic EQ® solves the problem of deteriorating sound quality as volume is decreased by taking into account human perception and room acoustics. Audyssey Dynamic EQ® works in tandem with Audyssey MultEQ® XT 32 to provide well-balanced sound for every listener at any volume level.

Audyssey Dynamic Volume®

Dynamic Volume® solves the problem of large variations in volume level between television programs, commercials, and between the soft and loud passages of movies. Audyssey Dynamic EQ® is integrated into Dynamic Volume® so that as the playback volume is adjusted automatically, the perceived bass response, tonal balance, surround impression, and dialog clarity remain the same.

Audyssey MultEQ® XT 32

MultEQ® XT 32 is a room equalization solution that calibrates any audio system so that it can achieve optimum performance for every listener in a large listening area. Based on several room measurements, MultEQ® XT 32 calculates an equalization solution that corrects for both time and frequency response problems in the listening area and also performs a fully automated surround system setup.

Audyssey Dynamic Surround Expansion™ (Audyssey DSX™)

Audyssey DSX™ is a scalable system that adds new speakers to improve surround impression. Audyssey DSX™ first adds Wide Channels for the biggest impact on envelopment and then creates Height channels to reproduce the next most important acoustical and perceptual cues. Surround Envelopment Processing is used to enhance the blend between the front and surround channels.



Manufactured under license from Audyssey Laboratories™. U.S. and foreign patents pending. Audyssey MultEQ® XT 32 is a registered trademark of Audyssey Laboratories. Audyssey Dynamic EQ® is a registered trademark of Audyssey Laboratories. Audyssey Dynamic Volume® is a registered trademark of Audyssey Laboratories. Audyssey DSX™ is a trademark of Audyssey Laboratories.

For more information, visit www.audyssey.com.

Surround Modes and Parameters

Surround mode	Signals and adjustability in the different modes															
	Channel output							Parameters (default values are shown in parentheses)								
	Front L/R	Center	Surround L/R	Surround back L/R	Front height L/R	Front wide L/R	Subwoofer	D. COMP *1	DRC *2	LFE *3	AFDM *4	SB CH Out	Cinema EQ.	Mode	Decoder	Room Size
PURE DIRECT, DIRECT (2ch)	<input type="radio"/>						<input checked="" type="radio"/>	<input type="radio"/> (OFF)	<input type="radio"/> (Auto)							
PURE DIRECT, DIRECT (5.1ch)	<input type="radio"/>	<input checked="" type="radio"/>	<input checked="" type="radio"/>	<input checked="" type="radio"/>	<input checked="" type="radio"/>	<input checked="" type="radio"/>	<input checked="" type="radio"/>	<input type="radio"/> (OFF)	<input type="radio"/> (Auto)	<input type="radio"/> (0dB)						
DSD DIRECT	<input type="radio"/>															
DSD MULTI DIRECT	<input type="radio"/>	<input checked="" type="radio"/>	<input checked="" type="radio"/>				<input checked="" type="radio"/>			<input type="radio"/> (0dB)						
MULTI CH DIRECT	<input type="radio"/>	<input checked="" type="radio"/>	<input checked="" type="radio"/>	<input checked="" type="radio"/>	<input checked="" type="radio"/>	<input checked="" type="radio"/>	<input checked="" type="radio"/>	<input type="radio"/> (OFF)	<input type="radio"/> (Auto)	<input type="radio"/> (0dB)						
STEREO	<input type="radio"/>						<input checked="" type="radio"/>	<input type="radio"/> (OFF)	<input type="radio"/> (Auto)	<input type="radio"/> (0dB)						
EXT. IN	<input type="radio"/>	<input checked="" type="radio"/>	<input checked="" type="radio"/>	<input checked="" type="radio"/>			<input checked="" type="radio"/>									
MULTI CH IN	<input type="radio"/>	<input checked="" type="radio"/>	<input checked="" type="radio"/>	<input checked="" type="radio"/>	<input checked="" type="radio"/>	<input checked="" type="radio"/>	<input checked="" type="radio"/>			<input type="radio"/> (0dB)		<input type="radio"/>	<input type="radio"/> (NOTE3)	<input type="radio"/> (NOTE4)		
WIDE SCREEN	<input type="radio"/>	<input checked="" type="radio"/>	<input checked="" type="radio"/>	<input checked="" type="radio"/>	<input checked="" type="radio"/>	<input checked="" type="radio"/>	<input checked="" type="radio"/>	<input type="radio"/> (OFF)	<input type="radio"/> (Auto)	<input type="radio"/> (0dB)			<input type="radio"/> (OFF)			
HOME THX CINEMA (2ch)	<input type="radio"/>	<input checked="" type="radio"/>	<input checked="" type="radio"/>	<input checked="" type="radio"/>	<input checked="" type="radio"/>	<input checked="" type="radio"/>	<input checked="" type="radio"/>							<input type="radio"/> (PLIIx CINEMA)	<input type="radio"/>	
HOME THX CINEMA (5.1ch)	<input type="radio"/>	<input checked="" type="radio"/>	<input checked="" type="radio"/>	<input checked="" type="radio"/>	<input checked="" type="radio"/>	<input checked="" type="radio"/>	<input checked="" type="radio"/>			<input type="radio"/> (0dB)	<input type="radio"/> (ON)				<input type="radio"/>	
DOLBY PRO LOGIC IIx	<input type="radio"/>	<input checked="" type="radio"/>	<input checked="" type="radio"/>	<input checked="" type="radio"/>			<input checked="" type="radio"/>	<input type="radio"/> (OFF)	<input type="radio"/> (Auto)			<input type="radio"/>	<input type="radio"/> (NOTE1)	<input type="radio"/> (Cinema)		
DOLBY PRO LOGIC II	<input type="radio"/>	<input checked="" type="radio"/>	<input checked="" type="radio"/>	<input checked="" type="radio"/>			<input checked="" type="radio"/>	<input type="radio"/> (OFF)	<input type="radio"/> (Auto)			<input type="radio"/>	<input type="radio"/> (NOTE2)	<input type="radio"/> (Cinema)		
DOLBY PRO LOGIC IIz	<input type="radio"/>	<input checked="" type="radio"/>	<input checked="" type="radio"/>	<input checked="" type="radio"/>	<input checked="" type="radio"/>	<input checked="" type="radio"/>	<input checked="" type="radio"/>	<input type="radio"/> (OFF)	<input type="radio"/> (Auto)				<input type="radio"/>			
DTS NEO:X	<input type="radio"/>	<input checked="" type="radio"/>	<input checked="" type="radio"/>	<input checked="" type="radio"/>	<input checked="" type="radio"/>	<input checked="" type="radio"/>	<input checked="" type="radio"/>	<input type="radio"/> (OFF)	<input type="radio"/> (Auto)				<input type="radio"/> (NOTE1)	<input type="radio"/>		
DOLBY DIGITAL	<input type="radio"/>	<input checked="" type="radio"/>	<input checked="" type="radio"/>	<input checked="" type="radio"/>	<input checked="" type="radio"/>	<input checked="" type="radio"/>	<input checked="" type="radio"/>	<input type="radio"/> (OFF)		<input type="radio"/> (0dB)	<input type="radio"/> (ON)	<input type="radio"/>	<input type="radio"/> (NOTE3)	<input type="radio"/> (NOTE4)		
DOLBY DIGITAL Plus	<input type="radio"/>	<input checked="" type="radio"/>	<input checked="" type="radio"/>	<input checked="" type="radio"/>	<input checked="" type="radio"/>	<input checked="" type="radio"/>	<input checked="" type="radio"/>	<input type="radio"/> (OFF)		<input type="radio"/> (0dB)	<input type="radio"/> (ON)	<input type="radio"/>	<input type="radio"/> (NOTE3)	<input type="radio"/> (NOTE4)		
DOLBY TrueHD	<input type="radio"/>	<input checked="" type="radio"/>	<input checked="" type="radio"/>	<input checked="" type="radio"/>	<input checked="" type="radio"/>	<input checked="" type="radio"/>	<input checked="" type="radio"/>		<input type="radio"/> (Auto)	<input type="radio"/> (0dB)	<input type="radio"/> (ON)	<input type="radio"/>	<input type="radio"/> (NOTE3)	<input type="radio"/> (NOTE4)		
DTS SURROUND	<input type="radio"/>	<input checked="" type="radio"/>	<input checked="" type="radio"/>	<input checked="" type="radio"/>	<input checked="" type="radio"/>	<input checked="" type="radio"/>	<input checked="" type="radio"/>	<input type="radio"/> (OFF)		<input type="radio"/> (0dB)		<input type="radio"/>	<input type="radio"/> (NOTE3)	<input type="radio"/> (NOTE4)		
DTS 96/24	<input type="radio"/>	<input checked="" type="radio"/>	<input checked="" type="radio"/>	<input checked="" type="radio"/>	<input checked="" type="radio"/>	<input checked="" type="radio"/>	<input checked="" type="radio"/>	<input type="radio"/> (OFF)		<input type="radio"/> (0dB)		<input type="radio"/>	<input type="radio"/> (NOTE3)	<input type="radio"/> (NOTE4)		
DTS-HD	<input type="radio"/>	<input checked="" type="radio"/>	<input checked="" type="radio"/>	<input checked="" type="radio"/>	<input checked="" type="radio"/>	<input checked="" type="radio"/>	<input checked="" type="radio"/>	<input type="radio"/> (OFF)		<input type="radio"/> (0dB)		<input type="radio"/>	<input type="radio"/> (NOTE3)	<input type="radio"/> (NOTE4)		
7CH STEREO	<input type="radio"/>	<input checked="" type="radio"/>	<input checked="" type="radio"/>	<input checked="" type="radio"/>	<input checked="" type="radio"/>	<input checked="" type="radio"/>	<input checked="" type="radio"/>	<input type="radio"/> (OFF)	<input type="radio"/> (Auto)	<input type="radio"/> (0dB)						<input type="radio"/> (Medium)
SUPER STADIUM	<input type="radio"/>	<input checked="" type="radio"/>	<input checked="" type="radio"/>	<input checked="" type="radio"/>	<input checked="" type="radio"/>	<input checked="" type="radio"/>	<input checked="" type="radio"/>	<input type="radio"/> (OFF)	<input type="radio"/> (Auto)	<input type="radio"/> (0dB)						<input type="radio"/> (Medium)
ROCK ARENA	<input type="radio"/>	<input checked="" type="radio"/>	<input checked="" type="radio"/>	<input checked="" type="radio"/>	<input checked="" type="radio"/>	<input checked="" type="radio"/>	<input checked="" type="radio"/>	<input type="radio"/> (OFF)	<input type="radio"/> (Auto)	<input type="radio"/> (0dB)						<input type="radio"/> (Medium)
JAZZ CLUB	<input type="radio"/>	<input checked="" type="radio"/>	<input checked="" type="radio"/>	<input checked="" type="radio"/>	<input checked="" type="radio"/>	<input checked="" type="radio"/>	<input checked="" type="radio"/>	<input type="radio"/> (OFF)	<input type="radio"/> (Auto)	<input type="radio"/> (0dB)						<input type="radio"/> (Medium)
CLASSIC CONCERT	<input type="radio"/>	<input checked="" type="radio"/>	<input checked="" type="radio"/>	<input checked="" type="radio"/>	<input checked="" type="radio"/>	<input checked="" type="radio"/>	<input checked="" type="radio"/>	<input type="radio"/> (OFF)	<input type="radio"/> (Auto)	<input type="radio"/> (0dB)						<input type="radio"/> (Medium)
MONO MOVIE	<input type="radio"/>	<input checked="" type="radio"/>	<input checked="" type="radio"/>	<input checked="" type="radio"/>	<input checked="" type="radio"/>	<input checked="" type="radio"/>	<input checked="" type="radio"/>	<input type="radio"/> (OFF)	<input type="radio"/> (Auto)	<input type="radio"/> (0dB)						<input type="radio"/> (Medium)
VIDEO GAME	<input type="radio"/>	<input checked="" type="radio"/>	<input checked="" type="radio"/>	<input checked="" type="radio"/>	<input checked="" type="radio"/>	<input checked="" type="radio"/>	<input checked="" type="radio"/>	<input type="radio"/> (OFF)	<input type="radio"/> (Auto)	<input type="radio"/> (0dB)						<input type="radio"/> (Medium)
MATRIX	<input type="radio"/>	<input checked="" type="radio"/>	<input checked="" type="radio"/>	<input checked="" type="radio"/>	<input checked="" type="radio"/>	<input checked="" type="radio"/>	<input checked="" type="radio"/>	<input type="radio"/> (OFF)	<input type="radio"/> (Auto)	<input type="radio"/> (0dB)						<input type="radio"/> (Medium)
DOLBY HEADPHONE	<input type="radio"/>							<input type="radio"/> (OFF)	<input type="radio"/> (Auto)	<input type="radio"/> (0dB)					<input type="radio"/>	

○ : Signal / Adjustable

⊙ : Turned on or off by speaker configuration setting

*1 : When playing Dolby Digital and DTS signals.

*2 : When playing Dolby TrueHD signal.

*3 : When playing Dolby Digital, DTS, DVD-Audio and Super Audio CD.

*4 : When playing Dolby Digital signals.

NOTE1 : This parameter is available when the GUI menu "Parameters" - "Audio" - "Surround Parameters" - "Mode" is set to "Cinema" (page 38).

NOTE2 : This parameter is available when the GUI menu "Parameters" - "Audio" - "Surround Parameters" - "Mode" is set to "Cinema" or "Pro Logic" (page 38).

NOTE3 : This parameter can be used when the "Parameters" - "Audio" - "Surround Parameters" - "SB CH Out" setting of GUI menu is set to "OFF", "ON", "MTRX ON" or "PLIIx CINEMA", or when a DTS NEO:X decoder is used and the "Mode" setting is "Cinema" (page 38, 39).

NOTE4 : This can be set when a DTS NEO:X decoder (+NEO:X) is used.

Surround Mode	Signals and adjustability in the different modes													
	Parameters (default values are shown in parentheses)													
	Effect Level	Delay Time	Subwoofer	PRO LOGIC II/IIx MUSIC mode only			Height Gain	DTS NEO:X	EXT. IN mode only	Tone	MultEQ® XT 32	Dynamic EQ® *5	Dynamic Volume® *6	RESTORER *7
Panorama				Dimension	Center Width	Center Gain		Subwoofer Att.						
PURE DIRECT, DIRECT (2ch)			<input type="radio"/>							<input type="radio"/> (NOTE7)	<input type="radio"/> (NOTE7)	<input type="radio"/> (NOTE7)		
PURE DIRECT, DIRECT (5.1ch)			<input type="radio"/>							<input type="radio"/> (NOTE7)	<input type="radio"/> (NOTE7)	<input type="radio"/> (NOTE7)		
DSD DIRECT			<input type="radio"/>											
DSD MULTI DIRECT														
MULTI CH DIRECT										<input type="radio"/> (NOTE7)	<input type="radio"/> (NOTE7)	<input type="radio"/> (NOTE7)		
STEREO									<input type="radio"/> (0dB)	<input type="radio"/> (OFF)	<input type="radio"/> (OFF)	<input type="radio"/> (OFF)	<input type="radio"/>	
EXT. IN													<input type="radio"/>	
MULTI CH IN						<input type="radio"/> (NOTE5)			<input type="radio"/> (0dB)	<input type="radio"/> (OFF)	<input type="radio"/> (OFF)	<input type="radio"/> (OFF)	<input type="radio"/>	
WIDE SCREEN	<input type="radio"/> (ON, 10)								<input type="radio"/> (0dB)	<input type="radio"/> (OFF)	<input type="radio"/> (OFF)	<input type="radio"/> (OFF)	<input type="radio"/>	
HOME THX CINEMA (2ch)									<input type="radio"/> (0dB)	<input type="radio"/> (OFF)	<input type="radio"/> (OFF)	<input type="radio"/> (OFF)	<input type="radio"/>	
HOME THX CINEMA (5.1ch)									<input type="radio"/> (0dB)	<input type="radio"/> (OFF)	<input type="radio"/> (OFF)	<input type="radio"/> (OFF)	<input type="radio"/>	
DOLBY PRO LOGIC IIx				<input type="radio"/> (OFF)	<input type="radio"/> (3)	<input type="radio"/> (3)			<input type="radio"/> (0dB)	<input type="radio"/> (OFF)	<input type="radio"/> (OFF)	<input type="radio"/> (OFF)	<input type="radio"/>	
DOLBY PRO LOGIC II				<input type="radio"/> (OFF)	<input type="radio"/> (3)	<input type="radio"/> (3)			<input type="radio"/> (0dB)	<input type="radio"/> (OFF)	<input type="radio"/> (OFF)	<input type="radio"/> (OFF)	<input type="radio"/>	
DOLBY PRO LOGIC IIz							<input type="radio"/> (Medium)		<input type="radio"/> (0dB)	<input type="radio"/> (OFF)	<input type="radio"/> (OFF)	<input type="radio"/> (OFF)	<input type="radio"/>	
DTS NEO:X								<input type="radio"/> (NOTE6)	<input type="radio"/> (0dB)	<input type="radio"/> (OFF)	<input type="radio"/> (OFF)	<input type="radio"/> (OFF)	<input type="radio"/>	
DOLBY DIGITAL							<input type="radio"/> (NOTE5)		<input type="radio"/> (0dB)	<input type="radio"/> (OFF)	<input type="radio"/> (OFF)	<input type="radio"/> (OFF)		
DOLBY DIGITAL Plus							<input type="radio"/> (NOTE5)		<input type="radio"/> (0dB)	<input type="radio"/> (OFF)	<input type="radio"/> (OFF)	<input type="radio"/> (OFF)		
DOLBY TrueHD							<input type="radio"/> (NOTE5)		<input type="radio"/> (0dB)	<input type="radio"/> (OFF)	<input type="radio"/> (OFF)	<input type="radio"/> (OFF)		
DTS SURROUND							<input type="radio"/> (NOTE5)		<input type="radio"/> (0dB)	<input type="radio"/> (OFF)	<input type="radio"/> (OFF)	<input type="radio"/> (OFF)		
DTS 96/24							<input type="radio"/> (NOTE5)		<input type="radio"/> (0dB)	<input type="radio"/> (OFF)	<input type="radio"/> (OFF)	<input type="radio"/> (OFF)		
DTS-HD							<input type="radio"/> (NOTE5)		<input type="radio"/> (0dB)	<input type="radio"/> (OFF)	<input type="radio"/> (OFF)	<input type="radio"/> (OFF)		
7CH STEREO	<input type="radio"/> (10)								<input type="radio"/> (0dB)	<input type="radio"/> (OFF)	<input type="radio"/> (OFF)	<input type="radio"/> (OFF)	<input type="radio"/>	
SUPER STADIUM	<input type="radio"/> (10)								<input type="radio"/> (NOTE8)	<input type="radio"/> (OFF)	<input type="radio"/> (OFF)	<input type="radio"/> (OFF)	<input type="radio"/>	
ROCK ARENA	<input type="radio"/> (10)								<input type="radio"/> (NOTE9)	<input type="radio"/> (OFF)	<input type="radio"/> (OFF)	<input type="radio"/> (OFF)	<input type="radio"/>	
JAZZ CLUB	<input type="radio"/> (10)								<input type="radio"/> (0dB)	<input type="radio"/> (OFF)	<input type="radio"/> (OFF)	<input type="radio"/> (OFF)	<input type="radio"/>	
CLASSIC CONCERT	<input type="radio"/> (10)								<input type="radio"/> (0dB)	<input type="radio"/> (OFF)	<input type="radio"/> (OFF)	<input type="radio"/> (OFF)	<input type="radio"/>	
MONO MOVIE	<input type="radio"/> (10)								<input type="radio"/> (0dB)	<input type="radio"/> (OFF)	<input type="radio"/> (OFF)	<input type="radio"/> (OFF)	<input type="radio"/>	
VIDEO GAME	<input type="radio"/> (10)								<input type="radio"/> (0dB)	<input type="radio"/> (OFF)	<input type="radio"/> (OFF)	<input type="radio"/> (OFF)	<input type="radio"/>	
MATRIX	<input type="radio"/> (10)								<input type="radio"/> (0dB)	<input type="radio"/> (OFF)	<input type="radio"/> (OFF)	<input type="radio"/> (OFF)	<input type="radio"/>	
DOLBY HEADPHONE										<input type="radio"/> (OFF)	<input type="radio"/> (OFF)	<input type="radio"/> (OFF)	<input type="radio"/>	

: Signal / Adjustable

*5 : This item cannot be set when the GUI menu "Parameters" – "Audio" – "Audyssey Settings" – "MultEQ® XT 32" is set to "OFF" (page 41).

*6 : This item cannot be set when the GUI menu "Parameters" – "Audio" – "Audyssey Settings" – "Dynamic EQ®" is set to "OFF" (page 41).

*7 : This item can be set when the input signal is analog, PCM 48 kHz or 44.1 kHz.

NOTE5 : This can be set when a PLIIz decoder (+PLIIz) is used.

NOTE6 : Default value for "DTS NEO:X Cinema" or "DTS NEO:X Game" : 1.0
Default value for "DTS NEO:X Music" : 0.3

NOTE7 : This parameter is available when the GUI menu "Auto Setup" – "Option" – "Direct Mode" is set to "ON" (page 22).

NOTE8 : In this mode, the "Tone Defeat" setting is "OFF", Bass is +6 dB, and Treble is 0 dB. (Default)

NOTE9 : In this mode, the "Tone Defeat" setting is "OFF", Bass is +6 dB, and Treble is +4 dB. (Default)

Differences in Surround Mode Names Depending on the Input Signals

Button	Surround mode	Note	Input signals																
			ANALOG	PCM		DTS-HD		DTS			DOLBY		DOLBY DIGITAL				Super Audio CD		
				PCM (multi ch)	PCM (2ch)	DTS-HD Master Audio	DTS-HD High Resolution Audio	DTS ES DSCRT (With Flag)	DTS ES MTRX (With Flag) *8	DTS (5.1ch)	DTS 96/24	DOLBY TrueHD	DOLBY DIGITAL Plus	DOLBY DIGITAL EX (With Flag)	DOLBY DIGITAL EX (With no Flag)	DOLBY DIGITAL (5.1/5/4/3ch)	DOLBY DIGITAL (2ch)	DSD (multi ch)	DSD (2ch)
HOME THX CINEMA																			
	ES DSCRT6.1 + THX	*1						○											
	ES MTRX6.1 + THX	*2							△										
	THX SURROUND EX	*1		○								○	○	◎	○	○		○	
	THX Ultra2 Cinema	*3		○		○	○		▲	○	○	○	○	○	○	○		○	
	THX Music Mode	*3		○		○	○		▲	○	○	○	○	○	○	○		○	
	THX Games Mode	*3	○	○	○	○	○		▲	○	○	○	○	○	○	○	○	○	○
	THX Cinema			○		○	○	○	▲	○	○	○	○	○	○	○		○	
	PLIIx C + THX	*4	○	○	○	○	○		▲	○	○	○	○	○	○	○	○	○	○
	PLII C + THX		○		○												○		○
	DOLBY PL + THX		○		○												○		○
	PLIIz + THX	*5	○	○	○	○	○	○	▲	○	○	○	○	○	○	○	○	○	○
STANDARD																			
DTS SURROUND																			
	DTS-HD MSTR					●													
	DTS-HD HI RES						●												
	DTS ES DSCRT6.1	*1						●											
	DTS ES MTRX6.1	*2							△ ●										
	DTS SURROUND							○	▲ ●	●									
	DTS 96/24										●								
	DTS (-HD) + PLIIx CINEMA	*3				○	○		▲	○	○								
	DTS (-HD) + PLIIx MUSIC	*1				○	○		▲	○	○								
	DTS (-HD) + PLIIz	*5				○	○	○	▲	○	○								
	DTS(-HD) + NEO:X CINEMA	*6				○	○	○	▲	○	○								
	DTS(-HD) + NEO:X MUSIC	*6				○	○	○	▲	○	○								
	DTS(-HD) + NEO:X GAME	*6				○	○	○	▲	○	○								
	DTS NEO:X CINEMA	*7	○		○												○		
	DTS NEO:X MUSIC	*7	○		○												○		
	DTS NEO:X GAME	*7	○		○												○		
	Audyssey DSX™					○	○	○	▲	○	○								

- : Mode selectable in initial status
- : Selectable mode

- *1 : This mode is not available when the surround back speaker setup is set to "None" (page 23).
- *2 : This cannot be selected when the "Speaker Configuration" settings are set to anything other than "Front", "Center", "Surround" and "Surround Back (1spkr)".
- *3 : This mode is not available when the surround back speaker setup is set to "1spkr" or "None" (page 23).
- *4 : For input signals other than 2 channel signals, this mode cannot be selected when surround back speaker is set to "1spkr" or "None" (page 23).
- *5 : This mode is not available when the front height speaker setup is set to "None" (page 23).
- *6 : When the surround back speaker, front height speaker and front wide speaker are all set to "None", this cannot be selected (page 23).
- *7 : This cannot be selected for 2-channel playback when only front speakers are used.
- *8 : When using DTS ES MTRX signal input, only △ can be selected when the "Speaker Configuration" settings are set to "Front", "Center", "Surround" and "Surround Back (1spkr)" (page 23). Also, only ▲ can be selected when the "Speaker Configuration" setting is "Surround Back (2spkrs)", "Front Height" and "Front Wide" (page 23).

Button	Surround mode	Note	Input signals																
			ANALOG	PCM		DTS-HD		DTS				DOLBY		DOLBY DIGITAL				Super Audio CD	
				PCM (multi ch)	PCM (2ch)	DTS-HD Master Audio	DTS-HD High Resolution Audio	DTS ES DSCRT (With Flag)	DTS ES MTRX (With Flag)	DTS (5.1ch)	DTS 96/24	DOLBY TrueHD	DOLBY DIGITAL Plus	DOLBY DIGITAL EX (With Flag)	DOLBY DIGITAL EX (With no Flag)	DOLBY DIGITAL (5.1/5/4/3ch)	DOLBY DIGITAL (2ch)	DSD (multi ch)	DSD (2ch)
STANDARD																			
DOLBY SURROUND																			
	DOLBY TrueHD											●							
	DOLBY DIGITAL+											●							
	DOLBY DIGITAL												○	●	●				
	DOLBY DIGITAL EX	*1											○	○	○				
	DOLBY (D+) (HD) +EX	*1										○	○						
	DOLBY (D) (D+) (HD) +PLIIx CINEMA	*3										○	○	◎	●	○	○		
	DOLBY (D) (D+) (HD) +PLIIx MUSIC	*1										○	○	○	○	○			
	DOLBY (D) (D+) (HD) +PLIIz	*5										○	○	○	○	○			
	DOLBY (D) (D+) (HD) + NEO:X CINEMA	*6										○	○	○	○	○			
	DOLBY (D) (D+) (HD) + NEO:X MUSIC	*6										○	○	○	○	○			
	DOLBY (D) (D+) (HD) + NEO:X GAME	*6										○	○	○	○	○			
	DOLBY PRO LOGIC IIx CINEMA	*1 *7	○	○													●		○
	DOLBY PRO LOGIC IIx MUSIC	*1 *7	○	○													○		○
	DOLBY PRO LOGIC IIx GAME	*1 *7	○	○													○		○
	DOLBY PRO LOGIC II CINEMA	*7	○	○													○		○
	DOLBY PRO LOGIC II MUSIC	*7	○	○													○		○
	DOLBY PRO LOGIC II GAME	*7	○	○													○		○
	DOLBY PRO LOGIC	*7	○	○													○		○
	DOLBY PRO LOGIC IIz HEIGHT	*5	○	○													○		○
	Audyssey DSX™	*9										○	○	○	○	○			
	DOLBY PRO LOGICIIx CINEMA A-DSX	*1 *7 *9	○	○													○		○
	DOLBY PRO LOGICIIx MUSIC A-DSX	*1 *7 *9	○	○													○		○
	DOLBY PRO LOGICIIx GAME A-DSX	*1 *7 *9	○	○													○		○
	DOLBY PRO LOGICII CINEMA A-DSX	*7 *9	○	○													○		○
	DOLBY PRO LOGICII MUSIC A-DSX	*7 *9	○	○													○		○
	DOLBY PRO LOGICII GAME A-DSX	*7 *9	○	○													○		○
	DOLBY PRO LOGIC A-DSX	*7 *9	○	○													○		○
	DOLBY HEADPHONE	*10	○	○	○	○	○	○	○	○	○	○	○	○	○	○	○	○	○

● : Mode selectable in initial status

◎ : Mode fixed when "AFDM" is "ON"

○ : Selectable mode

*1 : This mode is not available when the surround back speaker setup is set to "None" (page 23).

*3 : This mode is not available when the surround back speaker setup is set to "1spkr" or "None" (page 23).

*5 : This mode is not available when the front height speaker setup is set to "None" (page 23).

*6 : When the surround back speaker, front height speaker and front wide speaker are all set to "None", this cannot be selected (page 23).

*7 : This cannot be selected for 2-channel playback when only front speakers are used.

*9 : This mode is not available when the front height speaker and front wide speaker setup is set to "None" (page 23).

*10 : You can select this when the headphone plug is inserted into the headphone jack.

Button	Surround mode	Note	Input signals																
			ANALOG	PCM		DTS-HD		DTS				DOLBY		DOLBY DIGITAL				Super Audio CD	
				PCM (multi ch)	PCM (2ch)	DTS-HD Master Audio	DTS-HD High Resolution Audio	DTS ES DSCRT (With Flag)	DTS ES MTRX (With Flag)	DTS (5.1ch)	DTS 96/24	DOLBY TrueHD	DOLBY DIGITAL Plus	DOLBY DIGITAL EX (With Flag)	DOLBY DIGITAL EX (With no Flag)	DOLBY DIGITAL (5.1/5/4/3ch)	DOLBY DIGITAL (2ch)	DSD (multi ch)	DSD (2ch)
STANDARD																			
MULTI CH IN																			
MULTI CH IN				●															●
MULTI CH IN 7.1			*1	●															
MULTI IN + PLIIx CINEMA			*3	○															○
MULTI IN + PLIIx MUSIC			*1	○															○
MULTI IN + DOLBY EX			*1	○															○
MULTI IN + PLIIz			*5	○															○
MULTI IN + NEO:X CINEMA			*6	○															
MULTI IN + NEO:X MUSIC			*6	○															
MULTI IN + NEO:X GAME			*6	○															
Audyssey DSX™			*9	○															○
DIRECT																			
DIRECT				○		○		○	○	○	○	○	○	○	○	○			
DSD DIRECT																			○
DSD MULTI DIRECT																			○
MULTI CH DIRECT				○															
PURE DIRECT																			
PURE DIRECT				○		○		○	○	○	○	○	○	○	○	○			
DSD PURE DIRECT																			○
DSD MULTI PURE																			○
MULTI CH PURE DIRECT				○															
DSP SIMULATION																			
7CH STEREO			*11	○	○	○	○	○	○	○	○	○	○	○	○	○	○	○	○
WIDE SCREEN				○	○	○	○	○	○	○	○	○	○	○	○	○	○	○	○
SUPER STADIUM				○	○	○	○	○	○	○	○	○	○	○	○	○	○	○	○
ROCK ARENA				○	○	○	○	○	○	○	○	○	○	○	○	○	○	○	○
JAZZ CLUB				○	○	○	○	○	○	○	○	○	○	○	○	○	○	○	○
CLASSIC CONCERT				○	○	○	○	○	○	○	○	○	○	○	○	○	○	○	○
MONO MOVIE				○	○	○	○	○	○	○	○	○	○	○	○	○	○	○	○
VIDEO GAME				○	○	○	○	○	○	○	○	○	○	○	○	○	○	○	○
MATRIX				○	○	○	○	○	○	○	○	○	○	○	○	○	○	○	○
STEREO																			
STEREO				●	○	●	○	○	○	○	○	○	○	○	○	○	○	○	○

● : Mode selectable in initial status
○ : Selectable mode

- *1 : This mode is not available when the surround back speaker setup is set to "None" (page 23).
- *3 : This mode is not available when the surround back speaker setup is set to "1spkr" or "None" (page 23).
- *5 : This mode is not available when the front height speaker setup is set to "None" (page 23).
- *6 : When the surround back speaker, front height speaker and front wide speaker are all set to "None", this cannot be selected (page 23).
- *9 : This mode is not available when the front height speaker and front wide speaker setup is set to "None" (page 23).
- *11 : If the surround back speaker, front height speaker and front wide speaker setup is set to "None" and when using headphones, then "5CH STEREO" is displayed. When surround back speakers and front height speakers, or surround back speakers and front wide speakers are used, "9CH STEREO" is displayed.

Relationship Between Amp Assign Setting and Speaker Output

STEREO or DIRECT (2ch) Mode

Setting	Status	Speaker terminal			
	Surround mode	SURR.	SURR. BACK	AMP ASSIGN	FH/FW/AMP ASSIGN-2
2CH Bi-Wiring	STEREO/DIRECT	–	–	FL/FR	FL/FR
	Other	SL/SR	SBL/SBR	–	–
2CH Bi-Amp	STEREO/DIRECT	–	–	FL/FR	FL/FR
	Other	SL/SR	SBL/SBR	–	–

Multi-Zone Power On/Off

Setting	Status		Speaker terminal			
	ZONE2	ZONE3	SURR.	SURR. BACK	AMP ASSIGN	FH/FW/AMP ASSIGN-2
ZONE2	ON	ON	SL/SR	–	–	Z2 L/R
		OFF	SL/SR	–	–	Z2 L/R
	OFF	ON	SL/SR	SBL/SBR	–	–
		OFF	SL/SR	SBL/SBR	–	–
ZONE3	ON	ON	SL/SR	–	–	Z3 L/R
		OFF	SL/SR	SBL/SBR	–	–
	OFF	ON	SL/SR	–	–	Z3 L/R
		OFF	SL/SR	SBL/SBR	–	–
ZONE (MONO)	ON	ON	SL/SR	–	–	Z2/Z3
		OFF	SL/SR	–	–	Z2
	OFF	ON	SL/SR	–	–	Z3
		OFF	SL/SR	SBL/SBR	–	–
Bi & ZONE2	ON	ON	SL/SR	–	FL/FR	Z2 L/R
		OFF	SL/SR	–	FL/FR	Z2 L/R
	OFF	ON	SL/SR	SBL/SBR	FL/FR	–
		OFF	SL/SR	SBL/SBR	FL/FR	–
Bi & ZONE3	ON	ON	SL/SR	–	FL/FR	Z3 L/R
		OFF	SL/SR	SBL/SBR	FL/FR	–
	OFF	ON	SL/SR	–	FL/FR	Z3 L/R
		OFF	SL/SR	SBL/SBR	FL/FR	–
Bi & ZONE (MONO)	ON	ON	SL/SR	–	FL/FR	Z2/Z3
		OFF	SL/SR	–	FL/FR	Z2
	OFF	ON	SL/SR	–	FL/FR	Z3
		OFF	SL/SR	SBL/SBR	FL/FR	–
ZONE2/ ZONE3	ON	ON	–	–	Z3 L/R	Z2 L/R
		OFF	SL/SR	–	–	Z2 L/R
	OFF	ON	–	–	Z3 L/R	–
		OFF	SL/SR	SBL/SBR	–	–
ZONE2/3 (MONO)	ON	ON	–	–	Z3(MONO)	Z2(MONO)
		OFF	SL/SR	–	–	–
	OFF	ON	–	–	Z3(MONO)	–
		OFF	SL/SR	SBL/SBR	–	–

Troubleshooting

When this unit is upgraded, the "Audio" contents are changed. To check items related to "Audio", refer to this version of the Owner's Manual instead of the "Original version".





If a problem should arise, first check the following:

1. Are the connections correct?
2. Is the set being operated as described in the owner's manual?
3. Are the other components operating properly?

If this unit does not operate properly, check the items listed in the table below. Should the problem persist, there may be a malfunction.

In this case, disconnect the power immediately and contact your store of purchase.

[Audio]

Symptom	Cause	Countermeasure	Page	
			AVC-A1HD	AVP-A1HD
No sound is produced from center speaker.	<ul style="list-style-type: none"> You are playing a monaural source (TV, AM radio broadcast, etc.) in the "STANDARD" (Dolby/DTS Surround) or "HOME THX CINEMA" mode. 	<ul style="list-style-type: none"> The mode is set to something other than "STANDARD" (Dolby/DTS Surround) or "HOME THX CINEMA". 	35 ~ 37	35 ~ 37
No sound is produced from surround speakers.	<ul style="list-style-type: none"> The surround mode is set to "STEREO". 	<ul style="list-style-type: none"> Set to a surround playback mode. 	35 ~ 37,  47	35 ~ 37,  49
No sound is produced from surround back speaker.	<ul style="list-style-type: none"> Surround back speaker setting is set to "None". Surround mode not set to a mode for 6.1- or 7.1-channel playback. The surround back speaker's power amplifier is assigned to a different channel. 	<ul style="list-style-type: none"> Set to something other than "None". Select a surround playback mode. Sound is not output from the surround back speakers. Change the settings. 	23	23
			35 ~ 37,  48	35 ~ 37,  50
			28, 46 ~ 61	-

Symptom	Cause	Countermeasure	Page	
			AVC-A1HD	AVP-A1HD
No sound is produced from front height speaker.	<ul style="list-style-type: none"> The settings are not configured to use front height speakers. The front height speaker setting is "None". The "Extension Channel" setting is "Front Wide". 	<ul style="list-style-type: none"> In the "Amp Assign" settings, set to use front height speakers. Set the front height speakers to something other than "None". Set the "Extension Channel" setting to "Front Height". 	28, 46 ~ 61	-
			23	23
			28	29
No sound is produced from front wide speaker.	<ul style="list-style-type: none"> The settings are not configured to use front wide speakers. The front wide speaker setting is "None". The "Extension Channel" setting is "Front Height". 	<ul style="list-style-type: none"> In the "Amp Assign" settings, set to use front wide speakers. Set the front wide speakers to something other than "None". Set the "Extension Channel" setting to "Front Wide". 	28, 46 ~ 61	-
			23	23
			28	29
No sound is produced from subwoofer.	<ul style="list-style-type: none"> Subwoofer's power not turned on. The subwoofer was not detected by Auto Setup, or subwoofer is set as "No" in the speaker settings. The subwoofer is not properly connected. The subwoofer volume setting is too low or "Off". 	<ul style="list-style-type: none"> Turn on the subwoofer's power. Set the subwoofer settings to "Yes". Check the connections. Adjust the subwoofer's volume to an appropriate level. 	-	-
			23	23
			7	8
			-	-
No test tones are produced when main remote control unit's TEST button is pressed.	<ul style="list-style-type: none"> Surround mode not set to "STANDARD" (Dolby/DTS Surround) or "HOME THX CINEMA" mode. 	<ul style="list-style-type: none"> Set to the "STANDARD" (Dolby/DTS Surround) or "HOME THX CINEMA" mode. 	35 ~ 37	35 ~ 37

Symptom	Cause	Countermeasure	Page	
			AVC-A1HD	AVP-A1HD
DTS sound is not output.	• DVD player's audio output setting is not set to bitstream.	• Set the DVD player. For details, refer to the DVD player's operating instructions.	–	–
	• DVD player is not compatible with DTS sound playback.	• Use a DTS-compatible player.	–	–
	• The unit's "Decode Mode" setting is set to "PCM".	• Set to the "Auto" or "DTS" mode.	⓪45	⓪47
Saved contents cannot be called using the Web Control function.	• Contents saved before the upgrade cannot be called.	• After completing the upgrade, reconfigure the settings.	⓪61	⓪63
HDMI audio signals are not output from speakers.	• The "Manual Setup" – "HDMI Setup" – "Audio" setting is set to "TV".	• Set to "Amp".	⓪31	⓪31
No sound is output from the monitor connected with HDMI connections.	• The "Manual Setup" – "HDMI Setup" – "Audio" setting is set to "Amp".	• Set to "TV".	⓪31	⓪31

Specifications

AVC-A1HD

When this unit is upgraded, the "Audio section" contents are changed. To check items related to "Audio section", refer to this version of the Owner's Manual instead of the "Original version".

Audio section

Power amplifier

Rated output:

Front:
150 W + 150 W (8 Ω/ohms, 20 Hz ~ 20 kHz with 0.05 % T.H.D.)
170 W + 170 W (6 Ω/ohms, 1 kHz with 0.7 % T.H.D.)
Center:
150 W (8 Ω/ohms, 20 Hz ~ 20 kHz with 0.05 % T.H.D.)
170 W (6 Ω/ohms, 1 kHz with 0.7 % T.H.D.)

Surround:

150 W + 150 W (8 Ω/ohms, 20 Hz ~ 20 kHz with 0.05 % T.H.D.)
170 W + 170 W (6 Ω/ohms, 1 kHz with 0.7 % T.H.D.)

Surround back/Front height/Front wide:

150 W + 150 W (8 Ω/ohms, 20 Hz ~ 20 kHz with 0.05 % T.H.D.)
170 W + 170 W (6 Ω/ohms, 1 kHz with 0.7 % T.H.D.)

Dynamic power:

200 W x 2ch (8 Ω/ohms)
340 W x 2ch (4 Ω/ohms)

Output connectors:

Front, Center, Surround, Surround back,
Front height, Front wide 6 ~ 16 Ω/ohms

Analog

Input sensitivity / Input impedance: 200 mV / 47 kΩ/kohms

Frequency response: 10 Hz ~ 100 kHz — +1, -3 dB (DIRECT mode)

S/N: 102 dB (IHF-A weighted, DIRECT mode)

Distortion: 0.005 % (20 Hz ~ 20 kHz) (DIRECT mode)

Rated output: 1.2 V

Digital

D/A output: Rated output — 2 V (at 0 dB playback)

Total harmonic distortion — 0.005 % (1 kHz, at 0 dB)

Dynamic range — 110 dB

Format — Digital audio interface

Digital input:

Phono equalizer (PHONO input — REC OUT)

Input sensitivity: 2.5 mV

RIAA deviation: ±1 dB (20 Hz to 20 kHz)

S/N: 74 dB (A weighting, with 5 mV input)

Rated output: 150 mV

Distortion factor: 0.03 % (1 kHz, 3 V)

※ For purposes of improvement, specifications and design are subject to change without notice.

AVP-A1HD

No specifications are changed by this upgrade.

DENON

www.denon.com

D&M Holdings Inc.
3520 10058 00AD

Free Manuals Download Website

<http://myh66.com>

<http://usermanuals.us>

<http://www.somanuals.com>

<http://www.4manuals.cc>

<http://www.manual-lib.com>

<http://www.404manual.com>

<http://www.luxmanual.com>

<http://aubethermostatmanual.com>

Golf course search by state

<http://golfingnear.com>

Email search by domain

<http://emailbydomain.com>

Auto manuals search

<http://auto.somanuals.com>

TV manuals search

<http://tv.somanuals.com>