

# DENON

## DVD VIDEO AUTO CHANGER

# DVM-3700

## OPERATING INSTRUCTIONS MODE D'EMPLOI

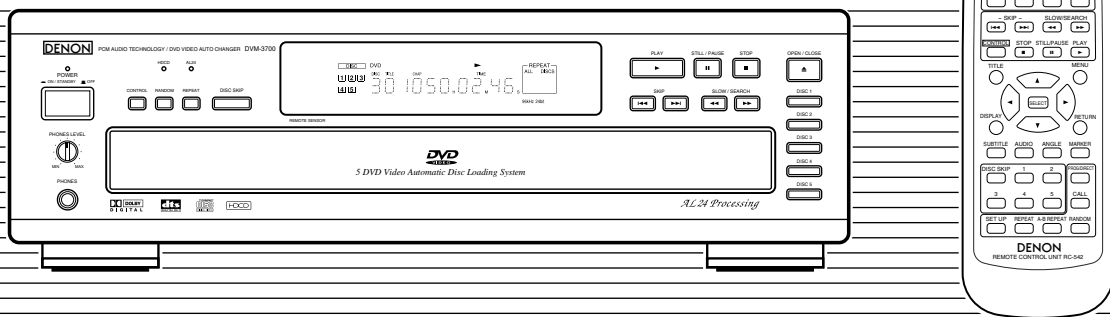

FOR ENGLISH READERS PAGE 6 ~ PAGE 62  
POUR LES LECTEURS FRANCAIS PAGE 63 ~ PAGE 119

## IMPORTANT TO SAFETY

### WARNING:

**TO PREVENT FIRE OR SHOCK HAZARD, DO NOT EXPOSE THIS APPLIANCE TO RAIN OR MOISTURE.**

### CAUTION:

#### 1. Handle the power supply cord carefully

Do not damage or deform the power supply cord. If it is damaged or deformed, it may cause electric shock or malfunction when used. When removing from wall outlet, be sure to remove by holding the plug attachment and not by pulling the cord.

#### 2. Do not open the top cover

In order to prevent electric shock, do not open the top cover. If problems occur, contact your DENON DEALER.

#### 3. Do not place anything inside

Do not place metal objects or spill liquid inside the DVD video player. Electric shock or malfunction may result.

Please, record and retain the Model name and serial number of your set shown on the rating label.

Model No. DVM-3700                      Serial No. \_\_\_\_\_

### NOTE:

This DVD video player uses the semiconductor laser. To allow you to enjoy music at a stable operation, it is recommended to use this in a room of 5°C (41°F) — 35°C (95°F).

### CAUTION:

**USE OF CONTROLS OR ADJUSTMENTS OR REFORMATION OF PROCEDURES OTHER THAN THOSE SPECIFIED HEREIN MAY RESULT IN HAZARDOUS RADIATION EXPOSURE.**

**THE COMPACT DISC PLAYER SHOULD NOT BE ADJUSTED OR REPAIRED BY ANYONE EXCEPT PROPERLY QUALIFIED SERVICE PERSONNEL.**

This device complies with Part 15 of the FCC Rules. Operation is subject to the following two conditions: (1) This device may not cause harmful interference, and (2) this device must accept any interference received, including interference that may cause undesired operation.

This Class B digital apparatus meets all requirements of the Canadian Interference-Causing Equipment Regulations.

Cet appareil numérique de la classe B respecte toutes les exigences du Règlement sur le matériel brouilleur du Canada.



**CAUTION: TO REDUCE THE RISK OF ELECTRIC SHOCK, DO NOT REMOVE COVER (OR BACK). NO USER SERVICEABLE PARTS INSIDE. REFER SERVICING TO QUALIFIED SERVICE PERSONNEL.**



The lightning flash with arrowhead symbol, within an equilateral triangle, is intended to alert the user to the presence of uninsulated "dangerous voltage" within the product's enclosure that may be of sufficient magnitude to constitute a risk of electric shock to persons.



The exclamation point within an equilateral triangle is intended to alert the user to the presence of important operating and maintenance (servicing) instructions in the literature accompanying the appliance.

#### • FOR U.S.A. & CANADA MODEL ONLY

### CAUTION

TO PREVENT ELECTRIC SHOCK DO NOT USE THIS (POLARIZED) PLUG WITH AN EXTENSION CORD, RECEPTACLE OR OTHER OUTLET UNLESS THE BLADES CAN BE FULLY INSERTED TO PREVENT BLADE EXPOSURE.

#### • POUR LES MODELES AMERICAINS ET CANADIENS UNIQUEMENT

### ATTENTION

POUR PREVENIR LES CHOCS ELECTRIQUES NE PAS UTILISER CETTE FICHE POLARISEE AVEC UN PROLONGATEUR UNE PRISE DE COURANT OU UNE AUTRE SORTIE DE COURANT, SAUF SI LES LAMES PEUVENT ETRE INSEREES A FOND SANS EN LAISSER AUCUNE PARTIE A DECOUVERT.

FRONT PANEL  
PANNEAU AVANT

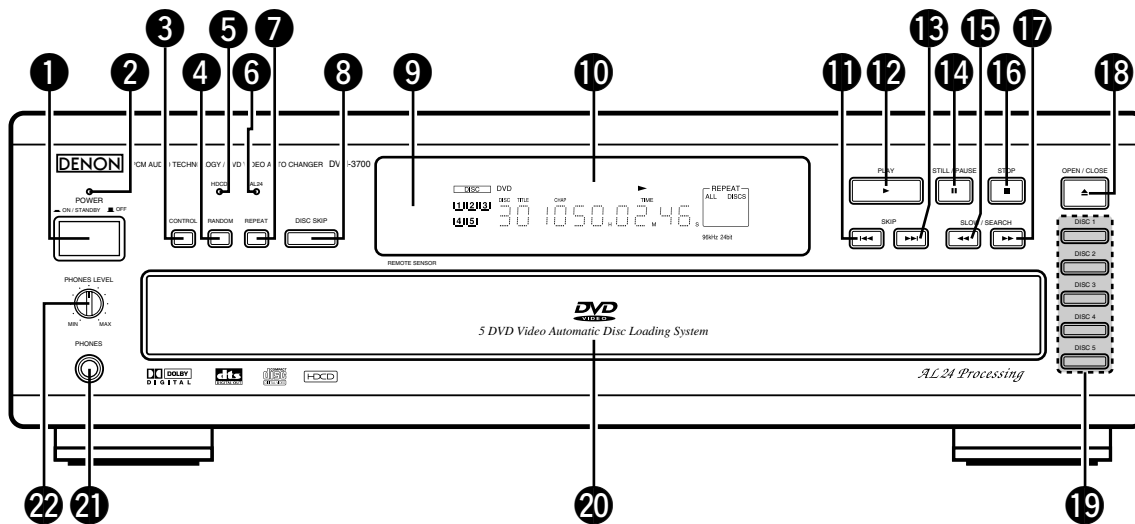

REAR PANEL  
PANNEAU ARRIERE

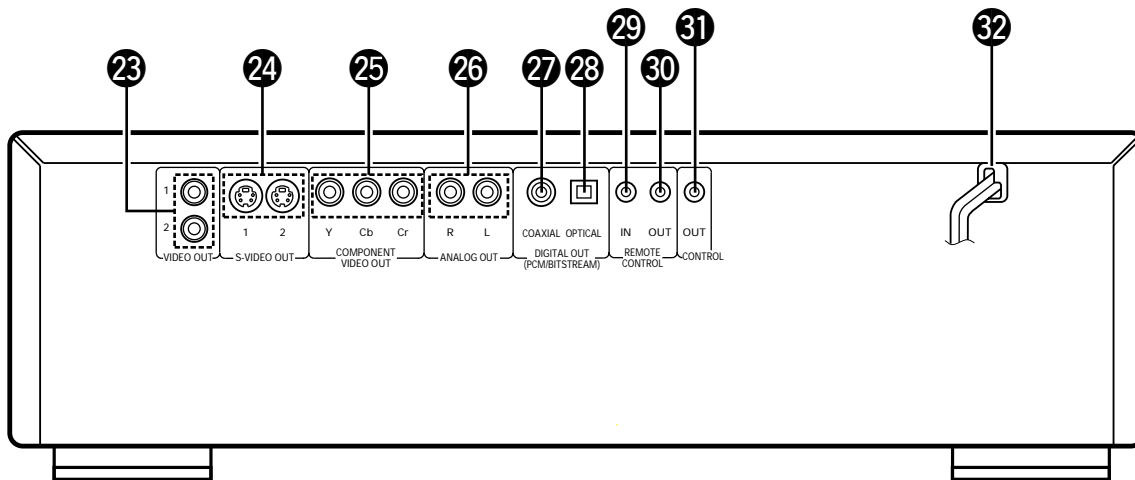



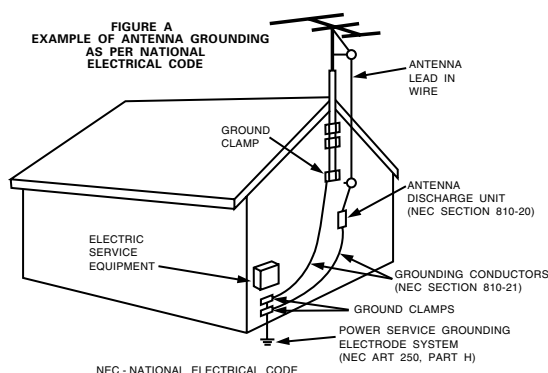

# SAFETY INSTRUCTIONS

1. Read Instructions – All the safety and operating instructions should be read before the appliance is operated.
2. Retain Instructions – The safety and operating instructions should be retained for future reference.
3. Heed Warnings – All warnings on the appliance and in the operating instructions should be adhered to.
4. Follow Instructions – All operating and use instructions should be followed.
5. Water and Moisture – The appliance should not be used near water – for example, near a bathtub, washbowl, kitchen sink, laundry tub, in a wet basement, or near a swimming pool, and the like.
6. Carts and Stands – The appliance should be used only with a cart or stand that is recommended by the manufacturer.
- 6A. An appliance and cart combination should be moved with care. Quick stops, excessive force, and uneven surfaces may cause the appliance and cart combination to overturn.
7. Wall or Ceiling Mounting – The appliance should be mounted to a wall or ceiling only as recommended by the manufacturer.
8. Ventilation – The appliance should be situated so that its location or position does not interfere with its proper ventilation. For example, the appliance should not be situated on a bed, sofa, rug, or similar surface that may block the ventilation openings; or, placed in a built-in installation, such as a bookcase or cabinet that may impede the flow of air through the ventilation openings.
9. Heat – The appliance should be situated away from heat sources such as radiators, heat registers, stoves, or other appliances (including amplifiers) that produce heat.
10. Power Sources – The appliance should be connected to a power supply only of the type described in the operating instructions or as marked on the appliance.
11. Grounding or Polarization – Precautions should be taken so that the grounding or polarization means of an appliance is not defeated.
12. Power-Cord Protection – Power-supply cords should be routed so that they are not likely to be walked on or pinched by items placed upon or against them, paying particular attention to cords at plugs, convenience receptacles, and the point where they exit from the appliance.
14. Cleaning – The appliance should be cleaned only as recommended by the manufacturer.
15. Power Lines – An outdoor antenna should be located away from power lines.
16. Outdoor Antenna Grounding – If an outside antenna is connected to the receiver, be sure the antenna system is grounded so as to provide some protection against voltage surges and built-up static charges. Article 810 of the National Electrical Code, ANSI/NFPA 70, provides information with regard to proper grounding of the mast and supporting structure, grounding of the lead-in wire to an antenna-discharge unit, size of grounding conductors, location of antenna-discharge unit, connection to grounding electrodes, and requirements for the grounding electrode. See Figure A.
17. Nonuse Periods – The power cord of the appliance should be unplugged from the outlet when left unused for a long period of time.
18. Object and Liquid Entry – Care should be taken so that objects do not fall and liquids are not spilled into the enclosure through openings.
19. Damage Requiring Service – The appliance should be serviced by qualified service personnel when:
  - A. The power-supply cord or the plug has been damaged; or
  - B. Objects have fallen, or liquid has been spilled into the appliance; or
  - C. The appliance has been exposed to rain; or
  - D. The appliance does not appear to operate normally or exhibits a marked change in performance; or
  - E. The appliance has been dropped, or the enclosure damaged.
20. Servicing – The user should not attempt to service the appliance beyond that described in the operating instructions. All other servicing should be referred to qualified service personnel.

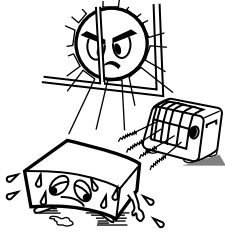
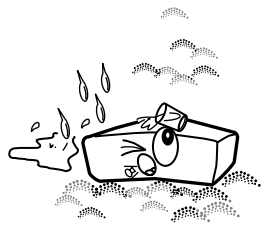
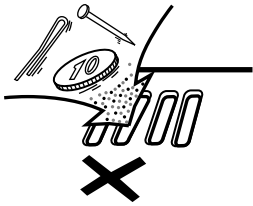
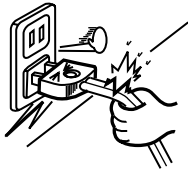
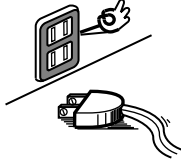

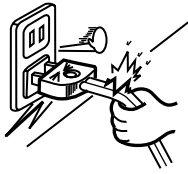
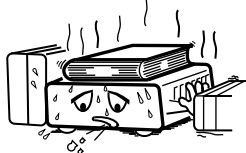
## NOTE ON USE / OBSERVATIONS RELATIVES A L'UTILISATION

 <ul style="list-style-type: none"> <li>• Avoid high temperatures. Allow for sufficient heat dispersion when installed on a rack.</li> <li>• Eviter des températures élevées. Tenir compte d'une dispersion de chaleur suffisante lors de l'installation sur une étagère.</li> </ul>	 <ul style="list-style-type: none"> <li>• Keep the set free from moisture, water, and dust.</li> <li>• Protéger l'appareil contre l'humidité, l'eau et la poussière.</li> </ul>	 <ul style="list-style-type: none"> <li>• Do not let foreign objects in the set.</li> <li>• Ne pas laisser des objets étrangers dans l'appareil.</li> </ul>
 <ul style="list-style-type: none"> <li>• Handle the power cord carefully. Hold the plug when unplugging the cord.</li> <li>• Manipuler le cordon d'alimentation avec précaution. Tenir la prise lors du débranchement du cordon.</li> </ul>	 <ul style="list-style-type: none"> <li>• Unplug the power cord when not using the set for long periods of time.</li> <li>• Débrancher le cordon d'alimentation lorsque l'appareil n'est pas utilisé pendant de longues périodes.</li> </ul>	 <ul style="list-style-type: none"> <li>• Do not let insecticides, benzene, and thinner come in contact with the set.</li> <li>• Ne pas mettre en contact des insecticides, du benzène et un diluant avec l'appareil.</li> </ul>
 <ul style="list-style-type: none"> <li>• Handle the power cord carefully. Hold the plug when unplugging the cord.</li> <li>• Manipuler le cordon d'alimentation avec précaution. Tenir la prise lors du débranchement du cordon.</li> </ul>	 <p>* (For sets with ventilation holes)</p> <ul style="list-style-type: none"> <li>• Do not obstruct the ventilation holes.</li> <li>• Ne pas obstruer les trous d'aération.</li> </ul>	 <ul style="list-style-type: none"> <li>• Never disassemble or modify the set in any way.</li> <li>• Ne jamais démonter ou modifier l'appareil d'une manière ou d'une autre.</li> </ul>

**CAUTION:**

At the bottom of the player there is shipping screw for use when the player is transported. Before using the player, turn the shipping screw (located under the player) counterclockwise and remove it. The player cannot start playing unless this screw is removed. Keep this screw for future use. When the player is going to be transported, remove the discs and close the disc tray. Turn off the power after "000 00 00" is displayed, then unplug the power cable from the outlet. Insert the shipping screw and turn clockwise. Tighten until secure.

**ATTENTION:**

Au-dessous du lecteur se trouve une vis de transport qui doit être utilisée pour transporter l'appareil. Avant d'utiliser le lecteur, dévissez cette vis de transport (située sous le lecteur) en tournant en sens inverse des aiguilles d'une montre et retirez-la. Le lecteur ne peut pas fonctionner tant que cette vis n'est pas enlevée. Conservez cette vis pour une utilisation ultérieure. Lorsque le lecteur va devoir être transporté, retirez les disques et fermez le tiroir à disque. Eteignez l'appareil après que "000 00 00" soit affiché, puis débranchez le câble d'alimentation de la prise. Insérez la vis de transport et vissez-la dans le sens des aiguilles d'une montre. Serrez à fond.

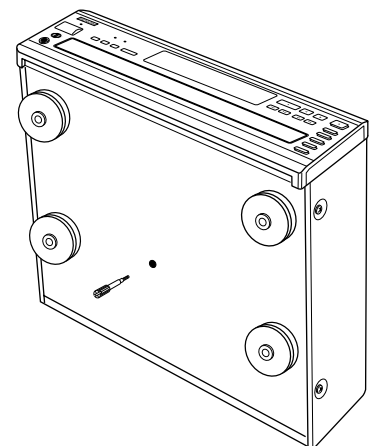
**Copyrights / Droits d'auteur**

- It is prohibited by law to reproduce, broadcast, rent or play discs in public without the consent of the copyright holder.
- La reproduction, la diffusion, la location, le prêt ou la lecture publique de ces disques sont interdits sans le consentement du détenteur des droits d'auteur.

— TABLE OF CONTENTS —

<b>1</b> Features .....	6, 7	<b>11</b> Playing Repeatedly .....	32, 33
<b>2</b> Discs .....	8	<b>12</b> Playing Tracks in the Desired Order .....	34, 35
<b>3</b> Cautions on Handling Discs .....	9	<b>13</b> Playing the Tracks in Random Order .....	35
<b>4</b> Connections .....	10~14	<b>14</b> 100 CD Changer Control Function .....	36
<b>5</b> Part Names and Functions .....	15, 16	<b>15</b> Using the Multiple Audio, Subtitle and Angle Functions .....	37~41
<b>6</b> Remote Control Unit .....	17, 18	<b>16</b> Using the Menu .....	42, 43
<b>7</b> Loading Discs .....	19, 20	<b>17</b> Changing the Default Settings .....	44~60
<b>8</b> Playback .....	21~25	<b>18</b> Troubleshooting .....	61
<b>9</b> Using the GUI Screens .....	26~30	<b>19</b> Main Specifications .....	62
<b>10</b> Marking Scenes You Want to See Again .....	31		

• ACCESSORIES

Please check to make sure the following items are included with the main unit in the carton:

<b>1</b> Video/Audio cord .....	1	<b>4</b> Operating instructions .....	1
<b>2</b> Remote control unit (RC-542) .....	1	<b>5</b> Service station list .....	1
<b>3</b> Batteries ("AA" (R6P)) .....	2		



**1** FEATURES

The DVM-3700 is DENON's top grade DVD video auto changer equipped with the latest in digital technology. This includes AL 24 Processing, a newly developed analog waveform reproduction technology with sights on next generation media, as well as a multi 24-bit D/A converter with 96 kHz sampling compatibility taking maximum advantage of the high quality offered by AL 24 Processing.

**1. Newly developed AL 24 Processing**

- (1) AL 24 Processing, an advanced version of conventional ALPHA Processing, is a newly developed analog waveform reproduction technology, and offers compatibility with the high number of bits and high sampling rates of next generation media. AL 24 Processing compensates the input digital data to reproduce the sound with analog waveforms as close as possible to those existing in nature and with 24-bit quality. The result is increased musical reproduction capabilities of reverberations, etc., at low levels, for a sound that seems to draw you into the concert hall.
- (2) AL 24 Processing of course carries over Adaptive Line Pattern Harmonized Algorithm & Automatic Low Pass Filter Harmonic Adjustment, the strong points of conventional ALPHA Processing. On the DVM-3700 these filters have been dramatically improved, resulting

in a filtered band attenuation of over -115 dB and ripple within the passing band of ±0.00002 dB, a figure comparable to that of professional recorders.

**2. High precision multi 24-bit D/A converter**

- (1) The DVM-3700 is equipped with a multi 24-bit D/A converter for faithful D/A conversion of the high quality 24-bit data achieved through AL 24 Processing. This further enhances such aspects of audio performance as the S/N ratio, dynamic range and distortion and makes full use of the possibilities for high quality sound provided by a high number of bits and high sampling rates.
- (2) The multi 24-bit D/A converter is little affected by noise resulting from fluctuations in the power supply voltage and current, and the quantization distortion level within the band is constant regardless of the frequency, resulting in clear sound with little noise.

**3. Newly developed carousel-type changer mechanism included**

This mechanism can house five discs, and while one disc is playing the remaining four discs can be changed. In addition, the carousel can be rotated either clockwise or counterclockwise, so searching between discs is fast.

#### 4. **Dolby Digital (AC-3) bitstream output compatibility (NOTE 1)**

The DVM-3700 is compatible with Dolby Digital (AC-3) bitstream output. When a Dolby Digital (AC-3) decoder is connected, the three-dimensional sense and positioning of the sound is recreated extremely naturally, resulting in a strong sense of presence, as if you were in a movie theater or concert hall.

#### 5. **®, HDCD® (High Definition Compatible Digital®) decoder (NOTE 2)**

HDCD is an encoding/decoding technology that greatly reduces the distortion occurring at the time of digital recording while maintaining compatibility with the conventional CD format. HDCD allows 24-bit data to be converted into the 16-bit data of current CDs with no loss in sound quality.

The use of this HDCD decoder makes it possible to achieve the high resolution and low distortion characteristic of HDCD when playing HDCD-compatible discs, and DENON's digital technology optimizes the high sound quality possibilities of HDCD technology. Furthermore, normal CDs, DVDs and HDCD-compatible CDs are automatically identified, and the optimum digital signal processing for that type of disc is used.

#### 6. **DTS bitstream output compatibility (NOTE 3)**

The DVM-3700 is compatible with DTS bitstream output, an optional audio format for DVD video. DTS sound can be enjoyed by connecting a commercially available DTS decoder and AV amplifier.

#### 7. **Advanced Virtual Surround Sound (V.S.S.) function**

Even when just two front speakers are being used, the user can simply press the V.S.S. (Virtual Surround Sound) button during playback of a Dolby Digital DVD (2 channel and above) to provide a rear surround effect. (This does not work with DVD Karaoke discs. In addition, this effect may differ depending on the kind of DVD used.)

#### 8. **High picture quality thanks to a 10-bit video D/A converter**

- (1) The 8-bit/13.5 MHz brightness and color component signals recorded on DVDs are expanded to 10-bit/27 MHz signals and requantized, leaving room to spare in the processing of the recorded signals to provide the beautiful pictures DVDs have to offer. Furthermore, color component video output terminals are provided for even more faithful reproduction of the colors.

#### (2) **An array of picture quality modes yielded by digital processing**

Signal deterioration is kept to the minimum by processing the data as digital data.

This feature can be used as the picture quality setting individually tailored for DVD playback.

- **Digital Cinema Mode**

Using the On-Screen Menu Icons enables the cinema mode, which is best for the playback of movie programs, to be selected.

In addition, the picture quality best suited to the type of software programs concerned can be selected. In all, four picture quality modes are provided: normal, soft, fine and cinema.

- **User selection**

Using the On-Screen Menu Icons, the contrast, color hue, equalizer and brightness can be adjusted to suit your own preference.

- **Monitor selector**

Once the type of TV used [Standard (Direct View TV), CRT Projector, LCD Projector, Projection TV] has been selected when the initial setting operations are performed, the optimum picture quality for the type of TV concerned will be automatically selected.

#### 9. **Many convenient functions**



- (1) Multiple audio function  
Selection of up to 8 audio languages.  
(The number of languages offered differs from DVD to DVD.)
- (2) Multiple subtitle function  
Selection of up to 32 subtitle languages.  
(The number of languages offered differs from DVD to DVD.)
- (3) Multiple angle function  
The angle of view can be changed.  
(For DVDs on which multiple angles are recorded.)
- (4) GUI (Graphical User Interface) function  
The on-screen display button on the remote control unit can be used to display player and disc information on the TV screen.
- (5) Marker function  
The positions of up to five scenes can be stored in the memory, so you can watch your favorite scenes whenever you want.
- (6) Playback disable function  
This function can be used to disable playback of DVDs you do not want children to watch.

#### NOTES:

1. Manufactured under license from Dolby Laboratories. "Dolby" and the double-D symbol are trademarks of Dolby Laboratories. Confidential Unpublished Work. ©1992 – 1997 Dolby Laboratories, Inc. All rights reserved.
2. ®, HDCD®, High Definition Compatible Digital® and Pacific Microsonics™ are either registered trademarks or trademarks of Pacific Microsonics, Inc. in the United States and/or other countries. HDCD system manufactured under license from Pacific Microsonics, Inc. This product is covered by one or more of the following: In the USA: 5,479,168, 5,638,074, 5,640,161, 5,808,574, 5,838,274, 5,854,600, 5,864,311, 5,872,531, and in Australia: 669114. Other patents pending.
3. "DTS" is a trademark of Digital Theater Systems, Inc.

## 2 DISCS

- The types of discs listed on the table below can be used on the DVM-3700. The marks are indicated on the disc labels or jackets.

Usable discs	Mark (logo)	Recorded signals	Disc size	Maximum recording time
DVD video		Digital audio + digital video (MPEG2)	12 cm	Approx. 240 minutes per side Approx. 480 minutes for both sides
			8 cm	Approx. 80 minutes per side Approx. 160 minutes for both sides
Video CD		Digital audio + digital video (MPEG1)	12 cm	74 minutes
			8 cm	20 minutes
CD		Digital audio	12 cm	74 minutes
			8 cm	20 minutes

■ **The following types of discs cannot be played on the DVM-3700:**

- DVD with Region No. other than "1" or "ALL"
- Disc of PAL system
- VSD
- DVD+RW
- DVD-ROM
- CDV
- CVD
- DVD-R/DVD-RAM
- CD-G
- SVCD
- CD-ROM
- CD-R/RW
- Divx Video Disc etc.

■ **Do not try to play Photo CD or CD-R.**

(Otherwise, data on the disc may be damaged.)

\* If you attempt to play CD-R or photo CD, the data on the disc may be damaged.

■ **Disc terminology**

• **Titles and chapters (DVDs)**

DVDs are divided into several large sections called "titles" and smaller sections called "chapters".

Numbers are allotted to these sections. These numbers are called "title numbers" and "chapter numbers".

For example:

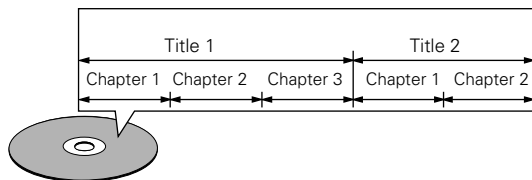

• **Tracks (video and music CDs)**

Video and music CDs are divided into sections called "tracks".

Numbers are allotted to these sections. These numbers are called "track numbers".

For example:

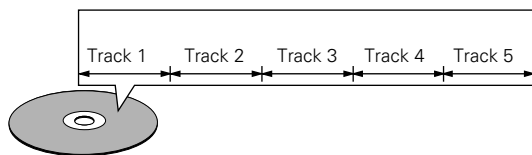

• **Playback control (video CDs)**

Video CDs including the words "playback control" on the disc or jacket are equipped with a function for displaying menus on the TV screen for selecting the desired position, displaying information, etc., in dialog fashion.

In this manual, playing video CDs using such menu is referred to "menu playback".

Video CDs with playback control can be used on the DVM-3700.

**NOTE:**

- This DVD video player is designed and manufactured to respond to the Region Management Information that is recorded on a DVD disc. If the Region number described on the DVD disc does not correspond to the Region number of this DVD video player, this DVD video player cannot play this disc. The Region number for this DVD video player is 1.





### 3 CAUTIONS ON HANDLING DISCS

#### Discs

Only the discs including the marks shown on page 8 can be played on the DVM-3700.  
 Note, however, that discs with special shapes (heart-shaped discs, hexagonal discs, etc.) cannot be played on the DVM-3700. Do not attempt to play such discs, as they may damage the player.

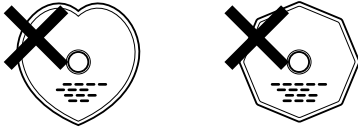

#### Holding Discs

Avoid touching the surface of discs when loading and unloading them.

Be careful not to get fingerprints on the signal surface (the side which shines in rainbow colors).



#### Cleaning Discs

- Fingerprints or dirt on the disc may lower sound and picture quality or cause breaks in playback. Wipe off fingerprints or dirt.
- Use a commercially available disc cleaning set or a soft cloth to wipe off fingerprints or dirt.

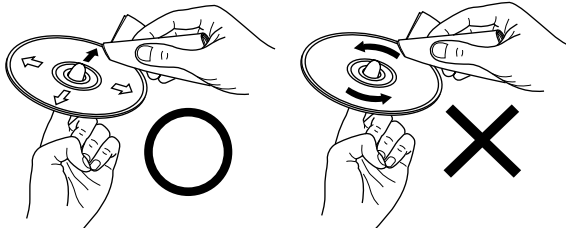

Wipe gently from the middle outwards. Do not wipe with a circular motion.

**NOTE:**

- Do not use record spray or antistatic. Also do not use volatile chemicals such as benzene or thinner.

Record spray    Thinner    Benzene

#### Cautions on Handling Discs

- Do not get fingerprints, grease or dirt on discs.
- Be especially careful not to scratch discs when removing them from their cases.
- Do not bend discs.
- Do not heat discs.
- Do not enlarge the center hole.
- Do not write on the labeled (printed) side with a ball-point pen or a pencil.
- Water droplets may form on the surface if the disc is moved suddenly from a cold place to a warm one. Do not use a hairdryer, etc., to dry the disc.

#### Cautions on Storing Discs

- Always eject discs after playing them.
- Keep discs in their cases to protect them from dust, scratches and warping.
- Do not put discs in the following places:
  1. Places exposed to direct sunlight for long periods of time
  2. Humid or dusty places
  3. Places exposed to heat from heaters, etc.

#### Cautions on Loading Discs

- Only load one disc at a time. Loading one disc on top of another may result in damage or scratch the discs.
- Load 8 cm discs securely in the disc guide, without using an adapter. If the disc is not properly loaded, it may slip out of the guide and block the disc tray.
- Be careful not to let your fingers get caught when the disc tray is closing.
- Do not place anything but discs in the disc tray.
- Do not load cracked or warped discs or discs that have been fixed with adhesive, etc.
- Do not use discs on which the adhesive part of cellophane tape or glue used to attach the label is exposed, or discs with traces of tape or labels that have been peeled off. Such discs may get stuck inside the player, resulting in damage.

## 4 CONNECTIONS

**NOTES:**

- Read the manuals of all the components when making connections.
- Keep the power cord unplugged until all connections have been completed.
- If the power is on when connections are made, noise may be generated and damage the speakers.
- Be sure to connect the left and right channels properly, L (left) to L, R (right) to R.
- Plug the power cord securely into the power outlet. Incomplete connection may result in noise.
- Binding the power cord together with connection cords may result in humming or noise.
- Plug in the power cord in the direction in which the sound is most to your liking.

### (1) Connecting to an AV TV

- Use the included video/audio cord to connect the TV's video input connectors and audio input connector to the DVM-3700's video output connectors and audio output connector.

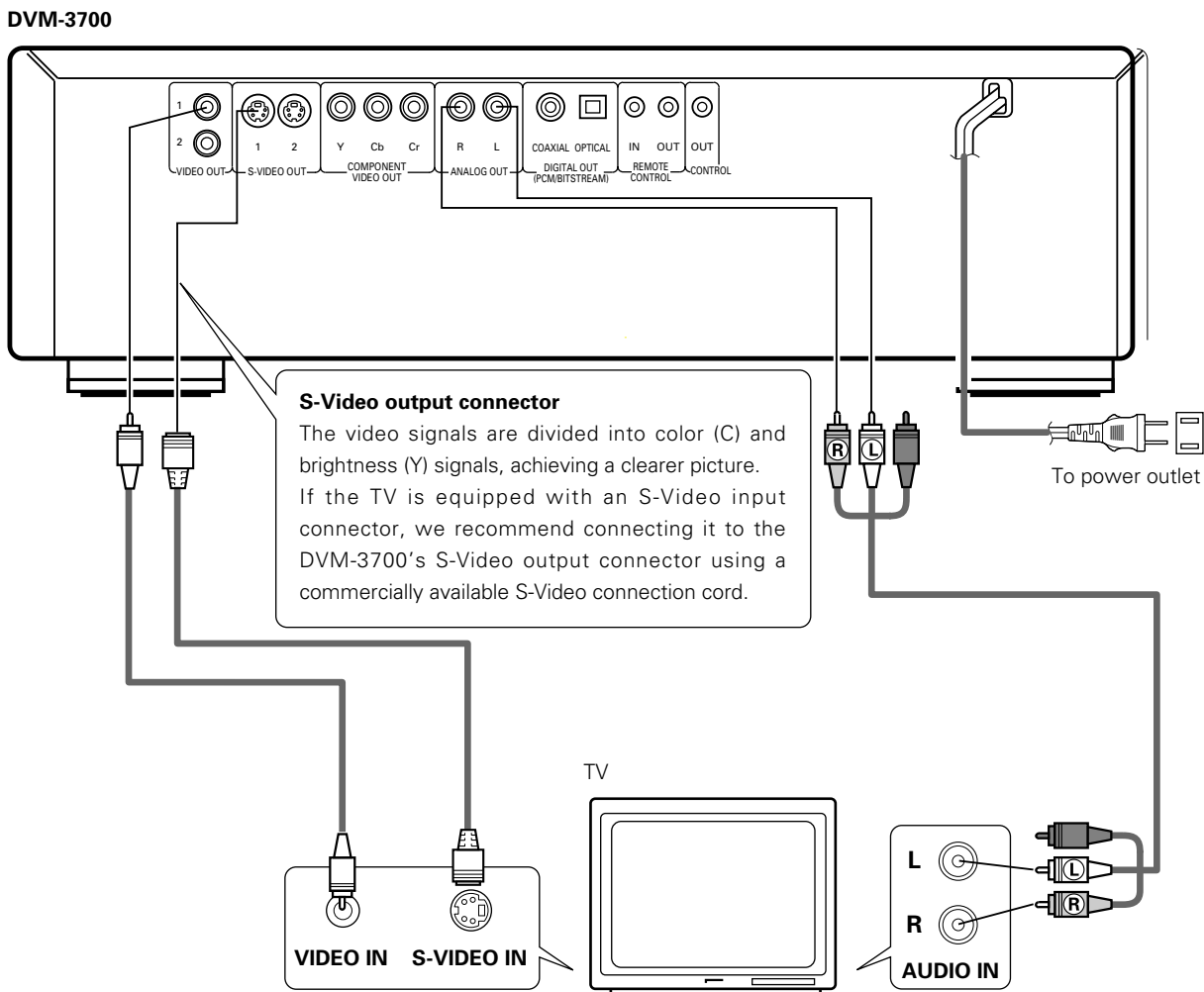

**Video equipment you own**

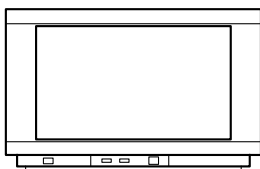

**Standard (Direct View TV)**  
**(See pages 10 and 11.)**  
 Conventional TV set (4:3),  
 Wide-screen TV set (16:9),  
 Digital TV etc.

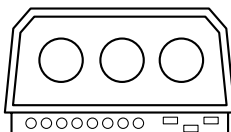

**CRT projector**  
**(See pages 10 and 11.)**  
 Cinema-size images can be  
 enjoyed by projecting from  
 three light sources onto a  
 large screen.

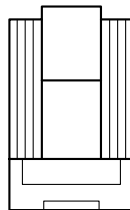

**LCD projector**  
**(See pages 10 and 11.)**  
 Cinema-size images can be  
 enjoyed by projecting from  
 an LCD panel onto a large  
 screen.

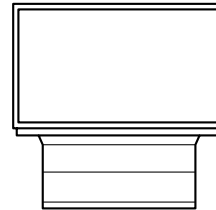

**Projection TV**  
**(See pages 10 and 11.)**  
 Powerful images can be  
 enjoyed with a large rear  
 screen projector.

**NOTES:**

- Connect the DVM-3700's video outputs to the TV either directly or through an AV amplifier. Do not connect it via a VCR (video cassette recorder).
- Some discs contain copy prohibit signals. If such discs are played via a VCR, the copy prohibit system may cause disturbance in the picture.

**(2) Connecting to a TV or Monitor Equipped with Color Component Input Connectors**

**Color component output connectors (Cr, Cb and Y)**

The red (Cr), blue (Cb) and brightness (Y) signals are output independently, achieving more faithful reproduction of the colors.

- The color component input connectors may be marked differently on some TVs or monitors (Pr, Pb and Y/R-Y, B-Y and Y/Cr, Cb and Y, etc.). For details, refer to the TV's operating instructions.

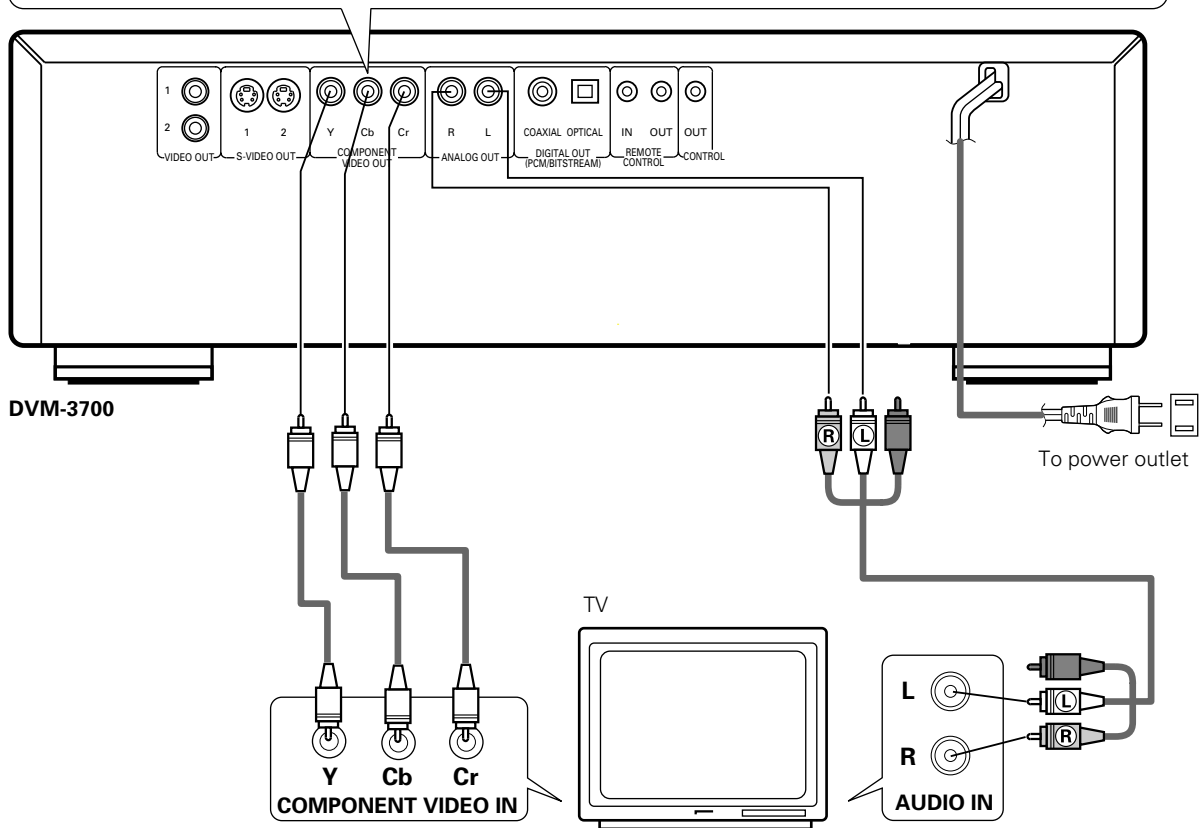

**NOTE:**

- Use three commercially available 75 Ω/ohm pin-plug cord to connect the DVM-3700's color component output connectors to the TV or monitor.

**(3) Connecting to a Dolby Digital (AC-3) or DTS (digital theater systems) Decoder**

When DVDs recorded in Dolby Digital or DTS are played, Dolby Digital or DTS bitstream signals are output from the DVD player's digital audio output connectors. If a Dolby Digital or DTS decoder is connected, you can achieve sound with the power and sense of presence of a movie theater or concert hall.

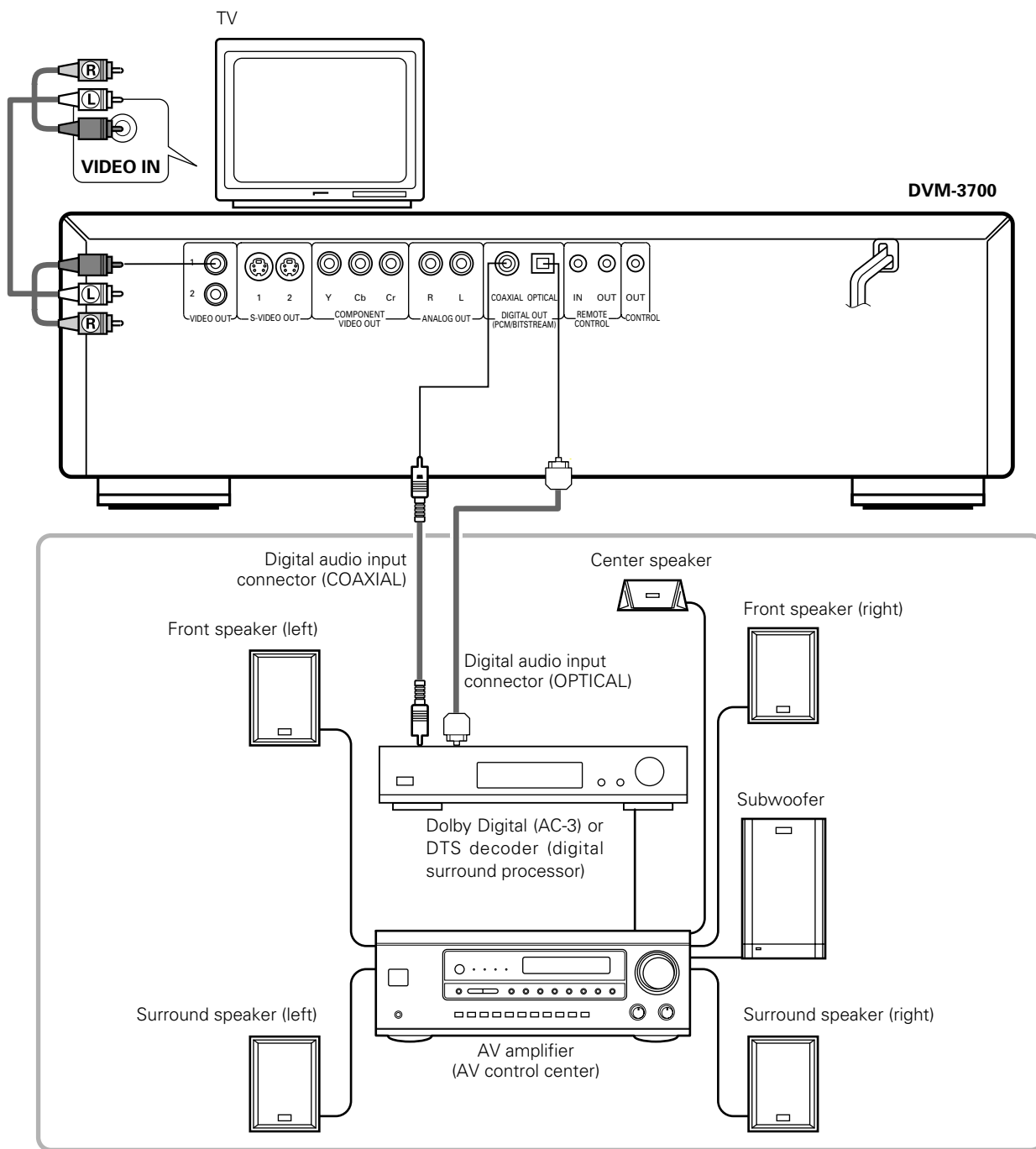

■ **Connecting an optical fiber cable (commercially available) to the digital audio input connector (OPTICAL)**

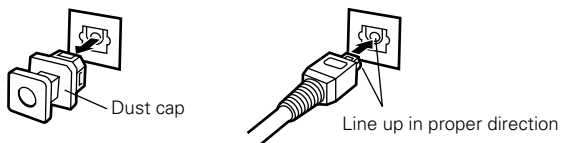

**NOTE:**

- Store the dust cap in a safe place, and be careful not to lose it. When not using the terminal, attach the cap to protect the terminal from dust.

Remove the dust cap, line up the cable in the proper direction, then insert it securely as far as it goes.

■ Sound output from the DVM-3700's digital audio output connectors

Disc played	Audio recording format	Sound output
DVD video	Dolby Digital (AC-3)	<ul style="list-style-type: none"> <li>Dolby Digital bitstream (1 to 5.1 channels) or PCM (48 kHz/16 bit) (2 channels). (NOTE 1, 2)</li> <li>* Select with the "Digital Audio Output" default setting. (See page 56.)</li> </ul>
	DTS	<ul style="list-style-type: none"> <li>dts bitstream or no output.</li> <li>* Select with the "Digital Audio Output" default setting. (See page 56.)</li> </ul>
	Linear PCM 48 kHz/96 kHz 16/20/24 bit	<ul style="list-style-type: none"> <li>Linear PCM (48 kHz/16 bit only) (2 channels) or no output. (NOTE 2)</li> <li>* Select with the "Digital Audio Output" default setting. (See page 56.)</li> </ul>
Video CD	MPEG1	<ul style="list-style-type: none"> <li>PCM (44.1 kHz) (NOTE 1)</li> </ul>
CD	Linear PCM	<ul style="list-style-type: none"> <li>Linear PCM (44.1 kHz)</li> </ul>

NOTE 1: The type of audio output from the connector can be selected by "7 Digital Audio Output" of the initial setting. (See page 56.)

NOTE 2: Compressed audio is converted to PCM before output.

**NOTE:**

- Some dts decoders which do not support DVD- dts interface may not work properly with the DVD video auto changer.

- Linear PCM audio is the signal recording format used for music CDs. While the signals are recorded at 44.1 kHz/16 bit for music CDs, for DVDs they are recorded at 48 kHz/16 bit to 96 kHz/24 bit, providing higher sound quality than music CDs.

(4) Connecting to a Digital Recorder (MD Recorder, DAT Deck, etc.)

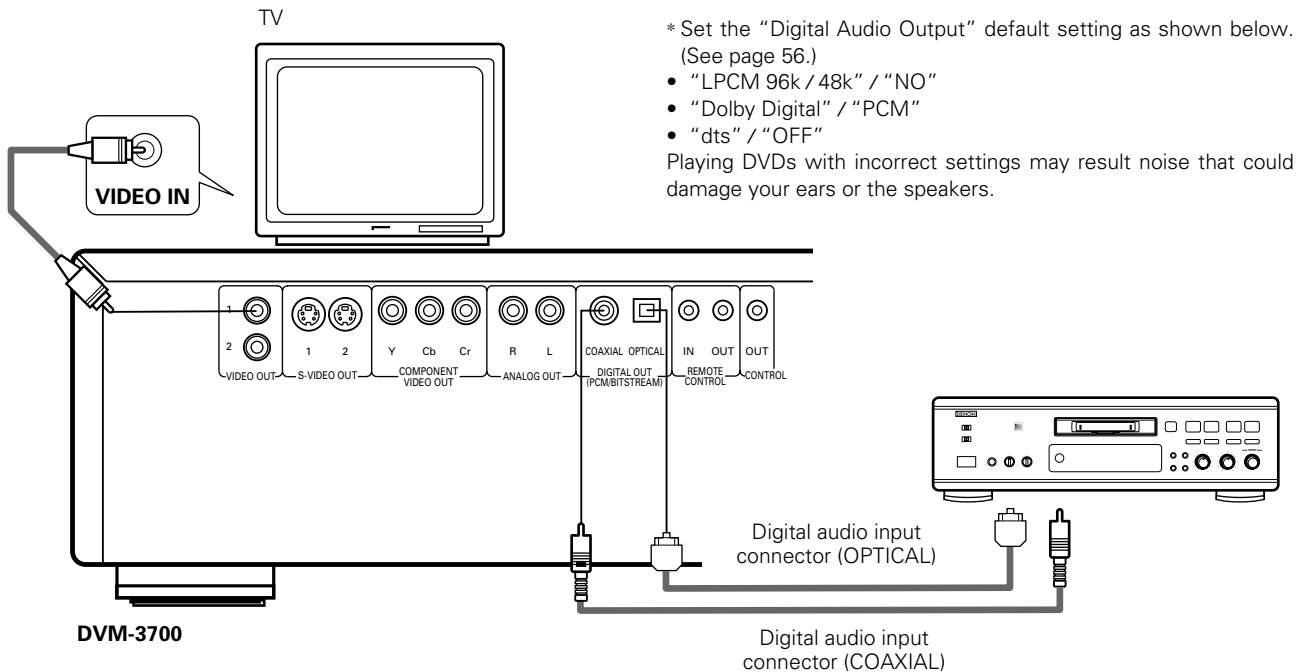

(5) Connecting to a Stereo Component

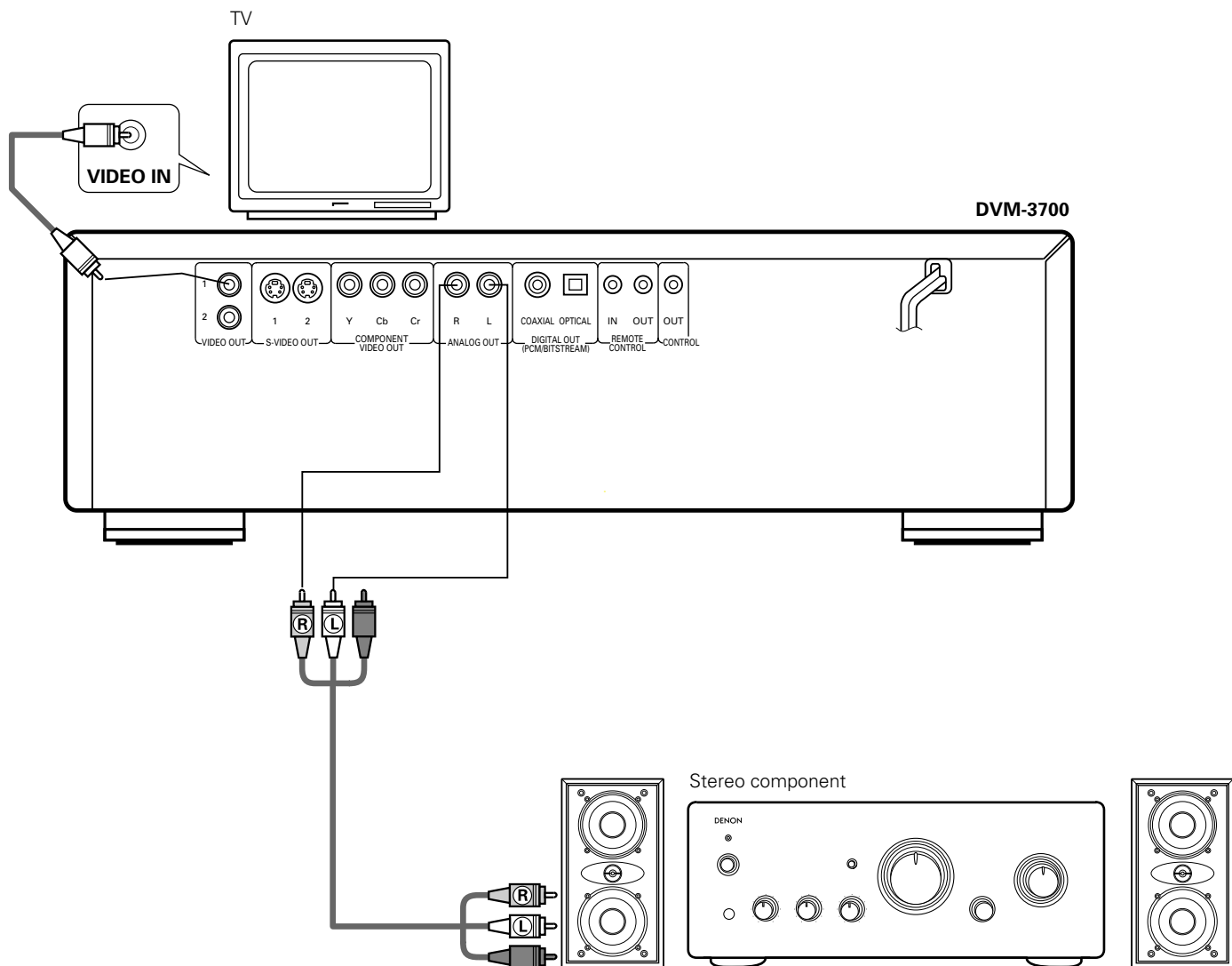

**NOTE:**

- Use commercially available 75 Ω/ohm pin-plug cord to connect the DVM-3700's video out connector to the TV or monitor.

## 5 PART NAMES AND FUNCTIONS

### (1) Front Panel

- 1 POWER button**
  - Press once to turn the power on.
  - Press again to set to the "OFF" position and turn the power off.
  - Set the power to the standby mode by pressing the POWER button on the remote control unit while the power is on.
  - Turn the power on from the standby mode by pressing the POWER button on the remote control unit.
- 2 Power indicator**
  - This indicator lights when the power is on and when the power is in the standby mode.
- 3 CONTROL button**
  - Press this button to set the control mode. In the control mode, the separately sold 100 CD changer (DCM-5000/5001) can be operated using the buttons on the DVM-3700 or the included remote control unit (RC-542).
  - The CONTROL OUT connector on the rear panel of the DVM-3700 must be connected to the REMOTE CONTROL IN connector on the separately sold 100 CD changer (DCM-5000/5001) in order to use this function.
- 4 RANDOM button**
  - Press this button to begin random play.
  - Pressing this button during stop, and press play button play to full automatic random play.
  - This button does not work when playing DVDs.
- 5 HDCD indicator**
  - This indicator lights when playing discs recorded in HDCD® format.
- 6 AL 24 indicator**
  - This indicator lights when the audio signals of a DVD, etc., are being processed digitally with the AL 24 processor, a newly developed analog waveform reproduction technology.
- 7 REPEAT button**
  - Press this button for repeated playback. (Refer to page 32 for details.)
- 8 DISC SKIP button**
  - Each time this button is pressed, the carousel will rotate in a clockwise direction to the next tray position. This allows for loading or unloading of discs.
  - This button is also used to select the next disc, in the normal play continuously.
- 9 Remote control sensor (REMOTE SENSOR)**
- 10 Display**
  - Information on the disc that is currently playing is shown on the display. (See page 16.)
- 11 SKIP button (I◀◀)**
  - Press this to move back to the beginning of the current track (or chapter).
  - Press again to move back to the beginning of the previous track (or chapter).
- 12 PLAY button (▶)**
  - Press this to play the disc.
- 13 SKIP button (▶▶I)**
  - Press this to move ahead to the beginning of the next track (or chapter).
- 14 STILL/PAUSE button (III)**
  - Press this button to stop play temporarily.
- 15 SLOW/SEARCH button (◀◀)**
  - Press this button in the play mode to search in the reverse direction.
  - Press the button in the still mode for slow play in the reverse direction.

- 16 STOP button (■)**
  - Press this to stop the disc. (See page 23.)
- 17 SLOW/SEARCH button (▶▶)**
  - Press the button in the play mode to search in the forward direction.
  - Press the button in the still mode for slow play in the forward direction.
- 18 OPEN/CLOSE button (▲)**
  - Press this button to open and close the disc tray.
- 19 Disc number button (1-5)**
  - Press these button to specify which disc you want to play.
- 20 Disc tray (1-5)**
  - Load discs here.
  - Press the OPEN/CLOSE button 18 to open and close the disc tray.
  - The disc tray is also closed when the PLAY button 12 is pressed.
- 21 PHONES jack**
  - Use this to connect separately sold headphones.
- 22 PHONES LEVEL control**
  - Use this to adjust the output level of the headphones jack.

### (2) Rear Panel

- 23 Video output connectors (VIDEO OUT)**
  - Connect using the included video cord.
- 24 S-Video output connectors (S-VIDEO OUT)**
  - Connect using an S-Video connection cord (available in stores).
- 25 Component video output connectors (COMPONENT)**
  - Connect using video cords (available in stores).
- 26 ANALOG OUT connectors**
  - Connect these to the input connectors of an amplifier, etc., to hear the sound of the DVM-3700 over the speakers through the amplifier.
- 27 Digital audio output connector (COAXIAL)**
  - Connect using an audio cord. Connect a commercially available 75 Ω/ohms pin-plug cord.
  - Digital data is output from this connector.
- 28 Digital audio output connector (OPTICAL)**
  - Connect using an optical fiber cable (available in stores).
  - Digital data is output from this connector.
- 29 Remote control input connector (REMOTE CONTROL IN)**
  - This is the input connector for wired remote control. Consult your DENON dealer if you wish to use this connector.
- 30 Remote control output connector (REMOTE CONTROL OUT)**
  - This is the output connector for wired remote control. Consult your DENON dealer if you wish to use this connector.
- 31 Control output connector (CONTROL OUT)**
  - Connect with the REMOTE CONTROL IN connector of a separately sold 100 CD changer (DCM-5000/5001) to control the 100 CD changer from the DVM-3700.
- 32 Power cord**
  - Plug this into a wall power outlet.

(3) Display

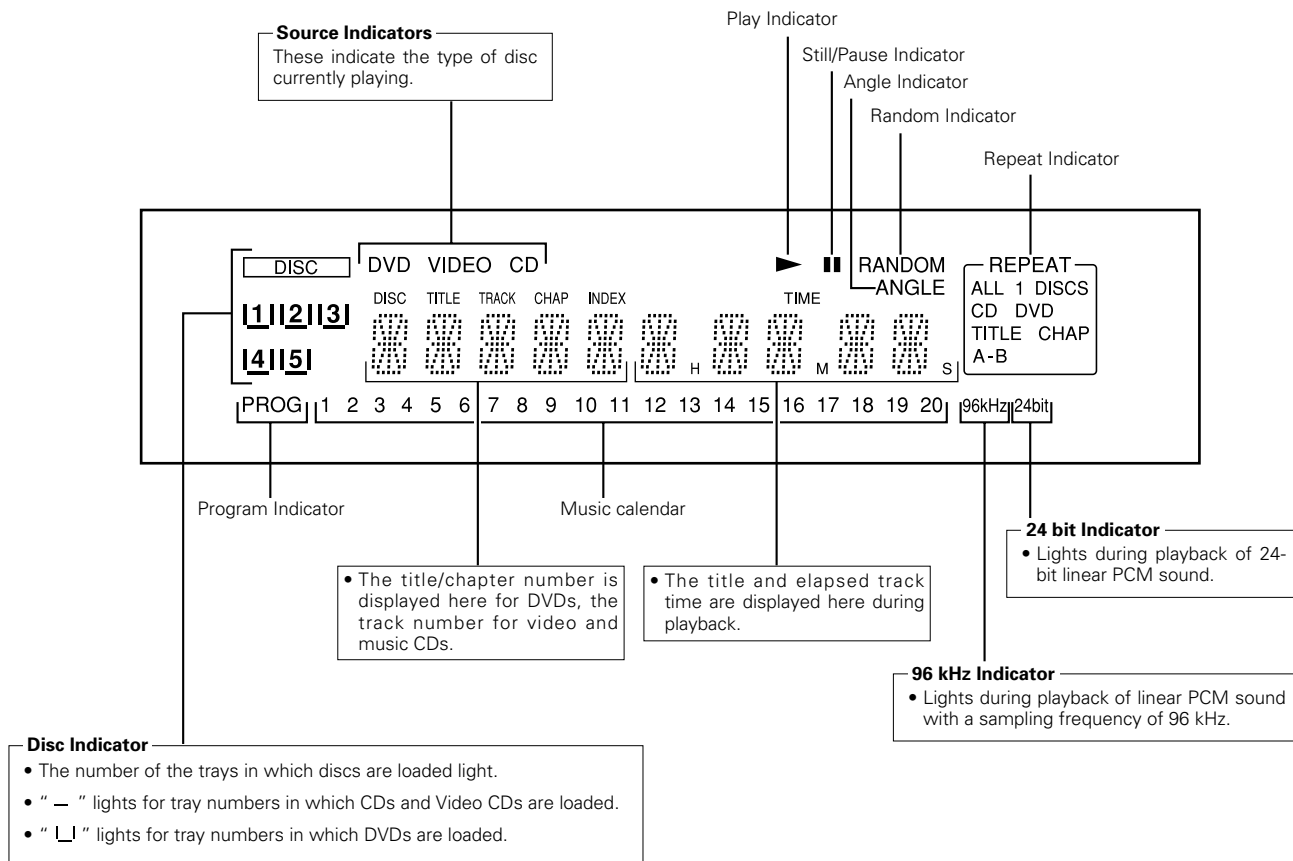



## 6 REMOTE CONTROL UNIT

- The DVM-3700 can be controlled from a distance using the included remote control unit (RC-542).

### (1) Inserting Batteries

- 1 Remove the remote control unit's rear cover.

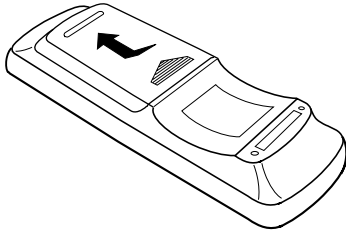

- 2 Place two batteries ("AA" (R6P)) in the battery compartment in the direction indicated by the marks.

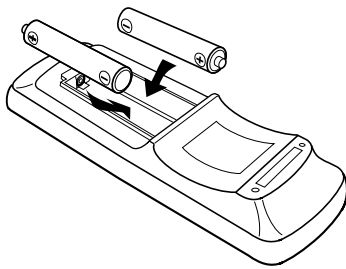

- 3 Close the rear cover.

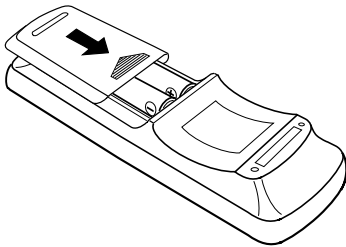

#### Cautions On Batteries

- Use batteries ("AA" (R6P)) in this remote control unit.
- Replace the batteries with new ones approximately once a year, though this depends on the frequency with which the remote control unit is used.
- If the remote control unit does not operate from close to the main unit, replace the batteries with new ones, even if less than a year has passed.
- When inserting the batteries, be careful to do so in the proper direction, following the  $\oplus$  and  $\ominus$  marks in the remote control unit's battery compartment.
- To prevent damage or battery fluid leakage:
  - Do not use a new battery with an old one.
  - Do not use two different types of batteries.
  - Do not short-circuit, disassemble, heat or dispose of batteries in flames.
- Remove the batteries when not planning to use the remote control unit for a long period of time.
- If the batteries should leak, carefully wipe off the fluid from the inside of the battery compartment, then insert new batteries.

### (2) Using the Remote Control Unit

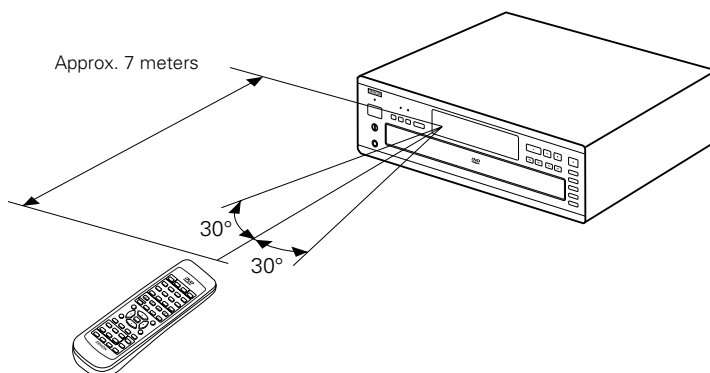

- When operating the remote control unit, point it at the remote control sensor as shown on the diagram.
- The remote control unit can be used from a direct distance of approximately 7 meters. This distance will be shorter, however, if there are obstacles in the way or if the remote control unit is not pointed directly at the remote control sensor.
- The remote control unit can be operated at a horizontal angle of up to 30° with respect to the remote control sensor.

#### NOTES:

- It may be difficult to operate the remote control unit if the remote control sensor is exposed to direct sunlight or strong artificial light.
- Do not press buttons on the main unit and on the remote control unit at the same time. Doing so will result in malfunction.

**(3) Names and Functions of Remote Control Unit Buttons**

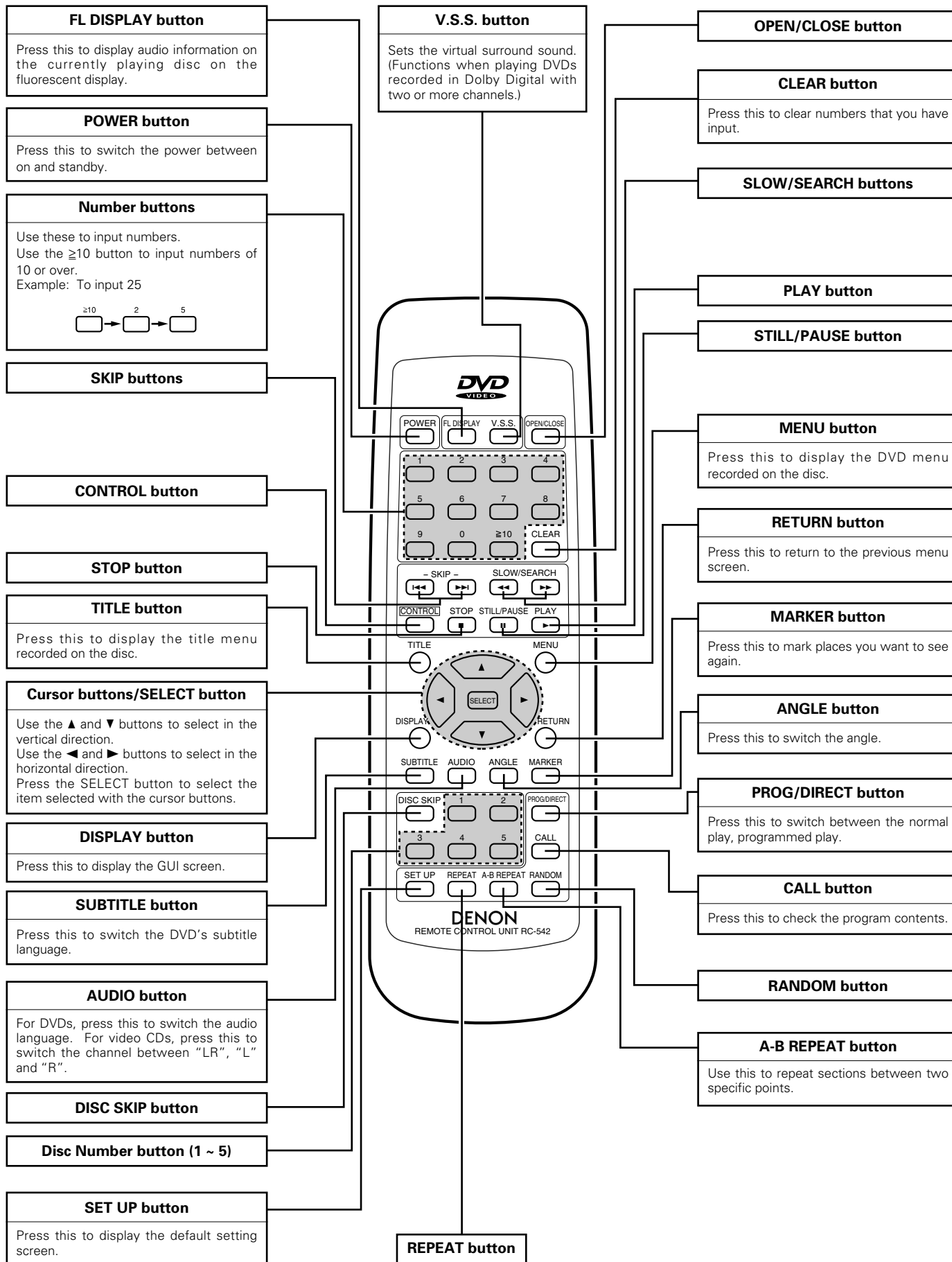

## IMPORTANT SETUP INFORMATION

**This set has the following presettings:** "Disc Languages", "Ratings", "Menu Language", "On-Screen Messages", "FL Display", "TV Aspect", "Digital Audio Output" and "Other Settings".

These presettings have been preset upon shipment from the factory. If you wish to change them to suit your specific purposes, refer to pages 44 to 60.

## 7 LOADING DISCS

- Set discs in the disc tray with the labeled (printed) side facing up.

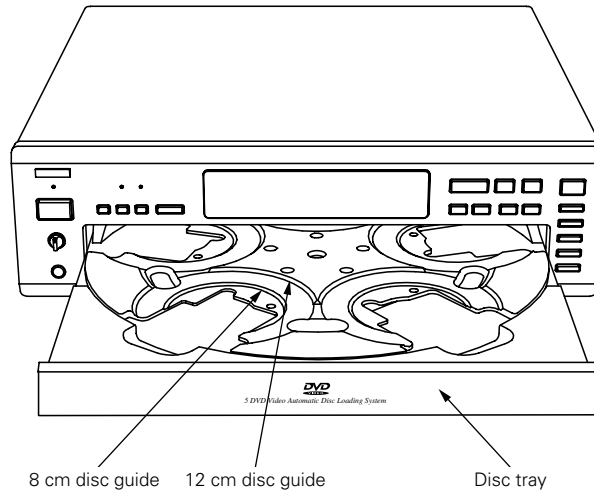

### NOTES:

- Do not move the DVM-3700 while a disc is playing. Doing so may scratch the disc.
- For discs on which both sides can be played, load the disc with the side you want to play facing down.

### (1) Opening and Closing the Disc Tray

- 1 Turn on the power.
- 2 Press the OPEN/CLOSE button.

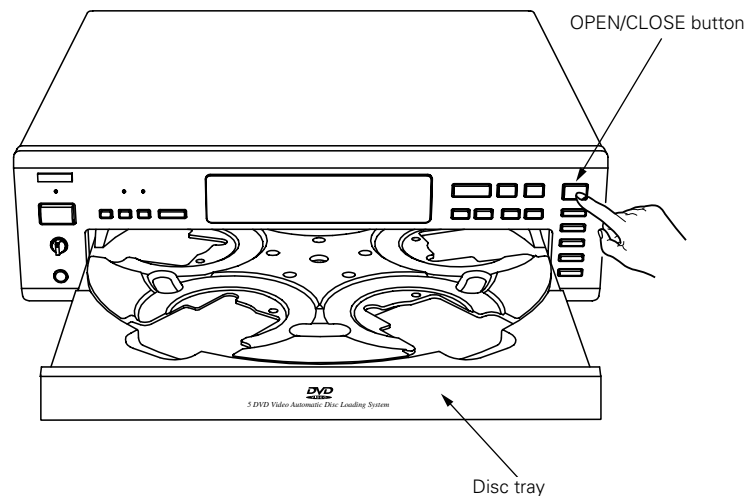

### NOTES:

- Be sure to turn on the power before opening and closing the disc tray.
- Do not strike on the button with a pencil, etc.

## (2) Loading Discs

### How to load a disc

- Make sure the drawer is completely open.
- Hold the disc by the edges and place it on the disc tray. (Do not touch the signal surface, i.e., the glossy side.)
- Set the disc properly in the tray according to its size.  
Set 8 cm discs in the center hole.  
Set 12 cm discs in the outer hole.
- When the drawer is opened during the stop mode, discs can be loaded in the 5 disc trays. If the DISC SKIP button is pressed, the carousel turns and a disc can be loaded in the another disc tray. When the drawer is opened during the play mode, it is possible to load and unload discs in all of the disc trays other than the one whose disc is currently playing. 5 discs can be replaced and press the DISC SKIP button to switch the other disc tray that can be replaced.
- Press the OPEN/CLOSE button (▲) to close the drawer.

### NOTES:

- Remove all discs before moving the player.
- The player will not operate properly and the disc may even be damaged if it is not set correctly.
- If your finger should get caught in the drawer when it closes, press the OPEN/CLOSE button (▲).
- Do not place any foreign objects on the disc tray, and do not place more than one disc on the tray at a time. Otherwise malfunction may occur.
- Do not push in the disc tray manually when the power is off as this may cause malfunction and damage the DVD video auto changer.
- Do not touch the carousel while it is turning. Also, do not turn the carousel by hand when it is stopped. Doing so could damage it.
- Do not insert disc where indicated by arrow. This could damage the internal mechanism in the unit.
- Do not hit the set strongly when a disc is loaded. Doing so may scratch the disc or cause the DVD video auto changer to stop operating.

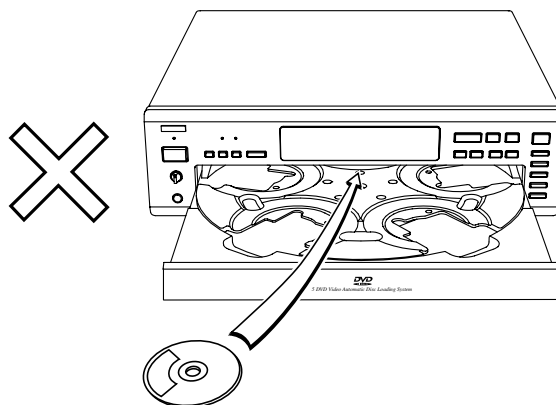
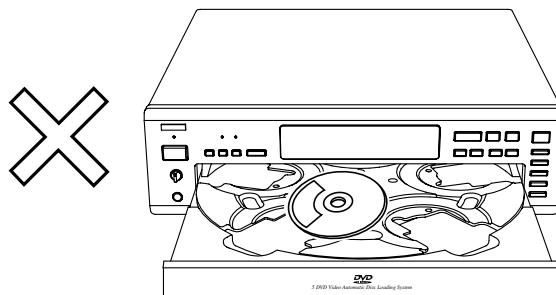
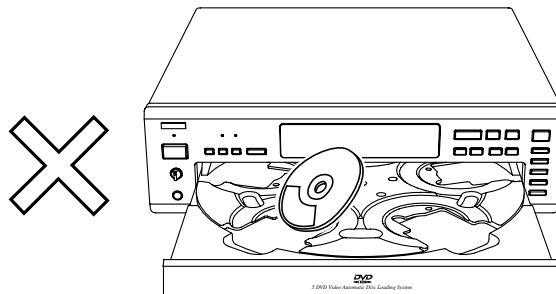
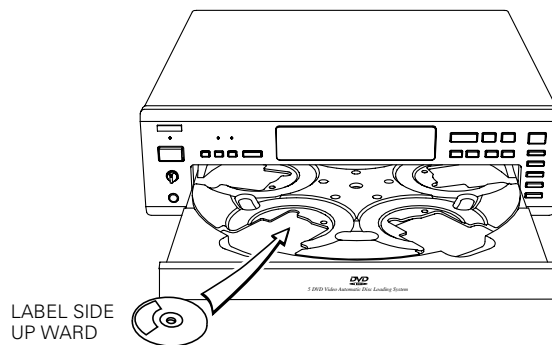

# 8 PLAYBACK

## (1) Playback

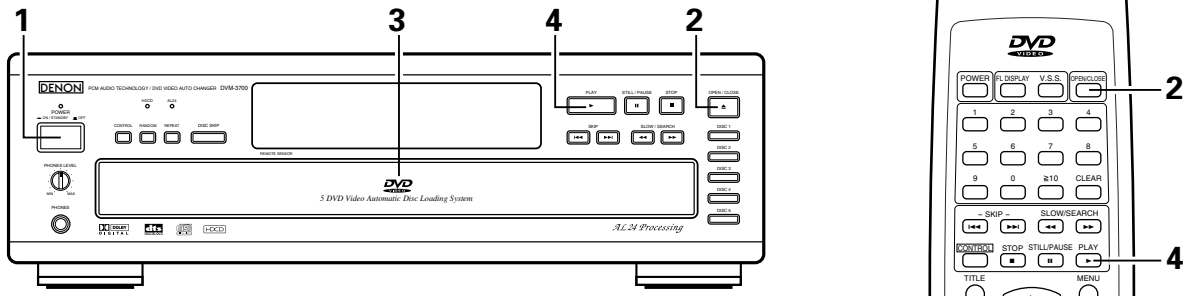

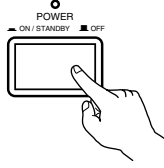
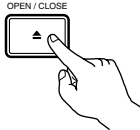
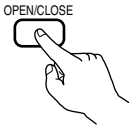
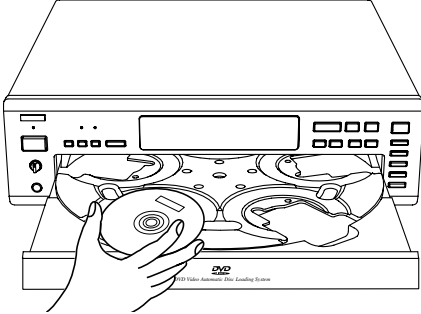
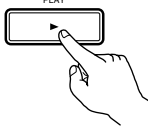
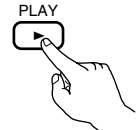
<p><b>1</b></p>	<p>Turn on the power.</p> <ul style="list-style-type: none"> <li>The power indicator lights and the power turns on.</li> </ul>	 <p>Main unit</p>											
<p><b>2</b></p>	<p>Press the OPEN/CLOSE button to open the disc tray.</p>	 <p>Main unit</p>  <p>Remote control unit</p>											
<p><b>3</b></p>	<p>Set the disc to be played in the front side tray.</p>												
<p><b>4</b></p>	<p>Press the PLAY button.</p> <ul style="list-style-type: none"> <li>The disc tray closes automatically and playback begins.</li> <li>If the disc tray is closed with the OPEN/CLOSE button, press the PLAY button.</li> <li>For many interactive DVDs and video CDs with playback control, a menu screen appears. In this case use the procedure in step 5 to select the desired item.</li> <li>* Interactive DVDs are DVDs including multiple angles, stories, etc.</li> <li>* The specified disc can be played by pressing the Disc Number button.</li> </ul>	 <p>Main unit</p> <p>Example: For DVDs with menu screens</p> <div data-bbox="889 1629 1146 1823" style="border: 1px solid black; padding: 5px;"> <p style="text-align: center;"><b>TITLE MENU</b></p> <table border="1" style="width: 100%; text-align: center;"> <tr> <td>Apple</td> <td>Banana</td> </tr> <tr> <td>Orange</td> <td>Strawberry</td> </tr> <tr> <td>Peach</td> <td>Pineapple</td> </tr> </table> </div>  <p>Remote control unit</p> <p>Example: For video CDs with playback control</p> <div data-bbox="1206 1629 1463 1823" style="border: 1px solid black; padding: 5px;"> <table border="1" style="width: 100%; text-align: center;"> <tr><td>1. Opening</td></tr> <tr><td>2. 1st movement</td></tr> <tr><td>3. 2nd movement</td></tr> <tr><td>4. 3rd movement</td></tr> <tr><td>5. Ending</td></tr> </table> </div>	Apple	Banana	Orange	Strawberry	Peach	Pineapple	1. Opening	2. 1st movement	3. 2nd movement	4. 3rd movement	5. Ending
Apple	Banana												
Orange	Strawberry												
Peach	Pineapple												
1. Opening													
2. 1st movement													
3. 2nd movement													
4. 3rd movement													
5. Ending													

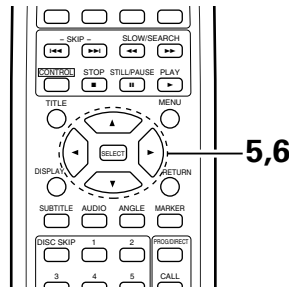

<p><b>5</b></p>	<p>Use the cursor buttons (▲, ▼, ◀ and ▶) to select the desired item.</p> <ul style="list-style-type: none"> <li>• For some discs there is a second menu screen. If so, press the ►► button to display the next menu screen. (See the disc's jacket.)</li> <li>* The cursor buttons (▲, ▼, ◀ and ▶) do not work for video CDs. Use the number buttons to select the desired item.</li> </ul>	<p>Remote control unit</p> <p>Example: When "Apple" is selected</p>
<p><b>6</b></p>	<p>Press the SELECT button.</p> <ul style="list-style-type: none"> <li>• The desired item is selected and playback starts.</li> <li>• You can return to the menu screen by pressing the TITLE/MENU/RETURN button while the DVD is playing, though this depends on the disc.</li> <li>• Press the RETURN button during playback of a video CD to return to the menu screen.</li> </ul>	<p>Remote control unit</p>

**NOTES:**

- If the OPEN/CLOSE (▲) button is pressed while a disc is playing, playback continues, but the drawer opens and four discs can be replaced. The disc that can be replaced switches when the DISC SKIP button is pressed. Press the OPEN/CLOSE (▲) button again to close the drawer.
- If ⓪ appears on the TV screen while buttons are being operated, that operation is not possible on the DVM-3700 or with that disc.
- Set the disc in the disc guide.
- Do not place more than one disc in the disc tray.
- The disc keeps turning while the menu screen is displayed on the TV screen.
- Always press the STOP button if you do not want to keep playing the disc.

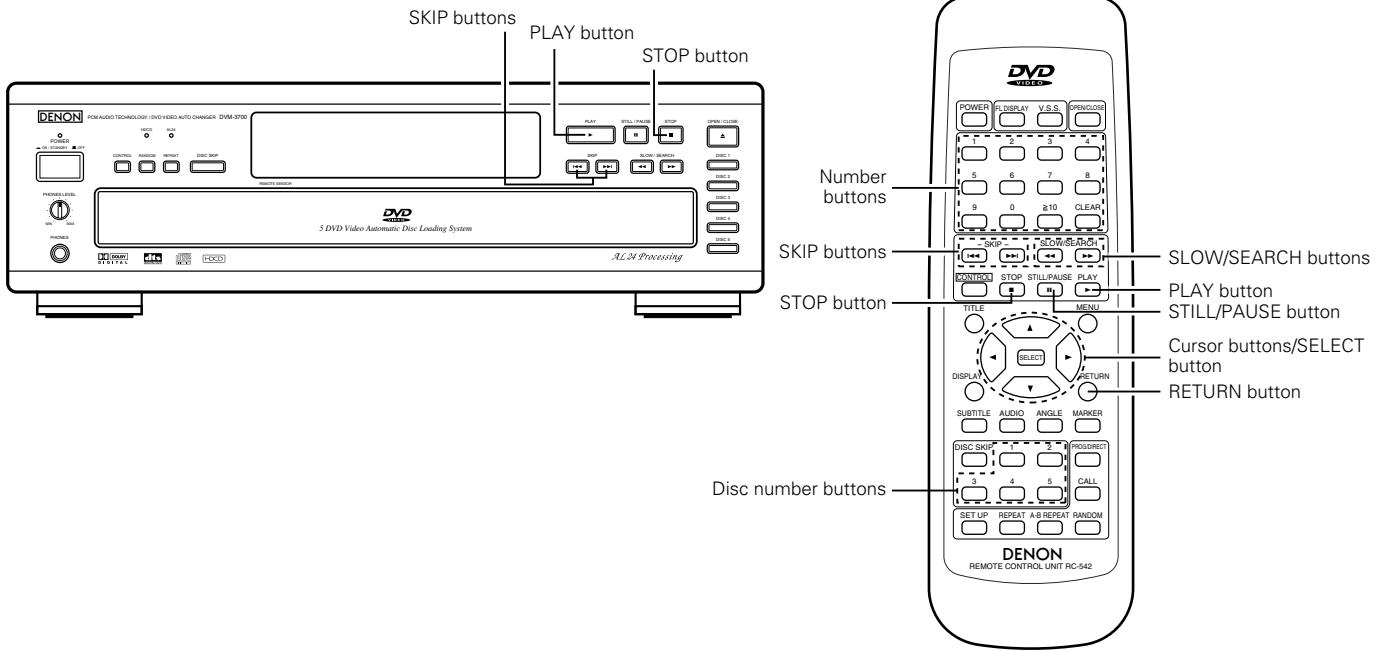

**(2) Stopping Playback**

During playback, press the STOP button.

**RESUME function**

The player records the point where STOP was pressed during play (RESUME function). ("▶" flashes on the player's FL display when this function is activated.)

- Press PLAY again while "▶" flashes, and play will resume from this point.
- When the tray is opened or STOP is pressed again while "▶" flashes, the RESUME function will be cleared.

The RESUME function works only with titles for which the elapsed playing time appears on the player's FL display during playback.

This feature will not be cleared when the player is set to the standby mode and then turned back ON.

**Chapter preview function (DVD only)**

When PLAY is pressed while "▶" flashes, the message shown at right is displayed.

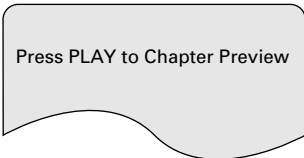

When PLAY is pressed again while the above message is displayed, the first few seconds of each chapter from the beginning of the title up to the point where operation was stopped will be played. This makes it possible to review previously viewed chapters. Normal playback will commence from the point where operation was stopped.

**NOTES:**

- Cancelling the RESUME function will also clear the chapter preview function.
- The chapter preview function may not work with some DVDs.
- After 30 minutes in the stop mode, the DVM-3700's power automatically turns off and the standby mode is set. (Auto Power Off)
- If you do not want to continue playing the disc, to save electricity either press the POWER button on the main to turn the power off or press the POWER button on the remote control unit to set the power to the standby mode.

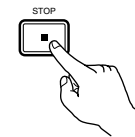

Main unit

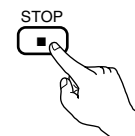

Remote control unit

\* The resume play memory function only works for discs for which the elapsed time is shown on the display during playback.

**(3) Selecting the disc**

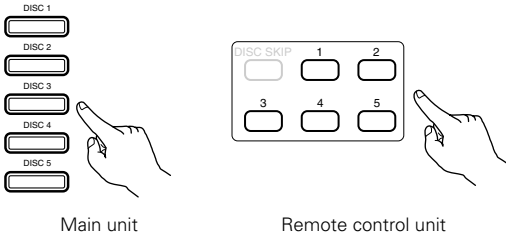
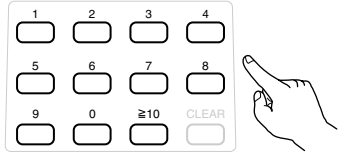
<p><b>1</b></p>	<p>Press the button for the number of the desired disc (1 to 5).</p>	 <p>Main unit                      Remote control unit</p>
<p><b>2</b></p>	<p>Press the number of the desired chapter or track (0 to 10 and <math>\geq 10</math> button).</p>	 <p>Remote control unit</p>

**(4) Selecting DISC SKIP**

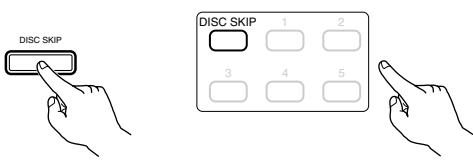
<p>Press the DISC SKIP button.</p> <ul style="list-style-type: none"> <li>The carousel in the dreamer turns and the disc on the next tray is played.</li> <li>For example, if disc number 3 was playing, the disc switches to disc number 4, and if disc number 5 was playing, the disc switches to disc number 1.</li> </ul>	 <p>Main unit                      Remote control unit</p>
---	--

**(5) Playing Still Pictures (Pausing)**

<p>During playback, press the STILL/PAUSE button.</p> <ul style="list-style-type: none"> <li>Press the PLAY button to resume normal playback.</li> </ul>	 <p>Main unit                      Remote control unit</p>
--	---

**(6) Forward/Reverse Searching**

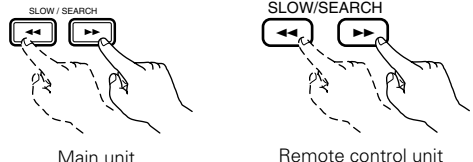
<p>During playback, press one of the SLOW/SEARCH buttons.</p> <p>◀◀ : Reverse direction ▶▶ : Forward direction</p> <ul style="list-style-type: none"> <li>When pressed again, the search speed increases (in five steps).</li> <li>Press the PLAY button to resume normal playback.</li> </ul>	 <p>Main unit                      Remote control unit</p> <div data-bbox="982 1843 1502 1972" style="border: 1px solid black; padding: 5px;"> <p><b>NOTE:</b></p> <ul style="list-style-type: none"> <li>In some cases the menu screen may reappear when one of the SLOW/SEARCH buttons is pressed during menu playback on a video CD.</li> </ul> </div>
--	--



**(7) Skipping to the Beginning of Chapters or Tracks**

During playback, press one of the skip buttons.

◀◀ : Reverse direction  
▶▶ : Forward direction

- A number of chapters or tracks equal to the number of times the button is pressed is skipped.
- When the skip back button is pressed once, the pickup returns to the beginning of the currently playing chapter or track.

Main unit                      Remote control unit

**NOTE:**

- In some cases the menu screen may reappear when one of the SKIP buttons is pressed during menu playback on a video CD.

**(8) Playing Frame by Frame (for DVDs and video CDs only)**

During playback, press the STILL/PAUSE button.

- The picture moves forward one frame each time the button is pressed.
- Press the PLAY button to resume normal playback.

Main unit                      Remote control unit

**(9) Slow Playback (for DVDs and video CDs only)**

In the still mode, press one of the SLOW/SEARCH buttons.

◀◀ : Reverse direction  
▶▶ : Forward direction

- When pressed again, the slow play speed increases (in five steps).
- Press the PLAY button to resume normal playback.

Main unit                      Remote control unit

**NOTE:**

- Reverse slow play is not possible on video CDs.

**(10) Playing Video CDs with Playback Control**  
**Playing Video CDs with Playback Control Without Using the Menu Playback Function**

**1** Press the STOP button while the video CD's menu screen is displayed.

- The display switches from "PBC" to the time display.

**2** Use the number buttons to input the desired track number.

- **To play the disc without using the menu playback function**
- Refer to the disc's jacket, etc., for the track numbers.
- To start playback from the beginning of the disc, press number button "1".
- **Returning to menu playback**
- Press the STOP button to stop playback, then press the MENU button. ("PBC" appears on the display window and the menu screen appears on the TV.) Now perform step 6 on page 22.

Main unit                      Remote control unit

Remote control unit

## 9 USING THE GUI SCREENS

- Use this function to display and change information on the disc (titles, chapters, time, audio, subtitles, angles, etc.) and on the player (repeat, play mode, markers, etc.).

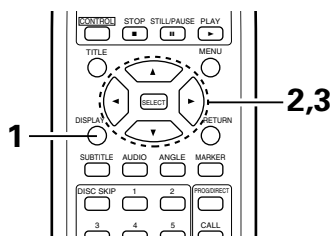

- In the play or stop mode, press the DISPLAY button.
- The GUI (Graphical User Interface) screen appears.
  - The picture on the TV screen switches each time the button is pressed.
  - The items displayed differ from disc to disc.

### For DVDs

- Normal playback screen

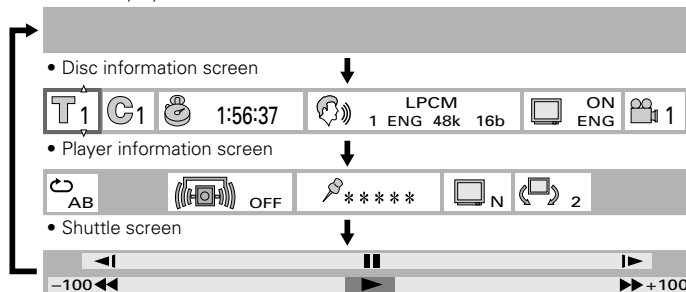

### For Video CD

- Normal playback screen

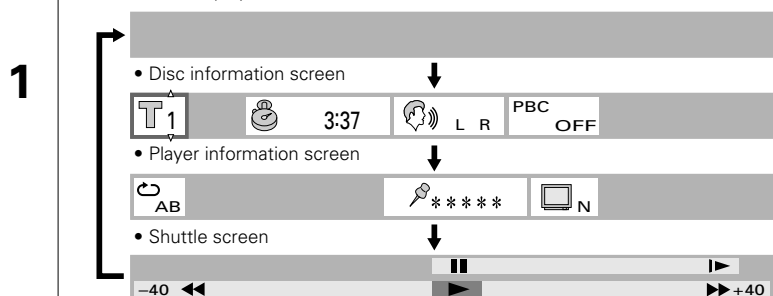

### For CD

- Normal playback screen

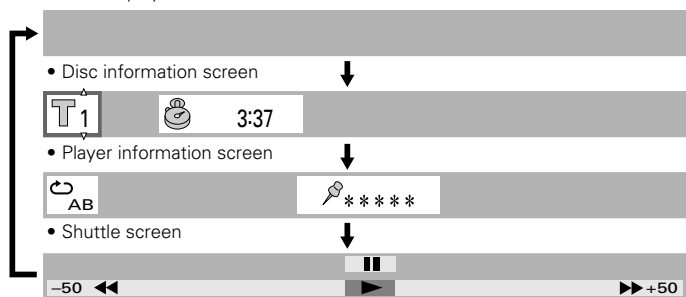

DISPLAY

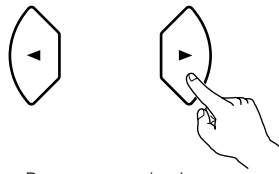
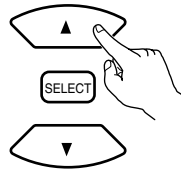

Remote control unit

<b>2</b>	<p>Use the ◀ and ▶ cursor buttons to select the item you wish to change.</p> <ul style="list-style-type: none"> <li>The selected item is displayed with a yellow frame.</li> </ul>	 <p>Remote control unit</p>
<b>3</b>	<p>Use the ▲ and ▼ cursor buttons to change the item.</p> <ul style="list-style-type: none"> <li>Some changes are effective immediately, while some changes are only made after the SELECT or PLAY button is pressed. Also, some functions may not work from the stopped GUI screen.</li> <li>Numbers (for titles, etc.) can be changed using the number buttons. When this is done, press the SELECT button to make the change effective.</li> </ul>	 <p>Remote control unit</p>

**Description of Icons Displayed on the TV Screen (Disc Information Screen)**

■ For DVDs

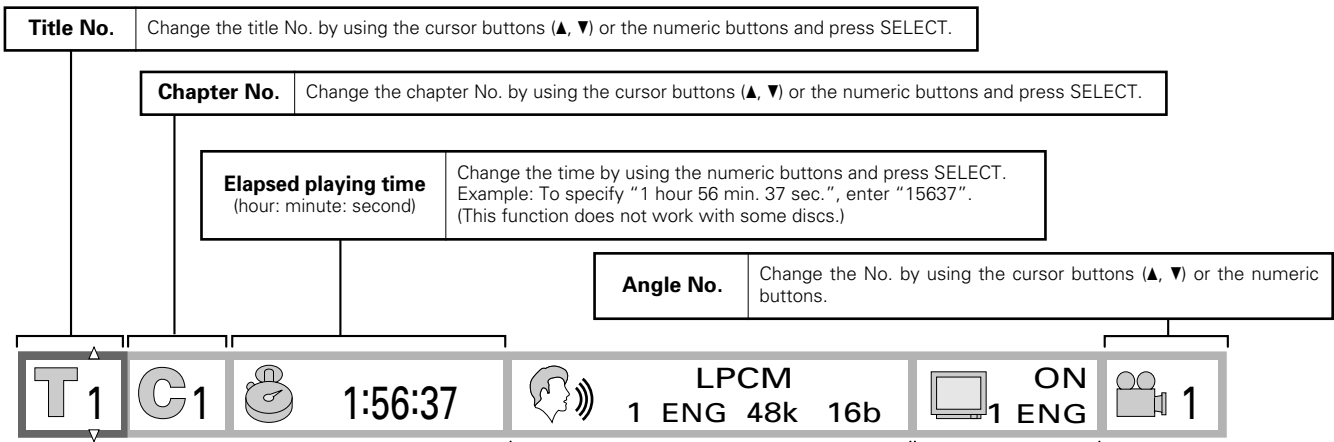

<b>Audio soundtrack language No.</b>	Change the No. by using the cursor buttons (▲, ▼) or the numeric buttons.						
<b>Audio soundtrack language</b>	ENG: English    POR: Portuguese FRA: French    RUS: Russian DEU: German    JPN: Japanese ITA: Italian    CHI: Chinese ESP: Spanish    KOR: Korean NLD: Dutch    MAL: Malay SVE: Swedish    VIE: Vietnamese NOR: Norwegian    THA: Thai DAN: Danish    *: Others						
<b>Audio attribute</b>	LPCM	96k or 48k	<table border="1" style="font-size: small;"> <tr><td style="text-align: center;">16b</td><td rowspan="3">Linear PCM ("k" stands for kHz and "b" stands for bit.)</td></tr> <tr><td style="text-align: center;">20b</td></tr> <tr><td style="text-align: center;">24b</td></tr> </table>	16b	Linear PCM ("k" stands for kHz and "b" stands for bit.)	20b	24b
	16b	Linear PCM ("k" stands for kHz and "b" stands for bit.)					
	20b						
	24b						
		1 ~ 5.1ch	Dolby Digital (AC-3)				
DTS	1 ~ 5.1ch	DTS					
Vocal	--- (OFF) ON	DVD karaoke (Solo)					
Vocal	--- (OFF) V1 + V2 V1 V2	DVD karaoke (Duet)					

<b>Subtitle language No.</b>	Change the No. by using the cursor buttons (▲, ▼) or the numeric buttons.	
<b>Subtitle language</b>	ENG: English    POR: Portuguese FRA: French    RUS: Russian DEU: German    JPN: Japanese ITA: Italian    CHI: Chinese ESP: Spanish    KOR: Korean NLD: Dutch    MAL: Malay SVE: Swedish    VIE: Vietnamese NOR: Norwegian    THA: Thai DAN: Danish    *: Others	
<b>Subtitle on/off</b>	Select "ON" or "OFF" by using the cursor buttons (▲, ▼).	
	OFF	Subtitle is cleared.
	ON	Subtitle is displayed.

**NOTE:**

- "▲ ▼" around the icon means that the item can be changed using the cursor buttons (▲, ▼).

▲  
T 1  
▼

■ For video and music CDs

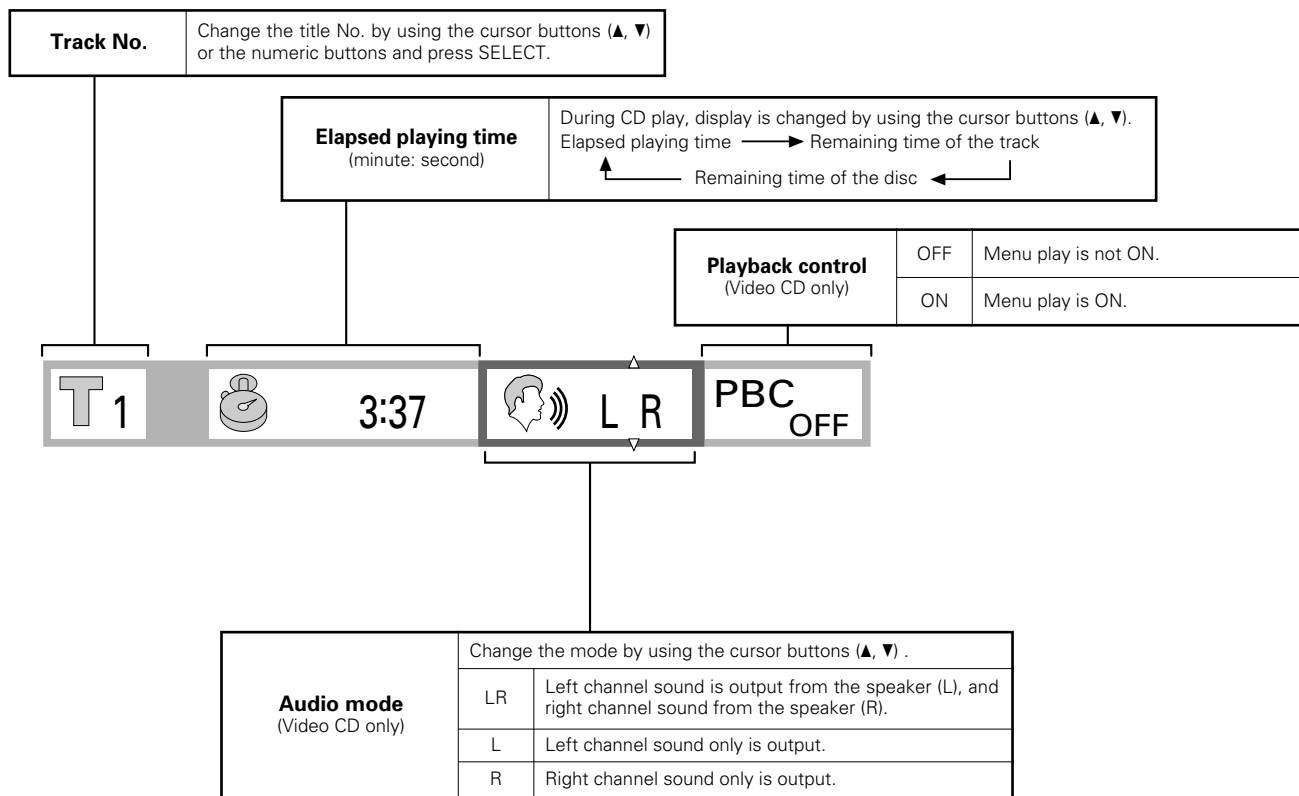

**NOTES:**

- Track No. and the elapsed playing time are not displayed during menu play of Video CDs with playback control.
- It is not possible to turn playback control ON or OFF using the On-Screen Menu Icons.
- “▲ ▼” around the icon means that the item can be changed using the cursor buttons (▲, ▼).

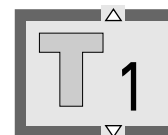

**Description of Icons Displayed on the TV Screen (Player Information Screen)**

**Markers**  
 Press SELECT during play and press SELECT again at the preferred point to store a marker. (Marker no. is displayed instead of " \* ".)  
 • To recall a marker, select the preferred marker no. by using the cursor buttons (◀, ▶) and enter the selection using the cursor button (▲).  
 • To clear a marker, select the preferred marker no. using the cursor buttons (◀, ▶) and press CLEAR.

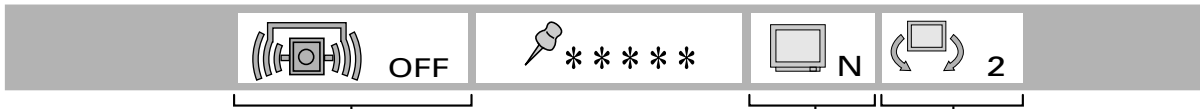

<ul style="list-style-type: none"> <li><b>DVD Dialogue Enhancer</b></li> </ul> OFF	Select the preferred mode during play by using the cursor buttons (▲, ▼).	
	OFF	Normal volume
	ON	Louder volume

<b>Virtual Surround Sound (V.S.S.)</b> (DVD only)	Select the preferred mode during play by using the cursor buttons (▲, ▼).	
	OFF	V.S.S. off
	1	V.S.S. natural effect
	2	V.S.S. emphasized effect

<b>Digital Cinema Mode</b> (DVD/Video CD only)	Select the preferred mode by using the cursor buttons (▲, ▼) and press SELECT.			
	<b>N</b>	<b>Normal mode</b>	<b>F</b>	<b>Fine mode</b>
	<b>S</b>	<b>Soft mode</b>	<b>C</b>	<b>Cinema mode</b>
	<b>U</b>	<b>User selection mode</b> (Adjust the picture quality as you like.) When "U" is selected and SELECT is pressed, the On-Screen Menu Icon as shown below appears.		
	Contrast (+7 to -7)    Contrast hue (+7 to -7)    Equalizer (+1/0/-1)    Brightness (0 to 15)			
	Select the preferred item by using the cursor buttons (◀, ▶) and select the preferred value by using the cursor buttons (▲, ▼).			

**NOTES:**

- Marker functions do not work with an interactive DVD or during menu play of a Video CD with playback control.
- It is not possible to change the play mode using the On-Screen Menu Icons.

**Description of Icons Displayed on the TV Screen (Shuttle Screen)**

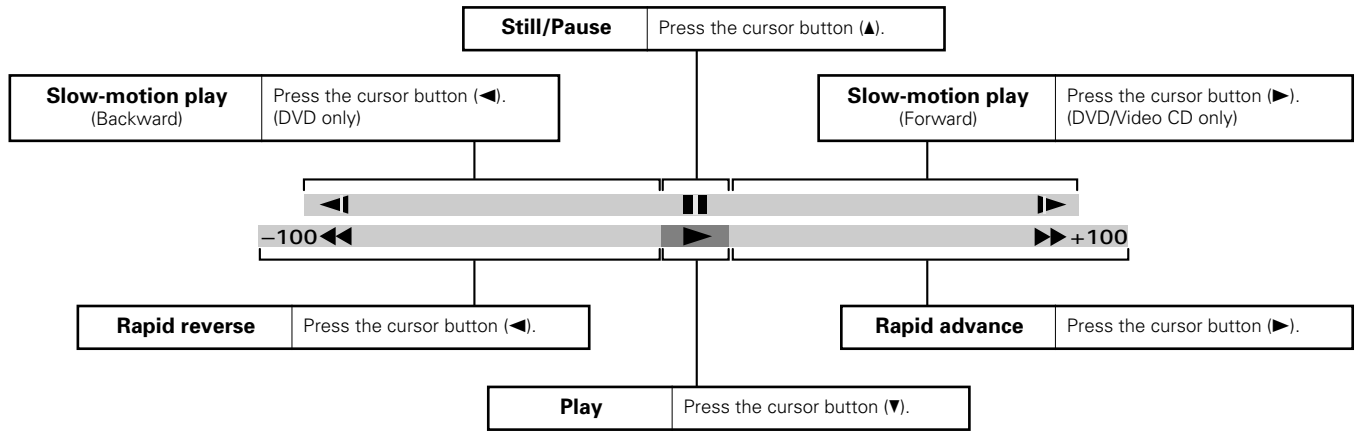

**NOTES:**

- Each time the cursor button (◀, ▶) is pressed, the speed of rapid reverse/advance and slow-motion play increases up to 5 steps.
- The figures appearing at both ends of the shuttle screen stand for the maximum speeds of rapid reverse and rapid advance. (DVD: +100/-100, Video CD: +40/-40, CD: +50/-50)

# 10 MARKING SCENES YOU WANT TO SEE AGAIN

■ Set marks at scenes you want to see again so that you can start playback from the marked position whenever you want.

## Setting Marks

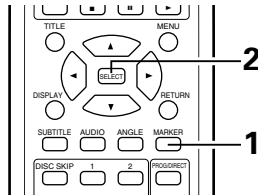

<b>1</b>	<p>During playback, press the MARKER button.</p> <ul style="list-style-type: none"> <li>The marker screen appears.</li> <li>"*" is displayed if the mark is not set.</li> </ul>	<p>Remote control unit</p>
<b>2</b>	<p>Press the SELECT button at the scene you want to mark.</p> <ul style="list-style-type: none"> <li>A number is displayed.</li> <li>Up to five marks can be set.</li> <li>If the SELECT button is pressed at a position at which a number is displayed, the previously marked scene is unmarked and the new scene is marked.</li> </ul>	<p>Remote control unit</p>

**NOTES:**

- In some cases, subtitles may not be displayed at marked spots.
- The marking function cannot be used for DVDs and video CDs for which the elapsed time is not shown on the display during playback.
- The marks are retained until the power is turned off or the disc is ejected.
- The mark settings will be cleared when changing from the specified disc to a disc of a different disc number, or when the power is set to the standby mode.

## Calling Out Marked Scenes and Clearing Marks

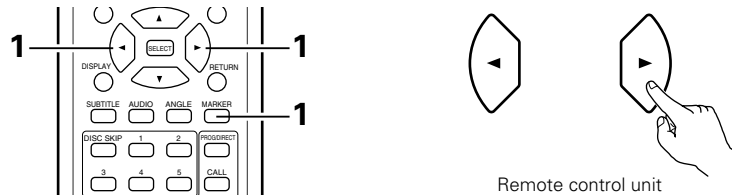

<b>1</b>	<p>Use the ◀ and ▶ cursor buttons to select the mark number.</p> <ul style="list-style-type: none"> <li>If the marker screen is not displayed during playback, press the MARKER button to display it.</li> </ul>	
<p>* To play from the selected mark number: Press the ▲ cursor button. The disc returns to the selected mark and playback starts.</p> <p>* Clearing the selected mark number: Press the CLEAR button. The selected mark is cleared.</p>		

# 11 PLAYING REPEATEDLY

■ Use this function to play your favorite audio or video sections repeatedly.

## Playing Repeatedly (Repeat Playback)

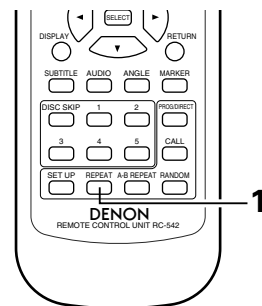
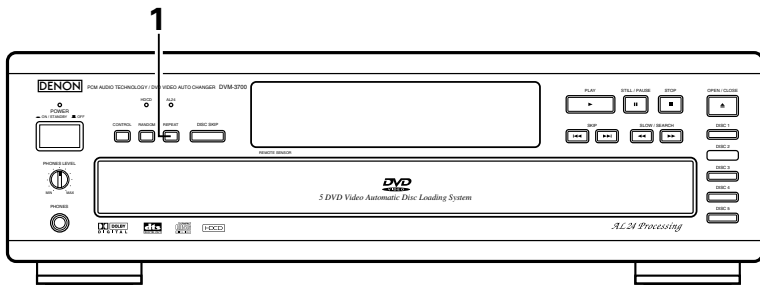

During playback, press the REPEAT button.

1 For DVDs (When the display's DVD indicator is lit)

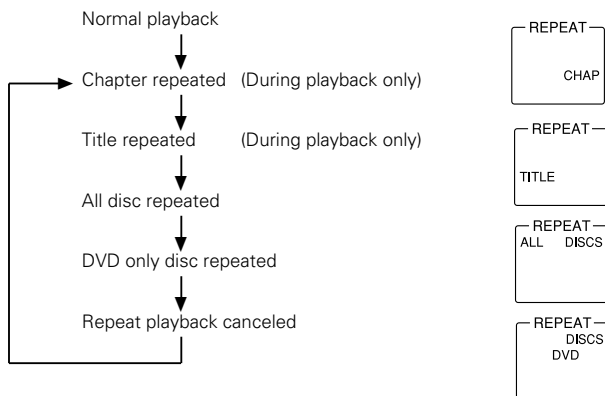

2 For video and music CDs (When the display's VIDEO CD or CD indicator is lit)

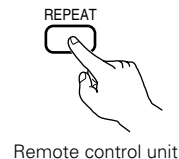
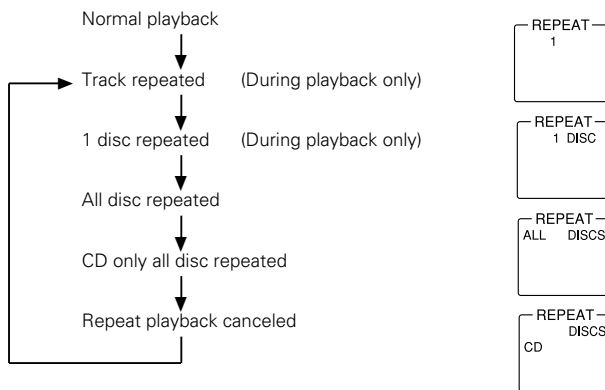

\* To return to normal playback:  
Press the REPEAT button until the display's "REPEAT" indicator turns off to return to the normal play mode.

**NOTES:**

- If neither the DVD, the VIDEO CD nor the CD indicator is lit, the mode switches in the following order each time the REPEAT button is pressed:  
Normal play back / All disc repeated / DVD only all disc repeated / CD only all disc repeated / Repeat playback canceled
- Repeat play may not work correctly with some DVDs.
- Repeat play does not work with an interactive DVD or during menu play of a Video CD with playback control.



**Playing a Certain Section Repeatedly (A-B Repeat Playback)**

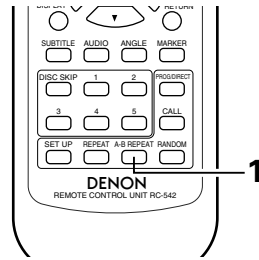

<b>1</b>	<p>During playback, press the A-B button.</p> <ul style="list-style-type: none"> <li>This sets start point A.</li> </ul>	<div style="border: 1px solid black; padding: 5px; width: fit-content; margin: 0 auto;"> <p style="text-align: center;">REPEAT</p> <p style="text-align: center;">A-</p> </div>
<b>2</b>	<p>Press the A-B button again.</p> <ul style="list-style-type: none"> <li>This sets end point B, and repeat playback of the A-B section starts.</li> </ul>	<div style="border: 1px solid black; padding: 5px; width: fit-content; margin: 0 auto;"> <p style="text-align: center;">REPEAT</p> <p style="text-align: center;">A-B</p> </div>
<p>* To return to normal playback: Press the A-B REPEAT button until the display's "REPEAT" indicator turns off.</p>		

**NOTES:**

- A-B repeat play does not work with an interactive DVD.
- Some subtitles recorded around point A or B may fail to appear. [DVD]
- A-B repeat play works only within a title [DVD] or a track [Video CD/CD].



**Setting the Repeat Play Mode During Programmed Playback**

When the REPEAT button is pressed during programmed playback, repeat playback of the entire program starts and the REPEAT indicator lights. Press the REPEAT button until the display's REPEAT indicator turns off to return to normal programmed playback.

## 12 PLAYING TRACKS IN THE DESIRED ORDER

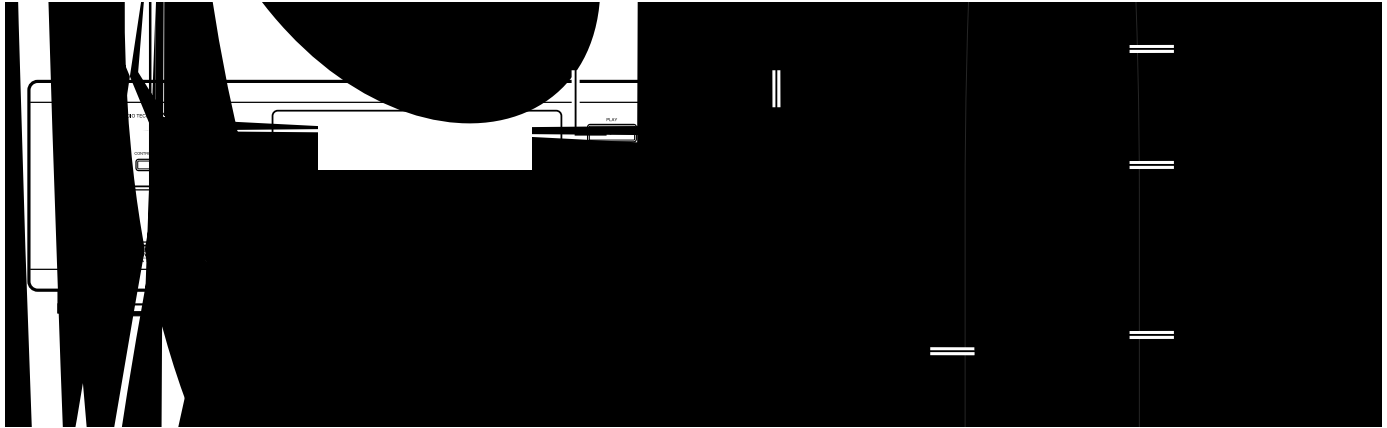
- Use this function with video and music CDs to play the tracks in the desired order. (This function will not work for DVDs.)
- Up to 32 tracks can be set in a program.

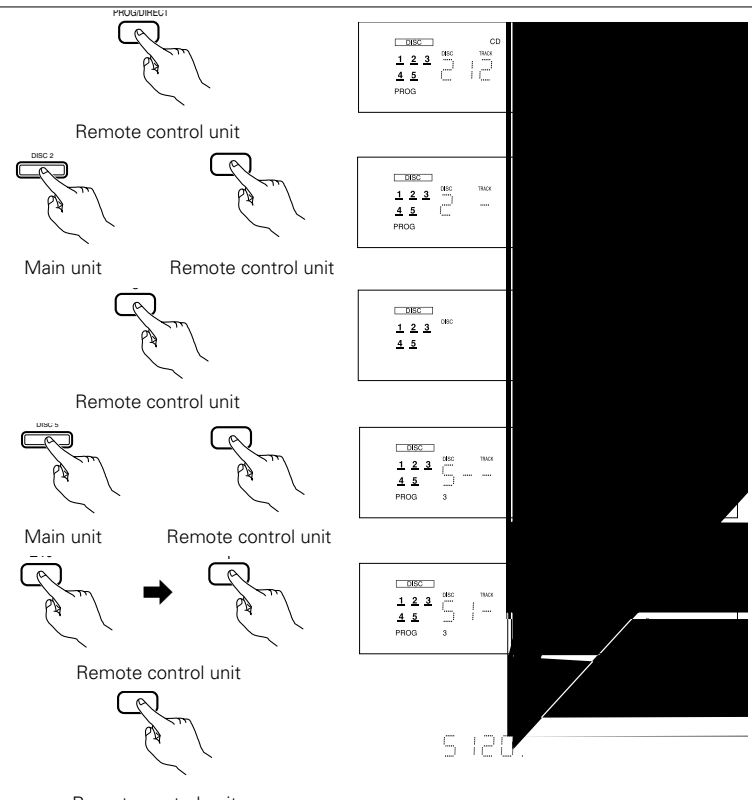

<p><b>1</b></p>	<p>In the stop mode, press the PROG/DIRECT button on the remote control unit.</p> <ul style="list-style-type: none"> <li>• The "PROG" indicator lights on the display.</li> </ul>	 <p>Remote control unit</p>
<p><b>2</b></p>	<p>Select the track using the disc number buttons (DISC1 to DISC5) on the main unit or the remote control unit and the number buttons on the remote control unit.</p> <ul style="list-style-type: none"> <li>• <b>Ex: To program track 3 on disc 2 and track 12 on disc 5:</b></li> </ul> <p>Press the PROG/DIRECT button.</p> <p>↓</p> <p>Press DISC2 (disc number button).</p> <p>↓</p> <p>Press 3 (number button).</p> <p>↓</p> <p>Press DISC5 (disc number button).</p> <p>↓</p> <p>Press ≥10 (number button).</p> <p>↓</p> <p>Press 1 (number button).</p> <p>↓</p> <p>Press 2 (number button).</p>	 <p>Remote control unit</p> <p>Main unit Remote control unit</p> <p>Remote control unit</p> <p>Main unit Remote control unit</p> <p>Remote control unit</p> <p>Remote control unit</p>
<p><b>3</b></p>	<p>Press the PLAY button.</p> <ul style="list-style-type: none"> <li>• Play now begins in the programmed sequence.</li> </ul>	 <p>Main unit Remote control unit</p>
<p>* To return to normal playback: Press the STOP button to stop programmed playback, then press the PROG/DIRECT button. Now press the PLAY button to start normal playback from the beginning of the disc. The program is stored in the memory.</p> <p>* To clear tracks from the program: Press the STOP button twice. Press the CLEAR button to clear the last track in the program.</p> <p>* To clear the entire program: The entire program is cleared when the power is turned off or when the PROG/DIRECT button is pressed.</p>		

**NOTES:**

- The programmed track numbers on the disc of the displayed disc number appear lit on the music calendar.
- Programming is not possible for DVDs.
- The PROG/DIRECT button does not function when DVDs are loaded in all five trays.
- The PROG/DIRECT button does not function during normal playback or programmed playback.
- The PROG/DIRECT button does not function when the tray is open and neither the DVD, the VIDEO CD nor the CD indicator is lit.
- When the PROG/DIRECT button is pressed in the all disc repeat or CD all disc repeat mode, the all programmed repeat mode is set.

### 13 PLAYING THE TRACKS IN RANDOM ORDER

■ Use this function with video and music CDs to play the tracks in random order. (This function will not work for DVDs.)

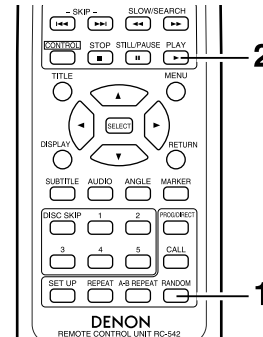
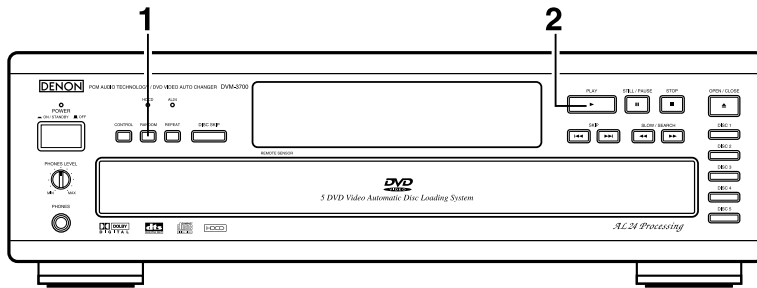

<p><b>1</b></p>	<p>In the stop mode, press the RANDOM button.</p> <ul style="list-style-type: none"> <li>• The display's RANDOM indicator lights.</li> </ul>	
<p><b>2</b></p>	<p>Press the PLAY button.</p> <ul style="list-style-type: none"> <li>• The tracks start playing in random order.</li> </ul>	
<p>* When random playback ends: The stop mode is set and the random play screen reappears.</p> <p>* To return to normal playback: Press the STOP button to stop random playback, then press the RANDOM button.</p> <p>* To set the disc sequential random play mode: Press the RANDOM button and specify the disc numbers (1 to 5) with the DISC SKIP button and the number buttons. A press of the PLAY (▶ PLAY) button will result in the player randomly selecting and playing tracks on the disc in the order of specified discs. Up to 5 discs can be selected, and the same disc can be selected, two or more times. Disc sequential random play is cancelled when play ends.</p> <p>* To set the program random play mode: After pressing the PROG/DIRECT button and inputting a program (See item 12 on page 34), press the Random button, then the Play button. The microcomputer will then select tracks from the program at random and play them.</p>		

**NOTES:**

- The RANDOM button does not function in the play mode.
- The RANDOM button does not function when DVDs are loaded in all five trays.
- The RANDOM button does not function when the tray is open and neither the DVD, the VIDEO CD nor the CD indicator is lit.
- When the RANDOM button is pressed in the all disc repeat or CD all disc repeat mode, the random all repeat mode is set. RANDOM (REPEAT) will appear lit on the display at this time.

# 14 100 CD CHANGER CONTROL FUNCTION

■ A separately sold 100 CD changer (DCM-5000/5001) can be connected to the DVM-3700 and operated from the DVM-3700.

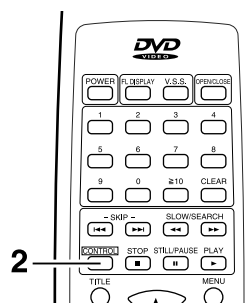
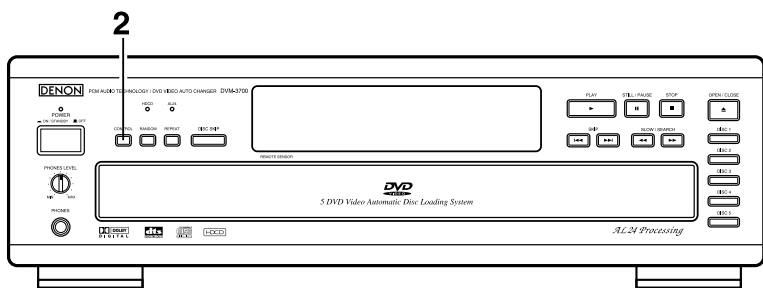

<p><b>1</b></p>	<p>Connect the DVM-3700's CONTROL OUT connector to the REMOTE CONTROL IN connector on the 100 CD changer (DCM-5000/5001).</p> <ul style="list-style-type: none"> <li>Use a commercially available mini-plug cord (monaural).</li> </ul>	
<p><b>2</b></p>	<p>Press the CONTROL button.</p> <ul style="list-style-type: none"> <li>"CONTROL" appears on the display.</li> </ul>	<p>Main unit      Remote control unit</p>
<p><b>3</b></p>	<p>Press the buttons on the DVM-3700 or the remote control unit.</p> <ul style="list-style-type: none"> <li>When one of the buttons on the DVM-3700 or the remote control unit shown on the table below is pressed, the DCM-5000/5001 operates in the same way as when the corresponding button on the DCM-5000/5001 is pressed.</li> </ul>	

DVM-3700	DCM-5000/5001
PLAY	PLAY
STILE / PAUSE	PAUSE
STOP	STOP
⏮, ⏭	⏮, ⏭
DISC SKIP	DISC SKIP +
SELECT	ENTER
0 ~ 9	0 ~ 9
▲, ▼, ◀, ▶	↑, ↓, ←, →

**NOTES:**

- Wait at least 15 seconds after turning on the power of the 100 CD changer (DCM-5000/5001) before performing this operation.
- Buttons not indicated on the above table do not operate.

# 15 USING THE MULTIPLE AUDIO, SUBTITLE AND ANGLE FUNCTIONS

## Switching the Audio Language (Multiple Audio Function)

■ With DVDs containing multiple audio language signals, the audio language can be switched during playback.

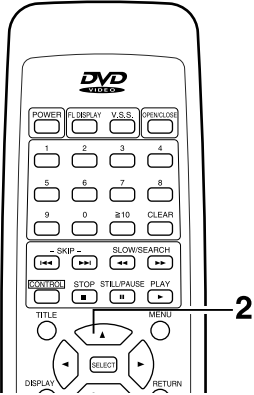

<p><b>1</b></p> <p>During playback, press the AUDIO button.</p> <ul style="list-style-type: none"> <li>• The current audio language number is displayed.</li> <li>• If no sound is recorded on the disc, "--" is displayed.</li> </ul>		<p>Remote control unit</p>	<p>LPCM 1 ENG 48k 16b</p> <p>Hello</p>
<p><b>2</b></p> <p>Use the ▲ and ▼ cursor buttons to select the desired language.</p> <ul style="list-style-type: none"> <li>• The display turns off when the AUDIO or SELECT button is pressed.</li> </ul>		<p>Remote control unit</p>	<p>LPCM 3 FRA 48k 16b</p> <p>Bonjour</p>

**NOTES:**

- If the desired language is not set after pressing the ▲ and ▼ cursor buttons several times, the disc does not include that language.
- The audio language set with the default settings (see page 45) is set when the power is turned on and when the disc is replaced. If that language is not included on the disc, the disc's default language is set.

Switching vocals ON or OFF for Karaoke discs (DVD/Video CD)

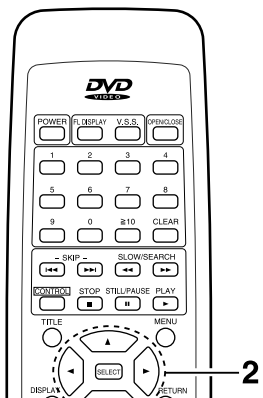

<p><b>1</b></p>	<p>Press AUDIO during play.</p>	<p>Remote control unit</p>
<p><b>2</b></p>	<p>Press the cursor buttons (▲, ▼, ◀, ▶) until the preferred setting is selected.</p> <ul style="list-style-type: none"> <li>• <b>DVD Karaoke (Solo)</b> (◀, ▶) ----(OFF) ↔ ON</li> <li>• <b>DVD Karaoke (Duet)</b> (◀, ▶) ----(OFF) → 1+2 (ON) → V1 (ON) → V2 (ON)</li> <li>• <b>Video CD</b> (▲, ▼) ----LR → L → R</li> </ul> <p>Press AUDIO or SELECT to clear the display</p>	<p>Remote control unit</p>

**NOTES:**

- This operation does not work with CDs.
- The vocals from the digital audio output connector cannot be switched by this operation.

**Switching the Subtitle Language (Multiple Subtitle Function)**

- With DVDs containing multiple subtitle language signals, the subtitle language can be switched during playback.

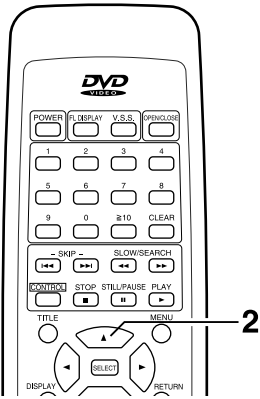

<p><b>1</b></p>	<p>During playback, press the SUBTITLE button.</p> <ul style="list-style-type: none"> <li>• The current subtitle language number is displayed.</li> <li>• If no subtitles are recorded on the disc, "--" is displayed.</li> </ul>	<p>Remote control unit</p>
<p><b>2</b></p>	<p>Use the ▲ and ▼ cursor buttons to select the desired language.</p> <ul style="list-style-type: none"> <li>• The display turns off when the SUBTITLE or SELECT button is pressed.</li> <li>• Use the ◀ and ▶ cursor buttons to turn the subtitles "ON" and "OFF".</li> </ul>	<p>Remote control unit</p>

**NOTES:**

- If the desired language is not set after pressing the ▲ and ▼ cursor buttons several times, the disc does not include that language.
- The subtitle language set with the default settings (see page 45) is set when the power is turned on and when the disc is replaced. If that language is not included on the disc, the disc's default language is set.
- When the subtitle language is changed, several seconds may be required for the new language to appear.
- When a disc supporting the closed caption is played, the subtitle and the closed caption may overlap each other on the TV monitor. In this case, turn the subtitle off.

### Switching the Angle (Multiple Angle Function)

- With DVDs containing multiple angle signals, the angle can be switched during playback.

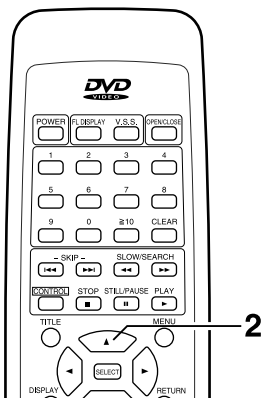

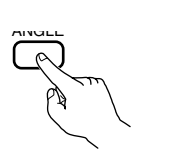
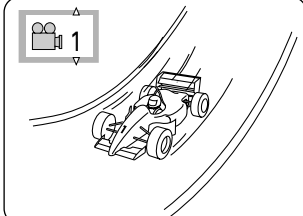
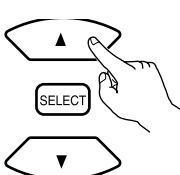
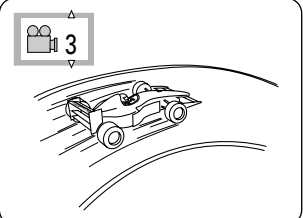
<p><b>1</b></p>	<p>During playback, press the ANGLE button.</p> <ul style="list-style-type: none"> <li>The current angle number is displayed.</li> </ul>	 <p>Remote control unit</p> 
<p><b>2</b></p>	<p>Use the ▲ and ▼ cursor buttons or the number buttons to select the desired angle.</p> <ul style="list-style-type: none"> <li>The display turns off when the ANGLE or SELECT button is pressed.</li> </ul>	 <p>Remote control unit</p> 

**NOTES:**

- The multiple angle function only works with discs on which multiple angles are recorded.
- At scenes where multiple angles are recorded, the angle can be switched.
- Even at scenes where multiple angles are not recorded, the angle number can be preset. In this case the angle switches to the preset angle once a scene at which multiple angles are recorded is reached.



**Reproducing an Advanced Virtual Surround Sound effect [ Dolby Digital (AC-3) DVD ]**

- This player can reproduce a virtual surround sound effect which provides sound as if heard from the front speakers located at the horizontally further position or heard from nonexistent speakers even when only a 2-channel stereo system is connected [for playback of Dolby Digital DVD software (2ch and above) only].

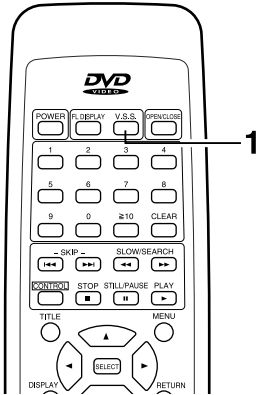

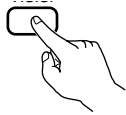
<b>1</b>	<p>Press V.S.S. during play. Each time this button is pressed, the player's FL display changes:</p> <p style="text-align: center;">Virtual surround sound is cancelled</p> <div style="text-align: center; border: 1px solid gray; background-color: #cccccc; padding: 5px; width: fit-content; margin: 0 auto;">V'SS OFF</div> <p style="text-align: center;">↓</p> <p style="text-align: center;">Virtual surround sound 1 (Natural effect)</p> <div style="text-align: center; border: 1px solid gray; background-color: #cccccc; padding: 5px; width: fit-content; margin: 0 auto;">V'SS 1</div> <p style="text-align: center;">↓</p> <p style="text-align: center;">Virtual surround sound 2 (Emphasized effect)</p> <div style="text-align: center; border: 1px solid gray; background-color: #cccccc; padding: 5px; width: fit-content; margin: 0 auto;">V'SS 2</div> <p style="text-align: center;">↶</p>	 <p>Remote control unit</p>
----------	---	---

**NOTES:**



- The virtual surround sound effect does not work with DVD Karaoke discs.
- The virtual surround sound effect may not work with some Dolby Digital 2.1ch or 3.1ch DVDs. Additionally, this effect may not work properly with some Dolby Digital DVDs other than 2.1ch or 3.1ch, depending on the software.
- Turn off the TV surround sound and other surround sound effects when using this virtual surround sound effect.

# 16 USING THE MENUS

## Using the Title Menu

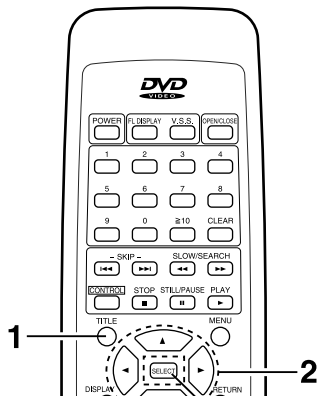
■ For DVDs containing multiple titles, the desired title can be selected and played from the title menu.

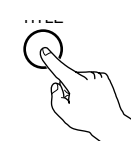
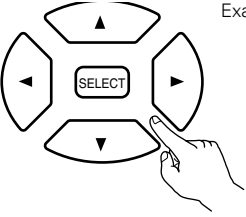

<p><b>1</b></p>	<p>During playback, press the TITLE button.</p> <ul style="list-style-type: none"> <li>The title menu appears.</li> <li>If the TITLE button is pressed again, the disc returns to the point at which the title menu was called out and playback resumes from that point.</li> </ul>	 <p>Remote control unit</p> <p>Example:</p> <table border="1" data-bbox="1242 765 1502 959"> <tr><th colspan="2">TITLE MENU</th></tr> <tr><td>Apple</td><td>Banana</td></tr> <tr><td>Orange</td><td>Apple</td></tr> <tr><td>Peach</td><td>Pineapple</td></tr> </table>	TITLE MENU		Apple	Banana	Orange	Apple	Peach	Pineapple
TITLE MENU										
Apple	Banana									
Orange	Apple									
Peach	Pineapple									
<p><b>2</b></p>	<p>Use the cursor or number buttons to select the desired title.</p> <ul style="list-style-type: none"> <li>If you select the title number using the number buttons, skip step 3 below.</li> </ul>	 <p>Remote control unit</p> <p>Example: When "Orange" is selected</p> <table border="1" data-bbox="1242 1024 1502 1218"> <tr><th colspan="2">TITLE MENU</th></tr> <tr><td>Apple</td><td>Banana</td></tr> <tr><td>Orange</td><td>Strawberry</td></tr> <tr><td>Peach</td><td>Pineapple</td></tr> </table>	TITLE MENU		Apple	Banana	Orange	Strawberry	Peach	Pineapple
TITLE MENU										
Apple	Banana									
Orange	Strawberry									
Peach	Pineapple									
<p><b>3</b></p>	<p>Press the SELECT button.</p> <ul style="list-style-type: none"> <li>Playback starts.</li> <li>Playback also starts if the PLAY button is pressed.</li> </ul>	 <p>Remote control unit</p>								

**Using the DVD Menu**

- Some DVDs include special menus called DVD menus. For example, DVDs with complex contents may contain guide menus, and DVDs with multiple languages may contain audio and subtitle language menus. These menus are called "DVD menus". Here we describe the general procedure for using DVD menus.

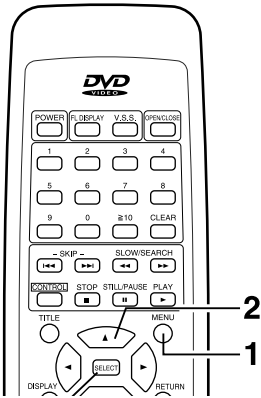

<p><b>1</b></p>	<p>During playback, press the MENU button.</p> <ul style="list-style-type: none"> <li>The DVD menu appears.</li> <li>If the MENU button is pressed again, the disc returns to the point at which the DVD menu was called out and playback resumes from that point.</li> </ul>	<p>Example:</p> <p>DVD MENU</p> <p>1. SUB TITLE</p> <p>2. AUDIO</p> <p>3. ANGLE</p> <p>Remote control unit</p>
<p><b>2</b></p>	<p>Use the ▲ or ▼ cursor buttons or the number buttons to select the desired item.</p> <ul style="list-style-type: none"> <li>If you select the item using the number buttons, skip step 3 below.</li> </ul>	<p>Example: When "AUDIO" is selected</p> <p>DVD MENU</p> <p>1. SUB TITLE</p> <p>2. AUDIO</p> <p>3. ANGLE</p> <p>Remote control unit</p>
<p><b>3</b></p>	<p>Press the SELECT button.</p> <ul style="list-style-type: none"> <li>The selected item is set.</li> <li>If more menus appear, repeat steps 2 and 3.</li> </ul>	<p>Remote control unit</p>

## 17 CHANGING THE DEFAULT SETTINGS

- The default values preset upon shipment from the factory can be changed. The default settings are retained until they are again changed, even if the power is turned off.

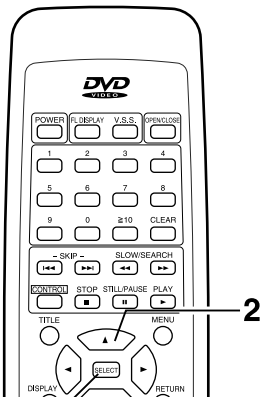

1

In the stop mode, press the SET UP button.

- The default setting screen appears.

### 1. Disc Languages

Use this to set the language to be used when playing the disc. If the set language is not offered on that disc, the disc's default language is set.

### 2. Ratings

Use this to disable playback of adult DVDs so that children cannot watch them. Note that playback of adult DVDs cannot be disabled if the rating level is not recorded on the DVD, but that it is possible to disable playback of all DVDs.

### 3. Menu Language

Use this to set the language for the default setting screen and messages displayed on the TV screen ("PLAY", etc.).

### 4. On-Screen Messages

Use this to set whether or not to display messages ("PLAY", etc.) on the TV screen.

### 5. FL Display

Use this to set the brightness of the display.

### 6. TV Aspect

Set this according to the size of the connected TV's screen (4:3 or 16:9).

### 7. Digital Audio Output

Use this to set the audio signals output from the digital audio output connectors.

### 9. Other Settings

These include special settings such as audio dynamic range compression.

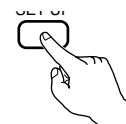

Remote control unit

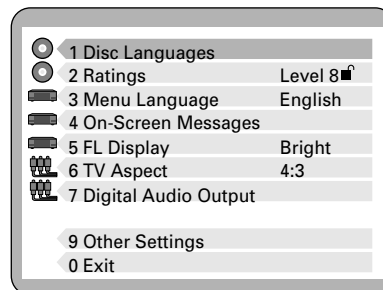

2

Use the ▲ and ▼ cursor buttons to select the desired setting, then press the SELECT button.

- Select "1 Disc Languages". (See page 45.)
- Select "2 Ratings". (See pages 46, 47 and 48.)
- Select "3 Menu Language". (See page 49.)
- Select "4 On-Screen Messages". (See page 50.)
- Select "5 FL Display". (See page 52.)
- Select "6 TV Aspect". (See page 53, 54 and 55.)
- Select "7 Digital Audio Output". (See pages 56 and 57.)
- Select "9 Other Settings". (See pages 58 and 59.)

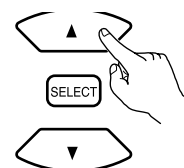

Remote control unit



Remote control unit

### NOTE:

- When the player is set to the "Lock All" setting in "2 Ratings", none of the initial setting, including "2 Rating", can be changed if the DVD disc is left inside the player. In this case, remove the disc, and then operate the player.

When "1 Disc Languages" is Selected



<b>1</b>	See page 44.	
<b>2</b>		
<b>3</b>	<p>Use the ▲ and ▼ cursor buttons to select the desired setting, then press the SELECT button.</p> <p><b>1. Audio</b> Use this to set the language of the sound output from the speakers.</p> <p><b>2. Subtitle</b> Use this to set the language of the subtitles displayed on the TV.</p> <p><b>3. Menus</b> Use this to set the language of the title menus (menus recorded on the disc), etc.</p>	<p style="text-align: center;">Remote control unit</p>
<b>4</b>	<p>Use the ▲ and ▼ cursor buttons to select the desired setting, then press the SELECT button.</p> <p><b>①</b> When "1 Audio" is selected:</p> <p><b>1. English (Factory default)</b> Select this to play the sound in English.</p> <p><b>2. French</b> Select this to play the sound in French.</p> <p><b>3. Spanish</b> Select this to play the sound in Spanish.</p> <p><b>4. Original</b> Select this to play the disc's original sound.</p> <p><b>5. Other * * * *</b> Select this to play the disc with a language other than the ones above. Use the number buttons to input the 4-digit language number shown on page 60.</p> <p><b>②</b> When "2 Subtitle" is selected:</p> <p><b>1. Automatic (Factory default)</b> The subtitle language is automatically set to the same language as the audio language.</p> <ul style="list-style-type: none"> <li>When the disc is played with the audio language set for the "1 Audio" setting, the subtitles are not displayed.</li> <li>When the disc is played with an audio language other than the one set for the "1 Audio" setting, the subtitles are displayed in the language set for the "1 Audio" setting.</li> </ul> <p><b>2. English</b> Select this to play the disc with English subtitles.</p> <p><b>3. French</b> Select this to play the disc with French subtitles.</p> <p><b>4. Spanish</b> Select this to play the disc with Spanish subtitles.</p> <p><b>5. Other * * * *</b> Select this to play the disc with subtitles in a language other than the ones above. Use the number buttons to input the 4-digit language number shown on page 60.</p>	<p style="text-align: center;">Remote control unit</p> <p style="text-align: center;">Remote control unit</p>



<p><b>4</b></p>	<p>③ When "3 Menus" is selected:</p> <ol style="list-style-type: none"> <li><b>1. English (Factory default)</b> Select this to display the menus in English.</li> <li><b>2. French</b> Select this to display the menus in French.</li> <li><b>3. Spanish</b> Select this to display the menus in Spanish.</li> <li><b>5. Other * * * *</b> Select this to display the menus in a language other than the ones above. Use the number buttons to input the 4-digit language number shown on page 60.</li> </ol>	
<p><b>5</b></p>	<p>The settings are completed, and the screen in step 3 reappears.</p>	
<p>* To return to the previous menu screen: Press the RETURN button.</p> <p>* To exit the default settings: Press the SET UP button or number button "0" at the default setting screen in step 1 on page 44.</p>		

**When "2 Ratings" is Selected**

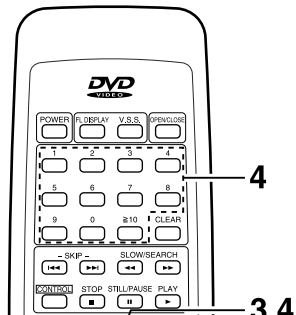
**1. When playback is not restricted (Level 8)**

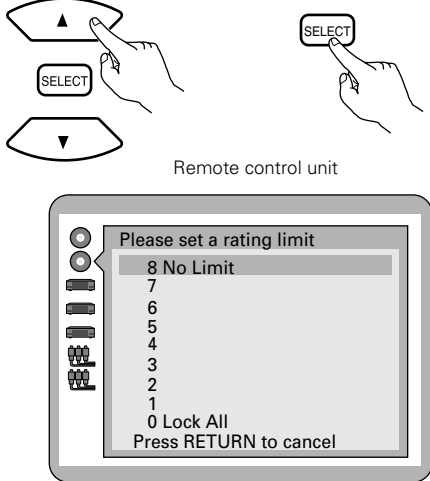

<p><b>1</b></p>	<p>See page 44.</p>	
<p><b>3</b></p>	<p>Use the ▲ and ▼ cursor buttons to select "2 Ratings", then press the SELECT button.</p> <p><b>Level 8 (Factory default)</b> Select this to play all DVDs.</p> <p><b>Level 7 to Level 2</b> Select this to play DVDs for general audiences and children. Adult DVDs cannot be played.</p> <p><b>Level 1</b> Select this to play only DVDs for children. (Adult and general audience DVDs cannot be played.)</p> <p><b>Level 0</b> Select this to disable playback of all DVDs. Use this for example to disable playback of adult DVDs on which the rating level is not recorded.</p>	

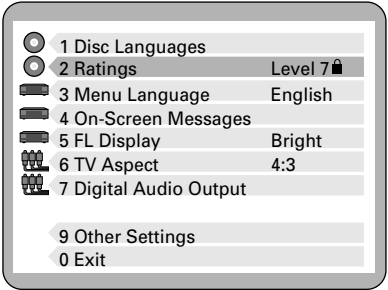
<p><b>4</b></p>	<p>If a rating of Level 7 or lower has been selected, use the number buttons to input a 4-digit password, then press the SELECT button.</p> <ul style="list-style-type: none"> <li>* Do not forget the password.</li> <li>* Once locked, the setting cannot be changed without inputting the correct password.</li> </ul>	 <p>Remote control unit</p> <p>Example: When "Level 7" is selected</p> 
<p><b>5</b></p>	<p>Press the SELECT button.</p>	
<p><b>6</b></p>	<p>The settings are completed, and the screen in step 1 on page 44 reappears.</p>	
<p>* To return to the previous menu screen: Press the RETURN button. (The RETURN button will not function after the SELECT button is pressed in step 5.)</p> <p>* To exit the default settings: Press the SET UP button or number button "0" at the default setting screen in step 1 on page 44.</p>		

2. When playback is restricted (Level 0 to 7)

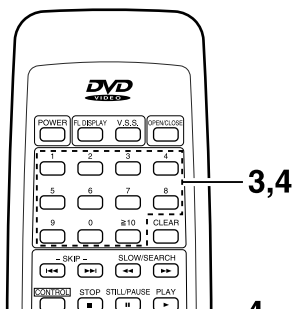

<b>1</b>	See page 44.	
<b>2</b>		
<b>3</b>	Use the number buttons to input the correct password, then press the SELECT button.	
<b>4</b>	<ol style="list-style-type: none"> <li>❶ To cancel the restriction (unlock the player):             <ul style="list-style-type: none"> <li>• Press number button "1", then press the SELECT button.</li> <li>The screen in step 1 on page 44 reappears.</li> </ul> </li> <li>❷ To change the password:             <ul style="list-style-type: none"> <li>• Press number button "2".</li> <li>• Use the number buttons to input the new password, then press the SELECT button.</li> <li>• Press the SELECT button.</li> <li>The screen in step 1 on page 44 reappears.</li> </ul> </li> <li>❸ To change the rating level:             <ul style="list-style-type: none"> <li>• Press number button "3".</li> <li>• Use the ▲ and ▼ cursor buttons or the number buttons to select the desired level, then press the SELECT button.</li> <li>The screen in step 1 on page 44 reappears.</li> </ul> </li> <li>❹ To temporarily cancel the restriction (unlock the player):             <ul style="list-style-type: none"> <li>• Press number button "4".</li> <li>• Press the SELECT button.</li> <li>The screen in step 1 on page 44 reappears.</li> <li>• The temporary unlock setting will be in effect until the power is switched OFF or set to STANDBY, as well as until the change is made to the disc that will be played.</li> </ul> </li> <li>❺ To exit without changing the rating level:             <ul style="list-style-type: none"> <li>• Press number button "0".</li> <li>The screen in step 1 on page 44 reappears.</li> </ul> </li> </ol>	
<p>* To return to the previous menu screen: Press the RETURN button.</p> <p>* To exit the default settings: Press the SET UP button or number button "0" at the default setting screen in step 1 on page 44.</p>		

**NOTE:**

- Some discs may not be encoded with specific rating level information though its disc jacket says that it is for "adults". For those discs, the age restriction will not work.



When "3 Menu Language" is Selected

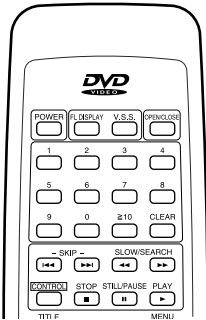

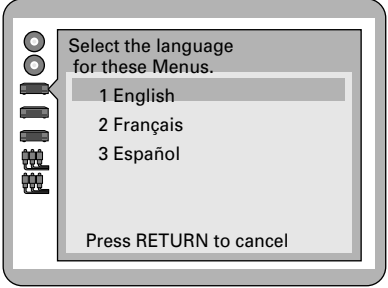
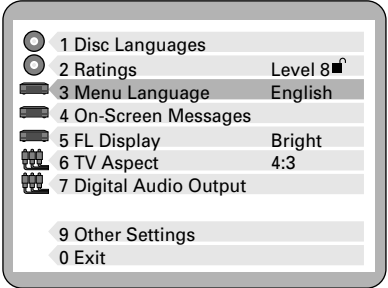
<p><b>1</b> <b>2</b></p>	<p>See page 44.</p>	
<p><b>3</b></p>	<p>Use the ▲ and ▼ cursor buttons to select "3 Menu Language", then press the SELECT button.</p> <p><b>1. English (Factory default)</b> Select this to set the language used for the default setting screen and the "PLAY" and other messages displayed on the TV screen to English.</p> <p><b>2. French</b> Select this to set the language used for the default setting screen and the "PLAY" and other messages displayed on the TV screen to French.</p> <p><b>3. Spanish</b> Select this to set the language used for the default setting screen and the "PLAY" and other messages displayed on the TV screen to Spanish.</p>	 <p>Remote control unit</p> 
<p><b>4</b></p>	<p>The settings are completed, and the screen in step 1 on page 44 reappears.</p>	
<p>* To return to the previous menu screen: Press the RETURN button.</p> <p>* To exit the default settings: Press the SET UP button or number button "0" at the default setting screen in step 1 on page 44.</p>		

When "4 On-Screen Messages" is Selected



<b>1</b>	See page 44.	
<b>2</b>		
<b>3</b>	<p>Press the cursor buttons (▲,▼) to select the preferred item and press SELECT.</p> <p><b>1. On-Screen Messages</b> To select whether "Play", "Still" and other displays are displayed or not.</p> <p><b>2. Color and Position</b> To select the color (Blue/Violet/Green) and position (above/slightly below) of "Play", "Still" and other displays as well as On-Screen Menu Icons.</p>	<p>Remote control unit</p>
<b>4</b>	<p>Press the cursor buttons (▲,▼) to select the preferred setting and press SELECT.</p> <p>❶ When "1 On-Screen Messages" is selected</p> <p><b>1. On (Factory default)</b> "Play", "Still" and other displays will always appear on the TV screen.</p> <p><b>2. Off</b> "Play", "Still" and other displays will not appear on the TV screen.</p> <p>❷ When "2 Color and Position" is selected The colors and positions are set as follows:</p> <ol style="list-style-type: none"> <li>1.  Blue (Factory default)</li> <li>2.  Violet</li> <li>3.  Green</li> <li>4.  Blue</li> <li>5.  Violet</li> <li>6.  Green</li> </ol>	

**5**

The settings are completed, and the screen in step 1 on page 44 reappears.

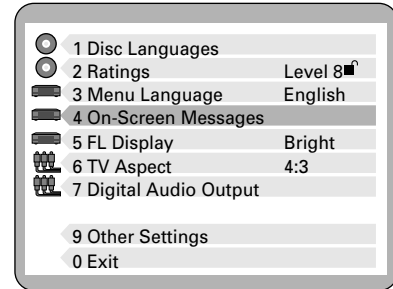

- \* To return to the previous menu screen:  
Press the RETURN button.
- \* To exit the default settings:  
Press the SET UP button or number button "0" at the default setting screen in step 1 on page 44.

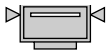
**NOTE:**

- When  is selected, "Play", "Still" and other displays as well as On-Screen Menu Icons will be displayed at a little lower position than the factory setting. It is recommended to choose this setting in such a case that the screen is only partially displayed.

When "5 FL Display" is Selected



<b>1</b>	See page 44.
<b>2</b>	
<b>3</b>	<p>Use the ▲ and ▼ cursor buttons to select the desired screen brightness, then press the SELECT button.</p> <ol style="list-style-type: none"> <li><b>1. Bright (Factory default)</b> The display indications are always bright.</li> <li><b>2. Dim</b> The display indications are always dim.</li> <li><b>3. Dim During DVD/VCD Play (Auto)</b> The indications on the display window are only dim when playing DVDs or video CDs, but are temporarily bright during the slow play and search operations.</li> </ol>
<b>4</b>	<p>The settings are completed, and the screen in step 1 on page 44 reappears.</p>

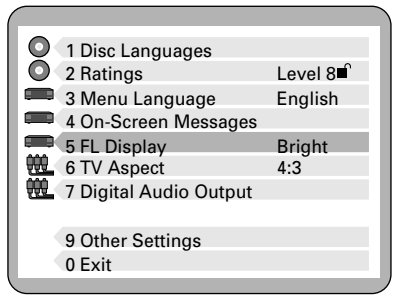
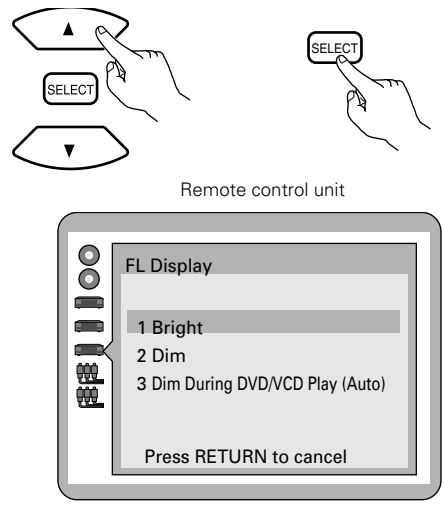

- \* To return to the previous menu screen:  
Press the RETURN button.
- \* To exit the default settings:  
Press the SET UP button or number button "0" at the default setting screen in step 1 on page 44.

When "6 TV Aspect" is Selected

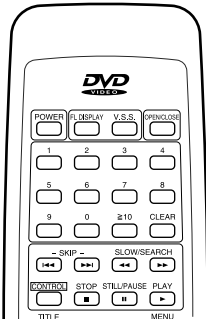

<b>1</b>	See page 44.	
<b>2</b>		
<b>3</b>	<p>Use the ▲ and ▼ cursor buttons to select "6 TV Aspect", then press the SELECT button.</p> <p><b>① 4:3 (Factory default)</b>                  Select this when a conventional size TV is connected. (Factory preset)</p> <ul style="list-style-type: none"> <li>The video material formatted in the Pan &amp; Scan style is played back in that style (the left and right edges are cut off).</li> <li>The video material not formatted in the Pan &amp; Scan style is played back in the letterbox style (black bands appear at top and bottom of screen).</li> </ul> <p>* Set the Pan &amp; Scan and letter box setting at "3 TV Mode" under "9 Other Settings". (Refer to page 58.)</p> <p><b>② 16:9</b>                  Select this when a wide-screen TV is connected. Played in "FULL" size. (Setting the wide-screen TV to "FULL" mode is also necessary.)</p> <p>* Each screen shows an example when the video material for a wide-screen is played. (This setting does not affect the video material for conventional size.)</p>	<p>Remote control unit</p>
<b>4</b>	<p>Press the cursor buttons (▲,▼) to select the TV type and press SELECT.</p> <p><b>①</b> When "4:3" is selected  <b>②</b> When "16:9" is selected</p> <p>Following TV types can be selected in both cases.</p> <ol style="list-style-type: none"> <li><b>Standard (Direct View TV) (Factory default)</b>                  Select when a standard TV (Direct view) is connected.</li> <li><b>CRT Projector</b>                  Select when a CRT projector is connected.</li> <li><b>LCD Projector</b>                  Select when a LCD projector is connected.</li> <li><b>Projection TV</b>                  Select when a projection TV is connected.</li> </ol>	

**5**

The settings are completed, and the screen in step 1 on page 44 reappears.

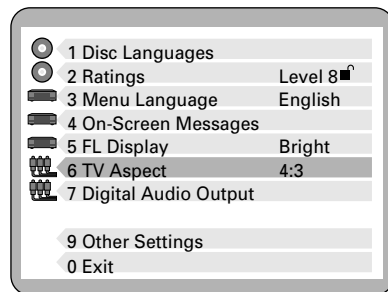

















\* To return to the previous menu screen:  
Press the RETURN button.

\* To exit the default settings:

Press the SET UP button or number button "0" at the default setting screen in step 1 on page 44.

• **Concerning images which appear on the TV screen (aspect ratios of the screen)**

Images which appear on the TV screen differ depending on the type of software and the TV set connected.

Type of software	TV set connected (Screen mode)			
	4:3	16:9 ("FULL" mode)	16:9 ("ZOOM" mode)	16:9 ("AUTO" mode)
<b>Software for wide-screen (formatted in the Pan &amp; Scan style)</b> 	Screen whose right and left edges are cut off 	Full screen 	Screen whose top and bottom edges are cut off 	Full screen 
<b>Software for wide-screen (not formatted in the Pan &amp; Scan style)</b> 	Letterbox (with black bands at top and bottom) 			
<b>Software (4:3)</b> 	Full screen 	Screen horizontally enlarged 	Screen whose top and bottom edges are cut off 	Full screen (with black bands at right and left) 
<b>Software (4:3, Letterbox)</b> 	Letterbox (with black bands at top and bottom) 	Screen horizontally enlarged (with black bands at top and bottom) 	Full screen 	Screen in which the picture at the far left and far right ends only is extended horizontally (with black bands at top and bottom) 

- The images which appear on the TV screen, and what each screen mode is called, may differ depending on the manufacturer of the TV set or on the type of the TV set. Consult the instruction manual provided with your TV set.

**For your reference:**

• **Letterbox**

Black bands are inserted at the top and bottom of the screen to fill in the gaps at the top and bottom where the size of the picture is smaller than the screen.

• **Pan & Scan**

Part of the wide-screen picture (either at both sides or one side of the screen) is automatically eliminated so that the picture fills the whole screen.

When "7 Digital Audio Output" is Selected



<b>1</b>	See page 44.	
<b>2</b>		
<b>3</b>	<p>Use the ▲ and ▼ cursor buttons to select "7 Digital Audio Output", then press the SELECT button.</p> <p><b>1. LPCM 96k → 48k</b> To select whether digital audio converted to 48 kHz/16 bit is output from the optical/coaxial digital audio output connector or no digital audio is output during playback of the DVD recorded in Linear PCM of 96 kHz. (In case of the DVD recorded in Linear PCM of 48 kHz, digital audio converted to 48 kHz/16 bit is output irrespective of the setting.)</p> <p><b>2. Dolby Digital</b> To select the signal format (Bitstream or PCM) to be output from the optical/coaxial digital audio output connector during playback of the DVD recorded in Dolby Digital (AC-3).</p> <p><b>3. dts</b> To select whether DTS bitstream is output from the optical/coaxial digital audio output connector or no digital audio is output during playback of the DVD recorded in dts.</p>	<p style="text-align: center;">Remote control unit</p>
<b>4</b>	<p>Use the ▲ and ▼ cursor buttons to select the desired setting, then press the SELECT button.</p> <p>① When "1 LPCM 96k → 48k" is selected</p> <p><b>1. No (Factory default)</b> Digital audio of 48 kHz/16 bit is output during playback of the DVD recorded in Linear PCM of 48 kHz. No digital audio is output during playback of the DVD recorded in Linear PCM of 96 kHz. However, audio will be output using the original audio recording system in case of the DVD which has not been copyright-protected.</p> <p><b>2. Yes</b> During playback of the DVD recorded in Linear PCM of 48 kHz or 96 kHz, digital audio converted to 48 kHz/16 bit is output. (Digital output of PCM audio is restricted to 48 kHz/16 bit or below for copyright protection.)</p> <p>② When "2 Dolby Digital" is selected</p> <p><b>1. Bitstream (Factory default) (NOTE 1)</b> Dolby Digital (AC-3) bitstream (1ch – 5.1ch) is output during playback of the DVD recorded in the Dolby Digital (AC-3). Select this setting when the player is connected to the Dolby Digital (AC-3) decoder.</p> <p><b>2. PCM</b> Digital audio converted to PCM (2ch) of 48 kHz/16 bit is output during playback of the DVD recorded in the Dolby Digital (AC-3).</p>	<p style="text-align: center;">Remote control unit</p> <p style="text-align: center;">Remote control unit</p>

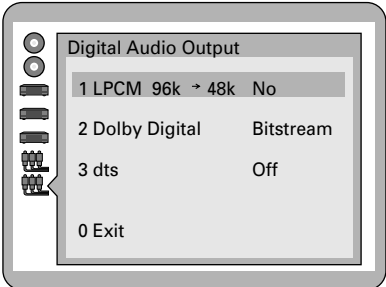

<p><b>4</b></p>	<p>③ When "3 DTS" is selected</p> <p><b>1. Off (Factory default)</b> No digital audio is output during playback of the DVD recorded in DTS.</p> <p><b>2. Bitstream (NOTE 1)</b> DTS bitstream is output during playback of the DVD recorded in DTS. Select this setting when the player is connected to the DTS decoder.</p>	
<p><b>5</b></p>	<p>The settings are completed, and the screen in step 3 reappears.</p>	
<p>* To return to the previous menu screen: Press the RETURN button.</p> <p>* To exit the default settings: Press the SET UP button or number button "0" at the default setting screen in step 1 on page 44.</p>		

• **Recommended "Digital Audio Output" settings**

The optimum digital output setting depends on the type of component connected to the digital audio output connector.

Digital audio output connector	"7 Digital Audio Output" setting		
	1 LPCM (96k → 48k)	2 Dolby Digital	3 DTS
When nothing is connected to the digital audio output connector	1 No (factory default)	1 Bitstream (factory default)	1 Off (factory default)
When an amplifier equipped with a digital input connector and with no built-in Dolby Digital (AC-3) decoder is connected to the digital audio output connector (see page 11)	2 Yes (NOTE 1)	2 PCM (NOTE 2)	1 Off (factory default)
When a Dolby Digital (AC-3) decoder is connected to the digital audio output connector (see page 12)	2 Yes (NOTE 1)	1 Bitstream (factory default)	1 Off (factory default)
When a Dolby Digital (AC-3) DTS decoder is connected to the digital audio output connector	2 Yes (NOTE 1)	1 Bitstream (factory default)	2 Bitstream

**NOTES:**

- When connecting an amplifier (with an optical/coaxial digital input connector) which does not contain the Dolby Digital (AC-3) or dts decoder, be sure to select "PCM" at the "2 Dolby Digital" and "Off" at the "3 dts". If "Bitstream" is selected, any attempt to play DVD may cause such a high level of noise that it may be harmful to your ears and damage your speakers.
- Audio output from the player's audio output connectors is converted to 48 kHz as well as audio from the digital audio output connector. To enjoy high quality sound at 96 kHz, connect the amplifier or decoder directly to the audio output connectors, not to the digital audio output connector. (Select "No" at the "1 LPCM 96k → 48k".)

When "9 Other Settings" is Selected

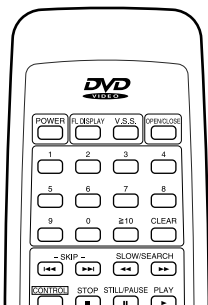

<b>1</b>	See page 44.	
<b>2</b>		
<b>3</b>	<p>Use the ▲ and ▼ cursor buttons to select "9 Other Settings", then press the SELECT button.</p> <p><b>1. Still Mode</b> Use this to reduce fluttering of the picture when playing still pictures.</p> <p><b>2. Audio during search</b> Use this to set whether or not to play the sound during the search operation in speed 1.</p> <p><b>3. TV mode (4:3)</b> Use this to set the TV screen display when playing wide DVDs on conventional size TVs.</p> <p><b>4. D.Range Compression</b> Use this to set the range of sound output when playing discs.</p> <p><b>5. Still Picture Display</b> To select whether the picture type (I/P/B) is displayed on the TV screen in the still picture mode or not.</p> <p><b>6. Black Level Control</b> To select the black level of the picture, "Lighter" or "Darker".</p>	<p style="text-align: center;">Remote control unit</p>
<b>4</b>	<p>Use the ▲ and ▼ cursor buttons to select the desired setting, then press the SELECT button.</p> <p><b>①</b> When "1 Still Mode" is selected</p> <p><b>1. Automatic (Factory default)</b> Normally set this. The frame still or field still mode is selected automatically.</p> <p><b>2. Field</b> Select this if the picture flutters when "Automatic" is set.</p> <p><b>3. Frame</b> "Frame still" is always selected. Select this setting when small text or fine patterns cannot be seen clearly even when "1 Automatic" is selected.</p> <p><b>②</b> When "2 Audio during search" is selected</p> <p><b>1. On (Factory default)</b> Select this to output sound during the search operation in speed 1.</p> <p><b>2. Off</b> Select this to turn off the sound during the search operation in speed 1.</p> <p><b>③</b> When "3 TV Mode (4:3)" is selected</p> <p><b>1. Pan&amp;Scan (factory default)</b> Select this to play wide DVDs with a pan &amp; scan screen (with the sides cut off). If pan &amp; scan is not specified for the disc, however, the disc is played with a letter box screen.</p> <p><b>2. Letter box</b> Select this to play wide DVDs with a letter box screen (with black bands at the top and bottom).</p>	<p style="text-align: center;">Remote control unit</p> <p style="text-align: center;">Remote control unit</p>

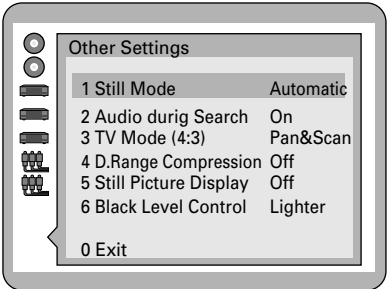
<p><b>4</b></p>	<p>④ When "4 D.Range Compression" is selected</p> <ol style="list-style-type: none"> <li><b>Off (Factory default)</b> Select this for the standard range.</li> <li><b>On</b> Select this to achieve powerful sound even when the volume is low. This setting is suited for watching DVDs late at night with the volume low. (This setting is only valid for DVDs recorded in Dolby Digital.)</li> </ol> <p>⑤ When "5 Still Picture Display" is selected</p> <ol style="list-style-type: none"> <li><b>Off (Factory default)</b> The picture type (I/P/B) will not be displayed on the TV screen in the still picture mode.</li> <li><b>On</b> The picture type (I/P/B) will be displayed on the TV screen in the still picture mode.</li> </ol> <p>⑥ When "6 Black Level Control" is selected</p> <ol style="list-style-type: none"> <li><b>Lighter (Factory default)</b> The black level of the picture is selected to the lighter one. Select this setting normally when the player is connected to a TV set through the VIDEO OUT connector or S VIDEO OUT connector.</li> <li><b>Darker</b> The black level of the picture is selected to the darker one. Select this setting normally when the player is connected to a TV set through the COMPONENT VIDEO OUT (Y,Cb, Cr) connector.</li> </ol>	
<p><b>5</b></p>	<p>The settings are completed, and the screen in step 3 reappears.</p>	
<p>* To return to the previous menu screen: Press the RETURN button.</p> <p>* To exit the default settings: Press the SET UP button or number button "0" at the default setting screen in step 1 on page 44.</p>		

**For your reference:**

- When the "2 On" is selected at the "5 Still Picture Display", the following screen is displayed in the still picture mode;

Still(P)

Example: in the case of the P-Picture

**I/P/B:**

- The MPEG 2 standard adopted for DVD uses the following 3 picture types for the coding of each picture (frame) on the TV screen.

**I: I-Picture (Intra coded picture)**  
This is the standard picture type, and each picture is coded separately. Since it features the best picture quality, it is recommended that the screen be frozen with I-Picture when the picture quality is to be adjusted.

**P: P-Picture (Predictive coded picture)**  
This picture type is computed on the basis of a past I-Picture or P-Picture.

**B: B-Picture (Bidirectionally-predictive coded picture)**  
This picture type is computed by comparing the previous and subsequent I-Picture or P-Picture. It has the lowest volume of information.

**General Picture type**

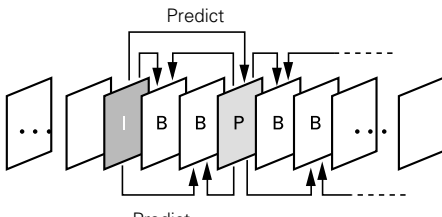

## Language code list

Code	Language	Code	Language	Code	Language	Code	Language
6565	Afar	7079	Faroese	7678	Lingala	8375	Slovak
6566	Abkhazian	7082	French	7679	Laothian	8376	Slovenian
6570	Afrikaans	7089	Frisian	7684	Lithuanian	8377	Samoan
6577	Ameharic	7165	Irish	7686	Latvian, Lettish	8378	Shona
6582	Arabic	7168	Scots Gaelic	7771	Malagasy	8379	Somali
6583	Assamese	7176	Galician	7773	Maori	8381	Albanian
6588	Aymara	7178	Guarani	7775	Macedonian	8382	Serbian
6590	Azerbaijani	7185	Gujarati	7776	Malayalam	8385	Sundanese
6665	Bashkir	7265	Hausa	7778	Mongolian	8386	Swedish
6669	Byelorussian	7273	Hindi	7779	Moldavian	8387	Swahili
6671	Bulgarian	7282	Croatian	7782	Marathi	8465	Tamil
6672	Bihari	7285	Hungarian	7783	Malay	8469	Telugu
6678	Bengali; Bangla	7289	Armenian	7784	Maltese	8471	Tajik
6679	Tibetan	7365	Interlingua	7789	Burmese	8472	Thai
6682	Breton	7378	Indonesian	7865	Nauru	8473	Tigrinya
6765	Catalan	7383	Icelandic	7869	Nepali	8475	Turkmen
6779	Corsican	7384	Italian	7876	Dutch	8476	Tagalog
6783	Czech	7387	Hebrew	7879	Norwegian	8479	Tonga
6789	Welsh	7465	Japanese	7982	Oriya	8482	Turkish
6865	Danish	7473	Yiddish	8065	Panjabi	8484	Tatar
6869	German	7487	Javanese	8076	Polish	8487	Twi
6890	Bhutani	7565	Georgian	8083	Pashto, Pushto	8575	Ukrainian
6976	Greek	7575	Kazakh	8084	Portuguese	8582	Urdu
6978	English	7576	Greenlandic	8185	Quechua	8590	Uzbek
6979	Esperanto	7577	Cambodian	8277	Rhaeto-Romance	8673	Vietnamese
6983	Spanish	7578	Kannada	8279	Romanian	8679	Volapük
6984	Estonian	7579	Korean	8285	Russian	8779	Wolof
6985	Basque	7583	Kashmiri	8365	Sanskrit	8872	Xhosa
7065	Persian	7585	Kurdish	8368	Sindhi	8979	Yoruba
7073	Finnish	7589	Kirghiz	8372	Serbo-Croatian	9072	Chinese
7074	Fiji	7665	Latin	8373	Singhalese	9085	Zulu

## 18 TROUBLESHOOTING

**Check again before assuming the player is malfunctioning.**

- **Are all the connections correct?**
- **Are you following the instructions in the manual?**
- **Are the amplifier and speakers operating properly?**

If the DVM-3700 does not seem to be functioning properly, check the table below. If this does not solve the problem, the DVM-3700 may be damaged. Turn off the power, unplug the power cord from the power outlet, and contact your store of purchase or nearest DENON sales office.

Symptom	Check	Page
Power does not turn on.	<ul style="list-style-type: none"> <li>• Plug the power cord securely into the power outlet.</li> </ul>	10
Playback does not start when PLAY button is pressed. Playback stops immediately.	<ul style="list-style-type: none"> <li>• Is there condensation on the disc or player? (Let stand for 1 or 2 hours.)</li> <li>• Discs other than DVDs, video CDs and music CDs cannot be played.</li> <li>• Disc is dirty. Wipe off the dirt.</li> </ul>	— 8 9
Picture does not appear.	<ul style="list-style-type: none"> <li>• Check the connections.</li> <li>• Set the TV's input to "video".</li> </ul>	10 —
Sound is not produced or sound quality is poor.	<ul style="list-style-type: none"> <li>• Check the connections.</li> <li>• Properly set the input of the TV, stereo, etc.</li> </ul>	10 —
Menu playback of video CD's is not possible.	<ul style="list-style-type: none"> <li>• Menu playback is not possible with anything but video CDs with playback control.</li> </ul>	21
Picture is disturbed during the search operation.	<ul style="list-style-type: none"> <li>• Some disturbance is normal.</li> </ul>	—
Buttons do not operate.	<ul style="list-style-type: none"> <li>• Some operations are disabled for some discs.</li> </ul>	22
No subtitles are displayed.	<ul style="list-style-type: none"> <li>• Subtitles are not displayed for DVDs not containing subtitles.</li> <li>• Subtitles are turned off. Turn the subtitles setting on.</li> </ul>	— 39
Audio (or subtitle) language does not switch.	<ul style="list-style-type: none"> <li>• The audio (or subtitle) language does not switch for discs which do not include multiple audio (or subtitle) languages.</li> <li>• For some discs the audio (or subtitle) language cannot be switched when the operation to switch it is performed, but can be switched on the menu screens.</li> </ul>	— 37, 39
Angle does not switch.	<ul style="list-style-type: none"> <li>• The angle cannot be switched for DVDs which do not contain multiple angles. In some cases multiple angles are only recorded for specific scenes.</li> </ul>	40
Playback does not start when the title is selected.	<ul style="list-style-type: none"> <li>• Check the "Ratings" setting.</li> </ul>	46~48
You have forgotten the password you have set for the "Ratings" setting.	<ul style="list-style-type: none"> <li>• Use the procedure described below to reset all the settings to the factory defaults. In the stop mode, press and hold in the PLAY, SKIP (I◀▶) and OPEN/CLOSE buttons on the DVD player for at least 3 seconds. (Check that "Initialized" has turned off from the TV screen.)</li> </ul>	—
The disc is not played with the audio or subtitle language set as the default setting.	<ul style="list-style-type: none"> <li>• The disc does not play with the selected audio or subtitle language if that audio or subtitle language is not included on that DVD.</li> </ul>	45
Picture is not displayed in 4:3 (or 16:9).	<ul style="list-style-type: none"> <li>• Set the "TV Aspect" default setting to the proper setting for the connected TV.</li> </ul>	53
No messages appear on the screen when buttons are operated.	<ul style="list-style-type: none"> <li>• Set the "On-Screen Messages" default setting to "On".</li> </ul>	50
Menu screen messages for the desired language do not display.	<ul style="list-style-type: none"> <li>• Check the default setting for the disc language's menu language.</li> </ul>	45
Remote control unit does not operate.	<ul style="list-style-type: none"> <li>• Check that the batteries are inserted in the proper "⊕" and "⊖" directions.</li> <li>• The batteries are dead. Replace them with new batteries.</li> <li>• Point the remote control unit at the remote control sensor when operating it.</li> <li>• Operate the remote control unit within a distance of 7 meters from the remote control sensor.</li> <li>• Remove the obstacle between the remote control unit and remote control sensor.</li> </ul>	17 17 17 17 17

**19 MAIN SPECIFICATIONS**

<b>Signal system:</b>	NTSC
<b>Applicable discs:</b>	<ul style="list-style-type: none"> <li>(1) DVD/video discs               <ul style="list-style-type: none"> <li>1-layer 12 cm single-sided discs, 2-layer 12 cm single-sided discs, 2-layer 12 cm double-sided discs (1 layer per side)</li> <li>1-layer 8 cm single-sided discs, 2-layer 8 cm single-sided discs, 2-layer 8 cm double-sided discs (1 layer per side)</li> </ul> </li> <li>(2) Compact discs (CD-DA, Video CD)               <ul style="list-style-type: none"> <li>12 cm discs, 8 cm discs</li> </ul> </li> </ul>
<b>S-Video output:</b>	Y output level: 1 Vp-p (75 $\Omega$ /ohms)      C output level: 0.286 Vp-p Output connectors: S connectors, two sets
<b>Video output:</b>	Output level: 1 Vp-p (75 $\Omega$ /ohms)      Output connector: Pin-plug jacks, two sets
<b>Component output:</b>	Y output level: 1 Vp-p (75 $\Omega$ /ohms) Cb output level: 0.648 Vp-p (75 $\Omega$ /ohms)      Cr output level: 0.648 Vp-p (75 $\Omega$ /ohms) Output connector: Pin jack, 1 set
<b>Audio output:</b>	Fixed output level: 2 Vrms, 1 set
<b>Audio output properties:</b>	<ul style="list-style-type: none"> <li>(1) Frequency response           <ul style="list-style-type: none"> <li>① DVDs (linear PCM) : 2 Hz to 22 kHz (48 kHz sampling)</li> <li>                             : 2 Hz to 44 kHz (96 kHz sampling)</li> <li>② CDs : 2 Hz to 20 kHz</li> </ul> </li> <li>(2) S/N ratio           <ul style="list-style-type: none"> <li>① DVDs : 115 dB</li> <li>② CDs : 115 dB</li> </ul> </li> <li>(3) Total harmonic distortion           <ul style="list-style-type: none"> <li>① DVDs : 0.0025%</li> <li>② CDs : 0.0030%</li> </ul> </li> <li>(4) Dynamic range           <ul style="list-style-type: none"> <li>① DVDs : 108 dB</li> <li>② CDs : 100 dB</li> </ul> </li> </ul>
<b>Digital audio output:</b>	Optical digital output : Optical connector, 1 set Coaxial digital output : Pin jack, 1 set
<b>Power supply:</b>	AC 120V, 60 Hz
<b>Power consumption:</b>	40 W
<b>Maximum external dimensions:</b>	434 (width) x 131 (height) x 415 (depth) mm (not including protruding parts)
<b>Weight:</b>	9.2 kg
■ <b>Remote control unit:</b>	RC-542
<b>Type:</b>	Infrared pulse
<b>Power supply:</b>	DC 3V, two batteries ("AA" (R6P))

This product incorporates copyright protection technology that is protected by method claims of certain U.S. patents and other intellectual property rights owned by Macrovision Corporation and other rights owners. Use of this copyright protection technology must be authorized by Macrovision Corporation, and is intended for home and other limited viewing uses only unless otherwise authorized by Macrovision Corporation. Reverse engineering or disassembly is prohibited.

\* Design and specifications are subject to change without notice in the course of product improvement.

## Free Manuals Download Website

<http://myh66.com>

<http://usermanuals.us>

<http://www.somanuals.com>

<http://www.4manuals.cc>

<http://www.manual-lib.com>

<http://www.404manual.com>

<http://www.luxmanual.com>

<http://aubethermostatmanual.com>

Golf course search by state

<http://golfingnear.com>

Email search by domain

<http://emailbydomain.com>

Auto manuals search

<http://auto.somanuals.com>

TV manuals search

<http://tv.somanuals.com>