

## 1x9 Bi-Directional Transceiver Module for Fast Ethernet, ATM, SONET OC-3/SDH STM-1



### FEATURES

- RoHS compliant
- Industry Standard 1 x 9 Footprint
- Single Mode Fiber, Bi-Directional Transmission with 1550nm Transmitter and 1310nm Receiver
- Link Distance up to 15km
- Single +3.3V power supply and PECL logic interface
- Wave Solderable and Aqueous Washable
- Bellcore GR-468 compliant
- Laser Class 1 Product which comply with the requirements of IEC 60825-1 and IEC 60825-2

### Description

DELTA's 1x9 Bi-Directional transceiver is designed for point-to-point Bi-Directional Optical Network transmission. The module consists 1550nm FP laser, InGaAs PIN, Preamplifier and WDM filter in a high-integrated optical sub-assembly, and it receives up to 155Mbps of continuous data at 1310nm, and transmits 155Mbps of continuous data at 1550nm.

The module is contained in a 1x9 industry standard package with a SC receptacle connector, and support LVPECL electrical signal Interface and receiver signal detect output.

### Application

- TTC TS-1000
- ITU-T G.985
- IEEE 802.3ah 100BASE-BX/ Fast Ethernet
- SONET OC-3/SDH STM-1/ ATM Network
- FTTx Broadband Access System

### Performance

- OPBD-F2J1R data link up to 15km in 9/125um single mode fiber.

### 1. Absolute Maximum Ratings

Parameter	Symbol	Min.	Typ.	Max.	Unit	Note
Storage Temperature	T <sub>s</sub>	-40		85	°C	
Operating Ambient Temperature	T <sub>a</sub>	-10		80	°C	
Storage Ambient Humidity	HA	5		95	%	
Power Supply Voltage	V <sub>CC</sub>	-0.5		5	V	
Signal Input Voltage		-0.3		V <sub>CC</sub> +0.3	V	
Optical Input Power (Peak)				0	dBm	
Lead Soldering Temperature	T <sub>SOLD</sub>			260	°C	
Lead Soldering Time	t <sub>SOLD</sub>			10	sec	

### 2. Recommended Operating Conditions

Parameter	Symbol	Min.	Typ.	Max.	Unit	Note
Ambient Operating Temperature	T <sub>A</sub>	0		70	°C	Without air flow
Ambient Humidity	HA	5		85	%	Non-condensing
Power Supply Voltage	V <sub>CC</sub>	3.135	3.3	3.465	V	
Power Supply Current	I <sub>CC</sub>			250	mA	
Power Supply Noise Rejection				100	mVp-p	100Hz to 1MHz
Data Rate		10		155.52	Mbps	
Transmission Distance				15	km	

### 3. Optical Specification of Transmitter

Parameter	Symbol	Min.	Typ.	Max.	Unit	Note
Average Launched Power	P <sub>O</sub>	-14	-11	-8	dBm	Note (1)
Launched power (Peak.)				-5	dBm	
Extinction Ratio	ER	8.5			dB	
Center Wavelength	λ <sub>c</sub>	1480	1520	1580	nm	FP Laser
Spectrum Width (RMS)	σ			3	nm	
Optical Rise/Fall Time	t <sub>r</sub> /t <sub>f</sub>			1.3	ns	Note (2)
Total Jitter	t <sub>J</sub>			1	ns	Note (3)
Optical Return Loss Tolerance	ORLT			14	dB	
Relative Intensity Noise	RIN			-116	dB/Hz	
Output Eye Mask	Compliant with Bellcore TR-NWT-000253 and ITU recommendation G.957					Note (4)

Note (1). Launched power (avg.) is power coupled into a single mode fiber.

Note (2). These are unfiltered 20-80% values.

Note (3). Measure at 2<sup>23</sup>-1 NRZ PRBS pattern

Note (4). Eye Mask definition

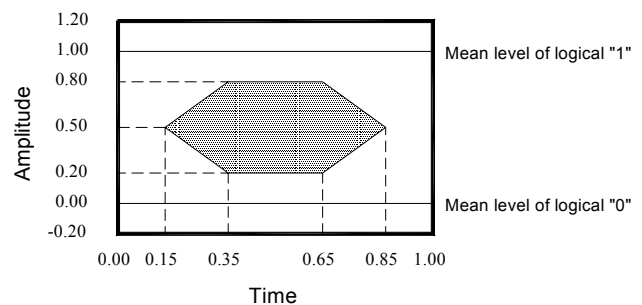

Optical Pulse Mask with Bessel Filter Specified in ITU-T G.957

#### 4. Optical Specification of Receiver

Parameter	Symbol	Min.	Typ.	Max.	Unit	Note
Input Optical Wavelength	$\lambda_{IN}$	1260		1360	nm	PIN-PD
Receiver Sensitivity	$P_{IN}$			-30	dBm	Note (1)
Input Saturation Power (Overload)	$P_{SAT}$	-3			dBm	
Signal Detect -Assert Power	$P_A$	-		-30	dBm	
Signal Detect -Deassert Power	$P_D$	-44			dBm	Note (2)
Signal Detect Hysteresis	$P_A-P_D$	0.5	2.5	6	dB	
Optical Receiver Reflectance				-14	dB	Note (3)
Output Data Rise/Fall time	$t_r/t_f$			1.5	ns	Note (4)
S/X Endurance				10	dB	Note (5)
Optical Isolation		25			dB	Note (6)

Note (1). Measured with 1310nm, ER=10dB; BER =  $<10^{-10}$  @ PRBS=2<sup>23</sup>-1 NRZ

Note (2). When SD deasserted, the data output is Low-level (fixed)

Note (3). When the terminal is viewed from the optical path, the reflection toward the optical path of the optical signal with a central wavelength of 1260nm to 1360nm transmitted to terminal.

Note (4). These are 20%~80% values

Note (5). X=10 MHz, Rectangular BER =  $10^{-10}$

Note (6). Receiver isolation between 1480nm ~1580nm

#### 5. Electrical Interface Characteristics

Parameter	Symbol	Min.	Typ.	Max.	Unit	Note
<b>Transmitter</b>						
Total Supply Current	$I_{CC}$			A	mA	Note (1)
Differential line input Impedance	$R_{IN}$	80	100	120	Ohm	
Differential Data Input Swing	VDT	300		1600	mV <sub>p-p</sub>	
Data Input Voltage- High	$V_{IH}-V_{CC}$	-1.165		-0.880	V	LVPECL
Data Input Voltage- Low	$V_{IL}-V_{CC}$	-1.810		-1.475	V	
<b>Receiver</b>						
Total Supply Current	$I_{CC}$			B	mA	Note (1)
Differential Data Output Swing	VDR	400		2000	mV <sub>p-p</sub>	
Data Output Voltage-High	$V_{OH}-V_{CC}$	-1.085		-0.880	V	LVPECL
Data Output Voltage-Low	$V_{OL}-V_{CC}$	-1.830		-1.555	V	
Signal Detect Output Voltage-High	$V_{OH}-V_{CC}$	-1.085		-0.880	V	
Signal Detect Output Voltage-Low	$V_{OL}-V_{CC}$	-1.830		-1.555	V	

Note (1). A (TX)+ B (RX) = 250mA

(A: Not include termination circuit; B: using a resistor of 150Ω between Data-output and ground)

### 6. Pin Description

Tx/Rx	Pin No.	I/O	Pin Name	Description
Rx	1		VeeR	Receiver Ground
	2	O	RD(n)	Inverted Receiver Data Output
	3	O	RD(p)	Non-Inverted Receiver Data Output
	4	O	SD	Normal Optical Input indicated by logic "High", and No Optical Input indicated by logic "Low".
	5		VccR	+3.3V Receiver Power Supply
Tx	6		VccT	+3.3V Transmitter Power Supply
	7	I	TD(p)	Non-Inverted Transmitter Data Input
	8	I	TD(n)	Inverted Transmitter Data Input
	9		VeeT	Transmitter Ground
			MS	Mounting studs/ connect this pin to Chassis ground

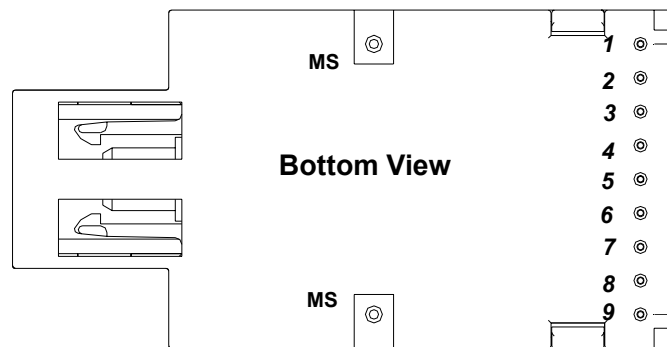

### 7. Recommended Interface Circuit (AC Coupling)

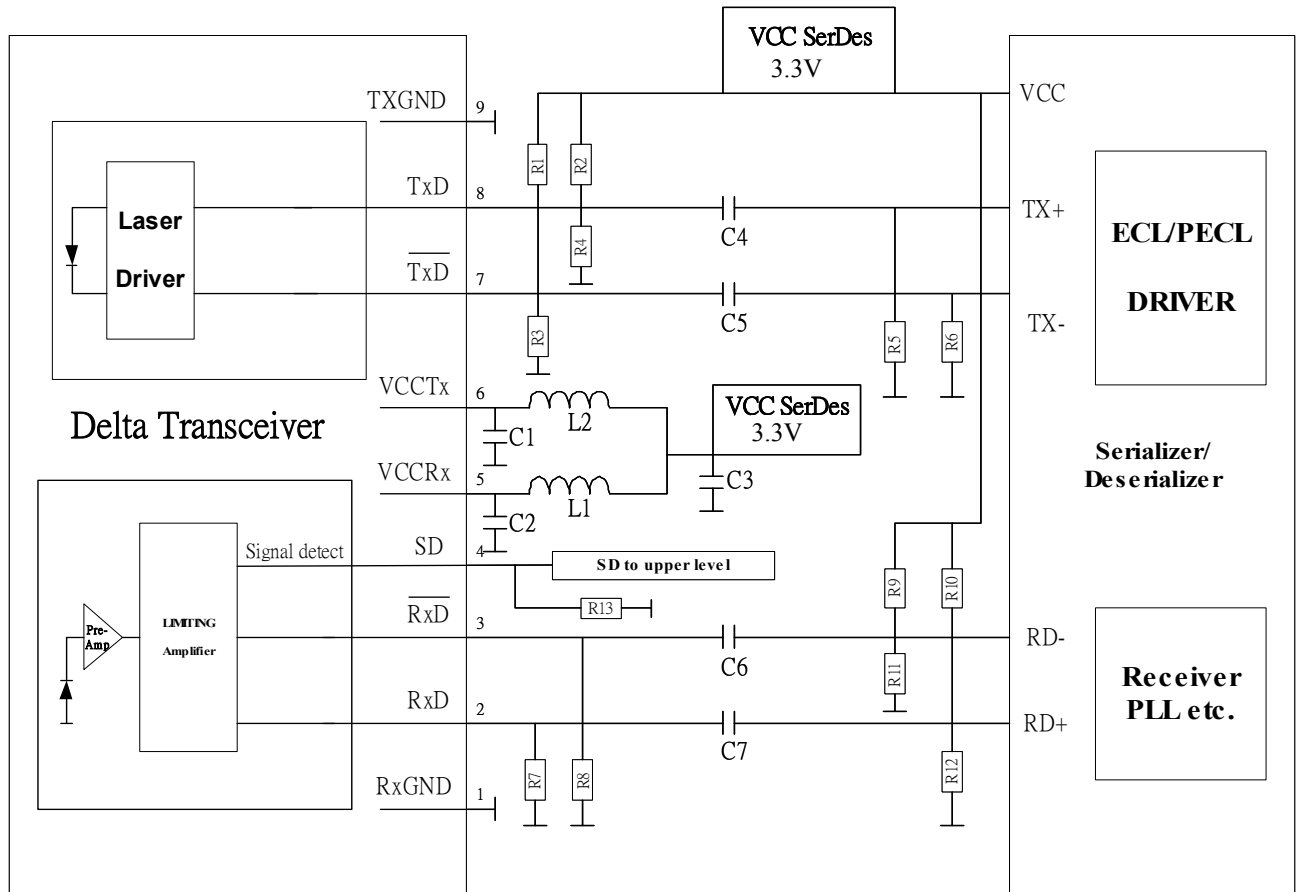

- C1/2/3 = 4.7 uF
- C4/5/6/7 = 100 nF
- L1/2 = 1 uH
- R1/2 = 82 Ω (If C4/5=0, then R1/2 =130 Ω, it is for DC-coupled.)
- R3/4 = 130 Ω (If C4/5=0, then R3/4 =82 Ω, it is for DC-coupled.)
- R7/8 = 150 Ω
- R5/6/9/10/11/12 Depend on SerDes chip used
- R13 = 270 Ω

Value of R5/6/9/10/11/12 may vary as long as proper 50 Ω termination or differential 100 Ω is provided. For good EMI performance, the power supply filter is required. Use shorter tracks from the inductor L1/2 to the module VccTx/VccRx .

8. Outline Dimensions

Parameter	Unit	Description	Note
Mechanical Dimensions	mm	50.4x25.4x10.8	
Connector Type	-	SC Receptacle Connector	IEC-61754-4

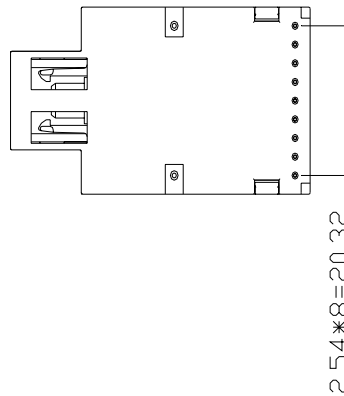
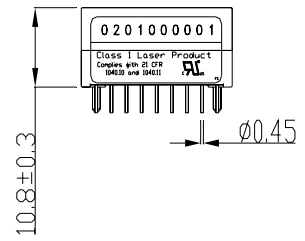
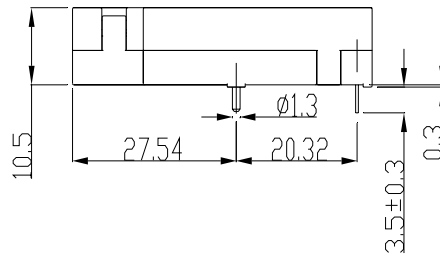
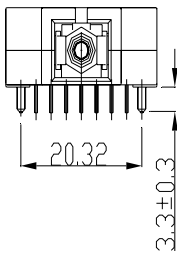
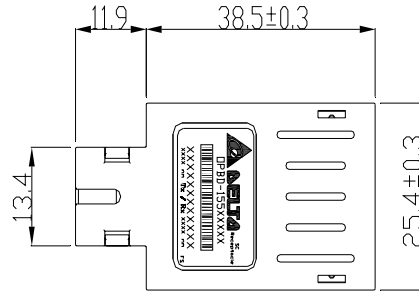

NOTE:  
 1.Units in mm  
 2.Dimensional tolerances ±0.2mm

S/N

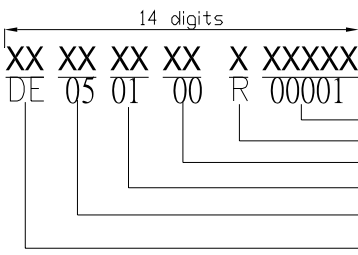

S/N :(00001~99999)  
 Rework : Rework=R or No-rework=0  
 Vender NOTE : Free or 00  
 Week (52Weeks/Year) : 1月2日=01  
 Year : 2005=05  
 Vender CODE : DELTA=DE

### 9. Regulatory Compliance

Feature	Test Method	Reference	Performance
Electrostatic Discharge (ESD) to the Electrical Pins	Human Body Model (HBM)	MIL-STD-883E Method 3015.7 EIA-JESD22-A114	(1) Satisfied with electrical characteristics of product spec.  (2) No physical damage
	Machine Model (MM)	EIA-JESD22-A115	
Electrostatic Discharge (ESD) to the Simplex Receptacle	Contact Discharge	IEC/EN 61000-4-2	
	Air Discharge	IEC/EN 61000-4-2	
Radio Frequency Electromagnetic Field Immunity		IEC/EN 61000-4-3	
Electromagnetic Interference (EMI)		FCC Part 15 Class B EN 55022 Class B (CISPR 22A)	
Laser Eye Safety	FDA/CDRH	FDA 21CFR 1040.10, 1040.11	CDRH File # 0420993
	TUV	IEC/EN 60825-1 IEC/EN 60825-2	TUV Certificate # R50032471
Component Recognition	TUV	IEC/EN 60950	
	UL/CSA	UL 60950	UL File # E239394

### Appendix B. Document Revision

Version No.	Date	Description
S0	2006-07-20	Preliminary datasheet
S1	2006-09-12	Add barcode on product label
S2	2007-03-09	Change the module height from 9.7±0.3mm to 10.8±0.3mm

## Free Manuals Download Website

<http://myh66.com>

<http://usermanuals.us>

<http://www.somanuals.com>

<http://www.4manuals.cc>

<http://www.manual-lib.com>

<http://www.404manual.com>

<http://www.luxmanual.com>

<http://aubethermostatmanual.com>

Golf course search by state

<http://golfingnear.com>

Email search by domain

<http://emailbydomain.com>

Auto manuals search

<http://auto.somanuals.com>

TV manuals search

<http://tv.somanuals.com>