

3 H.P. Single-Stage Dust Collector

(Model 50-852, three phase)

(Model 50-853, single phase)



PART NO. 902108 - 06-27-02
Copyright © 2002 Delta Machinery



To learn more about DELTA MACHINERY
visit our website at: www.deltamachinery.com.

For Parts, Service, Warranty or other Assistance,

please call 1-800-223-7278 (In Canada call 1-800-463-3582).

GENERAL SAFETY RULES

Woodworking can be dangerous if safe and proper operating procedures are not followed. As with all machinery, there are certain hazards involved with the operation of the product. Using the machine with respect and caution will considerably lessen the possibility of personal injury. However, if normal safety precautions are overlooked or ignored, personal injury to the operator may result. Safety equipment such as guards, push sticks, hold-downs, featherboards, goggles, dust masks and hearing protection can reduce your potential for injury. But even the best guard won't make up for poor judgment, carelessness or inattention. Always use common sense and exercise caution in the workshop. If a procedure feels dangerous, don't try it. Figure out an alternative procedure that feels safer. **REMEMBER:** Your personal safety is your responsibility.

This machine was designed for certain applications only. Delta Machinery strongly recommends that this machine not be modified and/or used for any application other than that for which it was designed. If you have any questions relative to a particular application, **DO NOT** use the machine until you have first contacted Delta to determine if it can or should be performed on the product.

Technical Service Manager

Delta Machinery
4825 Highway 45 North
Jackson, TN 38305

(IN CANADA: 505 SOUTHGATE DRIVE, GUELPH, ONTARIO N1H 6M7)



WARNING: FAILURE TO FOLLOW THESE RULES MAY RESULT IN SERIOUS PERSONAL INJURY

1. **FOR YOUR OWN SAFETY, READ INSTRUCTION MANUAL BEFORE OPERATING THE TOOL.** Learn the tool's application and limitations as well as the specific hazards peculiar to it.

2. **KEEP GUARDS IN PLACE** and in working order.

3. **ALWAYS WEAR EYE PROTECTION.** Wear safety glasses. Everyday eyeglasses only have impact resistant lenses; they are not safety glasses. Also use face or dust mask if cutting operation is dusty. These safety glasses must conform to ANSI Z87.1 requirements. Note: Approved glasses have Z87 printed or stamped on them.

4. **REMOVE ADJUSTING KEYS AND WRENCHES.** Form habit of checking to see that keys and adjusting wrenches are removed from tool before turning it "on".

5. **KEEP WORK AREA CLEAN.** Cluttered areas and benches invite accidents.

6. **DON'T USE IN DANGEROUS ENVIRONMENT.** Don't use power tools in damp or wet locations, or expose them to rain. Keep work area well-lighted.

7. **KEEP CHILDREN AND VISITORS AWAY.** All children and visitors should be kept a safe distance from work area.

8. **MAKE WORKSHOP CHILDPROOF** – with padlocks, master switches, or by removing starter keys.

9. **DON'T FORCE TOOL.** It will do the job better and be safer at the rate for which it was designed.

10. **USE RIGHT TOOL.** Don't force tool or attachment to do a job for which it was not designed.

11. **WEAR PROPER APPAREL.** No loose clothing, gloves, neckties, rings, bracelets, or other jewelry to get caught in moving parts. Non-slip footwear is recommended. Wear protective hair covering to contain long hair.

12. **SECURE WORK.** Use clamps or a vise to hold work when practical. It's safer than using your hand and frees both hands to operate tool.

13. **DON'T OVERREACH.** Keep proper footing and balance at all times.

14. **MAINTAIN TOOLS IN TOP CONDITION.** Keep tools sharp and clean for best and safest performance. Follow instructions for lubricating and changing accessories.

15. **DISCONNECT TOOLS** before servicing and when changing accessories such as blades, bits, cutters, etc.

16. **USE RECOMMENDED ACCESSORIES.** The use of accessories and attachments not recommended by Delta may cause hazards or risk of injury to persons.

17. **REDUCE THE RISK OF UNINTENTIONAL STARTING.** Make sure switch is in "OFF" position before plugging in power cord. In the event of a power failure, move switch to the "OFF" position.

18. **NEVER STAND ON TOOL.** Serious injury could occur if the tool is tipped or if the cutting tool is accidentally contacted.

19. **CHECK DAMAGED PARTS.** Before further use of the tool, a guard or other part that is damaged should be carefully checked to ensure that it will operate properly and perform its intended function – check for alignment of moving parts, binding of moving parts, breakage of parts, mounting, and any other conditions that may affect its operation. A guard or other part that is damaged should be properly repaired or replaced.

20. **DIRECTION OF FEED.** Feed work into a blade or cutter against the direction of rotation of the blade or cutter only.

21. **NEVER LEAVE TOOL RUNNING UNATTENDED. TURN POWER OFF.** Don't leave tool until it comes to a complete stop.

22. **STAY ALERT, WATCH WHAT YOU ARE DOING, AND USE COMMON SENSE WHEN OPERATING A POWER TOOL. DO NOT USE TOOL WHILE TIRED OR UNDER THE INFLUENCE OF DRUGS, ALCOHOL, OR MEDICATION.** A moment of inattention while operating power tools may result in serious personal injury.

23. **MAKE SURE TOOL IS DISCONNECTED FROM POWER SUPPLY** while motor is being mounted, connected or reconnected.

24. **THE DUST GENERATED** by certain woods and wood products can be injurious to your health. Always operate machinery in well ventilated areas and provide for proper dust removal. Use wood dust collection systems whenever possible.

SAVE THESE INSTRUCTIONS.

Refer to them often and use them to instruct others.

ADDITIONAL SAFETY RULES FOR DUST COLLECTORS



WARNING: FAILURE TO FOLLOW THESE RULES MAY RESULT IN SERIOUS PERSONAL INJURY.

1. **DO NOT OPERATE THIS MACHINE** until it is **assembled** and **installed** according to the instructions.
2. **OBTAIN ADVICE FROM YOUR SUPERVISOR, instructor, or another qualified person** if you are not familiar with the operation of this machine.
3. **FOLLOW ALL WIRING CODES** and recommended electrical connections.
4. **DO NOT** leave the dust collector plugged into the electrical outlet. Unplug dust collector from the outlet when not in use and before servicing, changing bags, unclogging and cleaning.
5. **ALWAYS** turn all controls “OFF” before unplugging the dust collector.
6. **TO REDUCE THE RISK OF ELECTRICAL SHOCK**, do not use on wet surfaces. Do not expose to rain. Store indoors.
7. **DO NOT** use the dust collector to pick up flammable or combustible liquids, such as gasoline. **NEVER** use the dust collector near any flammable or combustible liquids.
8. **USE** the dust collector to pick up wood materials only. **DO NOT** use the dust collector to pick up metal shavings, metal dust, or metal parts.
9. **NEVER** use the dust collector to dissipate fumes or smoke. **NEVER** pick up anything that is burning or smoking, such as cigarettes, matches or hot ashes.
10. **DO NOT** pull the dust collector by the power cord. **NEVER** allow the power cord to come in contact with sharp edges, hot surfaces, oil or grease. Do not place anything over the top of the power cord.
11. **DO NOT** unplug the dust collector by pulling on the power cord. **ALWAYS** grasp the plug, not the cord.
12. **DO NOT** handle the plug or dust collector with wet hands.
13. **REPLACE** a damaged cord immediately. **DO NOT** use a damaged cord or plug. If the dust collector is not operating properly, or has been damaged, left outdoors or has been in contact with water, take it to an Authorized Service Center for service.
14. **DO NOT** use the dust collector as a toy. **DO NOT** use near or around children.
15. **DO NOT** insert fingers or foreign objects into the dust intake port or discharge port. Keep hair, loose clothing, fingers, and all body parts away from openings and moving parts of the dust collector.
16. **DO NOT** use with any opening blocked; keep openings free of dust, lint, hair, and anything that may reduce air flow.
17. **NEVER** use the dust collector without the dust collection bag in place and properly secured.
18. **ALWAYS** use intake cover to cover dust port when the dust collector is not in use or mounted to a supporting surface for storage.
19. **PERIODICALLY INSPECT** dust bag for any cuts, rips or tears. **NEVER** operate the dust collector with a damaged bag or vacuum hose.
20. **USE EXTRA CARE** when cleaning on stairs.
21. **TURN THE MACHINE “OFF” AND DISCONNECT THE MACHINE** from the power source before installing or removing accessories, before adjusting or changing set-ups, or when making repairs.
22. **TURN THE MACHINE “OFF”**, disconnect the machine from the power source, and clean the table/work area before leaving the machine. **LOCK THE SWITCH IN THE “OFF” POSITION** to prevent unauthorized use.
23. **ADDITIONAL INFORMATION** regarding the safe and proper operation of this tool is available from the Power Tool Institute, 1300 Summer Avenue, Cleveland, OH 44115-2851. Information is also available from the National Safety Council, 1121 Spring Lake Drive, Itasca, IL 60143-3201. Please refer to the American National Standards Institute ANSI 01.1 Safety Requirements for Woodworking Machines and the U.S. Department of Labor OSHA 1910.213 Regulations.

**SAVE THESE INSTRUCTIONS.
Refer to them often
and use them to instruct others.**

UNPACKING AND CLEANING

Carefully unpack the tool and all loose items from the shipping container(s). Remove the protective coating from all unpainted surfaces. This coating may be removed with a soft cloth moistened with kerosene (do not use acetone, gasoline or lacquer thinner for this purpose). After cleaning, cover the unpainted surfaces with a good quality household floor paste wax.

Fig. 2

- 1 - Swivel Casters (4)
- 2 - Base
- 3 - "U" Brackets For Filter Bag Support Rods (2)
- 4 - Left-Hand Drum
- 5 - Dust Chute
- 6 - Right-Hand Drum
- 7 - Eight-Hole Rubber Gaskets (2)
- 8 - Ten-Hole Rubber Gasket

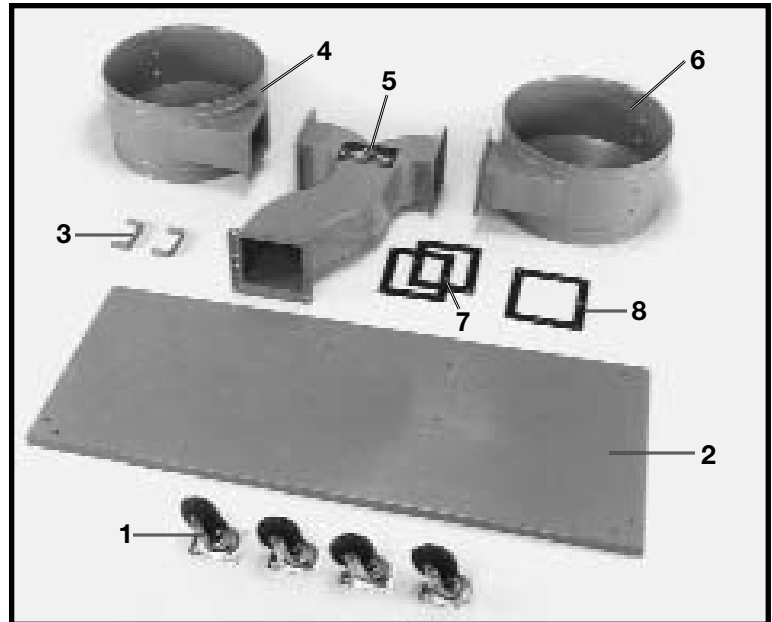

Fig. 2

Fig. 3

- 9 - Dust Collection Bags (2)
- 10 - Filter Bags (2)
- 11 - Drum Supports (4)
- 12 - Blower and Motor Assembly
- 13 - Intake Ports
- 14 - Intake Port Caps (4)
- 15 - Support Rods (2)
- 16 - Support Rod Extensions (2)
- 17 - Bag Locking Bands (4)
- 18 - Lower Dust Bag retaining Clips (8)



Fig. 3

Hardware (*not shown)

- * - 5/16 - 18 x 5/8 hex head screws (66)
- * - 5/16 lockwashers (66)
- * - 5/16 - 18 hex head nuts (12)
- * - M4 x 12 sheet metal screws (4)
- * - 5/16 x 15/16 O.D. flat washers (16)
- * - 1/4-20x5/8" Hex Head Screws (16)
- * - 1/4" Lockwashers (16)
- * - 1/4"-20 Hex Nuts (16)

ASSEMBLY

⚠ WARNING: FOR YOUR OWN SAFETY, DO NOT CONNECT THE MACHINE TO THE POWER SOURCE UNTIL THE MACHINE IS COMPLETELY ASSEMBLED AND YOU READ AND UNDERSTAND THE ENTIRE INSTRUCTION MANUAL.

ASSEMBLING CASTER ASSEMBLIES TO BASE

Align the holes in caster assembly (A) Fig. 5, with four holes in support stand (B) located on the underside of base (C). Place a lockwasher (E) Fig. 5 onto a hex head screw (D), insert the hex head screw through the caster (A), and thread into hole in base (B). Repeat this process for the three remaining holes in the caster and base. Assemble the three remaining caster assemblies to the base in the same manner. Fig. 6 shows a caster assembled to the base.

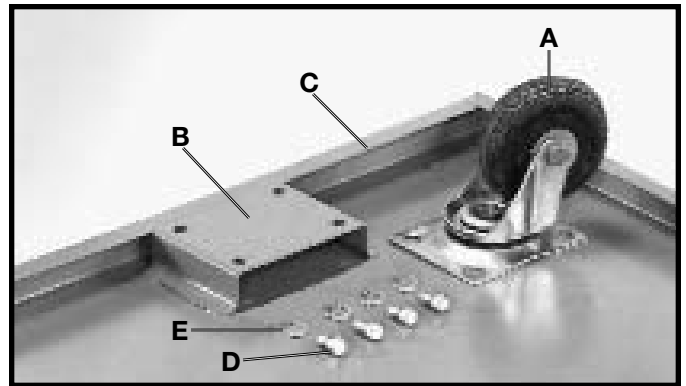

Fig. 5



Fig. 6

ASSEMBLING BLOWER AND MOTOR ASSEMBLY TO BASE

1. Set motor assembly (A) Fig. 7, on base (B).
2. Align mounting holes in the motor assembly (A) Fig. 7, with four pre-drilled holes in base (B). Place a lockwasher (D) Fig. 7, and a flat washer (E) onto hex head screw (C). Insert the hex head screw through the hole in the motor assembly, thread the screw into the hole in the base, and tighten securely. Repeat this process for the three remaining holes.

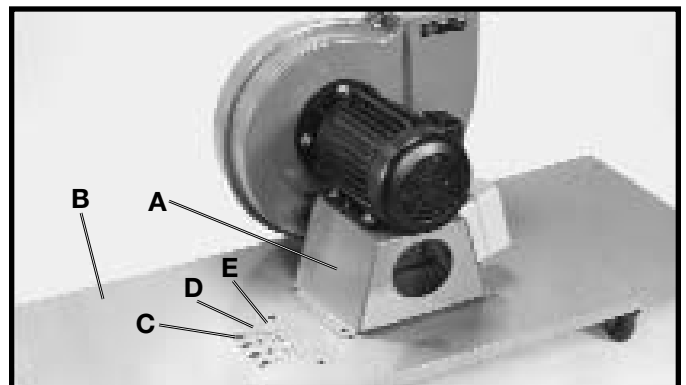

Fig. 7

3. Fig. 8, illustrates the motor assembly fastened to the base.



Fig. 8

4. Apply a bead of silicone sealant around flange of chute (F) Fig. 9. Align holes in ten-hole gasket (G) Fig. 9, with mounting holes in blower flange (F) and press gasket onto flange as shown.

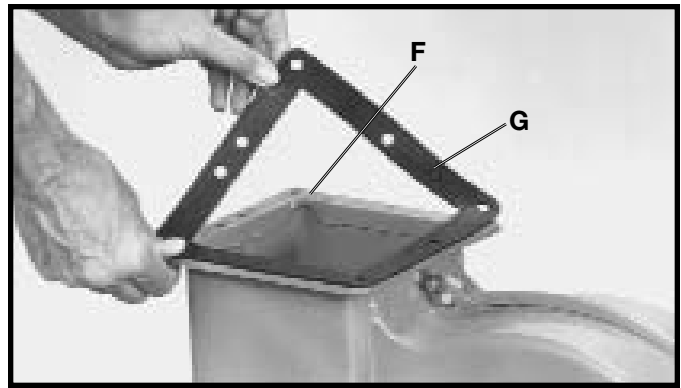

Fig. 9

5. Align mounting holes in dust chute (H) Fig. 10, with gasket (G), assembled in STEP 4. Place a lockwasher onto a hex head screw, insert screw through the chute and gasket, thread the screw into the motor assembly, and tighten securely. Repeat this process for the 9 remaining holes. Fig. 11 shows the dust chute assembled to the motor assembly.

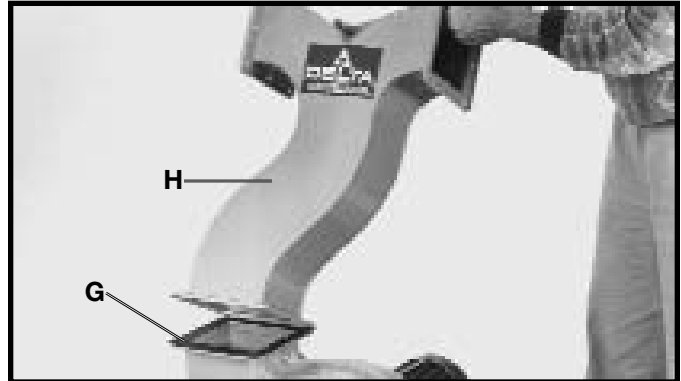

Fig. 10



Fig. 11

6. Align the two holes in "U" bracket (L) Fig. 12, with two pre-drilled holes (M) in left hand drum. Place a lockwasher (R), then a flat washer (S) onto the hex head screw (P). Insert the hex head screw through the hole in the "U" bracket and the hole in the drum, thread the hex nut (T) onto the hex head screw and tighten securely as shown in Fig. 13. Repeat this process for the remaining hole. Assemble the remaining "U" bracket to right hand drum in the same manner.

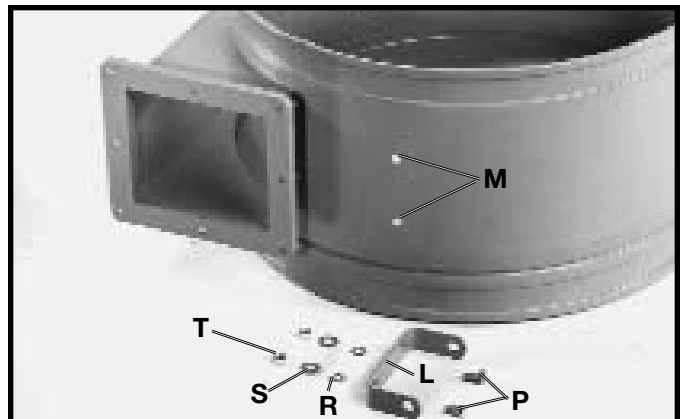

Fig. 12



Fig. 13

7. Apply a bead of silicone sealant around flange of chute (H) Fig. 14. Align holes in eight-hole gasket (K) Fig. 14, with mounting holes in chute (H) and press gasket (K) onto flange as shown.

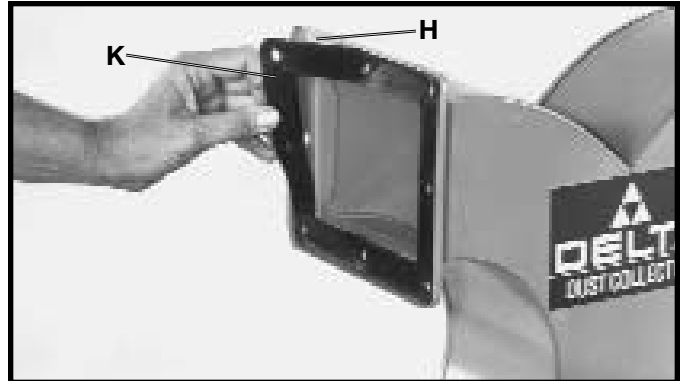

Fig. 14

8. Align mounting holes in left hand drum (N) Fig. 15, with gasket (K), assembled in STEP 7. Place a lockwasher onto a hex head screw, and insert screw through chute (H), thread screw into drum (N), and tighten securely as shown in Fig. 16. Repeat this process for the seven remaining holes.

9. Assemble the remaining eight hole gasket and right hand drum to the blower chute in the same manner.

10. Fig. 17, illustrates the drums assembled to the dust chute.

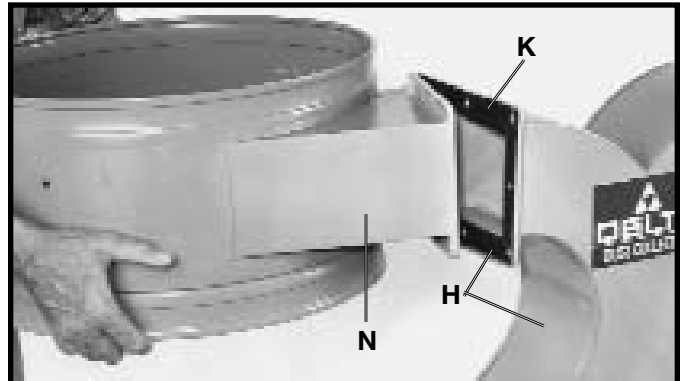

Fig. 15



Fig. 16

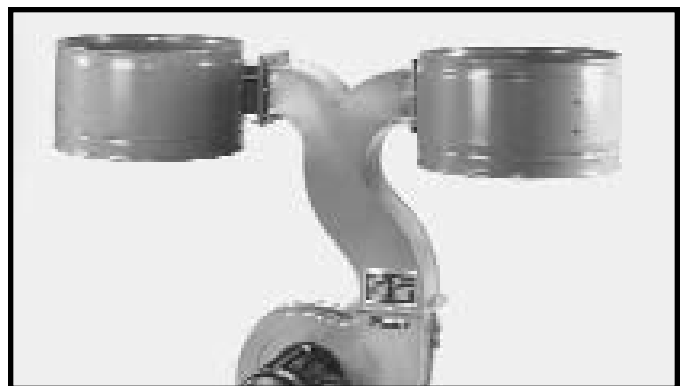

Fig. 17

11. Align two mounting holes in the top of drum support arm (T) Fig. 18, with two pre-drilled holes in drum (N) and fasten drum support arm (T) to drum (N). Place a lockwasher then a flat washer onto the hex head screw, insert the hex head screw through the hole in upper drum support and drum and thread a hex nut onto the hex head screw. **NOTE:** Do not completely tighten mounting hardware at this time.

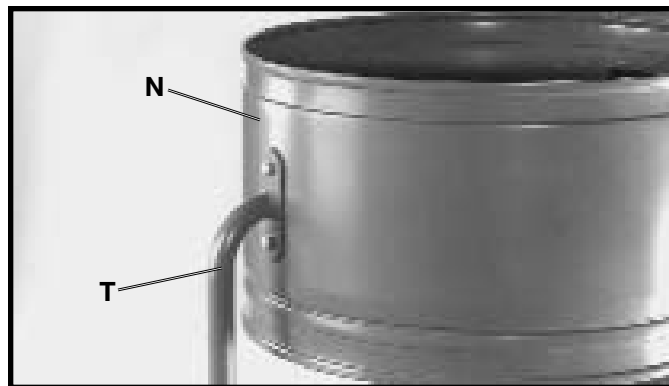

Fig. 18

12. Fasten the bottom of drum support (T) Fig. 19, at one corner of base (B). Place a lockwasher (X) onto a hex head screw (W) and insert the hex head screw through drum support arm (T) and thread into base (B). Fasten the remaining drum supports Fig. 20, to the other drum and base in the same manner.

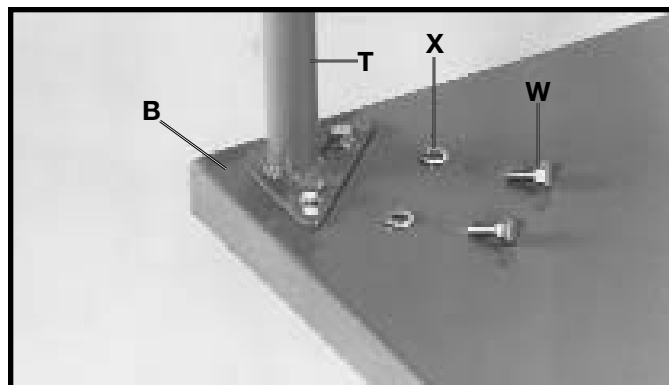

Fig. 19

13. Tighten all mounting hardware at this time.

14. Attach the lower dust bag retaining clip (A) Fig. 20, to the dust collector drum. Align the two holes in the retaining clip (A) Fig. 20, with the two holes in the drum. Insert a 1/4-20x5/8" hex head screw through the holes in the retaining clip and the holes in the drum. Place a 1/4" flat washer onto the screws, and thread 1/4-20 hex nut on the screws and tighten securely. Repeat this process for the three remaining sides of the drum and the other drum.

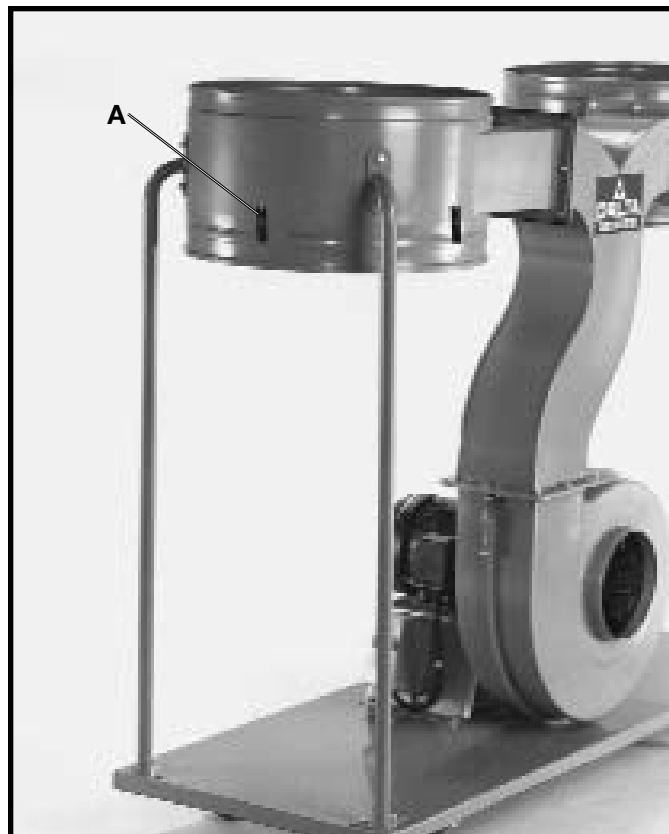

Fig. 20

14. Fig. 21, illustrates four drum supports assembled to the drums and base.



Fig. 21

ASSEMBLING FILTER AND DUST COLLECTION BAGS TO DRUM

1. Hook the loop on the top of filter bag (A) Fig. 22, onto filter bag support rod (B) as shown.
2. Assemble extension rod (C) Fig. 23, into the end of filter bag support rod (B). Raise support rods (B) and (C), with filter bag (A) attached and place end of extension support rod into holes of bracket (D). **NOTE:** Flared end of filter bag extension rod will prevent the rod from sliding through bracket.

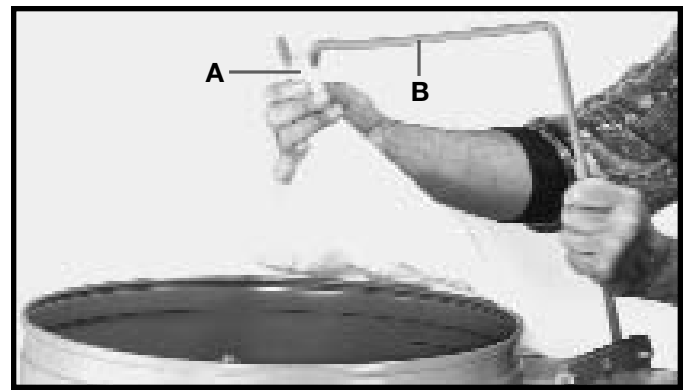

Fig. 22

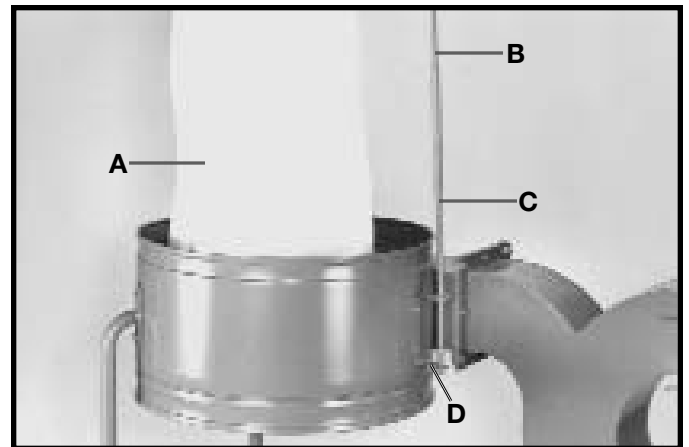

Fig. 23

3. Insert band (F) Fig. 24, through the loops of filter bag (A) Fig. 24, over upper lip of drum (E) and fasten with clamp (G) as shown in Fig. 25. **NOTE:** Make certain band (F) is positioned in the channel of drum (E) before fastening clamp (G).

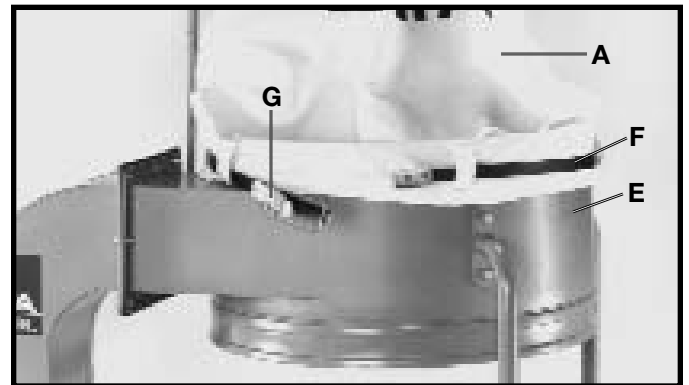

Fig. 24

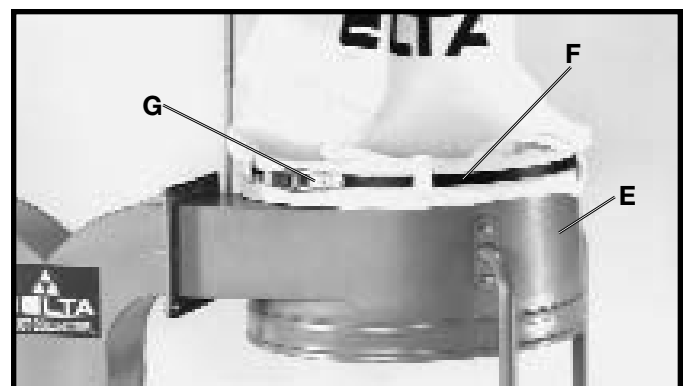

Fig. 25

4. Pull up on each retaining clip (A) Fig. 26, and insert the dust collection bag (B) underneath each retaining clip to hold the dust collection bag in place.

5. Place the locking clamp (C) Fig. 26 around dust collection bag and dust collector drum and lock in place.

NOTE: Make certain locking clamp is positioned in the channel of the dust collector drum before locking clamp.

6. Assemble the remaining filter bag and dust collection bag to the drum at the other side of the dust collector in the same manner.

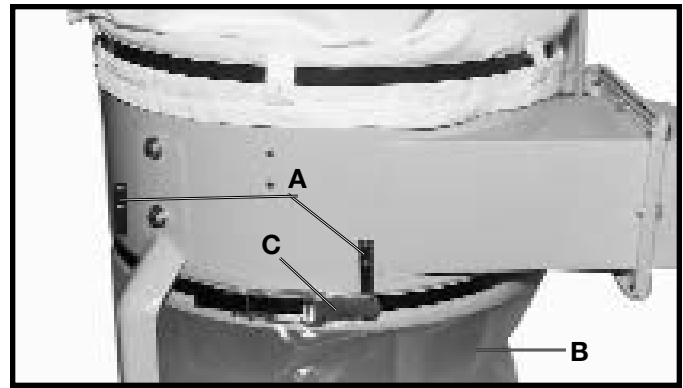

Fig. 26

6. Fig. 28, illustrates the filter and dust collection bags assembled to the dust collector.



Fig. 28

ASSEMBLING DUST INTAKE PORT TO BLOWER AND MOTOR ASSEMBLY

MAKE CERTAIN THE DUST COLLECTOR IS DISCONNECTED FROM THE POWER SOURCE.

1. Align the four holes in the dust intake port (A) Fig. 29, with the mounting holes in the lip of flange (B) of blower assembly and fasten with four sheet metal screws (C).

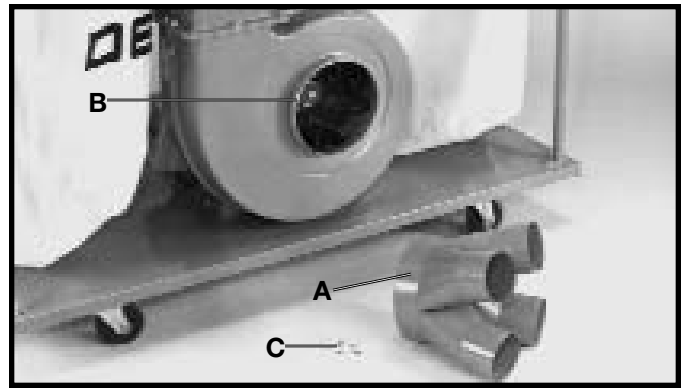

Fig. 29

2. Fig. 30, illustrates the dust intake ports assembled to the blower assembly.

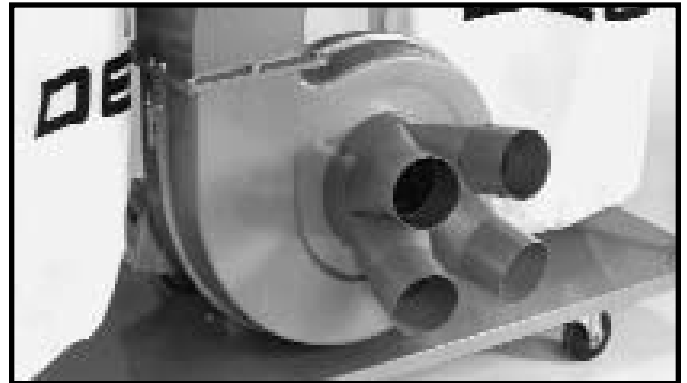

Fig. 30

3. Four dust intake port caps (D) Fig. 31, are supplied with the dust collector. These caps should be installed to cover any unused intake ports or when the dust collector is not in use.

⚠️ WARNING: DO NOT INSERT FINGERS INTO THE INTAKE PORTS WHEN UNIT IS OPERATING.

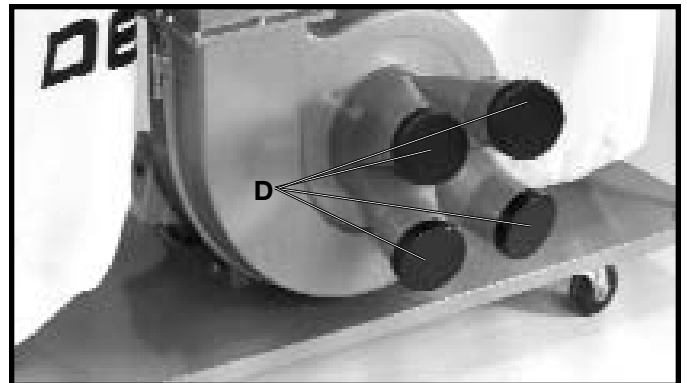

Fig. 31

CONNECTING MACHINE TO POWER SOURCE ELECTRICAL CONNECTIONS

The motor rating of your dust collector is either 230/460 Volt, Three Phase; or 230 Volt, Single Phase. Before connecting the motor to the power line, make sure the switch is in the "OFF" position and be sure that the electric current is of the same characteristics as indicated on the tool. All line connections should make good contact. Running on low voltage will damage the motor. **⚠️ WARNING: THIS TOOL MUST BE GROUNDED WHILE IN USE TO PROTECT THE OPERATOR FROM ELECTRIC SHOCK.**

MODEL 50-852 THREE PHASE INSTALLATION

Your dust collector is supplied with a motor and controller; however, it is not supplied with a power cord and plug.

1. To connect the dust collector to a power system, remove controller cover (A) Fig. 32.
2. Bring three phase power line through the access hole (B) Fig. 32, in the top of controller box and connect the three power lines to terminals (C) Fig. 33, and the green ground wire to ground screw (D).
3. After connecting the power cord to the machine, make certain the rotation of the motor is in the proper direction by viewing the rotation of the blower fan. The fan should rotate in a clockwise direction. **⚠️WARNING: DO NOT INSERT FINGERS OR ANY FOREIGN OBJECT INTO THE DUST INTAKE PORT.** Rotation of the motor can be reversed by interchanging any two of the three incoming power lines connected to terminals (C) Fig. 33.



Fig. 32

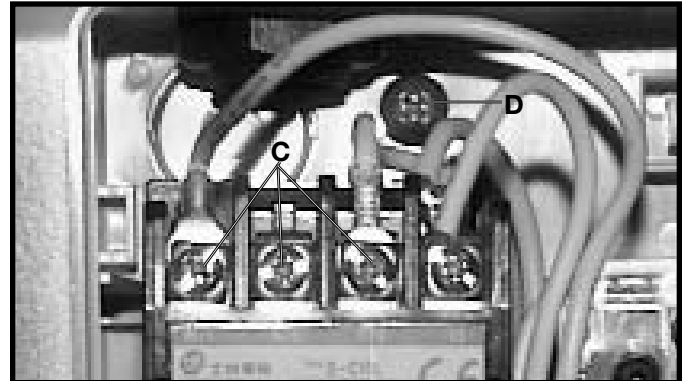

Fig. 33

MODEL 50-853 SINGLE PHASE INSTALLATION

Your dust collector is supplied with a motor and controller; however, it is not supplied with a power cord and plug.

1. To connect the dust collector to a power system, remove controller cover (A) Fig. 34.
2. Bring the single phase power line through the access hole (B) Fig. 34, in the top of controller box and connect the two power lines to terminals (E) Fig. 35, and the green ground wire to ground screw (F).
3. After connecting the power cord to the machine, the fan should rotate in a clockwise direction. **⚠️WARNING: DO NOT INSERT FINGERS OR ANY FOREIGN OBJECT INTO THE DUST INTAKE PORT.**

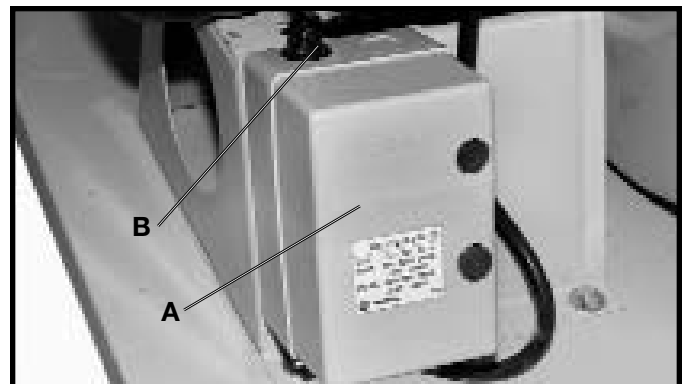

Fig. 34

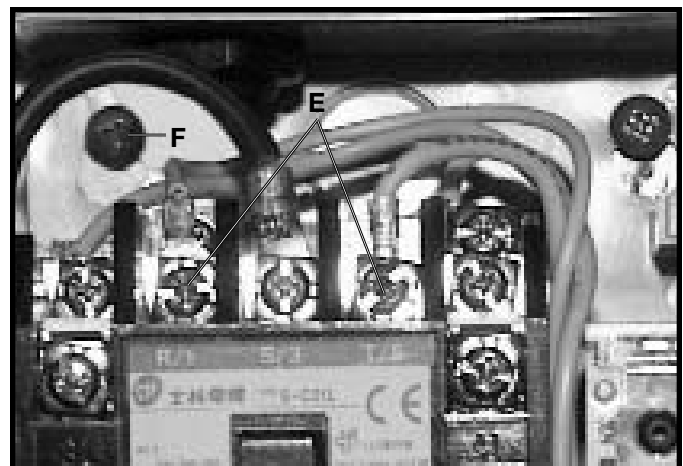

Fig. 35

OPERATING CONTROLS

ON/OFF SWITCH (Model 50-852)

The “on/off” switch is located on the side of the motor stand. To turn the dust collector “ON”, push button (A) Fig. 36. To turn the dust collector “OFF”, push button (B).

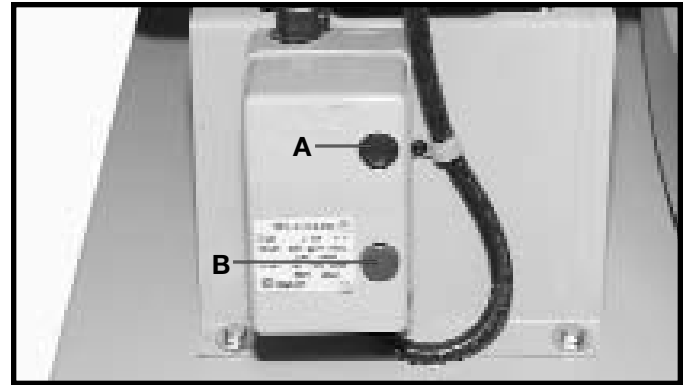

Fig. 36

ON/OFF SWITCH (Model 50-853)

The “on/off” switch is located on the side of the motor stand. To turn the dust collector “ON”, push button (A) Fig. 37. To turn the dust collector “OFF”, push button (B).

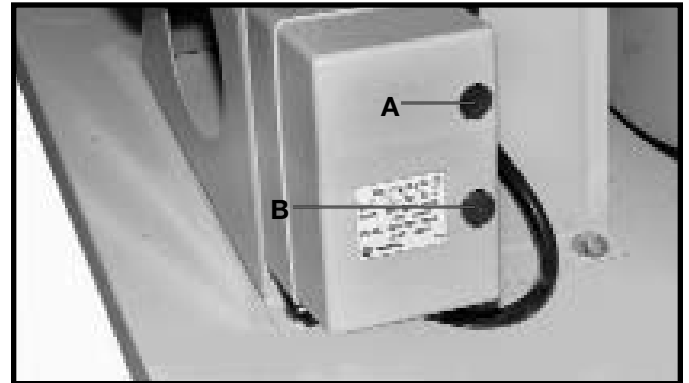

Fig. 37

MAINTENANCE

⚠ WARNING: Before any maintenance or service is performed, be sure that unit is disconnected from power source to prevent accidental starting.

MOTOR MAINTENANCE

Removing dust and dirt: Blow off motor with low pressure air to remove dust or dirt. Air pressure above 50 P.S.I. should not be used, as high pressure may damage insulation and blow dirt under loosened tape. The operator performing this cleaning function should always wear appropriate eye protective goggles. Built-up dust can cause excessive insulation temperatures, thereby affecting motor life.

NOTES

ACCESSORIES

A complete line of accessories is available from your Delta Supplier, Porter-Cable · Delta Factory Service Centers, and Delta Authorized Service Stations. Please visit our Web Site www.deltamachinery.com for a catalog or for the name of your nearest supplier.

 **WARNING:** Since accessories, other than those offered by Delta, have not been tested with this product, use of such accessories could be hazardous. For safest operation, only Delta recommended accessories should be used with this product.



PARTS, SERVICE OR WARRANTY ASSISTANCE

All Delta Machines and accessories are manufactured to high quality standards and are serviced by a network of Porter-Cable · Delta Factory Service Centers and Delta Authorized Service Stations. To obtain additional information regarding your Delta quality product or to obtain parts, service, warranty assistance, or the location of the nearest service outlet, please call 1-800-223-7278 (In Canada call 1-800-463-3582).



Two Year Limited Warranty

Delta will repair or replace, at its expense and at its option, any Delta machine, machine part, or machine accessory which in normal use has proven to be defective in workmanship or material, provided that the customer returns the product prepaid to a Delta factory service center or authorized service station with proof of purchase of the product within two years and provides Delta with reasonable opportunity to verify the alleged defect by inspection. Delta may require that electric motors be returned prepaid to a motor manufacturer's authorized station for inspection and repair or replacement. Delta will not be responsible for any asserted defect which has resulted from normal wear, misuse, abuse or repair or alteration made or specifically authorized by anyone other than an authorized Delta service facility or representative. Under no circumstances will Delta be liable for incidental or consequential damages resulting from defective products. This warranty is Delta's sole warranty and sets forth the customer's exclusive remedy, with respect to defective products; all other warranties, express or implied, whether of merchantability, fitness for purpose, or otherwise, are expressly disclaimed by Delta.

PORTER-CABLE • DELTA SERVICE CENTERS (CENTROS DE SERVICIO DE PORTER-CABLE • DELTA)

Parts and Repair Service for Porter-Cable • Delta Machinery are Available at These Locations
(Obtenga Refaccion de Partes o Servicio para su Herramienta en los Siguientes Centros de Porter-Cable • Delta)

ARIZONA

Tempe 85282 (Phoenix)
2400 West Southern Avenue
Suite 105
Phone: (602) 437-1200
Fax: (602) 437-2200

CALIFORNIA

Ontario 91761 (Los Angeles)
3949A East Guasti Road
Phone: (909) 390-5555
Fax: (909) 390-5554

San Leandro 94577 (Oakland)
3039 Teagarden Street
Phone: (510) 357-9762
Fax: (510) 357-7939

COLORADO

Arvada 80003 (Denver)
8175 Sheridan Blvd., Unit S
Phone: (303) 487-1809
Fax: (303) 487-1868

FLORIDA

Davie 33314 (Miami)
4343 South State Rd. 7 (441)
Unit #107
Phone: (954) 321-6635
Fax: (954) 321-6638

Tampa 33609
4538 W. Kennedy Boulevard
Phone: (813) 877-9585
Fax: (813) 289-7948

GEORGIA

Forest Park 30297 (Atlanta)
5442 Frontage Road,
Suite 112
Phone: (404) 608-0006
Fax: (404) 608-1123

ILLINOIS

Addison 60101 (Chicago)
400 South Rohlwing Rd.
Phone: (630) 424-8805
Fax: (630) 424-8895

Woodridge 60517 (Chicago)
2033 West 75th Street
Phone: (630) 910-9200
Fax: (630) 910-0360

MARYLAND

Elkridge 21075 (Baltimore)
7397-102 Washington Blvd.
Phone: (410) 799-9394
Fax: (410) 799-9398

MASSACHUSETTS

Braintree 02185 (Boston)
719 Granite Street
Phone: (781) 848-9810
Fax: (781) 848-6759

Franklin 02038 (Boston)
Franklin Industrial Park
101E Constitution Blvd.
Phone: (508) 520-8802
Fax: (508) 528-8089

MICHIGAN

Madison Heights 48071 (Detroit)
30475 Stephenson Highway
Phone: (248) 597-5000
Fax: (248) 597-5004

MINNESOTA

Minneapolis 55429
5522 Lakeland Avenue North
Phone: (763) 561-9080
Fax: (763) 561-0653

MISSOURI

North Kansas City 64116
1141 Swift Avenue
P.O. Box 12393
Phone: (816) 221-2070
Fax: (816) 221-2897

St. Louis 63119
7574 Watson Road
Phone: (314) 968-8950
Fax: (314) 968-2790

NEW YORK

Flushing 11365-1595 (N.Y.C.)
175-25 Horace Harding Expwy.
Phone: (718) 225-2040
Fax: (718) 423-9619

NORTH CAROLINA

Charlotte 28270
9129 Monroe Road, Suite 115
Phone: (704) 841-1176
Fax: (704) 708-4625

OHIO

Columbus 43214
4560 Indianola Avenue
Phone: (614) 263-0929
Fax: (614) 263-1238

Cleveland 44125
8001 Sweet Valley Drive
Unit #19
Phone: (216) 447-9030
Fax: (216) 447-3097

OREGON

Portland 97230
4916 NE 122 nd Ave.
Phone: (503) 252-0107
Fax: (503) 252-2123

PENNSYLVANIA

Willow Grove 19090
520 North York Road
Phone: (215) 658-1430
Fax: (215) 658-1433

TEXAS

Carrollton 75006 (Dallas)
1300 Interstate 35 N, Suite 112
Phone: (972) 446-2996
Fax: (972) 446-8157

Houston 77055
West 10 Business Center
1008 Wirt Road, Suite 120
Phone: (713) 682-0334
Fax: (713) 682-4867

WASHINGTON

Auburn 98001 (Seattle)
3320 West Valley HWY, North
Building D, Suite 111
Phone: (253) 333-8353
Fax: (253) 333-9613

Authorized Service Stations are located in many large cities. Telephone **800-438-2486** or **731-541-6042** for assistance locating one. Parts and accessories for Porter-Cable-Delta products should be obtained by contacting any Porter-Cable-Delta Distributor, Authorized Service Center, or Porter-Cable-Delta Factory Service Center. If you do not have access to any of these, call **800-223-7278** and you will be directed to the nearest Porter-Cable-Delta Factory Service Center. Las Estaciones de Servicio Autorizadas están ubicadas en muchas grandes ciudades. Llame al **800-438-2486** ó al **731-541-6042** para obtener asistencia a fin de localizar una. Las piezas y los accesorios para los productos Porter-Cable-Delta deben obtenerse poniéndose en contacto con cualquier distribuidor Porter-Cable-Delta, Centro de Servicio Autorizado o Centro de Servicio de Fábrica Porter-Cable-Delta. Si no tiene acceso a ninguna de estas opciones, llame al **800-223-7278** y le dirigirán al Centro de Servicio de Fábrica Porter-Cable-Delta más cercano.

CANADIAN PORTER-CABLE • DELTA SERVICE CENTERS

ALBERTA

Bay 6, 2520-23rd St. N.E.
Calgary, Alberta
T2E 8L2
Phone: (403) 735-6166
Fax: (403) 735-6144

BRITISH COLUMBIA

8520 Baxter Place
Burnaby, B.C.
V5A 4T8
Phone: (604) 420-0102
Fax: (604) 420-3522

MANITOBA

1699 Dublin Avenue
Winnipeg, Manitoba
R3H 0H2
Phone: (204) 633-9259
Fax: (204) 632-1976

ONTARIO

505 Southgate Drive
Guelph, Ontario
N1H 6M7
Phone: (519) 836-2840
Fax: (519) 767-4131

QUÉBEC

1515 ave.
St-Jean Baptiste,
Québec, Québec
G2E 5E2
Phone: (418) 877-7112
Fax: (418) 877-7123

1447, Begin
St-Laurent, (Montréal),
Québec
H4R 1V8
Phone: (514) 336-8772
Fax: (514) 336-3505

The following are trademarks of PORTER-CABLE-DELTA (Las siguientes son marcas registradas de PORTER-CABLE S.A.): Auto-Set®, BAMMER®, B.O.S.S.®, Builder's Saw®, Contractor's Saw®, Contractor's Saw II™, Delta®, DELTACRAFT®, DELTAGRAM™, Delta Series 2000™, DURATRONIC™, Emc²™, FLEX®, Flying Chips™, FRAME SAW®, Homecraft®, INNOVATION THAT WORKS®, Jet-Lock®, JETSTREAM®, 'kickstand'®, LASERLOC®, MICRO-SET®, Micro-Set®, Midi Lathe™, MORTEN™, NETWORK™, OMNIJIG®, POCKET CUTTER®, PORTA-BAND®, PORTA-PLANE®, PORTER-CABLE®(design), PORTER-CABLE®PROFESSIONAL POWER TOOLS, Posi-Matic®, Q-3®(design), QUICKSAND®(design), QUICKSET™, QUICKSET II®, QUICKSET PLUS™, RIPTIDE™(design), SAFE GUARD II®, SAFE-LOC®, Sanding Center®, SANDTRAP®(design), SAW BOSS®, Sawbuck™, Sidekick®, SPEED-BLOC®, SPEEDMATIC®, SPEEDTRONIC®, STAIR EASE®, The American Woodshop®(design), The Lumber Company®(design), THE PROFESSIONAL EDGE®, THE PROFESSIONAL SELECT®, THIN-LINE™, TIGER®, TIGER CUB®, TIGER SAW®, TORQBUSTER®, TORQ-BUSTER®, TRU-MATCH™, TWIN-LITE®, UNIGUARD®, Unifence®, UNIFEEDER™, Unihead®, Uniplane™, Unirip®, Unisaw®, Univise®, Versa-Feeder®, VERSA-PLANE®, WHISPER SERIES®, WOODWORKER'S CHOICE™.

Trademarks noted with ™ and ® are registered in the United States Patent and Trademark Office and may also be registered in other countries. Las Marcas Registradas con el signo de ™ y ® son registradas por la Oficina de Registros y Patentes de los Estados Unidos y también pueden estar registradas en otros países.

Printed in U.S.A.

Free Manuals Download Website

<http://myh66.com>

<http://usermanuals.us>

<http://www.somanuals.com>

<http://www.4manuals.cc>

<http://www.manual-lib.com>

<http://www.404manual.com>

<http://www.luxmanual.com>

<http://aubethermostatmanual.com>

Golf course search by state

<http://golfingnear.com>

Email search by domain

<http://emailbydomain.com>

Auto manuals search

<http://auto.somanuals.com>

TV manuals search

<http://tv.somanuals.com>