

Dell™ PowerEdge™ RAID
Controller (PERC) H200 and
6Gbps SAS HBA
User's Guide



Notes, Cautions, and Warnings



NOTE: A NOTE indicates important information that helps you make better use of your computer.



CAUTION: A CAUTION indicates potential damage to hardware or loss of data if instructions are not followed.



WARNING: A WARNING indicates a potential for property damage, personal injury, or death.

Information in this publication is subject to change without notice.

© 2009-2010 Dell Inc. All rights reserved.

Reproduction of these materials in any manner whatsoever without the written permission of Dell Inc. is strictly forbidden.

Trademarks used in this text: *Dell*, the *DELL* logo, *PowerEdge*, and *OpenManage* are trademarks of Dell Inc.; *Microsoft*, *Windows* and *Windows Server* are either trademarks or registered trademarks of Microsoft Corporation in the United States and/or other countries; *Novell*, *NetWare*, and *SUSE* are registered trademarks of Novell, Inc. in the United States and other countries; *Red Hat* and *Red Hat Enterprise Linux* are registered trademarks of Red Hat Inc. in the United States and other countries.

Other trademarks and trade names may be used in this document to refer to either the entities claiming the marks and names or their products. Dell Inc. disclaims any proprietary interest in trademarks and trade names other than its own.

UCS-71, UCS-70, and UCSM-70

July 2010

Rev. A01

Contents

1	CAUTION: Safety Instructions	9
	SAFETY: General	9
	SAFETY: When Working Inside Your System	10
	Protecting Against Electrostatic Discharge	10
	SAFETY: Battery Disposal	11
2	Overview	13
	Operating System Support	14
	About RAID	15
	RAID Levels	15
	RAID Terminology	15
	RAID 0	15
	RAID 1	16
	RAID 10	17
3	PERC H200 and 6Gbps SAS HBA Features	19
	LED Port Activity Feature for 6Gbps SAS HBA Only	22
	Physical Disk Cache Policy	23
	Unsupported Drives	23

4	Hardware Installation	25
	Installing the PERC H200 and 6Gbps SAS HBA Cards.	25
	Installing the PERC H200 Modular Card	28
5	Driver Installation	31
	Installing the Windows Driver.	32
	Creating the Driver Media	32
	Pre-Installation Requirements	32
	Installing the Driver During a Windows Server 2003 Operating System Installation	33
	Installing the Driver During a Windows Server 2008 or Windows Server 2008 R2 Installation	34
	Installing a Windows Server 2003, Windows Server 2008 or Windows Server 2008 R2 Driver for a New RAID Controller	35
	Updating the Windows Driver	36
	Installing Linux Driver	37
	Creating a DUD	37
	Creating a DUD Using DKMS	39
	Installing Red Hat Enterprise Linux Operating System Using the DUD	39
	Installing SUSE Linux Enterprise Server Using the DUD	40
	Installing the RPM Package With DKMS Support	40
	Upgrading the Kernel	41

6 PERC H200 and 6Gbps SAS HBA BIOS	43
POST Messages	43
BIOS Fault Code Messages	43
Booting With Multiple Controllers	44
Configuration Utility	44
Starting the Configuration Utility	44
Functions Performed	44
RAID Configuration and Management Screens	46
Select New Volume Type	47
Create New Volume	47
View Volume	50
Manage Volume	50
Exit Screen	51
Performing Configuration Tasks	51
Creating a RAID 0 Virtual Disk	52
Creating a RAID 1 Virtual Disk	53
Creating a RAID 10 Virtual Disk	54
Viewing Virtual Disk Properties	55
Activating a Virtual Disk	56
Migrating and Activating a Virtual Disk	57
Deleting a Virtual Disk	57
Hot Spare Failover	57
Replacing and Rebuilding a Degraded Virtual Disk	58
Assigning a Preferred Boot Device	58

7	Troubleshooting	61
	BIOS Boot Order	61
	Background Activities	61
	General Issues	61
	Physical Disk Related Issues	62
	Configuration Utility Error Messages	63
	BIOS Error Messages	65
A	Updating the Firmware	71
	Firmware Package Update Utility	71
B	Getting Help	73
	Technical Support and Customer Service	73
	Online Services	74
	Automated Order-Status Service	75
	Dell Enterprise Training	75
	Problems With Your Order	75
	Product Information	75
	Returning Items for Warranty Repair or Credit	76
	Before You Call	76

C Regulatory Notices	77
D Corporate Contact Details (Taiwan Only).	79
Glossary	81
Index	91



CAUTION: Safety Instructions

Use the following safety guidelines to help ensure your own personal safety and to help protect your system and working environment from potential damage.



WARNING: There is a danger of a new battery exploding if it is incorrectly installed. Replace the battery only with the same or equivalent type recommended by the manufacturer. See "SAFETY: Battery Disposal" on page 11.



NOTE: For complete information on U.S. Terms and Conditions of Sale, Limited Warranties and Returns, Export Regulations, Software License Agreement, Safety, Environmental and Ergonomic Instructions, Regulatory Notices, and Recycling Information, see the Safety, Environmental and Regulatory Information, End User License Agreement, and Warranty and Support Information that shipped with your system.

SAFETY: General

- Observe and follow service markings. Do not service any product except as explained in your user documentation. Opening or removing covers that are marked with the triangular symbol with a lightning bolt may expose you to electrical shock. Components inside these compartments must be serviced only by a trained service technician.
- If any of the following conditions occur, unplug the product from the electrical outlet, and replace the part or contact your trained service provider:
 - The power cable, extension cable, or plug is damaged.
 - An object has fallen in the product.
 - The product has been exposed to water.
 - The product has been dropped or damaged.
 - The product does not operate correctly when you follow the operating instructions.
- Use the product only with approved equipment.
- Operate the product only from the type of external power source indicated on the electrical ratings label. If you are not sure of the type of power source required, consult your service provider or local power company.
- Handle batteries carefully. Do not disassemble, crush, puncture, short external contacts, dispose of in fire or water, or expose batteries to temperatures higher than 60° Celsius (140° Fahrenheit). Do not attempt to open or service batteries; replace batteries only with batteries designated for the product.

SAFETY: When Working Inside Your System

Before you remove the system covers, perform the following steps in the sequence indicated.

 **CAUTION: Except as expressly otherwise instructed in Dell documentation, only trained service technicians are authorized to remove the system cover and access any of the components inside the system.**

 **CAUTION: To help avoid possible damage to the system board, wait 5 seconds after turning off the system before removing a component from the system board or disconnecting a peripheral device.**

- 1 Turn off the system and any connected devices.
- 2 Disconnect your system and devices from their power sources. To reduce the potential of personal injury or shock, disconnect any telecommunication lines from the system.
- 3 Ground yourself by touching an unpainted metal surface on the chassis before touching anything inside the system.
- 4 While you work, periodically touch an unpainted metal surface on the chassis to dissipate any static electricity that might harm internal components.

In addition, take note of these safety guidelines when appropriate:

- When you disconnect a cable, pull on its connector or on its strain-relief loop, not on the cable itself. Some cables have a connector with locking tabs. If you are disconnecting this type of cable, press in on the locking tabs before disconnecting the cable. As you pull connectors apart, keep them evenly aligned to avoid bending any connector pins. Also, when you connect a cable, make sure both connectors are correctly oriented and aligned.
- Handle components and cards with care. Do not touch the components or contacts on a card. Hold a card by its edges or by its metal mounting bracket. Hold a component such as a microprocessor chip by its edges, not by its pins.

Protecting Against Electrostatic Discharge

Electrostatic discharge (ESD) events can harm electronic components inside your system. Under certain conditions, ESD may build up on your body or an object, such as a peripheral, and then discharge into another object, such as your system. To prevent ESD damage, you must discharge static electricity from your body before you interact with any of your system's internal electronic components, such as a memory module. You can protect against ESD by touching a metal grounded object (such as an unpainted metal surface on your system's I/O panel) before you interact with anything electronic. When connecting a peripheral (including handheld digital assistants) to your system, you should always ground both yourself and the peripheral before connecting it to the system. Additionally, as you work inside the system, periodically touch an I/O connector to remove any static charge your body may have accumulated.

You can also take the following steps to prevent damage from electrostatic discharge:

- When unpacking a static-sensitive component from its shipping carton, do not remove the component from the antistatic packing material until you are ready to install the component. Just before unwrapping the antistatic package, be sure to discharge static electricity from your body.
- When transporting a sensitive component, first place it in an antistatic container or packaging.
- Handle all electrostatic sensitive components in a static-safe area. If possible, use antistatic floor pads and work bench pads.

SAFETY: Battery Disposal



Your system may use a nickel-metal hydride (NiMH), lithium coin-cell, and/or a lithium-ion battery. The NiMH, lithium coin-cell, and lithium-ion batteries are long-life batteries, and it is possible that you will never need to replace them.



NOTE: Do not dispose of the battery along with household waste. Contact your local waste disposal agency for the address of the nearest battery deposit site.



NOTE: Your system may also include circuit cards or other components that contain batteries. These batteries too must be disposed of in a battery deposit site. For information about such batteries, see the documentation for the specific card or component.

Taiwan Battery Recycling Mark



廢電池請回收

Overview

The Dell™ PowerEdge™ RAID Controller (PERC) H200 and the 6Gbps SAS HBA cards are part of the third generation of the Dell Serial-Attached SCSI (SAS) RAID controllers. The PERC H200 and 6Gbps SAS HBA cards comply with the T10 SAS 2.0 specification, providing upto 6 Gb/sec throughput, and improved hardware performance.

The PERC H200 card has integrated RAID capabilities and enables support for Dell-qualified hard drives and solid-state drives (SSD). The card also enables support for internal tape drives in PowerEdge systems only. The 6Gbps SAS HBA provides support for Dell-supported external SAS tape devices.

The PERC H200 and 6Gbps SAS HBA cards are all standard half-length, half-height PCI-E cards, except for the PERC H200 Integrated Modular controller on the blade systems.

The PERC H200 and 6Gbps SAS HBA cards are supported with PCI-E x8 link width. The cards can be used on platforms with PCI-E x8 and x16 connectors, and communicates with SAS devices using 2x4 mini-SAS external connectors. The PERC H200 Integrated Modular controller supports PCI-E x4 link width only.

Key features of the PERC H200 and 6Gbps SAS HBA cards include

- SAS 2.0 compliance, 6Gb/sec throughput
- RAID 0, RAID 1, and RAID 10 functionality
- Support for SSDs
- Support for LT03 060, LT04, and LT05 tape drives
- Support for full hardware Transport Layer Retry (TLR), to improve maximum tape throughput
- Mini-SAS connectors
- PCI-E 2.0 compliant to key features
- Support for two global hotspares

Figure 2-1. 6Gbps SAS HBA Hardware Architecture

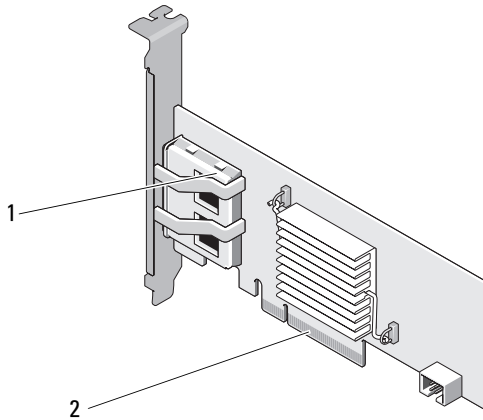

1 2 x4 external SAS connectors 2 PCI-E connector

Operating System Support

The PERC H200 and 6Gbps SAS HBA cards support the following operating systems:

- Microsoft® Windows Server® 2003 family
- Microsoft Windows Server 2008 family, including Hyper-V Virtualization
- Microsoft Windows Server 2008 R2
- Red Hat® Enterprise Linux® version 4.7, version 4.8, and version 5.3
- SUSE® Linux Enterprise Server version 10 Service Pack 2 (64-bit only), version 10 Service Pack 3 (64-bit only), and version 11 (64-bit only)
- Sun® Solaris™ 10 (64-bit)
- VMware® ESX 4.0 Update 1



NOTE: For the latest list of supported operating systems and driver installation instructions, see the system documentation on the Dell Support website at support.dell.com/manuals. For specific operating system service pack requirements, see the **Drivers and Downloads** section on the Dell Support website at support.dell.com.

About RAID

RAID is a group of multiple independent physical disks that provide high performance or better data availability by increasing the number of drives used for saving and accessing data. A RAID disk subsystem improves I/O performance and data availability. The physical disk group appears to the host system as a single storage unit. Data throughput improves because multiple disks can be accessed simultaneously. RAID systems also improve data storage availability and fault tolerance.

RAID Levels

- RAID 0 uses disk striping to provide high data throughput, especially for large files in an environment that requires no data redundancy.
- RAID 1 uses disk mirroring so that data written to one physical disk is simultaneously written to another physical disk. This is good for small databases or other applications that require small capacity, but complete data redundancy.
- RAID 10, a combination of RAID 0 and RAID 1, uses disk striping across mirrored disks. It provides high data throughput and complete data redundancy.



CAUTION: Lost data on a RAID 0 disk cannot be recovered in the event of a physical disk failure.

RAID Terminology

RAID 0

RAID 0 allows you to write data across multiple physical disks instead of just one physical disk. RAID 0 involves partitioning each physical disk storage space into 64 KB stripes. These stripes are interleaved in a repeated sequential manner. The part of the stripe on a single physical disk is called a stripe element.

For example, in a four-disk system using only RAID 0, segment 1 is written to disk 1, segment 2 is written to disk 2, and so on. RAID 0 enhances performance because multiple physical disks are accessed simultaneously, but it does not provide data redundancy. Figure 2-2 shows an example of RAID 0.

Figure 2-2. Example of RAID 0

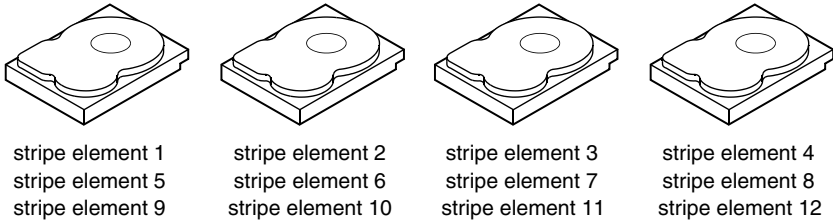

RAID 1

With RAID 1, data written to one disk is simultaneously written to another disk. If one disk fails, the contents of the other disk can be used to run the system and rebuild the failed physical disk. The primary advantage of RAID 1 is that it provides 100 percent data redundancy. Because the contents of the disk are completely written to a second disk, the system can sustain the failure of one disk. Both disks contain the same data at all times. Either physical disk can act as the operational physical disk.

 **NOTE:** Mirrored physical disks improve read performance by read load balance.

Figure 2-3. Example of RAID 1



RAID 10

RAID 10 requires two or more mirrored sets working together. Multiple RAID 1 sets are combined to form a single array. Data is striped across all mirrored drives. Since each drive is mirrored in RAID 10, no delay is encountered because no parity calculation is done. This RAID strategy can tolerate the loss of multiple drives as long as two drives of the same mirrored pair do not fail. RAID 10 volumes provide high data throughput and complete data redundancy.

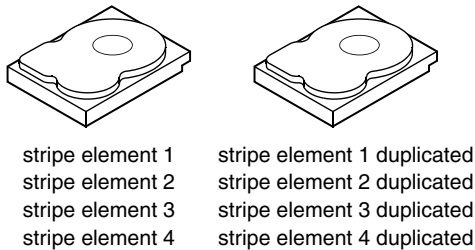
Figure 2-4. Example of RAID 10

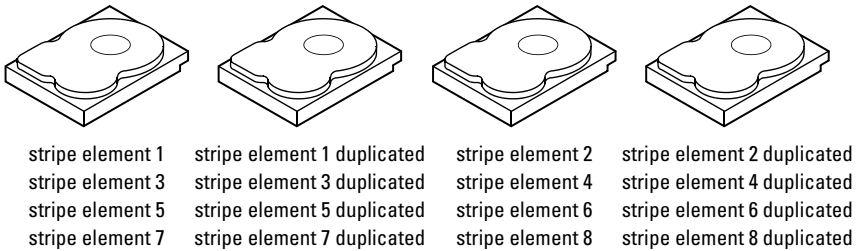

PERC H200 and 6Gbps SAS HBA Features

This section provides the specifications of the Dell™ PowerEdge™ RAID Controller (PERC) H200 and 6Gbps SAS HBA cards.

Table 3-1 compares the specifications of the PERC H200 Adapter and PERC H200 Integrated and PERC H200 Modular cards.

Table 3-1. Specifications of PERC H200

Specification	PERC H200 Adapter	PERC H200 Integrated	PERC H200 Modular
SAS technology	Yes	Yes	Yes
Support for x4 or x8 PCI-E Host Interface	Yes	Yes	Yes
Form Factor	Half-Height, Half-Length PCI Adapter	Half-Height, Half-Length PCI Adapter	Custom
I/O Controller (IOC)	LSI SAS 2008 Core Speed: 533 MHz	LSI SAS 2008 Core Speed: 533 MHz	LSI SAS 2008 Core Speed: 533 MHz
Operating voltage requirements	+12V, +3.3V, +3.3Vaux	+12V, +3.3V, +3.3Vaux	+12V, +3.3V, +3.3Vaux
Communication to the system	PCI-E lanes	PCI-E lanes	System dependent
Communication to end devices	SAS Links	SAS Links	SAS Links
SAS Connectors	2x4 internal	2x4 internal	SAS connectivity routed through PCI-E connector
Lead Free	Yes	Yes	Yes

Table 3-1. Specifications of PERC H200 (continued)

Specification	PERC H200 Adapter	PERC H200 Integrated	PERC H200 Modular
Supported operating systems	Microsoft® Windows Server® 2003 family, Microsoft Windows Server 2008 family, Windows Server 2008 R2, Red Hat® Enterprise Linux® version 4 Update 7 and later, version 5 Update 3 and later, SUSE® Linux Enterprise Server version 10 Service Pack 2 and later (64-bit only), and version 11 Gold and later (64-bit only).		
Dell-compliant SAS and SATA compatibility	Yes	Yes	Yes
Dell supported direct connected end devices	Dell-compliant physical disks	Dell-compliant physical disks	Dell-compliant physical disks
SMART error support through management applications	Yes	Yes	Yes
Backplane supported systems	Yes	Yes	Yes
Hardware-based RAID	RAID 0, RAID 1, RAID 10	RAID 0, RAID 1, RAID 10	RAID 0, RAID 1, RAID 10
Maximum number of virtual disks	2	2	2
Storage management software	Dell OpenManage™ Storage Services	OpenManage Storage Services	OpenManage Storage Services
NOTE: The management software that is supported depends on the specific platform.			
Support for internal tape drive	Yes	No	No
Support for Global Hotspare	Yes	Yes	Yes
Maximum number of physical disks	16	16	4

Table 3-1. Specifications of PERC H200 (continued)

Specification	PERC H200 Adapter	PERC H200 Integrated	PERC H200 Modular
Maximum number of physical disks configured in a single RAID disk	10	10	4
Maximum number of configured disks (including hot spares)	14	14	4
NOTE: The actual number of drives that is supported depends on the specific platform and expander support.			
6Gbps Expander Support	Yes	Yes	No
Maximum number of Hotspares	2	2	2

Table 3-2 lists the specifications of the 6Gbps SAS HBA.

Table 3-2. Specifications of 6Gbps SAS HBA

Specification	6Gbps SAS HBA
SAS technology	Yes
Support for x8, or x8 Full-Size PCI Express Host Interface	Yes
Form Factor	Half-Size, Half-Length PCI Adapter
I/O controller (IOC)	LSI SAS 2008
Core Speed	533 MHz
Operating voltage requirements	+12V, +3.3V, +3.3Vaux
Communication to the system	PCI-E lanes
Communication to end devices	SAS Links
Connectors	2x4 Mini-SAS

Table 3-2. Specifications of 6Gbps SAS HBA

Specification	6Gbps SAS HBA
Lead Free	Yes
Supported operating systems	Microsoft Windows Server 2003 family, Microsoft Windows Server 2008 family, Windows Server 2008 R2, Red Hat Enterprise Linux version 4 Update 7 and later, version 5 Update 3 and later, SUSE Linux Enterprise Server version 10 Service Pack 2 and later (64-bit only), and version 11 Gold and later (64-bit only).
Dell-compliant SAS and SATA compatibility	Yes
Dell-supported direct connected end devices	Dell-supported external tape devices.
Hot add or Hot remove of end devices	Yes
Support for external tape drive	Yes
Port activity or status LEDs	Yes
Hardware-based RAID	No

LED Port Activity Feature for 6Gbps SAS HBA Only

The 6Gbps SAS HBA controllers are equipped with port activity or status LEDs. The LEDs enable you to quickly determine the status of an external SAS port. Each x4 connector has its own set of LEDs.

Table 3-3 describes the color of the LEDs and corresponding SAS port state.

Table 3-3. x4 Connector LEDs Description

LED Color	SAS Port State
Off	It means any one of the following: <ul style="list-style-type: none">• Power is off.• Port has been reset.• All links in the port are either disconnected or the cable is disconnected.
Green	All links in the port are connected and functional.
Amber	One or more links in the port is not connected. This is only applicable in a wide port configuration.

Physical Disk Cache Policy

The default cache policy on a physical disk is **Enabled** in SATA drives and **Disabled** on SAS drives. When physical disk caching is **Enabled**, disk I/O performance is improved, but a power outage or equipment failure might result in data loss or corruption.



NOTE: It is recommended that you use a backup power source for all Dell production systems.

On a PERC H200 card, caching is forced to be disabled for all physical disks configured into a virtual disk, regardless of the drive type and default drive settings.

Unsupported Drives

Drives that are not certified by Dell are reported in the **BIOS Configuration Utility**, also known as <Ctrl><C>.

To view unsupported drives:

- 1 In the **BIOS Configuration Utility**, navigate to the **SAS Topology** screen.
- 2 Select the unsupported drive and press <Alt><D> to view the **Device Properties** screen.

The drive is marked as **Uncertified** in the **Device Properties** screen.

Drives that are not certified by Dell are not blocked and you can use them at your own risk.

Hardware Installation

This chapter describes how to install the Dell™ PowerEdge™ RAID Controller (PERC) H200 and 6Gbps SAS HBA cards.

Installing the PERC H200 and 6Gbps SAS HBA Cards

 **CAUTION:** Many repairs may only be done by a certified service technician. You should only perform troubleshooting and simple repairs as authorized in your product documentation, or as directed by the online or telephone service and support team. Damage due to servicing that is not authorized by Dell is not covered by your warranty. Read and follow the safety instructions that came with the product.

- 1 Unpack the PERC H200 card or 6Gbps SAS HBA and check for damage.

 **NOTE:** Contact Dell if the controller is damaged.

- 2 Turn off the system and attached peripherals, and disconnect the system from the electrical outlet. See your system's *Hardware Owner's Manual* or the *User's Guide* for more information on power supplies.
- 3 Disconnect the system from the network and remove the cover of the system. See your system's *Hardware Owner's Manual* or the *User's Guide* for more information on opening the system.
- 4 Select an appropriate PCI-E slot. If replacing a PERC H200 Adapter or 6Gbps SAS HBA, remove the blank filler bracket on the back of the system aligned with the PCI-E slot you have selected.

 **NOTE:** For more information about your system's PCI-E slots, see your system's *Hardware Owner's Manual*.

- 5 Align the controller to the PCI-E slot you have selected.

6 Insert the controller gently, but firmly, until the controller is firmly seated in the PCI-E slot. See Figure 4-1.

 **NOTE:** Figure 4-1 displays the 6Gbps SAS HBA, but the installation instructions in this section are common for the H200 Integrated, H200 Adapter and 6Gbps SAS HBA.

 **NOTE:** The H200 Integrated card may have a dedicated PCI slot. For additional details, see the system's *Hardware Owner's Manual* on the Dell Support website at support.dell.com.

Figure 4-1. Installing a 6Gbps SAS HBA



1 bracket screw

2 6Gbps SAS HBA

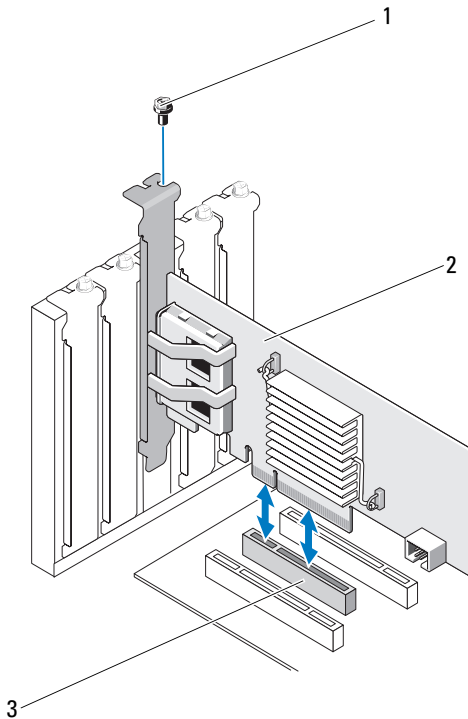
3 PCI-E slot

- 7 Tighten the bracket screw, if any, or use the system's retention clips to secure the controller to the system's chassis.
- 8 For a PERC H200 card, connect the cables from the end devices or the backplane of the system to the controller. See Figure 4-2.

Figure 4-2. Connecting the Cable for PERC H200

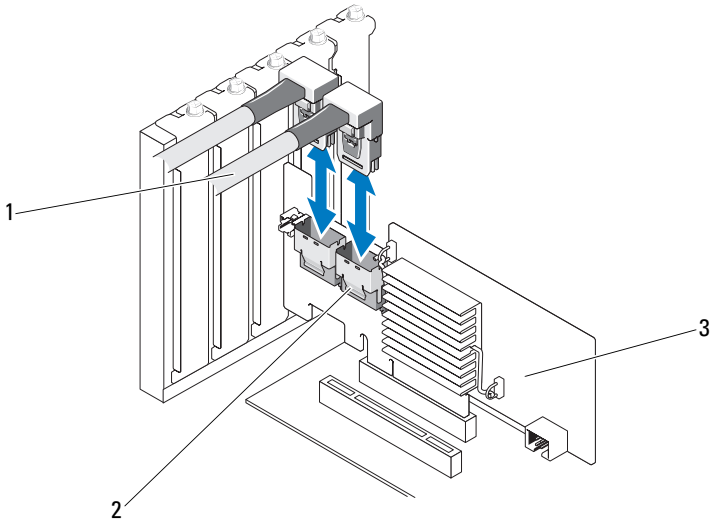

- | | | | |
|---|---------------------------|---|-------|
| 1 | SAS x4 internal connector | 2 | cable |
| 3 | PERC H200 Card | | |

- 9 For the 6Gbps SAS HBA controller, connect the cable from the external enclosure to the adapter. See Figure 4-3.





 **NOTE:** The external cable can be connected to either of the two external connectors.

Figure 4-3. Connecting the Cable for 6Gbps SAS HBA

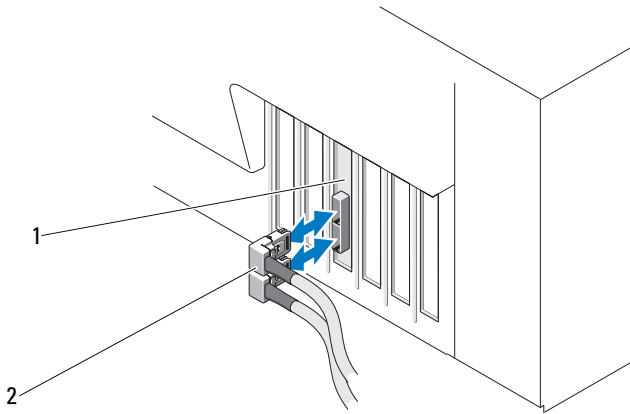

- 1 6Gbps SAS HBA 2 Cable from the external enclosure

- 10 Replace the cover of the system. See your system's *Hardware Owner's Manual* or the *User's Guide* for more information on closing the system.
- 11 Reconnect the power cable(s) and network cables, and then turn on the system.

-  **NOTE:** Ensure that you do not connect a hard disk and tape drive to the same PERC H200 card.
-  **NOTE:** For information on connecting your PERC H200 card to a tape drive, see your system's *Hardware Owner's Manual* on the Dell Support website at support.dell.com/manuals.
-  **NOTE:** Installing an operating system on a disk attached to the 6Gbps SAS HBA or a tape drive is not supported.

Installing the PERC H200 Modular Card

 **NOTE:** For more information on removing and installing blade system parts, see your system's *Hardware Owner's Manual* or the *User's Guide* from the Dell Support website at support.dell.com.

The storage controller card is located below the hard drive bays of the Dell Blade system.

To remove the storage controller card:

- 1 Remove the Dell Blade system from the Blade system chassis.
- 2 Remove the system cover of the Blade system.
- 3 Remove the system board and place it on a stable and flat surface.
- 4 Open the release lever to disconnect the storage controller card edge connector from the system board connector as illustrated in Figure 4-4.
- 5 Lift the storage controller card straight up from the system board as illustrated in Figure 4-4.

Figure 4-4. Removing and Installing the Storage Controller Card

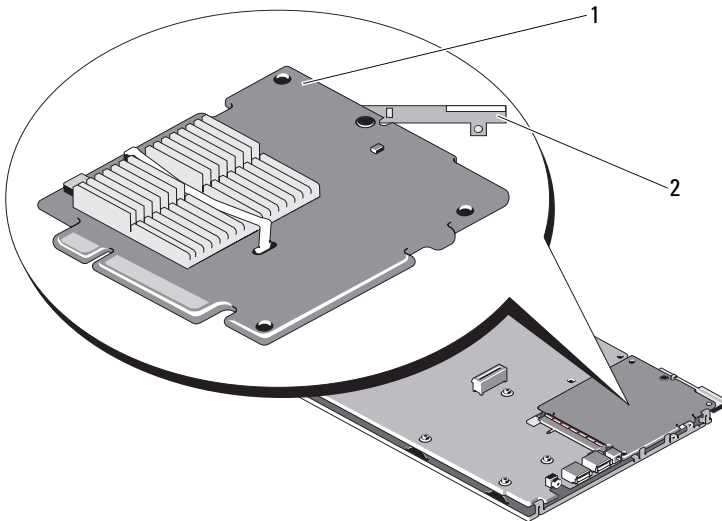

1 storage controller card

2 release lever

To install your new storage controller card:

- 1 Unpack the new storage controller card and check for damage.



NOTE: If the card is damaged, contact Dell technical support.

- 2 Place the storage controller card onto the system board. Align the storage controller card such that the tabs on the system board tray fit through the notches on the edges of the storage controller card.
- 3 Slide the storage controller card towards the connector on the system board until the storage controller clicks in place.
- 4 Reinstall the system board. For more information on reinstalling the system board, see your system's *Hardware Owner's Manual* or the *User's Guide*.
- 5 Close the top cover of the Blade system. For more information on closing the top cover of the Modular Blade system, see your system's *Hardware Owner's Manual* or the *User's Guide*.
- 6 Reinstall the Blade system in the Blade system chassis. For more information on reinstalling the Blade system in the Blade system chassis, see your system's *Hardware Owner's Manual* or the *User's Guide*.



NOTE: For the latest list of firmware and installation instructions, see the system documentation located at the Dell Support website at support.dell.com.

Driver Installation

The Dell™ PowerEdge™ RAID Controller (PERC) H200 and 6Gbps SAS HBA cards require software drivers to operate with Microsoft® Windows®, Red Hat® Enterprise Linux®, and SUSE® Linux operating systems.

This section contains the procedures for installing the drivers for the following operating systems:

- Microsoft Windows Server 2003 Server family
- Microsoft Windows Server 2008 Server family
- Windows Server 2008 R2
- Red Hat Linux version 4 Update 7 and later, and version 5 Update 3 and later
- SUSE Linux Enterprise Server version 10 Service Pack 2 and later (64-bit only), and version 11 Gold and later (64-bit only)

The three methods for installing a driver that are discussed in this chapter are:

- During operating system installation
- After adding a new PERC H200 or 6Gbps SAS HBA controller on an existing operating system
- Updating existing drivers



NOTE: The Windows Server 2008 R2 operating system includes native support for the PERC H200 card. The driver is automatically installed. For driver updates, see the Dell Support website at support.dell.com.



NOTE: Operating system installation on a RAID 1, RAID 0 or a RAID 10 virtual disk is supported only when the virtual disk is in an optimal state.



NOTE: To ensure you have the latest version of any driver mentioned in this section, check the Dell Support website at support.dell.com. If a newer version exists, you can download the driver to your system.

Installing the Windows Driver

This section documents the procedures used to install the Windows driver.

Creating the Driver Media

Perform the following steps to create the driver media:

- 1 From the Dell Support website at support.dell.com, browse to the download section for the system.
- 2 Locate and download the latest PERC H200 or 6Gbps SAS HBA card driver to the system.
- 3 Follow the instructions on the Dell Support website for extracting the driver to the media.

Pre-Installation Requirements

Before you install the operating system:

- Read the Microsoft *Getting Started* document that ships with your operating system.
- Ensure that your system has the latest BIOS and firmware. Ensure that the latest driver is available for the installation. If required, download the latest BIOS, firmware, and driver updates from the Dell Support website at support.dell.com.
- Create a device driver media (diskette, USB drive, CD, or DVD).

Creating the Device Driver Media

Use one of the methods described in the following sections to create the device driver media.

Downloading Drivers From the Dell Systems Service and Diagnostic Tools Media

- 1 Insert the *Dell Systems Service and Diagnostics Tools* media into a system. The **Welcome to Dell Service and Diagnostic Utilities** screen is displayed.
- 2 Select your system model and operating system.
- 3 Click **Continue**.

- 4 From the list of drivers displayed, select the driver that you require. Select the self-extracting zip file and click **Run**. Copy the driver to a diskette drive, CD, DVD, or USB drive. Repeat this step for all the drivers that you require.
- 5 During the operating system installation described in "Installing the Driver During a Windows Server 2003 Operating System Installation" on page 33 and "Installing the Driver During a Windows Server 2008 or Windows Server 2008 R2 Installation" on page 34, use the media that you created with the **Load Driver** option to load mass storage drivers.

Downloading Drivers From the Dell Support Website

- 1 Go to support.dell.com.
- 2 Click **Drivers and Downloads**.
- 3 Enter the service tag of your system in the **Choose by Service Tag** field or select your system's model.
- 4 Select the **System Type, Operating System, Driver Language, and Category** from the drop-down list.
- 5 The drivers that are applicable to your selection are displayed. From the available list, download the drivers that you require to a diskette drive, USB drive, CD, or DVD.
- 6 During the operating system installation described in "Installing the Driver During a Windows Server 2003 Operating System Installation" on page 33 and "Installing the Driver During a Windows Server 2003 Operating System Installation" on page 33, use the media that you created with the **Load Driver** option to load mass storage drivers.

Installing the Driver During a Windows Server 2003 Operating System Installation

Perform the following steps to install the driver during operating system installation.

- 1 Boot the system using the Windows Server 2003 media.
- 2 When the message **Press F6 if you need to install a third party SCSI or RAID driver** appears, press the <F6> key immediately.

Within a few minutes, a screen appears that asks for additional controllers in the system.

- 3 Press the <S> key.

The system prompts for the driver media to be inserted.



NOTE: The driver can be provided using a properly formatted USB key. Check the Dell Support website at support.dell.com for additional details.

- 4 Insert the driver media in the media drive and press <Enter>.

A list of SAS controllers appears.

- 5 Select the right driver for the installed controller and press <Enter> to load the driver.



NOTE: For Windows Server 2003, a message can appear that states that the driver that you provided is older or newer than the existing Windows driver. Press <S> to use the driver that is on the media.

- 6 Press <Enter> again to continue the installation process as usual.

Installing the Driver During a Windows Server 2008 or Windows Server 2008 R2 Installation

Perform the following steps to install the driver during operating system installation.

- 1 Boot the system using the Windows Server 2008 or the Windows Server 2008 R2 media.
- 2 Follow on-screen instructions until you reach the message **Where do you want to install 7/2008**; then select **Load driver...**
- 3 The system prompts for the media to be inserted. Insert the installation media and browse to the proper location when prompted.
- 4 Select the appropriate PERC H200 card from the list, click **Next** and continue installation as usual.



NOTE: The Windows Server 2008 R2 operating system includes native support for the PERC H200 card. The driver is automatically installed. For driver updates, see the Dell Support website at support.dell.com.

Installing a Windows Server 2003, Windows Server 2008 or Windows Server 2008 R2 Driver for a New RAID Controller

Perform the following steps to configure the driver for the RAID controller on a system that already has Windows installed:

- 1 Turn off the system.
- 2 Install the new RAID controller in the system.
- 3 Turn on the system.
The Windows operating system detects the new controller and displays a message to inform you.
- 4 The **Found New Hardware Wizard** screen displays the detected hardware device.
- 5 Click **Next**.
- 6 On the **Locate device driver** screen, select **Search for a suitable driver for my device** and click **Next**.
- 7 Make the **Driver Files** available and browse to the proper location from the **Locate Driver Files** screen.
- 8 Click **Next**.
- 9 The wizard detects and installs the appropriate device drivers for the new RAID controller.
- 10 Click **Finish** to complete the installation.
- 11 Reboot the system if Windows request to do so.





NOTE: The Windows Server 2008 R2 operating system includes a device driver to support the SAS controllers. The system automatically detects the new controller and installs the driver. Check the version of the driver installed by Windows and update if necessary.

Updating the Windows Driver

Perform the following steps to update the Windows driver for the PERC H200 card that is already installed on your system:



NOTE: It is important that you close all applications on your system before you update the driver.

- 1 Follow the step below according to your operating system.
 - For Windows Server 2003:
Click Start→Settings→Control Panel→System.
 - For Windows Server 2008:
Click Start→Settings→Control Panel→System.
 - For Windows Server 2008 R2:
Click Start →Control Panel→System and Security→System
 - The System Properties screen is displayed.
- 2 For Windows Server 2003,click on the **Hardware** tab. For Windows Server 2008 and Windows Server 2008 R2, go to step 3.
- 3 Click **Device Manager**.
The Device Manager screen is displayed.
 -  **NOTE:** An alternative method is to open **Device Manager**. In **Windows Explorer**, right-click on **My Computer** and select **Manage**. The **Computer Management** screen is displayed. Select **Device Manager** in the left panel.
- 4 Double-click on **SCSI and RAID Controllers**.
 -  **NOTE:** In Windows 2008, SAS is listed under **Storage Controllers**.
- 5 Double-click the RAID controller for which you want to update the driver.
- 6 Click the **Driver** tab and click **Update Driver**.
The **Upgrade Device Driver Wizard** screen is displayed.
- 7 Make the driver files available with the USB key, or other media.
- 8 Select **Install from a list or specific location**.
- 9 Click **Next**.

- 10 Follow the steps in the wizard and browse to the location of the driver files.
- 11 Select the `.inf` file from the USB key or other media.
- 12 Click **Next** and continue the installation steps in the Wizard.
- 13 Click **Finish** to exit the wizard and reboot the system for the changes to take place.

Installing Linux Driver

Use the procedures in this section to install the driver for Linux. The driver is updated frequently. To ensure that you have the current version of the driver, download the updated Linux driver from the Dell Support website at support.dell.com.



NOTE: The driver update disk (DUD) images are created only for those operating system releases in which the native (in-box) driver is insufficient for installation. In the event that an operating system is being installed with a corresponding DUD image, follow the instructions below. If not, proceed with using the native device driver and then skip to "Installing the RPM Package With DKMS Support" on page 41.



NOTE: Red Hat Enterprise Linux 5, SUSE Linux Enterprise Server 10 and SUSE Linux Enterprise Server 11 use the `mpt2sas` driver, whereas Red Hat Enterprise Linux 4 uses the `mpt2sasbtm` driver. Examples in this section refer to the `mpt2sas` driver only. For Red Hat Enterprise Linux 4, replace `mpt2sas` with `mpt2sasbtm`.

Creating a DUD

Before beginning the installation, copy the drivers from the *Service and Diagnostic Utilities* media or download the appropriate driver for Linux from the Dell Support website at support.dell.com. This file includes Red Hat Package Managers (RPMs) and driver update disk files. The package also contains the Dynamic Kernel Module Support (DKMS) Red Hat Package Manager (RPM) file, source code, and release notes.

For more information on DKMS, see the Dell Support website at support.dell.com.

The package is a gzipped tar file. After downloading the package to a Linux system, perform the following steps:

- 1 Unzip the package using `gunzip`.
- 2 Untar the file using `tar -xvf`.

The DUD image can be transferred to a USB flash key, system floppy disk slot, or USB floppy device depending upon the availability of the media type and the operating system.

- **USB key method:** Transfer the appropriate `.img` file to a USB key
- **System floppy Fisk slot method:** Use the `dd` command to create a DUD. Use the appropriate image for the purpose.
 - a Insert a floppy disk into the system floppy disk slot.
 - b At a terminal prompt, type the following:

```
# dd if=<image_file_name> of=/dev/fd0
```
- **USB floppy device method:** Use the `dd` command to create a driver update disk. Use the appropriate image for the purpose.
 - a Put a floppy disk into a USB floppy device and plug the device into a USB slot of the system under test. Use `dmesg` to find out to which device this USB floppy is enumerated (for example, `sdb`, `sdc`, etc).
 - b Transfer the driver image to the floppy:

```
# dd if=<image_file_name> of=/dev/sdx
```



NOTE: You can create a driver update disk on a Windows system using the program `dcopynt`.

- 3 Use the diskette for operating system installation. For Red Hat Enterprise Linux, see "Installing Red Hat Enterprise Linux Operating System Using the DUD" on page 39. For SUSE Linux Enterprise Server, see "Installing SUSE Linux Enterprise Server Using the DUD" on page 40.

Creating a DUD Using DKMS

Perform the following steps to create the DUD using the DKMS tool.

 **NOTE:** The driver must be installed on the system where this procedure is performed.

- 1 Install the DKMS-enabled `mpt2sas` driver rpm package.
- 2 Type the following command in any directory: `dkms mkdriverdisk -m mpt2sas -v <driverversion> -k <kernel version> -d <distro>`

 **NOTE:** The values for the `-d` option are `suse` for Suse Linux Enterprise Server diskettes and `redhat` for RHEL diskettes.

 **NOTE:** For more information on usage of DKMS, see the DKMS man page.

This starts the process to create the `mpt2sas` DUD image. After the DUD image has been built, you can find it in the DKMS tree for the `mpt2sas` driver. See the output of the `dkms mkdriverdisk` command for the exact path.

Installing Red Hat Enterprise Linux Operating System Using the DUD

Perform the following steps to install Red Hat Enterprise Linux (versions 4 and 5) and the appropriate driver.

- 1 Boot normally from the Red Hat Enterprise Linux installation media.
- 2 At the command prompt, type: `linux expert dd`
- 3 When the install prompts for additional drivers, insert the diskette or USB key and press `<Enter>`.
- 4 For information about creating a driver diskette, see "Creating a DUD" on page 37.
- 5 Complete the installation as directed by the installation program.

Installing SUSE Linux Enterprise Server Using the DUD



NOTE: For information about creating a driver diskette, see "Creating a DUD" on page 37.

To install SUSE Linux Enterprise Server using the DUD:

1 Insert the appropriate SUSE Linux Enterprise Server Service Pack media in the system.

2 For SLES 10, select <F5> for the DUD. For SLES 11, select <F6>.

The system displays three options: **Yes**, **No**, and **File**.

Choose **Yes** to install the driver.

3 Select **Installation** from the menu.

4 Press <Enter> to load the Linux kernel.

5 At the prompt **Please insert the driver update floppy**, click **OK**.

The system selects the driver from the diskette and installs it.

The system displays the message **DRIVER UPDATE ADDED** with the description of the driver module.

6 Click **OK**.

If you want to install from another driver update medium, continue with the following steps.

7 The system displays the message **PLEASE CHOOSE DRIVER UPDATE MEDIUM**.

8 Select the appropriate driver update medium.

The system selects the driver from the disk and installs it.

Installing the RPM Package With DKMS Support

Perform the following steps to install the RPM package with DKMS support:

- 1 Uncompress the gzipped tarball driver release package.
- 2 Install the DKMS package using the command: `rpm -ihv dkms-
<version>.noarch.rpm`
- 3 Install the driver package using the command: `rpm -ihv mpt2sas-
<version>.noarch.rpm`



NOTE: Use `rpm -Uvh <package name>` when updating an existing package.

- 4 If the previous device driver is in use, you must reboot the system for the updated driver to take effect.
- 5 Verify that the driver has been loaded with these system commands:
`modinfo mpt2sas` and `dkms status`.

Upgrading the Kernel

When upgrading to a new kernel, you must reinstall the DKMS-enabled driver packages. Perform the following steps to update or install the driver for the new kernel:

- 1 In a terminal window, type the following:

```
#dkms build -m <module_name> -v <module version> -  
k <kernel version>  
  
#dkms install -m <module_name> -v <module version>  
-k <kernel version>
```
- 2 To check whether the driver is successfully installed in the new kernel,
type: `dkms status`
You see a message similar to the following one: **<driver name>, <driver
version>, <new kernel version>: installed**
- 3 If the previous device driver is in use, you must reboot the system for the updated driver to take effect.

PERC H200 and 6Gbps SAS HBA BIOS

The BIOS of the Dell™ PowerEdge™ RAID Controller (PERC) H200 and 6Gbps SAS HBA cards have the following features:

- Support for multiple SAS controllers
- RAID configuration tool (applicable to the PERC H200 card only)
- Read-only memory (ROM) BIOS recovery image
- POST status error messaging
- POST accessible, text-based configuration utility (<Ctrl><C>)
- Boot Device Selection (applicable to the PERC H200 card only)

POST Messages

During POST, the BIOS displays messages that provide the status and identification information of the PERC H200 card, and also displays errors detected during the POST process.

- The BIOS POST identification banner prints the BIOS identification, copyright information, and the controller version.
- The BIOS displays the list of controllers and devices detected at initialization in a hierarchical order.
- The BIOS also prompts you to start the **Configuration Utility** during the POST process.

BIOS Fault Code Messages

If an error is encountered in the BIOS during POST, the **BIOS Configuration Utility** forces you to acknowledge BIOS errors by halting the POST process after the error display. You must press any key to continue. The **BIOS Configuration Utility** allows you to choose to continue booting or stop booting if errors are encountered.

Booting With Multiple Controllers

When booting a system with multiple PERC H200 and/or SAS 6 Gb HBA cards, ensure that the boot device is attached to the adapter at the lowest boot order number. Proper boot order must be specified in the controller BIOS to ensure the system boots correctly. If you add a PERC H200 or 6Gbps SAS HBA card or relocate existing controllers in the system, enter the **BIOS Configuration Utility** <Ctrl><C> to update and verify the boot order selection. Failure to do so results in a warning message displayed at POST by the BIOS. The warning persists until the you verify the boot order in the BIOS Configuration Utility.

 **NOTE:** System boot is not supported from an external device attached to a 6Gbps SAS HBA card. See the Dell Support website at support.dell.com for the latest information on booting from external devices.

Configuration Utility

Starting the Configuration Utility

- 1 Boot the system.
- 2 Press <Ctrl><C> during POST when prompted.
If you wait too long and the operating system logo appears, continue to wait until the operating system completes bootup. Then restart your system and try again.

The Configuration Utility menu screen is displayed.

Functions Performed

 **NOTE:** The screens are organized in a hierarchical fashion and navigation hints are displayed at the bottom of each screen. For additional information about the utility, see the online help.

Table 6-1. Functions of the Configuration Utility

Function	Description
Adapter List	Lists all the PERC H200 and 6Gbps SAS HBA cards in the system.
Global Properties	Lists static and modifiable properties applicable to all PERC H200 and 6Gbps SAS HBA cards in the system.
Adapter Properties	Main screen for the selected controller. Lists the static and modifiable properties for the selected PERC H200 and 6Gbps SAS HBA cards. Provides a menu for additional screens.
Select New Volume Type	Provides the option to view existing arrays or create new volumes.
Create New Volume	Provides the ability to add devices to the specified new volume.
View Volume	Displays the properties for the existing volume and the option to enter the Manage Volume screen.
Manage Volume	Provides options for managing the current volume.
Manage Hot Spares	Provides the ability to add or remove global hot spares.
SAS Topology	Lists the physical topology for the selected controller.
Device Properties	Lists the properties of physical devices attached to the selected controller.
Advanced Adapter Properties	Lists the advanced properties for the selected controller.

Table 6-1. Functions of the Configuration Utility (continued)

Function	Description
Select/Deselect as Boot Device	Provides the ability to select or deselect a Boot Device.
Verify	Provides the ability to verify all sectors on the device and to reassign defective Logical Block addresses (LBAs).
Consistency Check	Provides the ability to run a consistency check on an optimal volume.
Delete	Provides the ability to delete the selected volume.
Activate Volume	Provides the ability to import a foreign volume.

 **NOTE:** The navigation hints for the **Configuration Utility** are displayed at the bottom of each screen. Online help is also available in the utility.

 **NOTE:** After you press <Ctrl><C>, press <Enter> on the adapter to manage it.

RAID Configuration and Management Screens

RAID configuration and management involves many GUIs. You can access the GUIs by selecting **RAID Properties** on the **Adapter Properties** screen.

The screens in the RAID configuration and management properties area are:

- "Select New Volume Type" on page 47
- "Create New Volume" on page 47
- "View Volume" on page 50
- "Manage Volume" on page 50

You are prompted to create a RAID volume, if no RAID volumes are currently configured.

Select **View Existing volume** to manage the volume (s), or select the appropriate option to configure a new volume, if at least one RAID volume is currently configured.

Select New Volume Type

The three options for creating a new volume are:

- Create RAID 1 Volume
- Create RAID 10 Volume
- Create RAID 0 Volume

Additional information about the disk type options is displayed on the screen.

Create New Volume

The **Create New Volume** screen allows you to select disks for a new volume.

- 1 Press <C> to create the volume once the volume is configured.
- 2 Save the changes when prompted to do so.

After the volume is created, the utility returns to the **Adapter Properties** screen. See the table below for the volume properties description.



NOTE: It is recommended that you back up your data prior to adding or updating configurations.

Table 6-2. Volume Field Descriptions

Field	Description
Volume Number	Number of current volume out of total arrays configured
Volume Identifier	Identifier text for the current volume
Volume Type	Type of volume (R0, R1 or R10)
Volume Size (GB)	Size of the volume NOTE: To facilitate coercion on new larger disk drives, the disk size must be coerced down with a factor of 128 MB. Additionally, to comply with the latest Disk Data Format standard, 512 MB of space must be reserved for RAID metadata on the drive. This results in several hundred MB of space being removed from the usable size of an volume when it is created.

Table 6-2. Volume Field Descriptions (continued)

Field	Description
Volume Status	Status of the current volume The status definitions are given as: Optimal —All members of the volume are online and ready. Degraded —One or more members of a RAID 1 or RAID 10 volume have failed or are offline. The volume can be returned to the Optimal state by replacing the failed or offline member. Disabled —The volume is disabled Quiesced —The volume is quiesced Resync —The volume is resynchronizing Failed —The volume has failed PermDegraded —The volume is permanently degraded. This state indicates that the failure threshold on the primary member was reached while no secondary was available for correction. The data on the volume may be accessible, but the volume cannot be returned to the optimal state. Inactive —The imported volume is inactive. The volume must be activated before it can be accessed. Initializing —The array is undergoing Background Initialization BGI Pending —The array is queued up for a Background Initialization Checking —The array is queued up for a Consistency Check
Slot Number	Slot number in which the specified device sits
Device Identifier	Identifier text for the specified device
RAID Disk	Specifies whether or not the disk is part of a RAID volume (Yes or No). This field is inactive out under the following conditions: <ul style="list-style-type: none">• The disk does not meet the minimum requirements for use in a RAID volume.• The disk is not large enough to mirror existing data on the primary physical disk.• The disk is a part of another volume.

Table 6-2. Volume Field Descriptions (continued)

Field	Description
Hot Spare	Specifies whether or not the disk is a hotspare
Drive Status	<p>Ok - Disk is online and fully functional.</p> <p>Missing - Disk is not detected.</p> <p>Failed - Disk is not accessible or has reported a failure.</p> <p>Initing - Disk is initializing.</p> <p>CfgOffln - Disk is offline at host's request.</p> <p>UserFail - Disk is marked failed at host's request.</p> <p>Offline - Disk is offline for some other reason.</p> <p>Inactive - Disk has been set to inactive.</p> <p>Not Syncd - Data on disk is not synchronized with the rest of the volume.</p> <p>Primary - Disk is the primary disk for a 2 disk mirror and is OK.</p> <p>Secondary - Disk is the secondary disk for a 2 disk mirror and is OK.</p> <p>Wrg Type - Device is not compatible for use as part of a RAID volume.</p> <p>Too Small - Disk is too small to mirror existing data.</p> <p>Max Dsk - Maximum # of disks allowed for this type of volume reached Maximum # of total IR disks on a controller reached.</p> <p>No SMART - Disk doesn't support SMART and can't be used in a RAID volume.</p> <p>Wrg Intfc - Device interface (SAS/SATA) differs from existing IR disks.</p>
Predicted Failure	Indicates whether device SMART is predicting device failure.
Size (GB)	Actual physical size of the selected disk in the volume.

NOTE: The PERC H200 cards do support Drive Status LED operation on PowerEdge systems which include drive status LEDs. Status LED support is only supported for drives which are configured as members of a Virtual Disk or Hot Spare. PERC H200 supported Drive Status LED states may vary from those supported by other hardware based RAID solutions such as the PERC H700 and H800 controllers.

NOTE: Replacing a member of a volume in the **Permanently Degraded** state will result in the new physical disk being displayed as failed since resynchronization is not possible. This does not indicate an actual failure on the new physical disk.

View Volume

The **View Volume** screen allows you to view the current volume configuration.

Press <Alt><N> to view the next volume. See Table 6-2 to view descriptions of each virtual disk property.

Manage Volume

The **Manage Volume** screen is used to manage the current volume. The options are **Manage Hotspares**, **Consistency Check**, **Activate Volume**, and **Delete Volume**.

Table 6-3. Manage Volume Field Descriptions

Field	Description
Identifier	The identifier of the volume
Type	The RAID type of the volume
Size (GB)	The coerced size of the volume NOTE: To facilitate coercion on new larger disk drives, the disk size must be coerced down with a factor of 128 MB. Additionally, to comply with the latest Disk Data Format standard, 512 MB of space must be reserved for RAID metadata on the drive. This results in several hundred MB of space being removed from the usable size of an volume when it is created.
Status	The status of the volume
Manage Hotspares	This option is used to create or delete global hot spares. Using this option you can: <ul style="list-style-type: none">• Assign a hot spare, (RAID 1 and RAID 10 configurations only).• Display each drive's type, size and hot spare status.

Table 6-3. Manage Volume Field Descriptions (continued)

Field	Description
Consistency Check	This option is used to run a consistency check on a redundant RAID volume. This option is grayed out under the following conditions: <ul style="list-style-type: none">• The volume is RAID 0• The volume is not optimal• The volume has a consistency check pending• The volume is already running a consistency check
Activate Volume	This option is used to activate an inactive (foreign) volume. The option is grayed out if there are no inactive arrays.
Delete Volume	This option is used to delete the currently displayed volume.

Exit Screen

It is important to exit the **SAS BIOS Configuration Utility** properly, because some changes take effect only when you exit. From the **Adapter List**, press <Esc> to exit. In addition, a similar exit screen appears when you exit most other screens, and it can be used to save settings.

Performing Configuration Tasks

The following configuration tasks can be performed using a PERC H200 card:

- Creating a RAID 0, RAID 1, or RAID 10 virtual disk
- Viewing virtual disk properties
- Activating a virtual disk
- Migrating and Activating a virtual disk
- Hot Spare failover
- Replacing and Rebuilding a degraded virtual disk
- Assigning a Preferred Boot Device

The PERC H200 card supports a minimum of two drives and maximum of 10 drives for a RAID 0 volume. Two drives are required to configure a RAID 1 volume, and a minimum of four drives and a maximum of 10 drives for a RAID 10 volume. There can be no more than 14 configured drives in any system, including a maximum of two global hot spares. A configured drive is a drive that is part a RAID volume or is a hot spare.

Creating a RAID 0 Virtual Disk

A RAID 0 virtual disk offers the ability to stripe data across multiple physical disks. RAID 0 volumes offer increased capacity by combining multiple physical disks into a single virtual disk. RAID 0 volumes also offer increased performance by striping disk access across multiple physical disks.

Follow these steps to create a RAID 0 virtual disk on a PERC H200 card.

- 1 Select a controller from the **Adapter List** in the Configuration Utility.
- 2 Select the **RAID Properties** option.
- 3 Select **Create RAID 0 Volume** when you are prompted to create either a RAID 0 virtual disk, a RAID 1 virtual disk or a RAID 10 virtual disk.

The next screen shows a list of disks that can be added to a virtual disk.

- 4 Move the cursor to the **RAID Disk** column. To add a disk to the virtual disk, change **No** to **Yes** by pressing the <+>, <->, or space bar. As disks are added, the **Virtual Disk Size** field changes to reflect the size of the new virtual disk.

CAUTION: All data will be lost upon creation of the virtual disk.

There are several limitations when creating a RAID 0 virtual disk:

- All disks must be either Dell-compliant SAS or SATA HDDs or SSDs.
- SAS and SATA physical disks cannot be used in the same virtual disk.
- HDDs or SSDs cannot be used in the same virtual disk.
- There must be at least 2 physical disks in a virtual disk.
- No more than 10 physical disks are allowed in a virtual disk.

- 5 Press <C> and then select **Save changes** when the virtual disk has been fully configured.

The Configuration Utility pauses while the virtual disk is being created.

 **CAUTION: RAID 0 does not provide any data protection in the event of disk failure. It is primarily used to increase performance.**



NOTE: Once the number of disks in a RAID virtual disk is set, it cannot be changed.



NOTE: The maximum size of the virtual disk that contains the bootable operating system is 2 Tb. This is due to operating system restrictions. The maximum volume size (non-bootable) is 16 Tb.

Creating a RAID 1 Virtual Disk

A RAID 1 virtual disk offers the ability to mirror data from one physical disk onto another one. RAID 1 volumes offer increased reliability by combining two physical disks into a single virtual disk such that each disk contains a mirrored copy of the other's data. Follow these steps to create a RAID 1 virtual disk on a PERC H200 card that does not currently have a virtual disk configured.

- 1 Select a controller from the **Adapter List** in the Configuration Utility.
- 2 Select the **RAID Properties** option.
- 3 Select **Create RAID 1 Volume** when you are prompted to create either a RAID 0 virtual disk, a RAID 1 virtual disk or a RAID 10 virtual disk. The next screen shows a list of disks that can be added to a virtual disk.
- 4 Move the cursor to the **RAID Disk** column. To add a disk to the virtual disk, change **No** to **Yes** by pressing the <+>, <->, or space bar.



CAUTION: Data on both disks will be lost. It is recommended that you back up all data before performing these steps.

There are several limitations when creating a RAID 1 virtual disk:

- All disks must be either Dell-compliant SAS, SATA or SSD physical disks.
- SAS, SATA or SSD physical disks cannot be used in the same virtual disk.
- There must be 2 physical disks in a RAID 1 virtual disk.

- 5 Press <C> and then select **Save changes** when the virtual disk has been fully configured.



NOTE: There is an option to create a hot spare for a RAID 1 virtual disk. After the virtual disk is created, entering the Manage Hot Spares screen allows the option to assign a hot spare. Only drives that are compatible with the new virtual disk configuration can be selected. The maximum number of hot spares allowed is two.



NOTE: RAID 1 provides protection against the failure of a single physical disk. When a disk fails, the physical disk can be replaced and the data re-mirrored to the physical disk, maintaining data integrity.

- 6 Once the virtual disk has been created, a Background Initialization will automatically be scheduled on the virtual disk.



NOTE: Only one background task can be performed on the PERC H200 card at any time. If there is already a resynchronization or Background Initialization in progress on another virtual disk when a new virtual disk is created, the Background Initialization for the new virtual disk will be scheduled and given a status of BGI Pending. The pending Background Initialization will automatically start when the existing background process completes.



NOTE: A background initialization automatically starts after you configure a RAID 10 virtual disk. Once started, the background initialization process cannot be stopped.

Creating a RAID 10 Virtual Disk

A RAID 10 virtual disk offers the ability to stripe data across mirrored disks. RAID 10 volumes offer high data throughput and complete data redundancy. Follow these steps to create a RAID 10 virtual disk on a PERC H200 card that does not currently have a virtual disk configured.

- 1 Select a controller from the Adapter List in the **Configuration Utility**.
- 2 Select the **RAID Properties** option.
- 3 Select **Create RAID 10 Volume** when you are prompted to create either a RAID 0 virtual disk, a RAID 1 virtual disk or a RAID 10 virtual disk. The next screen shows a list of disks that can be added to a virtual disk.
- 4 Move the cursor to the **RAID Disk** column. To add a disk to the virtual disk, change **No** to **Yes** by pressing the <+>, <->, or the space bar. As disks are added, the **Virtual Disk Size** field changes to reflect the size of the new virtual disk.

 **CAUTION: Data on all disks will be lost. It is recommended that you back up all data before performing these steps.**

There are several limitations when creating a RAID 10 virtual disk:

- All disks must be either Dell-compliant SAS or SATA HDDs or SSDs.
 - SAS and SATA physical disks cannot be used in the same virtual disk.
 - HDDs and SSDs cannot be used in the same virtual disk.
 - There must be a minimum of 4 physical disks and a maximum of 10 physical disks in a RAID 10 virtual disk. An even number of physical disks need to be selected for a RAID 10 volume.
- 5** Press <C> and then select **Save changes** when the virtual disk has been fully configured.

 **NOTE:** There is an option to create a hot spare for a RAID 10 virtual disk. After the virtual disk is created, entering the **Manage Hot Spares** screen allows the option to assign a hot spare. Only drives that are compatible with the new virtual disk configuration can be selected. There is a maximum of 2 hot spares supported globally. Hot spares only apply to a redundant volume if it is of the same type and at least the same capacity of the volume.

- 6** Once the virtual disk has been created, a Background Initialization is automatically scheduled on the virtual disk.

 **NOTE:** RAID 10 provides protection against the failure of multiple physical disks, as long as both drives within a mirrored pair do not fail. When a disk fails, the physical disk can be replaced and the data re-mirrored to the physical disk, maintaining data integrity.

 **NOTE:** Only one background task can be performed on the PERC H200 card at any time. If there is already a resynchronization or Background Initialization in progress on another virtual disk when a new virtual disk is created, the Background Initialization for the new virtual disk will be scheduled and given a status of BGI Pending. The pending Background Initialization will automatically start when the existing background process completes.

 **NOTE:** A background initialization automatically starts after you configure a RAID 1 virtual disk. Once started, the background initialization process cannot be stopped.

Viewing Virtual Disk Properties

Follow these steps to view the properties of RAID 0, RAID 1 or RAID 10 virtual disks:

- 1 Select a controller from the **Adapter List** in the Configuration Utility.
- 2 Select the **RAID Properties** option.
 - If there are no existing virtual disks, you will be prompted to create a RAID 0, RAID 1 or RAID 10 virtual disk.
 - If there is one existing virtual disk, select **View Existing volume**.
 - If there are two existing virtual disks, press <Alt><N> to view the next virtual disk.
 - If a compatible global hot spare exists it displays with the members of the virtual disk.
- 3 Press <Enter> when the **Manage volume** item is selected to manage the current virtual disk.

Activating a Virtual Disk

A virtual disk can become inactive if, for example, it is removed from one PERC H200 card and moved to another one. The **Activate** option allows you to reactivate an inactive virtual disk that has been added to a system. This option is only available when the selected virtual disk is currently inactive.



NOTE: Do not migrate a volume or hotspares to a different system unless that system does not currently have the maximum number of virtual disks and hotspares. There is a maximum of 2 hot spares and 2 virtual disks supported globally. Hot spares only apply to a redundant volume if it is of the same type and at least the same capacity of the volume. Exceeding this number may result in undesirable behavior.

- 1 Select **Activate Volume**.
- 2 Press **Y** to proceed with the activation or press **N** to abandon it.

After a pause, the virtual disk will become active.



NOTE: Activation of migrated virtual disks is only supported when the migrated virtual disk(s) is in an optimal state and contains all the physical disks.



NOTE: If a virtual disk with defined hot spare drives is migrated to a PERC H200 card that has a native virtual disk with defined hot spares already configured, and the total number of hot spares is greater than the maximum supported number of hot spares (2) then the migrated hot spare drive(s) will be deleted. After a reboot, those drives are displayed as basic drives on the system. You can then create the desired virtual disk and hot spare drive configuration using <Ctrl><C> or the RAID management application.

Migrating and Activating a Virtual Disk

Virtual disks and hot spares can be migrated from other PERC H200 and SAS 6 series of controllers. Virtual disks cannot be migrated from any other controllers, including the SAS 5 series of controllers or PERC 5, PERC 6, PERC H700 and PERC H800 cards. Migration is only supported for virtual disks that are in the Optimal state. During the migration process, all systems must be powered down prior to removing and replacing drives. Volumes that are migrated to another controller will be inactive and must therefore be activated. To activate a virtual disk see "Activating a Virtual Disk" on page 56.

Deleting a Virtual Disk



CAUTION: Before deleting a virtual disk, be sure to back up all data on the virtual disk that you want to keep.

Follow these steps to delete a selected virtual disk:

- 1 Select **Delete Virtual Disk**.
- 2 Press **Y** to delete the virtual disk or press **N** to abandon the deletion.



CAUTION: If the physical disks of a virtual disk are removed and the virtual disk's configuration is subsequently deleted from the PERC H200 card, the physical disks show up only as simple disks with no RAID association if they are placed back onto the same PERC H200 card. Once the virtual disk is removed from a PERC H200 card using the **BIOS Configuration Utility** (regardless whether the physical disks members are present), the virtual disk cannot be restored.

Hot Spare Failover

If a RAID 1 or RAID 10 virtual disk enters a degraded state, a compatible hot spare automatically begins rebuilding the degraded virtual disk. The "missing" or "failed" member of the degraded virtual disk is displayed as a 'missing' global hot spare. The "missing" or "failed" drive must be replaced with a drive compatible with an existing virtual disk(s).

 **NOTE:** A compatible drive is one that is of the same drive type (SAS, SATA, or SSD) and of equal or greater size of the disk being replaced.

Replacing and Rebuilding a Degraded Virtual Disk

In the event of a physical disk failure in a RAID 1 or RAID 10 virtual disk, you will need to replace the disk and resynchronize the virtual disk. Synchronization occurs automatically on replacing the physical disk using the following steps.

- 1 Replace the failed physical disk with a blank disk of the same type and of equal or greater capacity.
- 2 Check your management application or the **BIOS Configuration Utility** (<Ctrl><C>) to ensure synchronization started automatically.

 **NOTE:** During the rebuilding of a volume the synchronization will be restarted from the beginning if a hard drive is added or removed from the system. Wait until any synchronization processes have been completed before adding or removing hard drives.

 **NOTE:** Always remove any configuration information from hard drives if they are to be permanently removed from a system. This can be completed by deleting the RAID configuration through the **BIOS Configuration Utility** or an operating system unless you are migrating these hard drives to a different system level application. PERC H200 hotspare functionality requires that the slots in which hard drives are inserted be associated with the virtual disks they are a part of. Do not insert hard drives with foreign or old (out of date) configuration information stored on those hard drives into slots that are associated with existing virtual disks.

 **NOTE:** If the system is rebooted while the rebuild is in progress, the rebuild continues from where it left off as a result of rebuild checkpointing. The rebuild time for a volume varies depending on the size of the member disks and any additional system activity.

Assigning a Preferred Boot Device

When installing an operating system on the PERC H200 card, it is strongly recommended that the desired Preferred Boot Device is selected in the <Ctrl><C> configuration utility. In the SAS topology screen in <Ctrl><C>, you can scroll down to either select the desired unconfigured physical disk or virtual disk and assign that device as the **Preferred Boot Device** by pressing <Alt>. The **Preferred Boot Device** is then be marked as **Boot under Device Information**. <Alt> can be used to deselect a previously selected **Preferred Boot Device** as well.

 **NOTE:** When an unconfigured physical disk is selected as the **Preferred Boot Device**, the selection is associated with the slot that the drive resides in. If the drive is then moved to a different slot, the system is not able to boot to the device anymore and an error message is seen during boot.

 **NOTE:** When a virtual disk is selected as the **Preferred Boot Device**, the selection is associated with the virtual disk itself. If the volume is then moved to a different location in the system, the system will still identify the virtual disk as the **Preferred Boot Device** and be able to boot without any errors.

When a **Preferred Boot Device** goes missing, an error message is seen on POST, requiring user action to continue. The error message is as follows:

```
ERROR: Preferred boot device is missing,  
reconfiguration is suggested!
```

You need to enter <Ctrl><C> to investigate the problem and select another **Preferred Boot Device** if needed.

In the scenario where you do not select a **Preferred Boot Device**, the boot device is chosen based on slot number, with the lowest number being given the highest priority. A message is displayed upon the first boot at POST stating which device has been assigned as the Boot Device.

The message looks something like the following for a virtual disk assignment:
Current Boot Device set to volume at handle 79



NOTE: Since this is not a user-selected **Preferred Boot Device**, it is not marked as **Boot** under Device Information in <Ctrl><C>.

If this device goes missing, the next device in the next available slot is selected as the Boot Device. Configured virtual disks are chosen as a boot device over unconfigured physical disks.

In summary, it is recommended to make a Preferred Boot Device selection in order to ensure that the desired boot device is always the device that the system boots to. All systems shipped from Dell have a Preferred Boot Device configured by default.

Troubleshooting

To get help with problems with your Dell™ PowerEdge™ RAID Controller H200 or 6Gbps SAS HBA cards, you can see "Getting Help" on page 73 or access the Dell Support website at support.dell.com.

BIOS Boot Order

If you intend to boot to the controller, ensure it is set appropriately in the system's BIOS boot order. See your system documentation for more information.

Background Activities

Disk I/O performance may be degraded while the following background activities are functioning:

- Background initialization
- Consistency check
- Disk rebuild

If disk I/O performance is lower than expected, check to see if any of these activities are running using a management application. If yes, wait until the background operation completes and recheck performance.

General Issues

 **NOTE:** For additional troubleshooting information, see the *SAS RAID Storage Manager User's Guide* and the *OpenManage Storage Services User's Guide* on the Dell Support website at support.dell.com.

Table 7-1. General Issues

Issue	Suggested Solution
No Physical Disks Found message appears during a CD installation of a Windows operating system.	<p>The message appears due to one of the following reasons:</p> <ul style="list-style-type: none">• The driver is not supported on the operating system. (applicable to Windows 2003 operating systems only)• The controller BIOS is disabled.• Physical disks are not connected or seated properly. <p>The corresponding solutions to the three causes of the message are:</p> <ul style="list-style-type: none">• Press <F6> to install the Device Driver during installation.• Enter the BIOS Configuration Utility to enable the BIOS. See "PERC H200 and 6Gbps SAS HBA BIOS" on page 43.• Verify if the physical disks are connected or seated properly.

Physical Disk Related Issues

Table 7-2. Physical Disk Issues

Issue	Suggested Solution
The system does not boot from the PERC H200 card.	Go to the Configuration Utility and verify the controller's boot order and also ensure that the desired Preferred Boot Device is set correctly. NOTE: See your system documentation for information about boot device selection. Also, see "Assigning a Preferred Boot Device" on page 59.
Physical disk is not enumerated during POST.	<ul style="list-style-type: none">• Go to the Configuration Utility and ensure that the physical disk is not enumerated in the SAS topology.• Verify the cable connection.• Reseat the physical disk.• Check and reseat the cable.
One of the physical disks in the volume shows the status as "Failed".	<ul style="list-style-type: none">• Check the SAS cables.• Reseat the physical disk.• Check the enclosure or the backplane for damage.• Contact Dell if the problem persists.
RAID 1 or RAID 10 virtual disk does not rebuild.	<ul style="list-style-type: none">• Enter the Configuration Utility and ensure the physical disk is enumerated in the SAS topology.• Ensure the new disk is of the same drive type as the other disk in the virtual disk.• Ensure the new disk is of equal or greater capacity as the other disk in the virtual disk.• Ensure the new disk is not detected as an inactive virtual disk under the RAID Properties menu. Delete the newly inserted inactive disk.• Ensure the new disk is a Dell supported SAS, SATA or SSD disk.

Configuration Utility Error Messages

 **NOTE:** These error messages are displayed inside the Configuration Utility. Restart your system and retry if you encounter any of these.

 **NOTE:** If the error message continues to be displayed even after following the steps mentioned in Table 7-3 for the resolution of the error, contact Dell Support for advanced troubleshooting. For information on how to contact Dell Technical Support, see "Getting Help" on page 73.

Table 7-3. Configuration Utility Error Messages

Message	Meaning	Suggested Solution
An error occurred while reading non-volatile settings.	An error occurred while reading any one of a number of settings from the firmware.	Reseat the controller and reboot.
An error occurred while reading current controller settings.	Controller setup and initialization has failed.	Reboot the system.
Advanced Device Properties settings not found.	Failed to read vital configuration page from firmware.	Reflash the firmware and reboot.
Error obtaining PHY properties configuration information.	Failed to read vital configuration page from firmware.	Reflash the firmware and reboot.
Configuration Utility Options Image checksum error.	Failed to properly read Configuration Utility options from flash.	Restart and retry. If the issue persists, reflash the firmware on the controller.
Can't load default Configuration Utility options.	Failed to allocate memory for Configuration Utility options structure.	
An error occurred while writing non-volatile settings.	An error occurred while writing one or more settings to the firmware.	

BIOS Error Messages

Table 7-4. BIOS Error Messages

Message	Meaning
Press <Ctrl+C> to Enable BIOS	When the BIOS is disabled, you are given the option to enable it by entering the Configuration Utility . You can change the setting to Enabled in the configuration utility.
Adapter configuration may have changed, reconfiguration is recommended! Press CTRL-C to run Dell PERC H200/6Gbps SAS HBA Configuration Utility...	Start the Configuration Utility and confirm the configuration of the PERC H200 or 6Gbps SAS HBA controller.
Initializing...	Displays while the BIOS is waiting to initialize.
SAS discovery error	Indicates that there was a discovery error reported by the firmware and may be accompanied by more such messages. Enter the Configuration Utility to investigate.
Integrated RAID exception detected:	The BIOS detected an exception with one or more RAID virtual disk. For additional troubleshooting information, see the error message "Volume (xx:yy:zzz) is currently in state "STATE".

Table 7-4. BIOS Error Messages (continued)

Message	Meaning
Volume (xx:yy:zzz) is currently in state "STATE"	<p>Lists the current state of the specified virtual disk when it is not optimal. The state may include:</p> <ul style="list-style-type: none">• INACTIVE: The virtual disk is inactive, possibly foreign, or could be in any one of the states mentioned below.• DEGRADED: The virtual disk is in a degraded state and has lost redundancy.• RESYNCING: The virtual disk is degraded and currently rebuilding.• FAILED: The virtual disk has an error and is in a failed state.• MISSING: The virtual disk is no longer present though a record of it remains.• UNKNOWN: The virtual disk has an error that is not defined by the previous errors.
Device not available at HBA n, HDL n, LUN	Device may not be ready at this time. The device will be retried. If the problem persists, restart your system.
ERROR! Device is not responding to Read Capacity	The device did not respond to a read capacity command. Contact Dell.
Please wait, spinning up the boot device!	The boot device was inactive, and is now spinning up.
Devices in the process of spinning up	One or more devices were inactive and are now spinning up.
nn drives are reported, BIOS memory allocation is full!	The reported drives consumed all of the available memory, no more memory can be allocated.
Failed to add device, too many devices!	Could not allocate resources for additional devices.

Table 7-4. BIOS Error Messages (continued)

Message	Meaning
ERROR! Adapter Malfunctioning!	The adapter did not initialize properly. There may be a problem with the adapter configuration. Reload the BIOS configuration. Invoke the configuration utility again and see if the issue persists.
MPT firmware fault	The LSI Logic MPT firmware faulted. Contact Dell.
Adapter removed from boot order!	An controller that was previously in the boot order was not found. It has either been removed from the system or moved to a different slot.
Updating Adapter List!	A new adapter was found for which there is no record. A record will be created for it.
Adapter(s) disabled by user	An adapter was found, but it has been disabled in the Configuration Utility and will not be used by the BIOS.
Adapter configuration may have changed, reconfiguration is suggested!	A controller has been moved or reinstalled in the system. Add it to the boot order using the available resources.
Memory allocation failed	The controller could not allocate enough memory to load the Configuration Utility , its strings file, or its options file. Reboot the system.
Invalid or corrupt image	One of the images for the Configuration Utility , its strings file, or its options file is corrupt. Reload the BIOS. Reflash the firmware.
Image upload failed	Could not upload the image for the Configuration Utility , its strings file, or its options file. Reload the BIOS. Reflash the firmware.
Unable to load the Dell PERC H200/HBA Configuration Utility	Could not load the Configuration Utility . This error usually follows one of the four previous messages.
Dell PERC H200/HBA configuration utility will load after initialization!	<Ctrl><C> is struck with the intention of starting the configuration utility but insufficient memory is available. The configuration utility therefore loads (boot) after POST initialization.

Table 7-4. BIOS Error Messages (continued)

Message	Meaning
MPT BIOS Fault xxh encountered at adapter PCI (xxh, xxh, xxh)	Fault 01: No I/O port assigned to the adapter. Fault 02: A MPT firmware fault occurred. Fault 03: No image for firmware download boot. Fault 04: Firmware download boot checksum error. Fault 05: IOC hardware error. Fault 06: MPT firmware communication error. Fault 07: PCI bus master error. Fault 08: String image (messages) not found. Fault 09: String memory allocation failed. Fault 0A: String upload failed. Fault 0B: String image was invalid. Fault 0C: Unsupported IOC configuration. Fault 0D: Timeout waiting for IOC to reply. Fault 0E: Transmit doorbell handshake error. Fault 0F: Receive doorbell handshake error. Fault 10: No memory mapped I/O address assigned. Fault 11: IOC facts failure. Fault 12: IOC initialization failure. Fault 13: Port enable failure.
MPT BIOS Fault xxh encountered at adapter PCI (xxh, xxh, xxh)	When xxh is 02 or 11, a 4-digit hexadecimal fault value may be displayed with this message. Ensure that you make a note of this value and contact technical support for assistance.

Table 7-4. BIOS Error Messages (continued)

Message	Meaning
ERROR: Preferred boot device is missing, reconfiguration is suggested!	The message indicates that the preferred boot device selected in the Configuration Utility is no longer available. You must enter the Configuration Utility and specify the physical or virtual disk to be the boot device. For details on assigning boot device preference, see "Assigning a Preferred Boot Device" on page 59.
One or more unsupported device detected!	There is a topology error during device scan.
SAS Address NOT programmed on controller in slot xx	The SAS address (World Wide ID) equals zero and is not programmed
WARNING! Foreign Metadata detected	Detected metadata is not supported by integrated RAID.
Device has an unsupported sector size, not 512	The sector size is not 512 bytes that is a requirement for boot support.
Bus master ERROR!	The bus master enable was not set for the chip.
Error: Preferred boot device is missing, reconfiguration is suggested!	The selected boot device is not found.

Updating the Firmware

Updating the Dell™ PowerEdge™ RAID Controller H200 or 6Gbps SAS HBA card firmware package is achieved by flashing the firmware package. The firmware package can be flashed while the controller is in use. The system must be restarted for all changes to take effect. If there is a failure while flashing the firmware package (such as a power outage) the controller reverts back to the earlier version of the firmware.



NOTE: If you flash the firmware while using the controller, you may notice temporary degradation in the controller's performance.

Firmware Package Update Utility

Firmware package update utility can be run from a variety of operating systems. This flash is automated and no user intervention is required. You can obtain the firmware package flash utility from the *PowerEdge Service and Diagnostic Utilities* media that shipped with your system.

You have to perform a manual update. In the event of new firmware package release, check the Dell Support website at support.dell.com for the latest firmware package updates and the firmware package update procedure.

Getting Help

 **CAUTION:** If you need to remove the computer cover, first disconnect the computer power and modem cables from all electrical outlets.

If you need assistance with a technical problem, perform the following steps:

- 1 Complete the procedures in the section "Troubleshooting Your System" of your system's *Hardware Owner's Manual*.
- 2 Run the system diagnostics and record any information provided.
- 3 Use Dell's extensive suite of online services available at Dell Support at support.dell.com for help with installation and troubleshooting procedures.

For more information, see "Online Services" on page 74.

- 4 If the preceding steps have not resolved the problem, call Dell for technical assistance.

 **NOTE:** Call the support service from a phone near or at the system so that the support staff can assist you with any necessary procedures.

When prompted by Dell's automated telephone system, enter your Express Service Code to route the call directly to the proper support personnel.

 **NOTE:** Dell's Express Service Code system may not be available in all countries.

If you do not have an Express Service Code, open the **Dell Accessories** folder, double-click the **Express Service Code** icon, and follow the directions.

For instructions on using the technical support service, see "Dell Enterprise Training" on page 75 and "Before You Call" on page 76.

 **NOTE:** Some of the following services are not always available in all locations outside the continental U.S. Call your local Dell representative for information on availability.

Technical Support and Customer Service

To contact Dell's support service, see "Before You Call" on page 76, and then see the contact information for your region or go to support.dell.com.

Online Services

You can access Dell Support at support.dell.com. Select your region on the **Welcome To Dell Support** page, and fill in the requested details to access help tools and information.

You can learn about Dell products and services on the following websites:

www.dell.com

www.dell.com/ap (Asian/Pacific countries only)

www.dell.com/jp (Japan only)

www.euro.dell.com (Europe only)

www.dell.com/la (Latin American and Caribbean countries)

www.dell.ca (Canada only)

You can access Dell Support by using the following websites and e-mail addresses:

- Dell Support websites
support.dell.com
support.jp.dell.com (Japan only)
support.euro.dell.com (Europe only)
- Dell Support e-mail addresses
mobile_support@us.dell.com
support@us.dell.com
la-techsupport@dell.com (Latin America and Caribbean countries only)
apsupport@dell.com (Asian/Pacific countries only)
- Dell Marketing and Sales e-mail addresses
apmarketing@dell.com (Asian/Pacific countries only)
sales_canada@dell.com (Canada only)
- Anonymous file transfer protocol (FTP)
[ftp.dell.com/](ftp://ftp.dell.com/)
Log in as user: `anonymous`, and use your e-mail address as your password.

Automated Order-Status Service

To check on the status of any Dell products that you have ordered, you can go to support.dell.com, or you can call the automated order-status service. A recording prompts you for the information needed to locate and report on your order. See the contact information for your region.

Dell Enterprise Training

Dell Enterprise training is available; see www.dell.com/training for more information. This service may not be offered in all locations.

Problems With Your Order

If you have a problem with your order, such as missing parts, wrong parts, or incorrect billing, contact Dell for customer assistance. Have your invoice or packing slip available when you call. See the contact information for your region.

Product Information

If you need information about additional products available from Dell, or if you would like to place an order, visit the Dell website at www.dell.com. For the telephone number to call to speak to a sales specialist, see the contact information for your region.

Returning Items for Warranty Repair or Credit



Prepare all items being returned, whether for repair or credit, as follows:

- 1 Call Dell to obtain a Return Material Authorization Number, and write it clearly and prominently on the outside of the box.
For the telephone number to call, see the contact information for your region.
- 2 Include a copy of the invoice and a letter describing the reason for the return.
- 3 Include a copy of any diagnostic information indicating the tests you have run and any error messages reported by the system diagnostics.
- 4 Include any accessories that belong with the item(s) being returned (such as power cables, media such as CDs and diskettes, and guides) if the return is for credit.
- 5 Pack the equipment to be returned in the original (or equivalent) packing materials.

You are responsible for paying shipping expenses. You are also responsible for insuring any product returned, and you assume the risk of loss during shipment to Dell. Collect-on-delivery (C.O.D.) packages are not accepted.

Returns that are missing any of the preceding requirements will be refused at our receiving dock and returned to you.

Before You Call

-  **NOTE:** Have your Express Service Code ready when you call. The code helps Dell's automated-support telephone system direct your call more efficiently.
-  **NOTE:** See your system's *Hardware Owner's Manual* for the telephone numbers and codes provided to contact Dell Support.

If possible, turn on your system before you call Dell for technical assistance and call from a telephone at or near the system. You may be asked to type some commands at the keyboard, relay detailed information during operations, or try other troubleshooting steps possible only at the system itself. Ensure that the system documentation is available.

-  **CAUTION:** Before servicing any components inside your system, see the product safety information for the system.

Regulatory Notices

For additional regulatory information, please go to the Regulatory Compliance Homepage on www.dell.com at the following location: www.dell.com/regulatory_compliance.

中国大陆 RoHS

根据中国大陆《电子信息产品污染控制管理办法》（也称为中国大陆 RoHS），以下部分列出了 Dell 产品中可能包含的有毒和/或有害物质的名称和含量。中国大陆 RoHS 指令包含在中国信息产业部 MCV 标准：“电子信息产品中有毒有害物质的限量要求”中。

Dell 企业产品（服务器、存储设备及网络设备）

部件名称	有毒或有害物质及元素					
	铅 (Pb)	汞 (Hg)	镉 (Cd)	六价铬 (Cr VI)	多溴联苯 (PBB)	多溴联苯醚 (PBDE)
机箱 / 挡板	X	O	X	O	O	O
印刷电路部件 - PCA*	X	O	X	O	O	O
电缆 / 连接器	X	O	X	O	O	O
硬盘驱动器	X	O	X	O	O	O
光盘驱动器 (CD、DVD 等)	X	O	O	O	O	O
磁带 / 介质	X	O	O	O	O	O
软磁盘驱动器	X	O	O	O	O	O
其它 RMSD/ 介质	X	O	O	O	O	O
电源设备 / 电源适配器	X	O	X	O	O	O
电源线	X	O	X	O	O	O
机械部件 - 风扇	X	O	O	O	O	O
机械部件 - 散热器	X	O	O	O	O	O
机械部件 - 电机	X	O	O	O	O	O
机械部件 - 其它	X	O	X	O	O	O
电池	X	O	O	O	O	O
定点设备 (鼠标等)	X	O	O	O	O	O
键盘	X	O	O	O	O	O
快擦写存储器	X	O	O	O	O	O
不间断电源设备	X	O	X	O	O	O
完整机架 / 导轨产品	X	O	X	O	O	O
软件 (CD 等)	O	O	O	O	O	O

* 印刷电路部件包括所有印刷电路板（PCB）及其各自的离散组件、IC 及连接器。

“0”表明该部件所含有害和有毒物质含量低于 MCV 标准定义的阈值。

“X”表明该部件所含有害和有毒物质含量高于 MCV 标准定义的阈值。对于所有显示 X 的情况，Dell 按照 EU RoHS 采用了容许的豁免指标。

在中国大陆销售的相应电子信息产品（EIP）都必须遵照中国大陆《电子信息产品污染控制标识要求》标准贴上环保使用期限（EPUP）标签。Dell 产品所采用的 EPUP 标签（请参阅实例，徽标内部的编号适用于指定产品）基于中国大陆的《电子信息产品环保使用期限通则》标准。





Corporate Contact Details (Taiwan Only)

Pursuant to Article 11 of the Commodity Inspection Act, Dell provides the following corporate contact details for the certified entity in Taiwan for the products addressed by this document:

Dell B.V. Taiwan Branch

20/F, No. 218, Sec. 2, Tung Hwa S. Road,

Taipei, Taiwan

Glossary

This section defines or identifies technical terms, abbreviations, and acronyms used in this document.

A

Adapter

An adapter enables the computer system to access peripheral devices by converting the protocol of one bus or interface to another. An adapter may also provide specialized function. Adapters may reside on the system board or be an add-in card. Other examples of adapters include network and SCSI adapters.

B

BIOS

(Basic Input/Output System) The part of the operating system in a system that provides the lowest level interface to peripheral devices. BIOS also refers to the Basic Input/Output System of other “intelligent” devices, such as RAID controllers.

BIOS Configuration Utility

The BIOS Configuration Utility reports and enables the configuration of controller properties. The utility resides in the controller BIOS and its operation is independent of the operating systems on your system. The BIOS Configuration Utility, also known as Ctrl-C, is built on elements called controls. Each control performs a function.

C

Coercion

Coercion is the process of rounding down the number of Logical blocks used for the physical members of a virtual disk to a common number. This allows drives with different absolute capacities, which can vary between drive manufacturers and drive families, to share a common stripe size and count as members of the virtual disk. Coercion necessarily results in a smaller capacity than was available on the un-coerced basic physical drive.

Controller

A chip that controls the transfer of data between the microprocessor and memory or between the microprocessor and a peripheral device such as a physical disk or the keyboard. In Storage Management, the hardware or logic that interacts with storage devices to write and retrieve data and perform storage management. RAID controllers perform RAID functions such as striping and mirroring to provide data protection.

D

Disk

A non-volatile, randomly addressable, rewriteable mass storage device, including rotating magnetic, optical and solid-state storage devices, or non-volatile electronic storage elements.

DKMS

DKMS stands for Dynamic Kernel Module Support. It is designed to create a framework where kernel dependent module source can reside so that it is very easy to rebuild modules as you upgrade kernels. This will allow Linux vendors to provide driver drops without having to wait for new kernel releases while also taking out the guesswork for customers attempting to recompile modules for new kernels.

Driver

A device driver, often called a driver for short, is a program that allows the operating system or some other program to interface correctly with a peripheral device such as a printer, a network PC card or the PERC H200 card.

DUD (Driver Update Diskette)

Acronym for driver update diskette. A DUD is an image of a diskette stored as a regular file. To use it, you have to create a real diskette from this file. The steps used to create the diskette depend on how the image is supplied.

F

Firmware

Software stored in read-only memory (ROM) or Programmable ROM (PROM). Firmware is often responsible for the behavior of a system when it is first turned on. A typical example would be a monitor program in a system that loads the full operating system from disk or from a network and then passes control to the operating system.

Flash Memory

Sometimes referred as simply "flash", is a compact, solid-state, rewriteable, non-volatile memory device that retains its data when the power is turned off. It offers fast access time, low power consumption, and relative immunity to severe shock or vibration. It is a special type of EEPROM that can be erased and reprogrammed in blocks instead of one byte at a time. Many modern PCs have their BIOS stored on a flash memory chip so that it can easily be updated if necessary. Such a BIOS is sometimes called a flash BIOS.

H

Hardware

The mechanical, magnetic, electronic, and electrical components making up a computer system constitutes its hardware.

Hot Add/Remove

It is the addition/removal of a component while the system is running and operating normally.

L

Link

A connection between any two PCI Express devices is known as a link.

M

MHz

Megahertz or one million cycles per second is a unit of frequency commonly used to measure the operating speed of a computer processor or any other electronic component.

Mirroring

The process of providing complete redundancy using two physical disks, by maintaining an exact copy of one physical disk's data on the second physical disk. If one physical disk fails, the contents of the other physical disk can be used to maintain the integrity of the system and to rebuild the failed physical disk.

O

Operating System

The software that runs a computer, including scheduling tasks, managing storage, and handling communication with peripherals and performs basic input/output functions, such as recognizing input from the keyboard, sending output to the display screen, etc. is called an operating system.

P

PCI Express (PCI-E)

PCI Express (PCI-E) is an evolutionary upgrade to the existing Peripheral Component Interconnect (PCI) bus. PCI-E is a serial connection that operates more like a network than a bus. Instead of one bus that handles data from multiple sources, PCI-E has a switch that controls several point-to-point serial connections. These connections fan out from the switch, leading directly to the devices where the data needs to go. Every device has its own dedicated connection, so devices no longer share bandwidth like they do on a normal bus.

PHY

The interface required to transmit and receive data packets transferred across the serial bus. Each PHY can form one side of the physical link in a connection with a PHY on a different Dell-qualified SATA device. The physical link contains four wires that form two differential signal pairs. One differential pair transmits signals, while the other differential pair receives signals. Both differential pairs operate simultaneously and allow concurrent data transmission in both the receive and the transmit directions.

Physical Disk

A physical disk (also known as hard disk drive) consists of one or more rigid magnetic discs rotating about a central axle, with associated read/write heads and electronics. A physical disk is used to store information, (data), in a non-volatile and randomly accessible memory space.

POST

POST, short for Power-On Self-Test is a process performed before the operating system loads when the computer is turned on. The POST tests various system components, such as RAM, the physical disks, and the keyboard.

R

RAID

Acronym for Redundant volume of Independent Disks (originally Redundant volume of Inexpensive Disks). It is an volume of multiple independent physical disks managed together to yield higher reliability and/or performance exceeding that of a single physical disk. The virtual disk appears to the operating system as a single storage unit. I/O is expedited because several disks can be accessed simultaneously. Redundant RAID levels provide data protection.

ROM

Read-only memory (ROM), also known as firmware, is an integrated circuit programmed with specific data when it is manufactured. ROM chips are used not only in computers, but in most other electronic items as well. Data stored in these chips is nonvolatile i.e., it is not lost when the power is turned off. Data stored in these chips is either unchangeable or requires a special operation such as flashing to change.

RPM

RPM, short for "Red Hat Package Manager" is a package management system primarily intended for Linux. RPM installs, updates, uninstalls, verifies and queries software. RPM is the baseline package format of the Linux Standard Base. Originally developed by Red Hat for Red Hat Linux, RPM is now used by many Linux distributions. It has also been ported to some other operating systems such as NetWare by Novell.

S

SAS

Serial-Attached SCSI, SAS, is a serial, point-to-point, enterprise-level device interface that leverages the proven SCSI protocol set. The SAS interface provides improved performance, simplified cabling, smaller connectors, lower pin count, and lower power requirements when compared to parallel SCSI.

SATA

Serial Advanced Technology Attachment, a physical storage interface standard, is a serial link that provides point-to-point connections between devices. The thinner serial cables allow for better airflow within the system and permit smaller chassis designs.

SCSI

SCSI stands for "Small Computer System Interface," a processor-independent standard interface for system-level interfacing between a computer and intelligent devices including hard-drives, floppy disks, CD-ROM, printer, scanners and many more.

SCSIport

SCSIport driver is a Microsoft® driver for Windows® XP storage architecture, delivering SCSI commands to the storage targets. The SCSIport driver works well with storage using parallel SCSI.

Serial Architecture

Serial architectures have emerged to deliver higher performance by allowing more bandwidth per device pathway than their parallel counterparts. Serial architecture connections consist of a single pair of transmission signals that contain an embedded clock for self-clocking, enabling clock speed to be easily scaled. Serial bus architectures also support a network of dedicated point-to-point device connections, versus the multi-drop architectures of parallel buses, to deliver full bandwidth to each device, eliminate the need for bus arbitration, reduce latency, and greatly simplify hot-plug and hot-swap system implementations.

Serial Technology

Serial storage technology, specifically Serial ATA, Serial-Attached SCSI and PCI Express, address the architectural limitations of their parallel counterparts to deliver highly scalable performance. The technology draws its name from the way it transmits signals - in a single stream, or serially, compared to multiple streams for parallel. The main advantage of serial technology is that while it moves data in a single stream, it wraps data bits into individual packets that are transferred up to 30 times faster than parallel technology data.

SMART

Acronym for Self-Monitoring Analysis and Reporting Technology. The self-monitoring analysis and reporting technology (SMART) feature monitors the internal performance of all motors, heads, and drive electronics to detect predictable drive failures. This feature helps monitor drive performance and reliability, and protects the data on the drive. When problems are detected on a drive, you can replace or repair the drive without losing any data. SMART-compliant disks have attributes for which data (values) can be monitored to identify changes in values and determine whether the values are within threshold limits. Many mechanical failures and some electrical failures display some degradation in performance before failure.

Storport

The Storport driver has been designed to replace SCSIport and work with Windows 2003 and beyond. In addition, it offers better performance for storage controllers, providing higher I/O throughput rates, improved manageability, and an upgraded miniport interface.

Stripe Element

A stripe element is the portion of a stripe that resides on a single physical disk.

Striping

Disk striping writes data across all physical disks in a virtual disk. Each stripe consists of consecutive virtual disk data addresses that are mapped in fixed-size units to each physical disk in the virtual disk using a sequential pattern. For example, if the virtual disk includes five physical disks, the stripe writes data to physical disks one through five without repeating any of the physical disks. The amount of space consumed by a stripe is the same on each physical disk. The portion of a stripe that resides on a physical disk is a stripe element. Striping by itself does not provide data redundancy.

W

Windows

Microsoft Windows is a range of commercial operating environments for computers. It provides a graphical user interface (GUI) to access programs and data on the computer.

X

XP

XP is a Microsoft Windows operating system. Released in 2001, it is built on the Windows 2000 kernel, making it more stable and reliable than previous versions of Windows. It includes an improved user interface and more mobility features, such as plug and play features used to connect to wireless networks.

Index

B

- BIOS, 43
 - Configuration Utility, 44
 - fault code messages, 43
 - POST messages, 43

C

- Configuration Utility
 - functions performed, 44
 - overview, 44
 - starting, 44

D

- driver diskette, 32
- drivers
 - installation, 31
 - Microsoft operating system installation, 33

E

- electrostatic discharge. *See* ESD
- ESD, 10

F

- firmware
 - update utility, 71
 - updating, 71

I

- installation
 - driver, 31
 - SAS 6/iR Adapter, 25
- Integrated RAID
 - configuration, 51
 - create new virtual disk, 47
 - creating IM, 53
 - creating IS, 52
- Integrated Striping, 15
 - manage array, 50
 - new virtual disk, 47
 - rebuilding virtual disk, 58
 - replacing virtual disk, 58
 - view virtual disk, 50
 - virtual disk activation, 56
 - virtual disk deletion, 57
 - virtual disk properties, 55

M

- Manage Array, 50

R

RAID, 15

RAID 0, 15

Red Hat Enterprise Linux, 31

S

safety instructions

for preventing ESD, 10

SAS 6/iR

BIOS, 43

features, 19

overview, 13

SAS 6/iR Adapter installation, 25

specifications, 19

troubleshooting, 61

T

troubleshooting, 61

BIOS boot order, 61

BIOS error messages, 65

Configuration Utility error
messages, 63

physical disk issues, 62

W

Windows, 31

drivers, 31

Free Manuals Download Website

<http://myh66.com>

<http://usermanuals.us>

<http://www.somanuals.com>

<http://www.4manuals.cc>

<http://www.manual-lib.com>

<http://www.404manual.com>

<http://www.luxmanual.com>

<http://aubethermostatmanual.com>

Golf course search by state

<http://golfingnear.com>

Email search by domain

<http://emailbydomain.com>

Auto manuals search

<http://auto.somanuals.com>

TV manuals search

<http://tv.somanuals.com>