

Dell™ 2200MP Projector User's Guide

The information below is provided by the supplier of the referenced device without independent verification by Dell and is subject to the [restrictions and disclaimers](#).

[Safety Instructions \(Read before connecting the projector\)](#)

[About Your Projector](#)

[Installation](#)

[Using Your Projector](#)

[Troubleshooting](#)

[Specifications](#)

[Regulatory Notices](#)

[Contacting Dell](#)

Notes, Notices, and Cautions



NOTE: A NOTE indicates important information that helps you make better use of your projector.



NOTICE: A NOTICE indicates either potential damage to hardware or loss of data and tells you how to avoid the problem.



CAUTION: A CAUTION indicates a potential for property damage, personal injury, or death.

Information in this document is subject to change without notice.

©2003 Coretronic Corporation.

©2003 Dell Inc.. All rights reserved.

Reproduction in any manner whatsoever without the written permission of Dell Inc. is strictly forbidden.

Trademarks used in this text: *Dell* and the *DELL* logo are trademarks of Dell Inc.; *DLP* and *Texas Instruments* are trademarks of Texas Instruments Corporation; *Microsoft* and *Windows* are registered trademarks of Microsoft Corporation; *Macintosh* is a registered trademark of Apple Computer, Inc.

Other trademarks and trade names may be used in this document to refer to either the entities claiming the marks and names or their products. Dell Inc. disclaims any proprietary interest in trademarks and trade names other than its own.

Restrictions and Disclaimers

The information contained in this document, including all instructions, cautions, and regulatory approvals and certifications, is based upon statements provided to Dell by the manufacturer and has not been independently verified or tested by Dell. Dell disclaims all liability in connection with any deficiencies in such information.

All statements or claims regarding the properties, capabilities, speeds, or qualifications of the part referenced in this document are made by the manufacturer and not by Dell. Dell specifically disclaims any knowledge of the accuracy, completeness, or substantiation for any such statements.

October 2003 Rev. A00

Safety Instructions: Dell™ 2200MP Projector



CAUTION

Use the following safety guidelines to help protect your projector from potential damage and to ensure your own personal safety:

- The surface beneath the projector might be hot with use. Be careful in handling the unit.
- The lamp becomes very hot with use. Do not attempt to replace the lamp after use until the projector has been allowed to cool down for at least 30 minutes, and follow all instructions in "[Changing the Lamp](#)."
- Do not touch the bulb or the lamp glass at any time. The bulb may explode due to improper handling, including the touching of the bulb or the lamp glass.
- Remove lens cap before turning on projector. Failure to do so may cause the lens cap to reach high temperatures.
- To avoid damaging the projector and lamp, allow the cooling fan to run for 2 minutes before turning off the projector.
- Do not block the ventilation slots and openings on the projector.
- Disconnect the power cord from the electrical outlet if the projector is not used for a long period of time.
- Do not use the projector in an extremely hot, cold, or humid environment.
- Do not use the projector in areas susceptible to excessive dust and dirt.
- Do not use the projector near any appliance that generates a strong magnetic field.
- Do not place the projector in direct sunlight.
- Do not look into the lens while the projector is on; the bright light may hurt your eyes.
- To reduce the risk of fire or electric shock, do not expose the projector to rain or moisture.
- To prevent electric shock, do not open or disassemble the projector further than what is needed for lamp replacement.
- To avoid damaging the projector, ensure that the zoom lens and elevator foot are fully retracted before moving the projector or placing the projector in its carrying case.
- Turn off the projector and disconnect it from the electrical outlet before cleaning it. Use a soft cloth moistened with mild detergent to clean the display housing. Do not use abrasive cleaners, waxes, or solvents.

About Your Projector: Dell™ 2200MP Projector

- [Features](#)
- [Equipment](#)
- [Main Unit](#)
- [Control Panel](#)
- [Connection Ports](#)
- [Remote Control](#)

Features

- Single chip 0.55" Texas Instruments DLP™ technology
- High contrast, double data rate (DDR) digital micromirror device
- True SVGA, 800 x 600 addressable pixels
- 4.7 lbs (2.14 kgs) lightweight compact design
- 1200 ANSI lumens brightness (Max)*
- 1700:1 full on / full off contrast ratio
- 1.2x manual zoom lens
- Built in 2W speaker
- Auto image re-sizing (Auto-Sync) to 800 x 600 full screen with scaling compression compatibility for SXGA+,SXGA, XGA, SVGA, VGA, MAC
- Preset and user defined video modes for optimum video and graphic settings
- Self-diagnostic for video troubleshooting
- State-of-the-art motion adaptive hardware deinterlacing with 3:2 and 2:2 pull down
- 200-watt, user-replaceable lamp
- Compatibility with Macintosh® computers
- Compatibility with NTSC, NTSC4.43, PAL, PAL-M, PAL-N, SECAM, and HDTV (1080i, 720P, 576i/P, 480i/P)
- Multi-function remote control
- D-Sub 15-pin cable for analog video connectivity
- High-definition TV compatibility
- User-friendly, multi-language on-screen display (OSD)
- Advanced electronic keystone correction
- User-friendly control panel with backlight
- Carrying case included

*Based on ANSI/NAPM IT7.228-1997 tests of 100 units, October 2003, with average ANSI Lumens 1152. Bulb brightness degrades with usage. Dell recommends replacing your bulb after 2000 hours usage.

Equipment

Your projector comes with all the items shown below. Ensure that you have all the items, and [contact Dell](#) if anything is missing.

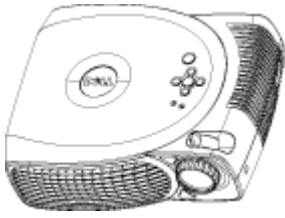

Main unit

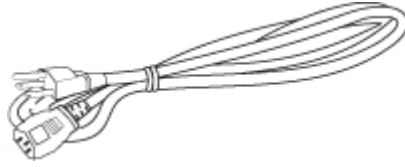

3.0m Power cord

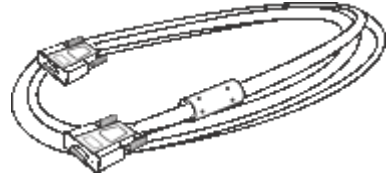

**1.8m VGA cable
(D-sub to D-sub)**



2.0m S-video cable



1.8m USB cable



1.8m Composite Video cable

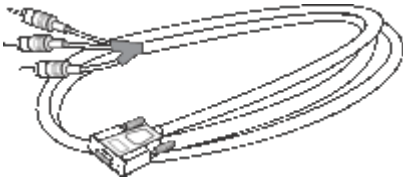

1.8m D-sub to YPbPr cable

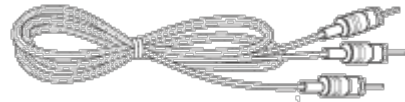

1.8m RCA to Audio cable

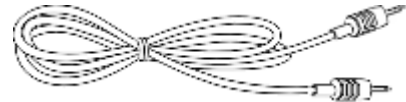

1.8m mini pin to mini pin cable



Remote control



***Dell 2200MP Projector
User's Guide***

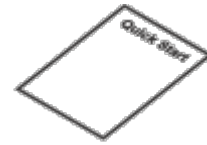

***Dell 2200MP Projector Quick Start
Card***

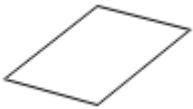

Warranty Guide



Owner's Manual



Carrying case

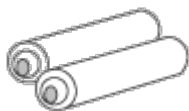

Batteries (2)

Main Unit

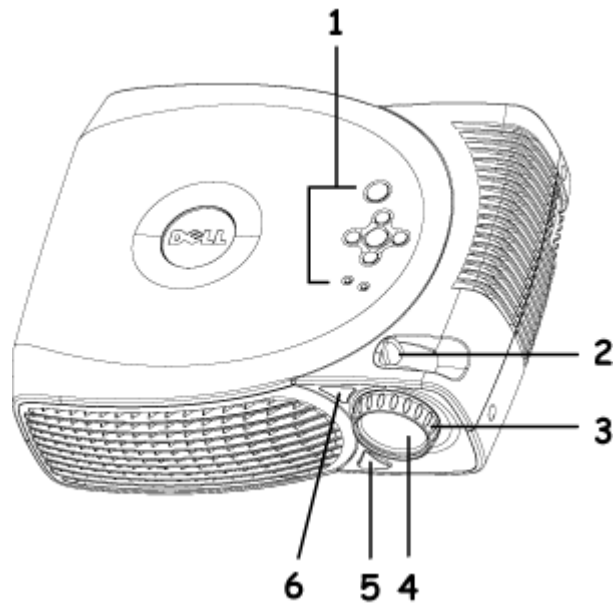

1	Control panel
2	Zoom tab
3	Focus ring
4	Lens
5	Elevator button
6	Remote control receiver

Control Panel

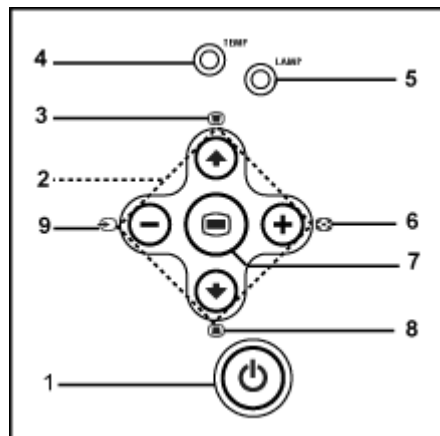

1	Power button
2	Four directional keys
3	Keystone adjustment
4	Temperature warning light

5	Lamp warning light
6	Resync
7	Menu
8	Keystone adjustment
9	Source

Connection Ports

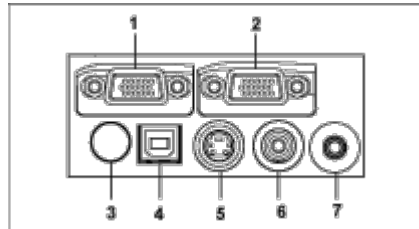

1	VGA in (D-sub) connector
2	VGA out (monitor loop-through)
3	IR receiver
4	USB connector
5	S-video connector
6	Composite video connector
7	Audio input connector

Remote Control

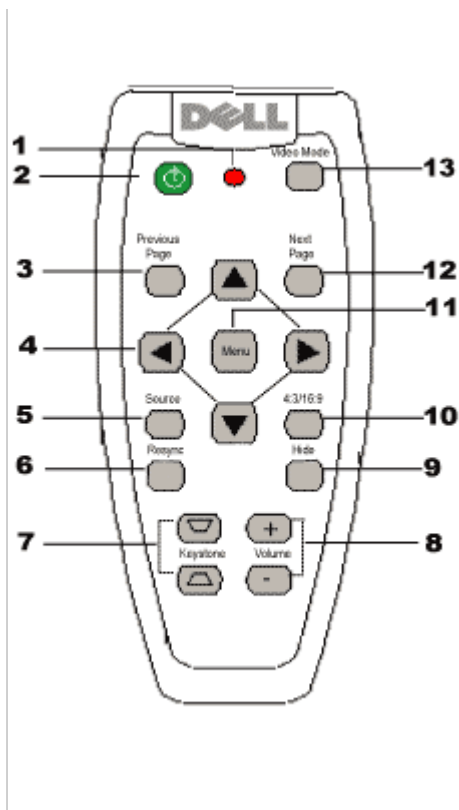

1	Light
2	Power button
3	Previous Page button (page up)
4	Four Direction buttons
5	Source button
6	Resync button
7	Keystone Correction button
8	Volume button
9	Hide button
10	4:3/16:9 (aspect ratio) button
11	Menu button
12	Next Page button (page down)
13	Video Mode button



Battery Disposal: Your projector remote control uses zinc-manganese batteries. If you need to replace the batteries, see your *Dell 2200MP Projector Quick Start Card*.

Do not dispose of used batteries along with household waste. Contact your local waste disposal agency for the address of the nearest battery deposit site.

Installation: Dell™ 2200MP Projector

- [Connecting the Projector](#)
 - [Powering On/Off the Projector](#)
 - [Adjusting the Projected Image](#)
 - [Changing the Lamp](#)
-

Connecting the Projector

A. To Computer

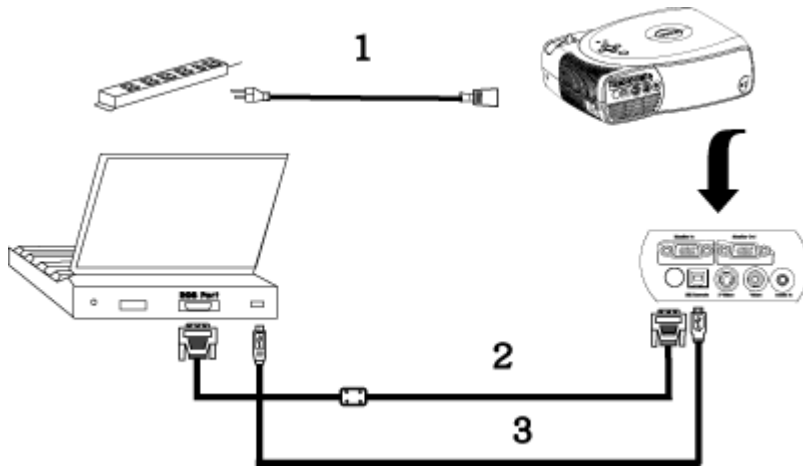

1	Power cord
2	D-sub to D-sub cable
3	USB to USB cable

B. To DVD Player: There are three possible methods of connecting to a DVD player.

1. Connecting with component cable:

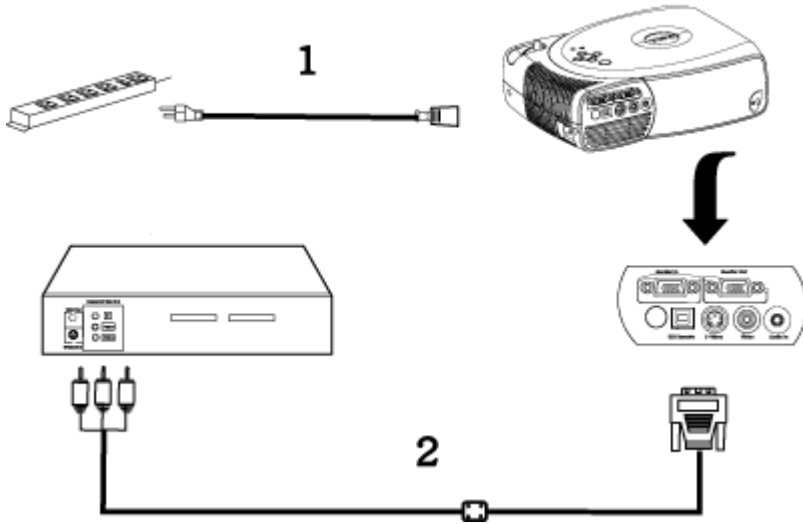

1	Power cord
2	D-sub to HDTV/Component cable

2. Connecting with S-video cable:

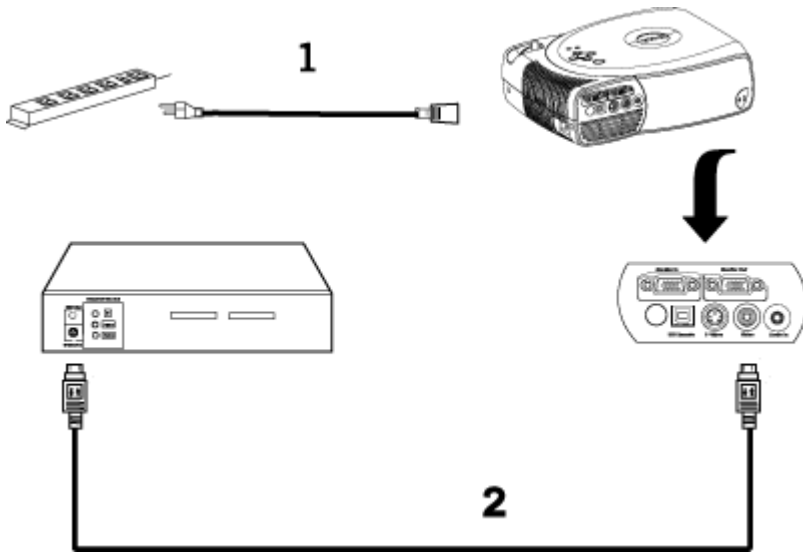

1	Power cord
2	S-video cable

3. Connecting with composite cable:

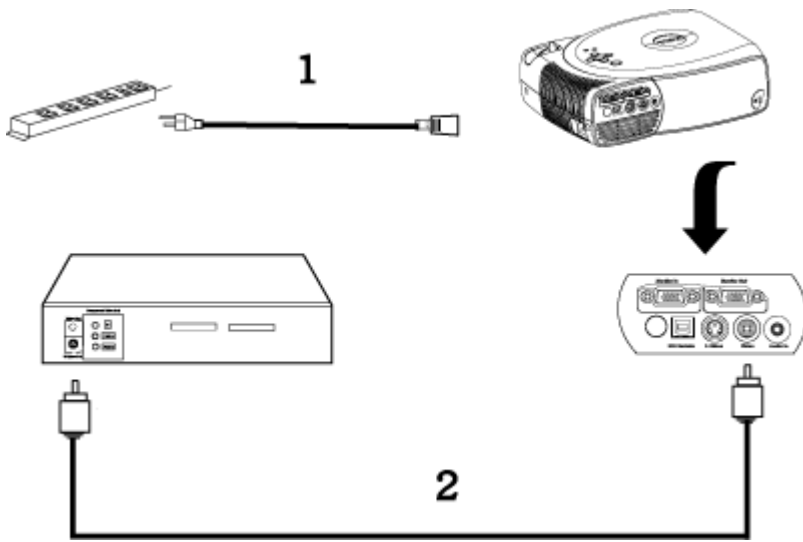

1	Power cord
2	Composite video cable

Powering On/Off the Projector

Powering On the Projector

 **NOTE:** Turn on the projector before you turn on the source.

1. Remove the lens cap.
 2. Ensure that the power cord and appropriate signal cable(s) are securely connected. The power button light will blink green.
 3. Press the power button to turn on the projector. The Dell logo will be displayed for 30 seconds.
 4. Turn on your source (computer, notebook, DVD, etc.). The projector automatically detects your source.
- If the "Searching for signal..." message appears on the screen, ensure that the appropriate signal cable(s) are securely connected.
 - If you are connecting multiple sources to the projector simultaneously, press the **Source** button on the [remote control](#) or [control panel](#) to select the desired source.



1	Power button
2	Lens cap

Powering Off the Projector

DO NOT UNPLUG THE PROJECTOR BEFORE PROPERLY SHUTTING DOWN USING THE FOLLOWING STEPS.

1. Press the power button to turn off the projector. The "Power Off the Lamp?" message appears on the OSD.
2. Press the power button again. The cooling fans continue to operate for 2 minutes.
3. If the **LAMP** light is solid orange, replace the lamp.
4. If the **TEMP** light is solid orange, the projector has overheated. The display automatically shuts down. Try turning the display on again after the projector cools down. If the problem persists, [contact Dell](#).
5. If the **TEMP** light is blinking orange, a projector fan has failed and the projector will automatically shut down. If this problem persists, [contact Dell](#).
6. Disconnect the power cord from the electrical outlet and the projector.
7. If you press the power button while the projector is running, the "Power Off the Lamp?" message appears on the screen. To clear the message, press any button on the control panel or ignore the message; the message will disappear after 5 seconds.

Adjusting the Projected Image

Adjusting the Projector Height

To raise the projector:

1. Press the elevator button.
2. Raise the projector to the desired display angle, and then release the button to lock the elevator foot into position.
3. Use the tilt adjustment wheel to fine-tune the display angle.

To lower the projector:

1. Press the elevator button.
2. Lower the projector, and then release the button to lock the elevator foot into position.

Notice: To avoid damaging the projector, make sure that the zoom lens and elevator foot are fully retracted before placing the projector in its carrying case.

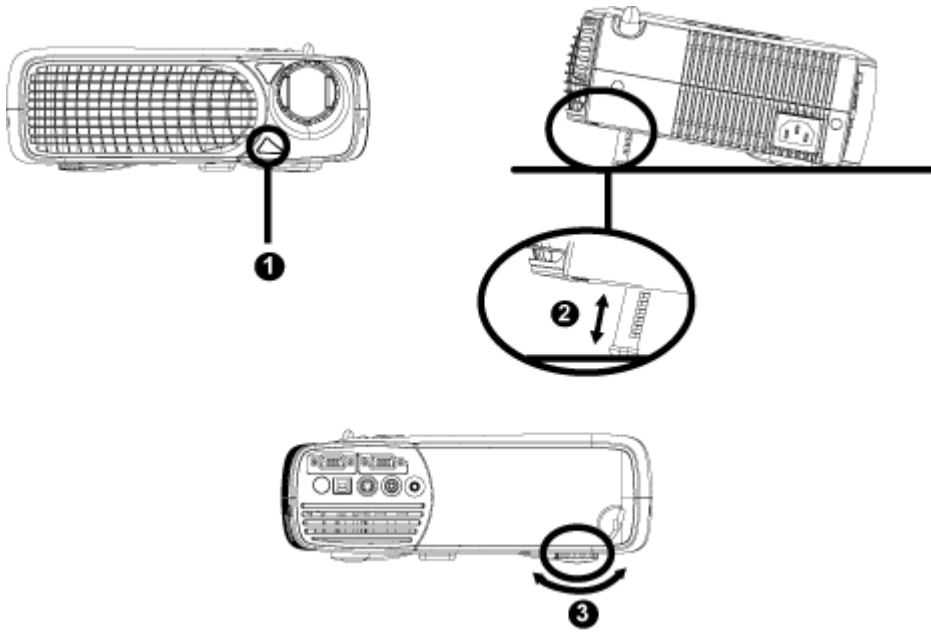

1	Elevator button
2	Elevator foot
3	Tilt adjustment wheel

Adjusting the Projector Zoom and Focus

1. Rotate the zoom tab to zoom in and out.
2. Rotate the focus ring until the image is clear. The projector focuses at distances from 3.9 ft to 39.4ft (1.2 m to 12 m).

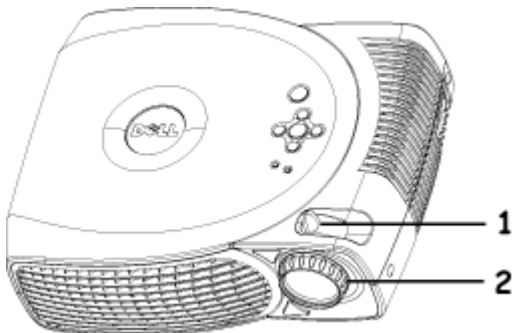

1	Zoom tab
2	Focus ring

Adjusting Projection Image Size

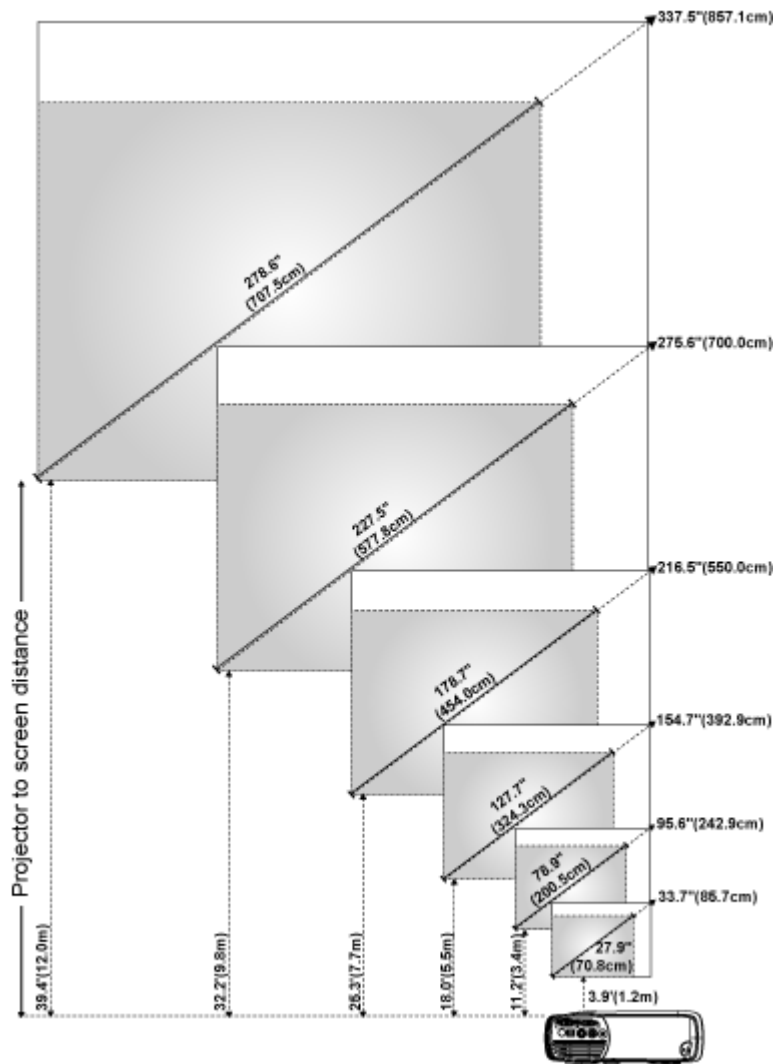

Screen (Diagonal)	Max.	33.7" (85.7cm)	95.6" (242.9cm)	154.7" (392.9cm)	216.5" (550.0cm)	275.6" (700.0cm)	337.5" (857.1cm)
	Min.	27.9" (70.8cm)	78.9" (200.5cm)	127.7" (324.3cm)	178.7" (454.0cm)	227.5" (577.8cm)	278.6" (707.5cm)
Screen Size	Max. (WxH)	27.0"X20.2"	76.5"X57.4"	123.7"X92.8"	173.2"X129.9"	220.5"X165.4"	270.0"X202.5"
	Min. (WxH)	22.3"X16.7"	63.1"X47.4"	102.1"X76.6"	143.0"X107.2"	182.0"X136.5"	222.8"X167.1"
Distance		3.9'(1.2m)	11.2'(3.4m)	18.0'(5.5m)	25.3'(7.7m)	32.2'(9.8m)	39.4'(12.0m)

* This graph is for user reference only.

Changing the Lamp

Replace the lamp when you see "Lamp is approaching the end of its useful life in full power operation. Replacement suggested!" message on the screen by carefully following these instructions. If this problem persists, [contact Dell](#).

CAUTION: The lamp becomes very hot with use. Do not attempt to replace the lamp after use until the projector has been allowed to cool down for at least 30 minutes.

Lamp Changing Procedure:

1. Turn off the projector and disconnect the power cord.
2. Let the projector cool for at least 30 minutes.
3. Loosen the 2 screws that secure the lamp cover, and remove the cover.
4. Loosen the 3 screws that secure the lamp.
5. Pull up the lamp by its metal handle.

6. Reverse steps 1 through 5 to install the new lamp.
7. Reset the lamp by selecting the left **Lamp Reset** icon in the OSD **Management** tab.
8. Dell may require that lamps replaced under warranty are returned to Dell. Otherwise, contact your local waste disposal agency for the address of the nearest deposit site.
9. The lamp contains mercury. Disposal of this material may be regulated due to environmental considerations. For disposal or recycling information, please contact your local authorities or the Electronic Industries Alliance: www.eiae.org.

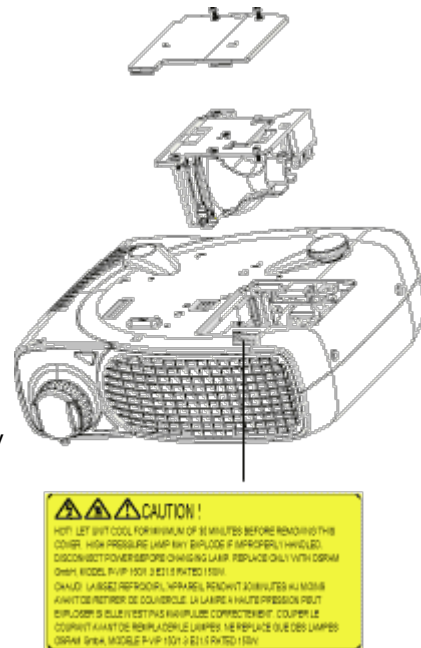

CAUTION: Do not touch the bulb or the lamp glass at any time. The bulb may explode due to improper handling, including the touching of the bulb or the lamp glass.

[Back to Contents Page](#)

Using Your Projector: Dell™ 2200MP Projector

- [Control Panel](#)
 - [Remote Control](#)
 - [On-Screen Display](#)
-

Control Panel

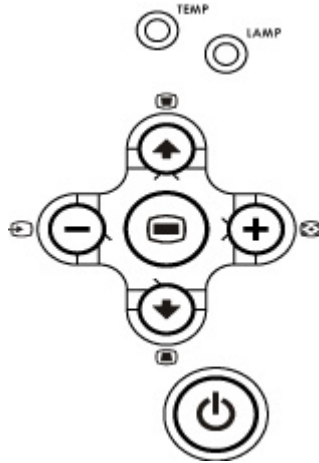

Power

See "[Powering On/Off the Projector.](#)"

Source

Press  to step through Analog RGB, Composite, Component-I, S-video, and Analog YPbPr sources when multiple sources are connected to the projector.

Resync

Press  to synchronize the projector to the input source.
Resync will not operate if the [OSD](#) (On-Screen Display) is displayed.



Menu

Press  to activate the [OSD](#). Use the directional keys and **Menu** button to navigate through the OSD.

Four Directional Keys

The four directional keys  can be used to toggle through the tabs in the [OSD](#).

Keystone

Press  or  button to adjust image distortion caused by tilting the projector. (± 16 degrees)

Remote Control



Power

See "[Power On/Off the Projector.](#)"

Source



Press the **Source** button to choose Analog RGB, Composite, Component-I, S-video, and Analog YPbPr sources.

Resync

Press  to synchronize the projector to the input source.

Resync will not operate if the [OSD](#) (On-Screen Display) is displayed.

Directional Keys

Use  or  to select OSD items, use "left" and "right" button to make adjustments.

Hide

Press **Hide** button to hide the image, press again to resume display of the image.

Video Mode

The Dell 2200MP Microprojector has preset configurations that are optimized for displaying data (PC Graphics) or video (movies, games, etc.). Press **Video Mode** button to toggle between **PC mode**, **Movie mode**, **sRGB**, or **User mode** (for user to setup and save preferred settings). Pressing the **Video Mode** button once will show the current display mode. Pressing the **Video Mode** button again will switch between modes.

Previous Page

Press the **Previous Page** button to page up.

Next Page

Press the **Next Page** button to page down.

Menu

Press the **Menu** button to activate the [OSD](#). Use the directional keys and **Menu** button to navigate through the OSD.

Volume up/down

Press the **up** button to increase the volume, press the **down** button to reduce the volume.









4:3/16:9

Press the **4:3/16:9** to switch the image aspect ratio from 4:3 to 16:9.

Keystone

Adjusts image distortion caused by tilting the projector. (±16 degrees)

On-Screen Display

- The projector has a multi-language On-Screen Display (OSD) that can only be displayed when an input source is present.
- The OSD allows you to make image adjustments and change a variety of settings. If the source is a computer, the OSD allows changes to the Computer Image tab. When using a video source, the OSD allows changes to the Video Image tab. The projector automatically detects the source.
- When the OSD is on the screen, press  or  to navigate through the OSD tabs.
Example: All Images--> Computer Image--> Audio--> Management--> Language--> Factory Reset. To make a selection in a tab, press  on keypad or "Menu" on remote controller.
- Press  or  to make a selection and adjust the settings by pressing  or  on keypad or Left and Right button on the remote controller. When an item is selected, the color of the item will change to dark gray.
- To exit the OSD, go to "Exit" tab and press  button on keypad or "Menu" on remote controller.

All Images Menu

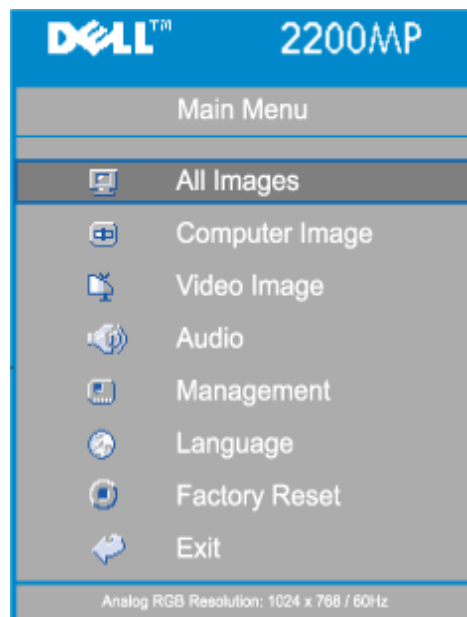





Brightness

Adjusts the brightness of the image.





- Press  to darken the image.
- Press  to lighten the image.

Contrast

Controls the degree of difference between the lightest and darkest parts of the picture. Adjusting the contrast changes the amount of black and white in the image.



- Press  to decrease the contrast.
- Press  to increase the contrast.

Color Temp.



Adjusts the color temperature. With the higher temperature, the screen looks colder; with the lower temperature, the screen looks warmer. User mode activates the values in the "color setting" menu.

Color Setting



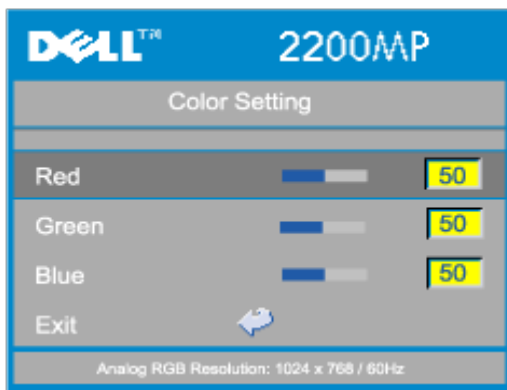

This mode allows for manual adjustment of red, green, and blue color settings. Modifying these values will automatically change the color temperature to "user".

Keystone



Adjusts image distortion caused by tilting the projector. (+/-16 degrees)

Aspect Ratio



Select this function to fit 16:9U, 1:1, 16:9, 4:3 aspect ratio. In order to use the 1:1 aspect ratio, the input must be a computer signal (through VGA cable) of resolution less than SVGA (800 x 600), component 576p/ 480i / 480p, S-Video, or Video (composite). If the input signal is a computer signal greater than SVGA or component 1080i / 720p, only 16:9, 16:9U or 4:3 aspect ratio will be available. When an icon is selected, the color of the icon will change to dark blue.

16:9U The input source will be displayed in wide screen mode (16:9) without scaling. Some pixels will be truncated accordingly.

1:1 The input source will be displayed without scaling.

16:9 The input source will be displayed in wide screen mode (16:9) without scaling. The source will be scaled to fit the width of the screen.

4:3 The input source will be scaled to fit the screen.

Video Mode



Select this function to optimize the display image for home use (**Movie Mode**), conference use (**PC Mode**), standard color use (**sRGB**), or as user preferable settings (**User Mode**). When an icon is selected, the color of the icon will change to dark blue. The default setting is **PC Mode**. Adjusting the settings of **White Intensity** or **Degamma** tab will select **User Mode** automatically.

White Intensity

White Intensity can be adjusted between 0 and 10.



- Setting 10 will maximize the brightness.
- Setting 0 will maximize color reproduction quality.

Degamma



Degamma can be adjusted between 1 and 7. Default setting is 3 (Recommended). Adjustment of the setting will change the color performance of the display.

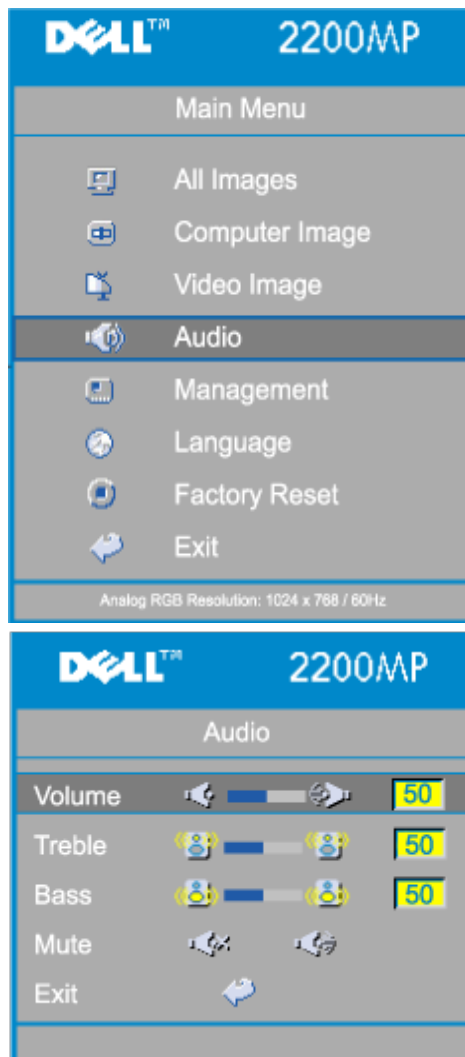

Audio Menu

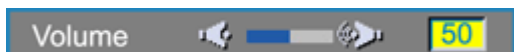

Audio

Volume





- Press  to decrease the volume.
- Press  to increase the volume.

Treble

Control the higher frequencies of your audio source.





- Press  to decrease the treble.
- Press  to increase the treble.

Bass

Control the lower frequencies of your audio source.



- Press  to decrease the bass.
- Press  to increase the bass.

Mute



- Select the left icon to mute the volume.
- Select the right icon to unmute the volume.

Management Menu

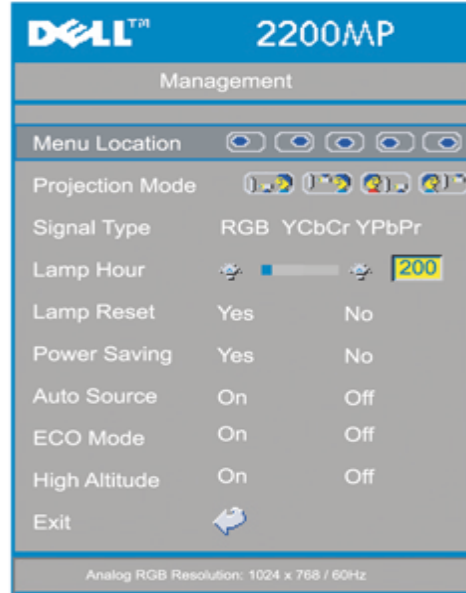
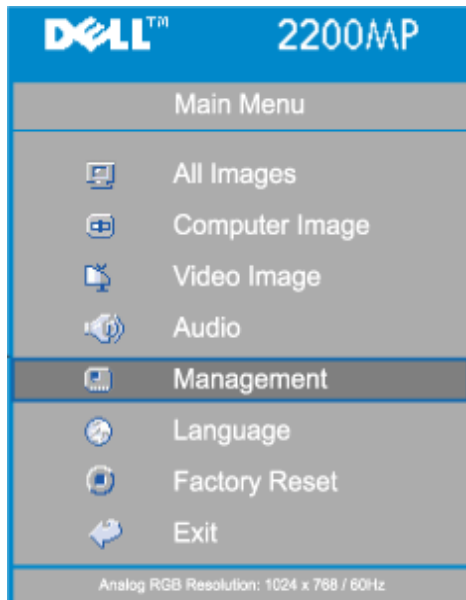

Management





Menu Location



Select the location of the OSD on the screen.

Projection Mode



-  Front Projection-Desktop
The default setting.
-  Rear Projection-Desktop
The projector reverses the image so you can project from behind a translucent screen.
-  Front Projection-Ceiling Mount
The projector turns the image upside down for ceiling-mounted projection.
-  Rear Projection-Ceiling Mount
The projector simultaneously reverses and turns the image upside down. You can project from behind a translucent screen with a ceiling-mounted projection.

Signal Type



Manually select signal type RGB, YCbCr, YPbPr.

Lamp Hour



Displays operating hours since lamp timer reset.

Lamp Reset

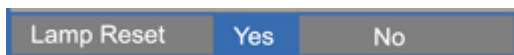

Use this function only after a new lamp is installed in the projector. Select the left **Lamp Reset** icon (light bulb and arrow under the icon), and press the **Enter** button to reset the lamp timer.

Power Saving Menu

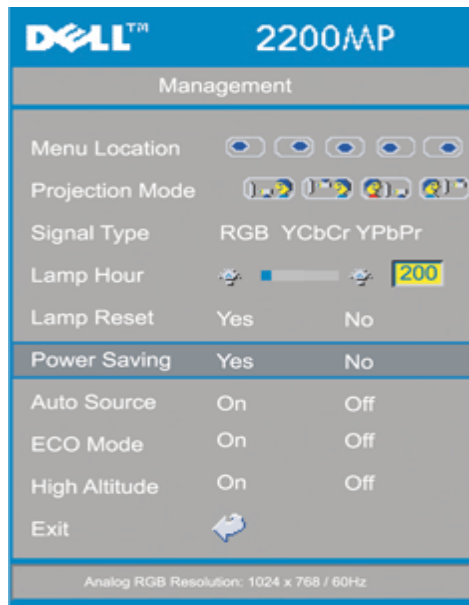

Power Saving

Use this function to select the power saving delay period. Press "Yes" to go into the "set time" sub menu.

Set Time(Min)



Set the power saving delay period as you prefer. When the projector is not receiving an input signal for the selected period of time, the projector will automatically enter power saving mode, and turn off the lamp. After a one-minute cooling period, the projector will turn back on with detection of an input signal or by pressing the "Power" button. After two hours the projector will turn off and must be turned on by pressing the power button on the control panel or remote.

Auto Source



The projector will always automatically search for available input signals when **Auto Source** is **On**, which is the default setting. Press the "Source" button with **Auto Source On** to automatically search for the next available input signal. Selecting **Off** will lock on the current input source. Set **Auto-Source** to **Off** to step through the different input signals manually.

ECO Mode



Use this function to dim the projector lamp light output which will lower power consumption and increase lamp life. Selecting "On" will dim the projector lamp; selecting "Off" will return the lamp to high brightness mode.

High Altitude

High Altitude **On** Off



Turning on **High Altitude** mode operates the fans at full speed continuously to allow for proper high altitude cooling of the projector.

Language Menu



Language

Language

Press  or  to select the language you prefer.

Factory Reset Menu

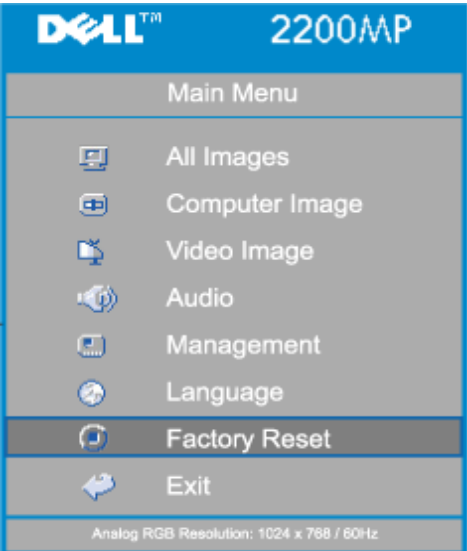



Factory Reset

Select **Yes** to reset the projector to its factory default settings. Reset items include both computer image and video image settings.

Computer Image Menu

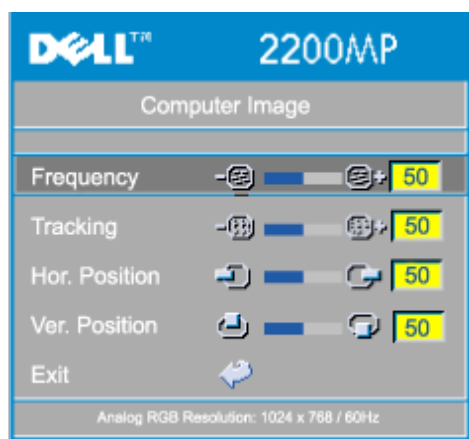

Computer Image- Note: this menu is only available with computer input signal.

Frequency



Change the display data frequency to match the frequency of your computer graphic card. If you experience a vertical flickering bar, use the frequency function to make an

adjustment.

Tracking



Synchronize the signal timing of the display with that of the graphic card. If you experience an unstable or flickering image, use the tracking function to correct it.

Hor. Position (Horizontal Position)



- Press to move the image left.
- Press to move the image right.

Ver. Position (Vertical Position)



- Press to move the image down.
- Press to move the image up.

Video Image Menu



Video Image- Note: this menu is only available with S-video, video(composite) signal.

Saturation



Adjust a video image from black and white to fully saturated color.



- Press to decrease the amount of color in the image.

- Press  to increase the amount of color in the image.

Sharpness





Adjust the sharpness of the image.

- Press  to decrease the sharpness.
- Press  to increase the sharpness.

Tint



Adjust the color balance of red and green.

- Press  to increase the amount of green in the image.
- Press  to increase the amount of red in the image.



[Back to Contents Page](#)

Troubleshooting: Dell™ 2200MP Projector



- [No image appears on the screen](#)
- [Partial, scrolling, or incorrectly displayed image](#)
- [The screen does not display your presentation](#)
- [Image is unstable or flickering](#)
- [Image has vertical flickering bar](#)
- [Image color is not correct](#)
- [Image is out of focus](#)
- [The image is stretched when displaying 16:9 DVD](#)
- [Image is reversed](#)
- [Lamp is burned out or makes a popping sound](#)
- [Self-diagnostic for video](#)
- [Noise made when turning projector upside down](#)

If you experience problems with your projector, see the following troubleshooting tips. If the problem persists, [contact Dell](#).

No image appears on the screen

- Ensure that the lens cap is removed and the projector is turned on.
- Ensure the external graphics port is enabled. If you are using a Dell portable computer, press  . For other computers, consult your owner's manual.
- Ensure that all the cables are securely connected as described in "[Connecting the Projector](#)."
- Ensure that the pins of the connectors are not bent or broken.
- Ensure that the lamp is securely installed (see "[Changing the Lamp](#)").
- Run "Self-diagnostic test" (see "[Self-diagnostic for video](#)") for preliminary diagnostic on projection problem for video. Ensure that the colors of the test pattern are correct.

Partial, scrolling, or incorrectly displayed image

- Press the **Resync** button on the [remote control](#) or the [control panel](#).
- If you are using a Dell portable computer (for other computers consult your owner's manual):
 1. Set the resolution of the computer to SVGA (800 x 600):
 - 1a) Right click on the unused portion of your Windows desktop-» Properties-» Settings tab.
 - 1b) Verify the "Screen area" slide bar is set to 800 x 600 pixels.
 2. Press  .

- If you experience difficulty in changing resolutions or your monitor freezes, restart all the equipment and the projector.

The screen does not display your presentation



- If you are using a portable computer, press  .

Image is unstable or flickering

- Adjust the tracking in the OSD **Computer Image** tab.

Image has vertical flickering bar

- Adjust the frequency in the OSD **Computer Image** tab.

Image color is not correct

- If your graphic card output signal is "sync on Green", and you would like to display VGA at 60Hz signal, please go into "OSD--> Management --> Signal Type" and select "RGB".
- Run "Self-diagnostic test" (see " [Self-diagnostic for video](#) ") for preliminary diagnostic on image color problem. Ensure that the colors of the test pattern are correct.

Image is out of focus

- Adjust the focus ring on the projector lens.
- Ensure that the projection screen is within the required distance from the projector (3.9ft [1.2m] to 39.4ft [12m]).

The image is stretched when displaying 16:9 DVD

The projector automatically detects 16:9 DVD and adjusts the aspect ratio to full screen with a 4:3 (letter-box) default setting.

If the image is still stretched, adjust the aspect ratio as follows:

- If you are playing a 16:9 DVD, select 4:3 aspect ratio type on your DVD player if capable.
- If you cannot select 4:3 aspect ratio type on your DVD player, select 4:3 aspect ratio in the "All Images" menu within the OSD function.

Image is reversed

- Select [Management](#) from the OSD and adjust the projection mode.

Lamp is burned out or makes a popping sound

- When the lamp reaches its end of life, it may burn out and may make a loud popping sound. If this occurs, the projector will not turn back on until the lamp is replaced. To replace the lamp, see "[Changing the Lamp](#)".

Self-diagnostic for video

- Dell 2200MP projector provides self-diagnostic test of the projector video display (for

Video, S-video, Component-I). Use this advanced feature for preliminary self-diagnostic on your projector when encountering the display problem for video.

- After turning on the projector, press "+" and "-" buttons on the control panel simultaneously and release the buttons when screen goes blank.
- Contact Dell if the projector doesn't enter diagnostic mode or if the colors are incorrectly displayed.
- Press "+" and "-" buttons again to exit the diagnostic mode.
- While in Self-diagnostic mode, the screen will run a seven-color-cycle test as following: "Red--> Green--> Blue--> White--> Watchet Blue--> Dark Green--> Yellow." Ensure that the colors of the test pattern are correct.

Noise made when turning projector upside down

- This is normal. This feature inside the projector allows for proper cooling in ceiling mount applications.

[Back to Contents Page](#)

Specifications: Dell™ 2200MP Projector

Light Valve	single-chip DLP™ technology
Contrast Ratio	1700:1 Typical (Full On/Full Off)
Lamp	200-watt, user-replaceable lamp
Number of Pixels	800 x 600
Displayable Color	16.7M colors
Color Wheel Speed	120Hz(2X)
Projection Lens	F/2.4~2.7, f=19.7~23.6mm with 1.2x manual zoom lens
Projection Screen Size	27.9-337.5 inches (diagonal)
Projection Distance	3.9~39.4 ft (1.2m~12m)
Video Compatibility	NTSC, NTSC 4.43, PAL, PAL-M, PAL-N, SECAM, and HDTV (1080i, 720P, 576i/P, 480i/P) compatibility
	Composite video and S-video capability
H. Frequency	15kHz~70kHz horizontal scan
V. Frequency	43Hz~85Hz vertical refresh
Power Supply	universal 100~240V AC 50~60 Hz
Power Consumption	250 watts full power operation
I/O Connectors	

power: AC power input socket

computer input: D-sub 15-pin for analog/ component, HDTV input signal

computer output: one 15-pin D-sub

video input: one composite video RCA and one S-video

USB input: one USB connector

audio input: one phone jack

Weight	4.7 lbs (2.14 kgs)
Dimensions (W x H x D)	External 10.47 x 8.5 x 3.35 ± 0.04 inches (266 x 216 x 85 ± 1mm)
Environmental	operating temperature: 5°C~35°C (41°F~95°F) humidity: 80% maximum
	storage temperature: -20°C to 60°C (-4°F to 140°F) humidity: 80% maximum
Regulatory	FCC, CE, VCCI, UL, cUL, TÜV GS, ICES-003, MIC, C-Tick, GOST, PCBC, CCC, PSB, ECU, TÜV-S, NOM

Compatibility Modes

Mode	Resolution	(ANALOG)	
		V. Frequency (Hz)	H. Frequency (KHz)
VGA	640X350	70	31.5
VGA	640X350	85	37.9

VGA	640X400	85	37.9
VGA	640X480	60	31.5
VGA	640X480	72	37.9
VGA	640X480	75	37.5
VGA	640X480	85	43.3
VGA	720X400	70	31.5
VGA	720X400	85	37.9
SVGA	800X600	56	35.2
SVGA	800X600	60	37.9
SVGA	800X600	72	48.1
SVGA	800X600	75	46.9
SVGA	800X600	85	53.7
*XGA	1024X768	43.4	35.5
*XGA	1024X768	60	48.4
*XGA	1024X768	70	56.5
*XGA	1024X768	75	60.0
*XGA	1024X768	85	68.7
*SXGA	1280X1024	60	63.98
*SXGA+	1400X1050	60	63.98
MAC II 13	640X480	66.68	35
*MAC 16	832X624	74.55	49.725
*MAC 19	1024X768	75	60.24
*MAC	1152X870	75.06	68.68
MAC G4	640X480	60	31.35
*IMAC DV	1024X768	75	60
* Compression computer image.			

[Back to Contents Page](#)

Regulatory Notices: Dell™ 2200MP Projector

- [Federal Communications Commission \(FCC\) Notice \(U.S. Only\)](#)
 - [FCC Declaration of Conformity](#)
 - [CE Declaration of Conformity for a Class B Digital Device](#)
 - [Canadian Regulatory Information \(Canada Only\)](#)
 - [EN 55022 Compliance \(Czech Republic Only\)](#)
 - [VCCI Class 2 Notice \(Japan Only\)](#)
 - [MIC Notice \(South Korea Only\)](#)
 - [Polish Center for Testing and Certification Notice](#)
 - [NOM Information \(Mexico Only\)](#)
 - [Regulatory Listing](#)
-

Federal Communications Commission (FCC) Notice (U.S. Only)

 **NOTICE:** This equipment has been tested and found to comply with the limits for a Class B digital device, pursuant to Part 15 of the FCC Rules. These limits are designed to provide reasonable protection against harmful interference in a residential installation. This equipment generates, uses, and can radiate radio frequency energy and, if not installed and used in accordance with the instructions, may cause harmful interference to radio communications. However, there is no guarantee that interference will not occur in a particular installation. If this equipment does cause harmful interference to radio or television reception, which can be determined by turning the equipment off and on, the user is encouraged to try to correct the interference by one or more of the following measures:

- Reorient or relocate receiving antenna.
- Increase the separation between the equipment and receiver.
- Connect the equipment into an outlet on a circuit different from that to which the receiver is connected.
- Consult the dealer or an experienced radio/TV technician for help.

This device complies with Part 15 of the FCC rules. Operation is subject to the following two conditions:

- This device may not cause harmful interference.
- This device must accept any interference received including interference that may cause undesired operation.

Instructions to Users: This equipment complies with the requirements of FCC (Federal Communication Commission) equipment provided that the following conditions are met.

1. Power cable: Shielded power cable must be used.
2. Video inputs: The input signal amplitude must not exceed the specified level.

 **NOTICE:** Changes or modifications not expressly approved by the party responsible for compliance could void the user's authority to operate the equipment.

FCC Declaration of Conformity

According to 47 CFR, Part 15 of the FCC Rules

* **For the following named product:**

DLP Projector

2200MP/DELL CHC7229

* **Manufactured at:**

Coretronic Corporation

We hereby declare that this device complies with Part 15 of the FCC Rules. Operation is subject to the following two conditions:

1. This device may not cause harmful interference, and
2. This device must accept any interference received, including interference that may cause undesired operation.

* **FCC Rules:** Tested to comply with FCC part 15, class B

* **Test site at:** Advance Data Technology Corporation
No.81-1, Lu Liao Keng, 9 Ling, Wu Lung Tsung, Chiung Lin Hsiang, Hsin Chu Hsien, Taiwan

* **Responsible Party for Product Compliance:** Coretronic Corporation
No 11, Li Hsing Rd, Science-Based Industrial Park, Hsinchu, Taiwan
Tel: 886-3-5772000 Fax: 886-3-5790066

* **Manufacturer Information:** Coretronic Corporation RD Center
No 11, Li Hsing Rd, Science-Based Industrial Park, Hsinchu, 300, Taiwan Technology Engineering Associate Vice President
October 01, 2003

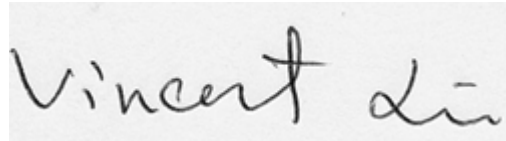

Hsinchu, October 01, 2003

Mr. Vincent Lin

CE Declaration of Conformity for a Class B Digital Device

Directives to which conformity is declared:

EMC Directives 89/336/EEC and Amending Directive 92/31/EEC

And

Low Voltage Directive 73/23/EEC

Standards to which conformity is declared

EN55022: 1998; EN55024: 1998; EN60950: 2000;

EN61000-3-2: 1995; EN61000-3-3: 1995

Manufacturer's Name: Coretronic Corporation

Manufacturer's Address: No 11, Li Hsing Rd, Science-Based Industrial Park, Hsinchu, Taiwan

Importer's Address: Dell Products Europe BV
Raheen Industrial Estate, Limerick, Ireland

Type of Equipment: DLP Projector

Model Number(s): 2200MP

Reference Report Number:

Previously Declared Models:

I, the undersigned, hereby declare that the equipment specified above conforms to the above Directive(s) and standards.

Hsinchu, Taiwan

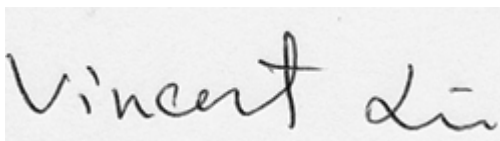

October 01, 2003

Mr. Vincent Lin

Head of RD Center

Canadian Regulatory Information (Canada Only)

This digital apparatus does not exceed the Class B limits for radio noise emissions from digital apparatus set out in the Radio Interference Regulations of the Canadian Department of Communications.

Note that Industry Canada regulations provided, that changes or modifications not expressly approved by Dell Inc. could void your authority to operate this equipment.

This Class B digital apparatus meets all requirements of the Canadian Interference-Causing Equipment Regulations.

Cet appareil numérique de la classe B respecte toutes les exigences du Règlement sur le matériel brouilleur du Canada.

EN 55022 Compliance (Czech Republic Only)

This device belongs to Class B devices as described in EN 55022, unless it is specifically stated that it is a Class A device on the specification label. The following applies to devices in Class A of EN 55022 (radius of protection up to 30 meters). The user of the device is obliged to take all steps necessary to remove sources of interference to telecommunication or other devices.

Pokud není na typovém štítku počítače uvedeno, že spadá do třídy A podle EN 55022, spadá automaticky do třídy B podle EN 55022. Pro zařízení zařazená do třídy A (ochranné pásmo 30m) podle EN 55022 platí následující. Dojde-li k rušení telekomunikačních nebo jiných zařízení, je uživatel povinen provést taková opatření, aby rušení odstranil.

VCCI Class 2 Notice (Japan Only)

This equipment complies with the limits for a Class 2 digital device (devices used in or adjacent to a residential environment) and conforms to the standards for information technology equipment that are set by the Voluntary Control Council for Interference for preventing radio frequency interference in residential areas.



Class B ITE

この装置は、情報処理装置等電波障害自主規制協議会 (VCCI) の基準に基づくクラス B 情報技術装置です。この装置は家庭環境で使用することを目的としていますが、ラジオやテレビジョン受信機に近接して使用されると、受信障害を引き起こすことがあります。取扱説明書に従って正しい取り扱いをしてください。

MIC Notice (South Korea Only)

B Class Device



명 칭 / 모 델 명 : Projector / 2200MP
인 증 번 호 :
인증받은자의상호 : 델컴퓨터(주)
제 조 년 월 일 : 2003
제 조 자 / 제 조 국 : Coretronic Corporation / 대만

기종별	사용자 안내문
B급 기기 (가정용 정보통신기기)	이 기기는 가정용으로 전자파적합등록을 한 기기로서 주거지역에서는 물론 모든 지역에서 사용할 수 있습니다.

Please note that this device has been approved for non-business purposes and may be used in any environment, including residential areas.

Polish Center for Testing and Certification Notice

The equipment should draw power from a socket with an attached protection circuit (a three-prong socket). All equipment that works together (computer, monitor, printer, and so on) should have the same power supply source.

The phasing conductor of the room's electrical installation should have a reserve short-circuit protection device in the form of a fuse with a nominal value no larger than 16 amperes (A).

To completely switch off the equipment, the power supply cable must be removed from the power supply socket, which should be located near the equipment and easily accessible.

A protection mark "B" confirms that the equipment is in compliance with the protection usage requirements of standards PN-93/T-42107 and PN-89/E-06251.

Wymagania Polskiego Centrum Badań i Certyfikacji

Urządzenie powinno być zasilane z gniazda z przyłączonym obwodem ochronnym (gniazdo z kołkiem). Współpracujące ze sobą urządzenia (komputer, monitor, drukarka) powinny być zasilane z tego samego źródła.

Instalacja elektryczna pomieszczenia powinna zawierać w przewodzie fazowym rezerwową ochronę przed zwarciami, w postaci bezpiecznika o wartości znamionowej nie większej niż 16A (amperów).

W celu całkowitego wyłączenia urządzenia z sieci zasilania, należy wyjąć wtyczkę kabla zasilającego z gniazdka, które powinno znajdować się w pobliżu urządzenia i być łatwo dostępne.

Znak bezpieczeństwa "B" potwierdza zgodność urządzenia z wymaganiami bezpieczeństwa użytkowania zawartymi w PN-93/T-42107 i PN-EN 55022:1996.

Jeżeli na tabliczce znamionowej umieszczono informację, że urządzenie jest klasy A, to oznacza to, że urządzenie w środowisku mieszkalnym może powodować zakłócenia radioelektryczne. W takich przypadkach można żądać od jego użytkownika zastosowania odpowiednich środków zaradczych.

Pozostałe instrukcje bezpieczeństwa

- Nie należy używać wtyczek adapterowych lub usuwać kołka obwodu ochronnego z wtyczki. Jeżeli konieczne jest użycie przedłużacza to należy użyć przedłużacza 3-żyłowego z prawidłowo połączonym przewodem ochronnym.
- System komputerowy należy zabezpieczyć przed nagłymi, chwilowymi wzrostami lub spadkami napięcia, używając eliminatora przepięć, urządzenia dopasowującego lub bezzakłócenowego źródła zasilania.
- Należy upewnić się, aby nic nie leżało na kablach systemu komputerowego, oraz aby kable nie były umieszczone w miejscu, gdzie można byłoby na nie nadeptywać lub potykać się o nie.
- Nie należy rozlewać napojów ani innych płynów na system komputerowy.
- Nie należy wpychać żadnych przedmiotów do otworów systemu komputerowego, gdyż może to spowodować pożar lub porażenie prądem, poprzez zwarcie elementów wewnętrznych.
- System komputerowy powinien znajdować się z dala od grzejników i źródeł ciepła. Ponadto, nie należy blokować otworów wentylacyjnych. Należy unikać kładzenia luźnych papierów pod komputer oraz umieszczania komputera w ciasnym miejscu bez możliwości cyrkulacji powietrza wokół niego.

NOM Information (Mexico Only)

The following information is provided on the device(s) described in this document in compliance with the requirements of the official Mexican standards (NOM)

Exporter:	Dell Inc. One Dell Way Round Rock, TX 78682
Importer:	Dell Computer de México, Paseo de la Reforma 2620, 11th Floor Col. Lomas Altas México DF CP 11950
Ship to:	Dell Computer de Mexico, S.A. de C.V. al Cuidado de Kuehne & Nagel de México S. de R.L., Avenida Soles No. 55 Col. Peñon de los Baños, 15520 Mexico, D.F.
Supply voltage:	> 100–240 VAC
Frequency:	50–60 Hz
Current consumption:	2.7 A

Regulatory Listing

Safety Certifications:

- UL 60950
- cUL
- NOM
- CE Mark--EN60950: 2000
- EZU
- IEC 60950:1999
- TÜV GS
- PCBC
- GOST
- CCC
- PSB
- TÜV-S

EMC Certifications:

- FCC Part 15 Class B
 - CE Mark--EN55022:1998 Class B, EN61003-3:1995, EN55024:1998, EN61000-3-2:1995, EN61000-3-3:1995
 - ICES-003
 - EZU
 - PCBC
 - C-Tick
 - VCCI Class B ITE
 - MIC
-

[Back to Contents Page](#)

Contacting Dell

To contact Dell electronically, you can access the following websites:

- www.dell.com
- support.dell.com (technical support)
- premiersupport.dell.com (technical support for educational, government, healthcare, and medium/large business customers, including Premier, Platinum, and Gold customers)

For specific web address for your country, find the appropriate country section in the table below.

NOTE: Toll-free numbers are for use within the country for which they are listed.

When you need to contact Dell, use the electronic addresses, telephone numbers, and codes provided in the following table. If you need assistance in determining which codes to use, contact a local or an international operator.

Country (City) International Access Code Country Code City Code	Department Name or Service Area, Website and E-mail Address	Area Code	Local Numbers, and Toll-Free Numbers
Anguilla	General Support		toll free:800-335-0031
Antigua and Barbuda	General Support		1-800-805-5924
Argentina (Buenos Aires) International Access Code:00 Country Code:54 City Code:11	Technical Support and Customer Care		toll free: 0800 444 0733
	Sales		toll free: 0810 444 3355
	Tech Support Fax	11	4515-7139
	Customer Care Fax	11	4515-7138
	Website: www.dell.com.ar		
Aruba	General Support		toll-free:800-1578
Australia (Sydney) International Access	E-mail (Australia): au_tech_support@dell.com		
	E-mail (New Zealand): nz_tech_support@dell.com		

Code:0011	Home and Small Business		1-300-65-55-33
Country Code:61	Government and Business		toll free: 1-800-633-559
City Code:2	Preferred Accounts Division (PAD)		toll free: 1-800-060-889
	Customer Care		toll free: 1-800-819-339
	Corporate Sales		toll free: 1-800-808-385
	Transaction Sales		toll free: 1-800-808-312
	Fax		toll free: 1-800-818-341
Austria (Vienna) International Access Code:900 Country Code:43 City Code:1	Switchboard	01	491 040
	Home/Small Business Sales	01	795676-02
	Home/Small Business Fax	01	795676-05
	Home/Small Business Customer Care	01	795676-03
	Preferred Accounts/Corporate Customer Care		0660-8056
	Home/Small Business Technical Support	01	795676-04
	Preferred Accounts/Corporate Technical Support		0660-8779
	Website: support.euro.dell.com		
	E-mail: tech_support_central_europe@dell.com		
Bahamas	General Support		toll-free:1-866-278-6818
Barbados	General Support		1-800-534-3142
Belgium (Brussels) International Access Code:00 Country Code:32 City Code:2	Technical Support	02	481 92 88
	Customer Care	02	481 91 19
	Home/Small Business Sales		toll free: 0800 16884
	Corporate Sales	02	481 91 00
	Fax	02	481 92 99
	Switchboard	02	481 91 00

	Website: support.euro.dell.com		
	E-mail: tech_be@dell.com		
	E-mail for French Speaking Customers: support.euro.dell.com/be/fr/emaildell/		
Bermuda	General Support		1-800-890-0748
Bolivia	General Support		toll free: 800-10-0238
Brazil			toll free: 0800 903355
International Access Code:00	Customer Support, Technical Support		
Country Code:55	Technical Support Fax	51	481-5470
City Code:51	Customer Care Fax	51	481-5480
	Sales		toll free: 0800 903390
	Website: www.dell.com/br		
British Virgin Islands	General Support		toll-free:1-866-278-6820
Brunei	Customer Technical Support (Penang, Malaysia)	604	633 4966
Country Code:673	Customer Service (Penang, Malaysia)	604	633 4949
	Transaction Sales (Penang, Malaysia)	604	633 4955
Canada (North York, Ontario)	Automated Order-Status System		toll free: 1-800-433-9014
International Access Code:011	AutoTech (Automated technical support)		toll free: 1-800-247-9362
	Customer Care Home & Home Office & Small Business		1-800-847-4096
	Customer Care Medium, Large, Commercial, Government (100+ Employees)		1-800-326-9463
	Technical Support Home & Home Office & Small Business		1-800-847-4096
	Technical Support Medium, Large, Commercial, Government (100+ Employees)		1-800-387-5757

	Sales (direct-from outside Toronto)		1-800-387-5752
	Sales (direct-from within Toronto)		416-758-2200
	Sales (federal government, education, and medical)		1-800-567-7542
	TechFax		toll free: 1-800-950-1329
Cayman Islands	General Support		1-800-805-7541
Chile (Santiago) Country Code:56 City Code:2	Sales, Customer Support, and Technical Support		toll free: 1230-020-4823
China (Xiamen) Country Code:86 City Code:592	Tech Support website: support.ap.dell.com/china		
	Tech Support E-mail: cn_support@dell.com		
	Tech Support Fax		818-1350
	Projector Technical Support Phone		toll free: 800 858 2920
	Customer Experience		toll free: 800 858 2060
	Home and Small Business		toll free: 800 858 2222
	Preferred Accounts Division		toll free: 800 858 2062
	Large Corporate Accounts North		toll free: 800 858 2999
	Large Corporate Accounts North Government and Education		toll free: 800 858 2955
	Large Corporate Accounts East		toll free: 800 858 2020
	Large Corporate Accounts East Government and Education		toll free: 800 858 2669
	Large Corporate Accounts Queue Team		toll free: 800 858 2572

	Large Corporate Accounts South		toll free: 800 858 2355
	Large Corporate Accounts West		toll free: 800 858 2811
	Large Corporate Accounts GCP		toll free: 800 858 2055
	Large Corporate Account Key Accounts		toll-free:800-858- 2628
	Large Corporate Accounts Spare Parts		toll free: 800-858-- 2621
Colombia	General Support		980-9-15-3978
Costa Rica	General Support		0800-012-0435
Czech Republic (Prague) International Access Code:00 Country Code:420 City Code:2	Technical Support	02	22 83 27 27
	Customer Care	02	22 83 27 11
	Fax	02	22 83 27 14
	TechFax	02	22 83 27 28
	Switchboard	02	22 83 27 11
	Website: support.euro.dell.com		
	E-mail: czech_dell@dell.com		
Denmark (Horsholm) International Access Code:00 Country Code:45	Technical Support		70230182
	Customer Care(Relational)		70230184
	Home/Small Business Customer Care		32875505
	Switchboard (Relational)		32871200
	Fax Switchboard (Relational)		32871201
	Switchboard (Home/Small Business)		32875000
	Fax Switchboard (Home/Small Business)		32875001
	Website: support.euro.dell.com		
	E-mail Support (portable computers): den_nbk_support@dell.com		
	E-mail Support (desktop computers): den_support@dell.com		
E-mail Support (servers):			

	Nordic_server_support@dell.com		
Dominica	General Support		toll free: 1-866-278-6821
Dominican Republic	General Support		toll free: 1-800-156-1588
Ecuador	General Support		toll-free 999-119
El Salvador	General Support		01-889-753-0777
Finland (Helsinki) International Access Code:990 Country Code:358 City Code:9	Technical Support	09	253 313 60
	Technical Support Fax	09	253 313 81
	Relational Customer Care	09	253 313 38
	Home/Small Business Customer Care	09	693 791 94
	Fax	09	253 313 99
	Switchboard	09	253 313 00
	Website: support.euro.dell.com		
	E-mail: fin_support@dell.com		
France (Paris) (Montpellier) International Access Code:00 Country Code:33 City Code:(1)(4)	Home and Small Business		
	Technical Support	0825	387 270
	Customer Care	0825	823 833
	Switchboard	0825	004700
	Switchboard (calls from outside of France)	04	99 75 40 00
	Sales	0825	004 700
	Fax (calls from outside of France)	04	99 75 40 001
	Website: support.euro.dell.com		
	E-mail: support.euro.dell.com/fr/fr/emaildell/		
	Corporate		
	Technical Support	0825	004 719
	Customer Care	0825	338 339
	Fax	01	55 94 71 01
	Switchboard	01	55 94 71 00
Sales			

		01	55 94 71 00
Germany (Langen) International Access Code:00 Country Code:49	Technical Support	06103	766-7200
	Home/Small Business Customer Care		0180-5-224 400
	Global Segment Customer Care	06103	766-9570
	Preferred Accounts Customer Care	06103	766-9420
	Large Accounts Customer Care	06103	766-9560
	Public Accounts Customer Care	06103	766-9555
	Switchboard	06103	766-7000
	Website: support.euro.dell.com		
	E-mail: tech_support_central_europe@dell.com		
Grenada	General Support		toll free:1-866-540-3355
Guatemala	General Support		1-800-999-0136
Guyana	General Support		toll free:1-877-440-6511
Hong Kong International Access Code:001 Country Code:852	Technical Support(Dimension™ and Inspiron™)		296-93188
	Technical Support (OptiPlex™, Latitude™ , and Dell Precision™)		296-93191
	Customer Service (non-technical, post-sales issues)		800-93-8291
	Transaction Sales		toll free: 800 96 4109
	Large Corporate Accounts HK		toll free: 800 96 4108
	Large Corporate Accounts GCP HK		toll free: 800 90 3708
India	Technical Support		1600-33-8045
	Sales		1600-33-8044
Ireland (Cherrywood)	Ireland Technical Support	1850	543 543

International Access Code:16 Country Code:353	UK Technical Support (dial within UK only)	0870	908 0800
	Home User Customer Care	01	204 4095
	Small Business Customer Care	01	204 4444
	Corporate Customer Care	01	204 4003
	UK Customer Care (dial number within UK only)	0870	906 0010
	Ireland Sales	01	204 4444
	UK Sales (dial within UK only)	0870	907 4000
	SalesFax	01	204 0144
	Fax	01	204 5960
	Switchboard	01	204 4444
	Website: support.euro.dell.com		
	E-mail: dell_direct_support@dell.com		
	Italy (Milan) International Access Code:00 Country Code:39 City Code:2	Home and Small Business	
Technical Support		02	577 826 90
Customer Care		02	696 821 14
Fax		02	696 821 13
Switchboard		02	696 821 12
Website: support.euro.dell.com			
E-mail: support.euro.dell.com/it/it/emaildell/			
Corporate			
Technical Support		02	577 826 90
Customer Care		02	577 825 55
Fax		02	577 035 30
Switchboard		02	577 821
Website: support.euro.dell.com			
E-mail: support.euro.dell.com/it/it/emaildell/			
Jamaica		General Support (dial from within Jamaica only)	

Japan (Kawasaki) International Access Code:001 Country Code:81	Web site: support.jp.dell.com		
	Technical Support	44	toll free: 0120-981-690
	Technical Support Outside of Japan	44	556-3468
	Customer Care	44	556-4240
Korea (Seoul) International Access Code:001 Country Code:82 City Code:2	Technical Support		toll free: 080-200-3800
	Sales		toll free: 080-200-3600
	Customer Service (Penang, Malaysia)		toll free: 604-633-4949
	Customer Service (Seoul, Korea)		080-200-3800
	Fax		2194-6202
	Switchboard		2194-6000
Latin America	Customer Technical Support (Austin, Texas, U.S.A.)	512	728-4093
	Customer Service (Austin, Texas, U.S.A.)	512	728-3619
	Fax (Technical Support and Customer Service) (Austin, Texas, U.S.A.)	512	728-3883
	Sales (Austin, Texas, U.S.A.)	512	728-4397
	SalesFax (Austin, Texas, U.S.A.)	512	728-4600 or 728-3772
Luxembourg International Access Code:00 Country Code:352	Technical Support (Brussels, Belgium)	02	481 92 88
	Home/Small Business Sales (Brussels, Belgium)		toll free: 080016884
	Corporate Sales (Brussels, Belgium)	02	481 91 00
	Customer Care (Brussels, Belgium)	02	481 91 19
	Switchboard (Brussels, Belgium)	02	481 91 00
	Fax (Brussels, Belgium)	02	481 92 99
	Website: support.euro.dell.com		
	E-mail: tech_be@dell.com		
Macao Country Code:853	Technical Support		toll free: 0800 582
	Customer Service (Penang, Malaysia)		604 633 4949

	Transaction Sales		toll free: 0800 581
Malaysia (Penang) International Access Code:00 Country Code:60 City Code: 4	Technical Support		toll free: 1 800 888 298
	Customer Service	4	633 4949
	Transaction Sales		toll free: 1 800 888 202
	Corporate Sales		toll free: 1 800 888 213
Mexico International Access Code:00 Country Code:52	Customer Technical Support		001-877-384-8979 or 001-877-269-3383
	Sales		50-81-8800 or 01-800-888-3355
	Customer Service		001-877-384-8979 or 001-877-269-3383
	Main		50-81-8800 or 01-800-888-3355
Montserrat	General Support		toll free:1-866-278-6822
Netherlands Antilles	General Support		001-800-882-1519
Netherlands (Amsterdam) International Access Code:00 Country Code:31 City Code:20	Technical Support	20	674 4500
	Home/Small and Medium Business	20	674 5500
	Home/Small and Medium Business Fax	20	674 4775
	Home/Small and Medium Business Customer Care	20	674 4200
	Corporate	20	674 5000
	Corporate Fax	20	674 4779
	Corporate Customer Care	20	674 4325
	Website: support.euro.dell.com		
	E-mail: support.euro.dell.com/nl/nl/emaildell/		

New Zealand	E-mail (New Zealand): nz_tech_support@dell.com		
	E-mail (Australia): au_tech_support@dell.com		
	Home and Small Business		0800 446 255
	Government and Business		0800 444 617
	Sales		0800 441 567
	Fax		0800 441 566
Nicaragua	General Support		001-800-220-1006
Norway (Lysaker) International Access Code:00 Country Code:47	Technical Support		671 16882
	Relational Customer Care		671 17514
	Home/Small Business Customer Care		231 62298
	Switchboard		671 16800
	Fax Switchboard		671 16865
	Website: support.euro.dell.com		
	E-mail Support (portable computers): nor_nbk_support@dell.com		
	E-mail Support (desktop computers): nor_support@dell.com		
Panama	General Support		001-800-507-0962
Peru	General Support		0800-50-669
Poland (Warsaw) International Access Code:011 Country Code:48	Customer Service Phone	22	57 95 700
	Customer Care	22	57 95 999
	Sales	22	57 95 750
	Switchboard	22	57 95 999
	Customer Service Fax	22	57 95 806
	Reception Desk Fax	22	57 95 998
	Website: support.euro.dell.com		

	E-mail: pl_support_tech@dell.com		
Portugal International Access Code:00 Country Code:35	Technical Support	35	800 834 077
	Customer Care		800 300 415 or 800 834 075
	Sales		800 300 410 or 800 300 411 or 800 300 412 or 121 422 07 10
	Fax	35	121 424 01 12
	E-mail: support.euro.dell.com/es/es/emaildell/		
Puerto Rico	General Support		1-800-805-7545
St. Kitts and Nevis	General Support		toll free:1-877-441-4731
St. Lucia	General Support		1-800-882-1521
St. Vincent and the Grenadines	General Support		toll free:1-877-441-4740
Singapore (Singapore) International Access Code:005 Country Code:65	Technical Support		toll free: 800 6011 051
	Customer Service (Penang, Malaysia)	604	633 4949
	Transaction Sales		toll free: 800 6011 054
	Corporate Sales		toll free: 800 6011 053
South Africa (Johannesburg) International Access Code:09/091 Country Code:27 City Code:11	Technical Support	011	709 7710
	Customer Care	011	709 7707
	Sales	011	709 7700
	Fax	011	706 0495
	Switchboard	011	709 7700
	Website: support.euro.dell.com		
	E-mail: dell_za_support@dell.com		
Southeast Asian/Pacific Countries	Customer Technical Support, Customer Service, and Sales (Penang, Malaysia)	604	633-4810

Spain (Madrid) International Access Code:00 Country Code:34 City Code:91	Home and Small Business		
	Technical Support	91	902 100 130
	Customer Care	91	902 118 540
	Sales	91	902 118 541
	Switchboard	91	902 118 541
	Fax	91	902 118 539
	Website: support.euro.dell.com		
	E-mail: support.euro.dell.com/es/es/emaildell/		
	Corporate		
	Technical Support	91	902 100 130
	Customer Care	91	902 118 546
	Switchboard	91	722 92 00
	Fax	91	722 95 83
	Website: support.euro.dell.com		
	E-mail: support.euro.dell.com/es/es/emaildell/		
Sweden (Upplands Vasby) International Access Code:00 Country Code:46 City Code:8	Technical Support	08	590 05 199
	Relational Customer Care	08	590 05 642
	Home/Small Business Customer Care	08	587 70 527
	Employee Purchase Program (EPP) Support		20 140 14 44
	Fax Technical Support	08	590 05 594
	Sales	08	590 05 185
	Website: support.euro.dell.com		
	E-mail: swe_support@dell.com		
	E-mail Support for Latitude and Inspiron: Swe-nbk_kats@dell.com		
	E-mail Support for OptiPlex: Swe_kats@dell.com		
	E-mail Support for Servers: nordic_server_support@dell.com		
Switzerland (Geneva) International Access Code:00	Technical Support (Home and Small Business)	22	0844 811 411
	Technical Support (Corporate)	22	0844 822 844
	Customer Care (Home and Small Business)	22	0848 802 202

Country Code:41	Customer Care(Corporate)		0848 821 721
City Code:22	Switchboard	22	799 01 01
	Fax	22	799 01 90
	Website: support.euro.dell.com		
	E-mail:swisstech@dell.com		
	E-mail for French-speaking HSB and Corporate Customers: support.euro.dell.com/ch/fr/emaildell/		
Taiwan International Access Code:002 Country Code:886	Technical Support (portable and desktop computers)		toll free: 00801 86 1011
	Technical Support (Servers)		toll free: 0080 60 1256
	Transaction Sales		toll free:0800 651 228 or 0800 33 556
	Corporate Sales		toll free: 0080 651 227/ 0800 33 555
Thailand International Access Code:001 Country Code:66	Technical Support		toll free: 088 006 007
	Customer Service (Penang, Malaysia)	604	633 4949
	Sales		toll free: 088 006 009
Trinidad and Tobago	General Support		1-800-805-8035
Turks and Caicos Islands	General Support		toll free:1-866-540- 3355
U.K. (Bracknell) International Access Code:44 Country Code:44	Technical Support (Corporate/Preferred Accounts/PAD [1000+ employees])	0870	908 0500
	Technical Support (Direct/PAD and general)	0870	908 0800
	Global Accounts Customer Care	01344	373 185 or 373 186
	Corporate Customer Care	0870	908 0500
	Preferred Accounts (500-5000 employees)	01344	373 196

	Customer Care		
	Central Government Customer Care	01344	373 193
	Local Government & Education Customer Care	01344	373 199
	Health Customer Care	01344	373 194
	Home/Small Business Sales	0870	907 4000
	Home/Small Business Customer Care	0870	906 0010
	Corporate/Public Sector Sales	01344	860 456
	Website: support.euro.dell.com		
	Customer Care website: dell.co.uk/lca/customerservices		
	E-mail: dell_direct_support@dell.com		
Uruguay	General Support		toll free:000-413-598-2521
U.S.A. (Austin, Texas)	Automated Order-Status System		toll free: 1-800-433-9014
International Access Code:011	AutoTech (portable and desktop computers)		toll free: 1-800-247-9362
Country Code:1	Projectors Technical Support		toll free: 1-877-459-7298
	Customer Service		toll free: 1-800-624-9897
	Dell Sales		toll free: 1-800-289-3355 or toll free: 1-800-879-3355
	Dell Outlet Store (Dell refurbished computers)		toll free: 1-888-798-7561
	Software and Peripherals Sales		toll free: 1-800-671-3355
	Spare Parts Sales		toll free: 1-800-357-3355
	Extended Service and Warranty Sales		toll free: 1-800-247-4618
	Fax		toll free: 1-800-727-8320

	Dell Services for the Deaf, Hard-of-Hearing, or Speech-Impaired		toll free: 1-877-DELLTTY (1-877-335-5889)
U.S. Virgin Islands	General Support		1-877-673-3355
Venezuela	General Support		8001-3605

[Back to Contents Page](#)

Free Manuals Download Website

<http://myh66.com>

<http://usermanuals.us>

<http://www.somanuals.com>

<http://www.4manuals.cc>

<http://www.manual-lib.com>

<http://www.404manual.com>

<http://www.luxmanual.com>

<http://aubethermostatmanual.com>

Golf course search by state

<http://golfingnear.com>

Email search by domain

<http://emailbydomain.com>

Auto manuals search

<http://auto.somanuals.com>

TV manuals search

<http://tv.somanuals.com>