



# Dell™ Latitude™ XT2 XFR

## Service Manual



## Notes, Notices, and Cautions

 **NOTE:** A NOTE indicates important information that helps you make better use of your computer.

 **CAUTION:** A CAUTION indicates either potential damage to hardware or loss of data and tells you how to avoid the problem.

 **WARNING:** A WARNING indicates a potential for property damage, personal injury, or death.

Information in this document is subject to change without notice. Some of the information contained in this document may not apply to all Dell systems.

© 2009 Dell Inc. All rights reserved.

Reproduction in any manner whatsoever without the written permission of Dell Inc. is strictly forbidden

Trademarks used in this text: *Dell*, the *DELL* logo, *Latitude*, *TravelLite*, *Wi-Fi Catcher*, and *ExpressCharge*, are trademarks of Dell Inc.; *Intel*, *Pentium*, *Celeron* and *Core* are registered trademarks of Intel Corporation; *Bluetooth* is a registered trademark owned by Bluetooth SIG, Inc. and is used by Dell under license; *TouchStrip* is a trademark of Zvetco Biometrics, LLC; *Blu-ray Disc* is a trademark of the Blu-ray Disc Association; *Microsoft*, *Windows*, *Windows Server*, *MS-DOS*, *Aero*, *Windows Vista*, and the *Windows Vista* start button are either trademarks or registered trademarks of Microsoft Corporation in the United States and/or other countries.

Other trademarks and trade names may be used in this document to refer to either the entities claiming the marks and names or their products. Dell Inc. disclaims any proprietary interest in trademarks and trade names other than its own.

Model P05S

nnnnn 2009 Rev. A00

## Table of Contents

<b>1</b>	<b>XT2 XFR FEATURES .....</b>	<b>6</b>
1.1	XT2 XFR USER MODES .....	6
1.1.1	<i>Notebook Mode</i> .....	6
1.1.2	<i>Tablet Mode</i> .....	7
1.2	XT2 XFR BUTTONS .....	8
1.2.1	<i>Tablet Buttons</i> .....	8
1.2.2	<i>Scroll Buttons</i> .....	8
1.3	XT2 XFR INTERFACE.....	9
1.3.1	<i>Windows Vista/XP XT2 XFR Interface Comparison</i> .....	9
1.3.2	<i>Windows Vista</i> .....	9
1.3.3	<i>Windows XP</i> .....	12
1.4	XT2 XFR SETTINGS .....	13
1.4.1	<i>Installation</i> .....	13
1.4.2	<i>Windows™ XP vs. Windows Vista™</i> .....	14
1.4.3	<i>N-trig Applet</i> .....	14
1.5	XT2 XFR PEN .....	20
1.5.1	<i>Calibrating the Pen</i> .....	20
1.5.2	<i>Troubleshooting</i> .....	21
1.6	APPLICATION MATRIX .....	22
<b>2</b>	<b>WORKING ON YOUR XT2 XFR.....</b>	<b>22</b>
2.1	BEFORE WORKING INSIDE YOUR XT2 XFR.....	23
2.2	RECOMMENDED TOOLS .....	24
2.3	TURNING OFF YOUR XT2 XFR.....	24
2.4	AFTER WORKING INSIDE YOUR XT2 XFR .....	24
<b>3</b>	<b>SCREW CHART.....</b>	<b>25</b>
<b>4</b>	<b>ADDING AND REPLACING PARTS.....</b>	<b>27</b>
4.1	MAIN BATTERY.....	27
4.1.1	<i>Removing the Main Battery</i> .....	28
4.1.2	<i>Removing the Battery from the Battery Door</i> .....	28
4.1.3	<i>Installing the Battery into the Battery Door</i> .....	29
4.2	HINGE COVER.....	30
4.2.1	<i>Removing the Hinge Cover</i> .....	30
4.3	KEYBOARD.....	31
4.3.1	<i>Removing the Keyboard</i> .....	31
4.4	MEMORY AND MINI-CARD COVER.....	34
4.4.1	<i>Removing the Memory and Mini-Card Cover</i> .....	34
4.5	MEMORY .....	36
4.5.1	<i>Removing a Memory Module</i> .....	36
4.6	HARD DRIVE .....	37
4.6.1	<i>Removing the Hard Drive</i> .....	37
4.7	MINI-CARD .....	38
4.7.1	<i>Removing the Mini-Card</i> .....	39
4.8	INTERNAL CARD WITH BLUETOOTH® WIRELESS TECHNOLOGY.....	41
4.8.1	<i>Removing the Internal Card With Bluetooth Wireless Technology</i> .....	41
4.9	PALM REST.....	43
4.9.1	<i>Removing the Palm Rest</i> .....	43
4.9.2	<i>Installing the Palm Rest</i> .....	45

4.10	COIN-CELL BATTERY .....	48
4.10.1	Removing the Coin-Cell Battery.....	48
4.10.2	Installing the Coin-Cell Battery.....	49
4.11	USB INTERFACE BOARD .....	49
4.11.1	Removing the USB Interface Board.....	49
4.12	STYLUS BAY.....	50
4.12.1	Removing the Stylus Bay.....	50
4.12.2	Installing the Stylus Bay.....	51
4.13	SPEAKER .....	51
4.13.1	Removing the Speaker.....	52
4.14	WiFi SNIFFER ASSEMBLY .....	53
4.14.1	WiFi Sniffer Assembly Removal.....	53
4.14.2	Wifi Sniffer Assembly Installation.....	53
4.15	SNIFFER BUTTON AND WiFi SWITCH .....	54
4.15.1	Installing the Wifi sniffer button.....	54
4.15.2	Installing the Wifi on/off switch.....	54
4.16	SYSTEM BOARD.....	56
4.16.1	Removing the System Board.....	56
4.16.2	Installing the System Board.....	58
4.17	HEAT SINK AND FAN ASSEMBLY .....	59
4.17.1	Removing the Heat Sink and Fan Assembly.....	59
4.18	DISPLAY ASSEMBLY .....	61
4.18.1	Removing the Display Assembly.....	62
4.18.2	Installing the Display Assembly.....	63
4.19	RF PASSTHRU .....	66
4.19.1	Removing the RF Passthru Board.....	66
4.19.2	Installing the RF Passthru Board.....	66
4.20	ROCKER SWITCH.....	67
4.20.1	Remove the Rocker Switch.....	67
4.20.2	Install the Rocker Switch.....	67
4.21	DOORS .....	68
4.21.1	Removing the USB/1394 Door.....	68
4.21.2	Removing the VGA/RJ45/USB Door.....	68
4.21.3	Removing the Power Door.....	69
4.21.4	Removing the Audio/Card Socket Door.....	69
4.22	USB MODULE BAY COVER.....	69
4.22.1	Removing the USB Module Cover.....	70
4.23	GPS MODULE (OPTIONAL) .....	70
4.23.1	Removing the GPS Module.....	71
4.24	CAMERA MODULE (OPTIONAL) .....	72
4.24.1	Removing the Camera Module.....	72
<b>5</b>	<b>SPECIFICATIONS .....</b>	<b>73</b>
<b>6</b>	<b>DELL DIAGNOSTICS.....</b>	<b>74</b>
6.1.1	Error Messages.....	77
6.2	SOLVING PROBLEMS.....	78
6.2.1	Battery Problems.....	78
6.2.2	Drive Problems.....	78
6.2.3	IEEE 1394 Device Problems.....	80
6.2.4	Lockups and Software Problems.....	80
6.2.5	Memory Problems.....	81
6.2.6	Power Problems.....	82
6.2.7	Sound and Speaker Problems.....	82

6.2.8	<i>Video and Display Problems</i> .....	83
6.3	DELL TECHNICAL UPDATE SERVICE.....	83
6.4	DELL SUPPORT UTILITY .....	84
6.4.1	<i>Clicking the Dell Support Icon</i> .....	84
6.4.2	<i>Double-Clicking the Dell Support Icon</i> .....	84
6.5	GPS DEVICE .....	85
6.5.1	<i>GPS Hardware Configuration</i> .....	85
6.5.2	<i>Software Configuration</i> .....	87
6.5.3	<i>Diagnostics</i> .....	87
6.6	CAMERA.....	88
6.6.1	<i>Camera Configuration Verification</i> .....	88
6.6.2	<i>Diagnostics</i> .....	89
6.7	DEVICE STATUS LEDs.....	90
6.8	KEYBOARD STATUS LEDs .....	91
6.9	LED ERROR CODES .....	91
<b>7</b>	<b>SYSTEM BIOS</b> .....	<b>93</b>
7.1	BIOS SCREEN NAVIGATION KEYSTROKES .....	93
7.2	<F12> MENU.....	93
7.3	ENTERING SYSTEM SETUP .....	93

# 1 XT2 XFR Features

## 1.1 XT2 XFR User Modes

### 1.1.1 Notebook Mode

Your XT2 XFR can be used either in notebook mode or tablet mode. To use your XT2 XFR in notebook mode, open the display until it reaches a comfortable viewing angle as in the image to the above, and use the keyboard and display as you would those of any other notebook computer.



## 1.1.2 Tablet Mode

Your XT2 XFR converts from notebook mode to tablet mode with a 180-degree clockwise twist of the display's rotating hinge.

 **CAUTION:** Forcing the hinge beyond the 180-degree point will damage the XT2 XFR.

		
<p>Open the display of the XT2 XFR until it reaches a 90-degree angle, perpendicular to the base.</p>	<p>Brace the base with one hand on the palm rest, grasp the top of the display with the other hand, and turn the rotating hinge clockwise 180 degrees until you feel the display engage securely.</p>	<p>Lay the display assembly on the base with the display facing upwards. Press the latch down to secure the display.</p>

When you convert your XT2 XFR between notebook and tablet modes, the screen orientation of your XT2 XFR will automatically change according to the settings you have established in the Dell Control Point System Manager application or the Windows Vista Pen and Tablet settings application, most commonly from landscape (notebook mode) to portrait (tablet mode).

## 1.2 XT2 XFR Buttons

### 1.2.1 Tablet Buttons

Your XT2 XFR has three tablet buttons located beside the power button. In order for these buttons to function properly, **Dell Control Point System Manager** must be installed.

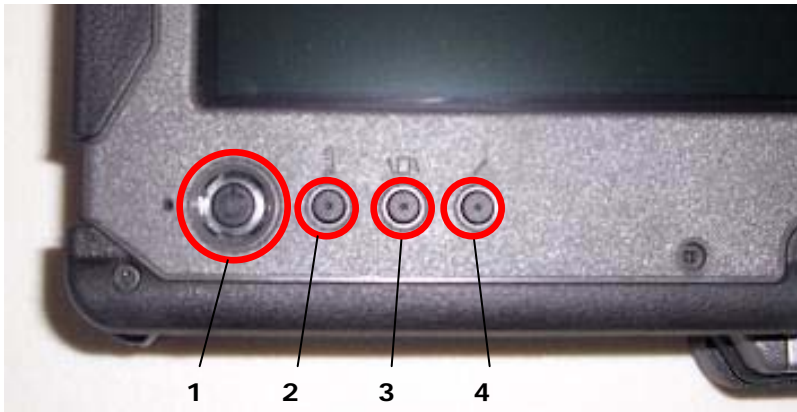

1	Power Button	3	Screen rotate button
2	Windows security button	4	Dell Control Point button

**Power button** — Used to power the system on and off.

**Windows Security button** — If you use your XT2 XFR in tablet mode, press this button to access the Windows Task Manager dialog box or a login screen, the same way you use the <Ctrl><Alt><Del> key sequence in notebook mode.

**Screen rotate button** — While the XT2 XFR is in tablet mode, use the screen rotate button to change the display orientation from portrait to landscape mode. Each time you press and release the screen rotate button, the screen image rotates clockwise 90 degrees.

**Dell Control Point tablet settings button** — Press this button to view and configure options for the XT2 XFR and the pen through Dell Control Point System Manager. You can configure this button to perform a different action using Windows Vista™ XT2 XFR Settings.

### 1.2.2 Scroll Buttons



1	Scroll control	2	Back button
---	----------------	---	-------------

#### 1.2.2.1 Using the Scroll Control

To scroll through a list of items or a set of pages one at a time, shift the scroll control up or down and release. The control automatically returns to the center/neutral position when released.

To rapidly scroll through a list of items or a set of pages, shift the control up or down and hold it, releasing it when you wish to stop scrolling.



To select objects, press and release the scroll control when it is in the center/neutral position.  
To launch context sensitive menus, press and hold the scroll control until a complete circle is drawn on the display then release. This is equivalent to clicking the right mouse button on a notebook computer.

Use the back button to move backwards in applications that support navigation, such as web browsers and Windows Explorer. It is also used to close the active window.

To move backward, press and release the back button.

To close the active window, press and hold the back button.

To customize the back button behavior, use the Tablet and Pen Settings in Windows Vista.

## 1.3 XT2 XFR Interface

### 1.3.1 Windows Vista/XP XT2 XFR Interface Comparison

Depending on the configuration you ordered, your XT2 XFR shipped with either the Windows Vista or Windows XP operating system. There are several differences in the Tablet PC-interfaces between the two. Listed below are the primary differences.

Tablet PC Interface Comparison Table			
Feature	Description	Vista	XP
<b>Touch</b>	Ability to use finger as an input device.	YES	YES
<b>Windows Journal</b>	Native note-taking application which takes input directly from pen or touch.	YES	YES
<b>Snipping Tool</b>	Tool used to capture portions of visual data (documents, pictures, etc.) via pen or touch. <small>*Available as a separate download from Microsoft.</small>	YES	YES*
<b>Flicks</b>	Gesture activated shortcuts for common tasks.	YES	NO
<b>Check Boxes</b>	Visual identifier in folders for selecting files.	YES	NO
<b>Cursor Feedback</b>	Visual indicator for tap location.	YES	NO
<b>Tablet Input Panel</b>	Tool used to input data via pen or touch that takes the place of a keyboard.	YES	YES
<b>Input device-sensitive tools</b>	Tablet Input Panel and icon change size according to pen or touch being used.	YES	NO
<b>Tablet Cursor</b>	Special Tablet cursor used for Tablet PC functions as opposed to a standard mouse pointer.	YES	NO
<b>Touch Widget</b>	Separate tool that appears in Touch Mode used for right-clicking purposes.	YES	NO
<b>Cursor Feedback</b>	Ability to see if the target has been hit by using visual feedback for success.	YES	NO
<b>Cursor Feedback</b>	Ability to see if the target has been hit by using visual feedback for success.	YES	NO



### 1.3.2 Windows Vista

#### 1.3.2.1 Pen Usage

##### Using the Pen as a Mouse

You can use the pen the same way you use a mouse or touch pad with a notebook computer. Holding the pen near the display makes a small cursor appear. Moving the pen moves the cursor.

The table below describes how to use the pen.

Electrostatic Pen Usage		
Appearance	Action	Function
	Gently tap the pen tip on the screen of your Tablet PC.	Same as a single-click on a mouse.
	Gently tap the pen tip twice in quick succession on the screen of your XT2 XFR.	Same as a double-click on a mouse.
	Touch the pen on the screen and hold it in place momentarily until Windows draws a complete circle around the cursor.	Same as a right-click on a mouse.

### Working With Files

You can open, delete, or move many files or folders at one time by selecting multiple items from a list. Using a tablet pen, hover over one item at a time and select the check box that appears to the left of each item.

To turn check boxes on:

1. Go to **Folder Options**.
2. Click on the **View** tab.
3. Under **Advanced settings**, select the **Use check boxes to select items** check box, and then click **OK**.

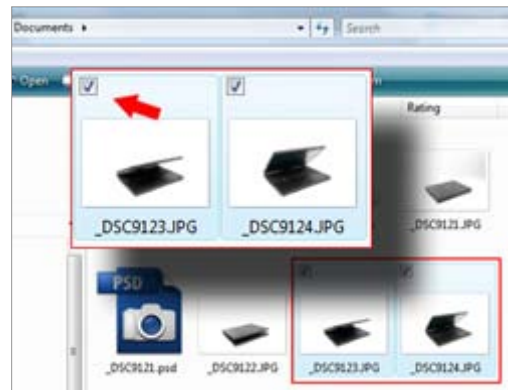

### Using the Pen as a Pen

The Windows Vista handwriting recognition software makes it easy to enter text into your applications with the pen. Some applications, such as Windows Journal, allow you to write with the pen directly into the application window.

### XT2 XFR Input Panel

When an application does not directly support pen input, you can use the **Tablet PC Input Panel** to enter text into your application. If you tap in an editable area, the Tablet PC Input Panel icon appears. Tapping the icon makes Input Panel slide out from the edge of the display.

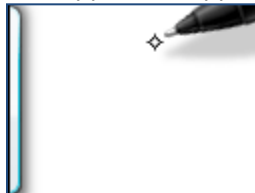



You can also open the Input Panel by tapping the Input Panel tab, which is docked at the edge of the screen when the Input Panel is hidden.

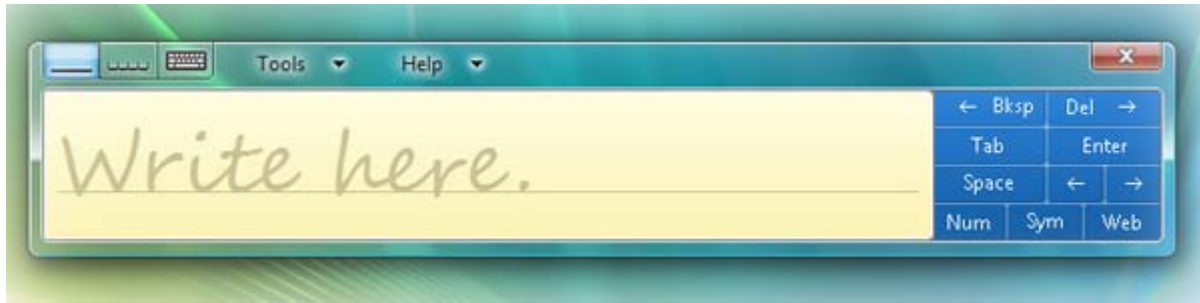

You can move the Input Panel tab by dragging it up or down along the edge of the screen. Then, when you tap it, the Input Panel opens at the same horizontal location on the screen that the tab appears.



You can use the writing pad, the character pad, or the on-screen keyboard to enter text. The writing pad and the character pad convert your handwriting into typed text. The on-screen keyboard works just like a standard keyboard except that you enter text by tapping keys with your tablet pen. The following table describes the different choices for using the Input Panel.

Input Panel Icons		
Icon	Name	Function
	<b>Writing Pad</b>	With the writing pad, you can write continuously as if you were writing on a lined piece of paper.
	<b>Character Pad</b>	The character pad converts your handwriting to typed text, one letter, number, or symbol at a time.
	<b>On-screen Keyboard</b>	The on-screen keyboard is similar to a standard keyboard.

The writing pad and character pad have a number pad, a symbol pad, and web quick keys to help you quickly and accurately enter these types of text. These quick keys are hidden when you start to write, but appear after you insert or delete your writing.

## Pen Flicks

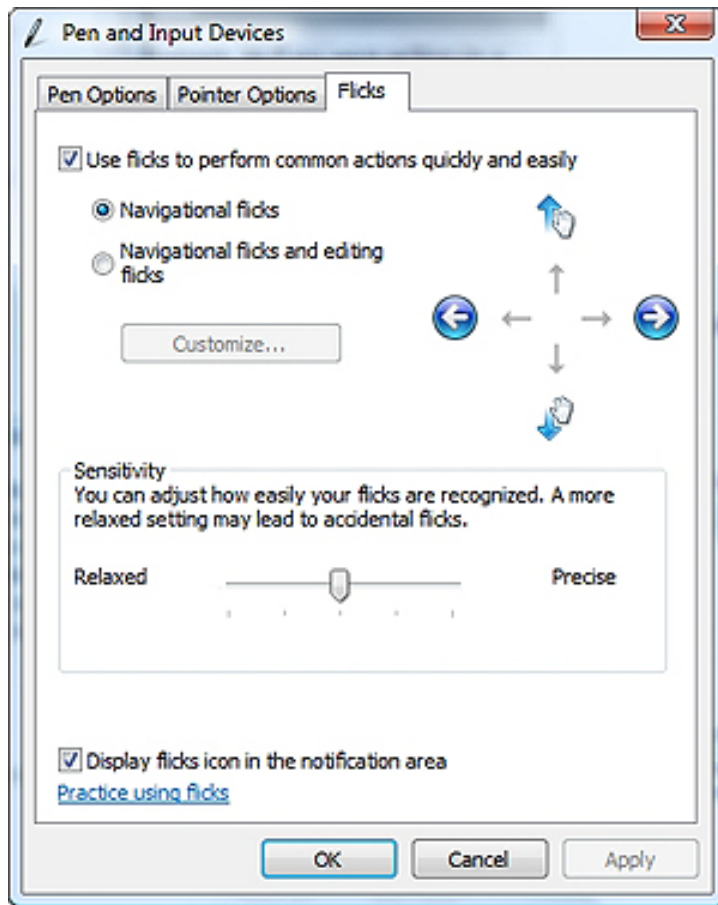

Pen flicks enable you to use the pen to perform actions that normally require a keyboard, such as pressing <Page Up> or using the directional arrow keys. Pen flicks are quick, directional gestures. You simply quickly draw a short line in one of eight directions. When a pen flick is recognized, the XT2 XFR performs the action assigned. The image below depicts the default pen flick settings. These can be customized by going to **Start→Control Panel→Pen and Input Devices** and clicking on the **Flicks** tab.

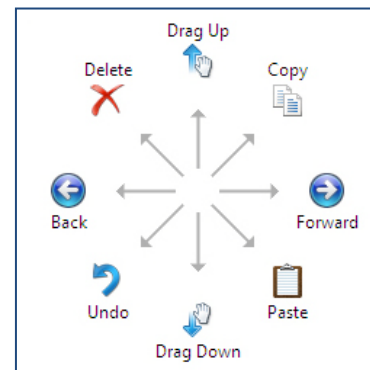

### 1.3.2.2 Touch Usage



One of the key advantages of the XT2 XFR is the ability to easily switch from pen input to touch input. When you use Touch Mode, a translucent image of a computer mouse, called the touch pointer, floats beneath your finger. The touch pointer has left and right mouse buttons that you can tap with your finger. You use the area beneath the buttons to drag the touch pointer.

## 1.3.3 Windows XP

### 1.3.3.1 Pen Usage

#### Using the Pen as a Mouse

You can use the pen the same way you use a mouse or touch pad with a notebook computer. Holding the pen near the display makes a small cursor appear. Moving the pen moves the cursor.



Tapping on the screen once is the same as clicking with a mouse. A double-tap constitutes a double-click.

Right-clicking with the pen is accomplished by holding the pen tip down on the screen until a red circle surrounds the pointer as illustrated to the right. Lifting the pen from here opens up the corresponding submenu.

### Using the Pen as a Pen



The native handwriting recognition software makes it easy to enter text into your applications with the pen. Some applications, such as Windows Journal, allow you to write with the pen directly into the application window.

### Tablet PC Input Panel

When an application does not directly support pen input, you can use the **Tablet PC Input Panel** to enter text into your application. If you tap in an editable area, the Tablet PC Input Panel icon appears. Tapping the icon makes Input Panel appear. 

You can move the Input Panel tab by dragging it up or down along the edge of the screen. Then, when you tap it, the Input Panel opens at the same horizontal location on the screen that the tab appears.

You can use the writing pad, the character pad, or the on-screen keyboard to enter text. The writing pad and the character pad convert your handwriting into typed text. The on-screen keyboard works just like a standard keyboard except that you enter text by tapping keys with your tablet pen. The following table describes the different choices for using the Input Panel.

Input Panel Icons		
Icon	Name	Function
	<b>Writing Pad</b>	With the writing pad, you can write continuously as if you were writing on a lined piece of paper.
	<b>Character Pad</b>	The character pad converts your handwriting to typed text, one letter, number, or symbol at a time.
	<b>On-screen Keyboard</b>	The on-screen keyboard is similar to a standard keyboard.

The writing pad and character pad have a number pad, a symbol pad, and web quick keys to help you quickly and accurately enter these types of text. These quick keys are hidden when you start to write, but appear after you insert or delete your writing.

### Touch Usage

One of the key advantages of your XT2 XFR is the ability to easily switch from pen input to touch input. Similar to how the pen works, tapping with your finger on the screen once is the same as clicking with a mouse. A double-tap constitutes a double-click.

Right-clicking in Touch Mode is accomplished by holding your finger tip down on the screen until a red circle surrounds the pointer. This can be difficult to see as often times user's fingers cover the pointer. Lifting your finger from this point opens up the corresponding submenu.

### Tablet and Pen Settings

Most of the settings for the tablet and pen are located in Control Panel under Tablet and Pen Settings. These are also accessed through Dell Control Point System Manager.

## 1.4 XT2 XFR Settings

### 1.4.1 Installation

The N-trig Tablet Settings applet is built into the driver package. You can either install it directly from the ResourceCD or obtain the latest version from [support.dell.com](http://support.dell.com). Once the file has been extracted,

an InstallShield Wizard will walk you through the process of installing the software. The appearance of the N-trig icon is an indication of a successful installation.

### 1.4.2 Windows™ XP vs. Windows Vista™

There is only one major difference in the N-trig applet between XP and Vista. On the Digitizer Options tab, under the Input Mode section, there is no listing for Dual Mode on the XP version. Windows XP does allow use of both pen and touch but the seamless switching capability that Vista offers is not available.

### 1.4.3 N-trig Applet

The N-trig Tablet Settings applet is used to adjust several settings for the digitizer. Once the N-trig drivers are loaded, an icon appears in the system tray.

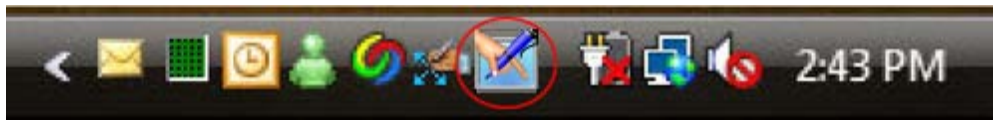

Hovering over the icon with your pointer displays the firmware version number. Right-clicking the icon brings up the sub menu below.

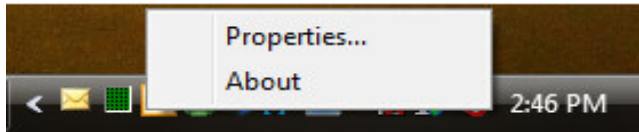

Clicking on Properties opens up the N-trig Tablet Settings window.

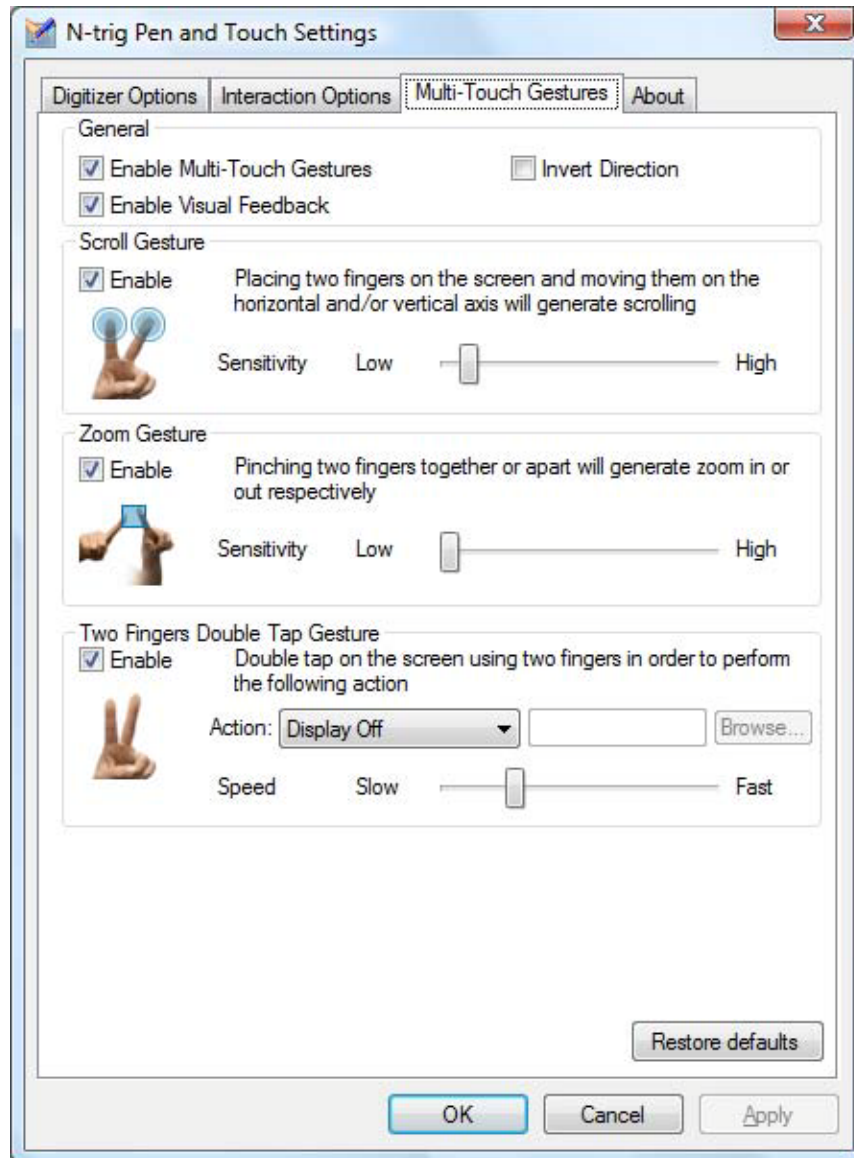

There are four tabs on the N-trig Tablet Settings window:

- [Digitizer Options](#)
- [Interaction Options](#)
- [Multi-Touch Gestures](#)
- [About](#)

### 1.4.3.1 Digitizer Options Tab

The **Digitizer Options** tab is used for the following:

- Input mode selection
- Touch tuning
- Launching diagnostics
- Restoring default settings



### 1.4.3.1.1 Input Mode Selection

The N-trig applet has 4 operating modes:

**Pen Only** — In this mode, the stylus is the only device that can be used as the input device with the N-trig digitizer. Changing from Pen Only mode to any other mode is done by clicking with an active input device on the N-trig Applet icon in the system tray. When the applet is open, select desired mode and press OK.

**Touch Only** — In Touch Only mode, a single finger is the only input device that can be used with the N-trig digitizer. Using the stylus is not possible. It is important to note that only a single hand contact is allowed with the digitizer for proper execution. Changing Touch Only mode into any other mode is done by tapping the N-trig Applet icon in System Tray using a finger or other active input device and choosing the desired mode. Press OK to confirm.

**Auto Mode** — The N-Trig digitizer is capable of detecting a stylus as well as finger touch. The purpose of Auto Mode is to allow the user intuitive toggling between the Pen Only or Touch Only modes. The default input device for Auto Mode is the stylus as long as it is in range of the tablet screen (hovering in proximity or in contact). A basic principle in Auto Mode is that stylus detection in the digitizer proximity would turn the digitizer into Pen Only mode as an overriding priority. A double-tap finger gesture on the screen (similar in style to a mouse double-click) will switch the digitizer from Pen Only mode to Touch Only mode. The system will remain in Touch Only mode as long as the stylus is out of range. Once the stylus is detected in range the system will automatically switch to Pen Only mode.

**Dual Mode (Vista Only)** — Dual Mode is a unique operational mode that is functional only while using the Microsoft Vista operating system. In this mode, the OS switches automatically between the available pointing device according to its internal priority and attributes.

### 1.4.3.1.2 Touch Tuning

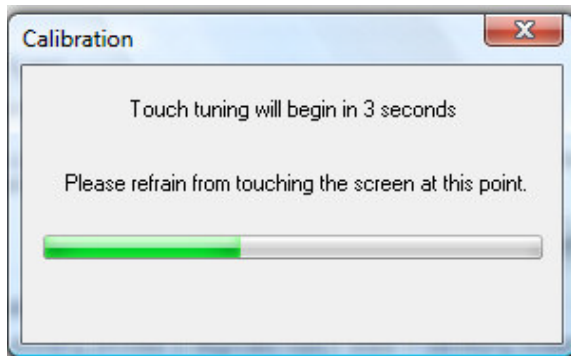

If you believe that the XT2 XFR's finger detection function is not working properly, a recalibration of the touch feature may be in order. To accomplish this, click the **Reset** button and then follow the on-screen prompts.



**CAUTION: Do NOT touch the screen while touch reset is in progress.**

A message indicating success or failure appears once the reset routine completes. If the result is failure, try running the diagnostics.

### 1.4.3.1.3 Launching Diagnostics

Running the diagnostics will help determine the functionality of the digitizer. Start by clicking the **Troubleshoot** button. Pressing the **Self Test** button on the subsequent pop-up window starts the diagnostics.



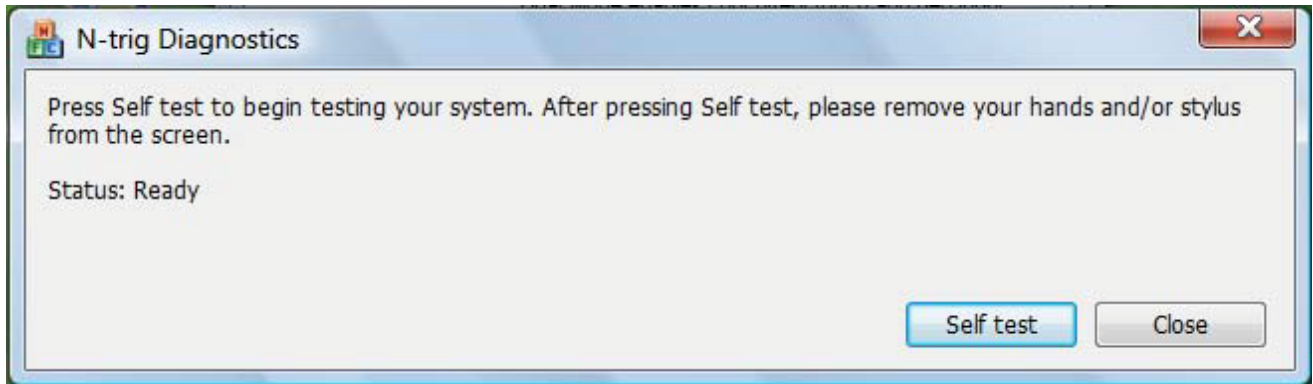

After the test is complete, the results are displayed as illustrated below.

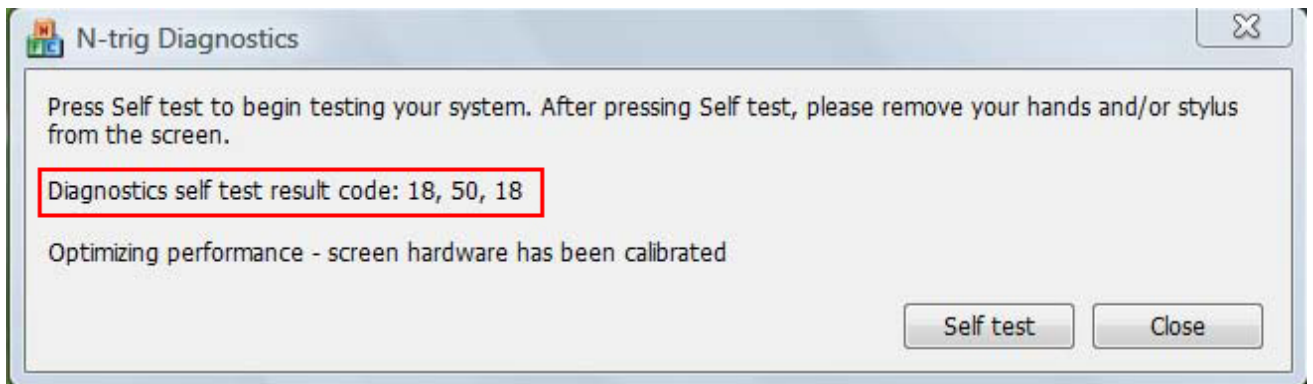

Use this table to define the result codes.

Digitizer Self Test Result Codes			
Code	Test	Error Details	Symptoms
7	A-trigs connectivity	Digitizer analog processor fail	Digitizer is unable to initialize or read samples from analog processor. No pen or touch position is reported.
11	Stylus excitation	No pen excitation	Signals received during the stylus excitation test are below certain limit. Pen may be not functional or detected in tip only.
14	Sensor Antenna disconnects	Digitizer grid disconnect	There are disconnected lines. Pen or touch may be malfunctioning in a specific physical display area.
15	Sensor Antenna shorts	Digitizer grid shortcut	There are shorted lines. Pen or touch may be malfunctioning in a specific physical display area.
18	Channel imbalance	Digitizer channel degraded	There is an unbalanced channel. Pen or touch may be malfunctioning in a specific physical display area.
19	Capacitor calibration	Digitizer calibration degraded	The calibration capacitor in a certain channel is set to minimal or maximum value. Pen or touch may be malfunctioning in a specific physical display area.
47	Internal Firmware Error	Internal Firmware Error	Firmware resource problem in executing diagnostics. Diagnostics tool is not functional.
48	Critical Malfunction	Device Error	Critical malfunction was detected, test cannot continue.

49	Host Timeout Error	Host Timeout Error	Host communication or resources problem in executing diagnostics.
50	Capacitor Calibration Required	Hardware calibration is required	Hardware calibration is required to gain maximum performance.

### 1.4.3.2 Interaction Options Tab

The **Interaction Options** tab controls the visual and sound effects that can modify the user experience while operating the system's various modes.

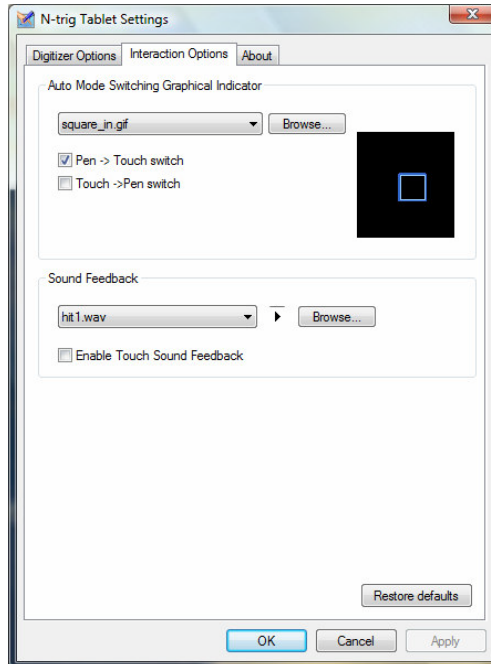

#### 1.4.3.2.1 Auto Mode Switching Graphical Indicator

This section enables you to select a .gif file (image) to be displayed whenever an auto mode switching event is detected. You can select the event that will cause the graphical indicator to appear:

- **Pen → Touch:** Pen is detected after finger usage.
- **Touch → Pen:** Touch is detected after pen usage.

#### 1.4.3.2.2 Sound Feedback

This section enables you to select which .wav file (sound) will be played when the finger touches the screen. The sound can be tested using the play button. One can enable/disable this functionality using the specified radio button.

### 1.4.3.3 Multi-Touch Gestures Tab

#### 1.4.3.3.1 Gestures

Gestures are expressions made while touching the screen of your Tablet PC with two fingers. They are interpreted as user commands to the operating system or active application software. When the operating system recognizes a gesture, an icon confirming the gesture appears on the screen. This multi-touch update includes three gestures: a scroll gesture, a zoom gesture, and a two-finger double-tap gesture. Gesture features and descriptive icons shown herein are sourced by N-trig.

### Scroll Gesture



Placing two fingers on the screen and moving them horizontally or vertically generates scrolling in the direction of movement: right, left, up, or down.

### Zoom Gesture



Touching the screen with two fingers and moving them together or apart generates a zoom-in or zoom-out command to the screen.



### Two-Fingers Double-Tap Gesture



Tapping the screen twice with two fingers sends an operating system command that you can configure. It can be used to perform actions, such as turning the display off and disabling touch gestures (default), or run an executable program, such as one that opens Internet Explorer.

### Sensitivity Setup

To adjust the sensitivity for the two-finger gestures, double-click the N-trig icon (  ) in the system tray, and tap the Multi-Touch Gestures tab. Set the sliders for each gesture as desired.

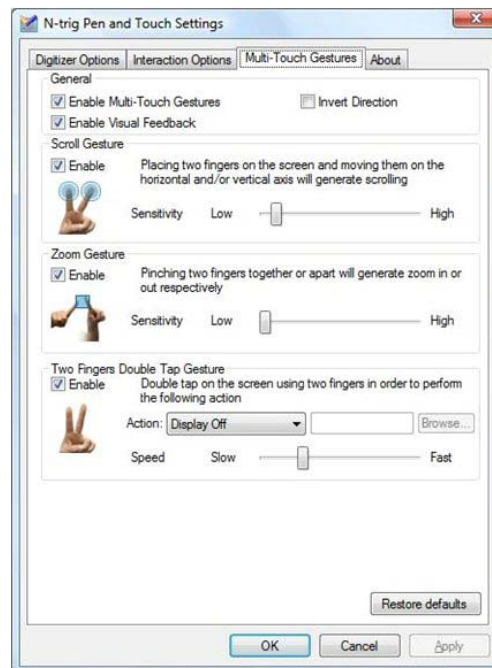

#### 1.4.3.4 About Tab

The **About** tab is used to find information such as the driver version and firmware revision numbers. The firmware revision number can also be obtained by hovering your pointer over the N-trig Tablet Settings icon in the system tray.

## 1.5 XT2 XFR Pen



1	Pen	2	Eraser pen button
3	Right-click pen button	4	Pen tip

Your XT2 XFR uses a specifically designed electrostatic pen or *stylus* for use in tablet PC mode. Instead of relying on battery power, the energy source for the stylus is magnetic energy produced by the excitation coil built into the digitizer itself. The signal from the coil is picked up by the stylus and triggers the stylus to transmit an electric field.

The transmitted electric field is sensed by a matrix of conductive lines, accurate stylus position determined using the low amplitude signals received on the vertical and horizontal conductors, and an appropriate signal is transferred to the digitizer's on-board processor.

Tips come in one color type, black. The black tips present a "harder" writing feel. The system ships with a total of two black tips. These tips are easily replaced by using the pen-tip removal tool which looks similar to an oversized pair of tweezers. This tool also ships with the XT2 XFR.

 **NOTE:** In the event of a suspected digitizer failure, the pen tip should be examined. If the tip is damaged it needs to be replaced. This will oftentimes remedy the problem with the digitizer.

### 1.5.1 Calibrating the Pen

The pen can function at the default calibration or at a calibration set by you or by another user. It is recommended that you use the pen only while it is calibrated to your personal calibration settings. Calibration optimizes pen performance for each user.



To calibrate the pen:

1. Open **Dell Control Point**.
2. Click **System → Tablet Settings**.
3. On the **Dell Tablet Settings** window, click **Pen & Input** then click **Calibrate**.
4. Follow the instructions on the screen. The calibration markers are displayed on the screen as plus signs (+). Tap the pen in the exact center of each of the calibration markers.



**NOTE:** Be sure to calibrate the pen for use in both portrait and landscape display orientations.

## 1.5.2 Troubleshooting

The pen is the first component to be investigated in the event of a suspected problem with the digitizer. Verify the tip is in good shape (free of chips, excessive wear, etc.) by closely examining it. If there is any doubt, you should change out the tip with a new one or one that is known to be in good condition.

You should also verify that the touch capabilities are not affected. Switch to touch mode and see if the problem still exists. If there are no symptoms present while in touch mode, the pen tip is the most likely suspect. If the problem does persist in touch mode you should run diagnostics and take the necessary steps depending on the results.

## 1.6 Application Matrix

The following matrix shows the gestures supported by the operating system and specific application software packages. Other applications may also respond to these gestures.

Operating System		Microsoft™ Windows Vista™			Microsoft Windows™ XP		
Application Family	Application Name	Pinch/Zoom	Horizontal Scroll	Vertical Scroll	Pinch/Zoom	Horizontal Scroll	Vertical Scroll
Windows	Explorer	Yes	Yes	Yes	No	Yes	Yes
	Photo Gallery	Yes	Yes	Yes	No	No	No
Windows Live	Photo Gallery	Yes	Yes	Yes	No	No	No
Virtual Earth		No	No	No	No	No	No
Microsoft Office 2007	Outlook®	Yes	Yes	No	Yes	Yes	No
	Word	Yes	Yes	Yes	Yes	Yes	No
	Excel®	Yes	Yes	Yes	Yes	Yes	No
	Power Point®	Yes	Yes	Yes	Yes	Yes	Yes
	One Note®	Yes	Yes	Yes	Yes	Yes	No
	Picture Manager	Yes	Yes	Yes	Yes	Yes	Yes
Microsoft Office 2003	Outlook®	Yes	Yes	Yes	Yes	Yes	Yes
	Word	Yes	Yes	Yes	Yes	Yes	Yes
	Excel®	Yes	Yes	Yes	Yes	Yes	Yes
	Power Point®	Yes	Yes	Yes	Yes	Yes	Yes
	One Note®	Yes	Yes	Yes	Yes	Yes	Yes
	Picture Manager	Yes	Yes	Yes	Yes	Yes	Yes

## 2 Working on Your XT2 XFR

## 2.1 Before Working Inside Your XT2 XFR

Use the following safety guidelines to help protect your XT2 XFR from potential damage and to help to ensure your personal safety. Unless otherwise noted, each procedure included in this document assumes that the following conditions exist:

- You have performed the steps in [Working on Your XT2 XFR](#).
- You have read the safety information that shipped with your XT2 XFR.
- A component can be replaced or--if purchased separately--installed by performing the removal procedure in reverse order.

 **WARNING:** Before working inside your XT2 XFR, read the safety information that shipped with your XT2 XFR. For additional safety best practices information, see the Regulatory Compliance Homepage at [www.dell.com/regulatory\\_compliance](http://www.dell.com/regulatory_compliance).

 **CAUTION:** Only a certified service technician should perform repairs on your XT2 XFR. Damage due to servicing that is not authorized by Dell is not covered by your warranty.

 **CAUTION:** To avoid electrostatic discharge, ground yourself by using a wrist grounding strap or by periodically touching an unpainted metal surface, such as a connector on the back of the computer.

 **CAUTION:** Handle components and cards with care. Do not touch the components or contacts on a card. Hold a card by its edges or by its metal mounting bracket. Hold a component such as a processor by its edges, not by its pins.

 **CAUTION:** When you disconnect a cable, pull on its connector or on its pull-tab, not on the cable itself. Some cables have connectors with locking tabs; if you are disconnecting this type of cable, press in on the locking tabs before you disconnect the cable. As you pull connectors apart, keep them evenly aligned to avoid bending any connector pins. Also, before you connect a cable, ensure that both connectors are correctly oriented and aligned.

 **NOTE:** The color of your XT2 XFR and certain components may appear differently than shown in this document.

To avoid damaging your XT2 XFR, perform the following steps before you begin working inside the XT2 XFR.

1. Ensure that your work surface is flat and clean to prevent the XT2 XFR cover from being scratched.
2. Turn off your XT2 XFR (see [Turning Off Your XT2 XFR](#)).
3. If the XT2 XFR is connected to a docking device (docked) such as the optional Media Base or Battery Slice, undock it.

 **CAUTION:** To disconnect a network cable, first unplug the cable from your XT2 XFR and then unplug the cable from the network device.

4. Disconnect all network cables from the XT2 XFR.
5. Disconnect your XT2 XFR and all attached devices from their electrical outlets.
6. Close the display and turn the XT2 XFR upside-down on a flat work surface.

 **CAUTION:** To avoid damaging the system board, you must remove the main battery before you service the XT2 XFR.

7. Remove the main battery (see [Removing the Main Battery](#)).
8. Turn the XT2 XFR top-side up.
9. Open the display.
10. Press the power button to ground the system board.

△ **CAUTION:** To guard against electrical shock, always unplug your XT2 XFR from the electrical outlet before opening the display.

△ **CAUTION:** Before touching anything inside your XT2 XFR, ground yourself by touching an unpainted metal surface, such as the metal at the back of the XT2 XFR. While you work, periodically touch an unpainted metal surface to dissipate static electricity, which could harm internal components.

11. Remove any installed ExpressCards or Smart Cards from the appropriate slots.
12. Remove the hard drive (see [Removing the Hard Drive](#)).

## 2.2 Recommended Tools

The procedures in this document may require the following tools:

- Small flat-blade screwdriver
- #0 Phillips screwdriver
- #1 Phillips screwdriver
- Small plastic scribe
- Flash BIOS update program CD

## 2.3 Turning Off Your XT2 XFR

△ **CAUTION:** To avoid losing data, save and close all open files and exit all open programs before you turn off your XT2 XFR.

1. Shut down the operating system:

- **In Windows Vista:**

Click **Start** , then click the arrow in the lower-right corner of the **Start** menu as shown below, and then click **Shut Down**.



- **In Windows XP:**

Click **Start** → **Turn Off Computer** → **Turn Off**.

The XT2 XFR turns off after the operating system shutdown process is complete.

2. Ensure that the XT2 XFR and all attached devices are turned off. If your XT2 XFR and attached devices did not automatically turn off when you shut down your operating system, press and hold the power button for about 4 seconds to turn them off.

## 2.4 After Working Inside Your XT2 XFR



After you complete any replacement procedure, ensure you connect any external devices, cards, and cables before turning on your computer.

**CAUTION:** To avoid damage to the XT2 XFR, use only the battery designed for this particular Dell computer. Do not use batteries designed for other Dell computers.

1. Connect any external devices, such as a port replicator, battery slice, or media base, and replace any cards, such as an ExpressCard.
2. Connect any telephone or network cables to your XT2 XFR.

**CAUTION:** To connect a network cable, first plug the cable into the network device and then plug it into the computer.

3. Replace the [main battery](#).
4. Connect your XT2 XFR and all attached devices to their electrical outlets.
5. Turn on your XT2 XFR.

### 3 Screw Chart

Chassis	Location	Screw	Part #	Qty
1	USB/1394 DOOR	hinge assy screw-M3 x 3	21106-03	2
		Latch screw-M1.2	40621	1
		door to chassis mouting screw	21106-00	4
2	IO/AUDIO DOOR	hinge assy screw-M3 x 3	21106-03	3
		Latch screw-M1.2	40621	1
		door to chassis mouting screw	21106-00	6
3	IO/VGA DOOR	hinge assy screw-M3 x 3	21106-03	2
		Latch screw-M1.2	40621	1
		door to chassis mouting screw	21106-00	4
4	POWER DOOR	hinge assy screw-M3 x 3	21106-03	1
		Latch screw-M1.2	40621	1
		door to chassis mouting screw	21106-00	2
5	RF PASS THRU	M2 x 3	21106-00	2
6	STYLUS BAY	Self tapping screw	40426	1
7	SNIFFER ASSEMBLY	M2 x 3	21106-00	2
8	SYSTEM BOARD	M2.5 x 5	21106-01	1
		M2.5 x 8	21106-02	1

9	WIFI ASSEMBLY			
		custom		1
10	HINGE PLATE TO CHASSIS			
		M2.5 x 5	21106-01	2
<b>Palm Rest</b>				
1	KEYBOARD DOOR			
		M2 x 3	21106-00	2
2	TOUCH PAD ASSEMBLY			
		M2 x 3	21106-00	4
3	USB HUB BOARD			
		M2 x 3	21106-00	2
4	BLUETOOTH MODULE (option)			
		M2 x 3	21106-00	1
5	KEYBOARD			
		M2 x 3	21106-00	2
6	Upper Palm Rest Screw			
		CSK screw-M2x 5	40628	1
<b>LCD inner- Bezel</b>				
1	FPR board			
		M2 x 3	21106-00	1
<b>LCD Outer</b>				
1	Rocker Switch Assy			
		custom	Thread Forming	3
2	Antenna bracket			
		M2 x 3	21106-00	4
<b>LCD ASSY</b>				
1	LCD mouting screws-PCB			
		custom csk	40319	3
2	Hinge Mouting screws			
		M2.5 x 5	21106-01	4
3	ID Plate			
		M2.5 x 5	21106-01	4
4	LCD inner and Outer Assy screws			
		M2.5 x 8	21106-02	8
	front top side	M2.5 x 7	40630	4
5	Hinge Cover screw			
		M2.5 x 5	21106-01	1
<b>Base to LCD</b>				
1	hinge mouting base screw			
		M3 x 3	40500	4
2	Cable Clamp screws			

		custom	Thread Forming	
<b>Base to Palm rest</b>				
1	under the battery area			
		M2.5 x 5	21106-01	7
2	under the battery area			
		M2.5 x 8	21106-02	1
3	bottom side screws			
		M2.5 x 8	21106-02	9
<b>Battery Module</b>				
1	Battery module assy			
		M2 x 3	21106-00	4
<b>KEYPAD / HINGE COVER</b>				
1	Captive screw-M2			
		custom	40190	4
<b>Dimms Door</b>				
1	Captive screw-M2			
		custom	40190	4
<b>Latch Palm Rest</b>				
1	shoulder screw, Captive			
		custom	40301	2

## 4 Adding and Replacing Parts

### 4.1 Main Battery

**⚠ WARNING:** Before working inside your XT2 XFR, read the safety information that shipped with your XT2 XFR. For additional safety best practices information, see the Regulatory Compliance Homepage at [www.dell.com/regulatory\\_compliance](http://www.dell.com/regulatory_compliance).



### 4.1.1 Removing the Main Battery

1. Follow the procedures in [Before Working Inside Your XT2 XFR](#).
2. Slide the two battery-bay latch releases on the bottom of the XT2 XFR outward to each side.

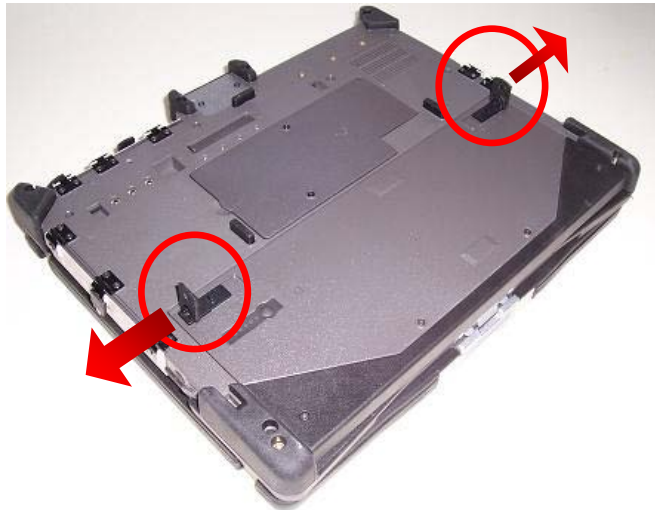

3. Slide the battery out of the battery bay. Lift slightly using the latches to release the back edge.

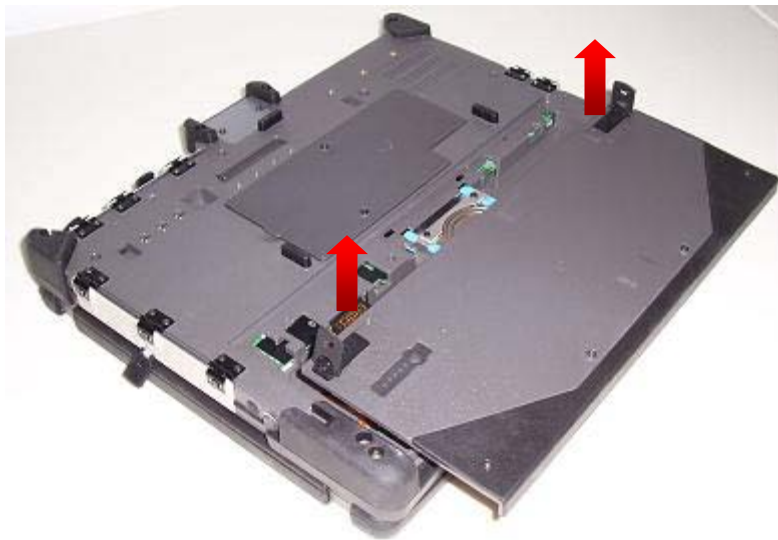

4. Remove the battery from the XT2 XFR.

### 4.1.2 Removing the Battery from the Battery Door

1. Follow the procedures in [Before Working Inside Your XT2 XFR](#).
2. Remove the [battery](#) from the XT2 XFR before continuing.
3. Loosen the four captive screws on the front edge of the battery door. This releases the battery bracket.

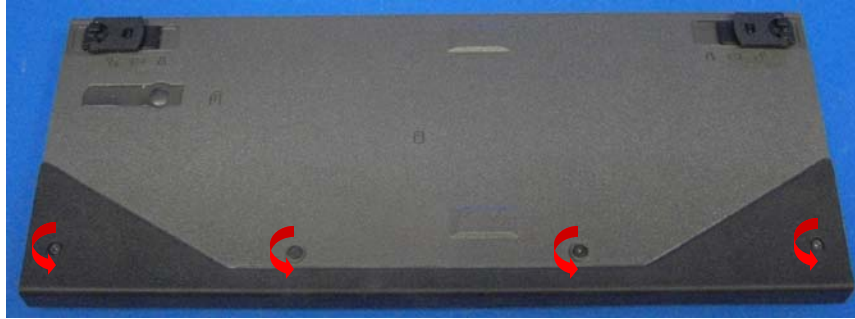

4. Rotate the door up to remove the battery.



5. Remove the battery.

### 4.1.3 Installing the Battery into the Battery Door

1. Place the bracket onto the battery.



2. Slide the battery onto the battery door and align the tabs on the battery with the door tabs.



3. Hold the bracket down and tighten the four captive screws.

## 4.2 Hinge Cover

**⚠ WARNING:** Before working inside your XT2 XFR, read the safety information that shipped with your XT2 XFR. For additional safety best practices information, see the Regulatory Compliance Homepage at [www.dell.com/regulatory\\_compliance](http://www.dell.com/regulatory_compliance).

### 4.2.1 Removing the Hinge Cover

1. Follow the procedures in [Before Working Inside Your XT2 XFR](#).
2. Remove the [battery](#) from the XT2 XFR.
3. Loosen the four captive screws securing the hinge cover in place.

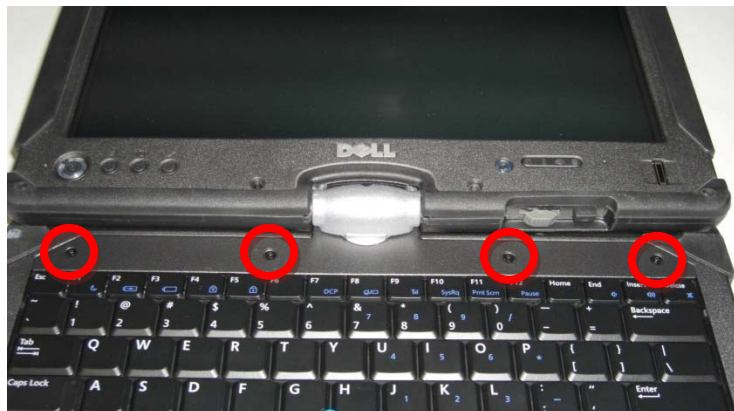

4. Use your fingers to release the rest of the hinge cover by pulling up slightly and remove from the XT2 XFR.





## 4.3 Keyboard

**⚠ WARNING:** Before working inside your XT2 XFR, read the safety information that shipped with your XT2 XFR. For additional safety best practices information, see the Regulatory Compliance Homepage at [www.dell.com/regulatory\\_compliance](http://www.dell.com/regulatory_compliance).

### 4.3.1 Removing the Keyboard



1. Follow the procedures in [Before Working Inside Your XT2 XFR](#).
2. Before performing this step, follow the instructions in [removing the battery](#) section.
3. Perform the instructions on [removing the hinge cover](#) section.
4. Remove the two screws securing the keyboard to the XT2 XFR.



5. Gently slide the keyboard towards the display.



6. Remove the two screws (M2 x 3-mm) securing the connector door to the palm rest.
7. Lift and remove the connector door.
8. Release the zif connector for the touchpad cable.



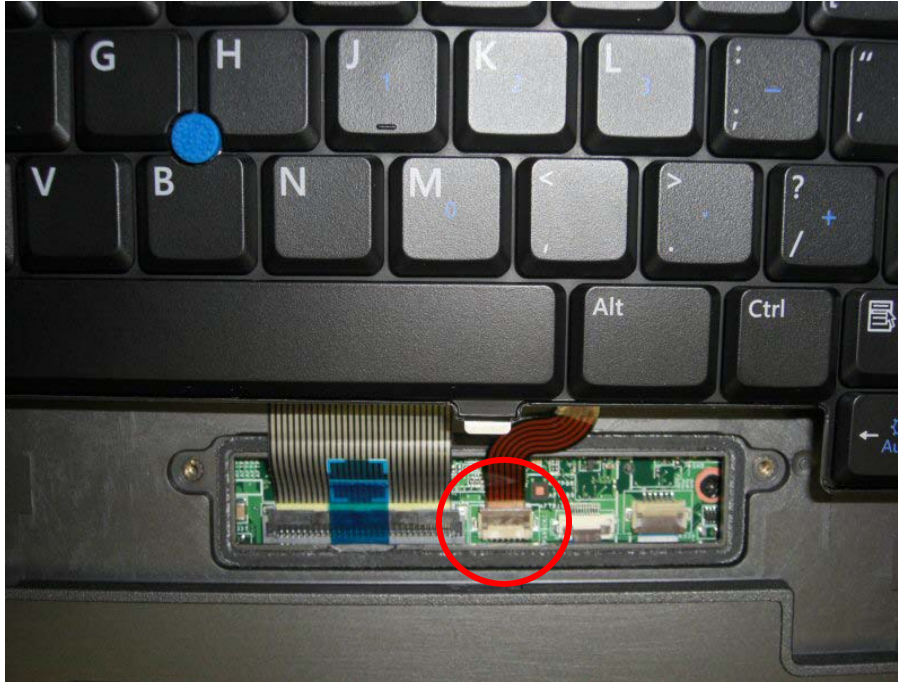

7. Disconnect the touch pad cable.

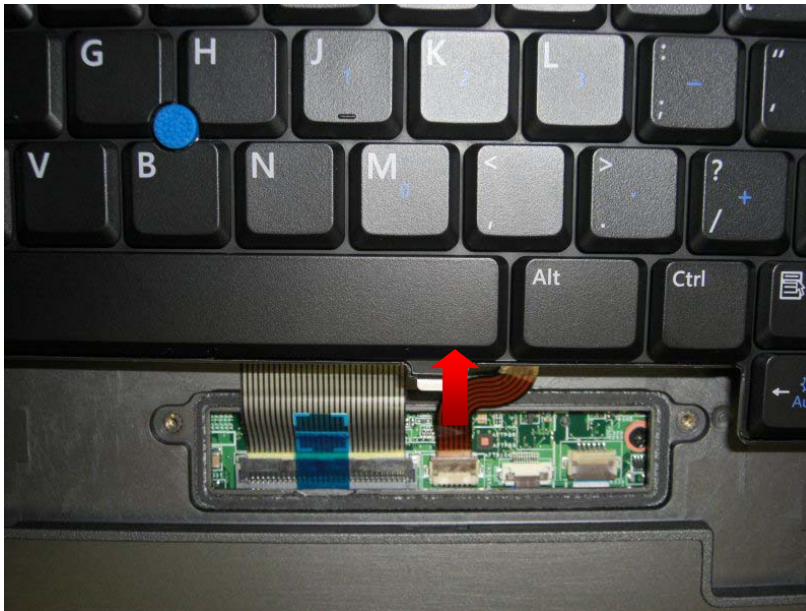

8. Release the zif connector for the keyboard cable.

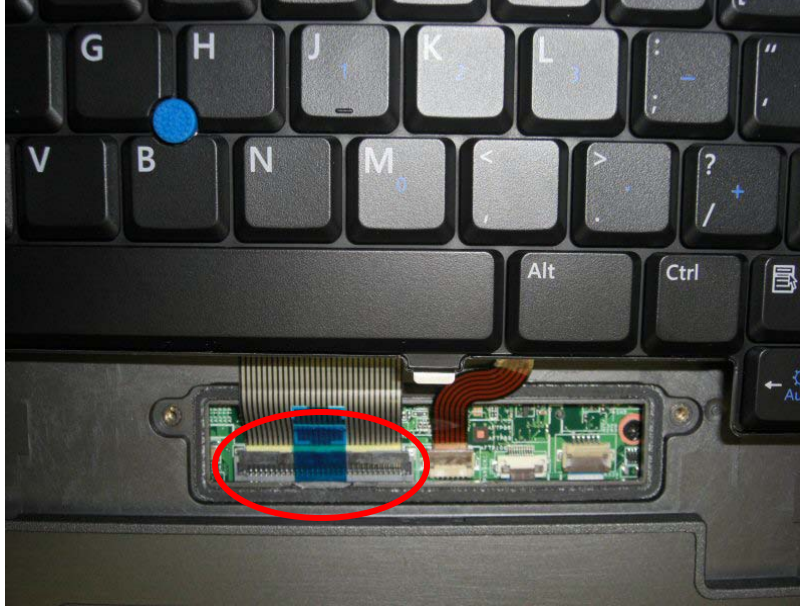

9. Lift using the blue pull tab on the keyboard cable and disconnect the keyboard cable from the system board.
10. Remove the keyboard from the XT2 XFR.

## 4.4 Memory and Mini-Card Cover

**⚠ WARNING:** Before working inside your XT2 XFR, read the safety information that shipped with your XT2 XFR. For additional safety best practices information, see the Regulatory Compliance Homepage at [www.dell.com/regulatory\\_compliance](http://www.dell.com/regulatory_compliance).

### 4.4.1 Removing the Memory and Mini-Card Cover



1. Follow the procedures in [Before Working Inside Your XT2 XFR](#).
2. Remove the [battery](#) from the XT2 XFR.
3. Loosen the two captive screws on the memory and mini-card cover.



4. Lift the cover up from the left side using the grip tab.



5. Lift the cover while sliding to the left, and remove from the XT2 XFR.





## 4.5 Memory

**⚠ WARNING:** Before working inside your XT2 XFR, read the safety information that shipped with your XT2 XFR. For additional safety best practices information, see the Regulatory Compliance Homepage at [www.dell.com/regulatory\\_compliance](http://www.dell.com/regulatory_compliance).

### 4.5.1 Removing a Memory Module



1. Follow the procedures in [Before Working Inside Your XT2 XFR](#).
2. Remove the [battery](#) before continuing.
3. Remove the [memory and mini-card cover](#) before continuing.
4. Use your fingers to gently pry the retaining clips away from the memory module.

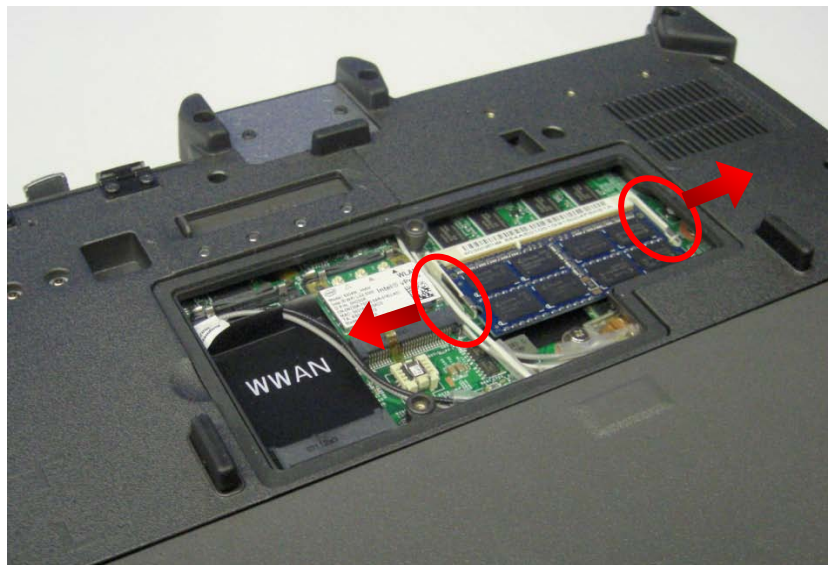

5. Remove the memory module from the XT2 XFR at an angle.



## 4.6 Hard Drive

**⚠ WARNING:** Before working inside your XT2 XFR, read the safety information that shipped with your XT2 XFR. For additional safety best practices information, see the Regulatory Compliance Homepage at [www.dell.com/regulatory\\_compliance](http://www.dell.com/regulatory_compliance).

### 4.6.1 Removing the Hard Drive



1. Follow the procedures in [Before Working Inside Your XT2 XFR](#).
2. Remove the [battery](#) from the XT2 XFR.
3. Slide the hard drive towards front edge to disconnect from the system board and unlock the housing from the chassis.



4. Lift the handle to remove the hard drive from the XT2 XFR.

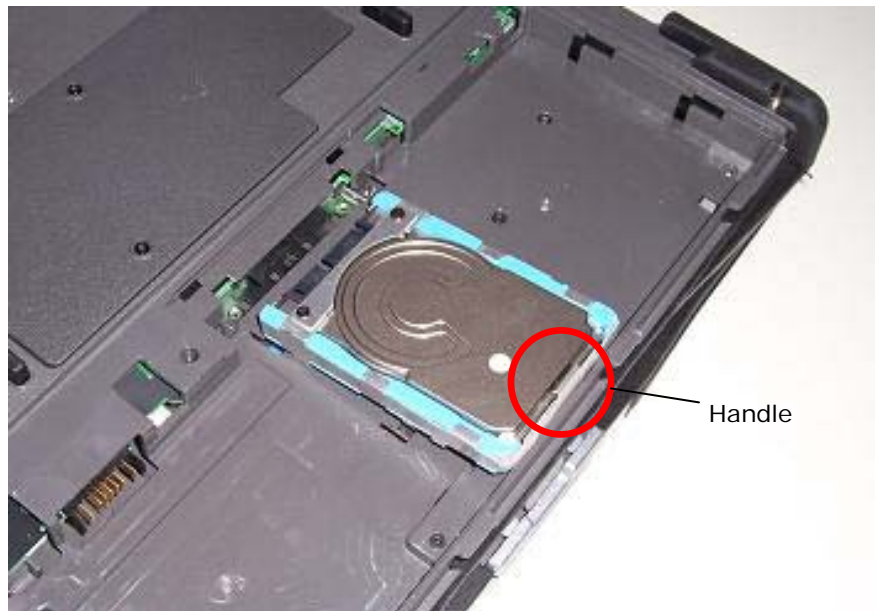

## 4.7 Mini-Card

**⚠ WARNING:** Before working inside your XT2 XFR, read the safety information that shipped with your XT2 XFR. For additional safety best practices information, see the Regulatory Compliance Homepage at [www.dell.com/regulatory\\_compliance](http://www.dell.com/regulatory_compliance).

## 4.7.1 Removing the Mini-Card



1. Follow the procedures in [Before Working Inside Your XT2 XFR](#).
2. Remove the [battery](#) from the XT2 XFR.
3. Remove the [memory and mini-card cover](#) before continuing.
4. Depending on the type of wireless adapter installed, disconnect either two or three antenna cables from the mini-card. Each mini-card will have a label for the wire to be connected or disconnected from the adapter. WWAN, WLAN and WPAN mini-cards all have similar labeling.

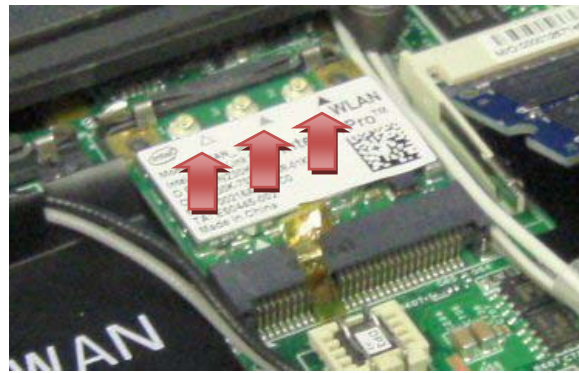

**NOTE:** There are five cables located under the memory door. Two enter the bay from the left side, three enter from the back center location. The table below explains where each cable would connect to for WLAN and WWAN devices. Most new WLAN and WWAN mini-cards available today have icons on their label that tells you which cable to connect to which antenna port.

1	BLACK (left side) – Connects to black labeled terminal on WLAN adapters
2	GREY (left side) – Connects to grey terminal on WWAN adapters
3	WHITE (center) – Connects to white terminal on WLAN adapters
4	WHITE/GREY (center) – Connects to white terminal on WWAN adapters
5	GREY (center) – Connects to grey terminal on WLAN adapters (If adapter is A/G/N capable)



5. Use your finger to gently pry the retaining clips back and release the mini-card.



6. Remove the mini-card from the XT2 XFR at an angle.





## 4.8 Internal Card With Bluetooth® Wireless Technology

**⚠ WARNING:** Before working inside your XT2 XFR, read the safety information that shipped with your XT2 XFR. For additional safety best practices information, see the Regulatory Compliance Homepage at [www.dell.com/regulatory\\_compliance](http://www.dell.com/regulatory_compliance).

### 4.8.1 Removing the Internal Card With Bluetooth Wireless Technology

1. Follow the procedures in [Before Working Inside Your XT2 XFR](#).
2. Remove the [battery](#) before continuing.
3. Disconnect the Bluetooth cable from the Bluetooth adapter.

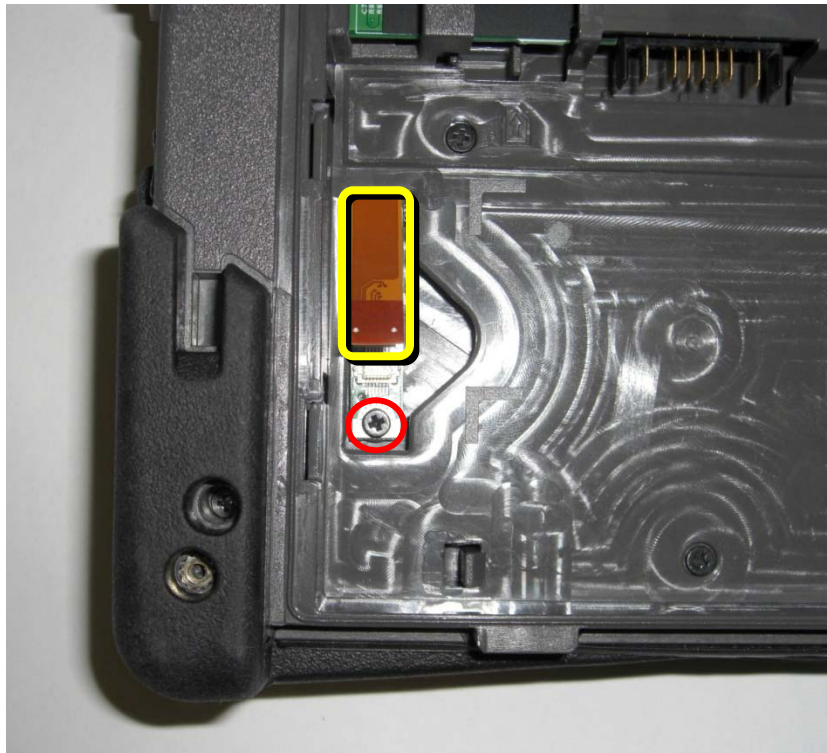

4. Loosen the screw on the Bluetooth assembly.
5. Carefully lift the Bluetooth assembly out of the XT2 XFR.



6. Remove the Bluetooth assembly from the XT2 XFR.



## 4.9 Palm Rest

**⚠ WARNING:** Before working inside your XT2 XFR, read the safety information that shipped with your XT2 XFR. For additional safety best practices information, see the Regulatory Compliance Homepage at [www.dell.com/regulatory\\_compliance](http://www.dell.com/regulatory_compliance).

### 4.9.1 Removing the Palm Rest

1. Follow the procedures in [Before Working Inside Your XT2 XFR](#).
2. Remove the [battery](#) before continuing.
3. Remove the [hard drive](#) before continuing.
4. Remove the [memory and mini-card cover](#) before continuing.
5. Disconnect any antenna cables from the WWAN/WLAN adapters in the XT2 XFR.
6. Remove the seventeen (17) screws (7 – 2.5 x 5-mm and 10 - 2.5 x 8-mm) securing the palm rest from the bottom of the XT2 XFR.
7. Release the two (2) locking tabs by pressing each toward the corner edge slightly and pushing down to disengage the tabs from the chassis.

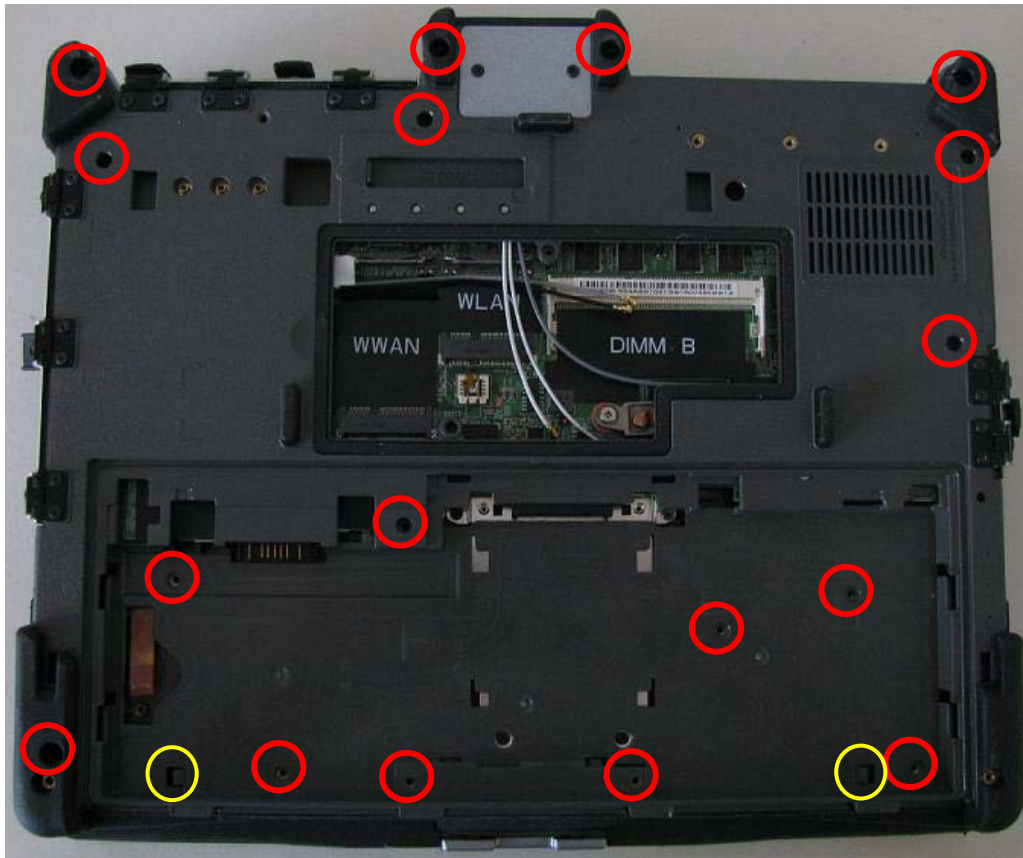

8. Flip the unit over and remove the [hinge cover](#) from the XT2 XFR.
9. Remove the [keyboard](#) from the XT2 XFR.
10. Rotate the LCD 90 degrees to allow access to the front and rear mounting plate screws. Remove the 2 screws for the Hinge Cap and remove the hinge cap from the rear of the system, then remove the 2 screws in the LCD Hinge securing the display assembly to the chassis.
11. Remove two cable clamp to base screws and lift the clamp out of the XT2 XFR.

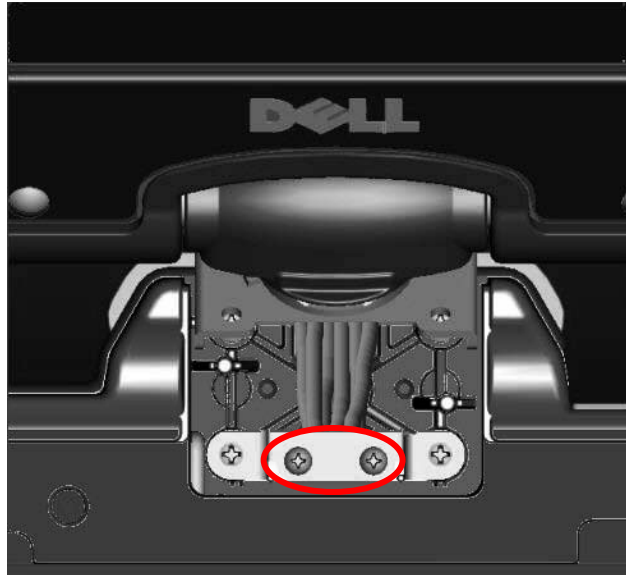

12. Lay the display assembly behind the chassis.
13. Gently lift the palm rest, moving the door opening over to the right slightly and disconnect the touchpad cable.

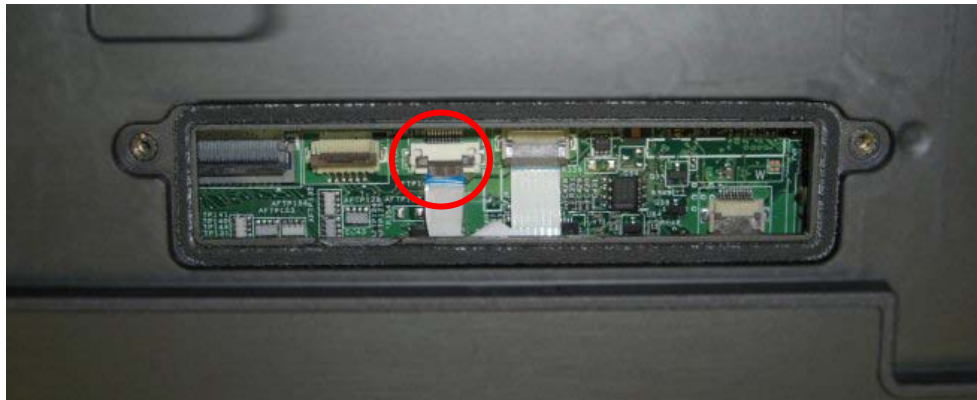

14. Lift the palmrest from the left side slightly and tilt the palm rest up towards the right to disconnect the LCD to USB hub board and USB hub board to system board connector.





15. Remove the palm rest from the XT2 XFR.

## 4.9.2 Installing the Palm Rest

1. Insert the cable clamp over the LCD cables and secure with the cable clamp to base screws.

**⚠ CAUTION:** Make sure the cable clamp is set properly over the cable gasket and the cable gasket is secure before proceeding. Failure to perform this step properly could cause an inlet for moisture into the system.

2. Set the palm rest onto the right side and tilt the palm rest up connect the USB Hub board to system board cable (ribbon cable). Then connect the LCD to USB Hub board cable.

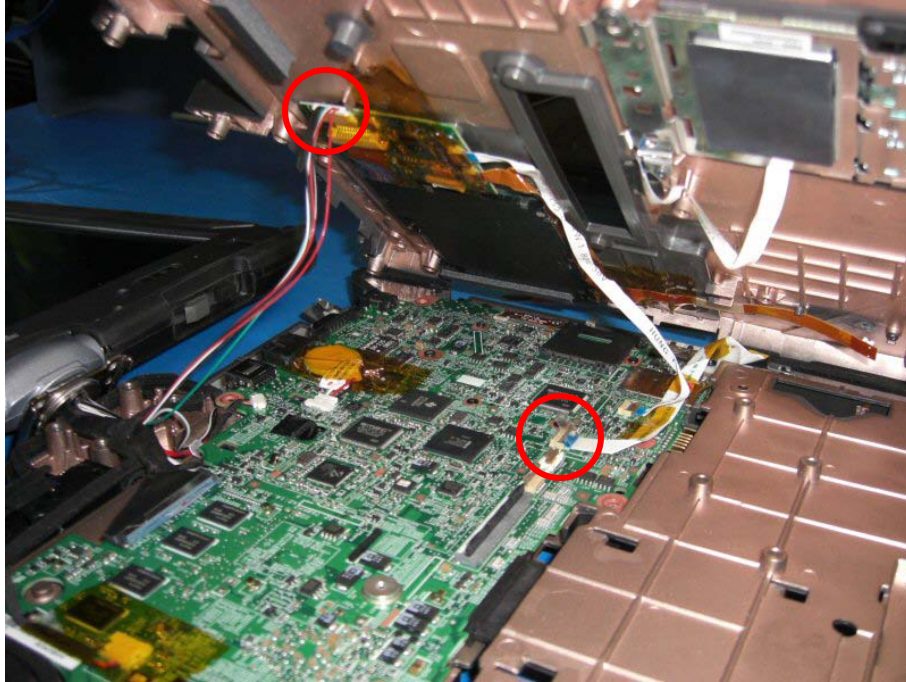

3. Ensure the ribbon cable for the touch pad can be seen through the palm rest door, then place the palm rest over the chassis so the view through the door is over the touchpad connector. Insert the touch pad cable into the connector and close the lock tab.

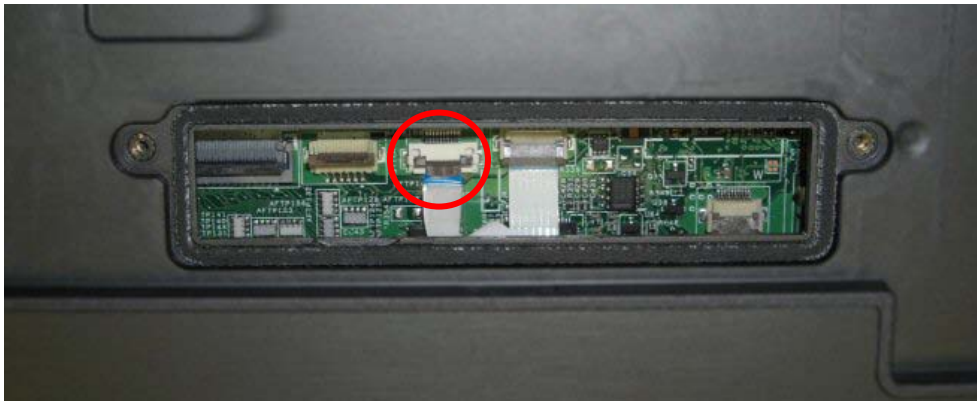

4. Lift the palm rest slightly and set it into position over the edge gaskets and press on the palm rest front edge to lock the palm rest into place.
5. Install the screw on the right side of the keyboard valley.



6. With the LCD bracket rotated 90 degrees, set the display onto the chassis and align the bracket guide pins.



7. Install the back hinge cap and tighten the two screws securing the cover.
8. Install the front two screws securing the display to the chassis. Rotate the display to notebook mode before continuing.
9. Install the keyboard. (see [Keyboard](#) chapter for reference)
10. Install the hinge cover. (see [Hinge Cover](#) chapter for reference)
11. Turn the system over so the bottom side is facing up.
12. Install the seventeen (17) screws (7 – 2.5 x 5-mm and 10 - 2.5 x 8-mm) securing the palm rest from the bottom of the XT2 XFR.



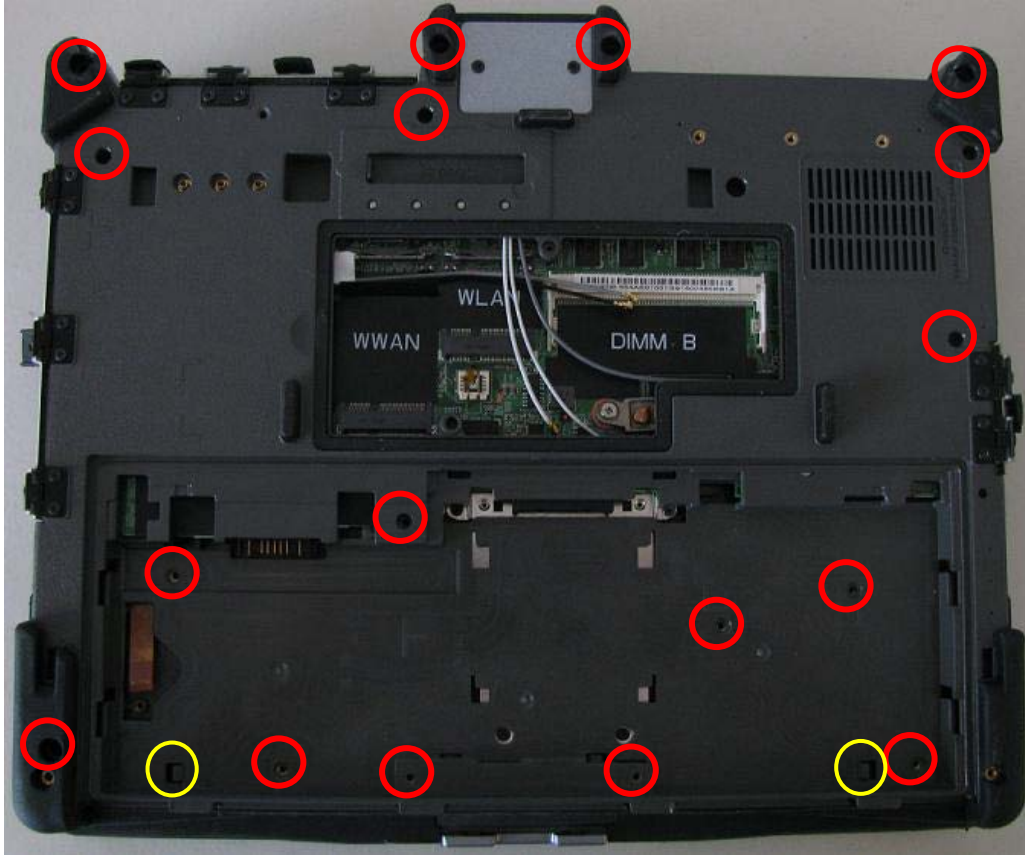

13. Install the WLAN/WWAN mini-cards. (See [mini-card](#) chapter for reference)
14. Install the memory module. (See [memory](#) chapter for reference)
15. Install the mini-card and memory door. (See [memory cover](#) chapter for reference)
16. Install the hard drive. (See [hard drive](#) chapter for reference)
17. Install the battery. (See [battery](#) chapter for reference)

## 4.10 Coin-Cell Battery

**⚠ WARNING:** Before working inside your XT2 XFR, read the safety information that shipped with your XT2 XFR. For additional safety best practices information, see the Regulatory Compliance Homepage at [www.dell.com/regulatory\\_compliance](http://www.dell.com/regulatory_compliance).

### 4.10.1 Removing the Coin-Cell Battery

1. Follow the procedures in [Before Working Inside Your XT2 XFR](#).
2. Follow the procedures in [removing the palm rest](#) before continuing.
3. Disconnect the coin-cell battery from the system board and remove from the XT2 XFR



## 4.10.2 Installing the Coin-Cell Battery

1. Connect the coin-cell battery to the system board.
2. Place the tape side of the battery to the left of the chassis pad directly in front of the USB connector location. DO NOT place battery on chassis pad.



3. Follow the procedures for [Installing the palm rest](#).

## 4.11 USB Interface Board

### 4.11.1 Removing the USB Interface Board

**⚠ WARNING:** Before working inside your XT2 XFR, read the safety information that shipped with your XT2 XFR. For additional safety best practices information, see the Regulatory Compliance Homepage at [www.dell.com/regulatory\\_compliance](http://www.dell.com/regulatory_compliance).

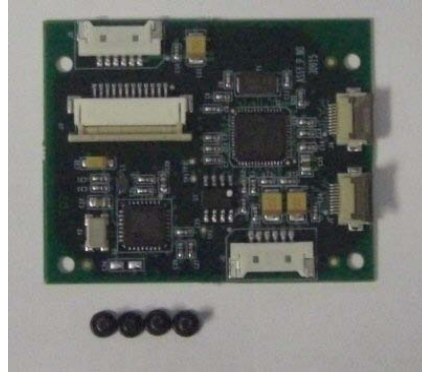

1. Follow the procedures in [Before Working Inside Your XT2 XFR](#).
2. Follow the procedures in [removing the palm rest](#) before continuing.
3. Flip the palm rest over and remove the protective Mylar tape (covering the USB hub board assembly), and save, as this will be replaced later during installation.
4. Disconnect the Smartcard reader cable, the Bluetooth cable and the system board cable from the ZIF connectors on the USB Interface board.
5. Remove the 4 screws holding the USB interface board to the palm rest.

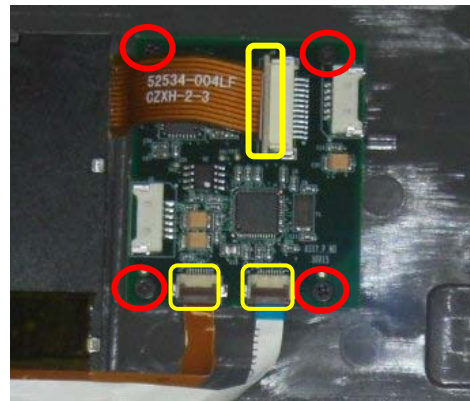

## 4.12 Stylus Bay

**⚠ WARNING:** Before working inside your XT2 XFR, read the safety information that shipped with your XT2 XFR. For additional safety best practices information, see the Regulatory Compliance Homepage at [www.dell.com/regulatory\\_compliance](http://www.dell.com/regulatory_compliance).

### 4.12.1 Removing the Stylus Bay

1. Follow the procedures in [Before Working Inside Your XT2 XFR](#).
2. Follow the procedures in [removing the palm rest](#) before continuing.
3. Disconnect the stylus bay connector from the system board.

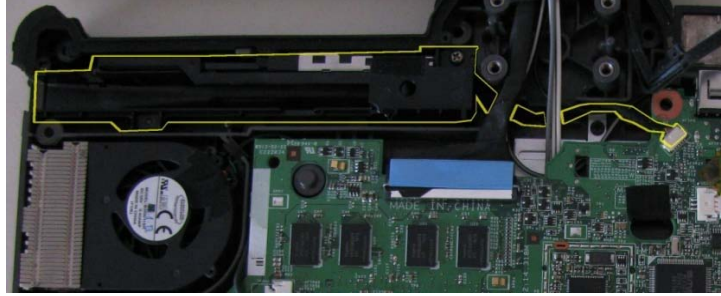

4. Loosen and remove the screw holding the stylus bay housing to the chassis.

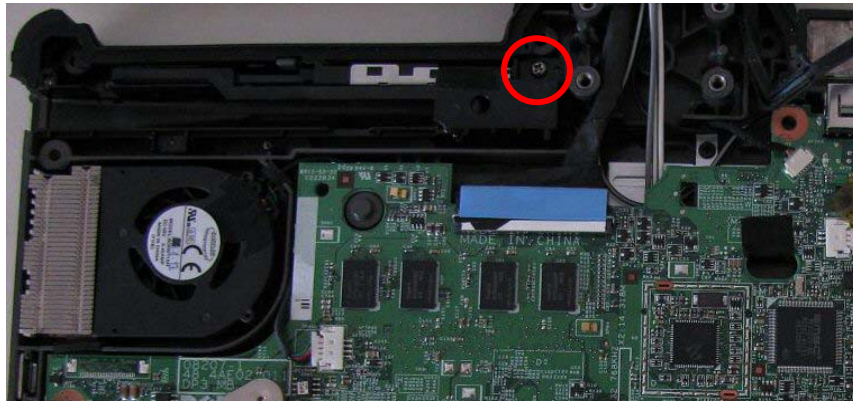

5. Unthread the cable and connector for the stylus bay.
6. Remove the Stylus Bay from the bottom chassis by lifting up. Being careful not to damage the grommet that seals to the base.

## 4.12.2 Installing the Stylus Bay

1. Start by threading the cable and connector through the opening in the chassis.
2. Set the grommet surrounding the cable in the opening to produce a seal.
3. Insert the stylus bay into the chassis being careful with the gaskets around the bay.
4. Insert and tighten the self tapping screw.

## 4.13 Speaker

**⚠ WARNING:** Before working inside your XT2 XFR, read the safety information that shipped with your XT2 XFR. For additional safety best practices information, see the Regulatory Compliance Homepage at [www.dell.com/regulatory\\_compliance](http://www.dell.com/regulatory_compliance).



### 4.13.1 Removing the Speaker



1. Follow the procedures in [Before Working Inside Your XT2 XFR](#).
2. Follow the procedures in [removing the palm rest](#) before continuing.
3. Disconnect the speaker cable from the system board.

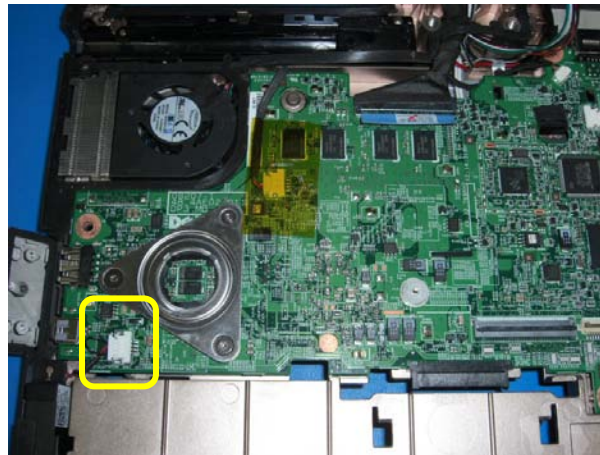

4. Remove the speaker assembly from the XT2 XFR.



## 4.14 WiFi Sniffer Assembly

**⚠ WARNING:** Before working inside your XT2 XFR, read the safety information that shipped with your XT2 XFR. For additional safety best practices information, see the Regulatory Compliance Homepage at [www.dell.com/regulatory\\_compliance](http://www.dell.com/regulatory_compliance).

### 4.14.1 WiFi Sniffer Assembly Removal

1. Follow the procedures in [Before Working Inside Your XT2 XFR](#).
2. Follow the procedures in [Removing the palm rest](#) before continuing.
3. Loosen and remove the two screws holding the WiFi sniffer assembly chassis.

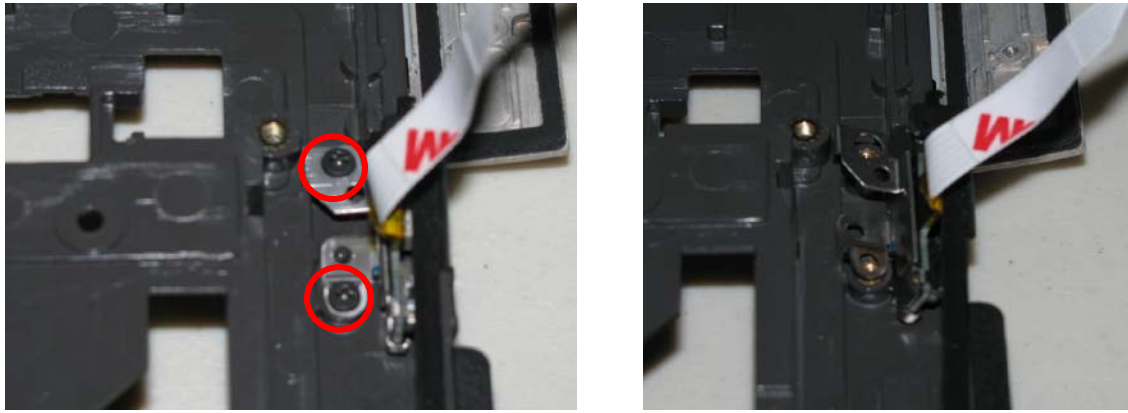

4. Carefully remove the WiFi sniffer assembly from the bottom chassis by rotating slightly.

### 4.14.2 Wifi Sniffer Assembly Installation

1. Install the sniffer switch assembly into the chassis. On installation, the sniffer switch needs to be aligned with the metal bracket for the external switch. (see image below)

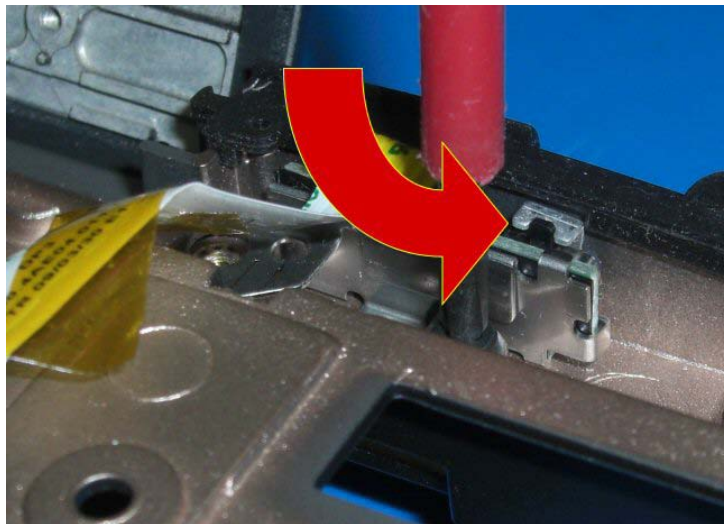

2. Install the two screws (2 x 3-mm) holding the sniffer bracket to the chassis.



## 4.15 Sniffer Button and Wifi Switch

1. Remove the sniffer button by inserting a plastic scribe on the top corner and lightly pressing down to release the seal.



2. Remove the button.

### 4.15.1 Installing the Wifi sniffer button

1. Place the rubber sniffer button over the hole and gently press while rolling your finger over the button. This is a self sealing button.



2. Verify the button is sealed by sliding your finger over it.

### 4.15.2 Installing the Wifi on/off switch

1. Follow the procedures in [WiFi Sniffer Assembly Removal](#) before continuing.
2. Place a scribe or flathead screwdriver at a position that allows the switch to be inserted into the center hole of the metal bracket and hold firmly in place.

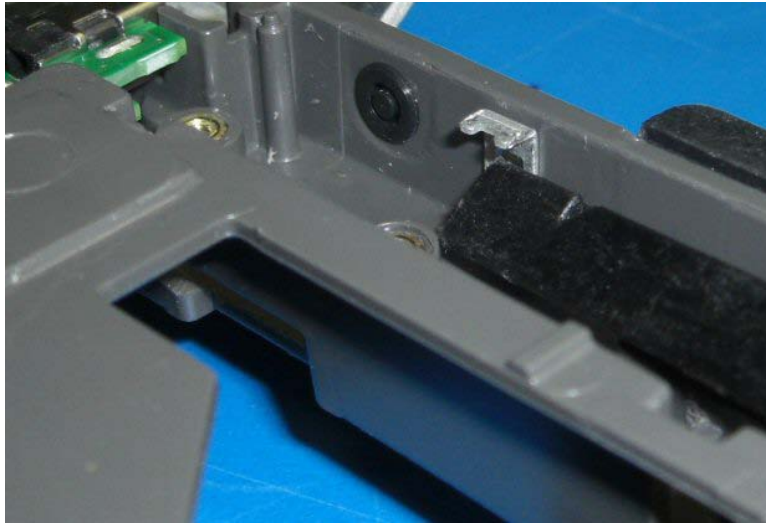

3. Press the switches clips through the hole in the bracket until it locks in place.

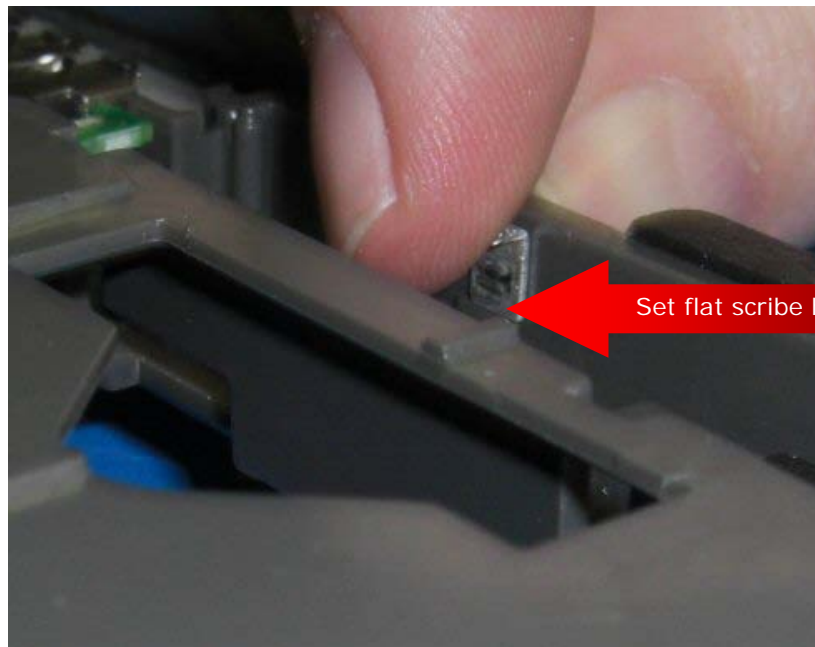

 **NOTE:** It may help to hold the tool and bracket in place with the flathead screwdriver and set the switch in place then use your index finger to hold the upper part of the bracket while pressing the switch into place with your thumb.

4. Perform the steps for [Installing the WiFi Sniffer Assembly](#).
5. To complete perform the steps for [Installing the Palm Rest](#).

## 4.16 System Board

**⚠ WARNING:** Before working inside your XT2 XFR, read the safety information that shipped with your XT2 XFR. For additional safety best practices information, see the Regulatory Compliance Homepage at [www.dell.com/regulatory\\_compliance](http://www.dell.com/regulatory_compliance).

### 4.16.1 Removing the System Board

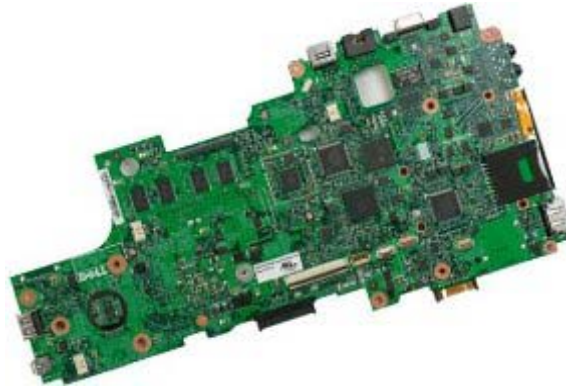

1. Follow the procedures in [Before Working Inside Your XT2 XFR](#).
2. Follow the procedures in [removing the palm rest](#) before continuing.
3. From the inside of the XT2 XFR, disconnect the display cable from the system board.
4. Remove the [coin-cell battery](#) from the XT2 XFR.
5. Disconnect the speaker cable from the system board.
6. Disconnect the Stylus bay connector from the system board.
7. Disconnect the video connector from the system board.
8. Remove the sniffer switch cable from the system board.
9. Remove the two screws securing the system board to the bottom chassis and white plastic bracket.

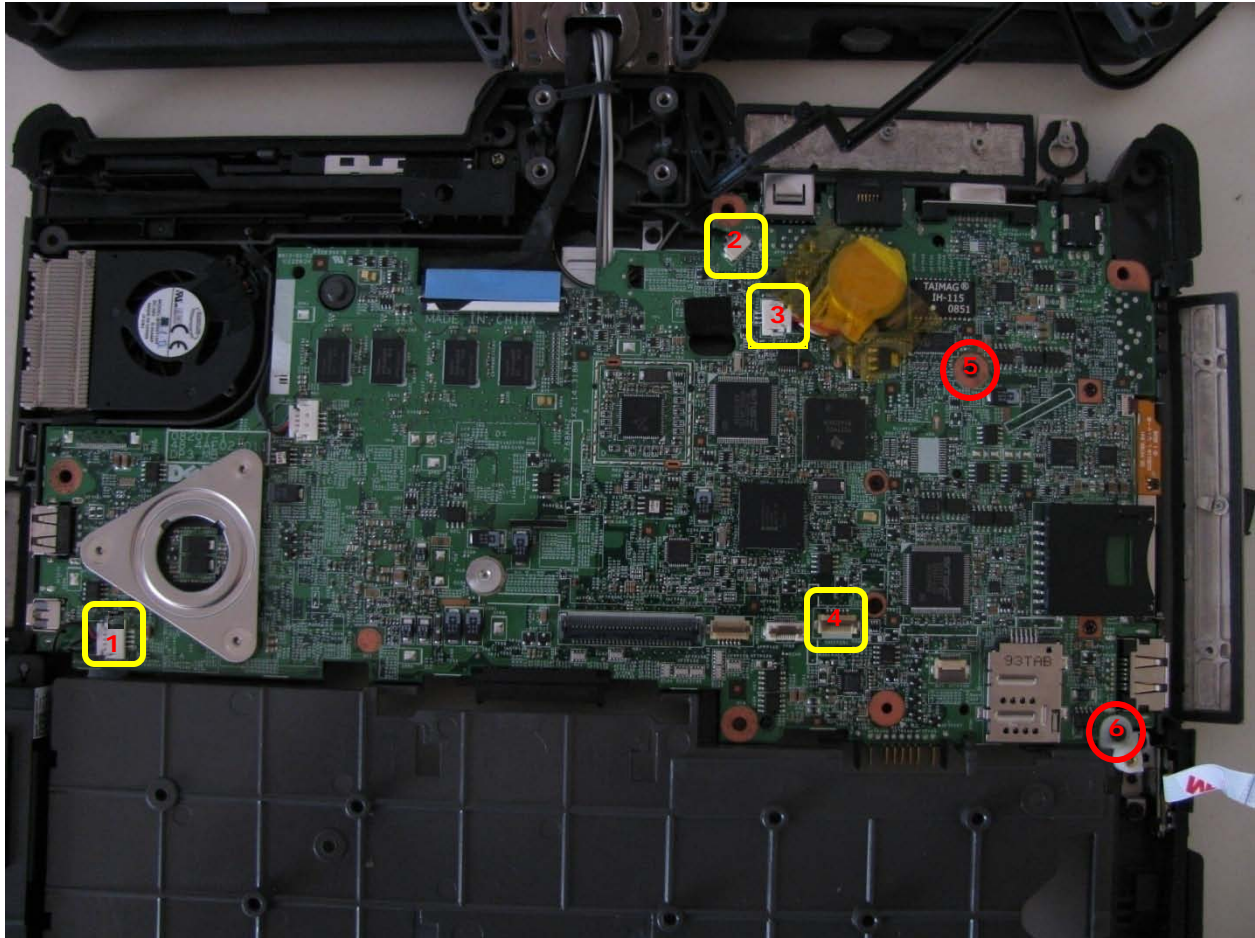

1	Speaker connection	2	Stylus connection
3	Coin-cell battery connection	4	WiFi sniffer connection
5	System board screw (2.5 x 5-mm)	6	System board screw at bracket (2.5 x 8-mm)

10. Carefully lift the gasket surround from the fan housing area and lift the gasket from over the video/antenna cable socket.

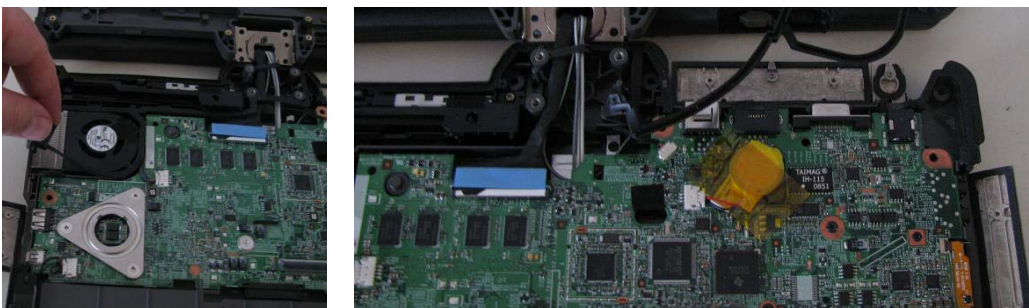

11. Lift the system board up and remove from the XT2 XFR.



## 4.16.2 Installing the System Board

1. Examine the system board to make sure there are nine (9) insulation pads set around the grounding clips on the palmrest side of the system board, and one (1) on the processor side of the system board near the docking connector.

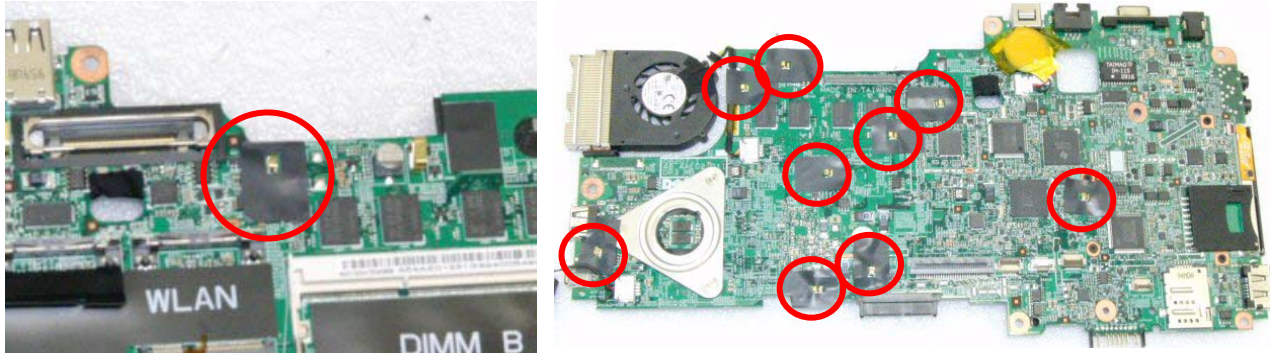

2. Place the system board into the chassis and seat the fan cable grommet into the grommet channel.
3. Install the screws (1 – 2.5 x 5-mm), (1- 2.5 x 8-mm with bracket) securing the system board to the chassis.

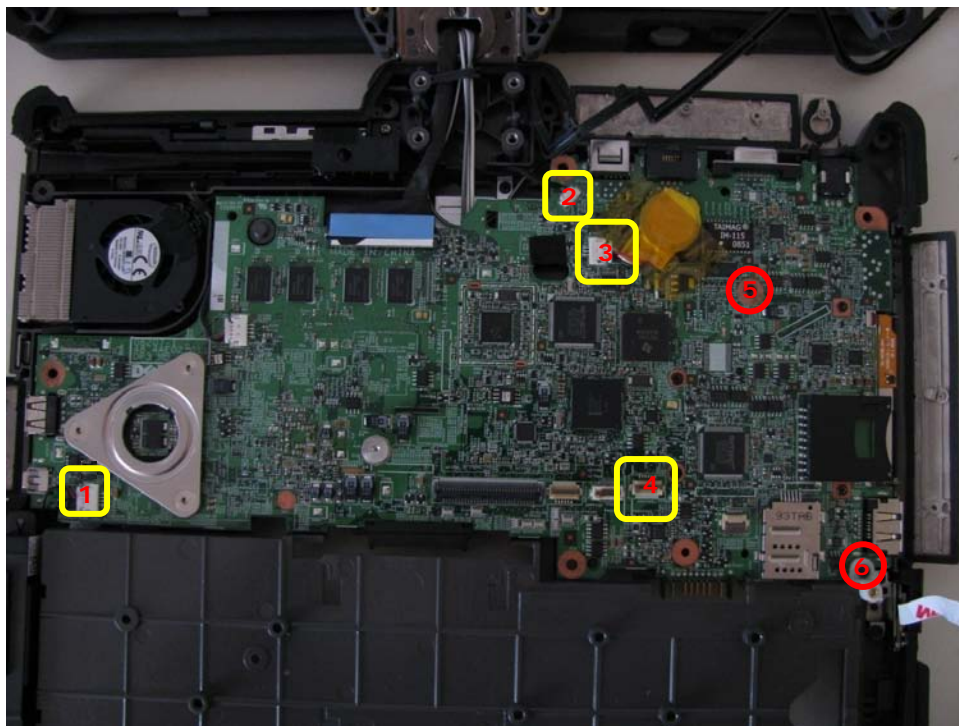

1	Speaker connection	2	Stylus connection
3	Coin-cell battery connection	4	WiFi sniffer connection



5	System board screw (2.5 x 5-mm)	6	System board screw at bracket (2.5 x 8-mm)
---	---------------------------------	---	--

4. Connect the sniffer switch cable to the system board.
5. Connect the stylus bay cable to the system board.
6. Connect the speaker to the system board.
7. Connect the video cable to the system board.
8. Connect the coin-cell battery to the system board.
9. Place the fan bay gasket back into the channel and press down as it's laid over to ensure a proper fit.

**CAUTION:** Make sure the gasket is set properly over the chassis and around the heat-sink and fan bay before proceeding. Failure to perform this step properly could cause an inlet for moisture into the system.

10. Complete the assembly by following instructions for [Installing the Palm Rest](#).

## 4.17 Heat Sink and Fan Assembly

**WARNING:** Before working inside your XT2 XFR, read the safety information that shipped with your XT2 XFR. For additional safety best practices information, see the Regulatory Compliance Homepage at [www.dell.com/regulatory\\_compliance](http://www.dell.com/regulatory_compliance).

### 4.17.1 Removing the Heat Sink and Fan Assembly



1. Follow the procedures in [Before Working Inside Your XT2 XFR](#).
2. Follow the procedures in [removing the palm rest](#) before continuing.
3. Follow the procedures in [Removing the system board](#) before continuing.
4. Disconnect the fan cable from the system board connector, then flip over the system board.

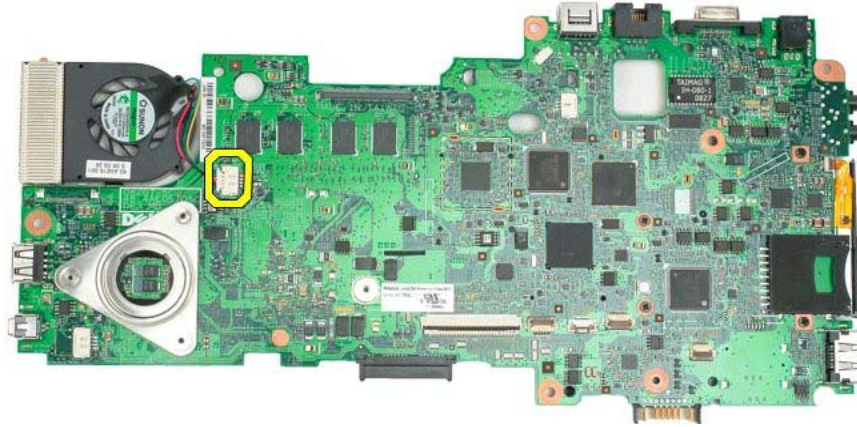

5. Loosen the four captive screws on the heat sink.

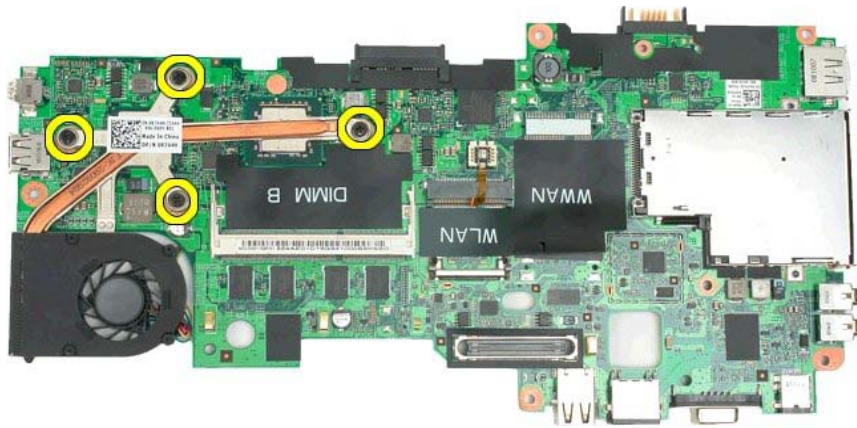

16. Remove the top section of the heat sink assembly from the system board, then turn over the system board again.

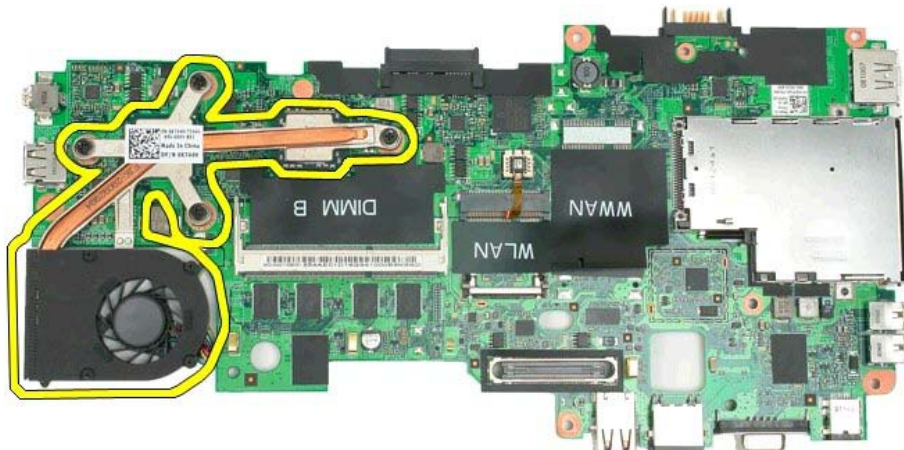

17. Remove the bottom section of the heat sink assembly.

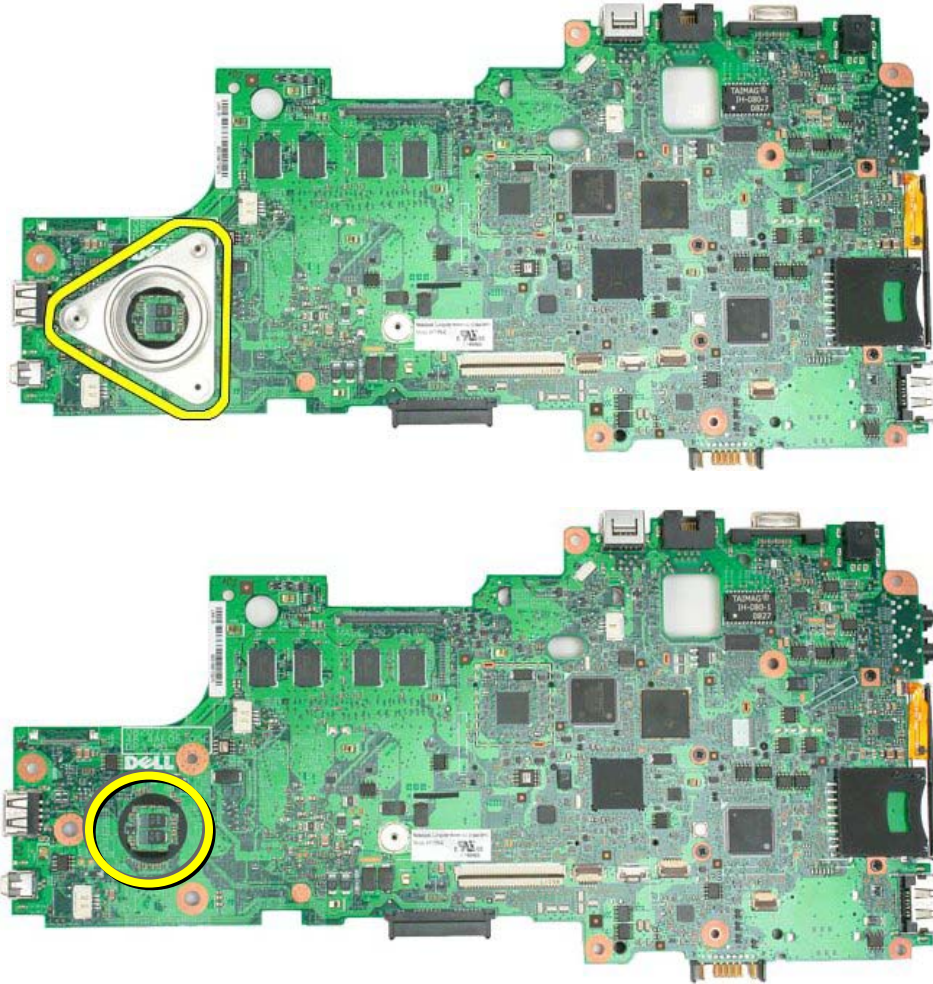

 **NOTE:** Make sure the insulator is attached to the system board prior to installation of the heat sink assembly. If this insulator is missing a replacement system board should be ordered.

## 4.18 Display Assembly

 **WARNING:** Before working inside your XT2 XFR, read the safety information that shipped with your XT2 XFR. For additional safety best practices information, see the Regulatory Compliance Homepage at [www.dell.com/regulatory\\_compliance](http://www.dell.com/regulatory_compliance).



## 4.18.1 Removing the Display Assembly



1. Follow the procedures in [Before Working Inside Your XT2 XFR](#).
2. Follow the procedures in [Removing the palm rest](#) before continuing.
3. From the inside of the XT2 XFR, disconnect the display cable from the system board.
4. Carefully lift the gasket surround from the fan housing area and lift the gasket from over the video/antenna cable socket.

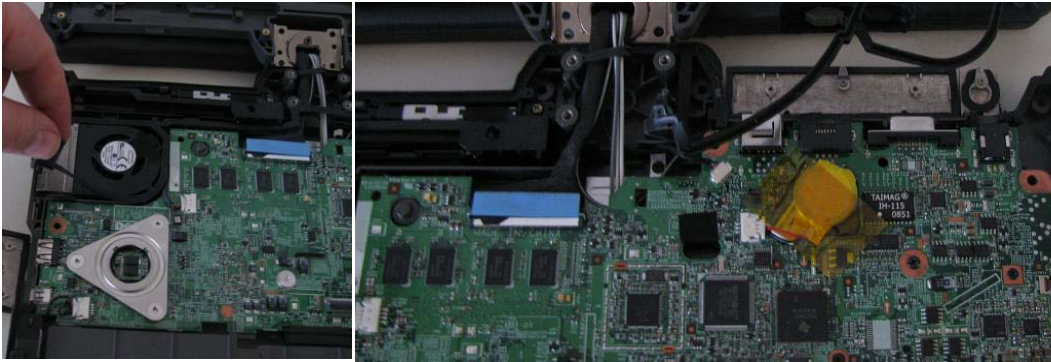

**⚠ WARNING:** Do NOT cut or remove the gasket material as this will cause the unit to not seal against water intrusion.

5. Follow the procedures in [Removing the system board](#) before continuing.
6. Remove the rear two Dock Door Screws along with the side screw and lightly loosen the front 2 screws to allow the cables to pull out of the retention tab on the dock door bracket.

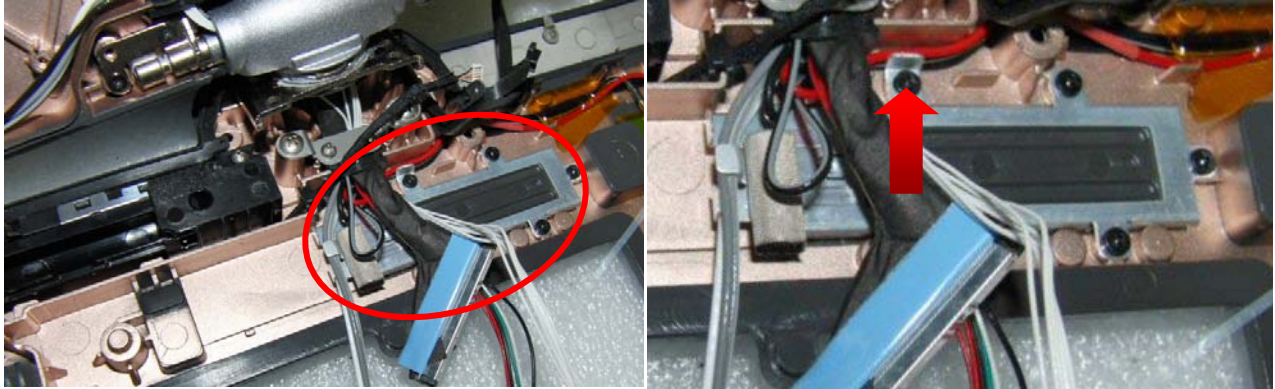

7. Remove the two (M2 x 3-mm) screws holding the RF Passthru board to the chassis and lift the RF passthru board up.



8. Disconnect the back Black/Grey, Red, and Black antenna cables from the RF Passthru board.
9. Lift the cables for the display assembly out of the chassis area and remove the display assembly.

#### 4.18.2 Installing the Display Assembly

1. Set the display assembly behind the system and pull all cables to align with the center of the chassis.
2. The black/grey, red, and black cables with the barrel connector on the ends connect onto the back side of the RF Passthru board. The RF Passthru board is labeled to assist with connecting the cables to the appropriate locations.



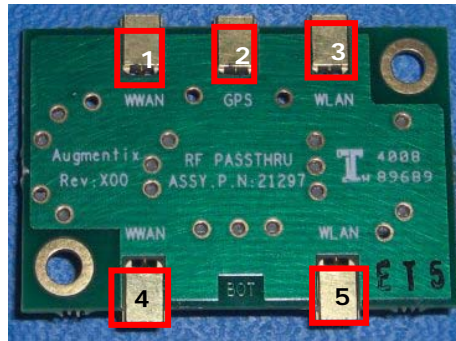

ID	PCB Reference	Wiring Color
1	WWAN – Back	Black / Grey
2	GPS – Back	Red
3	WLAN – Back	Black
4	WWAN – Front	Grey
5	WLAN - Front	Black

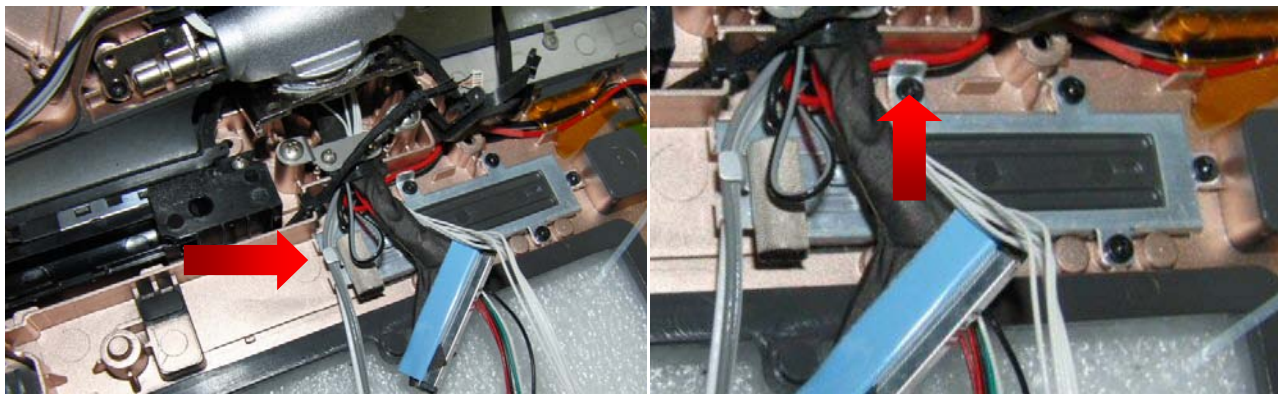

- Route the three cables under the tab for the docking door bracket, then install and tighten the five (M2 x 3-mm) screws for the docking door bracket.
- Place the RF Passthru board into place and tighten the two screws (M2 x 3-mm) securing it to the chassis.
- Route the black and grey cable from the front end of the RF Passthru so they sit under the retention tab and lay within the memory door opening.



6. Set the three antenna cables from the display assembly within the memory door opening.
7. Place the grommet surrounding the cables into the grommet chamber. Be sure the grommet is seated properly and hold in place.



8. Insert the cable bracket and install the two screws securing the bracket, cables and grommet in place. Release the grommet once this has been completed.

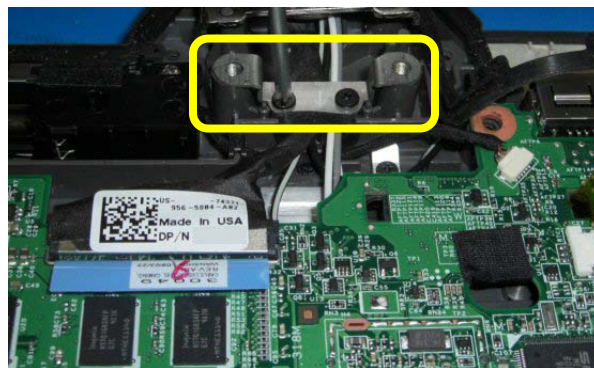

9. Perform the steps for [Installing the system board](#) before continuing.

10. Complete the assembly by performing [Installing the palm rest](#).

## 4.19 RF Passthru

### 4.19.1 Removing the RF Passthru Board

**⚠ WARNING:** Before working inside your XT2 XFR, read the safety information that shipped with your XT2 XFR. For additional safety best practices information, see the [Regulatory Compliance Homepage at www.dell.com/regulatory\\_compliance](http://www.dell.com/regulatory_compliance).

1. Follow the procedures in [Before Working Inside Your XT2 XFR](#).
2. Follow the procedures in [removing the palm rest](#) before continuing.
3. Follow the procedures in [Removing the system board](#) before continuing.
4. Remove the two (2.5 x 5-mm) screws holding the RF Passthru board onto the bottom chassis.



5. Remove the WWAN and WLAN RF Cables from the retaining tab.
6. Lift the RF Passthru board straight up to remove.

### 4.19.2 Installing the RF Passthru Board

1. Connect the Black/Grey, Red and Black antenna cables from the Display assembly to the RF Passthru board. The RF Passthru board barrel connectors are labeled for each cable.

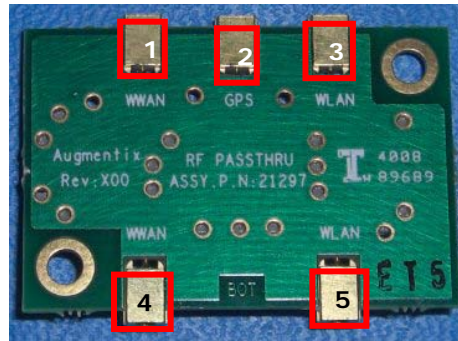

ID	PCB Reference	Wiring Color
1	WWAN – Back	Black / Grey
2	GPS – Back	Red
3	WLAN – Back	Black
4	WWAN – Front	Grey
5	WLAN - Front	Black

2. Set the RF Passthru board on the chassis, insert and tighten the two (2 x 3-mm) screws.
3. Connect the grey and black mini-card cables into the barrel connectors on the opposite side and run them under the retainer tab.

## 4.20 Rocker Switch

### 4.20.1 Remove the Rocker Switch

1. Remove the screw (M2 x 3-mm) from the center of the rocker switch.
2. Pull the rocker switch with your finger until it disengages from the rocker pin.

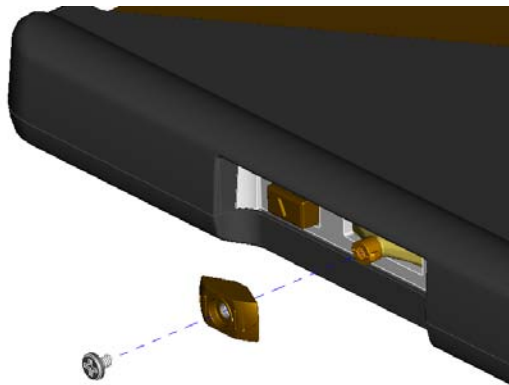

### 4.20.2 Install the Rocker Switch

1. Insert the rocker switch onto the rocker pin.
2. Secure the screw holding the rocker switch to the pin.



## 4.21 Doors

**⚠ WARNING:** Before working inside your XT2 XFR, read the safety information that shipped with your XT2 XFR. For additional safety best practices information, see the Regulatory Compliance Homepage at [www.dell.com/regulatory\\_compliance](http://www.dell.com/regulatory_compliance).

### 4.21.1 Removing the USB/1394 Door



1. Follow the procedures in [Before Working Inside Your XT2 XFR](#).
2. Remove the four (2.5 x 5-mm) screws from the door hinge connected to the bottom chassis.
3. Rotate the pull tab to release the lock and open the door to remove.

### 4.21.2 Removing the VGA/RJ45/USB Door



1. Follow the procedures in [Before Working Inside Your XT2 XFR](#).
2. Remove the four (2.5 x 5-mm) screws from the door hinge connected to the bottom chassis.
3. Rotate the pull tab to release the lock and open the door to remove.



### 4.21.3 Removing the Power Door



1. Follow the procedures in [Before Working Inside Your XT2 XFR](#).
2. Remove the two(2.5 x 5-mm) screws from the door hinge connected to the bottom chassis.
3. Rotate the pull tab to release the lock and open the door to remove.

### 4.21.4 Removing the Audio/Card Socket Door



1. Follow the procedures in [Before Working Inside Your XT2 XFR](#).
2. Remove the two(2.5 x 5-mm) screws from the door hinge connected to the bottom chassis.
3. Rotate the pull tab to release the lock and open the door to remove.

## 4.22 USB Module Bay Cover

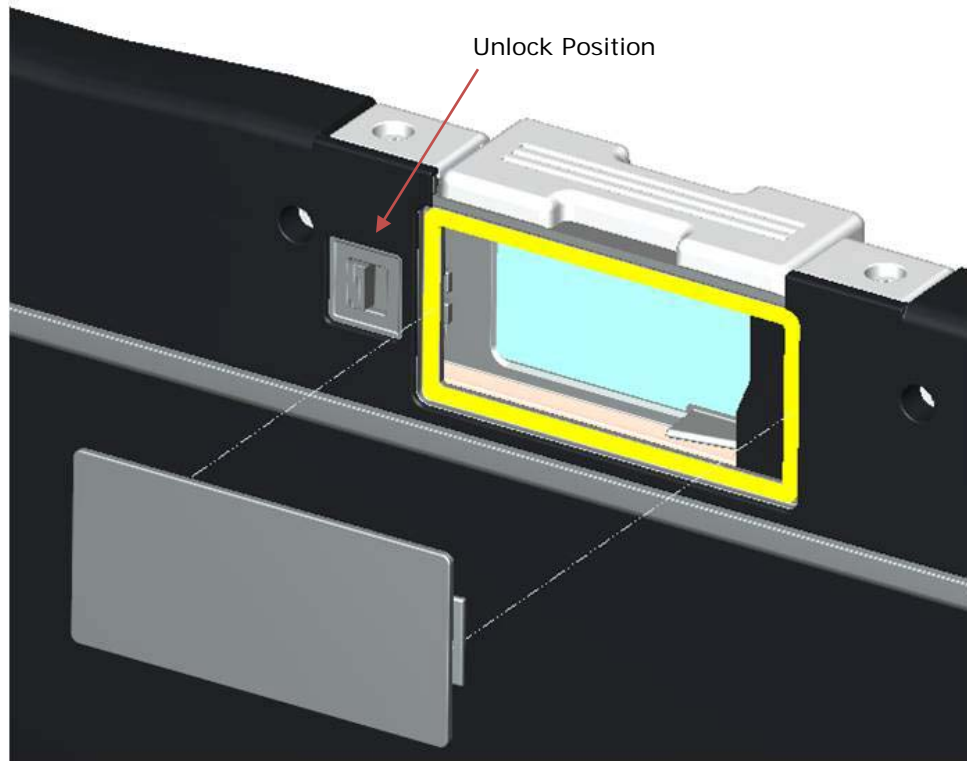

**⚠ WARNING:** Before working inside your XT2 XFR, read the safety information that shipped with your XT2 XFR. For additional safety best practices information, see the Regulatory Compliance Homepage at [www.dell.com/regulatory\\_compliance](http://www.dell.com/regulatory_compliance).

#### 4.22.1 Removing the USB Module Cover

1. Follow the procedures in [Before Working Inside Your XT2 XFR](#).
2. Remove the [battery](#) from the XT2 XFR.
3. Unlock the cover from the LCD bezel.
4. Remove the cover from the Hot Swappable Module bay.

### 4.23 GPS Module (OPTIONAL)

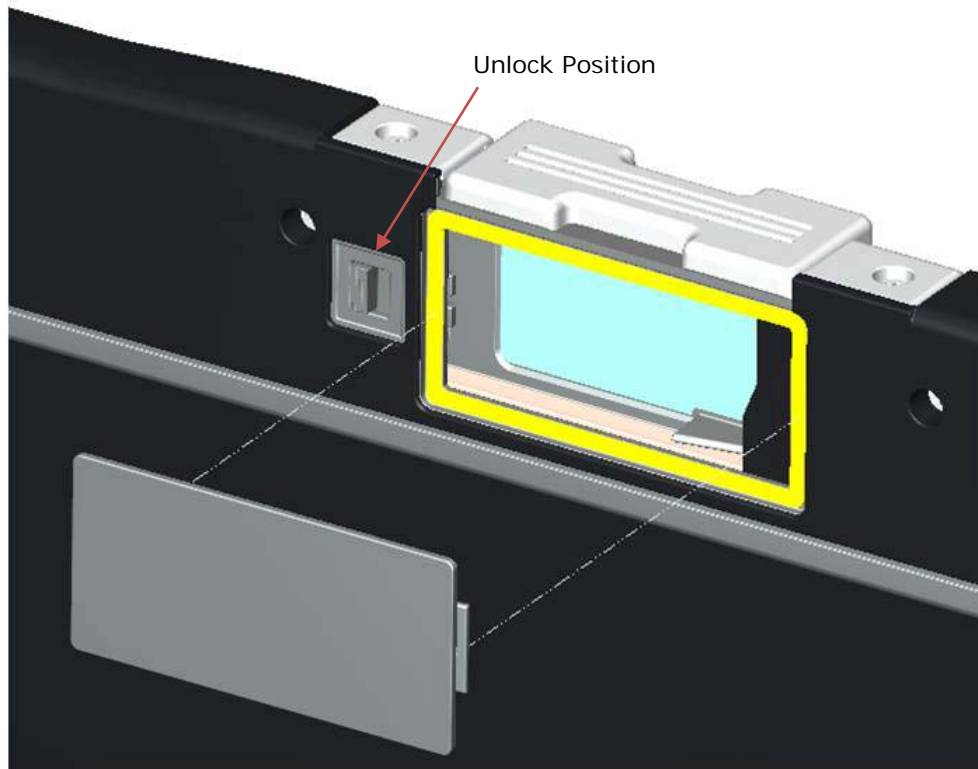

**⚠ WARNING:** Before working inside your XT2 XFR, read the safety information that shipped with your XT2 XFR. For additional safety best practices information, see the Regulatory Compliance Homepage at [www.dell.com/regulatory\\_compliance](http://www.dell.com/regulatory_compliance).

#### 4.23.1 Removing the GPS Module

1. Follow the procedures in [Before Working Inside Your XT2 XFR](#).
2. Remove the [battery](#) from the XT2 XFR.
3. Unlock the GPS from the LCD bezel.
4. Remove the GPS module from the Hot Swappable Module bay.

## 4.24 Camera Module (OPTIONAL)

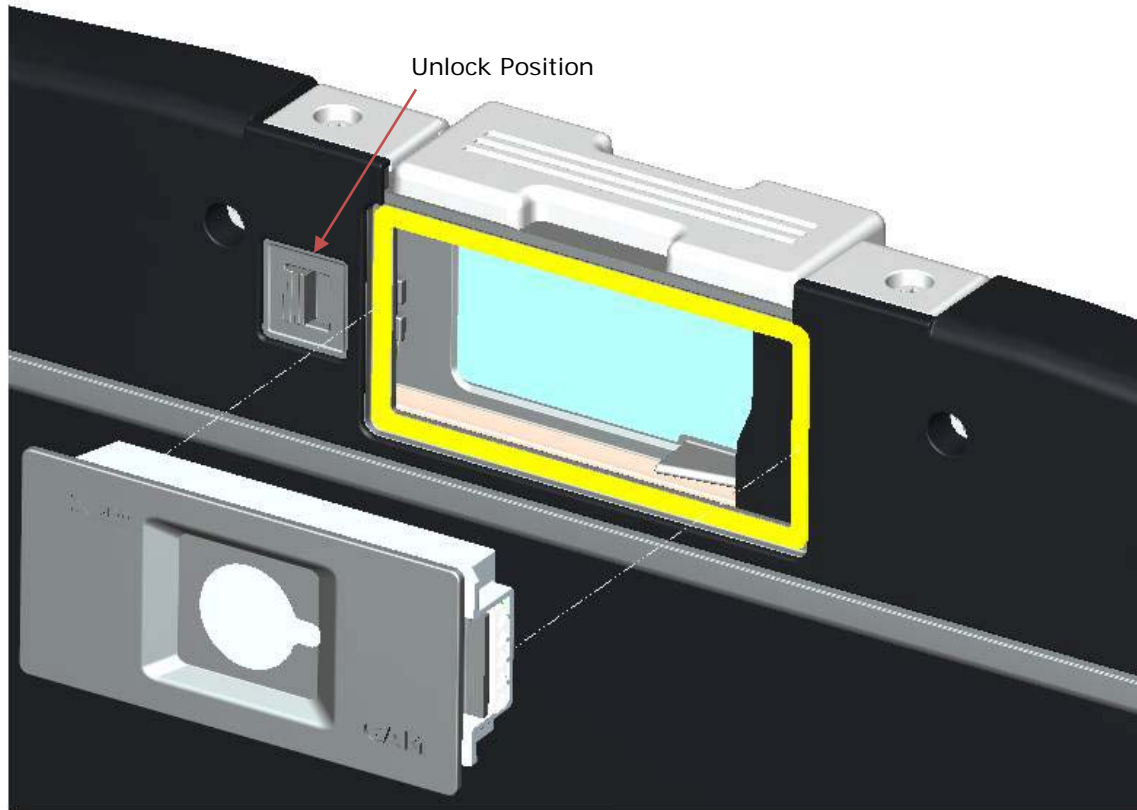



**⚠ WARNING:** Before working inside your XT2 XFR, read the safety information that shipped with your XT2 XFR. For additional safety best practices information, see the Regulatory Compliance Homepage at [www.dell.com/regulatory\\_compliance](http://www.dell.com/regulatory_compliance).

### 4.24.1 Removing the Camera Module

1. Follow the procedures in [Before Working Inside Your XT2 XFR](#).
2. Remove the [battery](#) from the XT2 XFR.
3. Unlock the camera from the LCD bezel.
4. Remove the GPS module from the Hot Swappable Module Bay.

## 5 Specifications

 **NOTE:** Offerings may vary by region. For more information regarding the configuration of your XT2 XFR, click **Start**  (or **Start** in Windows XP)→**Help and Support**, and then select the option to view information about your XT2 XFR.

<b>Processors</b>	Intel® Core™2 Duo ULV processor up to SU9600 (1.6GHz, 800 MHz FSB, 3 MB L2 Cache) with vPro technology
<b>Chipset</b>	Intel® Small Form Factor Montevina Chipset
<b>Graphics</b>	Intel Integrated Graphics Media Accelerator 4500MHD
<b>Audio</b>	1 Speaker, stereo headphone and line out jack, Mic
<b>Memory</b>	Up to 5GB DDR3 1066MHz (1 GB down + 1 slot)
<b>Storage</b>	HDD 160 GB 5400 RPM SATA SSD 64 GB Mobility, 128 GB FDE SSD
<b>Display</b>	12.1" WXGA DLV Outdoor-Readable (400 nits)
<b>Camera</b>	Optional (IP54-rated) integrated 2.0MP camera
<b>Ports</b>	1394, USB 2.0 (x2), USB 2.0/eSATA, VGA, RJ-45 , Audio, External Antenna Connection (RF pass thru)
<b>Expansion</b>	Express 54 (34 and 54mm support), SD Card slot
<b>Docking</b>	Vehicle Docking, Desktop Media Bay, Tri-Mode RF Pass-through
<b>ODD</b>	External E-Family modular media bay: 8X DVD-ROM, 24X CDRW/DVD, 8X DVD+/-RW, 2nd Hard Drive
<b>Battery</b>	4-cell 28W/Hr Li-Ion primary (standard) 6-cell 42W/Hr Li-Ion primary (optional)
<b>Ethernet</b>	10/100/1000 base-T Ethernet
<b>WLAN</b>	Up to Intel® WiFi® Link 5300 (802.11a/g/Draft n 3x3)
<b>WPAN</b>	Dell 365 Bluetooth® Module
<b>WWAN</b>	Dell Wireless 5720 EV-DOrA Mobile Broadband1 Minicard Dell Wireless 5530 HSUPA/HSDPA Mobile Broadband1 Minicard, GOBI
<b>GPS</b>	Optional GPS Receiver or 2.0MP Camera
<b>Security</b>	Dell ControlVault®, Dell ControlPoint Security ManagerCable lock slot, Integrated Smart Card Reader, Fingerprint Reader, Computrace Option, TPM 1.2
<b>Ergonomics</b>	12.2" x 9.6" x 1.49"
<b>Weight</b>	Starting at <5.5 lbs



## 6 Dell Diagnostics

 **CAUTION:** Before you begin any of the procedures in this section, follow the safety instructions that shipped with your computer.

### When to Use the Dell Diagnostics

If you experience a problem with your computer, perform the checks in [Solving Problems](#), and then run the Dell Diagnostics before contacting Dell for assistance.

Start the Dell Diagnostics from your hard drive or from the *Drivers and Utilities* media provided with your computer.

 **NOTE:** The *Drivers and Utilities* media is optional and may not ship with your computer.

 **NOTE:** The Dell Diagnostics only operate on Dell computers.

### Starting the Dell Diagnostics From Your Hard Drive

Before running the Dell Diagnostics, enter system setup to review your computer's configuration information, and ensure that the device you want to test is displayed in system setup and is active. For more information on using the system setup program, see the *Dell™ Technology Guide* on your computer or at [support.dell.com](http://support.dell.com).

The Dell Diagnostics is located on a separate diagnostic utility partition on your hard drive.

 **NOTE:** If the computer is connected to a docking device (docked), undock it. See the documentation that came with your docking device for instructions.

 **NOTE:** If your computer does not display a screen image, contact Dell Support.

1. Ensure that the computer is connected to an electrical outlet that is known to be working properly.
2. Press and hold the <Fn> key or the mute button then turn on your computer.

 **NOTE:** Alternatively, you can select **Diagnostics** from the one-time boot menu at startup to boot to the diagnostic utility partition and run the Dell Diagnostics.

The computer runs the Pre-boot System Assessment (PSA), a series of initial tests of your system board, keyboard, display, memory, hard drive, etc.

- During the assessment, answer any questions that appear.
- If failures are detected during the Pre-boot System Assessment, write down the error code(s) and contact Dell Support.
- If the Pre-boot System Assessment completes successfully, the following message appears: "Booting Dell Diagnostic Utility Partition. Press any key to continue."

 **NOTE:** If you see a message stating that no diagnostics utility partition has been found, run the Dell Diagnostics from your *Drivers and Utilities* media (see [Starting the Dell Diagnostics From the Drivers and Utilities Media](#)).

3. Press any key to start the Dell Diagnostics from the diagnostics utility partition on your hard drive.
4. Press <Tab> to select **Test System** and then press <Enter>.

 **NOTE:** It is recommended that you select **Test System** to run a complete test on your computer. Selecting **Test Memory** initiates the extended memory test which can take up to thirty minutes or more to complete. When the test completes, record the test results and then press any key to return to the previous menu.

5. At the Dell Diagnostics Main Menu, left-click with the touch pad/mouse, or press <Tab> and then <Enter>, to select the test you want to run (see [Dell Diagnostics Main Menu](#)).

 **NOTE:** Write down any error codes and problem descriptions exactly as they appear and follow the instructions on the screen.

6. After all tests have completed, close the test window to return to the Dell Diagnostics Main Menu.
7. Close the Main Menu window to exit the Dell Diagnostics and restart the computer.

 **NOTE:** If you see a message stating that no diagnostics utility partition has been found, run the Dell Diagnostics from your *Drivers and Utilities* media (see [Starting the Dell Diagnostics From the Drivers and Utilities Media](#)).

### Starting the Dell Diagnostics From the Drivers and Utilities Media

Before running the Dell Diagnostics, enter system setup to review your computer's configuration information, and ensure that the device you want to test is displayed in system setup and is active. For more information on using the system setup program, see the *Dell™ Technology Guide* on your computer or at [support.dell.com](http://support.dell.com).

1. Insert the *Drivers and Utilities* media into the optional external optical drive.
2. Restart your computer.
3. When the DELL logo appears, press <F12> immediately.

 **NOTE:** Keyboard failure may result when a key is held down for extended periods of time. To avoid possible keyboard failure, press and release <F12> in even intervals to open the Boot Device Menu.

If you wait too long and the operating system logo appears, continue to wait until you see the Microsoft Windows desktop, then shut down your computer and try again.

4. When the boot device list appears, use the up- and down-arrow keys to highlight **CD/DVD/CD-RW Drive**, and then press <Enter>.

 **NOTE:** Using the one-time boot menu changes the boot sequence for the current boot only. Upon restart, the computer boots according to the boot sequence specified in system setup.

5. Press any key to confirm that you want to start from the CD/DVD  
If you wait too long and the operating system logo appears, continue to wait until you see the Microsoft Windows desktop, then shut down your computer and try again.
6. Type 1 to **Run the 32 Bit Dell Diagnostics**.
7. At the Dell Diagnostics Menu, type 1 to select **Dell 32-bit Diagnostics for Resource CD (graphical user interface)**.
8. Press <Tab> to select **Test System** and then press <Enter>.

 **NOTE:** It is recommended that you select **Test System** to run a complete test on your computer. Selecting **Test Memory** initiates the extended memory test which can take up to

thirty minutes or more to complete. When the test completes, record the test results and then press any key to return to the previous menu.

9. At the Dell Diagnostics Main Menu, left-click with the touch pad/mouse, or press <Tab> and then <Enter>, to select the test you want to run (see [Dell Diagnostics Main Menu](#)).

 **NOTE:** Write down any error codes and problem descriptions exactly as they appear and follow the instructions on the screen.

10. After all tests have completed, close the test window to return to the Dell Diagnostics Main Menu.
11. Close the Main Menu window to exit the Dell Diagnostics and restart the computer.
12. Remove the *Drivers and Utilities* media from the optical drive.

## Dell Diagnostics Main Menu

After the Dell Diagnostics loads, the following menu appears:

Option	Function
Test Memory	Run the stand-alone memory test
Test System	Run system diagnostics
Exit	Exit the diagnostics

Press <Tab> to select the test you want to run and then press <Enter>.

 **NOTE:** It is recommended that you select **Test System** to run a complete test on your computer. Selecting **Test Memory** initiates the extended memory test which can take up to thirty minutes or more to complete. When the test completes, record the test results and then press any key to return to the previous menu.

After **Test System** is selected, the following menu appears:

Option	Function
Express Test	Performs a quick test of devices in the system. This typically can take 10 to 20 minutes.  <b>NOTE:</b> The <b>Express Test</b> requires no interaction on your part. Run <b>Express Test</b> first to increase the possibility of tracing a problem quickly.
Custom Test	Use to test a specific device or customize the tests to be run.
Symptom Tree	This option allows you to select tests based on a symptom of the problem you are having. This option lists the most common symptoms.

 **NOTE:** It is recommended that you select **Extended Test** to perform a more thorough check of devices in the computer.

For any problem encountered during a test, a message appears with an error code and a description of the problem. Write down the error code and problem description exactly as it appears and follow the instructions on the screen. If you cannot resolve the problem, contact Dell Support.



**NOTE:** When contacting Dell Support, have your Service Tag ready. The Service Tag for your computer is located at the top of each test screen.

The following tabs provide additional information for tests run from the Custom Test or Symptom Tree option:

Tab	Function
Results	Displays the results of the test and any error conditions encountered.
Errors	Displays error conditions encountered, error codes, and the problem description.
Help	Describes the test and any requirements for running the test.
Configuration	<p>Displays the hardware configuration for the selected device.</p> <p>The Dell Diagnostics obtains configuration information for all devices from System Setup, memory, and various internal tests, and displays the information in the device list in the left pane of the screen.</p> <p><b>NOTE:</b> The device list may not display the names of all components installed on your computer or all devices attached to your computer.</p>
Parameters	Allows you to customize the test, if applicable, by changing the test settings.

## 6.1.1 Error Messages



**CAUTION:** Before you begin any of the procedures in this section, follow the safety instructions that shipped with your computer.

If the error message is not listed, see the documentation for the operating system or the program that was running when the message appeared.

**A FILENAME CANNOT CONTAIN ANY OF THE FOLLOWING CHARACTERS: \ / : \* ? " < > | —** Do not use these characters in filenames.

**A REQUIRED .DLL FILE WAS NOT FOUND** — The program that you are trying to open is missing an essential file. To remove and then reinstall the program:

*Windows XP:*

1. Click **Start** → **Control Panel** → **Add or Remove Programs** → **Programs and Features**.
2. Select the program you want to remove.
3. Click **Uninstall**.
4. See the program documentation for installation instructions.

*Windows Vista:*

1. Click **Start**  → **Control Panel** → **Programs** → **Programs and Features**.
2. Select the program you want to remove.
3. Click **Uninstall**.
4. See the program documentation for installation instructions.

**drive letter :\\ IS NOT ACCESSIBLE. THE DEVICE IS NOT READY** — The drive cannot read the disk. Insert a disk into the drive and try again.

**INSERT BOOTABLE MEDIA** — Insert a bootable floppy disk, CD, or DVD.

**NON-SYSTEM DISK ERROR** — Remove the floppy disk from the floppy drive and restart your computer.

**NOT ENOUGH MEMORY OR RESOURCES. CLOSE SOME PROGRAMS AND TRY AGAIN** — Close all windows and open the program that you want to use. In some cases, you may have to restart your computer to restore computer resources. If so, run the program that you want to use first.

**OPERATING SYSTEM NOT FOUND** — Contact Dell Support.

## 6.2 Solving Problems

 **CAUTION:** Before you begin any of the procedures in this section, follow the safety instructions that shipped with your computer.

Follow these tips when troubleshooting your computer:

- If you added or removed a part before the problem started, review the installation procedures and ensure that the part is correctly installed.
- If a peripheral device does not work, ensure that the device is properly connected.
- If an error message appears on the screen, write down the exact message. This message may help support personnel diagnose and fix the problem(s).
- If an error message occurs in a program, see the program's documentation.

 **NOTE:** The procedures in this document were written for the Windows default view, so they may not apply if you set your Dell computer to the Windows Classic view.

### 6.2.1 Battery Problems

 **CAUTION:** There is a danger of a new battery exploding if it is incorrectly installed. Replace the battery only with the same or equivalent type recommended by the manufacturer. Discard used batteries according to the manufacturer's instructions.

### 6.2.2 Drive Problems

 **CAUTION:** Before you begin any of the procedures in this section, follow the safety instructions that shipped with your computer.

**ENSURE THAT MICROSOFT WINDOWS RECOGNIZES THE DRIVE** —

*Windows XP:*

- Click **Start** and click **My Computer**.

*Windows Vista:*

- Click the Windows Vista Start button  and click **Computer**.

If the drive is not listed, perform a full scan with your antivirus software to check for and remove viruses. Viruses can sometimes prevent Windows from recognizing the drive.



#### TEST THE DRIVE —

- Insert another disc to eliminate the possibility that the original drive is defective.
- Insert a bootable floppy disk and restart the computer.

**CLEAN THE DRIVE OR DISK** — For information on cleaning your computer, see the *Dell™ Technology Guide* on your computer or at [support.dell.com](http://support.dell.com).

#### CHECK THE CABLE CONNECTIONS

**RUN THE HARDWARE TROUBLESHOOTER** — See [Hardware Troubleshooter](#).

**RUN THE DELL DIAGNOSTICS** — See [Dell Diagnostics](#).

#### Optical Drive Problems



**NOTE:** High-speed optical drive vibration is normal and may cause noise, which does not indicate a defect in the drive or the media.



**NOTE:** Because of different regions worldwide and different disc formats, not all DVD titles work in all DVD drives.

#### ADJUST THE WINDOWS VOLUME CONTROL —

- Click the speaker icon in the lower-right corner of your screen.
- Ensure that the volume is turned up by clicking the slider and dragging it up.
- Ensure that the sound is not muted by clicking any boxes that are checked.

**CHECK THE SPEAKERS AND SUBWOOFER** — See [Sound and Speaker Problems](#).

#### Problems writing to an optical drive

**CLOSE OTHER PROGRAMS** — The optical drive must receive a steady stream of data during the writing process. If the stream is interrupted, an error occurs. Try closing all programs before you write to the optical.

**TURN OFF STANDBY MODE IN WINDOWS BEFORE WRITING TO A DISC** — For information about setting power options, see the *Dell™ Technology Guide* on your computer or at [support.dell.com](http://support.dell.com). You can also search for the keyword *standby* in Windows Help and Support for information on power management modes.

#### Hard Drive Problems

##### RUN CHECK DISK —

*Windows XP:*

1. Click **Start** and click **My Computer**.
2. Right-click **Local Disk C:**.
3. Click **Properties**→ **Tools**→ **Check Now**.
4. Click **Scan for and attempt recovery of bad sectors** and click **Start**.

*Windows Vista:*

1. Click **Start**  and click **Computer**.
2. Right-click **Local Disk C:**.
3. Click **Properties**→ **Tools**→ **Check Now**.  
The **User Account Control** window may appear. If you are an administrator on the computer, click **Continue**; otherwise, contact your administrator to continue the desired action.
4. Follow the instructions on the screen.

## 6.2.3 IEEE 1394 Device Problems

 **CAUTION:** Before you begin any of the procedures in this section, follow the safety instructions that shipped with your computer.

 **NOTE:** Your computer supports only IEEE 1394a standard.

**ENSURE THAT THE CABLE FOR THE IEEE 1394 DEVICE IS PROPERLY INSERTED INTO THE DEVICE AND INTO THE CONNECTOR ON THE COMPUTER**

**ENSURE THAT THE IEEE 1394 DEVICE IS ENABLED IN SYSTEM SETUP** — For more information on using the system setup program, see the *Dell™ Technology Guide* on your computer or at [support.dell.com](http://support.dell.com).

**ENSURE THAT THE IEEE 1394 DEVICE IS RECOGNIZED BY WINDOWS —**

*Windows XP:*

5. Click **Start** and click **Control Panel**.
6. Under **Pick a Category**, click **Performance and Maintenance** → **System** → **System Properties** → **Hardware** → **Device Manager**.

*Windows Vista:*

Click **Start**  → **Control Panel** → **Hardware and Sound**.

Click **Device Manager**. If your IEEE 1394 device is listed, Windows recognizes the device.

**IF YOU HAVE PROBLEMS WITH A DELL IEEE 1394 DEVICE** — Contact Dell Support.

**IF YOU HAVE PROBLEMS WITH AN IEEE 1394 DEVICE NOT PROVIDED BY DELL** — Contact the IEEE 1394 device manufacturer.

## 6.2.4 Lockups and Software Problems

 **CAUTION:** Before you begin any of the procedures in this section, follow the safety instructions that shipped with your computer.

**The Computer Does Not Start Up**

**CHECK THE DIAGNOSTIC LIGHTS** — See [Power Problems](#).

**ENSURE THAT THE POWER CABLE IS FIRMLY CONNECTED TO THE COMPUTER AND TO THE ELECTRICAL OUTLET**

**The computer stops responding**

 **NOTICE:** You may lose data if you are unable to perform an operating system shutdown.

**TURN THE COMPUTER OFF** — If you are unable to get a response by pressing a key on your keyboard or moving your mouse, press and hold the power button for at least 8 to 10 seconds (until the computer turns off), and then restart your computer.

**A Program Stops Responding**

**END THE PROGRAM** —

1. Press <Ctrl><Shift><Esc> simultaneously to access the Task Manager.
2. Click the **Applications** tab.
3. Click to select the program that is no longer responding.
4. Click **End Task**.

### A Program Crashes Repeatedly

 **NOTE:** Most software includes installation instructions in its documentation or on a floppy disk, CD, or DVD.

**CHECK THE SOFTWARE DOCUMENTATION** — If necessary, uninstall and then reinstall the program.

### A Program is Designed for an Earlier Windows Operating System

#### **RUN THE PROGRAM COMPATIBILITY WIZARD** —

##### *Windows XP:*

The Program Compatibility Wizard configures a program so that it runs in an environment similar to non-XP operating system environments.

1. Click **Start** → **All Programs** → **Accessories** → **Program Compatibility Wizard** → **Next**.
2. Follow the instructions on the screen.

##### *Windows Vista:*

The Program Compatibility Wizard configures a program so that it runs in an environment similar to non-Windows Vista operating system environments.

1. Click **Start**  → **Control Panel** → **Programs** → **Use an older program with this version of Windows**.
2. In the welcome screen, click **Next**.
3. Follow the instructions on the screen.

### A Solid Blue Screen Appears

**TURN THE COMPUTER OFF** — If you are unable to get a response by pressing a key on your keyboard or moving your mouse, press and hold the power button for at least 8 to 10 seconds (until the computer turns off), and then restart your computer.

### Other Software Problems

#### **CHECK THE SOFTWARE DOCUMENTATION OR CONTACT THE SOFTWARE MANUFACTURER FOR TROUBLESHOOTING INFORMATION** —

- Ensure that the program is compatible with the operating system installed on your computer.
- Ensure that your computer meets the minimum hardware requirements needed to run the software. See the software documentation for information.
- Ensure that the program is installed and configured properly.
- Verify that the device drivers do not conflict with the program.
- If necessary, uninstall and then reinstall the program.

#### **BACK UP YOUR FILES IMMEDIATELY**

#### **USE A VIRUS-SCANNING PROGRAM TO CHECK THE HARD DRIVE, FLOPPY DISKS, CDS, OR DVDS**

#### **SAVE AND CLOSE ANY OPEN FILES OR PROGRAMS AND SHUT DOWN YOUR COMPUTER THROUGH THE START MENU**

## 6.2.5 Memory Problems

 **CAUTION:** Before you begin any of the procedures in this section, follow the safety instructions that shipped with your computer.

#### **IF YOU RECEIVE AN INSUFFICIENT MEMORY MESSAGE** —

Save and close any open files and exit any open programs you are not using to see if that resolves the problem.

- See the software documentation for minimum memory requirements. If necessary, install additional memory (see [Replacing a Memory Module](#)).
- Reseat the memory modules (see [Memory](#)) to ensure that your computer is successfully communicating with the memory.
- Run the Dell Diagnostics (see [Dell Diagnostics](#)).

#### IF YOU EXPERIENCE OTHER MEMORY PROBLEMS —

- Reseat the memory modules (see [Memory](#)) to ensure that your computer is successfully communicating with the memory.
- Ensure that you are following the memory installation guidelines (see [Replacing a Memory Module](#)).
- Ensure that the memory you are using is supported by your computer. For more information about the type of memory supported by your computer, see the *Setup and Features Information Guide* for your computer at [support.dell.com](http://support.dell.com).
- Run the Dell Diagnostics (see [Dell Diagnostics](#)).

## 6.2.6 Power Problems



**CAUTION:** Before you begin any of the procedures in this section, follow the safety instructions that shipped with your computer.

**IF THE POWER LIGHT IS BLUE AND THE COMPUTER IS NOT RESPONDING** — See [Diagnostic Lights](#).

**IF THE POWER LIGHT IS OFF** — The computer is either turned off or is not receiving power.

- Reseat the power cable in the power connector on the back of the computer and the electrical outlet.
- Bypass power strips, power extension cables, and other power protection devices to verify that the computer turns on properly.
- Ensure that any power strips being used are plugged into an electrical outlet and are turned on.
- Ensure that the electrical outlet is working by testing it with another device, such as a lamp.

**ELIMINATE INTERFERENCE** — Some possible causes of interference are:

- Power, keyboard, and mouse extension cables
- Too many devices connected to the same power strip
- Multiple power strips connected to the same electrical outlet

## 6.2.7 Sound and Speaker Problems



**CAUTION:** Before you begin any of the procedures in this section, follow the safety instructions that shipped with your computer.



**NOTE:** The volume control in MP3 and other media players may override the Windows volume setting. Always check to ensure that the volume on the media player(s) has not been turned down or off.

**ADJUST THE WINDOWS VOLUME CONTROL** — Click or double-click the speaker icon in the lower-right corner of your screen. Ensure that the volume is turned up and that the sound is not muted.

**DISCONNECT HEADPHONES FROM THE HEADPHONE CONNECTOR** — Sound from the speakers is automatically disabled when headphones are connected to the computer's front-panel headphone connector.

**ELIMINATE POSSIBLE INTERFERENCE** — Turn off nearby fans, fluorescent lights, or halogen lamps to check for interference.

**RUN THE HARDWARE TROUBLESHOOTER** — See [Hardware Troubleshooter](#).

### No Sound From Headphones

**CHECK THE HEADPHONE CABLE CONNECTION** — Ensure that the headphone cable is securely inserted into the headphone connector. See the *Setup and Features Information Guide* for your computer at [support.dell.com](http://support.dell.com).

**ADJUST THE WINDOWS VOLUME CONTROL** — Click or double-click the speaker icon in the lower-right corner of your screen. Ensure that the volume is turned up and that the sound is not muted.

## 6.2.8 Video and Display Problems

 **CAUTION:** Before you begin any of the procedures in this section, follow the safety instructions that shipped with your computer.

 **NOTICE:** If your computer came with a PCI graphics card installed, removal of the card is not necessary when installing additional graphics cards; however, the card is required for troubleshooting purposes. If you remove the card, store it in a safe and secure location. For information about your graphics card, go to [support.dell.com](http://support.dell.com).

**CHECK THE DIAGNOSTIC LIGHTS** — See [Diagnostic Lights](#).

**CHECK THE DISPLAY SETTINGS** — See the *Dell™ Technology Guide* on your computer or at [support.dell.com](http://support.dell.com).

### ADJUST THE WINDOWS DISPLAY SETTINGS —

*Windows XP:*

1. Click **Start** → **Control Panel** → **Appearance and Themes**.
2. Click the area you want to change or click the **Display** icon.
3. Try different settings for **Color quality** and **Screen resolution**.

*Windows Vista:*

1. Click **Start**  → **Control Panel** → **Hardware and Sound** → **Personalization** → **Display Settings**.
2. Adjust **Resolution** and **Colors settings**, as needed.

### Only Part of the Display is Readable

#### CONNECT AN EXTERNAL MONITOR —

1. Shut down your computer and connect an external monitor to the computer.
2. Turn on the computer and the monitor and adjust the monitor brightness and contrast controls.

If the external monitor works, the computer display or video controller may be defective. Contact Dell Support.

## 6.3 Dell Technical Update Service

The Dell Technical Update service provides proactive e-mail notification of software and hardware updates for your computer. The service is free and can be customized for content, format, and how frequently you receive notifications.

To enroll for the Dell Technical Update service, go to [support.dell.com](http://support.dell.com).



## 6.4 Dell Support Utility

The Dell Support Utility is installed on your computer and available from the Dell Support, , icon on the taskbar or from the **Start** button. Use this support utility for self-support information, software updates, and health scans of your computing environment.

### Accessing the Dell Support Utility

Access the Dell Support Utility from the  icon on the taskbar or from the **Start** menu.

If the Dell Support icon does not appear in your taskbar:

1. Click **Start**→ **All Programs**→ **Dell Support**→ **Dell Support Settings**.
2. Ensure that the **Show icon on the taskbar** option is checked.

 **NOTE:** If the Dell Support Utility is not available from the Start menu, go to [support.dell.com](http://support.dell.com) and download the software.

The Dell Support Utility is customized for your computing environment. The  icon in the taskbar functions differently when you click, double-click, or right-click the icon.

### 6.4.1 Clicking the Dell Support Icon

Click or right-click the  icon to perform the following tasks:

- Check your computing environment.
- View the Dell Support Utility settings.
- Access the help file for the Dell Support Utility.
- View frequently asked questions.
- Learn more about the Dell Support Utility.
- Turn the Dell Support Utility off.

### 6.4.2 Double-Clicking the Dell Support Icon

Double-click the  icon to manually check your computing environment, view frequently asked questions, access the help file for the Dell Support Utility, and view Dell Support settings.

For more information about the Dell Support Utility, click the question mark (?) at the top of the **Dell™ Support** screen.

## 6.5 GPS Device

Follow the directions in the hot swappable modules section above to install the GPS device. Ensure the GPS device is properly seated and the lock is in the locked position.

### 6.5.1 GPS Hardware Configuration

It is important that you configure your computer's hardware settings properly to allow the GPS device to operate. The following instructions show the proper process to configuring a communications port for the GPS to operate in.

1. Click on the **Start** button and right-click on **Computer**; then click on **Properties**.
2. Click on **Device Manager**.

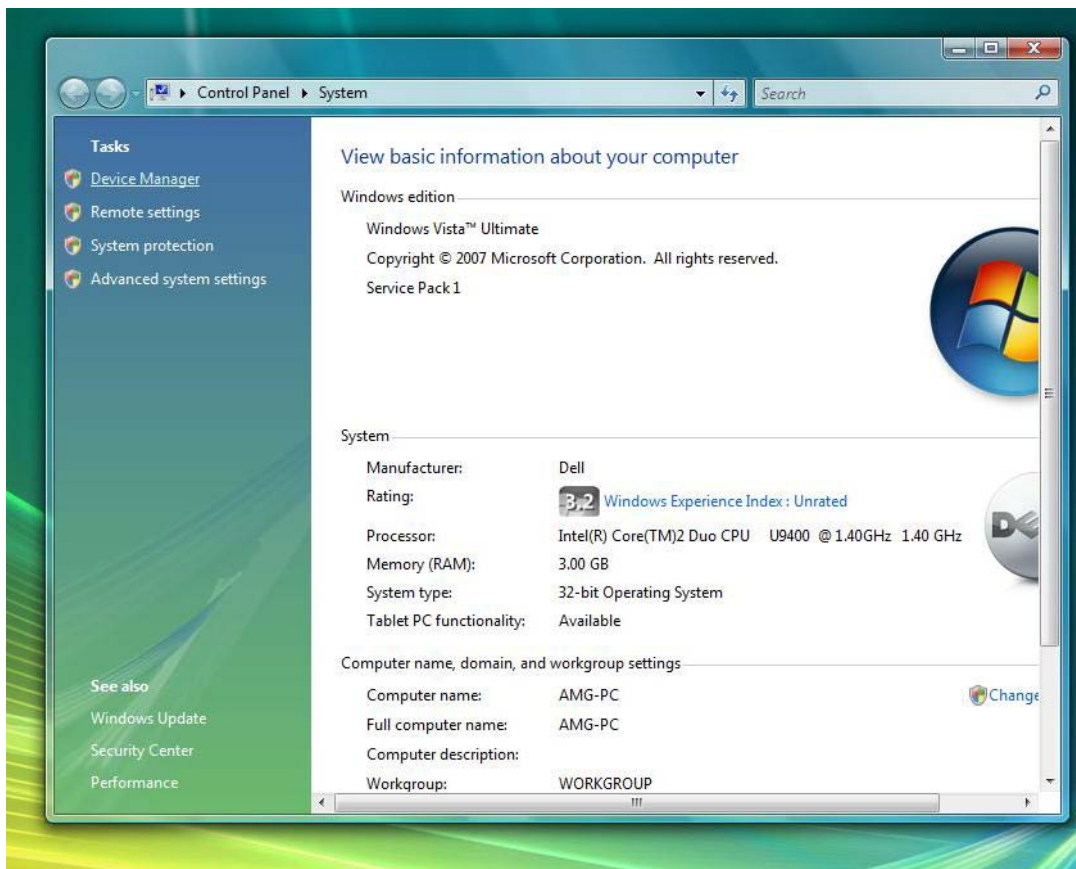

3. Double-click on **"Ports"**. Right-click on the **USB Serial Port (COM#)** device and select **Properties**.

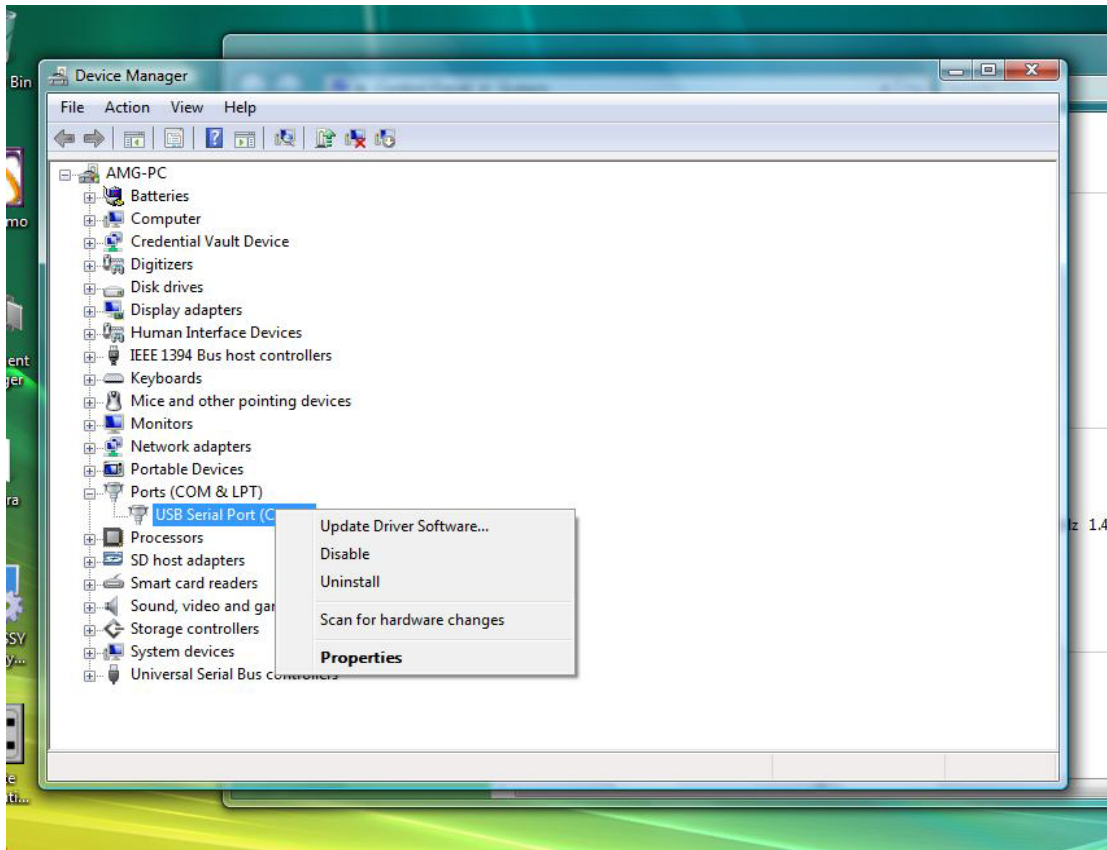

4. Select the **Port Settings** tab. Confirm that the following settings are assigned to each field shown below:

**Bits per second:** 4800

**Data bits:** 8

**Parity:** none

**Stop bits:** 1

**Flow control:** None

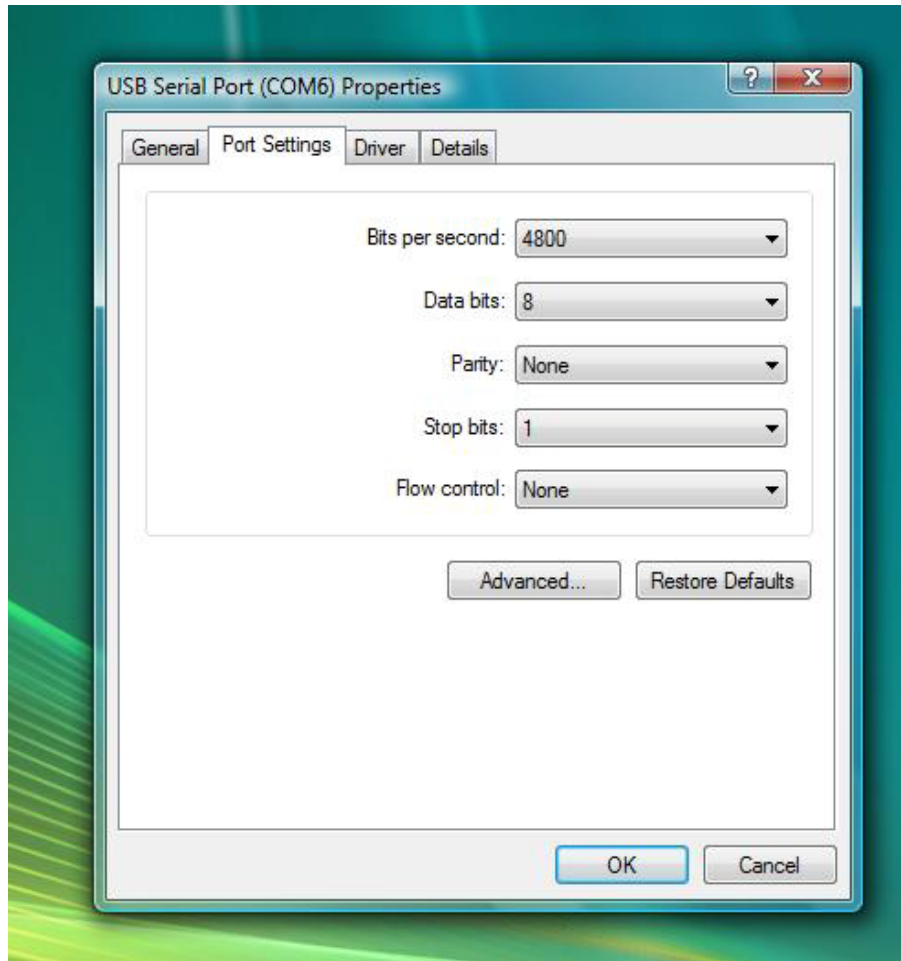

## 6.5.2 Software Configuration

There are many off the shelf and usage specific applications available that are compatible with this GPS module. Additional configuration may be required to allow the software to function with the GPS module. Please follow the instructions provided by your software manufacturer.

## 6.5.3 Diagnostics

Performing Dell Diagnostics on USB devices will locate the GPS as a connected device and run a ping test on the GPS installed. A pass indicates the GPS is installed and using the USB bus properly.

If the USB device test fails the GPS only, replace the GPS module. If the ping test does not recognize a GPS module is attached, a replacement USB hub board may be needed or the USB cable checked for proper connection. If no USB devices are present, replace the system board.

## 6.6 Camera

Follow the directions in the Hot Swappable Module Devices section above to install the Camera device. Ensure the camera is properly seated and the lock is in the locked position.

### 6.6.1 Camera Configuration Verification

If the camera is not working, or is working intermittently, use the following steps to verify the camera configuration.

1. Click on the **Start** button and right-click on **Computer**; then click on **Properties**.
2. Click on **Device Manager**.

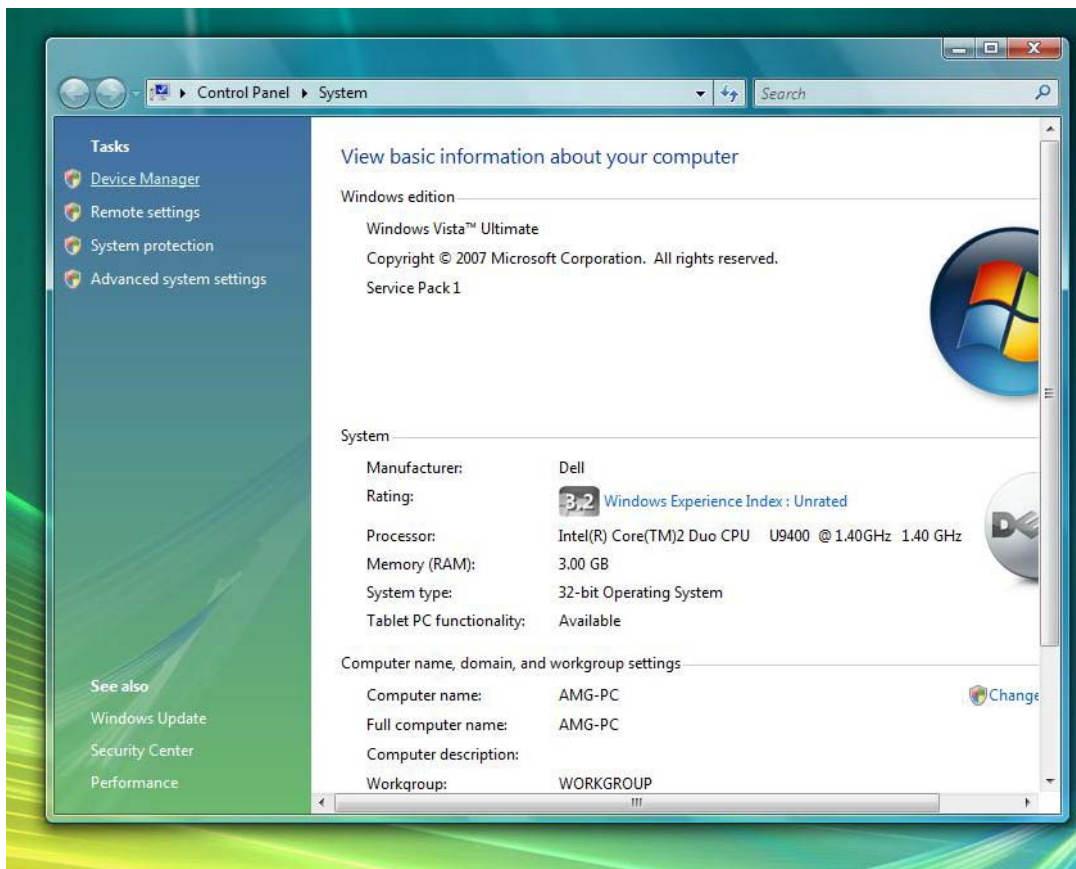



3. Double-click on **"Imaging Device"**, and locate **"USB UVC Webcam"**.

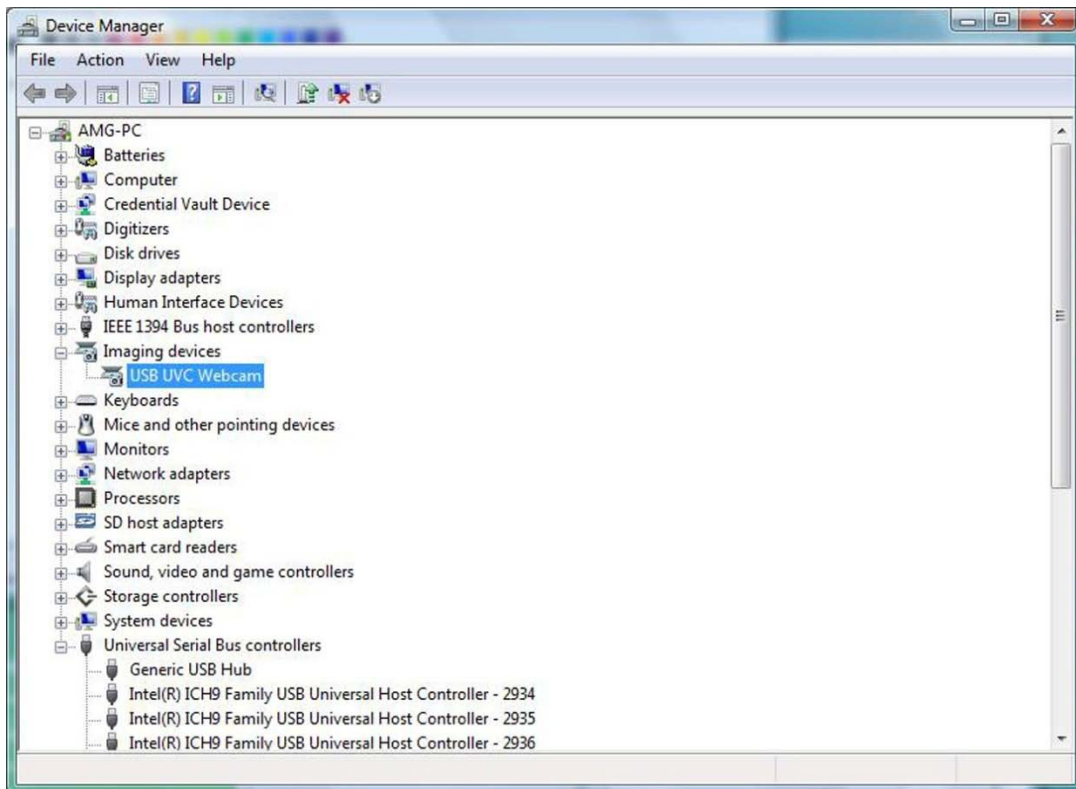

- a. If a 'Yellow Bang' appears on the device, then the drivers should be reinstalled.
  - b. If **"USB UVC Webcam"** is under **Device Manager**, but the camera is non-functional, locate the **"USB Composite Device"** and look at the **"General"** tab in the **"Properties"** for the **"USB Composite Device"**. If a **"Down Arrow"** appears over the USB icon for the device, then the device is installed but needs to be enabled.
4. Verify that the messaging application does not have the camera disabled or turned off.

## 6.6.2 Diagnostics

Performing Dell Diagnostics on USB devices will locate the camera as a connected device and run a ping test on the camera installed. A pass indicates the camera is installed and using the USB bus properly.

If the USB device test fails the Camera only, replace the Camera module. If the ping test does not recognize a Camera module is attached, a replacement USB hub board may be needed or the USB cable checked for proper connection. If no USB devices are present, replace the system board.

## 6.7 Device Status LEDs

Device status LEDs are a good source for diagnosing common problems that may occur on your XT2 XFR.



Turns on when you turn on the XT2 XFR and blinks when the XT2 XFR is in a power management mode.



Turns on when the XT2 XFR reads or writes data.



Turns on steadily or blinks to indicate battery charge status.



Turns on when wireless networking is enabled.



Turns on when a card with Bluetooth® wireless technology is enabled. To turn off only the Bluetooth wireless technology function, right-click the icon in the system tray and select **Disable Bluetooth Radio**.

### Battery Status

If the computer is connected to an electrical outlet, the battery light operates as follows:

- **Alternately blinking amber light and blue light** — An unauthenticated or unsupported, non-Dell AC adapter is attached to your XT2 XFR.
- **Alternately blinking amber light with steady blue light** — Temporary battery failure with AC adapter present.
- **Constantly blinking amber light** — Fatal battery failure with AC adapter present.
- **Light off** — Battery in full charge mode with AC adapter present.
- **Blue light on** — Battery in charge mode with AC adapter present.

### Battery Charge and Health

To check the battery charge, press and release the status button on the battery charge gauge to illuminate the charge-level lights. Each light represents approximately 20 percent of the total battery charge. For example, if four lights are on, the battery has 80 percent of its charge remaining. If no lights appear, the battery has no charge.

To check the battery health using the charge gauge, press and hold the status button on the battery charge gauge for at least 3 seconds. If no lights appear, the battery is in good condition and more than 80 percent of its original charge capacity remains. Each light represents incremental degradation. If five lights appear, less than 60 percent of the charge capacity remains, and you should consider replacing the battery.

## 6.8 Keyboard Status LEDs

The green lights located above the keyboard indicate the following:



Turns on when the numeric keypad is enabled.







Turns on when the Caps Lock function is enabled.



Turns on when the Scroll Lock function is enabled.

## 6.9 LED Error Codes

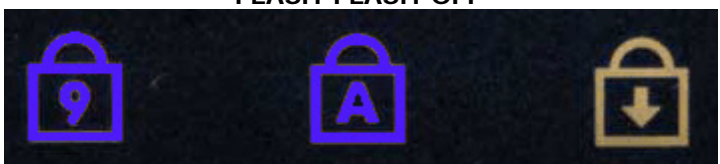
Appearance	Description	Next Step
<p style="text-align: center;"><b>ON-OFF-OFF</b></p>	No SODIMMs are installed	<ol style="list-style-type: none"> <li>1. Install supported memory modules.</li> <li>2. If memory is already present, reseal the module(s) one at time in each slot.</li> <li>3. Try known good memory from another computer or replace the memory.</li> <li>4. Replace the system board.</li> </ol>
<p style="text-align: center;"><b>FLASH-ON-ON</b></p>	System board error	<ol style="list-style-type: none"> <li>1. Reseat the processor.</li> <li>2. Replace the system board.</li> <li>3. Replace the processor.</li> </ol>
<p style="text-align: center;"><b>FLASH-ON-FLASH</b></p>	LCD Panel Error	<ol style="list-style-type: none"> <li>1. Reseat the LCD cable.</li> <li>2. Replace the LCD panel.</li> <li>3. Replace the video card / system board.</li> </ol>
<p style="text-align: center;"><b>OFF-FLASH-OFF</b></p>	Memory compatibility error	<ol style="list-style-type: none"> <li>1. Install compatible memory modules.</li> <li>2. If two modules are installed remove one and test. Try the other module in the same slot and test. Test the other slot with both modules.</li> <li>3. Replace the memory.</li> </ol>

		<ol style="list-style-type: none"> <li>4. Replace the system board.</li> </ol>
<p style="text-align: center;"><b>ON-FLASH-ON</b></p> 	<p>Memory is detected but has errors</p>	<ol style="list-style-type: none"> <li>1. Reseat the memory.</li> <li>2. If two modules are installed remove one and test. Try the other module in the same slot and test. Test the other slot with both modules.</li> <li>3. Replace the memory</li> <li>4. Replace the system board.</li> </ol>
<p style="text-align: center;"><b>OFF-FLASH-FLASH</b></p> 	<p>Modem Error</p>	<ol style="list-style-type: none"> <li>1. Reseat the modem.</li> <li>2. Replace the modem.</li> <li>3. Replace the system board.</li> </ol>
<p style="text-align: center;"><b>FLASH-FLASH-FLASH</b></p> 	<p>System board error</p>	<ol style="list-style-type: none"> <li>1. Replace the system board.</li> </ol>
<p style="text-align: center;"><b>FLASH-FLASH-OFF</b></p> 	<p>Option ROM Error</p>	<ol style="list-style-type: none"> <li>1. Reseat the device.</li> <li>2. Replace the device.</li> <li>3. Replace the system board.</li> </ol>
<p style="text-align: center;"><b>OFF-ON-OFF</b></p> 	<p>Storage device error</p>	<ol style="list-style-type: none"> <li>1. Reseat the hard drive and optical drive.</li> <li>2. Test the computer with just the hard drive and just the optical drive.</li> <li>3. Replace the device that is causing the failure.</li> <li>4. Replace the system board.</li> </ol>
<p style="text-align: center;"><b>OFF-ON-OFF</b></p> 	<p>Video card error</p>	<ol style="list-style-type: none"> <li>1. Replace the system board.</li> </ol>

## 7 System BIOS

Your XT2 XFR offers the following system BIOS options:

- Bring up a one-time boot menu by pressing <F12>
- Access the System Setup utility by pressing <F2>

### 7.1 BIOS Screen Navigation Keystrokes

Use the following keystrokes to navigate the BIOS screens.

Navigation Keystrokes	
Action	Keystroke
Expand and collapse field	<Enter>, left- and right-arrow keys, or +/-
Expand or collapse all fields	< >
Exit BIOS	<Esc> — Remain in Setup, Save/Exit, Discard/Exit
Change a setting	Left- and right-arrow keys
Select field to change	<Enter>
Cancel a modification	<Esc>
Reset defaults	<Alt><F> or <b>Load Defaults</b> menu option

 **NOTE:** Depending on your computer and any installed devices, the items listed in this section may or may not appear.

### 7.2 <F12> Menu

Press <F12> when the Dell™ logo appears to initiate a one-time boot menu with a list of the valid boot devices for the system. **Diagnostics** and **Enter Setup** options are also included in this menu. The devices listed on the boot menu depend on the bootable devices in the system. This menu is useful when you are attempting to boot to a particular device or to bring up the diagnostics for the system. Using the boot menu does not make any changes to the boot order stored in the BIOS.

#### Boot Menu

Your XT2 XFR features an enhanced one-time boot menu. The enhanced menu features the following improvements:

- **Easier access** — Access the menu by pressing <F12> during system boot.
- **User prompting** — The missing keystroke is now displayed on the BIOS splash screen.
- **Added diagnostics options** — The boot menu now includes two new options: **BIOS Setup** and **Diagnostics**.

### 7.3 Entering System Setup



Press <F2> to enter System Setup and change the user-definable settings. If you have trouble entering System Setup using this key, press <F2> when the keyboard LEDs first flash.

Follow the on-screen instructions to view and/or change any settings. On each screen, the system setup options are listed at the left. To the right of each option is the setting or value for that option. You can change settings that appear as white type on the screen. Options or values that you cannot change (because they are determined by your XT2 XFR) appear less bright.

The upper-right corner of the screen displays help information for the currently highlighted option. The lower-right corner displays information about the computer. System setup key functions are listed across the bottom of the screen.

The system setup screens display the current setup information and settings for your computer, such as:

- System configuration
- Boot order
- Boot (start-up) configuration
- Basic device configuration settings
- System security and hard drive password setting

## Free Manuals Download Website

<http://myh66.com>

<http://usermanuals.us>

<http://www.somanuals.com>

<http://www.4manuals.cc>

<http://www.manual-lib.com>

<http://www.404manual.com>

<http://www.luxmanual.com>

<http://aubethermostatmanual.com>

Golf course search by state

<http://golfingnear.com>

Email search by domain

<http://emailbydomain.com>

Auto manuals search

<http://auto.somanuals.com>

TV manuals search

<http://tv.somanuals.com>