

LifeStyle Series™

CALYPSO™ STROLLER

CALYPSO™ TRAVEL SYSTEM

Instruction Manual



**Do not use this product until
you read and understand
these instructions.**

English PM-1722AC 2/01

Century®

DEDICATED TO QUALITY

IMPORTANT INFORMATION

Table of Contents

Page:

1 Important Information

2 Warnings

3 Assembly

Opening Stroller

Rear Axle and Wheels

Swivel Locking Tabs

Front Wheel Assembly

Footrest

Rear Support Frame for Canopy

Cup Holder

5 Stroller Use

Locking Or Unlocking Rear Wheels

Locking Or Unlocking Front Wheel Swivels

Child's Tray Use

Closing Child's Tray Slot

Seat Back Positions

Canopy Positions

Securing Child With Harness

7 Car Seat/Stroller Use

Attaching Car Seat

Canopy Positions

Removing Car Seat

10 Folding

11 Maintenance

Cleaning Cup Holder

Cleaning Stroller

Dented Tires

12 Replacement Parts

Need Help?

If you should have any problems with this product, *call 1-800-837-4044 from anywhere in the U.S. or Canada or fax at 1-610-286-4555.*

Or write us at: Century Products
P.O. Box 100
Elverson, PA. 19520-9974
Attention: Customer Service Department

Please have the following information available. See label on stroller leg.

Model Number: _____

Manufacture Date: _____

Date of Purchase: _____

Safety First Checklist

- ✓ Read and understand stroller instruction manual before using stroller.
- ✓ Never leave child unattended.
- ✓ Use with only one (1) child at a time.
- ✓ Do not use accessories other than those provided by Century.

NOTE: All warnings and instructions apply whether stroller is being used with or without child's tray attached.

Weight and Height Limits

Stroller Use:

Maximum Weight: 40 lbs. (18.2 kg)

Maximum Height: 40 inches (101 cm)



WARNINGS

Failure to follow all warnings and instructions could result in serious injury or death.

- **Never leave child unattended, even when sleeping.**
 - **Child may become entangled in harness straps and suffocate.**
 - **Stroller may roll away and crash even with brakes engaged.**

- **Avoid serious injury from falling or sliding out. Always use seat belt.**

- **Always be sure stroller is fully set up and fold locks are engaged before using.**

- **DO NOT pull or carry stroller on stairs or escalators with child in it.**

- **DO NOT allow child to climb unassisted into stroller, play, hang or pull down on stroller handle as stroller may tip over.**

- **DO NOT hang or place anything on stroller handle or canopy. Stroller may become unstable and tip over.**

- **DO NOT jog with stroller. Push stroller at a normal walking speed only. Fast walking, jogging or running can cause loss of control.**

- **Always be sure child is clear of any moving parts when adjusting stroller.**

- **DO NOT overload basket. Maximum basket weight is 10 lbs. (4.5 kg). Stroller may become unstable and tip over.**

- **DO NOT use accessories other than those provided by Century.**

ASSEMBLY

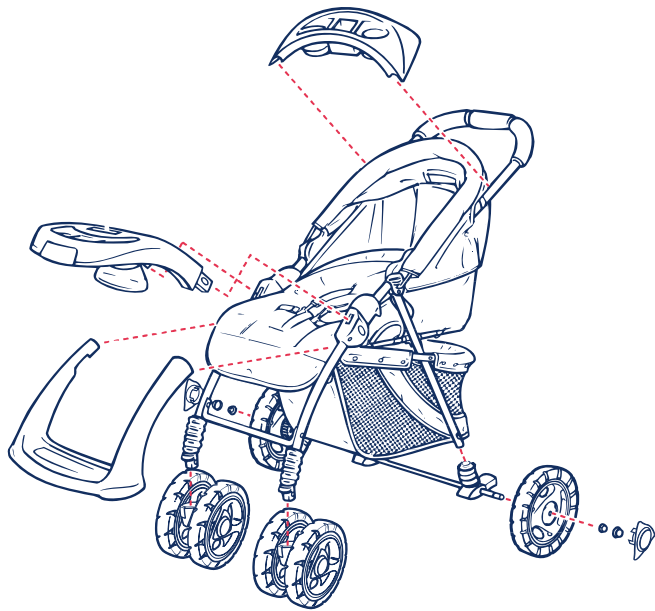

Opening Stroller

To open stroller:

- Stand stroller upright and pull out on **Red Frame Latch** while opening.

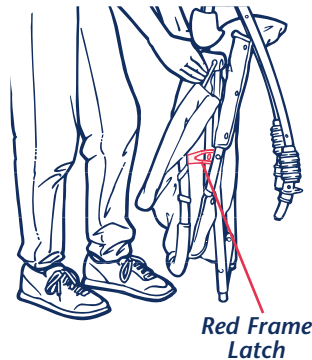

- Spread handle and rear legs until both **Fold Locks** "click" into position.



Rear Axle and Wheels

To attach rear axle and brakes:

- Remove axle protectors from ends of axle and discard.
- With stroller laying face down on floor, slide brake lever brackets onto rear legs until they "click" in place.



NOTE: Brake levers *must* face rear of stroller.

To attach wheels to rear axle:

- Slide **Wheel** onto end of **Axle** with brake ribs facing in.
- Push **Wheel Retainer** onto end of **Axle**. Make sure large end of **Wheel Retainer** is towards **Wheel**. **Wheel Retainer** should snap into groove on end of **Axle**.
- Snap wheel **Retainer Cap** over **Wheel Retainer**.
- Line up slot in **Hub Cap** with rib on **Wheel** and snap **Hub Cap** in place.

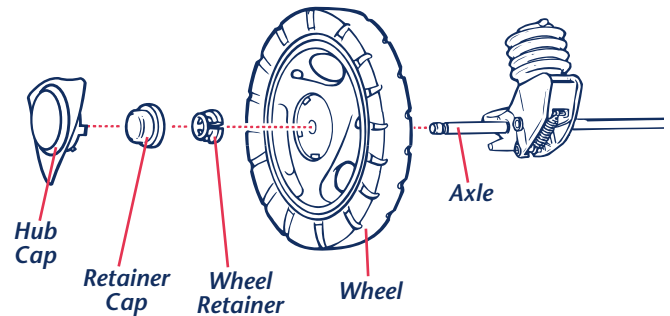

CAUTION:

- Failure to install retainer cap may cause wheels to come off of stroller.
- After wheel assembly is complete, pull on wheels to check that they are locked into place.



WARNING

Prevent a possible choking hazard, discard axle protectors and polybag which contained rear wheel parts.

ASSEMBLY continued

Swivel Locking Tabs

To attach swivel locking tabs:

- Pull **Bellow** away from swivel **Post** on front leg.
- Align grooves on **Locking Tab** with grooves on **Post**.
- Slide **Locking Tab** over **Post** until it snaps in place.

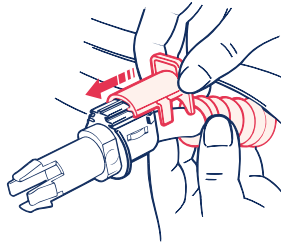

Repeat for opposite leg.

Front Wheel Assembly

To attach front wheel assembly:

- Hold wheel assembly upright.
- Tilt stroller slightly back and push wheel assembly onto leg until it **locks** in place.

Repeat for opposite leg.

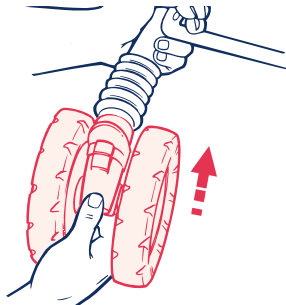

CAUTION: Pull on wheel assemblies to check that they are **locked** in place.

Footrest

To attach footrest:

- Snap footrest onto stroller frame and push up.

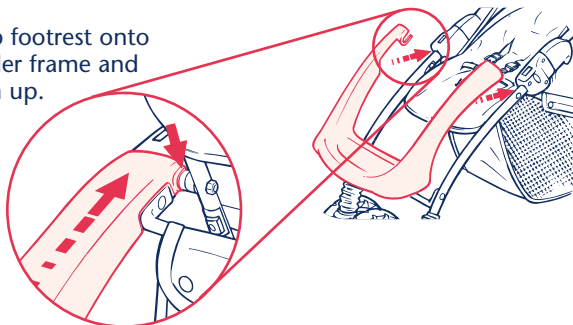

- Push footrest against legs, then slide footrest down until it snaps onto cross tube.

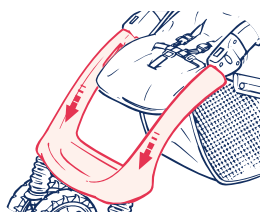

- Check to be sure tabs on bottom of footrest are snapped onto **Cross Tube**.

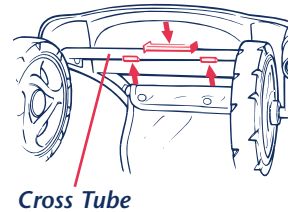

Rear Support Frame for Canopy

To secure rear support frame for canopy:

- Rotate canopy forward until it stops.

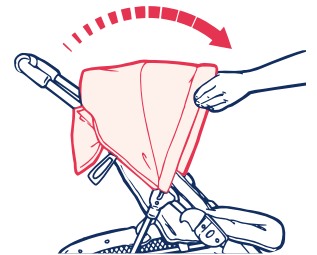

- Check to be sure **Rear Support Frame** is locked in place.

If **Rear Support Frame** is not locked, pull forward until it locks.

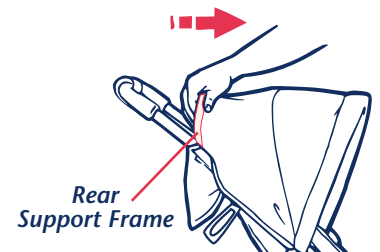

Cup Holder

To attach cup holder:

- Snap one end of cup holder over stroller frame above canopy.
- Rotate down to opposite side and snap in place.

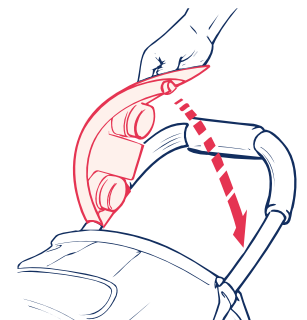

WARNING

- To avoid burns, never put hot liquids in cup holder.
- Avoid possible tipping, **DO NOT** place more than 3 lbs. (1.4 kg) in cup holder.

STROLLER USE

Locking Or Unlocking Rear Wheels

LOCKING:

Push down on both Brake Levers.

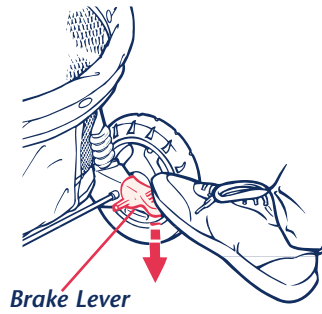

UNLOCKING:

Push up on both brake levers.

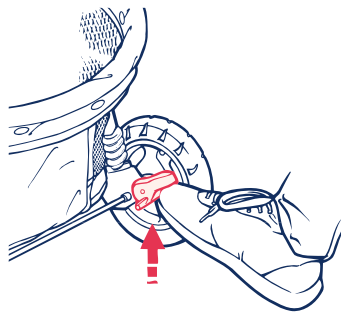

Locking Or Unlocking Front Wheel Swivels

LOCKING SWIVELS FOR ROUGH SURFACES: (straight tracking wheels)

Rotate both wheel assemblies until **Blocks** on wheel housings align with **Locking Tabs**, then push **Locking Tabs** down.

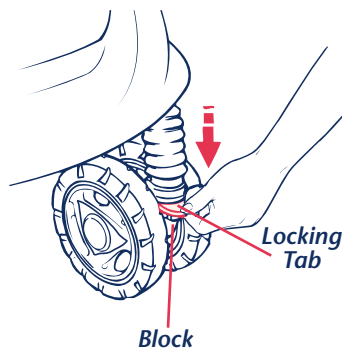

UNLOCKING SWIVELS FOR SMOOTH SURFACES: (swiveling wheels)

Push both locking tabs up so that wheel assemblies can swivel freely.

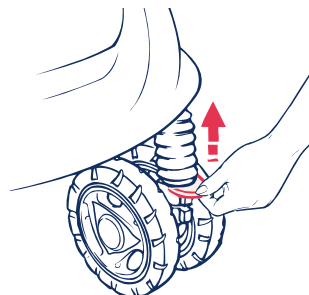

Child's Tray Use

Stroller may be used with or without child's tray.

To attach child's tray:

- Line up child's tray ends with slots in fold locks.
- Push child's tray into slots.
- Pull on child's tray to be sure it is securely **locked**.

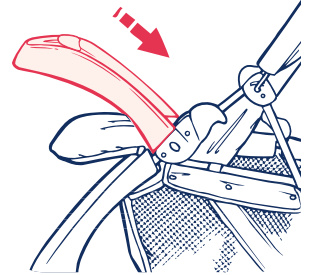

To remove child's tray:

- Press child's tray **Release Buttons** on sides of fold locks.
- Pull child's tray out of slots in fold locks.

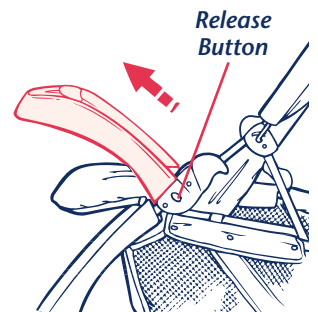

NOTE: When not using child's tray, store it where it will not be damaged.

Closing Child's Tray Slot

Be sure **Tongue** of child's tray pad is inserted into child's tray **Slot** when car seat is not attached.

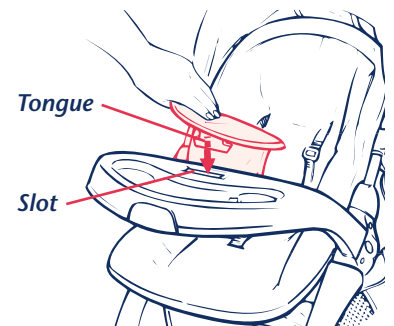

STROLLER USE continued

Seat Back Positions

Seat back has four (4) positions: upright, two (2) middle positions and recline.

To adjust seat back position:

- Push both seat back *Levers* inward.

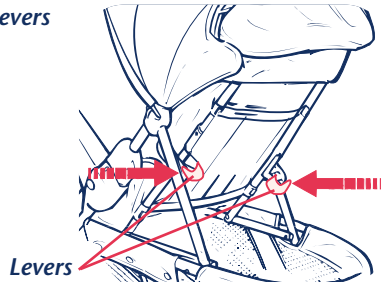

- Lower or raise seat back to desired position.

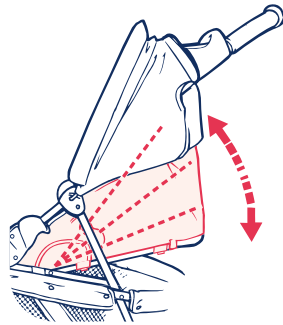

- Release *Levers*.

Canopy Positions

Canopy has two (2) positions: opened and closed.

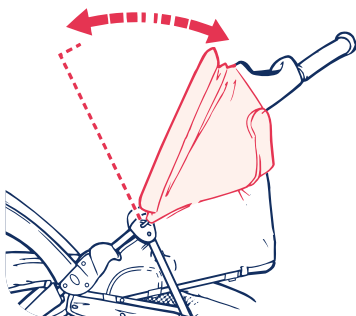

Securing Child With Harness



WARNING

Avoid serious injury from falling or sliding out:

- Always use shoulder, waist and crotch straps to restrain child, even when sleeping.
- To prevent child from standing or sliding out of stroller, be sure all straps are **SNUG** and do not slip loose.
- Periodically check all straps to be sure they are snug around child.

Secure child with harness system:

- Place child's arms through shoulder harness straps.
- Place waist straps around child's waist.
- Place crotch strap between child's legs.
- Snap *Buckle Tongues* into *Buckle*.
- Adjust length of shoulder, waist and crotch straps to snugly fit child.

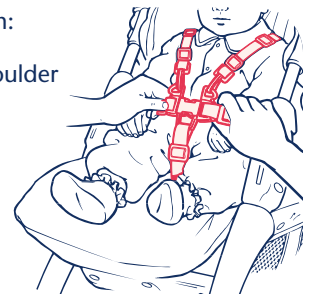

Adjust harness system:

- Adjust shoulder and crotch straps by pulling slider rings.

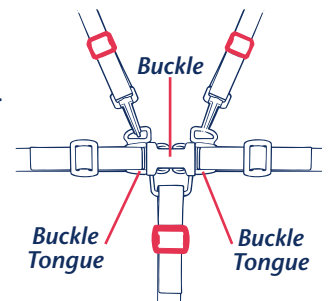

- Adjust length of waist straps by loosening or tightening as shown.

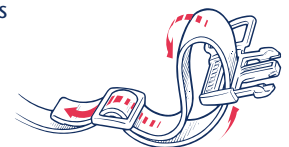

CAR SEAT/STROLLER USE

Car Seat included with some models.

Only a Century *Celestia* Infant Car Seat or *Avanta* Infant Car Seat (manufactured after January 1, 2001) is designed to attach to this stroller. If one of these car seats is not included with this stroller, one may be purchased separately at a retail store.

Safety First Checklist

- ✓ Call Century for updates of compatible car seat models for this stroller.
- ✓ **ONLY** use car seats recommended by Century with this stroller.
- ✓ Read and understand car seat instruction manual before using car seat in a vehicle.

Weight, Height and Activity Limits

Car Seat/Stroller Use:
Maximum Weight: 22 lbs. (10 kg)
Maximum Height: 29 inches (73.7 cm)

⚠ WARNING

Avoid serious injury from falling or sliding out:

- Always use car seat harness straps to restrain child, even when sleeping.
- Always be sure car seat handle is in locked upright carrying position when lifting or carrying child.
- Always be sure brakes are locked when attaching and removing car seat from stroller frame.
- Always be sure child's tray is fully inserted and locked into position before attaching car seat.
- Always be sure car seat is locked into child's tray and straps are attached to car seat before each use.
- **DO NOT** lift car seat/stroller unit by car seat handle or car seat shell. Handle may break.
- **DO NOT** allow child to hang or pull down on car seat handle as stroller may tip over.

Attaching Car Seat

- 1 Set rear brakes to prevent stroller from moving by pushing down on **both Brake Levers**.

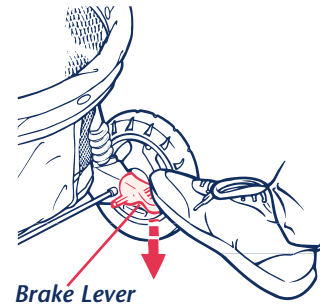

- 2 Attach child's tray:

- Line up child's tray ends with slots in fold locks.
- Push child's tray into slots.
- Pull on child's tray to be sure it is securely **locked**.

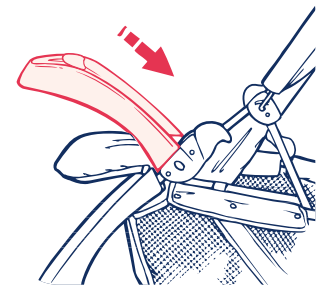

- 3 Remove **Tongue** of child's tray pad from child's tray **Slot**:

While pulling out on **Release Handle** on front of child's tray, pull up on child's tray pad.

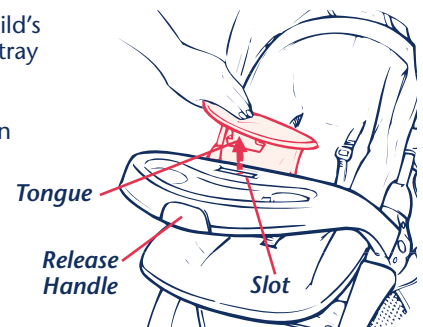

- 4 Position stroller seat back support in recline position:

Push both seat back **Levers** inward and fully lower seat back.

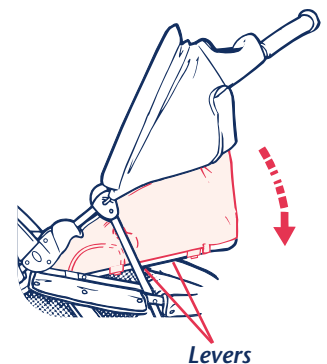

CAR SEAT/STROLLER USE continued

- 5 With car seat handle in *locked* carrying position (upright), insert car seat *Tongue* into child's tray *Slot*.

NOTE: Car seat may be placed in child's tray slot either rear-facing or forward-facing.

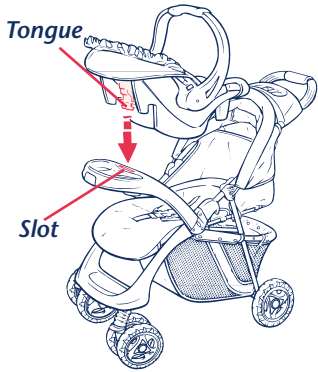

Rear-facing

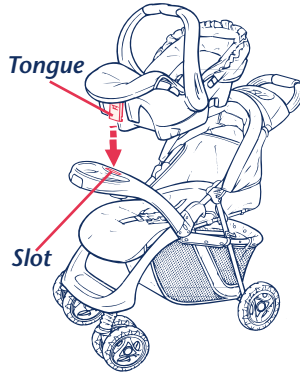

Forward-facing

CAUTION: Pull up on car seat to be sure it is *locked* in child's tray.

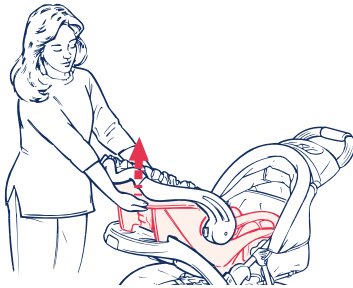

- 6 Attach *Snap* on *Red Strap* to car seat.

Repeat for opposite side.

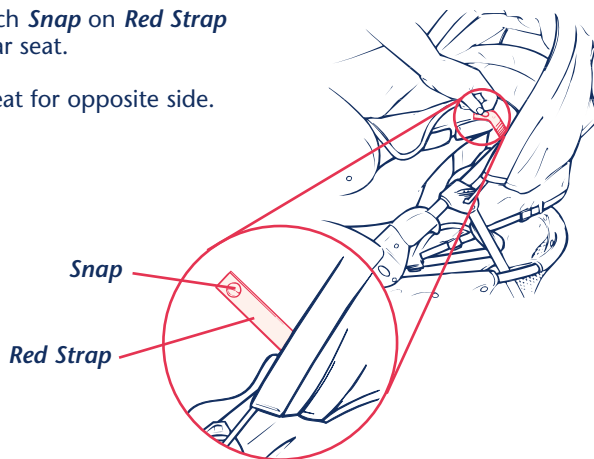

NOTE: Car seat level indicator is *not* applicable when car seat is attached to stroller.

Canopy Positions

Canopy has two (2) positions: opened and closed.

Car seat and stroller canopies can both be opened at the same time.

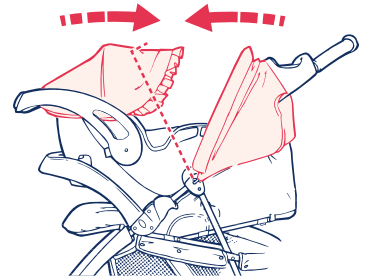

Removing Car Seat

- 1 Set rear brakes to prevent stroller from moving by pushing down on both brake levers.

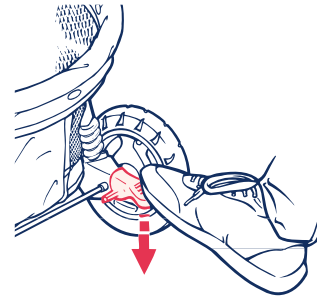

- 2 Move car seat handle to locked upright carrying position.

CAUTION: Be sure a "click" sound is heard and handle is locked.

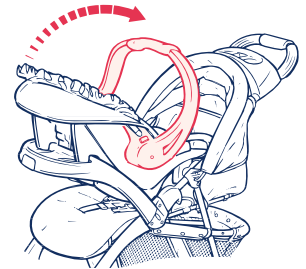

- 3 Unsnap both red straps from car seat.

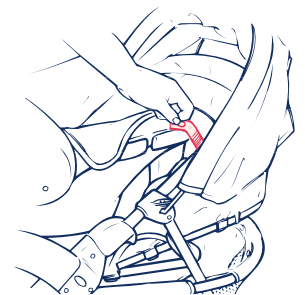

CAR SEAT/STROLLER USE continued

- 4 While pulling out on *Release Handle* on front of child's tray, lift car seat.

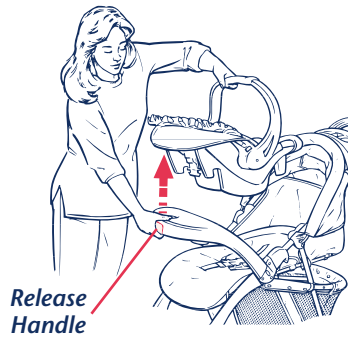

- 5 After removing car seat, insert *Tongue* of child's tray pad into child's tray *Slot*.

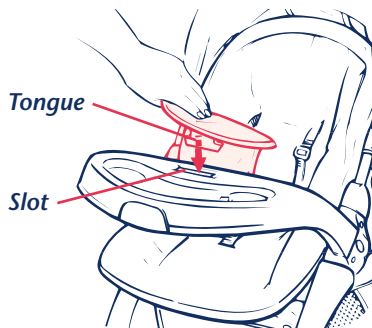

FOLDING

Folding Stroller

- 1 Set rear brakes to prevent stroller from moving by pushing down on both brake levers.

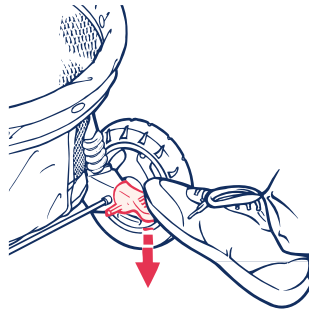

- 2 If car seat is attached to stroller, remove car seat. (See "Car Seat/Stroller Use".)

- 3 To prevent damage to child's tray, remove child's tray before folding stroller:

- Press child's tray **Release Buttons** on sides of fold locks.
- Pull child's tray out of slots in fold locks

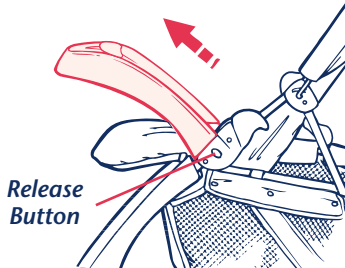

- 4 Fold stroller using either the **One-Hand Fold** or **Fold Locks**:

Folding using One-Hand Fold:

- Slide red button to right.
- Rotate **One-Hand Fold** towards rear of stroller.
- Push handle down until stroller completely folds.

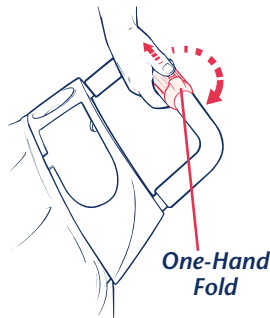

Folding using Fold Locks:

- Pull **Fold Locks** up on both sides then begin lifting stroller.
- Continue to lift stroller by **Fold Locks** until it completely folds.

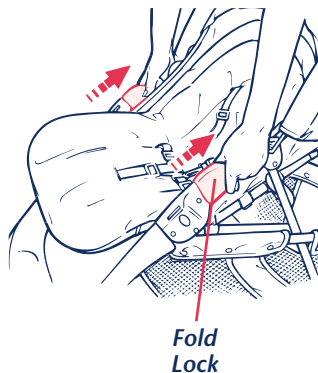

IMPORTANT:

- When folding stroller, turn stroller front wheels to straddle frame.

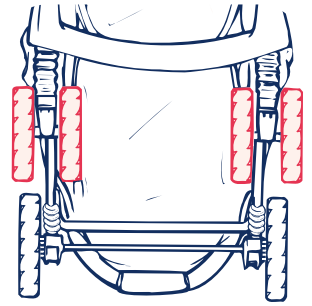

- **DO NOT** allow front wheels to rest on frame.

If wheels rest on frame, they may warp and not roll correctly.

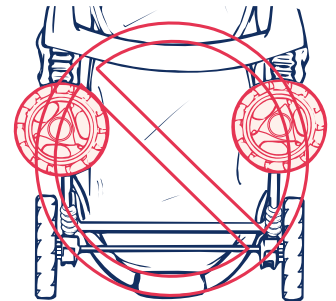

- 5 **Red Frame Latch** will engage automatically when stroller is completely folded.

Check to be sure **Red Frame Latch** is engaged to prevent stroller from opening.

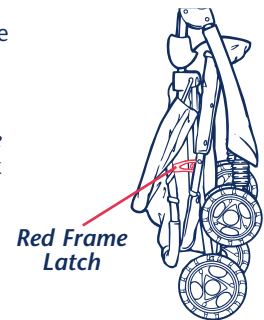

MAINTENANCE



WARNING

Avoid serious injury or death:

- **Periodically check anchoring straps beneath seat pad to ensure they are secured to frame.**
- **Periodically check and clean child's tray slot. If dirty, car seat adapter tongue will not latch properly. Remove loose objects, crumbs and any other debris from slot.**

Dented Tires

Sometimes tires become "dented" from shipment or from normal use. You may try the following procedure for repairing the dented tire before calling our Customer Service Department.

Blow warm air from hair dryer over dented area for 1 to 3 minutes.

Cleaning Cup Holder

To remove cup holder, pull one end up, rotate over to opposite side and pull other end up.

Wash cup holder in warm water and mild soap. **DO NOT** use abrasives, solvents, strong detergents, or household cleaners: they can scratch, discolor or weaken plastic.

DO NOT place in dishwasher.

Cleaning Stroller

Seat and Frame:

- Wipe fabric and frame with damp cloth and mild soap. **DO NOT** use abrasives, solvents, strong detergents, or household cleaners: they can scratch, discolor or weaken plastic.
- **DO NOT** machine wash or dry seat pads that have boards in them.

Comfort Pad:

- Machine wash in cold water, machine dry on cool setting to prevent shrinkage. **DO NOT** wash with other clothes.
- When replacing comfort pad, make sure shoulder, waist and crotch straps are rethreaded through slots in comfort pad.
- Loop front of comfort pad over leg rest and refasten attachment strips.

Child's Tray Slot:

- Clean child's tray slot with mild soap and water. **DO NOT** use abrasives, solvents, strong detergents, or household cleaners: they can scratch, discolor or weaken plastic.

REPLACEMENT PARTS

| Parts List (11-350 & 11-970) | Price | Quantity | Total |
|---|-------------|-----------|----------|
| A. Front Wheel Assembly  | US \$ 16.00 | x _____ = | \$ _____ |
| B. Rear Wheel Kit Including Retainer and Cap  | US \$ 8.00 | x _____ = | \$ _____ |
| C. Hub Cap Set (4)  | US \$ 5.00 | x _____ = | \$ _____ |
| D. Seat Pad  | US \$ 18.00 | x _____ = | \$ _____ |
| E. Comfort Pad  | US \$ 16.00 | x _____ = | \$ _____ |
| F. Canopy Pad with Window  | US \$ 15.00 | x _____ = | \$ _____ |
| G. Canopy Frame  | US \$ 8.00 | x _____ = | \$ _____ |
| H. Cup Holder  | US \$ 12.00 | x _____ = | \$ _____ |
| I. Basket  | US \$ 12.00 | x _____ = | \$ _____ |
| J. Child's Tray  | US \$ 12.00 | x _____ = | \$ _____ |
| K. Footrest  | US \$ 11.00 | x _____ = | \$ _____ |
| L. Instruction Manual  | FREE | x _____ = | FREE |

NOTE: Prices subject to change.

Total Parts \$ _____ **12**

REPLACEMENT PARTS ORDER FORM

Total Parts \$ _____
Sales Tax \$ _____
Shipping & Handling \$ _____
Outside Continental USA \$ _____
Total \$ _____

Sales Tax

- **California, Illinois, Indiana, Maryland and New York** Residents Add Sales & Applicable Local Taxes
- **Ohio** Residents Add 5.75% Sales Tax
- **Pennsylvania** Residents Add 6% Sales Tax except for **Philadelphia** and **Allegheny Counties** add 7% Sales Tax
- **South Carolina** Residents Add 5% Sales Tax

Shipping & Handling

\$ 0.01 to \$ 9.99 = \$ 3.00
\$ 10.00 and over = \$ 5.00

Outside Continental USA

Add \$10.00

We must have this information to process your order: see label on leg of stroller.

Model No.: _____

Manufacture Date: _____

Please make checks payable in U.S. currency to **CENTURY PRODUCTS** or charge to VISA, MASTERCARD or DISCOVER.

NOTE: If requested color is not available, a similar color will be substituted.

Orders outside USA **MUST** use credit card.

Cardholder's Name: _____

Card Number: _____

Card Exp. Date: _____

Check enclosed for \$ _____

SHIP TO:

Name: _____

Address: _____

City: _____

State: _____ Zip: _____

Telephone No.:(_____) _____

MAIL BOTH PAGES OF ORDER TO:

CENTURY PRODUCTS
P.O. BOX 100
ELVERSON, PA. 19520-9974
ATTENTION: CUSTOMER SERVICE DEPARTMENT
or

FAX BOTH PAGES OF ORDER TO:

(610) 286-4555



Visit us at our web site:
www.centuryproducts.com



Remember

We are here to help you!

**For immediate help, call our Customer Service
Department at 1-800-837-4044
from anywhere in the U.S. or Canada
or fax at 1-610-286-4555.**

Century Products
Graco Children's Products Inc.
A Division of Newell Rubbermaid
Macedonia, Ohio 44056-2096

Free Manuals Download Website

<http://myh66.com>

<http://usermanuals.us>

<http://www.somanuals.com>

<http://www.4manuals.cc>

<http://www.manual-lib.com>

<http://www.404manual.com>

<http://www.luxmanual.com>

<http://aubethermostatmanual.com>

Golf course search by state

<http://golfingnear.com>

Email search by domain

<http://emailbydomain.com>

Auto manuals search

<http://auto.somanuals.com>

TV manuals search

<http://tv.somanuals.com>