

LK-210 ***LK-215***

USER'S GUIDE
GUÍA DEL USUARIO



LK210/215ES1C

CASIO®

GUIDELINES LAID DOWN BY FCC RULES FOR USE OF THE UNIT IN THE U.S.A. (not applicable to other areas).

NOTICE

This equipment has been tested and found to comply with the limits for a Class B digital device, pursuant to Part 15 of the FCC Rules. These limits are designed to provide reasonable protection against harmful interference in a residential installation. This equipment generates, uses and can radiate radio frequency energy and, if not installed and used in accordance with the instructions, may cause harmful interference to radio communications. However, there is no guarantee that interference will not occur in a particular installation. If this equipment does cause harmful interference to radio or television reception, which can be determined by turning the equipment off and on, the user is encouraged to try to correct the interference by one or more of the following measures:

- Reorient or relocate the receiving antenna.
- Increase the separation between the equipment and receiver.
- Connect the equipment into an outlet on a circuit different from that to which the receiver is connected.
- Consult the dealer or an experienced radio/TV technician for help.

FCC WARNING

Changes or modifications not expressly approved by the party responsible for compliance could void the user's authority to operate the equipment.

Declaration of Conformity

Model Number: LK-210/LK-215

Trade Name: CASIO COMPUTER CO., LTD.

Responsible party: CASIO AMERICA, INC.

Address: 570 MT. PLEASANT AVENUE, DOVER, NEW JERSEY 07801

Telephone number: 973-361-5400

This device complies with Part 15 of the FCC Rules. Operation is subject to the following two conditions:

(1) This device may not cause harmful interference, and (2) this device must accept any interference received, including interference that may cause undesired operation.

Important!

Please note the following important information before using this product.

- Before using the optional AD-5 Adaptor to power the unit, be sure to check the AC Adaptor for any damage first. Carefully check the power cord for breakage, cuts, exposed wire and other serious damage. Never let children use an AC adaptor that is seriously damaged.
- Never attempt to recharge batteries.
- Do not use rechargeable batteries.
- Never mix old batteries with new ones.
- Use recommended batteries or equivalent types.
- Always make sure that positive (+) and negative (-) poles are facing correctly as indicated near the battery compartment.
- Replace batteries as soon as possible after any sign they are getting weak.
- Do not short-circuit the battery terminals.
- The product is not intended for children under 3 years.
- Use only CASIO AD-5 adaptor.
- The AC adaptor is not a toy.
- Be sure to disconnect the AC adaptor before cleaning the product.



This mark applies in EU countries only.



Manufacturer:
CASIO COMPUTER CO.,LTD.
6-2, Hon-machi 1-chome, Shibuya-ku, Tokyo 151-8543, Japan
Responsible within the European Union:
CASIO EUROPE GmbH
Casio-Platz 1, 22848 Norderstedt, Germany

Safety Precautions

Congratulations on your selection of the CASIO electronic musical instrument.

- Before using the instrument, be sure to carefully read through the instructions contained in this manual.
- Be sure to keep all user documentation handy for future reference.

Symbols

Various symbols are used in this user's guide and on the product itself to ensure that the product is used safely and correctly, and to prevent injury to the user and other persons as well as damage to property. Those symbols along with their meanings are shown below.

DANGER

This symbol indicates information that, if ignored or applied incorrectly, creates the danger of death or serious personal injury.

WARNING

This indication stipulates matters that have the risk of causing death or serious injury if the product is operated incorrectly while ignoring this indication.

CAUTION

This indication stipulates matters that have the risk of causing injury as well as matters for which there is the likelihood of occurrence of physical damage only if the product is operated incorrectly while ignoring this indication.

Symbol Examples



This triangle symbol (\triangle) means that the user should be careful. (The example at left indicates electrical shock caution.)



This circle with a line through it (\odot) means that the indicated action must not be performed. Indications within or nearby this symbol are specifically prohibited. (The example at left indicates that disassembly is prohibited.)



The black dot (\bullet) means that the indicated action must be performed. Indications within this symbol are actions that are specifically instructed to be performed. (The example at left indicates that the power plug must be unplugged from the electrical socket.)

DANGER

Alkaline Batteries

Perform the following steps immediately if fluid leaking from alkaline batteries ever gets into your eyes. 

1. Do not rub your eyes! Rinse them with water.
 2. Contact your physician immediately.
- Leaving alkaline battery fluid in your eyes can lead to loss of sight.





WARNING



Smoke, Strange Odor, Overheating

Continued use of the product while it is emitting smoke, a strange odor, or heat creates the risk of fire and electric shock. Take the following steps immediately.

1. Turn off power.
2. If you are using the AC adaptor for power, unplug it from the wall outlet.
3. Contact your original retailer or an authorized CASIO Service Provider.

AC Adaptor

- Misuse of the AC adaptor creates the risk of fire and electric shock. Always make sure you observe the following precautions.
 - Be sure to use only the AC adaptor that is specified for this product.
 - Use only a power source whose voltage is within the rating marked on the AC adaptor. 
 - Do not overload electrical outlets and extension cords. 
- Misuse of the AC adaptor's electric cord can damage or break it, creating the risk of fire and electric shock. Always make sure you observe the following precautions.
 - Never place heavy objects on the cord or subject it to heat. 
 - Never try to modify the cord or subject it to excessive bending.
 - Never twist or stretch the cord.
 - Should the electric cord or plug become damaged, contact your original retailer or authorized CASIO Service Provider. 

- Never touch the AC adaptor while your hands are wet. Doing so creates the risk of electric shock. 
- Use the AC adaptor where it will not be splashed with water. Water creates the risk of fire and electric shock. 
- Do not place a vase or any other container filled with liquid on top of the AC adaptor. Water creates the risk of fire and electric shock. 

Batteries

Misuse of batteries can cause them to leak, resulting in damage to nearby objects, or to explode, creating the risk of fire and personal injury. Always make sure you observe the following precautions.

- Never try to take batteries apart or allow them to become shorted. 
- Never expose batteries to heat or dispose of them by incineration.
- Never mix old batteries with new ones.
- Never mix batteries of different types.
- Do not charge the batteries.
- Make sure the positive (+) and negative (-) ends of the batteries are facing correctly.

Do not incinerate the product.

Never throw the product into fire. Doing so can cause it to explode, creating the risk of fire and personal injury. 

Water and Foreign Matter

Water, other liquids, and foreign matter (such as pieces of metal) getting into the product create the risk of fire and electric shock. Take the following steps immediately. 

1. Turn off power.
2. If you are using the AC adaptor for power, unplug it from the wall outlet.
3. Contact your original retailer or an authorized CASIO Service Provider.

Disassembly and Modification

Never try to take this product apart or modify it in any way. Doing so creates the risk of electric shock, burn injury, or other personal injury. Leave all internal inspection, adjustment, and maintenance up to your original retailer or authorized CASIO Service Provider. 



Dropping and Impact

Continued use of this product after it has been damaged by dropping or subjecting it to strong impact creates the risk of fire and electric shock. Take the following steps immediately.



1. Turn off power.
2. If you are using the AC adaptor for power, unplug it from the wall outlet.
3. Contact your original retailer or an authorized CASIO Service Provider.

Plastic Bags

Never place the plastic bag the product comes in over your head or in your mouth. Doing so creates the risk of suffocation. Particular care concerning this precaution is required where small children are present.



Keep off of the product and stand.*

Climbing onto the product or stand can cause it to tip over or become damaged. Particular care concerning this precaution is required where small children are present.



Location

Avoid locating the product on an unstable stand, on an uneven surface, or any other unstable location. An unstable location can cause the product to fall over, creating the risk of personal injury.



⚠ CAUTION

AC Adaptor

- Misuse of the AC adaptor creates the risk of fire and electric shock. Always make sure you observe the following precautions.
 - Do not locate the electric cord near a stove or other sources of heat.
 - Never pull on the cord when unplugging from the electrical outlet. Always grasp the AC adaptor when unplugging.
- Misuse of the AC adaptor creates the risk of fire and electric shock. Always make sure you observe the following precautions.
 - Insert the AC adaptor into the wall outlet as far as it will go.
 - Unplug the AC adaptor from the wall outlet during lightening storms or before leaving on a trip or other long-term absence.
 - At least once a year, unplug the AC adaptor from the wall outlet and wipe away any dust that is built up in the area around the prongs of the plug.



Relocating the Product

Before relocating the product, always unplug the AC adaptor from the wall outlet and disconnect all other cables and connecting cords. Leaving cords connected creates the risk of damage to the cords, fire, and electric shock.



Cleaning

Before cleaning the product, always unplug the AC adaptor from the wall outlet first. Leaving the AC adaptor plugged in creates the risk of damage to the AC adaptor, fire, and electric shock.



Batteries

Misuse of batteries can cause them to leak resulting in damage to nearby objects, or to explode, creating the risk of fire and personal injury. Always make sure you observe the following precautions.

- Use only batteries that are specified for use with this product.
- Remove batteries from the product if you do not plan to use it for a long time.

Connectors

Connect only the specified devices and equipment to the product's connectors. Connection of a non-specified device or equipment creates the risk of fire and electric shock.



Location

Avoid the following locations for this product. Such locations create the risk of fire and electric shock.



- Areas subject to high humidity or large amounts of dust.
- In food preparation areas or other areas subject to oil smoke.
- Near air conditioning equipment, on a heated carpet, in areas exposed to direct sunlight, inside of a vehicle parked in the sun, or any other area that subjects the product to high temperatures.

Display Screen

- Never push on the display screen's LCD panel or subject it to strong impact. Doing so can cause the LCD panel's glass to crack, creating the risk of personal injury.
- Should the LCD panel ever crack or break, never touch the liquid inside of the panel. LCD panel liquid can cause skin irritation.
- Should LCD panel liquid ever get inside your mouth, immediately wash out your mouth with water and contact your physician.
- Should LCD panel liquid ever get into your eyes or onto your skin, rinse with clear water for at least 15 minutes, and then contact a physician.



Sound Volume

Do not listen to music at very loud volumes for long periods. Particular care concerning this precaution is required when using headphones. High volume settings can damage your hearing.



Health Precaution

In extremely rare cases, exposure to strong sudden light or flashing light can cause momentary muscle spasms, loss of consciousness, or other physical problems with some individuals.

- If you suspect that you might be susceptible to any condition such as this, be sure to consult with your physician before using this product.
- Use this product in an area that is well illuminated.



- Should you ever feel any symptoms similar to those described above when using this product, stop using it immediately and contact your physician.



Heavy Objects

Never place heavy object on top of the product.

Doing so can make the product top heavy, causing the product to tip over or the object to fall from it, creating the risk of personal injury.



Correct Stand* Assembly

An incorrectly assembled stand can tip over, causing the product to fall and creating the risk of personal injury.

Make sure you assemble the stand correctly, following the assembly instructions that come with it. Make sure you mount the product on the stand correctly.



- * Stand is available as an option.

IMPORTANT!

When using batteries, be sure to replace them or shift to one of the alternate power sources whenever you notice any of the following symptoms.

- Dim power supply indicator
- Instrument does not turn on
- Dim, difficult to read display
- Abnormally low speaker/headphone volume
- Distortion of sound output
- Occasional interruption of sound when playing at high volumes
- Sudden power failure when playing at high volumes
- Dimming of the display when playing at high volume
- Continued sound output even after you release a key
- A totally different tone may sound
- Abnormal rhythm pattern and demo tune play
- Abnormally low microphone volume
- Distortion of microphone input
- Dim power supply indicator when a microphone is used
- Sudden power failure when using the microphone
- Dimming of keyboard lights when notes sound
- Loss of power, sound distortion, or low volume when playing from a connected computer



Main Features

❑ 264 tones

A wide selection of tones includes stereo piano and synthesized sounds, drum sets, and much more. Other features include digital effects that control the acoustical characteristic of tones.

❑ PIANO BANK button

The touch of a button takes you directly to piano tones and piano lessons.

❑ 3-Step Lesson System

The 3-Step Lesson System lets you practice at your own pace. The keyboard automatically grades your performances, so you can trace your progress as you improve.

- 3-Step Lesson System: Use any of the keyboard's built-in tunes and SMF data from a memory card to learn to play as the keyboard keys light to teach you the correct notes. First practice the timing of the notes. Next, play along at your own pace. Soon you will be ready for step three, where you play along at normal speed.
 - * Note that key lights may be difficult to see under direct sunlight or under other very bright lighting.
- Evaluation System: The keyboard can be configured to rate your performances during Step 3 lesson by assigning points.

❑ 100 built-in tunes, including piano pieces

Built-in tunes are divided into two groups: a Song Bank of 65 tunes with Auto Accompaniment, and a Piano Bank of 35 piano tunes. You can simply enjoy listening to the built-in tunes, or eliminate either hand part of a tune, and then play along on the keyboard.

❑ 120 rhythms

A selection of rhythms cover rock, pops, jazz and just about any other musical style imaginable.

❑ Auto Accompaniment

Simply play a chord and the corresponding rhythm, bass, and chord parts play along automatically.

❑ Musical Information System

A big LCD screen graphically shows you fingerings and notes, making keyboard play more informative and enjoyable than ever before.

❑ Storing and Playing Back Tune Data You Transferred from Your Computer

You can connect your keyboard to a computer, use special CASIO conversion software to convert SMF data you purchase or create to CASIO format, and then transfer it to the keyboard.

❑ Memory Card Slot

You can load a card with a standard MIDI file (SMF) and play it back on the keyboard.



Contents

Safety Precautions E-1

Main Features E-5

General Guide E-8

Attaching the Score Stand E-10

Quick Reference E-11

To play the keyboard E-11

Power Supply E-12

Using batteries E-12

Using the AC Adaptor E-13

Auto Power Off E-13

Power On Alert E-14

Memory Contents E-14

Connections E-14

Phones/Output Jack E-14

USB port E-15

Sustain/Assignable Jack E-15

Microphone Jack E-15

Accessories and Options E-15

Basic Operations E-16

To play the keyboard E-16

Selecting a Tone E-16

Using Tone Effects E-17

Turning the Key Light System
On and Off E-17

Using the Microphone Jack E-17

Playing a Built-in Tune E-19

To play back a Song Bank tune E-19

To play back a Piano Bank tune E-20

Musical Information System E-20

Adjusting the Tempo E-20

To pause playback E-21

To fast reverse E-21

To fast forward E-21

Looping a Musical Phrase E-21

To change the melody tone E-22

To play all tunes in succession E-22

Using the PIANO BANK Button E-22

Using the SMF Data on the
Bundled CD-ROM E-22

3-Step Lesson E-23

Evaluation Mode E-24

Using the Lesson Functions and
Evaluation Mode E-25

Step 1 – Master the timing. E-25

Step 2 – Master the notes. E-25

Step 3 – Play at normal speed. E-26

Voice Fingering Guide E-27

Using the Metronome E-27



Auto Accompaniment E-28

- Selecting a Rhythm E-28
- Playing a Rhythm E-29
- Using Auto Accompaniment E-29
- Using an Intro Pattern E-31
- Using a Fill-in Pattern E-31
- Using a Rhythm Variation E-31
- Using a Fill-in Pattern with a Variation
Rhythm E-32
- Synchro Starting Accompaniment with
Rhythm Play E-32
- Finishing with an Ending Pattern E-32

Keyboard Settings E-33

- Using Touch Response
(LK-215 Only) E-33
- Adjusting Accompaniment and
Song Bank Volume E-33
- Transposing the Keyboard E-34
- Tuning the Keyboard E-34

Connection to a Computer E-35

- Connecting to a Computer E-35
- Expanding the Selections in the
Song Bank Tunes E-36
- General MIDI Tone E-37
- Changing the Settings E-37

Using a Memory Card E-39

- Getting Ready E-40
- Reading a Memory Card E-41
- Memory Card Error Messages E-42

Troubleshooting E-44

Specifications E-46

Operating Precautions E-47

Appendix A-1

- Tone List / Note Table A-1
- Drum Assignment List A-4
- FINGERED Chord Chart A-5
- Rhythm List A-6
- Song List A-7

MIDI messages that can be sent and received using the USB port

Company and product names used in this manual may be registered trademarks of others.

General Guide

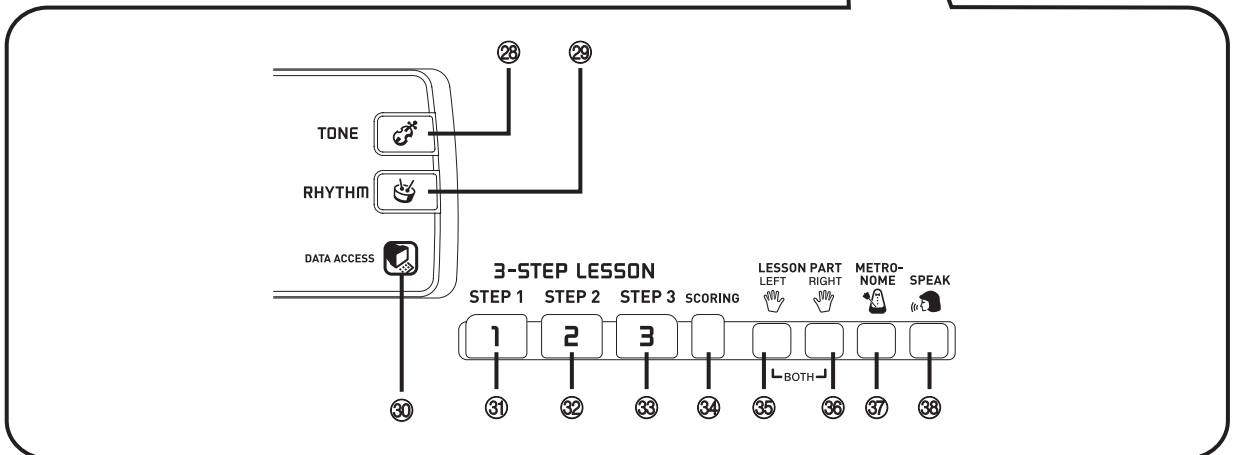
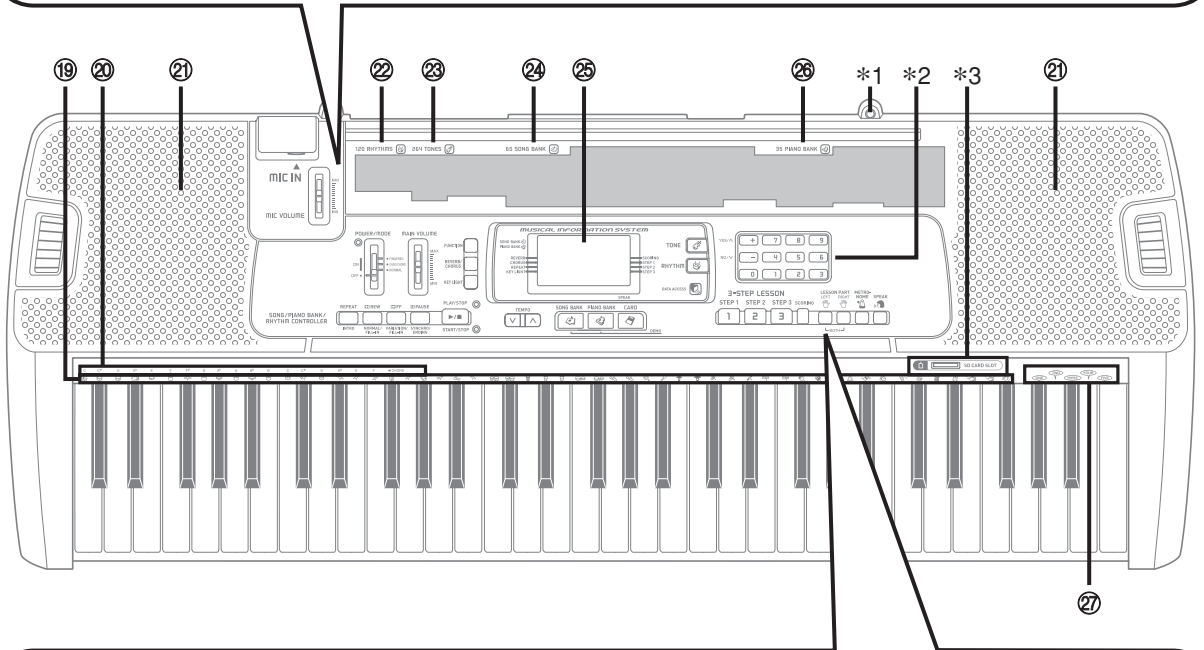
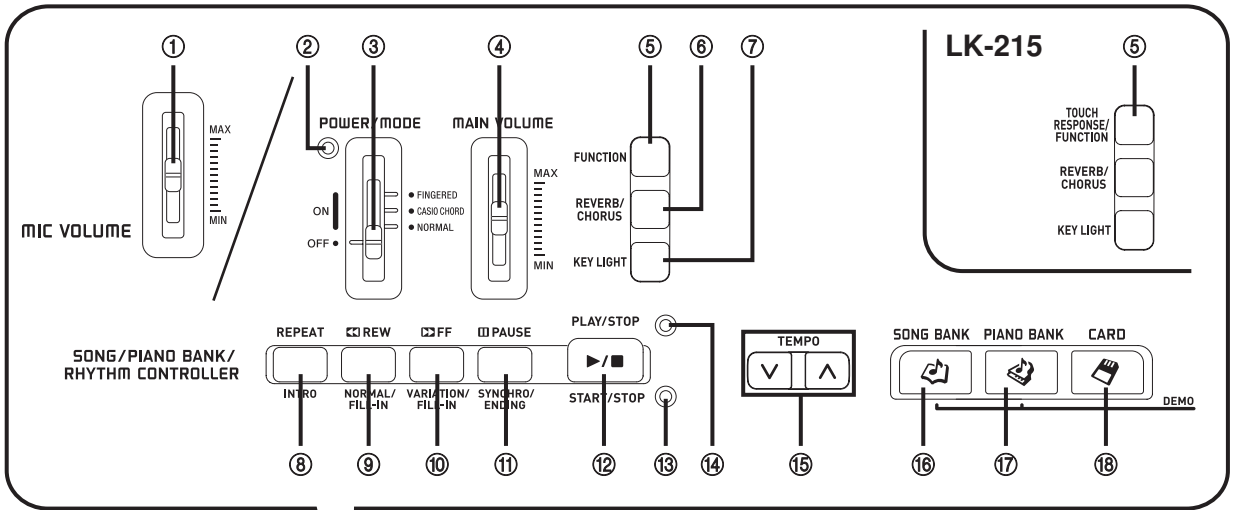

**NOTE**

- Illustrations in this User's Guide shows the LK-210.

- ① MIC VOLUME slider
- ② Power indicator
- ③ POWER/MODE switch
- ④ MAIN VOLUME slider
- ⑤ <LK-210>
FUNCTION button
- ⑤ <LK-215>
TOUCH RESPONSE/FUNCTION button
- ⑥ REVERB/CHORUS button
- ⑦ KEY LIGHT button
- **SONG/PIANO BANK/RHYTHM CONTROLLER**
 - ⑧ REPEAT button, INTRO button
 - ⑨ REW button, NORMAL/FILL-IN button
 - ⑩ FF button, VARIATION/FILL-IN button
 - ⑪ PAUSE button, SYNCHRO/ENDING button
 - ⑫ PLAY/STOP button, START/STOP button
 - ⑬ Rhythm controller indicator
 - ⑭ Song/Piano Bank controller indicator
- ⑮ TEMPO buttons
- ⑯ SONG BANK button
- ⑰ PIANO BANK button
- ⑱ CARD button
- ⑲ Percussion instrument list
- ⑳ CHORD root names
- ㉑ Speaker
- ㉒ RHYTHM list
- ㉓ TONE list
- ㉔ SONG BANK list
- ㉕ Display
- ㉖ PIANO BANK list
- ㉗ Voice 1 to 5 list
- ㉘ TONE button
- ㉙ RHYTHM button
- ㉚ DATA ACCESS lamp
- **3-STEP LESSON**
 - ⑳ STEP 1 button
 - ㉑ STEP 2 button
 - ㉒ STEP 3 button
 - ㉓ SCORING button
 - ㉔ LEFT button
 - ㉕ RIGHT button
 - ㉖ METRONOME button
 - ㉗ SPEAK button

Controller Indicators

Song/Piano Bank controller indicator

Pressing the SONG BANK or PIANO BANK button causes the Song/Piano Bank controller indicator to light. This indicates that buttons ⑧ through ⑫ are currently functioning as playback control buttons.

Rhythm controller indicator

Pressing the RHYTHM button to enter the Rhythm Mode causes the Rhythm controller indicator to light. This indicates that buttons ⑧ through ⑫ are currently functioning as rhythm control buttons.

NOTE

- Display examples shown in this User's Guide are intended for illustrative purposes only. The actual text and values that appear on the display may differ from the examples shown in this User's Guide.
- Viewing a liquid crystal display screen from an angle can change the appearance of display contrast. The display contrast of this keyboard is set to allow easy viewing for a person seated on a chair in front of the keyboard. Note that display contrast is fixed, and cannot be adjusted.

*1 Attaching the Score Stand

Insert both ends of the music stand provided with the keyboard into the two holes on the top surface.

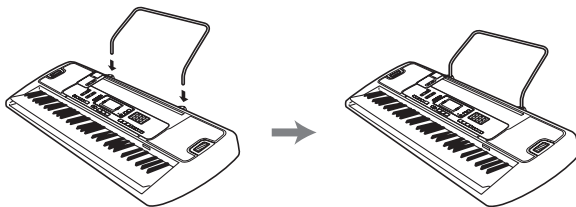

*2

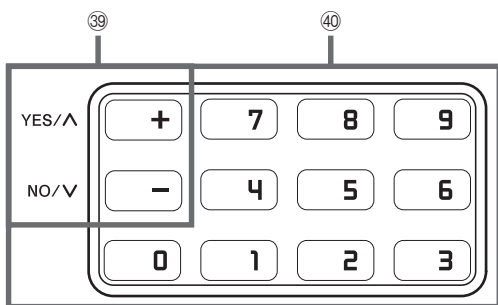

③⑨ [+]/[-] buttons

④⑩ Number buttons

- Negative values cannot be input using the number buttons. Use [+] (increase) and [-] (decrease) instead.
- For input of numbers to change a displayed number or setting.

*3

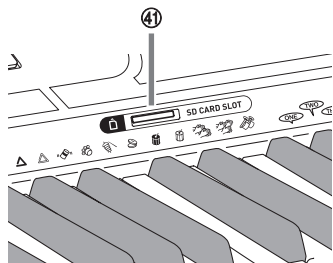

④① SD CARD SLOT

Rear Panel

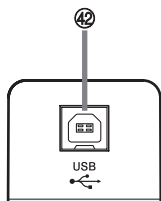

④② USB port

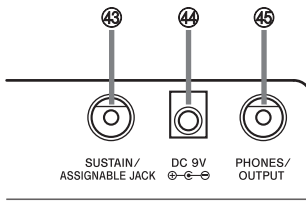

④③ SUSTAIN/ASSIGNABLE JACK

④④ DC 9V jack

④⑤ PHONES/OUTPUT jack

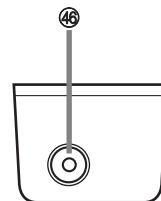

④⑥ MIC IN jack

Quick Reference

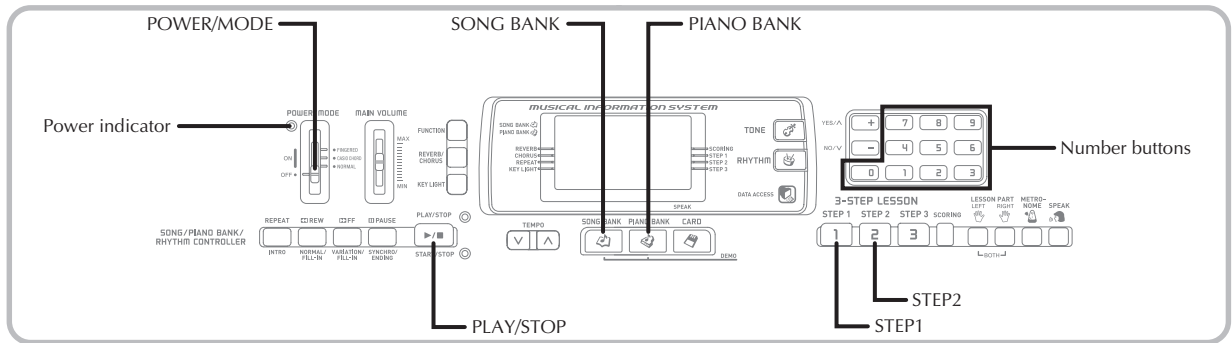

This section provides a quick overview of keyboard operation using steps one and two of the 3-step lesson feature.

To play the keyboard

- 1 Set the POWER/MODE switch to NORMAL.
 - This causes the power indicator to light.

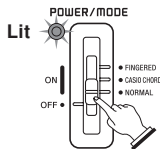

- 2 Press the SONG BANK button.

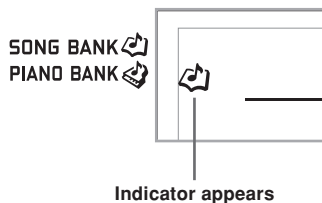

- 3 Find the tune you want to play in the SONG BANK List, and then use the number buttons to input its two-digit number.
 - See page A-7 for the SONG BANK List.

Example: To select "54 ALOHA OE", input 5 and then 4.



- 4 Press the STEP 1 button or STEP 2 button.
 - The keyboard sounds a count beat and waits for you to play something on the keyboard. The keys that you need to press first flash.
- 5 Play the melody along with the selected tune's accompaniment.
 - Play in accordance with the fingerings, notes, and dynamic marks that appear on the display.

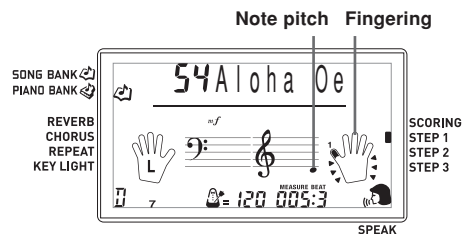

If you selected lesson Step 1

- Play the notes on the keyboard.
- Accompaniment (left-hand part) plays in time with the notes.
- With Step 1, the correct melody note is played no matter which keyboard key you press.

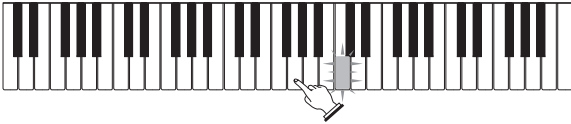

If you selected lesson Step 2

- Play the correct notes on the keyboard.



- Press the keyboard key that lights. Note that with a Piano Bank tune, the keyboard key light turns off as soon as you press the key.
- The keyboard key for the next note you will need to play flashes.
- Accompaniment (left-hand part) plays in time with the notes, as long as you press the correct keyboard keys.

- 6 To stop play at any time, press the PLAY/STOP button.

To play an Etude or Concert Piece tune

- 1 When you get to step 2 of the above procedure, press the PIANO BANK button in place of the SONG BANK button.

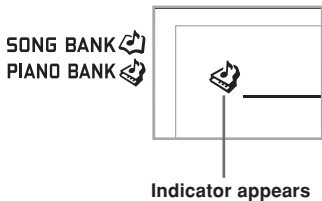

- 2 Find the tune you want to play in the PIANO BANK List, and then use the number buttons to input its two-digit number.
 - See page A-7 for the PIANO BANK List.
- 3 Next, continue from step 4 of the above procedure.

This keyboard can be powered by current from a standard household wall outlet (using the specified AC adaptor) or by batteries. Always make sure you turn the keyboard off whenever you are not using it.

Using batteries

Always make sure you turn off the keyboard before loading or replacing batteries.

To load batteries

- 1 Remove the battery compartment cover.
- 2 Load 6 AA-size batteries into the battery compartment.
 - Make sure that the positive (+) and negative (-) ends are facing correctly.

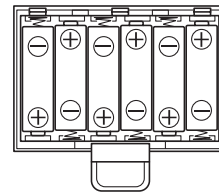

- 3 Insert the tabs on the battery compartment cover into the holes provided and close the cover.

NOTE

- The keyboard may not function correctly if you load or replace batteries with power turned on. If this happens, turning the keyboard off and then back on again should return functions back to normal.

Important Battery Information

- The following shows the approximate battery life.

Manganese batteries	1 hour
Alkaline batteries	4 hours

The above value is standard battery life at normal temperature, with the keyboard volume at medium setting. Temperature extremes or playing at very loud volume settings can shorten battery life.

⚠ WARNING

Misuse of batteries can cause them to leak, resulting in damage to nearby objects, or to explode, creating the risk of fire and personal injury. Always make sure you observe the following precautions.

- Never try to take batteries apart or allow them to become shorted. ⓧ
- Never expose batteries to heat or dispose of them by incineration.
- Never mix old batteries with new ones.
- Never mix batteries of different types.
- Do not charge the batteries.
- Make sure the positive (+) and negative (-) ends of the batteries are facing correctly.

⚠ CAUTION

Misuse of batteries can cause them to leak resulting in damage to nearby objects, or to explode, creating the risk of fire and personal injury. Always make sure you observe the following precautions.

- Use only batteries that are specified for use with this product. ⓧ
- Remove batteries from the product if you do not plan to use it for a long time.

NOTE

- Do not use an oxyride battery or any other type of nickel-based primary battery with this product. Incompatibility between such batteries and product specifications can result in shorter battery life and product malfunction.

Using the AC Adaptor

Make sure that you use only the AC adaptor specified for this keyboard.

Specified AC Adaptor: AD-5

[Rear Panel]

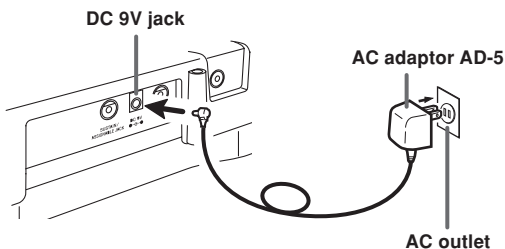

Note the following important precautions to avoid damage to the power cord.

● During Use

- Never pull on the cord with excessive force.
- Never repeatedly pull on the cord.
- Never twist the cord at the base of the plug or connector.
- The power cord should not be stretched tight while it is in use.

● During Movement

- Before moving the keyboard, be sure to unplug the AC adaptor from the power outlet.

● During Storage

- Loop and bundle the power cord, but never wind it around the AC adaptor.

IMPORTANT!

- Make sure that the keyboard is turned off before connecting or disconnecting the AC adaptor.
- Using the AC adaptor for a long time can cause it to become warm to the touch. This is normal and does not indicate malfunction.

Auto Power Off

When you are using battery power, keyboard power turns off automatically whenever you leave it on without performing any operation for about 6 minutes. When this happens, adjust the POWER/MODE switch to turn power back on.

NOTE

- Auto Power Off is disabled (it does not function) when you are using the AC adaptor to power the keyboard.

To disable Auto Power Off

Hold down the TONE button while turning on the keyboard to disable Auto Power Off.

NOTE

- When this function is turned off, the keyboard does not turn off automatically no matter how long it is left with no operation being performed.
- Auto Power Off is enabled again when you manually turn off power and then turn it back on again.

Power On Alert

Keyboard keys light to alert you if you leave power on and do not perform any operation for about 6 minutes. Note that keys light only, and no sound is produced. When this happens, press any button or keyboard key to clear the power on alert.

NOTE

- Power on alert operates only when you are powering the keyboard using the AC adaptor. It does not operate when you are using batteries.

To turn off power on alert

- 1 Press the FUNCTION (LK-215: TOUCH RESPONSE/FUNCTION) button a number of times until "DEMO 2" appears on the display.
- 2 Use the [+] and [-] buttons to change the setting to "oFF".
- 3 Press the FUNCTION (LK-215: TOUCH RESPONSE/FUNCTION) button to clear the setting screen from the display.

Memory Contents

Even when the keyboard is turned off, user song data saved as Song Bank tunes are retained as long as power is being supplied to the keyboard.

Unplugging the AC adaptor when batteries are not loaded or when batteries are dead cuts off the power supply. This causes all keyboard settings to be initialized to the initial factory defaults, and clears all data stored in memory.

Power Requirements

Note the following precautions whenever you want to ensure that current keyboard settings and memory contents are not lost.

- Make sure the keyboard is being supplied power through the AC adaptor before replacing its batteries.
- Before unplugging the AC adaptor, make sure that fresh batteries are loaded in the keyboard.

Make sure that keyboard power is turned off before replacing batteries or unplugging the AC adaptor.

Phones/Output Jack

PREPARATION

- Before connecting headphones or other external equipment, be sure to first turn down the volume settings of the keyboard and the connected equipment. You can then adjust volume to the desired level after connections are complete.

[Rear Panel]

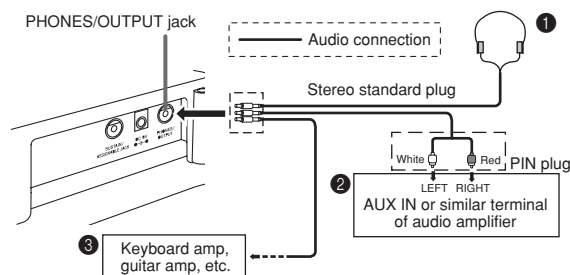

Connecting Headphones (Figure 1)

Connecting headphones cuts off output from the keyboard's built-in speakers, so you can play even late at night without disturbing anyone.

Audio Equipment (Figure 2)

Connect the keyboard to an audio equipment using a commercially available connecting cord with a standard plug on one end and two PIN plugs on the other end. Note that the standard plug you connect to the keyboard must be a stereo plug, otherwise you will be able to output only one of stereo channels. In this configuration, you normally set the input selector of the audio equipment to the terminal (usually marked AUX IN or something similar) where the cord from the keyboard is connected. See the user documentation that comes with your audio equipment for full details.

Musical Instrument Amplifier (Figure 3)

Use a commercially available connecting cord to connect the keyboard to a musical instrument amplifier.

NOTE

- Be sure to use a connecting cord that has a stereo standard plug on the end you connect to the keyboard, and a connector that provides dual channel (left and right) input to the amplifier to which you are connecting. The wrong type of connector at either end can cause one of the stereo channels to be lost.

When connected to a musical instrument amplifier, set the volume of the keyboard to a relatively low level and make output volume adjustments using the amplifier's controls.

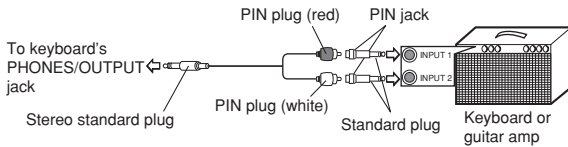
Connection Example**USB port**

You can also connect the keyboard to a computer. See “Connecting to a Computer” on page E-35 for details.

Sustain/Assignable Jack

You can connect an optional sustain pedal (SP-3 or SP-20) to the SUSTAIN/ASSIGNABLE JACK to enable the capabilities described below.

For details on how to select the pedal function you want, see “SUSTAIN/ASSIGNABLE JACK (Default: SUS)” on page E-38.

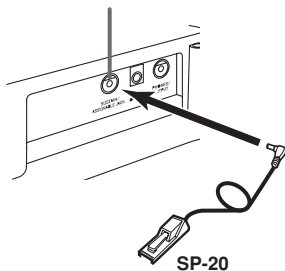
SUSTAIN/ASSIGNABLE JACK**Sustain Pedal**

- With piano tones, depressing the pedal causes notes to linger, much like a piano’s damper pedal.
- With organ tones, depressing the pedal causes notes to continue to sound until the pedal is released.

Sostenuto Pedal

- As with the sustain pedal function described above, depressing the sostenuto pedal causes notes to be sustained.
- This difference between a sostenuto pedal and sustain pedal is the timing. With a sostenuto pedal, you press the keys and then depress the pedal before you release the keys.
- Only the notes that are sounding when the pedal is depressed are sustained.

Soft Pedal

Depressing the pedal softens the sound of the notes being played.

Rhythm Start/Stop Pedal

In this case, the pedal performs the same functions as the START/STOP button.

Microphone Jack

You can connect a commercially available microphone to the microphone jack and sing along with notes played on the keyboard. For details, see “Using the Microphone Jack” on page E-17.

Accessories and Options

Use only the accessories and options specified for this keyboard. Use of non-authorized items creates the danger of fire, electrical shock, and personal injury.

Basic Operations

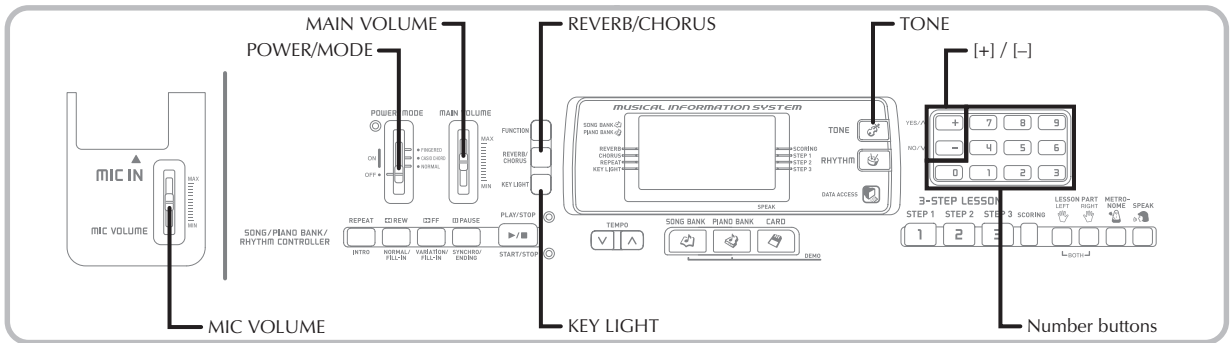

This section provides information on performing basic keyboard operations.

To play the keyboard

- 1 Set the POWER/MODE switch to NORMAL.
- 2 Use the MAIN VOLUME slider to set the volume to a relatively low level.
- 3 Play something on the keyboard.

Selecting a Tone

This keyboard comes with 264 built-in tones. Use the following procedure to select the tone you want.

To select a tone

- 1 Find the tone you want to use in the TONE List and note its tone number.
 - Not all of the available tones are shown on the tone list printed on the keyboard console. For a complete list, see the "Tone List" on page A-1.
- 2 Press the TONE button.

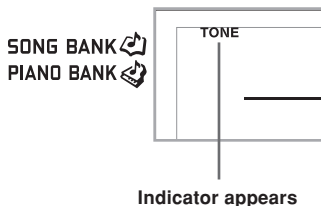

- 3 Use the number buttons to input the three-digit tone number of the tone you want to select.

Example: To select "049 ACOUSTIC BASS", input 0, 4 and then 9.



NOTE

- Always input all three digits for the tone number, including leading zeros (if any). If you input one or two digits and stop, the display will automatically clear your input after a few seconds.
- You can also increment the displayed tone number by pressing [+], and decrement it by pressing [-].
- When one of the drum sets is selected (tone numbers 256 through 263), each keyboard key is assigned a different percussion sound. See page A-4 for details.

Polyphony

The term polyphony refers to the maximum number of notes you can play at the same time. The keyboard has 32-note polyphony, which includes the notes you play as well as the rhythms and auto-accompaniment patterns that are played by the keyboard. This means that when a rhythm or auto-accompaniment pattern is being played by the keyboard, the number of notes (polyphony) available for keyboard play is reduced. Also note that some of the tones offer only 16-note polyphony.

- When rhythm or auto accompaniment is playing, the number of sounds simultaneously played is reduced.

Using Tone Effects

Reverb: Makes your notes resonate

Chorus: Adds more breadth to your notes

- Press the REVERB/CHORUS button to cycle through the effect settings as shown below.
 - You can find out the current effect setting by looking at the REVERB and CHORUS indicators.

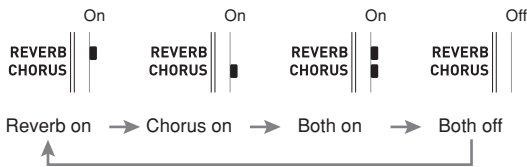

- After turning on the effect you want, use the number buttons or the [+]/[-] buttons to select the effect type you want.
 - Note that you need to select an effect type with the number buttons or the [+]/[-] buttons within a few seconds after turning on an effect. If you don't, the display will exit the setting screen.

Effect List

Reverb	0: Room 1 1: Room 2 2: Hall 1 3: Hall 2	Chorus	0: Chorus 1 1: Chorus 2 2: Chorus 3 3: Chorus 4
--------	--	--------	--

Turning the Key Light System On and Off

Use the following procedure when you want to turn the key light system on or off.

To turn the key light system on and off

- Press the KEY LIGHT button to toggle the key light system on and off.
 - The KEY LIGHT indicator disappears when the key light system is turned off.

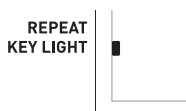

NOTE

- The key light system is turned on automatically whenever you turn on keyboard power.

Using the Microphone Jack

Connecting a commercially available microphone* to the MIC IN jack makes it possible to sing along with the keyboard's built-in tunes or with SMF playback. When connecting a microphone, be sure to first adjust the MIC VOLUME to a relatively low setting, and then adjust to the level you want after connecting.

* If a microphone was included with your keyboard, use that microphone. If your keyboard did not come with a microphone, use a commercially available microphone that satisfies the stipulated specifications.

- Set the MIC VOLUME slider setting so it is on the "MIN" side.
- Turn on the microphone's on/off switch.
- Use the MIC VOLUME slider to adjust microphone volume to the level you want.

[Rear Panel]

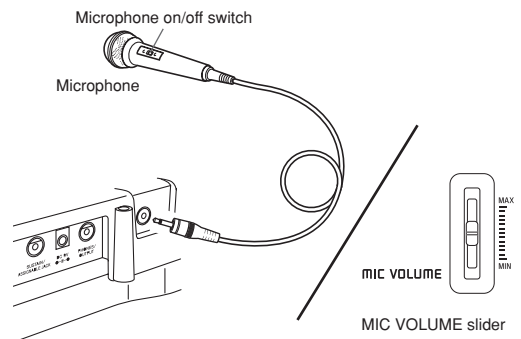

IMPORTANT!

- Be sure to use the microphone's on/off switch to turn off the microphone and to disconnect the microphone from the keyboard whenever you are not using it.



Recommended Microphone Type

- Dynamic microphone (standard plug)

IMPORTANT!

- Be sure to disconnect the microphone from the keyboard whenever you are not using it.
-

Howling (Feedback Noise)

Any of the following conditions can cause howling (feedback noise).

- Covering the head of the microphone with your hand
- Positioning the microphone too near to a speaker

Should howling occur, try grasping the microphone further away from the head, and move away from any nearby speaker.

Static Noise

Fluorescent lighting can cause static noise in the microphone signal. When this happens, move away from the lighting you suspect may be causing the static.

To play back a Piano Bank tune

- Find the tune you want to play in the PIANO BANK List, and note its number.
 - See page A-7 for the PIANO BANK List.
- Press the PIANO BANK button to specify the Piano Bank group.

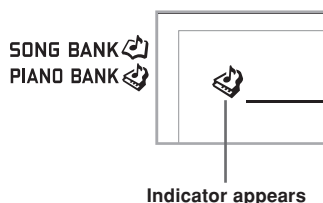

NOTE

- Pressing the PIANO BANK button changes the tone to STEREO PIANO (Tone Number 000).

- Use the number buttons to input the two-digit tune number you looked up in step 1.

Example: To select tune number 07 (ODE TO JOY), input 0 and then 7.



NOTE

- Tune Number 00 is the initial default Piano Bank tune setting whenever you turn on keyboard power.
- You can also change the displayed tune number using the [+] and [-] buttons.

- Press the PLAY/STOP button to start playback.
- To stop playback, press the PLAY/STOP button.
 - The tune you select continues to play until you stop it.

Musical Information System

When the keyboard is playing one of its built-in tunes, the display shows a variety of information about the tune.

Example: Display during Song Bank play

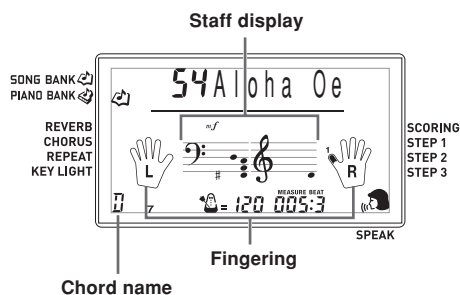

NOTE

- Chord names are not displayed for Piano Bank tunes.

Adjusting the Tempo

The tempo (beats per minute) can be set to a value in the range of 30 to 255. The tempo value you set is used for Song Bank, Piano Bank, 3-step lesson, and Auto Accompaniment chord play, as well as playback from memory card and metronome operation.

To set the tempo

- Use the TEMPO buttons to set the tempo.
 - ∧ : Increases the tempo value.
 - ∨ : Decreases the tempo value.

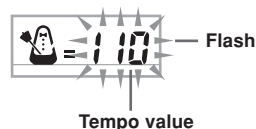

NOTE

- While the tempo value is flashing, you can also use the number buttons or [+] and [-] to input a three-digit value. Note that you must input leading zeros, so 90 is input as 090.
- Pressing both the ∧ and ∨ TEMPO buttons at the same time automatically returns the currently selected rhythm to its default tempo.
- Piano Bank tunes have tempo changes part way through in order to produce specific musical effects.

To pause playback

- 1 Press the PAUSE button while a tune is playing to pause it.
- 2 Pressing the PAUSE button again resumes play from the point where it was paused.

To fast reverse

- 1 While a tune is playing or paused, hold down the REW button to skip in a reverse direction at high speed.
 - The fast reverse operation skips back one measure at a time.
 - The measure and beat numbers on the display change while the fast reverse operation is being performed.



- 2 Releasing the REW button starts song playback from the measure whose number is shown on the display.

NOTE

- Fast reverse does not work while tune play is stopped.
- Certain playback conditions can cause it to take some time before fast reverse starts after you press the REW button.

To fast forward

- 1 While a tune is playing or paused, hold down the FF button to skip forward at high speed.
 - The fast forward operation skips forward one measure at a time.
 - The measure and beat numbers on the display change while the fast forward operation is being performed.



- 2 Releasing the FF button starts song playback from the measure whose number is shown on the display.

NOTE

- Fast forward does not work while tune play is stopped.

Looping a Musical Phrase

You can select one or more measures and “loop” them, which means that they play again and again until you stop playback.

- 1 While the tune is playing, press the REPEAT button while the measure you want to start from is playing.
 - This causes the repeat indicator to flash on the display, and displays the measure number of the start measure.
- 2 When playback is within the measure you want to specify as the end of the loop, press the REPEAT button again.
 - This displays the measure number of the end measure, and starts repeat play of the loop.
 - To cancel repeat play of a loop, press the REPEAT button again so the repeat indicator is not displayed.

To change the melody tone

- 1 Press the TONE button.

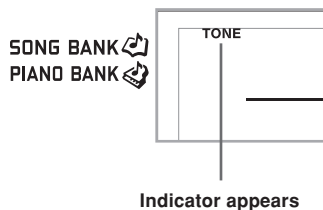

- 2 Find the tone you want in the TONE List, and then use the number buttons to input its three-digit number.

Example: To select "057 VIOLIN", input 0, then 5, then 7.

- You can select any one of the keyboard's 264 built-in tones.



NOTE

- You can also use the [+] and [-] buttons to change the melody tones.
- For two-hand tunes (Piano Bank tunes), the same tone is applied for both the left and right hand parts.
- Specifying the tune number for the same tune that is currently selected returns the melody tone to the default setting for that tune.

To play all tunes in succession

- 1 Press the SONG BANK button and PIANO BANK button at the same time.
 - Playback starts from Song Bank tune number 00, followed in sequence by Piano Bank tunes.
- 2 To stop tune play, press the PLAY/STOP button.

NOTE

- While a tune is playing, you can use the number buttons or [+] and [-] to change to another tune.
- You can play along with the tunes on the keyboard.

Using the PIANO BANK Button

Pressing the PIANO BANK button provides instant access to piano tones and piano tune selection.

Initial Piano Bank Setting

Tone: 000 STEREO PIANO

To use the piano bank

- 1 Press the PIANO BANK button.

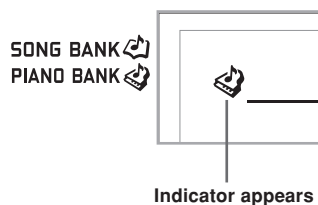

- 2 Now try playing something on the keyboard.
 - The notes you play sound with a piano tone.
- 3 If you want to playback the built-in tune, press the PLAY/STOP button.
 - This causes the currently selected tune to play in an endless loop.
 - To stop playback, press the PLAY/STOP button again.

Using the SMF Data on the Bundled CD-ROM

The CD-ROM that comes bundled with the keyboard contains demos as well as 25 tunes (SMF data) that you can use for step lessons. It also contains PDF format files that contain the sheet music of the included tunes. For a full list of the tunes that are included, open the "List.txt" file located inside the "MusicDataFolder" on the CD-ROM. For each tune, "List.txt" shows the tune name, SMF file name, PDF file name of the music score, and the type of lesson* for which the tune can be used.

* A tune marked with an asterisk (*) can be used for a both-hand lesson. A tune that is not marked with an asterisk can be used for a right-hand lesson.

NOTE

- You can load SMF data from the CD-ROM to the keyboard using an SD memory card (page E-41) or using the SMF converter tool (page E-36).
- You will need to have Adobe Reader or Acrobat Reader installed on your computer in order to view the contents of a music score PDF file. If neither of these applications is installed on your computer, see "Installing Adobe Reader (Acrobat Reader**)" on page E-35.

3-Step Lesson

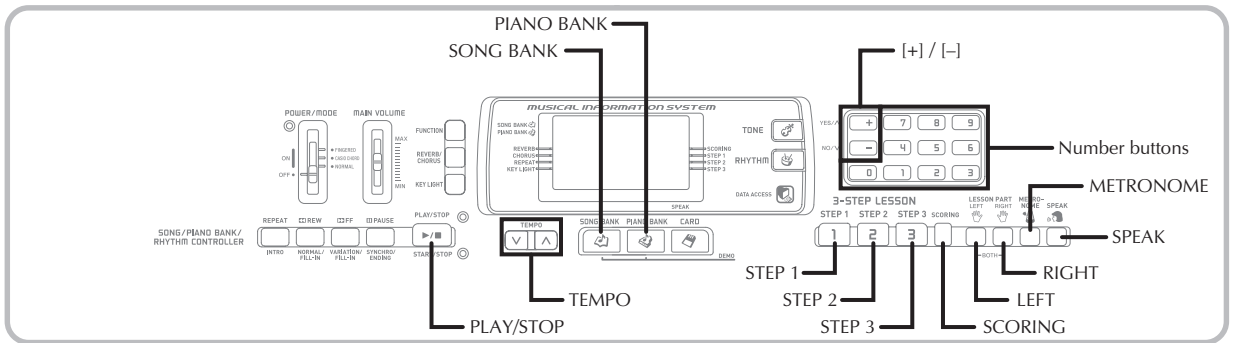

With the 3-Step Lesson System, you can practice built-in tunes and SMF data from a memory card, and even plot your progress according to the evaluation points the keyboard awards you.

* See "Using a Memory Card" on page E-39 for information about using the SMF data from a memory card for playback.

Lesson Progress



3-Step Lesson

The 3-step lesson feature takes you through the three distinct steps described below to help you learn to play tunes on the keyboard.

Step 1 – Master the timing.

In this step, pressing any key on the keyboard plays the correct note, so you can concentrate on getting the timing right without worrying about playing the right note. Accompaniment (left-hand part) waits until you press a key before proceeding to the next phrase.

Step 2 – Master the notes.

In this step, you use the display to learn which fingers you should use and how loud or soft to play, and the key light system to learn which keyboard keys to press. Accompaniment (left-hand part) waits until your play the correct note, so you can learn at your own pace.

Step 3 – Play at normal speed.

This is where you enjoy actually playing the tunes you learn using Step 1 and Step 2. The key light system still shows you which keyboard keys to press, but accompaniment proceeds at normal speed regardless of whether or not you play the correct notes.

Lesson Parts

3-Step Lesson lets you practice the right-hand part, left-hand part, or the parts for both hands.

Key Lighting System Operation and Display Contents During 3-step Lesson Play

Whenever you select an Auto Accompaniment tune for 3-step lesson play, the key lighting system shows you which keys to press, while the display shows you the notes and their fingerings.

Note Pitch

The keyboard key that should be pressed lights, while the actual pitch of the note appears in the display's staff notation area. The fingers you should use to play the notes are also shown on the display.

Note Length

Keyboard keys stay lit for as long as the note should be played. The staff notation and fingerings also remain on the display for the length of the note.

Next Note

The keyboard key for the next note to be played flashes, while a number appears on the display near the finger you should use to play the next note.

Series of Same Pitch Notes

The keyboard key light turns off momentarily between the notes and lights again for each successive note. The staff notation and fingerings also turn off and back on again.

3-Step Lesson

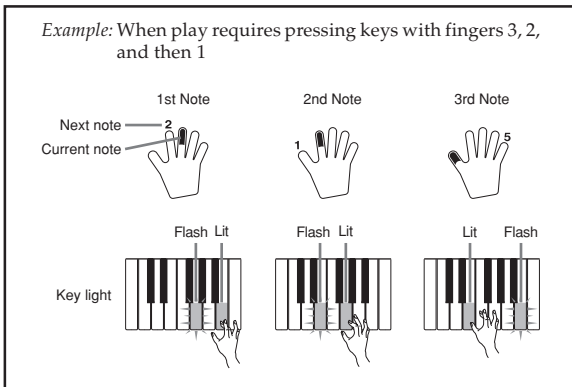

NOTE

- Note length is not indicated when you are using two-hand tunes with 3-step lesson Steps 1 and 2. As soon as you press a lit key, it goes out and the next key to be played starts to flash.
- Note length is indicated by the key light system when you use a two-hand tune with Step 3. In this case, the next key to be pressed does not flash when you press a lit key and the next finger number does not appear on the display. Only the current finger number is shown.

3-step Lesson Tempo Setting

Use the procedure under "Adjusting the Tempo" on page E-20 to adjust the tempo for 3-step lesson play.

Dynamic Marks

The dynamic marks listed below appear on the display while tunes are playing. Adjust the pressure you apply to the keyboard in accordance with the mark that is on the display.

- pp*** pianissimo: Very soft
p piano: Soft
mp mezzo piano: Moderately soft
mf mezzo forte: Moderately loud
f forte: Loud
ff fortissimo: Very loud
cresc. (<) crescendo: Gradually louder
decresc. (>) decrescendo: Gradually softer

Evaluation Mode

The keyboard's Evaluation Mode awards points to your performances during Step 3 of the 3-Step Lesson. A perfect score is 100. Also, the Evaluation Mode provides comments about your play on the monitor screen.

Evaluation Mode Display

Level Indicator (9 Levels): This indicator shows the evaluation of your current performance at a glance. The more segments that appear, the higher your points.

Example: 50 points



Timing Indicator: In the Evaluation Mode, the configuration of the star changes with each note to let you know how your timing is. The more stars, the better your timing.



Evaluation Results

After you finish playing, the keyboard calculates an evaluation of your total performance, from beginning to end, and displays your total score on the monitor screen. The greater the score, the higher your evaluation is.

Evaluation Rank Display Messages

Display Message	
"Bravo!"	<High>
"Great!"	Evaluation Ranges
"Not bad!"	
"Again!"	

"*****" : indicates that the Evaluation Mode was exited before an evaluation result could be obtained.

NOTE

- If you press the PLAY/STOP button and interrupt the Evaluation Mode part way through, the monitor screen shows the evaluation points you have accumulated up to that point. In this case, the keyboard does not display a message.

Using the Lesson Functions and Evaluation Mode

Perform the following steps to master your favorite tunes.

Step 1 – Master the timing.

- 1 Select the tune you want to use.
- 2 Press the RIGHT button or the LEFT button to specify the part you want to practice.
 - If you want to practice both hands, press both buttons at the same time.
 - Indicators appear around the hand on the display whose part is selected for practice.

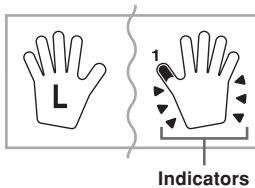

- 3 Press the STEP 1 button to start Step 1 play.
 - After a count sounds, the keyboard stands by and waits for you to play the first note of the tune.
 - Voice fingering guide will use a simulated human voice to call out fingering numbers during one-hand part practice. See "Voice Fingering Guide" on page E-27 for details.

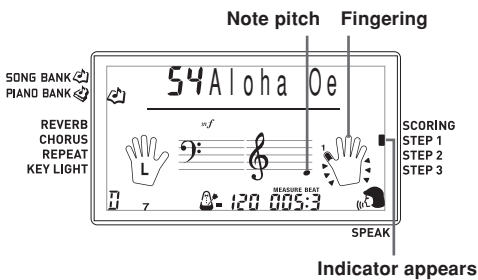

- 4 Press any keyboard keys to play the notes.

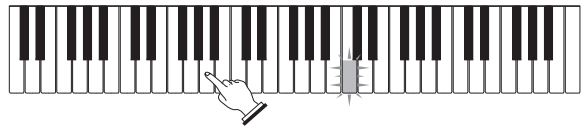

- The key for the next note to be played flashes while the keyboard waits for you to play it. When you press any key to play the note, the key remains lit as the note plays.
- Accompaniment (left-hand part) waits until you press any key to play a note.
- If you accidentally press more than one key in succession, accompaniment is played for the corresponding number of notes.
- Pressing more than one key at the same time counts as a single note. Pressing a key while another key is held down is counted as two notes.

- 5 To stop play at any time, press the PLAY/STOP button.

Step 2 – Master the notes.

- 1 Select the tune you want to use.
- 2 Press the RIGHT button or the LEFT button to specify the part you want to practice.
 - If you want to practice both hands, press both buttons at the same time.
- 3 Press the STEP 2 button to start Step 2 play.
 - After a count sounds, the keyboard stands by and waits for you to play the first note of the tune.
 - Voice fingering guide will use a simulated human voice to call out fingering numbers during one-hand part practice. See "Voice Fingering Guide" on page E-27 for details.

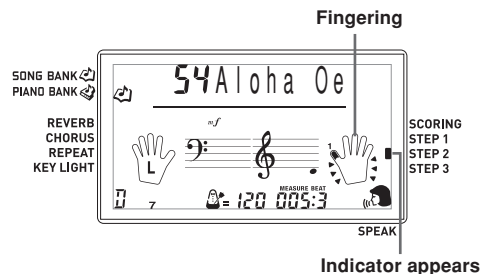

3-Step Lesson

- 4 Follow the key light system to press the correct keyboard keys and play the notes.

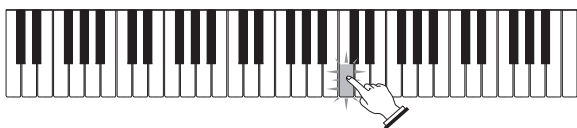

- The key for the next note to be played flashes while the keyboard waits for you to play it. When you press any key to play the note, the key remains lit as the note plays.
- If multiple keys light on the on-screen keyboard guide when you are using a two-hand tune, it means that you must press all of the keys that are lit.

- 5 To stop play at any time, press the PLAY/STOP button.

Step 3 – Play at normal speed.

- 1 Select the tune you want to play.
- 2 Press the RIGHT button or the LEFT button to specify the part you want to practice.
 - If you want to practice both hands, press both buttons at the same time.
- 3 Press the STEP 3 button to start Step 3 play.
 - Accompaniment (left hand part) starts to play at normal speed.

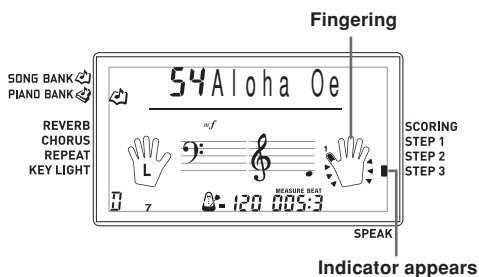

- 4 Follow the key light system to press the correct keyboard keys and play the notes.

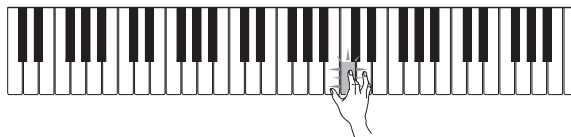

- 5 To stop play at any time, press the PLAY/STOP button.

Evaluation: Find out how the keyboard evaluates your Step 3 play.

Use the SCORING button to check the evaluation of your play in Step 3.

- 1 Press the SCORING button.
 - This causes the SCORING indicator to appear on the display.
 - A count beat sounds and then evaluation mode starts.

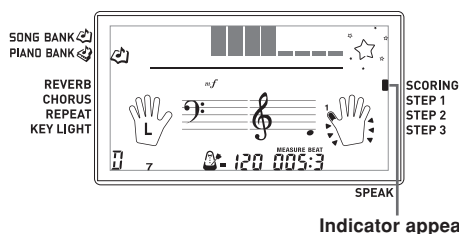

- 2 Play in accordance with the guidance on the monitor screen.
 - To stop evaluation, press the PLAY/STOP button. This displays only the points accumulated up to that point.
- 3 After you finished playing, your evaluation result appears on the display.
 - For information about evaluation ranks, see "Evaluation Results" on page E-24.
 - Pressing the SONG BANK button or PIANO BANK button returns to the tune selection screen.



Voice Fingering Guide

Voice fingering guide uses a simulated human voice to call out fingering numbers during Step 1 and Step 2 one-hand part practice. If you need to press a key with your thumb, for example, voice fingering guide says, "One!" In the case of a chord to be played with your thumb, middle and little finger, voice fingering guide says, "One, three, five!" Voice Fingering Guide calls out fingerings only when you do not press the proper key when you should.

Voice Fingering Guide

One : Thumb
Two : Forefinger
Three : Middle finger
Four : Ring finger
Five : Little finger

To turn voice fingering guide on or off

Press the SPEAK button to toggle voice fingering guide on (voice fingering guide indicator displayed) and off (indicator not displayed).



NOTE

- Note that Voice Fingering is disabled in the Evaluation Mode.
- Exiting the Evaluation Mode automatically restores the Voice Fingering setting that was in effect when you entered the Evaluation Mode.

Using the Metronome

The metronome feature of this keyboard produces a bell sound for the first beat of each measure, followed by click sounds for each successive beat of the measure. It is the perfect tool for practicing tunes without accompaniment (rhythm).

To start the metronome

- 1 Press the METRONOME button to start sounding the metronome.
 - This causes "Beat" to appear on the display. Perform step 2 within five seconds after "Beat" appears.



- 2 Use the number buttons or [+] and [-] to change the number of beats per measure.
 - You can specify 0, or a value from 2 to 6 as the number of beats per measure.



NOTE

- The bell (indicating the first beat of a measure) does not sound while one beat per measure is specified. All beats are indicated by a click sound. This setting lets you practice with a steady beat, without worrying about how many beats there are in each measure.

- 3 Use the TEMPO buttons to set the tempo.
 - Press \wedge to increase the tempo (make it faster) or \vee to decrease it (make it slower).



NOTE

- While the tempo value is flashing, you can also use the number buttons or [+] and [-] to input a three-digit value. Note that you must input leading zeros, so 90 is input as 090.
- Pressing both the \wedge and \vee TEMPO buttons at the same time automatically returns the currently selected rhythm or tune to its default tempo.

- 4 To turn off the metronome, press the METRONOME button.

Auto Accompaniment

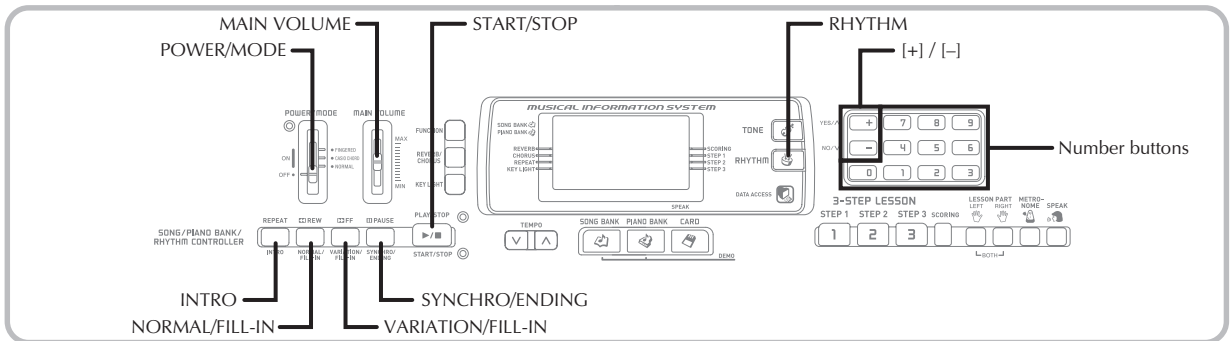

This keyboard automatically plays bass and chord parts in accordance with the chords you finger. The bass and chord parts are played using sounds and tones that are automatically selected to select the rhythm you are using. All of this means that you get full, realistic accompaniments for the melody notes you play with your right hand, creating the mood of an one-person ensemble.

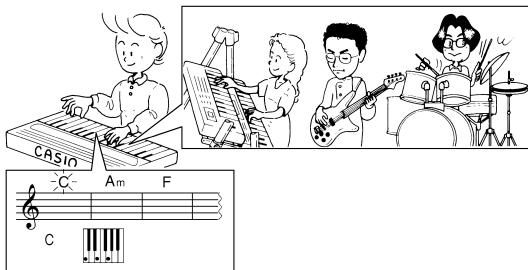

Selecting a Rhythm

This keyboard provides you with 120 exciting rhythms that you can select using the following procedure.

To select a rhythm

- Find the rhythm you want to use in the RHYTHM List and note its rhythm number.
 - Not all of the available rhythms are shown on the rhythm list printed on the keyboard console. For a complete list, see the "Rhythm List" on page A-6.

- Press the RHYTHM button.

SONG BANK
PIANO BANK



Indicator appears

- Use the number buttons to input the three digit rhythm number for the rhythm you want to select.
Example: To select "075 RHUMBA", input 0, 7 and then 5.

SONG BANK
PIANO BANK



NOTE

- You can also increment the displayed rhythm number by pressing [+], and decrement it by pressing [-].
- Some rhythms consist of chord accompaniments only, without any drums or other percussion instruments. Such rhythms do not sound unless CASIO CHORD or FINGERED is selected as the accompaniment mode.

Playing a Rhythm

Use the following procedure to start and stop rhythm play.

To play a rhythm

- 1 Set the POWER/MODE switch to NORMAL.
- 2 Press the START/STOP button to start play of the currently selected rhythm.
- 3 To stop rhythm play, press the START/STOP button again.

NOTE

- All of the keyboard keys are melody keys while the POWER/MODE switch is set to NORMAL.

Using Auto Accompaniment

The following procedure describes how to use the keyboard's Auto Accompaniment feature. Before starting, you should first select the rhythm you want to use and set the tempo of the rhythm to the value you want.

To use Auto Accompaniment

- 1 Set the POWER/MODE switch to CASIO CHORD or FINGERED.
- 2 Press the START/STOP button to start play of the currently selected rhythm.
- 3 Play a chord.
 - The actual procedure you should use to play a chord depends on the current POWER/MODE switch position. Refer to the following pages for details on chord play.

CASIO CHORD Page E-29
 FINGERED Page E-30

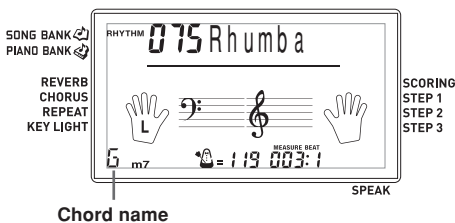

- 4 To stop Auto Accompaniment play, press the START/STOP button again.

NOTE

- If you press the SYNCHRO/ENDING button and then the INTRO button in place of the START/STOP button in step 2, accompaniment will start with an intro pattern when you perform the operation in step 3. For details about these buttons, see pages E-31 and E-32.
- If you press the SYNCHRO/ENDING button in place of the START/STOP button in step 4, an ending pattern will play before accompaniment play is ended. For details about this button, see page E-32.
- You can adjust the accompaniment part volume level independently of the main volume. For details, see "Adjusting Accompaniment and Song Bank Volume" on page E-33.

CASIO CHORD

This method of chord play makes it possible for anyone to easily play chords, regardless of previous musical knowledge and experience. The following describes the CASIO CHORD "Accompaniment keyboard" and "Melody keyboard", and tells you how to play CASIO CHORDs.

CASIO CHORD Accompaniment Keyboard and Melody Keyboard

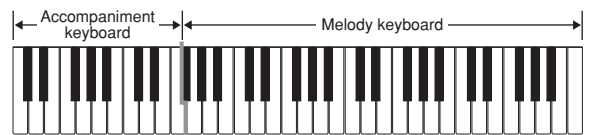

NOTE

- The accompaniment keyboard can be used for playing chords only. No sound will be produced if you try playing single melody notes on the accompaniment keyboard.

Chord Types

CASIO CHORD accompaniment lets you play four types of chords with minimal fingering.

Chord Types	Example
Major chords Major chord names are marked above the keys of the accompaniment keyboard. Note that the chord produced when you press an accompaniment keyboard does not change octave, regardless of which key you use to play it.	C Major (C)
Minor chords (m) To play a minor chord, keep the major chord key depressed and press any other accompaniment keyboard key located to the right of the major chord key.	C minor (Cm)
Seventh chords (7) To play a seventh chord, keep the major chord key depressed and press any other two accompaniment keyboard keys located to the right of the major chord key.	C seventh (C7)
Minor seventh chords (m7) To play a minor seventh chord, keep the major chord key depressed and press any other three accompaniment keyboard keys located to the right of the major chord key.	C minor seventh (Cm7)

NOTE

- It makes no difference whether you press black or white keys to the right of a major chord key when playing minor and seventh chords.

FINGERED

FINGERED provides you with a total of 15 different chord types. The following describes the FINGERED "Accompaniment keyboard" and "Melody keyboard", and tells you how to play a C-root chord using FINGERED.

FINGERED Accompaniment Keyboard and Melody Keyboard

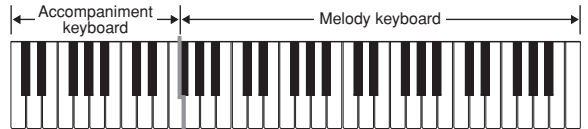

NOTE

- The accompaniment keyboard can be used for playing chords only. No sound will be produced if you try playing single melody notes on the accompaniment keyboard.

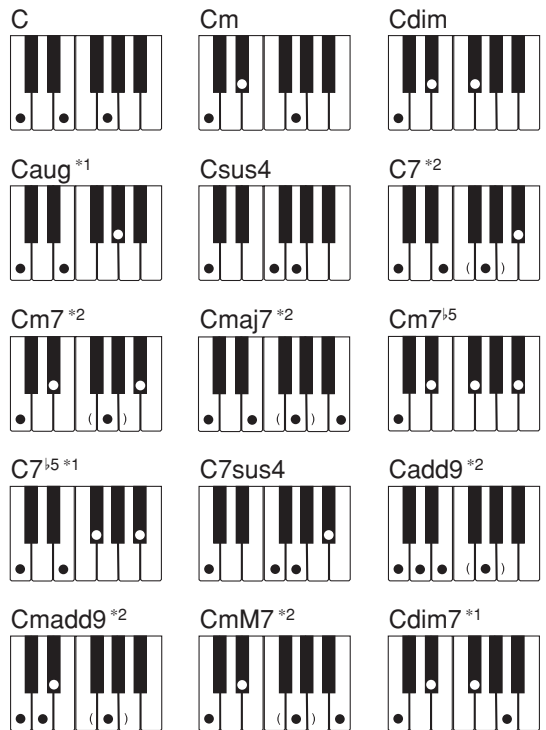

See the FINGERED Chord Chart on page A-5 for details on playing chords with other roots.

*1: Inverted fingerings cannot be used. The lowest note is the root.

*2: The same chord can be played without pressing the 5th G.

NOTE

- Except for the chords specified in note*1 above, inverted fingerings (i.e. playing E-G-C or G-C-E instead of C-E-G) will produce the same chords as the standard fingering.
- Except for the exception specified in note*2 above, all of the keys that make up a chord must be pressed. Failure to press even a single key will not play the desired FINGERED chord.

Using an Intro Pattern

This keyboard lets you insert a short intro into a rhythm pattern to make startup smoother and more natural.

The following procedure describes how to use the Intro feature. Before starting, you should first select the rhythm you want to use, and set the tempo.

To insert an intro

- 1 Press the INTRO button to start the selected rhythm with an intro pattern.
 - With the above setup, the intro pattern is played and the auto accompaniment with intro pattern starts as soon as you play chords on the accompaniment keyboard.

NOTE

- The standard rhythm pattern starts to play after the intro pattern is complete.
- Pressing the VARIATION/FILL-IN button while an intro pattern is playing causes the variation pattern to sound after the intro pattern is complete.

Using a Fill-in Pattern

Fill-in patterns let you momentarily change the rhythm pattern to add some interesting variation to your performances.

The following procedure describes how to use the Fill-in feature.

To insert a fill-in

- 1 Press the START/STOP button to start rhythm play.
- 2 Press the NORMAL/FILL-IN button to insert a fill-in pattern for the rhythm you are using.

NOTE

- The fill-in pattern does not play if you press the NORMAL/FILL-IN button while an intro pattern is playing.

Using a Rhythm Variation

In addition to the standard rhythm pattern, you can also switch to a secondary "variation" rhythm pattern for a bit of variety.

To insert the variation rhythm pattern

- 1 Press the START/STOP button to start rhythm play.
- 2 Press the VARIATION/FILL-IN button to switch to the variation pattern for the rhythm you are using.

NOTE

- To switch back to the standard rhythm pattern, press the NORMAL/FILL-IN button.

Using a Fill-in Pattern with a Variation Rhythm

You can also insert a fill-in pattern while a variation rhythm pattern is playing.

To insert a fill-in into a rhythm variation

- 1 While a variation rhythm pattern is playing, press the VARIATION/FILL-IN button to insert a fill-in pattern for the variation rhythm you are using.

Synchro Starting Accompaniment with Rhythm Play

You can set up the keyboard to start rhythm play at the same time you play the accompaniment on the keyboard.

The following procedure describes how to use synchro start. Before starting, you should first select the rhythm you want to use, set the tempo, and use the POWER/MODE switch to select the chord play method you want to use (NORMAL, CASIO CHORD, FINGERED).

To use synchro start

- 1 Press the SYNCHRO/ENDING button to put the keyboard into synchro start standby.



Flash

- 2 Playing a chord and the rhythm pattern starts to play automatically.

NOTE

- If the POWER/MODE switch is set to NORMAL, only the rhythm plays (without a chord) when you play on the accompaniment keyboard.
- If you press the INTRO button before playing anything on the keyboard, the rhythm starts automatically with an intro pattern when you play something on the accompaniment keyboard.
- Pressing the VARIATION/FILL-IN button before playing anything on the keyboard causes play to start with the variation pattern when something is played on the keyboard.
- To cancel synchro start standby, press the SYNCHRO/ENDING button one more time.

Finishing with an Ending Pattern

You can end your performances with an ending pattern that brings the rhythm pattern you are using to a natural-sounding conclusion.

The following procedure describes how to insert an ending pattern. Note that the actual ending pattern played depends on the rhythm pattern you are using.

To finish with an ending pattern

- 1 While the rhythm is playing, press the SYNCHRO/ENDING button.
 - This causes the ending pattern to play, which brings rhythm accompaniment to an end.

NOTE

- The timing when the ending pattern starts depends on when you press the SYNCHRO/ENDING button. If you press the button before the second beat of the current measure, the ending pattern starts playing immediately. Pressing the button at any point in the measure after the second beat results in the ending pattern playing from the beginning of the following measure.

To adjust built-in tune volume

Enter the Song Bank mode or Piano Bank mode, and then perform the procedure under "To adjust the accompaniment volume".

- In this case, a song volume screen will appear in place of the accompaniment volume screen.

NOTE

- Pressing [+] and [-] buttons at the same time automatically sets an accompaniment volume of 127.

To adjust volume for playback of SMF data from a memory card

Load a memory card into the card slot, and then perform the procedure under "To adjust the accompaniment volume".

- In this case, a song volume screen will appear in place of the accompaniment volume screen.

Transposing the Keyboard

Transpose lets you raise and lower the overall key of the keyboard in semitone units. If you want to play an accompaniment for a vocalist who sings in a key that's different from the keyboard, for example, simply use transpose to change the key of the keyboard.

To transpose the keyboard

- 1 Press the RHYTHM button to enter the Rhythm Mode.
 - Note that you cannot transpose the keyboard while in the Song Bank Mode or Piano Bank Mode.
- 2 Press the FUNCTION (LK-215: TOUCH RESPONSE/FUNCTION) button until the transpose screen appears on the display.
 - Example: To transpose the keyboard five semitones upwards.
- 3 Use [+] and [-] to change the transpose setting of the keyboard.
 - Example: To transpose the keyboard five semitones upwards.



NOTE

- The keyboard can be transposed within a range of -12 to +12.
- The default transpose setting is "00" when keyboard power is turned on.
- If you leave the transpose screen on the display for about five seconds without doing anything, the screen is automatically cleared.
- The transpose setting also affects playback from Auto Accompaniment.
- To return the keyboard to its default key, perform the above procedure and press the [+] and [-] buttons at the same time in step 3.
- The effect of a transpose operation depends on the pitch of each note and on the tone you are currently using. If a transpose operation causes a note to be outside of the allowable range for a tone, the same note in the nearest octave within the range will be substituted.

Tuning the Keyboard

Use the following procedure to fine tune the keyboard to match the tuning of another musical instrument.

To tune the keyboard

- 1 Press the FUNCTION (LK-215: TOUCH RESPONSE/FUNCTION) button until the tuning screen appears.



- 2 Use the [+], [-], and the number buttons to adjust the tuning value.
 - Example: To lower tuning by 20

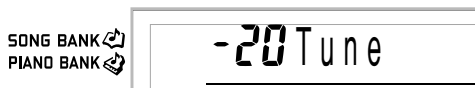

NOTE

- The keyboard can be tuned within a range of -50 cents to +50 cents.
 - * 100 cents is equivalent to one semitone.
- The default tuning setting is "00" when keyboard power is turned on.
- If you leave the tuning screen on the display for about five seconds without doing anything, the screen is automatically cleared.
- The tuning setting also affects playback from Auto Accompaniment.
- To return the keyboard to its default tuning, perform the above procedure and press the [+] and [-] buttons at the same time in step 2.

Connection to a Computer

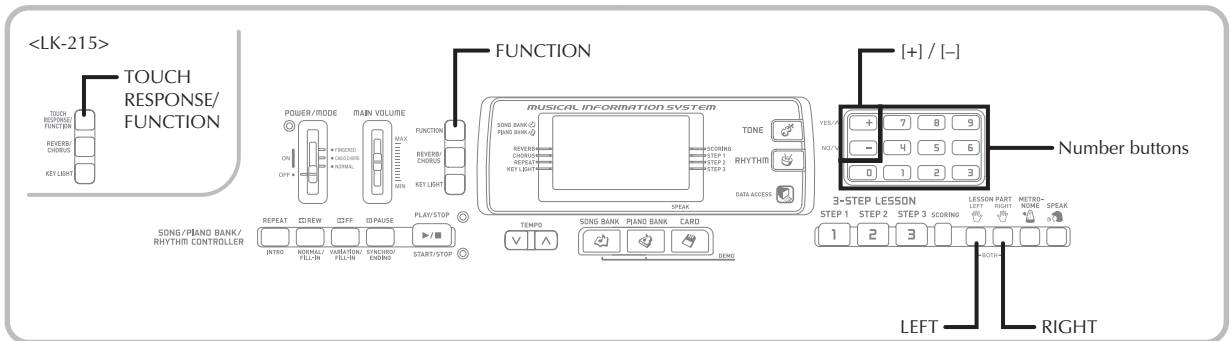

Connecting to a Computer

The keyboard's USB port makes it quick and simple to connect to a computer. After installing the USB MIDI driver onto your computer from the CD-ROM that comes with the keyboard, you will be able to use commercially available MIDI software on your computer to exchange data between the keyboard and your computer.

To install the USB MIDI driver

- 1 On the computer to which you plan to connect, install the USB MIDI driver that comes on the CD-ROM that comes bundled with the keyboard.
 - For information about installing the USB MIDI driver, see the "CASIO USB MIDI Driver User's Guide" (manual_e.pdf) on the "USB Manual and Driver CD-ROM".

NOTE

- Before starting actual installation of USB MIDI driver, be sure to read the contents of the "readme.txt" file in the "English" folder on the CD-ROM.
- Use Adobe Reader or Acrobat Reader to access the USB MIDI driver user's guide.*
- * You need to have Adobe Reader or Acrobat Reader installed on your computer in order to view the contents of the "CASIO USB MIDI Driver User's Guide" (manual_e.pdf). If your computer does not have either Adobe Reader or Acrobat Reader installed, use the procedure below to install it.

Installing Adobe Reader (Acrobat Reader**)

- Place the "USB Manual and Driver CD-ROM" into your computer's CD-ROM drive.
- On the CD-ROM, navigate to the folder named "Adobe", open the folder named "English", and then double-click "ar601enu.exe" ("ar505enu.exe"). Follow the instructions that appear on your computer screen to install Adobe Reader.

** Adobe Reader cannot be installed on a computer running Windows 98. If your computer is running under Windows 98, double-click "ar505enu.exe" to install Acrobat Reader.

Minimum Computer system Requirements

Supported Operating Systems

Operation is supported under Windows® XP Professional, Windows® XP Home Edition, Windows® 2000 Professional, Windows® Me, Windows® 98SE, and Windows® 98.

● Universal

- IBM AT or compatible computer
- USB port that provides normal operation under Windows
- CD-ROM drive (for installation)
- At least 2MB of free hard disk space (not including space required for Adobe Reader)

● Windows XP

- 300MHz or higher Pentium processor
- At least 128MB of memory

● Windows 2000

- 166MHz or higher Pentium processor
- At least 64MB of memory

● Windows Me, Windows 98SE, Windows 98

- 166MHz or higher Pentium processor
- At least 32MB of memory

NOTE

- Company and product names used herein are trademarks of their respective owners.

Using the USB port

Note that you need to purchase a commercially available USB cable to connect the keyboard to a computer using the USB port. Once you establish a USB connection between the keyboard and a computer, you can exchange data between them.

To connect to a computer using the USB port

- 1 Use a commercially available USB cable to connect the keyboard to the computer.

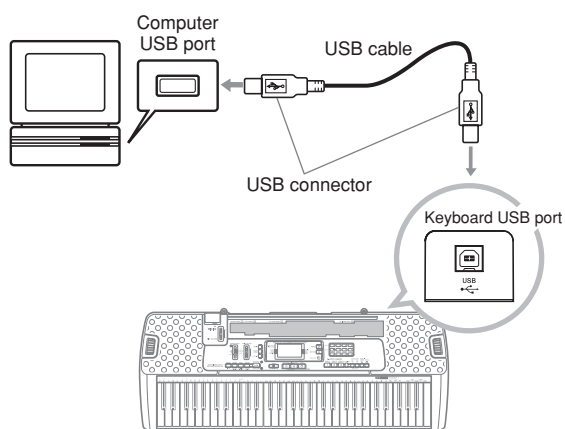

DATA ACCESS Lamp

- The DATA ACCESS lamp lights whenever the keyboard is exchanging data with a connected computer over a USB cable connection. Never disconnect the USB cable while the DATA ACCESS lamp is lit.

Expanding the Selections in the Song Bank Tunes

You can transfer song data from your computer to the keyboard. You can store up to 10 tunes (about 320 KB) as Song Bank tunes 65 through 74. For SMF data you purchase or create, you need to use an SMF Converter to convert it to CASIO format before transferring it to the keyboard.

To install the SMF Converter

- 1 On the computer to which you plan to connect, install the SMF Converter that comes on the CD-ROM that comes bundled with the keyboard.
 - On the CD-ROM, double-click "SMFConv-e.exe", and then follow the instructions that appear on your computer screen to install SMF Converter.

* Before installing SMF Converter, be sure to read the contents of the "smfreadme.txt" file in each language folder on the CD-ROM.

For information about using SMF Converter, double-click "index.html" in the [help] folder, which was created when you installed SMF Converter. You can also access user documentation from the Windows [Start] menu by clicking [Programs] - [CASIO] - [SMF Converter] - [manual].

* A browser that supports frames (like Internet Explorer 4 or Netscape Navigator 4.04 or higher) is required to view the SMF Converter manual.

Minimum Computer System Requirements

* Operating System:

Windows 98SE

Windows Me

Windows XP Home Edition/XP Professional

* Storage

At least 10MB free HDD space

* USB interface

- You can also obtain a copy of the SMF Converter by downloading it at the Web page shown below. After downloading, install the software on your computer.

CASIO MUSIC SITE

<http://music.casio.com/>

- In addition to the software itself, the CASIO MUSIC SITE will also provide you with information about its installation and use. You can also find out about the latest news about your keyboard and other CASIO musical instruments, and much more.

Song Data Storage

Song data saved as Song Bank tunes are retained even when power is turned off, as long as the keyboard is being supplied battery or AC adaptor power. If you remove the batteries or should the batteries go dead while the keyboard is not being supplied power by the AC adaptor, song data will be deleted. Be sure to supply power to the keyboard with the AC adaptor when replacing batteries.

NOTE

- This keyboard supports SMF 0 and 1 format data.
- Voice Fingering Guide and on-screen fingering indicators are not supported for commercially available SMF data.

General MIDI Tone

The General MIDI standard defines the tone numbering sequence, the drum sound numbering sequence, the number of MIDI channels that can be used, and other general factors that determine the sound source configuration. Because of this, musical data produced on a General MIDI sound source can be played back using similar tones and identical nuances as the original, even when played on another manufacturer's sound source.

This keyboard conforms with General MIDI standards, so it can be connected to a computer and used to play back General MIDI data that has been purchased, downloaded from the Internet, or obtained from any other source.

Changing the Settings

This section tells you how to make the settings required when connecting to a computer.

KEYBOARD CHANNEL (Default: 1)

The keyboard channel is the channel used to send messages from this keyboard to a computer. You can specify one channel from 1 to 16 as the keyboard channel.

- 1 Press the FUNCTION (LK-215: TOUCH RESPONSE/ FUNCTION) button until the KEYBOARD CHANNEL screen appears.



- 2 Use the [+], [-], and the number buttons to change the channel number.
Example: To specify channel 4



NAVIGATE CHANNEL (Default: 4)

When messages are received from a computer for play on this keyboard, the navigate channel is the channel whose note data appears on the display. You can select one channel from 01 to 16 as the navigate channel. Since this setting lets you use the data on any channel of commercially available SMF data to light on the on-screen keyboard guide, you can analyze how different parts of an arrangement are played.

- 1 Press the FUNCTION (LK-215: TOUCH RESPONSE/ FUNCTION) button until the NAVIGATE CHANNEL screen appears.



- 2 Use the [+], [-], and the number buttons [0] through [9] to change the channel number.

Example: To specify channel 2



To turn off specific sounds before playing back tune data that is being received

<<Navigate channel on/off>>

- 1 While playing tune data, press the RIGHT button.
 - This cuts the sound of the navigate channel, but on-screen keyboard guide keys continue to light in accordance with the channel's data as it is received. Press RIGHT button again to turn the channel back on.

<<Next lower channel from navigate channel on/off>>

- 1 While playing tune data, press the LEFT button.
 - This cuts the sound of the channel whose number is one less than the navigate channel, but on-screen keyboard guide keys continue to light in accordance with the channel's data as it is received. Press LEFT button again to turn the channel back on.

Example: If the navigate channel is channel 4, the above operation turns off channel 3.

LOCAL CONTROL (Default: On)

oFF: Anything played on the keyboard is output as a message from the USB port, without being sounded by the internal sound source.

- Note that no sound is produced by the keyboard if LOCAL CONTROL is turned off and no external device is connected.

- 1 Press the FUNCTION (LK-215: TOUCH RESPONSE/FUNCTION) button until the LOCAL CONTROL screen appears.

Example: When LOCAL CONTROL is on



- 2 Use the [+] and [-] or [0] and [1] buttons to turn the setting on and off.

Example: To turn LOCAL CONTROL off



ACCOMP OUT (Default: Off)

on: Auto Accompaniment is played by the keyboard and the corresponding message is output from the USB port.

oFF: Auto Accompaniment messages are not output from the USB port.

- 1 Press the FUNCTION (LK-215: TOUCH RESPONSE/FUNCTION) button until the ACCOMP OUT screen appears.

Example: When ACCOMP OUT is off



- 2 Use the [+] and [-] or [0] and [1] buttons to turn the setting on and off.

Example: To turn ACCOMP OUT on



GM Mode Receive

When GM off is received and the mode switch is set to a chord mode, the Auto Accompaniment chord is specified in accordance with the received message.

When GM on is received, Auto Accompaniment chords cannot be specified by received messages.

SUSTAIN/ASSIGNABLE JACK (Default: SUS)

SUS(sustain): Specifies a sustain*¹ effect when the pedal is depressed.

SoS (sostenuto): Specifies a sostenuto*² effect when the pedal is depressed.

SFt (soft): Specifies reduction of the sound's volume when the pedal is depressed.

rHy (rhythm): Specifies START/STOP button operation when the pedal is depressed.

- 1 Press the FUNCTION (LK-215: TOUCH RESPONSE/FUNCTION) button until the SUSTAIN/ASSIGNABLE JACK screen appears.

Example: When sustain is currently set



- 2 Use the [+] and [-] or [0], [1], [2], and [3] buttons to change the setting.

Example: To select rhythm



*1 Sustain

With piano tones and other sounds that decay, the pedal acts as a damper pedal, with sounds being sustained longer when the pedal is depressed. With organ tones and other continuous sounds, notes played on the keyboard continue to sound until the pedal is released. In either case, the sustain effect is also applied to any notes that are played while the pedal is depressed.

*2 Sostenuto

This effect performs the same way as sustain, except that it is applied only to notes that are sounding already when the pedal is depressed. It does not affect notes that are played after the pedal is depressed.

Using a Memory Card

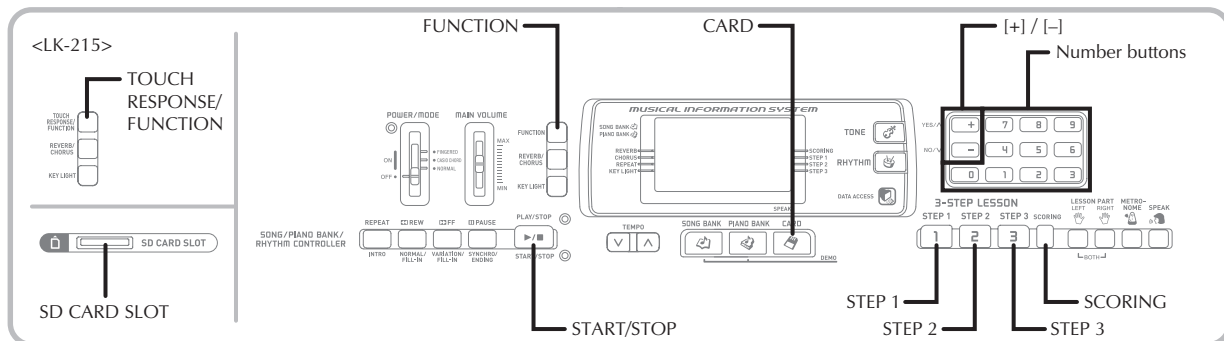

Your keyboard is equipped with a card slot that supports use of memory cards (commercially available SD memory card or optional CASIO song data card*). This makes it possible for the keyboard to directly read commercially available SMF data, which has been saved to a memory card from your computer, for listening pleasure and lessons. Memory card data can be used the same way as built-in tunes.



Supported Memory Cards:

SD memory cards, optional CASIO song data cards*

Supported SD Cards:

1 GB or less (Cards with capacity greater than 1 GB are not supported.)

Maximum Number of Importable Songs: Up to 1,000

- The actual number of songs that can be imported depends on the size of each file. The actual number will be less than 1,000 when individual song files are large.

Supported Data:

SMF Format 0, CASIO Original Format CM2

IMPORTANT!

- Use only an SD memory card or an optional CASIO song data card* with this keyboard. Proper operation is not guaranteed when any other type of card is used.

Memory Card and Card Slot Precautions

IMPORTANT!

- Be sure to carefully read all documentation that comes with the memory card for important information about how to handle it.
- SD memory cards have a write protect switch, which you can use to protect against accidental deletion of data. After saving important data to an SD memory card, be sure to use the write protect switch to protect the data against accidental changes or deletion.

- Avoid storing and using memory cards in the following types of locations. Such conditions can cause corruption of data stored on the card.
 - Areas subject to high temperatures, high humidity, or corrosive agents
 - Areas subject to strong electrostatic charge or electrical noise
- Whenever handling a memory card, make sure that you never touch its contacts with your fingers.
- If the data access lamp is lit and the message "Pls Wait" is on the display, it means that data on the memory card is being accessed by a save, read, or delete operation. Never remove the memory card from the card slot or turn off the keyboard while the card is being accessed. Doing so can corrupt the data on the memory card or even damage the card slot.
- Never try to insert anything that is not an SD memory card or optional CASIO song data card* into the Keyboard's memory card slot. Doing so can cause malfunction of the keyboard.
- Inserting a memory card that is charged with static electricity into the card slot can cause malfunction of the keyboard. If this happens, turn the keyboard off and then back on again.
- A memory card that has been in the card slot for a long time may feel hot when you remove it. This is normal and does not indicate malfunction.
- Note that a memory card has a limited service life. After long use, you may not be able to store data to, read data from, and/or delete data from a card. When this happens, you will need to purchase a new memory card.

* May not be available in some geographic areas.

CASIO COMPUTER CO., LTD. assumes no responsibility for any loss or damage to you or any third party arising out of the loss or corruption of data.

Inserting and Removing a Memory Card

IMPORTANT!

- Make sure you turn off the keyboard before inserting or removing a memory card.
- Be sure to orient the card correctly when inserting it. Never try to force a memory card into the card slot when you feel resistance.
- Never remove the memory card from the card slot or turn off the keyboard while card data is being accessed by a read or format operation. Doing so can corrupt the data on the memory card or even damage the card slot.

To insert a memory card into the card slot

- 1 With the front side of the memory card facing upwards, carefully slide it into the card slot. Slide the card all the way in until you hear it click securely into place.

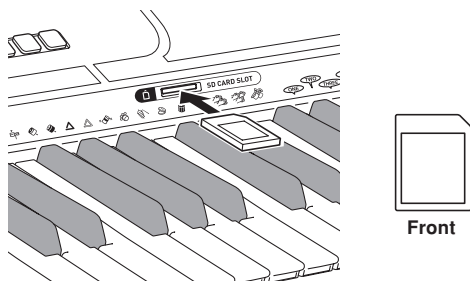

To remove a memory card from the card slot

- 1 Press the memory card into the card slot and then release it. This will cause the card to come part way out of the keyboard.
- 2 Pull the memory card out of the card slot.

Getting Ready

IMPORTANT!

- Before you can use an SD memory card with this keyboard, you need to perform the procedure below to format it. After formatting the card, transfer SMF data from your computer to the card.
- Formatting an SD memory card with this keyboard automatically creates a folder named "MUSICDAT" on the card. When transferring SMF data from your computer to the card for use by the keyboard, be sure to store it in the "MUSICDAT" folder.
- Note that formatting a card that already contains data causes all of that data to be deleted. Data deleted by the format operation cannot be recovered. Before performing the procedure below, check to make sure that the media does not contain any data you might need.

PREPARATION

- Insert the SD memory card you want to format into the keyboard's card slot. Make sure that the SD memory card's write protect is removed, which enables writing.

To format an SD memory card

- 1 Press the FUNCTION (LK-215: TOUCH RESPONSE/FUNCTION) button a number of times until the card format setting screen appears.

SONG BANK ↺
PIANO BANK ↺

CardFormat ?

- 2 Press the [+] (YES) button.
 - This will display a confirmation message asking whether you really want to format the media.
- 3 Press the [+] (YES) button to start formatting.
 - The message "Pls Wait" will remain on the display to indicate that a procedure is being performed. Never try to perform any other operation on the keyboard while the card is being formatted. After formatting is complete, the keyboard returns to the mode you were in before you displayed the setting screen.
 - To cancel the format operation, press the [-] (NO) button. This returns to the card format setting screen.
 - If an error message appears on the display, see "Memory Card Error Messages" on page E-42. Pressing the FUNCTION (LK-215: TOUCH RESPONSE/FUNCTION) button while an error message is on the display returns to the card format setting screen.

Reading a Memory Card

- 1 Press the CARD button.

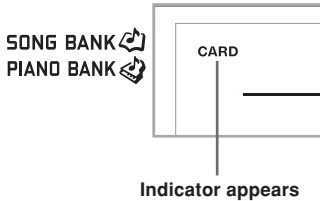

- 2 Use the number buttons to input the three-digit number that corresponds to the SMF data you want to select.
- 3 Perform one of the following operations.

■ To play back SMF data

- 3-1 Press the START/STOP button.
 - The keyboard will read the SMF data and play it.

■ To use SMF data in a 3-Step Lesson

- 3-1 Press the STEP 1, STEP 2, or STEP 3 button.
 - The keyboard will read the SMF data and start a lesson at the step you selected.
 - An error message will appear if the selected SMF data file is larger than about 320 KB.
 - If an error message appears, see “Memory Card Error Messages” on the following page for information about what you need to do.
 - The channel specified as the navigate channel is assigned to the right-hand part, while the channel that is one less than the channel specified as the navigate channel is assigned to the left-hand part.
 - Voice Fingering Guide and on-screen fingering indicators, are not supported for SMF data.

■ To evaluate your play using SMF Data

- 3-1 Press the SCORING button.
 - The keyboard will read the SMF data and enter the Evaluation Mode.
 - An error message will appear if the selected SMF data file is larger than about 320 KB.
 - If an error message appears, see “Memory Card Error Messages” on the following page for information about what you need to do.
 - The channel specified as the navigate channel is assigned to the right-hand part, while the channel that is one less than the channel specified as the navigate channel is assigned to the left-hand part.
 - On-screen fingering indicators are not supported for SMF data.
- 4 Press the START/STOP button to stop SMF data play.

Memory Card Error Messages

Display Message	Cause	Action
Err No Card	There is no memory card loaded in the keyboard or the memory card you are using is not loaded correctly.	Load a memory card or correctly reinsert the memory card. page E-40
Err No File	(1) The memory card song data that is supported by the keyboard is not in the MUSICDAT folder. (2) The memory card does not have a MUSICDAT folder.	(1) Move the files containing song data supported by the keyboard to the MUSICDAT folder. (2) Create a MUSICDAT folder and move the applicable files into the folder. Formatting the card will create a MUSICDAT folder automatically. page E-40
Err WrongDat	The data is damaged.	Take the necessary steps to replace the damaged data with normal data.
Err SizeOver	The file is too large to be played by this keyboard.	The maximum supported file size is 320 KB. Select a smaller file. page E-41
Err Protect	The memory card is write-protected.	Remove write protection and re-format the card. pages E-39, 40
Err Format	(1) The memory card has a format that is not supported by this keyboard. (2) The memory card has a capacity that is not supported by this keyboard. (3) There is something wrong with the memory card.	(1) Use this keyboard to format the card. page E-40 (2) This keyboard supports cards with a capacity of 1 GB or less. page E-39 (3) Use a different card.
Err Not SMF0	There is no Format 0 SMF format file. This keyboard supports Format 0 SMF files only.	Use a Format 0 SMF format file. page E-39
Err Card R/W	The memory card cannot be written to or formatted for some reason.	Use a different card.



<p>Err Mem Full</p>	<p>The keyboard ran out of memory for SMF data reading during a playback, lesson or use of the evaluation feature.</p> <p>After a few seconds, the “Err Mem Full” message will be replaced by one of the messages described below.</p> <p><“dEL UsrSong?”></p> <p>This message asks whether you want to delete the contents of Song Bank user area for storage of SMF data (10 songs) in order to make room for the SMF data you are trying to read. To clear this message and return to the Card Bank Mode screen, press the [-] (NO) button.</p> <ol style="list-style-type: none"> 1) Press the [+] (YES) button if you want to delete Song Bank user area contents. <ul style="list-style-type: none"> • This causes a confirmation message to appear on the display. • If you want to cancel the delete operation, press the [-] (NO) button. This returns you to the confirmation message. 2) Press the [+] (YES) button to delete Song Bank user area contents. <ul style="list-style-type: none"> • After Song Bank user area contents are deleted, the keyboard automatically starts reading of the SMF data you originally selected, and then starts the playback, lesson, or evaluation. 	<pre> graph TD A["Card Bank Mode screen Playback Step 1 to 3 Scoring 1 to 3"] --> B["Err Mem Full"] B -- "After a few seconds" --> C["dEL UsrSong?"] C -- "NO(-)" --> A C -- "YES(+)" --> D["Sure ?"] D -- "YES(+)" --> E["Pls Wait"] E --> F["The keyboard starts the playback, lesson, or evaluation"] </pre>
----------------------------	--	---

Troubleshooting

Problem	Possible Cause	Action	See page
No keyboard sound	(1) Power supply problem. (2) Power is not turned on. (3) Volume setting is too low. (4) The POWER/MODE switch is in the CASIO CHORD or FINGERED position. (5) LOCAL CONTROL is off.	(1) Correctly attach the AC adaptor, make sure that batteries poles (+/-) are facing correctly, and check to make sure that batteries are not dead. (2) Adjust the POWER/MODE switch to turn on power. (3) Use the MAIN VOLUME slider to increase volume. (4) Normal play is not possible on the accompaniment keyboard while the POWER/MODE switch is set to CASIO CHORD or FINGERED. Change the POWER/MODE switch setting to NORMAL. (5) Turn on LOCAL CONTROL.	Page E-13 Page E-16 Page E-16 Page E-29 Page E-38
Any of the following symptoms while using battery power.	Low battery power	Replace the batteries with a set of new ones or use the AC adaptor.	Pages E-12, 13
<div style="border: 1px solid black; padding: 10px;"> <ul style="list-style-type: none"> • Dim power supply indicator • Instrument does not turn on • Dim, difficult to read display • Abnormally low speaker/headphone volume • Distortion of sound output • Occasional interruption of sound when playing at high volumes • Sudden power failure when playing at high volumes • Dimming of the display when playing at high volume • Continued sound output even after you release a key • A totally different tone may sound • Abnormal rhythm pattern and demo tune play • Abnormally low microphone volume • Distortion of microphone input • Dim power supply indicator when a microphone is used • Sudden power failure when using the microphone • Dimming of keyboard lights when notes sound • Loss of power, sound distortion, or low volume when playing from a connected computer </div>			
Auto Accompaniment does not sound.	Accompaniment volume is set to 000.	Use the FUNCTION (LK-215: TOUCH RESPONSE/FUNCTION) button to increase the volume.	Page E-33
Key light stays on.	Keyboard is waiting for play of the correct note during Step 1 or Step 2 play.	<ul style="list-style-type: none"> • Press the lit key to continue with Step 1 or Step 2 play. • Press the PLAY/STOP button to quit Step 1 or Step 2 play. 	Pages E-25, 26 Pages E-25, 26
Keys are lit though no sound is being produced.	Power on alert is reminding you that power was left on without any operation being performed.	Press any button or keyboard key to restore power to normal.	Page E-14
Cannot record chord accompaniment data on a computer.	ACCOMP OUT is turned off.	Turn on ACCOMP OUT.	Page E-38
Static noise when a microphone is connected.	Use of the microphone in the vicinity of fluorescent lighting.	Move the microphone away from source of the static.	Page E-17



Problem	Possible Cause	Action	See page
No microphone sound	(1) Microphone volume setting is too low. (2) Microphone on/off switch is set to off.	(1) Increase the microphone volume setting. (2) Change the microphone on/off switch setting to on.	Page E-17 Page E-17
Cannot recall data from a memory card.	(1) The memory card is not inserted correctly into the card slot. (2) The memory card is damaged. (3) The data has not been copied to the memory card MUSICDAT folder.	(1) Correctly insert the memory card into the card slot. (2) Use a different memory card. (3) Insert a formatted memory card into the memory card slot of your computer, and copy the data you want to play back into the directory named "MUSICDAT".	Page E-40
Song play momentarily cuts out at some points during SMF play.	Data is fragmented.	Perform either of the two following operations. <ul style="list-style-type: none"> Without deleting the original (fragmented) data, perform a "save as" operation to save the data under a different name. Next, try performing the operation using the newly saved data. If you saved the data to the card from another location, format the card (which will delete its contents), and then save the data to the card again. Next, try performing the operation using the newly saved data. 	— Page E-40
Auto accompaniment chords do not sound.	The keyboard is in the Song Bank mode.	Press the RHYTHM button to enter the rhythm mode, which is indicated by the rhythm indicator on the display.	Page E-28
After transferring song data from my computer, playback stops part way through.	Digital noise from the USB cable or power cord caused data communication between your computer and keyboard to be interrupted.	Stop playback, disconnect the USB cable from and then reconnect it to the keyboard's USB port, and then try playing back the tune again. If this does not correct the problem, exit the MIDI software you are using, and then disconnect the USB cable from and then reconnect it to the keyboard's USB port. Next, restart your MIDI software and try playback again.	Page E-36
A tone's quality and volume sounds slightly different depending where it is played on the keyboard.	This is an unavoidable result of the digital sampling process,* and does not indicate malfunction. * Multiple digital samples are taken for the low range, middle range, and high range of the original musical instrument. Because of this, there may be a very slight difference in tonal quality and volume between sample ranges.		

Specifications

Models:	LK-210/LK-215
Keyboard:	61 standard-size keys, 5 octaves (with touch response <LK-215 only>)
Key Light System:	Can be turned on and off (up to 10 keys can be lit at the same time)
Tones:	264 (128 panel tones + 128 General MIDI tones + 8 drum sets)
Digital Effects:	Reverb (4 types), Chorus (4 types)
Polyphony:	32 notes maximum (16 for certain tones)
Auto Accompaniment Rhythm Patterns: Chords: Rhythm Controller: Accomp Volume:	120 2 fingering methods (CASIO CHORD, FINGERED) START/STOP, INTRO, NORMAL/FILL-IN, VARIATION/FILL-IN, SYNCHRO/ENDING 0 to 127 (128 steps)
3-step Lesson: Playback: Lesson Part: Evaluation Mode: Voice Fingering Guide:	3 lessons (Step 1, 2, 3) Repeat play of a single tune Left hand, right hand, both hands Scoring On/Off
Song Bank, Piano Bank Number of Tunes: Controllers:	100 (Song Bank: 65, Piano Bank: 35) PLAY/STOP, PAUSE, FF, REW, REPEAT
User Songs:	Number of Songs: Up to 10 download songs Capacity: Approximately 320 KB* * Calculated based on 1 KB = 1024 bytes.
Metronome: Beat Specification:	On/Off 0, 2 to 6
Other Functions Tempo: Transpose: Tuning:	Variable (226 steps, ♩ = 30 to 255) 25 steps (-12 semitones to +12 semitones) 101 steps (A4 = approximately 440 Hz ±50 Cents)
Card Supported Memory Cards: Supported SD Cards: Maximum Number of Importable Songs: Supported Data:	SD memory cards, optional CASIO song data cards* * May not be available in some geographic areas. 1 GB or less (Cards with capacity greater than 1 GB are not supported.) Up to 1,000 SMF Format 0, CASIO Original Format CM2
Terminals SUSTAIN/ASSIGNABLE JACK: PHONES/OUTPUT Jack: Microphone In: USB port: SD CARD SLOT	Standard jack (sustain, sostenuto, soft, rhythm start/stop) Stereo standard jack Output Impedance: 78 Ω Output Voltage: 4.5 V (RMS) MAX Standard jack Input impedance: 2 KΩ Input sensitivity: 10 mV TYPE B
Power Jack:	9V DC

Power Supply: Batteries: Battery Life: AC Adaptor: Auto Power Off:	2-way 6 AA-size batteries Approximately 1 hour continuous operation on manganese batteries Approximately 4 hours continuous operation on alkaline batteries AD-5 Turns power off approximately 6 minutes after last key operation. Enabled under batter power only, can be disabled manually.
Speaker Output:	<LK-210> 2.0W + 2.0W <LK-215> 2.5W + 2.5W
Power Consumption:	9V --- 7.7W
Dimensions:	94.5 × 37.3 × 13.5 cm (37 ¹ / ₄ × 14 ¹¹ / ₁₆ × 5 ⁵ / ₁₆ inch)
Weight:	Approximately 4.7kg (10.4 lbs)(without batteries)

- Design and specifications are subject to change without notice.

Operating Precautions

Be sure to read and observe the following operating precautions.

■ Location

Avoid the following locations for this product.

- Areas exposed to direct sunlight and high humidity
- Areas subjected to temperature extremes
- Near a radio, TV, video deck, or tuner

The above devices will not cause malfunction of the product, but interference from the product can cause audio or video interference of a nearby device.

■ User Maintenance

- Never use benzene, alcohol, thinner, or other chemical agents to clean the product.
- To clean the product or its keyboard, wipe with a soft cloth moistened in a weak solution of water and a mild neutral detergent. Wring all excess moisture from the cloth before wiping.

■ Included and Optional Accessories

Use only accessories that are specified for use with this product. Use of unauthorized accessories creates the risk of fire, electric shock, and personal injury.

■ Weld Lines

Lines may be visible on the exterior of the product. These are “weld lines” that result from the plastic molding process. They are not cracks or scratches.

■ Musical Instrument Etiquette

Always be aware of others around you whenever using this product. Be especially careful when playing late at night to keep the volume at levels that do not disturb others. Other steps you can take when playing late at night are closing the window and using headphones.

- Any reproduction of the contents of this manual, either in part or its entirety, is prohibited. Except for your own, personal use, any other use of the contents of this manual without the consent of CASIO is prohibited under copyright laws.
- IN NO EVENT SHALL CASIO BE LIABLE FOR ANY DAMAGES WHATSOEVER (INCLUDING, WITHOUT LIMITATION, DAMAGES FOR LOSS OF PROFITS, BUSINESS INTERRUPTION, LOSS OF INFORMATION) ARISING OUT OF THE USE OF OR INABILITY TO USE THIS MANUAL OR PRODUCT, EVEN IF CASIO HAS BEEN ADVISED OF THE POSSIBILITY OF SUCH DAMAGES.
- The contents of this manual are subject to change without notice.

Tone List / Note Table

Lista de sonidos / Tabla de notas

- ① : No. /Nº
- ② : Maximum Polyphony/Polfonia máxima

①	②	③	④	⑤	⑥
000	PIANO PIANO	A	16	000	002
001	STEREO PIANO	A	32	000	001
002	GRAND PIANO	A	16	001	002
003	BRIGHT PIANO	A	16	000	003
004	MODERN PIANO	A	16	001	003
005	DANCE PIANO	A	32	001	001
006	STRINGS PIANO	A	16	000	008
007	HONKY-TONK	A	16	003	002
008	OCTAVE PIANO	A	16	003	008
009	ELEC.GRAND PIANO	A	16	002	002
010	MODERN E.G.PIANO	A	16	002	003
011	ELEC.PIANO	A	32	004	002
012	CHORUSED EP	A	16	004	009
013	MODERN E.PIANO	A	16	005	002
014	SOFT E.PIANO	A	16	004	008
015	E.PIANO PAD	A	16	005	008
016	HARPSICHORD	A	32	006	002
017	COUPLED HARPSICHORD	A	16	006	008
018	CLAVI	A	32	007	002
CHROMATIC PERC					
019	CELESTA	A	32	008	002
020	GLOCKENSPIEL	B	32	009	002
021	VIBRAPHONE	A	32	011	002
022	MARIMBA	A	32	012	002
ORGAN					
023	DRAWBAR ORGAN 1	A	16	016	002
024	DRAWBAR ORGAN 2	A	16	016	001
025	DRAWBAR ORGAN 3	A	16	016	003
026	PERC.ORGAN 1	A	16	017	002
027	PERC.ORGAN 2	A	16	017	003
028	ELEC.ORGAN 1	A	16	016	008
029	ELEC.ORGAN 2	A	16	017	004
030	JAZZ ORGAN	A	16	017	004
031	ROCK ORGAN	A	16	018	002
032	CHURCH ORGAN	A	16	019	002
033	CHAPEL ORGAN	A	32	019	008
034	ACCORDION	A	16	021	002
035	OCTAVE ACCORDION	A	16	021	008
036	BANDONEON	A	16	023	002
037	HARMONICA	A	32	022	002
GUITAR					
038	NYLON STR.GUITAR	C	32	024	002
039	STEEL STR.GUITAR	C	32	025	002
040	12 STR.GUITAR	C	16	025	008
041	JAZZ GUITAR	C	32	026	002
042	OCT JAZZ GUITAR	C	16	026	008
043	CLEAN GUITAR	C	32	027	002
044	ELEC.GUITAR	C	16	027	001
045	MUTE GUITAR	C	32	028	002

- ② : Tone Name/Nombre de sonido
- ③ : Program Change/Cambio de programa

①	②	③	④	⑤	⑥
046	OVERDRIVE GT	C	32	029	002
047	DISTORTION GT	C	32	030	002
048	FEEDBACK GT	C	16	031	008
BASS					
049	ACOUSTIC BASS	C	32	032	002
050	RIDE BASS	C	16	032	032
051	FINGERED BASS	C	32	033	002
052	PICKED BASS	C	32	034	002
053	FRETLESS BASS	C	32	035	002
054	SLAP BASS	C	32	037	002
055	SAW SYNTH-BASS	C	32	038	002
056	SQR SYNTH-BASS	C	32	039	002
STR/ORCHESTRA					
057	VIOLIN	A	32	040	002
058	SLOW VIOLIN	A	32	040	008
059	CELLO	C	32	042	002
060	PIZZICATO STRINGS	A	32	045	002
061	HARP	A	32	046	002
ENSEMBLE					
062	STRINGS	A	32	048	002
063	SLOW STRINGS	A	32	049	002
064	CHAMBER	A	16	048	003
065	SYNTH-STRINGS 1	A	32	050	002
066	SYNTH-STRINGS 2	A	32	051	002
067	CHOIR AAHS	A	32	052	002
068	CHOIRS	A	32	052	008
069	VOICE DOO	A	32	053	002
070	SYNTH-VOICE	A	32	054	002
071	SYNTH-VOICE PAD	A	16	054	008
072	ORCHESTRA HIT	A	16	055	002
BRASS					
073	TRUMPET	A	32	056	002
074	TROMBONE	C	32	057	002
075	TUBA	C	32	058	002
076	MUTE TRUMPET	A	32	059	002
077	FRENCH HORN	C	16	060	002
078	BRASS	A	32	061	002
079	BRASS SECTION	A	16	061	003
080	BRASS SFZ	A	16	061	008
081	ANALOG SYNTH-BRASS	A	16	062	008
082	SYNTH-BRASS 1	A	32	062	002
083	SYNTH-BRASS 2	A	16	063	002
REED					
084	SOPRANO SAX	A	32	064	002
085	ALTO SAX 1	C	16	065	001
086	ALTO SAX 2	C	32	065	002
087	BREATHY A.SAX	C	16	065	008
088	TENOR SAX 1	C	16	066	001
089	TENOR SAX 2	C	32	066	002
090	BREATHY T.SAX	C	16	066	008

- ③ : Range Type/Tipo de gama
- ④ : Bank Select MSB/MSB de selección de banco

①	②	③	④	⑤	⑥
091	T-SAXYS	C	16	066	009
092	BARITONE SAX	C	32	067	002
093	OBOE	A	32	068	002
094	CLARINET	A	32	071	002
PIPE					
095	PICCOLO	B	32	072	002
096	FLUTE 1	A	32	073	002
097	FLUTE 2	A	16	073	001
098	MELLOW FLUTE	A	16	073	008
099	RECORDER	A	32	074	002
100	PAN FLUTE	A	32	075	002
101	WHISTLE	A	32	078	002
SYNTH LEAD					
102	SQUARE LEAD	A	16	080	002
103	SAWTOOTH LEAD	A	16	081	002
104	MELLOW SAW LEAD	A	16	081	008
105	SINE LEAD	A	32	080	003
106	SS LEAD	A	16	081	003
107	GALLOPE	A	16	082	002
108	VOICE LEAD	A	16	085	002
109	BASS-LEAD	A	16	087	002
SYNTH PAD					
110	FANTASY	A	16	088	002
111	WARM PAD	A	16	089	002
112	WARM VOX	A	16	089	002
113	POLY SYNTH	A	16	090	002
114	POLY SAW	A	16	090	008
115	BOWED PAD	A	16	092	002
116	HALO PAD	A	16	094	002
117	ATMOSPHERE	A	16	099	002
118	BRIGHTNESS	A	16	100	002
119	ECHO PAD	A	16	102	002
120	STAR THEME	A	16	103	002
121	SPACE PAD	A	16	103	008
ETHNIC					
122	SITAR	A	16	104	002
123	BANJO	A	32	105	002
124	SHAMISEN	A	32	106	002
125	KOTO	A	32	107	002
126	THUMB PIANO	A	32	108	002
127	STEEL DRUMS	A	16	114	002
GM TONE					
128	GM PIANO 1	A	32	000	000
129	GM PIANO 2	A	32	001	000
130	GM PIANO 3	A	32	002	000
131	GM HONKY-TONK	A	16	003	000
132	GM E.PIANO 1	A	32	004	000
133	GM E.PIANO 2	A	16	005	000
134	GM HARPSICHORD	A	32	006	000
135	GM CLAVI	A	32	007	000

1	2	3	4	5	6
254	GM APPLAUSE	D	16	126	000
255	GM GUNSHOT	D	32	127	000
DRUMS					
256	STANDARD SET	D	32	000	120
257	ROOM SET	D	32	008	120
258	POWER SET	D	32	016	120
259	ELECTRONIC SET	D	32	024	120
260	SYNTH SET	D	32	025	120
261	JAZZ SET	D	32	032	120
262	BRUSH SET	D	32	040	120
263	ORCHESTRASET	D	32	048	120

NOTE

• The meaning of each range type is described below.

NOTA



• El significado de cada tipo de gama se describe debajo.

1	2	3	4	5	6
195	GM BARITONE SAX	A	32	067	000
196	GM OBOE	A	32	068	000
197	GM ENGLISH HORN	A	32	069	000
198	GM BASSOON	A	32	070	000
199	GM CLARINET	A	32	071	000
200	GM PICCOLO	A	32	072	000
201	GM FLUTE	A	32	073	000
202	GM RECORDER	A	32	074	000
203	GM PAN FLUTE	A	32	075	000
204	GM BOTTLE BLOW	A	16	076	000
205	GM SHAKUHACHI	A	16	077	000
206	GM WHISTLE	A	32	078	000
207	GM OCARINA	A	32	079	000
208	GM SQUARE LEAD	A	16	080	000
209	GM SAWTOOTH LEAD	A	16	081	000
210	GM CALLIOPE	A	16	082	000
211	GM CHIFF LEAD	A	16	083	000
212	GM CHARANG	A	16	084	000
213	GM VOICE LEAD	A	16	085	000
214	GM FIFTH LEAD	A	16	086	000
215	GM BASS+LEAD	A	16	087	000
216	GM FANTASY	A	16	088	000
217	GM WARM PAD	A	16	089	000
218	GM POLYSYNTH	A	16	090	000
219	GM SPACE CHOIR	A	16	091	000
220	GM BOWED GLASS	A	16	092	000
221	GM METAL PAD	A	16	093	000
222	GM HALO PAD	A	16	094	000
223	GM SWEEP PAD	A	16	095	000
224	GM RAIN DROP	A	16	096	000
225	GM SOUND TRACK	A	16	097	000
226	GM CRYSTAL	A	16	098	000
227	GM ATMOSPHERE	A	16	099	000
228	GM BRIGHTNESS	A	16	100	000
229	GM GOBLINS	A	16	101	000
230	GM ECHOES	A	16	102	000
231	GM SF	A	16	103	000
232	GM SITAR	A	16	104	000
233	GM BANJO	A	32	105	000
234	GM SHAMISEN	A	32	106	000
235	GM KOTO	A	32	107	000
236	GM THUMB PIANO	A	32	108	000
237	GM BAGPIPE	A	16	109	000
238	GM FIDDLE	A	32	110	000
239	GM SHANAI	A	32	111	000
240	GM TINKLE BELL	A	32	112	000
241	GM AGOGO	A	32	113	000
242	GM STEEL DRUMS	A	16	114	000
243	GM WOOD BLOCK	D	32	115	000
244	GM TAIKO	D	32	116	000
245	GM MELODIC TOM	D	32	117	000
246	GM SYNTH-DRUM	D	32	118	000
247	GM REVERSE CYMBAL	D	32	119	000
248	GM GT FRET NOISE	A	32	120	000
249	GM BREATH NOISE	A	32	121	000
250	GM SEASHORE	D	16	122	000
251	GM BIRD	D	16	123	000
252	GM TELEPHONE	D	32	124	000
253	GM HELICOPTER	D	32	125	000

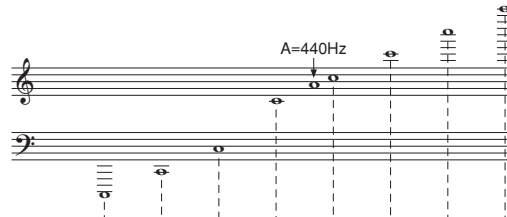
1	2	3	4	5	6
136	GM CELESTA	A	32	008	000
137	GM GLOCKENSPIEL	A	32	009	000
138	GM MUSIC BOX	A	16	010	000
139	GM VIBRAPHONE	A	32	011	000
140	GM MARIMBA	A	32	012	000
141	GM XYLOPHONE	A	32	013	000
142	GM TUBULAR BELL	A	32	014	000
143	GM DULCIMER	A	16	015	000
144	GM ORGAN 1	A	16	016	000
145	GM ORGAN 2	A	16	017	000
146	GM ORGAN 3	A	16	018	000
147	GM PIPE ORGAN	A	16	019	000
148	GM REED ORGAN	A	32	020	000
149	GM ACCORDION	A	16	021	000
150	GM HARMONICA	A	32	022	000
151	GM BANDONEON	A	16	023	000
152	GM NYLON STR.GUITAR	A	32	024	000
153	GM STEEL STR.GUITAR	A	32	025	000
154	GM JAZZ GUITAR	A	32	026	000
155	GM CLEAN GUITAR	A	32	027	000
156	GM MUTE GUITAR	A	32	028	000
157	GM OVERDRIVE GT	A	32	029	000
158	GM DISTORTION GT	A	32	030	000
159	GM GT HARMONICS	A	32	031	000
160	GM ACOUSTIC BASS	A	32	032	000
161	GM FINGERED BASS	A	32	033	000
162	GM PICKED BASS	A	32	034	000
163	GM FRETLESS BASS	A	32	035	000
164	GM SLAP BASS 1	A	32	036	000
165	GM SLAP BASS 2	A	32	037	000
166	GM SYNTH-BASS 1	A	32	038	000
167	GM SYNTH-BASS 2	A	32	039	000
168	GM VIOLIN	A	32	040	000
169	GM VIOLA	A	32	041	000
170	GM CELLO	A	32	042	000
171	GM CONTRABASS	A	32	043	000
172	GM TREMOLO STRINGS	A	32	044	000
173	GM PIZZICATO	A	32	045	000
174	GM HARP	A	32	046	000
175	GM TIMPANI	A	32	047	000
176	GM STRINGS 1	A	32	048	000
177	GM STRINGS 2	A	32	049	000
178	GM SYNTH-STRINGS 1	A	32	050	000
179	GM SYNTH-STRINGS 2	A	32	051	000
180	GM CHOIR AAHS	A	32	052	000
181	GM VOICE DOO	A	32	053	000
182	GM SYNTH-VOICE	A	32	054	000
183	GM ORCHESTRA HIT	A	16	055	000
184	GM TRUMPET	A	32	056	000
185	GM TROMBONE	A	32	057	000
186	GM TUBA	A	32	058	000
187	GM MUTE TRUMPET	A	32	059	000
188	GM FRENCH HORN	A	16	060	000
189	GM BRASS	A	32	061	000
190	GM SYNTH-BRASS 1	A	32	062	000
191	GM SYNTH-BRASS 2	A	16	063	000
192	GM SOPRANO SAX	A	32	064	000
193	GM ALTO SAX	A	32	065	000
194	GM TENOR SAX	A	32	066	000



Range Type/ Tipo de gama	C-1	C0	C1	C2	C3	C4	C5	C6	C7	G7	C8	C9	G9	
A (Standard type) (Tipo estándar)				[Keyboard range bar from C2 to C8]										
B ("020 GLOCKENSPIEL") ("095 PICCOLO") ("020 GLOCKENSPIEL") ("095 PICCOLO")				[Keyboard range bar from C3 to C9]										
C (Low pitch) instruments (Instrumentos de altura tonal baja)			[Keyboard range bar from C1 to C7]											
D (Sound Effect) (Efecto de sonido)	No scale for tones. Sin escala para los sonidos.													

- a Keyboard range
.....Gama del teclado
- b Available range (using transpose or a message receive)
.....Gama disponible (usando la transposición o recepción de mensaje)

Drum Assignment List / Lista de asignación de batería

NOTE " ← " Indicates the same sound as STANDARD SET.

NOTA " ← " Indica el mismo sonido que STANDARD SET.

Key/Note number	Drumset 1 STANDARD SET	Drumset 2 ROOM SET	Drumset 3 POWER SET	Drumset 4 ELECTRONIC SET	Drumset 5 SYNTH SET	Drumset 6 JAZZ SET	Drumset 7 BRUSH SET	Drumset 8 ORCHESTRA SET
E1 28	High Q							Closed Hi-Hat
F1 29	Scratch Pull							Pedal Hi-Hat
F#1 30	Scratch Push							Open Hi-Hat
G1 31	Sticks							Ride Cymbal 1
A1 32	Square Click							
A1 33	Metronome Click							
B1 34	Metronome Bell							
C2 36	Standard Kick 1	Room Kick 2	Power Kick 1	Elec. Kick 1	Synth Kick 1	Jazz Kick 1	Jazz Kick 2	Jazz Kick 1
C#2 37	Side Stick	Room Kick 1	Power Kick 2	Elec. Kick 2	Synth Kick 2	Jazz Kick 1	Jazz Kick 1	Concert BD 1
D2 38	Standard Snare 1	Room Snare 1	Power Snare 1	Elec. Snare 1	Synth Rim Shot	Jazz Snare 1	Brush Snare 1	Concert SD
E2 40	Standard Snare 2	Room Snare 2	Power Snare 2	Elec. Snare 2	Hand Clap 2	Jazz Snare 2	Brush Snare 2	Gastanets
F2 41	Low Tom 2	Room Low Tom 2	Power Low Tom 2	Elec. Low Tom 2	Synth Low Tom 2	Jazz Snare 2	Brush Snare 2	Concert SD
F#2 42	Closed Hi-Hat				Synth ClosedHH 1			Tripani F
G2 43	Pedal Hi-Hat	Room Low Tom 1	Power Low Tom 1	Elec. Low Tom 1	Synth Low Tom 1			Tripani G
A2 44	Mid Tom 2	Room Mid Tom 2	Power Mid Tom 2	Elec. Mid Tom 2	Synth ClosedHH 2			Tripani G#
B2 45	Open Hi-Hat	Room Mid Tom 1	Power Mid Tom 1	Elec. Mid Tom 1	Synth Open HH			Tripani A#
C2 47	High Tom 1	Room High Tom 1	Power High Tom 1	Elec. High Tom 1	Synth High Tom 1			Tripani B
C#2 48	Crash Cymbal 1				Synth Crash Cymbal			Tripani c
D3 50	Ride Cymbal 1	Room High Tom 1	Power High Tom 1	Elec. High Tom 1	Synth High Tom 1			Tripani d
E3 52	Chinese Cymbal			Reverse Cymbal	Synth Ride Cymbal			Tripani e
F3 53	Ride Bell							Tripani f
F#3 54	Tambourine 1				Synth Tambourine			
G3 55	Splash Cymbal				Synth Cowbell			Concert Cymbal 2
A3 57	Cowbell							Concert Cymbal 1
B3 59	Crash Cymbal 2							
B3 59	Reverse Cymbal							
C4 60	Ride Cymbal 2							
C#4 61	High Bongo				Synth High Bongo			
D4 62	Low Bongo				Synth Low Bongo			
E4 64	Open High Conga				Synth Open H Conga			
F4 65	Open Low Conga				Synth Open L Conga			
G4 67	High Tom 1				Synth Open Low Conga			
A4 69	High Tom 2							
B4 70	High Tom 2							
C5 72	Long Low Whistle				Synth Maracas			
D5 74	Short Guiro							
E5 76	Long Guiro							
F5 77	High Wood Block				Synth Claves			
G5 79	Mute Cuica							
A5 81	Mute Triangle							
B5 83	Shaker							
C6 84	Jingle Bell							
D6 86	Castanets							
E6 88	Mute Surdo							
F6 89	Applause 1							
G6 91	Applause 2							
A6 93	One							
B6 95	Two							
C7 96	Three							
	Four							
	Five							

FINGERED Chord Chart

Cuadro de acordes digitados

This table shows the left-hand fingerings (including inverted forms) for a number of often-used chords. These fingering indications also appear on the keyboard's display. Chords marked with asterisk (*) cannot be played in the Fingered Mode on this keyboard.

Esta tabla muestra las digitaciones (incluyendo las formas invertidas) para varios de los acordes más a menudo usados. Estas indicaciones de digitación también aparecen sobre la presentación del teclado. En este teclado, los acordes marcados con asterisco (*) no pueden ejecutarse en el modo de digitación.

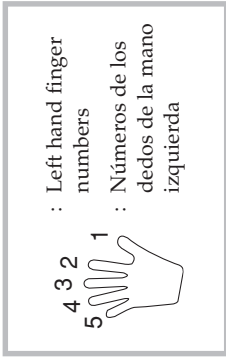

Chord Type Root	M	m	7	m7	dim7	M7	m7-5	dim	aug	sus4	7 sus4	m add9	m M7	7-5	add9
C	[5.3.1]	[5.3.1]	[5.3.2.1]	[5.3.2.1]	[5.3.2.1]	[5.3.2.1]	[5.3.2.1]	[5.3.2]	[5.3.1]	[5.2.1]	[5.3.2.1]	[4.3.2.1]	[5.3.2.1]	[5.3.2.1]	[4.3.2.1]
C# (D♭)	[5.3.1]	[5.3.1]	[5.3.2.1]	[5.3.2.1]	[5.3.2.1]	[5.3.2.1]	[5.3.2.1]	[5.3.2]	[5.3.1]	[5.2.1]	[5.3.2.1]	[4.3.2.1]	[5.3.2.1]	[5.3.2.1]	[4.3.2.1]
D	[5.3.1]	[5.3.1]	[5.3.2.1]	[5.3.2.1]	[5.3.2.1]	[5.3.2.1]	[5.3.2.1]	[5.3.2]	[5.3.1]	[5.2.1]	[5.3.2.1]	[4.3.2.1]	[5.3.2.1]	[5.3.2.1]	[4.3.2.1]
E♭ (D♯)	[5.3.1]	[5.3.1]	[5.3.2.1]	[5.3.2.1]	[5.3.2.1]	[5.3.2.1]	[5.3.2.1]	[5.3.2]	[5.3.1]	[5.2.1]	[5.3.2.1]	[4.3.2.1]	[5.3.2.1]	[5.3.2.1]	[4.3.2.1]
E	[5.3.1]	[5.3.1]	[5.3.2.1]	[5.3.2.1]	[5.3.2.1]	[5.3.2.1]	[5.3.2.1]	[5.3.2]	[5.3.1]	[5.2.1]	[5.3.2.1]	[4.3.2.1]	[5.3.2.1]	[5.3.2.1]	[4.3.2.1]
F	[5.3.1]	[5.3.1]	[5.3.2.1]	[5.3.2.1]	[5.3.2.1]	[5.3.2.1]	[5.3.2.1]	[5.3.2]	[5.3.1]	[5.2.1]	[5.3.2.1]	[4.3.2.1]	[5.3.2.1]	[5.3.2.1]	[4.3.2.1]
F# (G♭)	[5.3.1]	[5.3.1]	[5.3.2.1]	[5.3.2.1]	[5.3.2.1]	[5.3.2.1]	[5.3.2.1]	[5.3.2]	[5.3.1]	[5.2.1]	[5.3.2.1]	[4.3.2.1]	[5.3.2.1]	[5.3.2.1]	[4.3.2.1]
G	[5.3.1]	[5.3.1]	[5.3.2.1]	[5.3.2.1]	[5.3.2.1]	[5.3.2.1]	[5.3.2.1]	[5.3.2]	[5.3.1]	[5.2.1]	[5.3.2.1]	[4.3.2.1]	[5.3.2.1]	[5.3.2.1]	[4.3.2.1]
A♭ (G♯)	[5.3.1]	[5.3.1]	[5.3.2.1]	[5.3.2.1]	[5.3.2.1]	[5.3.2.1]	[5.3.2.1]	[5.3.2]	[5.3.1]	[5.2.1]	[5.3.2.1]	[4.3.2.1]	[5.3.2.1]	[5.3.2.1]	[4.3.2.1]
A	[5.3.1]	[5.3.1]	[5.3.2.1]	[5.3.2.1]	[5.3.2.1]	[5.3.2.1]	[5.3.2.1]	[5.3.2]	[5.3.1]	[5.2.1]	[5.3.2.1]	[4.3.2.1]	[5.3.2.1]	[5.3.2.1]	[4.3.2.1]
B♭ (A♯)	[5.3.1]	[5.3.1]	[5.3.2.1]	[5.3.2.1]	[5.3.2.1]	[5.3.2.1]	[5.3.2.1]	[5.3.2]	*	[5.2.1]	[5.3.2.1]	[4.3.2.1]	[5.3.2.1]	[5.3.2.1]	[4.3.2.1]
B	[5.2.1]	[5.2.1]	[5.3.2.1]	[5.3.2.1]	[5.3.2.1]	[5.3.2.1]	[5.3.2.1]	[5.3.2]	*	[5.2.1]	[5.3.2.1]	[4.3.2.1]	[5.3.2.1]	[5.3.2.1]	[4.3.2.1]

Rhythm List/Lista de ritmos

POPS I	ROCK I	EUROPEAN	VARIOUS II
000 POP 1	030 POP ROCK 1	060 POLKA	090 FOLKLORE
001 WORLD POP	031 POP ROCK 2	061 POP POLKA	091 JIVE
002 8 BEAT POP	032 POP ROCK 3	062 MARCH 1	092 FAST GOSPEL
003 SOUL BALLAD 1	033 FOLKIE POP	063 MARCH 2	093 SLOW GOSPEL
004 POP SHUFFLE 1	034 POP SHUFFLE 2	064 WALTZ 1	094 SIRTAKI
005 8 BEAT DANCE	035 ROCK BALLAD	065 SLOW WALTZ	095 HAWAIIAN
006 POP BALLAD 1	036 SOFT ROCK	066 VIENNESE WALTZ	096 ADANI
007 POP BALLAD 2	037 ROCK 1	067 FRENCH WALTZ	097 BALADI
008 BALLAD	038 ROCK 2	068 SERENADE	098 ENKA
009 FUSION SHUFFLE	039 HEAVY METAL	069 TANGO	099 STR QUARTET
POPS II	ROCK II	LATIN I	FOR PIANO I
010 SOUL BALLAD 2	040 60'S SOUL	070 BOSSA NOVA 1	100 PIANO BALLAD 1
011 16 BEAT 1	041 60'S ROCK	071 BOSSA NOVA 2	101 PIANO BALLAD 2
012 16 BEAT 2	042 SLOW ROCK	072 SAMBA 1	102 PIANO BALLAD 3
013 8 BEAT 1	043 SHUFFLE ROCK	073 SAMBA 2	103 EP BALLAD 1
014 8 BEAT 2	044 50'S ROCK	074 MAMBO	104 EP BALLAD 2
015 8 BEAT 3	045 BLUES	075 RHUMBA	105 BLUES BALLAD
016 DANCE POP 1	046 NEW ORLNS R&R	076 CHA-CHA-CHA	106 MELLOW JAZZ
017 POP FUSION	047 TWIST	077 MERENGUE	107 JAZZ COMBO 2
018 POP 2	048 R&B	078 BOLERO	108 RAGTIME
019 POP WALTZ	049 ROCK WALTZ	079 SALSA	109 BOOGIE-WOOGIE
DANCE/FUNK	JAZZ	LATIN II/VARIOUS I	FOR PIANO II
020 DANCE	050 BIG BAND 1	080 REGGAE	110 ARPEGGIO 1
021 DISCO 1	051 BIG BAND 2	081 PUNTA	111 ARPEGGIO 2
022 DISCO 2	052 BIG BAND 3	082 CUMBIA	112 ARPEGGIO 3
023 EURO BEAT	053 SWING	083 PASODOBLE	113 PIANO BALLAD 4
024 DANCE POP 2	054 SLOW SWING	084 SKA	114 6/8 MARCH
025 GROOVE SOUL	055 FOX TROT	085 BLUEGRASS	115 MARCH 3
026 TECHNO	056 JAZZ COMBO 1	086 DIXIE	116 2 BEAT
027 TRANCE	057 JAZZ VOICE	087 TEX-MEX	117 WALTZ 2
028 HIP-HOP	058 ACID JAZZ	088 COUNTRY 1	118 WALTZ 3
029 FUNK	059 JAZZ WALTZ	089 COUNTRY 2	119 WALTZ 4

NOTE

- Rhythms 110 through 119 consist of chord accompaniments only, without any drums or other percussion instruments. These rhythms do not sound unless CASIO CHORD or FINGERED is selected as the accompaniment mode. With such rhythms, make sure that CASIO CHORD or FINGERED is selected before you try playing chords.

NOTA

- Los ritmos 110 al 119 consisten solamente de acompañamientos de acordes, sin ninguna batería ni otros instrumentos de percusión. Estos ritmos no suenan a menos que CASIO CHORD o FINGERED sean seleccionados como el modo de acompañamiento. Con tales ritmos, asegúrese de que se selecciona CASIO CHORD o FINGERED, antes de tratar de ejecutar los acordes.

Song List/Listas de canciones

SONG BANK

Lista SONG BANK

00	CAN YOU FEEL THE LOVE TONIGHT (“LION KING” THEME)
01	HARD TO SAY I’M SORRY
02	SEPTEMBER
03	WE WISH YOU A MERRY CHRISTMAS
04	JINGLE BELLS
05	SILENT NIGHT
06	JOY TO THE WORLD
07	O CHRISTMAS TREE
08	WHEN THE SAINTS GO MARCHING IN
09	BEAUTIFUL DREAMER
10	GREENSLEEVES
11	SWING LOW, SWEET CHARIOT
12	JOSHUA FOUGHT THE BATTLE OF JERICHO
13	AMAZING GRACE
14	AULD LANG SYNE
15	TWINKLE TWINKLE LITTLE STAR
16	LIGHTLY ROW
17	UNDER THE SPREADING CHESTNUT TREE
18	COME BIRDS
19	THE MUFFIN MAN
20	LONG LONG AGO
21	DID YOU EVER SEE A LASSIE?
22	LONDON BRIDGE
23	THE FARMER IN THE DELL
24	ON THE BRIDGE OF AVIGNON
25	SIPPIN’ CIDER THROUGH A STRAW
26	GRANDFATHER’S CLOCK
27	MICHAEL ROW THE BOAT ASHORE
28	DANNY BOY
29	ANNIE LAURIE
30	MY BONNIE
31	IF YOU’RE HAPPY AND YOU KNOW IT, CLAP YOUR HANDS
32	MY DARLING CLEMENTINE

33	HOME SWEET HOME
34	MY WILD IRISH ROSE
35	ON TOP OF OLD SMOKEY
36	AMERICA THE BEAUTIFUL
37	DOWN IN THE VALLEY
38	I’VE BEEN WORKING ON THE RAILROAD
39	LITTLE BROWN JUG
40	AURA LEE
41	OHI SUSANNA
42	HOUSE OF THE RISING SUN
43	SHE WORE A YELLOW RIBBON
44	WHEN JOHNNY COMES MARCHING HOME
45	CAMPTOWN RACES
46	SWANEE RIVER (OLD FOLKS AT HOME)
47	JEANNIE WITH THE LIGHT BROWN HAIR
48	YANKEE DOODLE
49	RED RIVER VALLEY
50	TURKEY IN THE STRAW
51	MY OLD KENTUCKY HOME
52	HOME ON THE RANGE
53	JAMAICA FAREWELL
54	ALOHA OE
55	SAKURA SAKURA
56	SANTA LUCIA
57	WALTZING MATILDA
58	AIR FROM “SUITE no.3”
59	SPRING FROM “THE FOUR SEASONS”
60	BRIDAL MARCH FROM “LOHENGGRIN”
61	TRUMPET MARCH FROM “AIDA”
62	HABANERA FROM “CARMEN”
63	BRINDISI FROM “LA TRAVIATA”
64	MARCH FROM “THE NUTCRACKER”
65-74	Loaded songs (user songs) / Canciones cargadas (canciones del usuario)

PIANO BANK List

Lista PIANO BANK

ETUDES	
00	MINUET IN G MAJOR
01	GAVOTTE (GOSSEC)
02	CHOPSTICKS
03	AVE MARIA (GOUNOD)
04	JESUS BLEIBET MEINE FREUDE
05	CANON (PACHELBEL)
06	PIANO SONATA op.13 “PATHÉTIQUE” 2nd Mov.
07	ODE TO JOY
08	SERENADE FROM “EINE KLEINE NACHTMUSIK”
09	GOING HOME FROM “FROM THE NEW WORLD”
CONCERT PIECES	
10	FÜR ELISE
11	TURKISH MARCH (MOZART)
12	THE ENTERTAINER
13	MAPLE LEAF RAG
14	GYMNOPÉDIES no.1
15	ETUDE op.10 no.3 “CHANSON DE L’ADIEU”
16	PIANO SONATA op.27 no.2 “MOONLIGHT” 1st Mov.
17	HUNGARIAN DANCES no.5
18	TRÄUMEREI
19	HUMORESKE (DVOŘÁK)
20	PROMENADE FROM “TABLEAUX D’UNE EXPOSITION”
21	LE CYGNE FROM “LE CARNAVAL DES ANIMAUX”
22	CHANSON DU TOREADOR FROM “CARMEN”
23	LARGO (HÄNDEL)
24	WEDDING MARCH FROM “MIDSUMMER NIGHT’S DREAM”
25	AMERICAN PATROL
26	CSIKOS POST
27	DOLLY’S DREAMING AND AWAKENING
28	LA CHEVALERESQUE
29	PIANO SONATA K.545 1st Mov.
30	LA PRIÈRE D’UNE VIERGE
31	NOCTURNE op.9 no.2 (CHOPIN)
32	MARCHE MILITAIRE no.1
33	BLUMENLIED
34	GRANDE VALSE BRILLANTE op.18 no.1

Models LK-210/LK-215

Version: 1.0

MIDI messages that can be sent and received using the USB port Los mensajes MIDI pueden enviarse y recibirse usando el puerto USB

Function ...	Transmitted	Recognized	Remarks
Basic Channel Default Changed	1 1-16	1-16 1-16	
Mode Default Messages Altered	Mode 3 X *****	Mode 3 X *****	
Note Number True voice	36-96 *****	0-127 12-108*1	*1: See Tone List on page A-1. *1: Vea la lista de sonidos en la página A-1.
Velocity Note ON Note OFF	*2 X 8nH V = 64	O 9nH V = 1-127 X 9nH V = 0,8nH V = XX	XX: no relation XX: sin relación
After Touch Key's Ch's	X X	X O*3	
Pitch Bender	X	O	
Control Change 0, 32 1 6, 38 7 10 11 64 66	O X X X X X O*5 O*5	O O*3 O*4 O O O O O O	Bank select Modulation Data entry Volume Pan Expression Hold1 Sostenuto

67 91 93 100, 101 120 121	O*5 X O X O O	O*5 X O X O O	Soft pedal Reverb send Chorus send RPN LSB, MSB All sound off Reset all controller
Program Change : True #	O 0-127 *****	O 0-127 *****	O 0-127 *****
System Exclusive	O*6	O*6	O*6 *7
System Common : Song Pos : Song Sel : Tune	X X X	X X X	X X X
System Real Time : Clock : Commands	O O	O O	X X
Aux : Local ON/OFF : All notes OFF : Active Sense : Reset	X O X X	X O X X	X O O X
Remarks	<small> ⁸² LK-210: X 9H V = 98, LK-215: O 9H V = 1-127 ⁸³ LK-210: X 9H V = 98, LK-215: O 9H V = 1-127 ⁸⁴ Modulation and after touch for each channel are the same effect. ⁸⁵ La modulación y después del toque para cada canal tienen el mismo efecto. ⁸⁶ FINE TUNE COARSE TUNE receive, and PITCH BEND SENSE, RPN Null receive ⁸⁷ FINE TUNE COARSE TUNE, y PITCH BEND SENSE, recepción RPN. ⁸⁸ In accordance with sustain/assignable jack setting ⁸⁹ De acuerdo con el ajuste de la toma asignable. ⁹⁰ * Reverb_Type [F0] [7F] [7F] [04] [05] [01] [01] [01] [01] [01] [00] ⁹¹ [v] [F7] v=0: Room1, 01: Room2, 04: Hall1, 03: Hall2 ⁹² Chorus_Type [F0] [7F] [7F] [04] [05] [01] [01] [01] [01] [02] [00] ⁹³ [v] [F7] v=0: Chorus1, 01: Chorus2, 03: Chorus4 ⁹⁴ Type de reverbe: 01: Room1, 01: Room2, 04: Hall1, 03: Hall2 ⁹⁵ Tipo de Chorus: 01: Chorus1, 01: Chorus2, 03: Chorus4 ⁹⁶ [W] [F7] v=0: Chorus1, 01: Chorus2, 02: Chorus3, 03: Chorus4 ⁹⁷ GM on/off GM ON: [F0] [7E] [7F] [09] [01] [F7] GM OFF: [F0] [7E] [7F] [09] [02] [F7] ⁹⁸ Activación/desactivación GM GM ON: [F0] [7E] [7F] [09] [01] [F7] GM OFF: [F0] [7E] [7F] [09] [02] [F7] </small>		

Mode 1 : OMNI ON, POLY
Mode 3 : OMNI OFF, POLY

Mode 2 : OMNI ON, MONO
Mode 4 : OMNI OFF, MONO

O : Yes
X : No



This recycle mark indicates that the packaging conforms to the environmental protection legislation in Germany.

Esta marca de reciclaje indica que el empaquetado se ajusta a la legislación de protección ambiental en Alemania.

CASIO®

CASIO COMPUTER CO.,LTD.
6-2, Hon-machi 1-chome
Shibuya-ku, Tokyo 151-8543, Japan

 MA0903-C Printed in China
LK210/215ES1C

Free Manuals Download Website

<http://myh66.com>

<http://usermanuals.us>

<http://www.somanuals.com>

<http://www.4manuals.cc>

<http://www.manual-lib.com>

<http://www.404manual.com>

<http://www.luxmanual.com>

<http://aubethermostatmanual.com>

Golf course search by state

<http://golfingnear.com>

Email search by domain

<http://emailbydomain.com>

Auto manuals search

<http://auto.somanuals.com>

TV manuals search

<http://tv.somanuals.com>