

CASIO®

Handheld Terminal DT-X8 Series

User's Guide

Be sure to read "Safety Precautions" inside this guide before trying to use your Handheld Terminal.

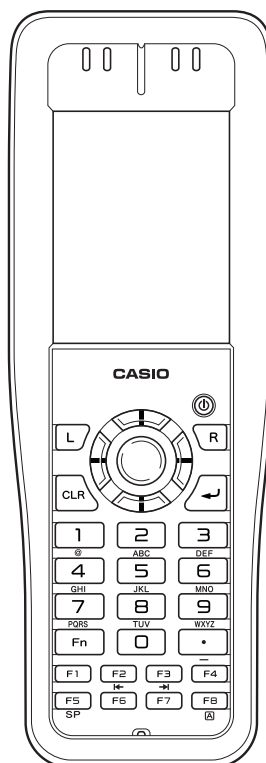

 **Bluetooth®**

- BLUETOOTH is a registered trademark owned by Bluetooth SIG, Inc. and licensed to CASIO COMPUTER CO., LTD.
- Microsoft and Windows are either registered trademarks or trademarks of Microsoft Corporation in the United States and/or other countries.
- “FeliCa” is a contactless IC card technology developed by SONY Corporation and a registered trademark of SONY Corporation.

Information in this document is subject to change without advance notice. CASIO Computer Co., Ltd. makes no representations or warranties with respect to the contents or use of this manual and specifically disclaims any express or implied warranties of merchantability or fitness for any particular purpose.

Contents

Contents	E-1
Safety Precautions	E-3
Operating Precautions	E-8
About the Waterproofing/Dustproofing	E-10
Warning Label	E-11
Important	E-12
Regulatory Information	E-12
Checking in the Box	E-13
Handheld Terminal System Configuration	E-14
General Guide	E-16
Loading and Removing the Battery Pack	E-19
Loading	E-20
Removing.....	E-21
Attaching the Pen Cord	E-22
Attaching the Hand Strap	E-23
To attach the hand strap	E-23
Calibrating Touch Panel Alignment	E-24
Setting the Display Brightness	E-25
Adjusting Display Brightness	E-25
Display Auto Dimmer	E-25
Using the Laser Scanner (Laser Models)	E-26
Bar Code Scanning Position	E-27
Adjusting the Laser Light Emission Width	E-28
Using the CMOS Imager (Imager Models)	E-30
Using the Full Range Imager (Full Range Imager Models)	E-31
Handling the NFC Reader/Writer (DT-X8-11E/11C/21E/21C)	E-32
RFID Tags	E-32
Contactless IC Cards.....	E-32
Handling microSD Cards	E-34
Installing.....	E-34
Removing.....	E-35

Performing Bluetooth® Communication.....	E-36
Resetting the Handheld Terminal.....	E-37
Performing a Full Reset (Initialization)	E-37
DT-X8 Specifications	E-39
Dimensional Drawings.....	E-42
Handling the Hand Belt (HA-K95HB).....	E-43
Attaching the hand belt	E-43
Removing the hand belt	E-43
Using the USB Cradle (HA-K60IO)	E-44
General Guide	E-44
Connecting the USB Cradle Power Supply	E-46
Specifications	E-49
Using the Ethernet Cradle (HA-K62IO)	E-50
General Guide	E-50
Connecting the Ethernet Cradle Power Supply.....	E-52
Specifications	E-55
Using the Cradle-type Dual Battery Charger (HA-K36DCHG).....	E-56
General Guide	E-56
Charging Battery Pack	E-58
Connecting Multiple Cradle-type Dual Battery Charger	E-61
Specifications	E-62
Using the USB and Charging Unit (HA-K65US)	E-63
General Guide	E-63
Mounting the USB and Charging Unit	E-64
Removing the USB and Charging Unit.....	E-65
Connecting to a Computer	E-65
Charging the Battery Pack	E-66
Specifications	E-67
Using the Dual Battery Charger (HA-F32DCHG).....	E-68
General Guide	E-68
Charging Battery Pack	E-69
Connecting Multiple Dual Battery Chargers.....	E-70
Specifications	E-71
Using Rechargeable Battery Pack.....	E-72
Battery Pack Specifications.....	E72

Safety Precautions

Congratulations upon your selection of this CASIO product. Be sure to read the following Safety Precautions before trying to use it for the first time.

Your neglect or avoidance of the warning and caution statements in the subsequent pages causes the danger of fire, electric shock, malfunction and damage on the goods as well as personal injury.

Markings and Symbols

The following are the meanings of the markings and symbols used in these Safety Precautions.



Danger

This symbol indicates information that, if ignored or applied incorrectly, creates the danger of death or serious personal injury.



Warning

This symbol indicates information that, if ignored or applied incorrectly, creates the possibility of death or serious personal injury.



Caution

This symbol indicates information that, if ignored or applied incorrectly, creates the possibility of personal injury or property damage.



• A diagonal line indicates something you should not do. The symbol shown here indicates you should not try to take the unit apart.



• A black circle indicates something you should do. The symbol shown here indicates you should unplug the unit from the wall outlet.



Warning

Disassembly and Modification



• Never try to disassemble or modify the Handheld Terminal and its options including battery pack and battery in any way.

Abnormal Conditions



• Should the Handheld Terminal and/or its options including battery pack and battery become hot or start to emit smoke or a strange odor, immediately turn off the power and contact your dealer or distributor whom you purchased the product from, or an authorized CASIO service provider.

Warning

Dust and Moisture

-  • Though the Handheld Terminal is dust and water splash resistant, its options including the battery pack are not. Keep loose metal objects and containers filled with liquid away from your Handheld Terminal and the options. Also, never handle the Handheld Terminal and the options while your hands are wet.

Laser Light

-  • The laser scanner models (model dependant) with the integrated laser scanning module scan bar codes using laser light. Never look directly into the laser light or shine the laser light into the eyes.

Warning

Interference with the Operation of Other Equipment (Using Wireless Data Communication)

-  • Keep your Handheld Terminal at least 22 centimeters (8¹¹/₁₆") away from anyone wearing a pacemaker. Radio waves emitted by the Handheld Terminal can affect the operation of a pacemaker.
- Before the use in aircraft, be sure to consult with cabin crew for interference the Handheld Terminal emits.
- Before the use in medical facility, be sure to consult with the facility management or the manufacture of a specific medical equipment that the Handheld Terminal may interfere with.
- Do not use the Handheld Terminal nearby gas pump or chemical tank or any other places flammable or explosive.



Caution

Foreign Objects



- Take care to ensure that metals or combustible objects are not inserted into the openings of the Handheld Terminal or its options, and not to allow moisture to get inside of them.

Location



- Install the cradle properly on a flat and stable surface so that it cannot fall down onto floor.



LCD Screen





- Never apply strong pressure to the screen or subject it to strong impact. Doing so can crack the LCD Screen.

Optional Lithium-ion Battery Pack

Danger

-  • Never use the Handheld Terminal and its option including the battery pack and battery next to open flame, near a stove, or any other area exposed to high heat, or leave them for a long period of time in a vehicle parked in direct sunlight.
- Never use the battery pack with any device other than the Handheld Terminal.
- Never dispose of the battery pack by incinerating it or otherwise expose it to heat.
- Never transport or store the battery pack together with metal objects that may result in shorting positive (+) and negative (-) terminals of the battery pack. Be sure to place the battery pack in its case whenever transporting or storing it.
- Never throw the battery pack or otherwise subject it to strong impact.
- Never pierce the battery pack with nails, hit it with a hammer, or step on it.
-  • Use only the specified battery charger to charge the battery pack.

Warning



-  • Never place the battery pack in a microwave oven or any other high-voltage device.
-  • If the amount of time period the battery pack can serve becomes considerably short even after it has been fully charged for the specified time period, stop using it.
- Should the battery pack start to leak or emit a strange odor, immediately move it away from any flame nearby. Leaking battery fluid is combustible.
- Should fluid from the battery pack accidentally get into your eyes or on the skin, do not rub it. Immediately rinse it off with clean tap water and then consult a physician.

Caution





-  • Replace only with the same type of battery pack recommended by CASIO. Dispose of used battery packs according to the local regulation.
- Keep the battery pack out of the reach of small children.

Power Supply / AC Adaptor

Warning

-  Do not use the Handheld Terminal at a voltage other than the specified voltage. Also, do not connect the Handheld Terminal to a multi-plug power strip.
- Never modify, sharply bend, twist, or pull on the power cord.
- Never use a detergent to clean AC adaptor and its power cable, especially on the plug and the jack.
-  When using the battery chargers and the cradles, be sure to use the respective AC adaptors.

Caution

-  Never pull on the power cord when unplugging it. Always hold the plug when unplugging it from the wall outlet.
- Never touch the plug while your hands are wet.
-  Be sure to unplug the power cord from the wall outlet before cleaning the battery chargers and the cradles.
- Unplug the power cord from the wall outlet whenever leaving the battery chargers and the cradles unattended for a long period.
-  The housing of the AC adaptor can become warm during normal use.
-  At least once a year, unplug the AC adaptor from the wall outlet and clean any dust that builds up between the prongs of the plug. Dust built up between the prongs can lead to the danger of fire.

Backup of All Important Data

Caution

-  Note that CASIO Computer Co., Ltd. shall not be held liable to you or any third party for any damages or loss caused by deletion or corruption of data due to use of the Handheld Terminal, malfunction or repair of the Handheld Terminal or its peripherals, or due to the batteries going dead.
- The Handheld Terminal employs electronic memory to store data, which means that memory contents can be corrupted or deleted if power is interrupted due to the batteries going dead or incorrect battery replacement procedures. Data cannot be recovered once it is lost or corrupted. Be sure to make backup of all important data. One way to do this is to use the separately sold cradles to transfer data to a computer.

Operating Precautions

Your Handheld Terminal and its options are precision. Improper operation or rough handling can cause problems with data storage and other problems. Note and observe the following precautions to ensure proper operation.

- **Do not leave dead battery pack in the Handheld Terminal for a long period.**

Dead battery pack can leak, leading to malfunction and damage to the Handheld Terminal.

- **Stop or avoid using the Handheld Terminal and its options in areas and conditions subject to the following.**

- Large amounts of static electricity
- Extreme heat or cold or humidity
- Sudden temperature change
- Large amount of dust
- After large amount of rain or water falls on the Handheld Terminal
- Pressing the screen or keys with excessive force when using in the rain

- **Always use the special pen (stylus) provided when using the touch panel or reset button.**

The use of implements other than the stylus could damage the touch panel and cause malfunctions.

- **Dead Pixels**

The LCD panel employed in this product uses high precision and substantial number of components which commonly cause a small number of the pixels not to light or to remain lit all the time. This is due to the characteristics of LCD panel yield in accuracy over 99.99% and permissible.

- **Lithium-ion Battery Pack**

Each lithium-ion battery pack has its life. The life span heavily depends on how the battery pack is charged or stored which may cause deterioration of the battery pack to shorten the life span if it is handled improperly. Note the tips below to make the battery pack last long.

- Be sure to charge the battery pack before using it if the battery pack is used for the first time or if it has not been used for a long period of time.
- If the battery pack is repeatedly charged, the life span becomes short. To avoid the repetition of charging the battery pack, be sure that the remaining capacity is low before you start charging.
- Be sure to charge the battery pack in recommended temperature range. The temperature range is dependant on device you use to charge including battery chargers and Handheld Terminals. Refer to the respective user guides. Charging the battery pack in a temperature outside of the recommended range causes deterioration.
- When used at low temperatures, the battery pack has a reduced capacity and will supply power for shorter time.
The life span of the battery pack is also shortened.
- Charging the battery pack while the battery pack itself is freeze including inside causes deterioration. Be sure to resume an ordinary room temperature on the battery pack and then leave it unattended for approximately one hour before charging.
- After charging the battery pack, if the performance of the battery pack does not show any recovery, it is a sign of ending the life. Replace it with a new battery pack.
- Avoid the battery pack with a full of the capacity to store for a long period of time. If you need to store it for a long period, be sure that the remaining capacity is 30 to 50 percent and to store in a moderate low temperature. This can reduce deterioration.
- The battery pack gradually deteriorates over time. In particular, storing (or using) the fully charged battery pack at high temperatures tends to accelerate battery pack deterioration.

About the Waterproofing/Dustproofing

The DT-X8 Series models are waterproof and dustproof.

- **Waterproofing:** Performance complies with the IPX7 level set out in the IEC standards (waterproof for 30 minutes at a depth of 1 meter in still tap water at normal temperature).
- **Dustproofing:** Performance complies with the IP6X level set out in the IEC standards.

IP (Ingress Protection) is the standard for splash- and dust-proofing for electrical products set out in the International Electrotechnical Commission (IEC) standard 60529. The IEC is a global organization for standardization that includes all the IEC National Committees.

Important!

The water- and dust-proofing performance of this product is based on CASIO testing procedures. Note also that this performance applies to the product at the time of shipment (delivery to the customer) and is not guaranteed inclusive of the environment in which the product is used. The warranty does not apply to any situation where the product is immersed during use, and as with any other electrical product, great care should be taken when using this product in the rain or similar situation.

• Precautions When Using this Product

- Check that there is no dust, sand or other foreign matter on the battery pack cover, microSD card slot cover or on the respective contact surfaces. If any soiling is found, wipe it off with a clean, soft, dry cloth. Even very small amounts of soiling trapped on the contact surfaces (a single hair or grain of sand, etc.) can cause water to leak into the device.
- Check that the waterproof seals on the battery pack cover and microSD card slot cover are free from cracks and other damage.
- Close the battery pack cover lock switch firmly until you hear it click into place.
- Avoid opening and closing the battery pack cover or microSD card slot cover in locations near water or exposed to sea breezes, and do not open or close them with wet hands.
- Do not drop this product or leave it in locations exposed to temperatures outside the specified range. Doing so could impair its water- or dust-proofing.

• Other Precautions

- The accessories for this product (battery pack, etc.) and optional products are not water- or dust-proof.
- Subjecting this product to a severe impact could render it no longer water- or dust-proof.
- If any water leaks into the product as a result of carelessness or inattention during product handling, CASIO cannot be held liable for compensation for any damage to internal components (battery, recording media, etc.) or for the costs of recorded content or the recording thereof.
- CASIO COMPUTER CO., LTD. accepts no other liability whatsoever for any accident that occurs due to water leakage.

Warning Label

Warning!

■ Never look directly into the laser light.

-  • These products scan using laser light. Never look directly into the laser light or shine the laser light into the eyes.

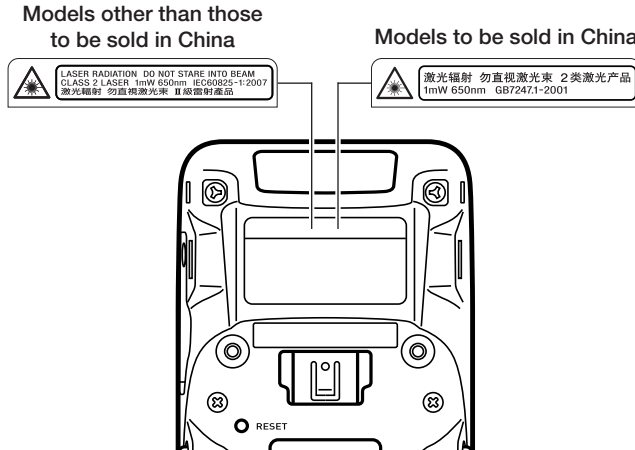

- This label is a warning and caution label for Class 2 laser products that comply with IEC60825-1:2007.
- Although Class 2 laser light is only emitted momentarily, never look directly into the beam light.
- The laser light emitted by this laser scanner has a maximum output of less than 1 mW and a wavelength of 650 nm.
- Use of controls or adjustments or performance of procedures other than those specified herein may result in hazardous radiation exposure.

Important

- This guide does not include any information about programming and download procedures. See the applicable separate documentation for information about the procedures.

After Service

- Should this product ever malfunction, contact your original retailer providing information about the product name, the date you purchased it, and details about the problem.



This mark applies to EU countries and Turkey only.

Regulatory Information

Europe

Products are for distribution within
all member states of the EU.

CE 0984

France limited to 2446.5-2483.5 MHz Indoor use.

Belgium limited to 2400-2483.5 MHz Indoor, 2460-2483.5 MHz Outdoor use.

Optional models HA-K60IO, HA-K62IO, HA-K65US, HA-F32DCHG, HA-K36DCHG and HA-K23XLBAT are in conformity with the Council Directive 2004/108/EC.

To comply with the relevant European RF exposure compliance requirements, a separation distance of at least 2.6 cm in wireless operation must be maintained between the terminal and all persons around. This terminal must not be co-located or operating in conjunction with other transmitter.



Manufacturer:
CASIO COMPUTER CO., LTD.
6-2, Hon-machi 1-chome, Shibuya-ku, Tokyo 151-8543, Japan
Representative within the European Union:
CASIO EUROPE GmbH
Casio-Platz 1, 22848 Norderstedt, Germany

Checking in the Box

Please check the contents of the box before using the Handheld Terminal for the first time.

Open the box and make sure that all the items shown here are included.

Handheld Terminal

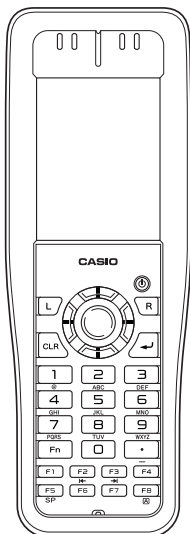

Hand Strap

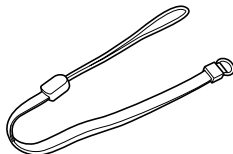

Pen (stylus)

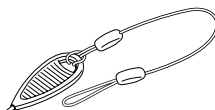

Shown with pen cord attached.

**USB Cable
DT-380USB-A**

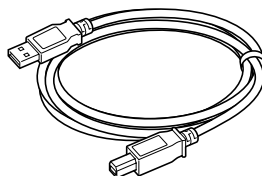

**Battery Pack
HA-K23XLBAT**

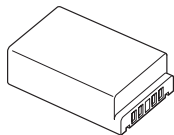

**USB and Charging Unit
HA-K65US**

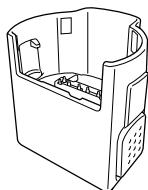

**AC Adaptor
AD-S15050B**



**Power Cord for Europe
AC-CORD-EU**

**AC Adaptor
AD-S15050B-CN
(China only)**

User's Guide (this manual)

Handheld Terminal System Configuration

DT-X8 Series

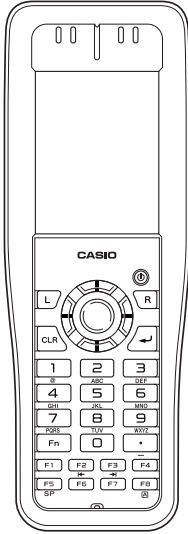

Options

USB Cradle
HA-K60IO

Ethernet Cradle
HA-K62IO

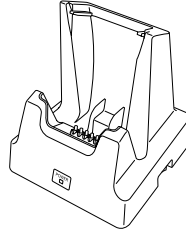

The illustration shows the
USB Cradle (HA-K60IO).

Dual Battery Charger
HA-F32DCHG

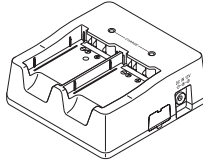

USB and Charging Unit
HA-K65US

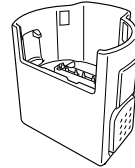

**Cradle-type Dual
Battery Charger**
HA-K36DCHG

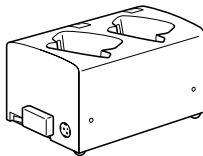

**AC Adaptor for Cradle-type
Dual Battery Charger**
AD-S90190C

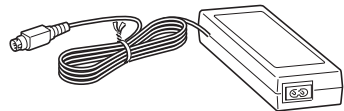

For the latest options list, refer to the ON-LINE manual available at
http://world.casio.com/system/pa/UsersGuide/sup85_e.html

Options

**AC Adaptor for Ethernet Cradle/
Dual Battery Charger**
AD-S42120B/AD-S42120C

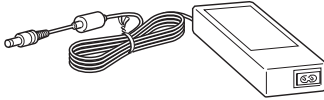

**AC Adaptor for USB Cradle/
USB and Charging Unit**
AD-S15050B

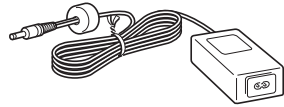

Power Cord for Europe AC-CORD-EU
Power Cord for North America AC-CORD-US
Power Cord for Taiwan AC-CORD-TW
Power Cord for Korea AC-CORD-KR
Power Cord for Australia AC-CORD-AU

Battery Pack
HA-K23XLBAT

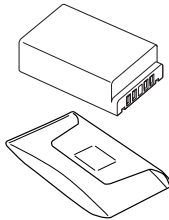

USB Cable
DT-380USB-A

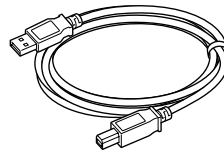

Hand Belt
HA-K95HB

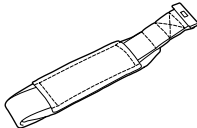

Screen Protect Sheet
HA-K90PS5

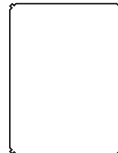

General Guide

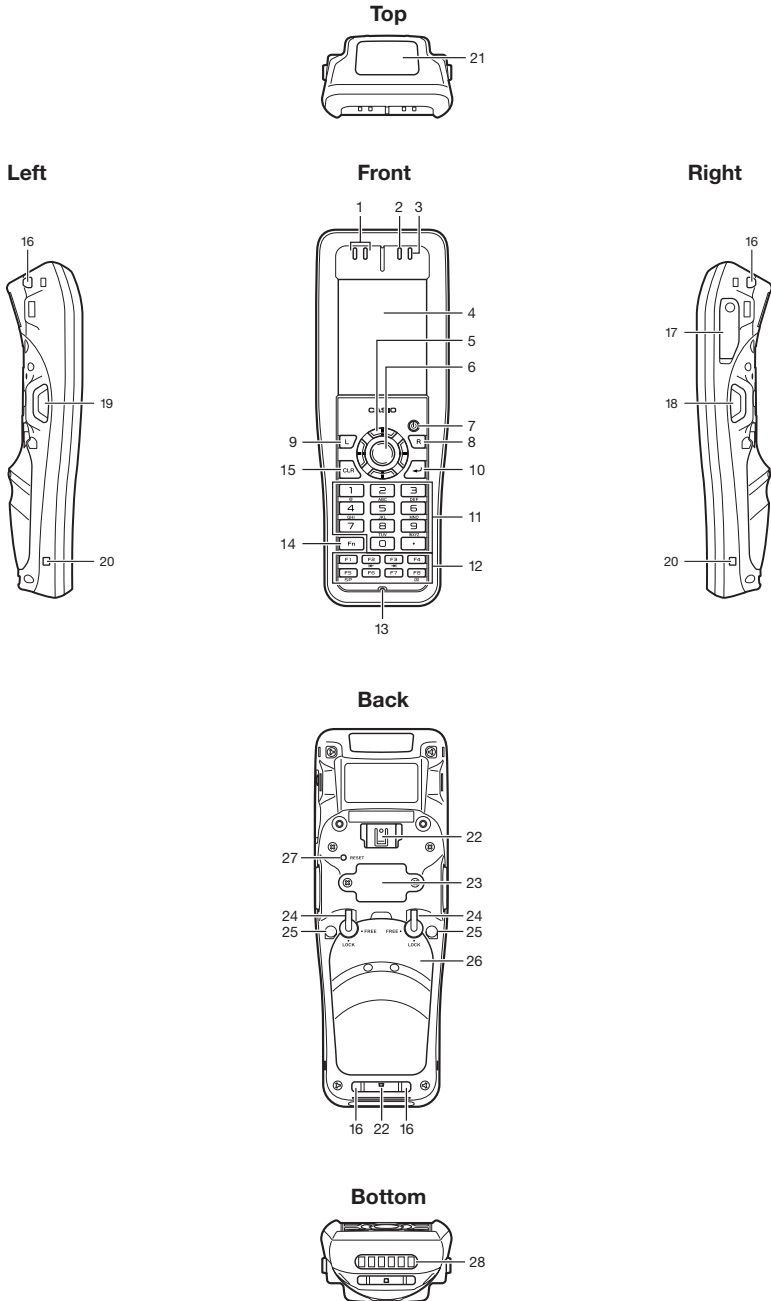

1	Speaker	Generates audio and buzzer tones.
2	Indicator 1	Orange: Charging Green: Charging complete Red: Battery pack error or the surrounding temperature is out of the charging temperature range.
3	Indicator 2	Flashes blue when operating via Bluetooth or orange when operating via W-LAN. Lights red when there is a bar code scanning error and lights green when a bar code scans successfully. Lights red when the alarm function is activated. Flashes magenta when the DT-X8 is ready to communicate.
4	Screen	The screen displays texts, operations, indicators and so forth.
5	Cursor Key	Perform the same functions as the up, down, left and right arrow keys on a PC keyboard.
6	Center Trigger Key	Used to perform bar code reading. Can be assigned an arbitrary function.
7	Power Key	Turns the power on and off.
8	R Key	Can be assigned an arbitrary function.
9	L Key	Can be assigned an arbitrary function.
10	Enter Key	Press when finishing entering numerical values or when moving to the next step.
11	Numeric Keys	Used to enter numeric values and decimal points.
12	Function Keys	F1: Similar function as the Alt key on a PC keyboard. F2: Similar function as the Shift+Tab keys combination on a PC keyboard. Used to move the cursor among entry or selection items. F3: Similar function as the Tab key on a PC keyboard. Used to move the cursor among entry or selection items. F4: Not assigned. F5: Enter a space. F6: Similar function as the cursor left key on a PC keyboard. F7: Similar function as the cursor right key on a PC keyboard. F8: Select text entry mode. (The mode changes in order of Numeric → Uppercase letter → Lowercase letter)
13	Microphone	Used for audio input (including voice).
14	Fn Key	Used to make various settings in combination with the numeric keys or when starting a pre-registered application.

15	CLR Key	Used to clear one letter to the left of the cursor.
16	Strap Holes	Used to attach neck strap and hand belt.
17	microSD Card Slot	microSD card slot.
18	R Trigger Key	Used to perform bar code reading.
19	L Trigger Key	Used to perform bar code reading.
20	USB and Charging Unit Mount Holes	Used to attach the USB and Charging Unit.
21	Barcode Reader/ NFC Reader	Laser light or LED light is emitted from this window that reads bar codes. When using NFC, hold the card or tag up to the reader.
22	Hand Belt Mount	Used to attach the hand belt.
23	Extension Port	Provided for future extension.
24	Battery Pack Cover Lock Switches	Used to lock the battery cover and to release.
25	Mount Holes	These holes hold the terminal seating in the optional USB Cradle or in the Ethernet Cradle.
26	Battery Pack Cover	Used to cover the battery compartment that holds the battery pack inside.
27	Reset Switch	Used to reset the Handheld Terminal.
28	Power Supply/Data Communication Terminals	Used to receive power provided by the USB Cradle, Ethernet Cradle or USB and Charging Unit. Also used for data communication.

Loading and Removing the Battery Pack

Your Handheld Terminal uses two types of battery: a battery pack and a memory backup battery.

The battery pack is used to power normal operations and to store data, while the memory backup battery provides the power required to maintain memory contents when the battery pack power is unable to supply power for some reason.

Use the battery pack (HA-K23XLBAT) as the main power source. The backup battery is installed inside of the Handheld Terminal.

This guide uses the following terms to refer to the batteries.

Battery Pack: Rechargeable battery pack (HA-K23XLBAT) for normal operations and data storage

Backup Battery: Built-in battery for memory backup

When the battery pack power goes low, immediately charge it or replace it with a charged battery pack.

You can use the USB Cradle, the Ethernet Cradle, the USB and Charging Unit, the Dual Battery Charger or the Cradle-type Dual Battery Charger to charge a battery pack installed in the terminal. See the relevant sections in this guide for the respective options about how to use.

Important!

Always keep backup of all important data!

- **The battery pack powers normal operation and also provides power required to maintain memory contents, while the backup battery provides backup power to maintain memory contents. Because of this, you should not remove the battery pack if the backup battery is dead. Removing the battery pack while the backup battery is dead causes data in the memory to be corrupted or lost. Note that once data is lost it cannot be recovered. Always keep backup of all important data.**
- **The charge of a battery pack when you purchase it may be depleted due to testing at the factory or natural discharge during shipment and storage. Be sure to charge the battery pack before you use it.**
- **The life of a battery pack is limited, and charging a battery pack causes it to gradually lose its ability to maintain the charge. If your battery pack seems to require charging very frequently, it probably means it is time to purchase a new one.**
- **If a battery pack is used past the end of its service life, it may swell up in size. In such a case, replace the battery pack with a new one.**
- **If the backup battery is fully charged, it will maintain the contents of the terminal's memory (RAM) for approximately 10 minutes when the main battery pack is removed.**
- **It takes 4 days with the main battery pack installed in the terminal for the backup battery to be charged fully.**

Loading

1. Turn the terminal over, turn the left and right lock switches for the battery pack cover to the “FREE” position (1), and then remove the battery pack cover (2).

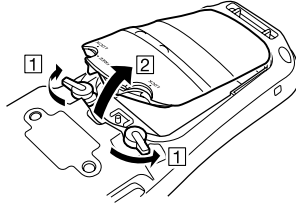

2. Load a battery pack (HA-K23XLBAT). Take care that the battery pack is oriented correctly when you load it. In addition, load the battery pack while making sure that the end of the battery pack removal tape is protruding above the battery pack.

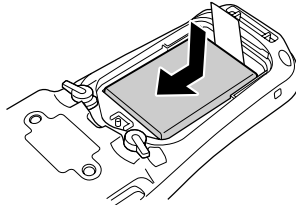

3. Put back the battery pack cover in the compartment as instructed by the arrows, 1 and 2 in the illustration and then turn the lock switches to the “LOCK” position (3).

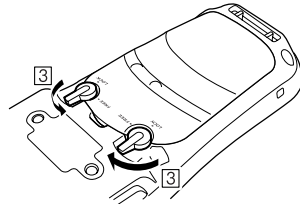
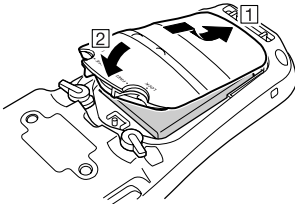

Removing

1. Make sure that the Handheld Terminal is turned off.
If the power is on, press the power key to turn it off.
2. Turn the terminal over, turn the left and right lock switches for the battery pack cover to the “FREE” position (1), and then remove the battery pack cover (2).

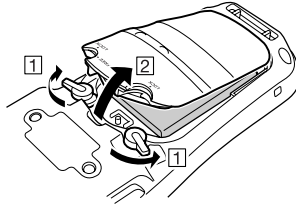

3. Remove the battery pack by pulling up the removal tape as shown in the illustration.

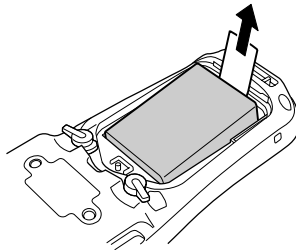

Important!

- When removing the battery pack, make sure you do not leave the Handheld Terminal without a battery pack for more than about 10 minutes. Doing so can cause data in the memory to be deleted.
- When removing the battery pack, be sure you carefully follow the proper procedure as explained in this guide.
- Never try to use other type of battery than the ones that are specified for this product.
- When removing the battery pack, pull the removal tape straight up and remove the battery pack. Removing with excessive force can damage the battery pack.
- Before starting to use the Handheld Terminal, ensure that the battery pack cover is properly closed. If not, the power is not turned on or is turned off abruptly while it is in use.
- When the hand belt is attached to the terminal, loosen the hand belt before opening or closing the battery pack cover. Pulling with excessive force could damage the hand belt or hand belt mount.

Attaching the Pen Cord

The pen cord can be used to prevent the pen (stylus) from being lost. Since there are two strap holes where the pen cord can be attached on the back of the terminal near the top, use the hole that affords the greatest ease of use. Attach the pen cord according to the procedure described below.

1. Pass the loop on the end of the pen cord (the end not attached to the pen) through the cord hole on the back of the terminal near the top.

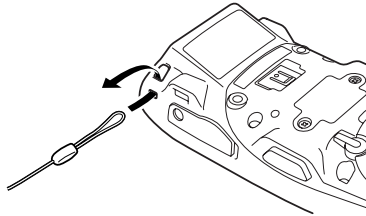

2. Then pass the pen through the loop.

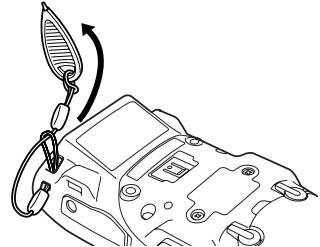
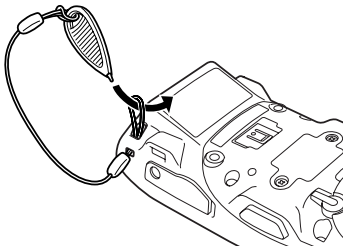

Important!

- Do not swing the Handheld Terminal around holding the pen cord.

Attaching the Hand Strap

The hand strap can be used to prevent the Handheld Terminal from fall. Since there are four strap holes where the hand strap can be attached, use the hole that affords the greatest ease of use. Attach the hand strap according to the procedure described below.

To attach the hand strap

1. Pass the thin cord of the hand strap through the strap hole on the back of the Handheld Terminal.

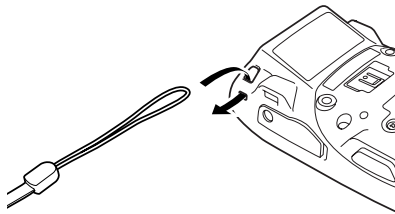

2. Pass the other end of the strap (the part you put around your wrist) through the loop formed by the thin cord.

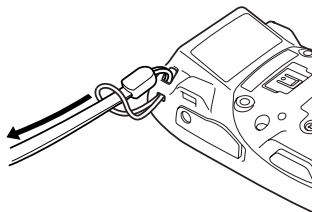
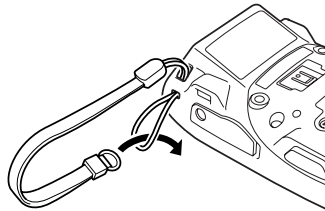

Important!

- Do not swing the Handheld Terminal around holding the hand strap.

Calibrating Touch Panel Alignment

Whenever the response of the touch panel is poor, or operation being executed does not match with the location you are tapping on the touch panel, please recalibrate the alignment of the touch panel using the following method.

- Press the “Fn” key and then press the “4” key after confirming that “F” is displayed in the lower right corner of the screen. The following screen is displayed.
- * You can also display this screen by navigating as follows:

Start → Settings → Stylus → Screen → Align Screen

Carefully press and briefly hold stylus on the center of the target. Repeat as the target moves around the screen. Press the Fn key and then the CLR key to cancel.



- Press the stylus against the center of the target mark (+ mark) as indicated on the screen.

Press the stylus against the target mark on the screen 5 times to display the next screen. Then press the Enter key or tap anywhere on the screen.

New settings have been measured. Press the Enter key to accept the new settings. Press the Fn key and then the CLR key to keep the old settings.

Setting the Display Brightness

Adjusting Display Brightness

You can use the following procedures to adjust display brightness to make it easier to read under different lighting conditions.

- Press the “Fn” key and then press the “5” key or “6” key after confirming that “F” is displayed on the screen. Pressing the “5” key adjusts brightness for a darker display, while pressing the “6” key adjusts brightness for a lighter display.
- * In order to continue to make adjustments, press the “5” key or “6” key again after first pressing the “Fn” key.
- * You can set the brightness by tapping “Brightness” in the Control Panel.

Display Auto Dimmer

The display auto dimmer automatically lowers display brightness if you do not perform any operation for a specific period of time. This helps the battery power to be conserved.

Tap “Brightness” in the Control Panel and select the “Backlight” tab to set the time delay until the display dims.

Using the Laser Scanner (Laser Models)

1. After turning on the power, position the laser scanner close to a bar code and then press the trigger key.



2. The laser emits light and scans the bar code. If scanning is completed normally, Indicator 2 displays a green light.

Important!

- **If you are unable to scan a bar code, try changing the angle at which the scanner is held or distance from the scanner to the bar code, and then try scanning again.**
- **This Handheld Terminal is capable of scanning bar codes at a distance of about 40-400 mm ($1^{9/16}$ "- $15^{3/4}$ "). Furthermore, the distance at which scanning is possible may vary according to the bar code symbology.**

Bar Code Scanning Position

Position the laser scanner close to the bar code when scanning small bar codes.

Position the laser scanner at a distance from the bar code so that the bars enter the light when scanning large bar codes.

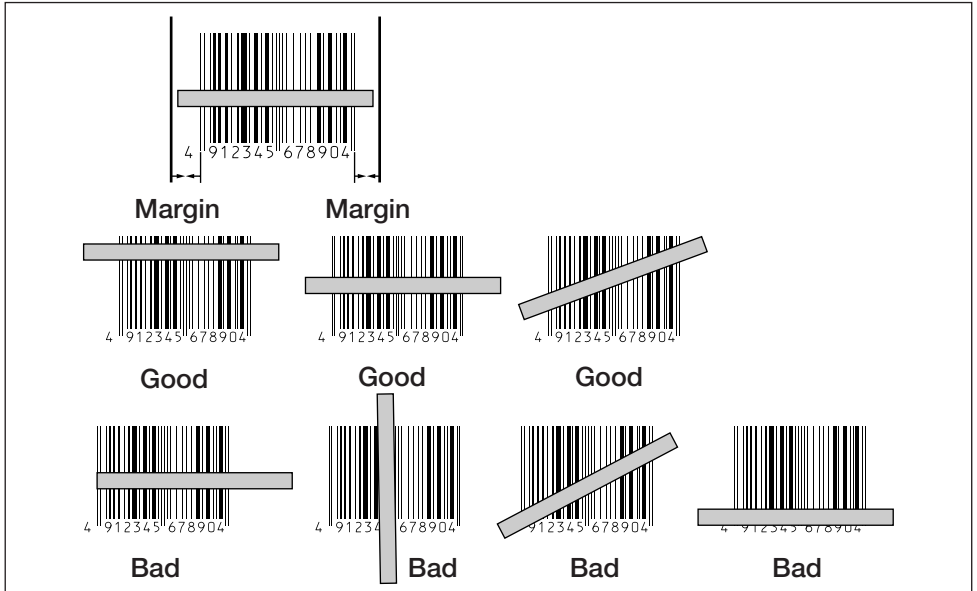

Warning!

■ Never look directly into the laser light.



- The products with the integrated Laser Scanner module scan bar codes using laser light. Never look directly into the laser light or shine the laser light into the eyes.

Adjusting the Laser Light Emission Width

The emission width of the laser light emitted by the Handheld Terminal (model dependant) can be adjusted. Adjust the emission width when it is improper.

1. Navigate to the menus in the following sequence:

Start → Settings → Control Panel

The Control Panel appears as shown in the screen.

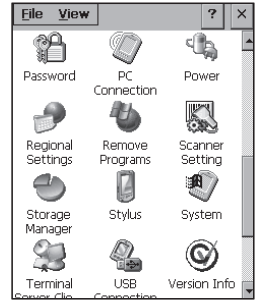

2. Double-tap the [Scanner Setting] icon. The Setting screen appears as shown in the screen.

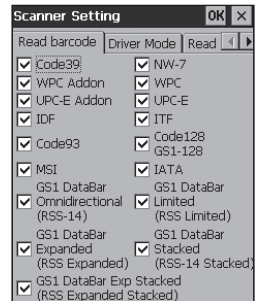

3. Tap the [Others] tab in the Scanner Setting screen.

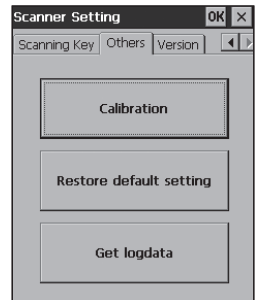

4. Tap the [Calibration] button. The display appears as shown at right.

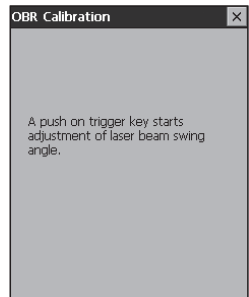

5. Press the trigger key to emit laser light, and align the light with the barcode for adjusting emission width.
- Align the laser light with the narrow bars on both sides.
 - The message appears as shown at right when adjustment is completed.
 - Repeat the setting if "Setting failed" message appears.

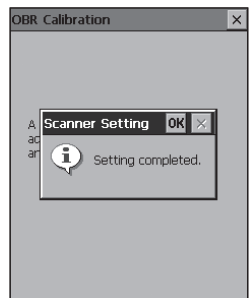

Emission Width Adjustment Bar code

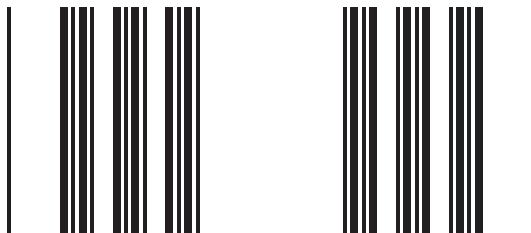

Using the CMOS Imager (Imager Models)

1. Turn on the Handheld Terminal, position its CMOS Imager reader port near the bar code or 2D code, and then press the trigger key.



2. The Handheld Terminal reads the code by emitting laser and red lights. Indicator 2 (read operation indicator lamp) lights in green when the reading is successful.

Bar code and stacked 2D code Reading Guide

When you press the trigger key, LEDs in the Handheld Terminal emit laser and red lights. Align the laser frame with the center of the bar code or 2D code you are trying to read. Take particular care aligning the light when there are other bar codes nearby.

When reading a bar code in large size, adjust the position of the Handheld Terminal so that the entire code is enclosed within the laser frame. For small size, move the Handheld Terminal closer to it.

Important!

- If you have problem not properly reading a code, change the angle and/or the distance between the code and the Handheld Terminal and try reading it again.
- A bar code can be read from a distance of 45mm to 410mm ($1\frac{3}{4}$ " to $16\frac{1}{8}$ "), and a stacked 2D code can be read from a distance of 65mm to 260mm ($2\frac{9}{16}$ " to $10\frac{1}{4}$ ") and matrix 2D code can be read from a distance of 55mm to 195mm ($2\frac{3}{16}$ " to $7\frac{11}{16}$ "). The actual reading distance depends on the symbology and the resolution.
- Fingerprints, dust, dirt, or stain on the CMOS Imager reader port can cause abnormal reading. Should the reader port become dirty, wipe it clean with a soft and dry cloth.

Using the Full Range Imager (Full Range Imager Models)

1. Turn on the Handheld Terminal, aim its CMOS Imager reader port toward the bar code or 2D code, and then press the trigger key.

The aimer in a round shape is emitted onto barcode.

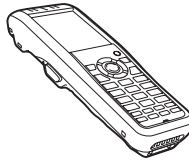

2. The Handheld Terminal reads the code by emitting laser and red lights. Indicator 2 (read operation indicator lamp) lights in green when the reading is successful.

Bar code and stacked 2D code Reading Guide

When you press the trigger key, LEDs in the Handheld Terminal emit laser and red lights. Align the laser pointer with the center of the bar code or 2D code you are trying to read. Take particular care aligning the light when there are other bar codes nearby.

When reading a bar code in large size, adjust the position of the Handheld Terminal so that the entire code is at proper distance. For small size, move the Handheld Terminal closer to it.

Important!

- **If you have problem not properly reading a code, change the angle and/or the distance between the code and the Handheld Terminal and try reading it again.**
- **A bar code and a stacked 2D code can be read from a distance of 130mm to 2,500mm (5¹/₈" to 98⁷/₁₆"), and matrix 2D code can be read from a distance of 100mm to 20,000mm (3¹⁵/₁₆" to 65⁷/₈"). The actual reading distance depends on the symbology and the resolution.**
- **Fingerprints, dust, dirt, or stain on the CMOS Imager reader port can cause abnormal reading. Should the reader port become dirty, wipe it clean with a soft and dry cloth.**

Handling the NFC Reader/Writer (DT-X8-11E/11C/21E/21C)

NFC is a type of RFID (Radio Frequency Identification) technology that allows the data in a device to be read simply by holding the device up to an NFC reader. It can be used to read RFID tags used for controlling goods as well as contactless IC cards used in applications such as employee identification.

RFID Tags

1. Hold the Handheld Terminal up so that the reader port is parallel with the RFID tag.

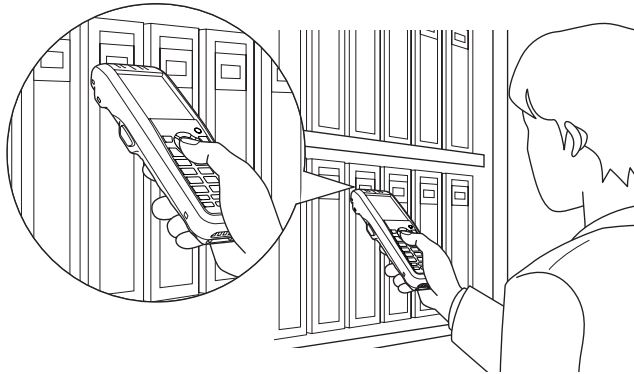

Contactless IC Cards

1. Hold the contactless IC card up so that it is parallel with the Handheld Terminal's reader port.
Otherwise, you can hold the Handheld Terminal up to the card.

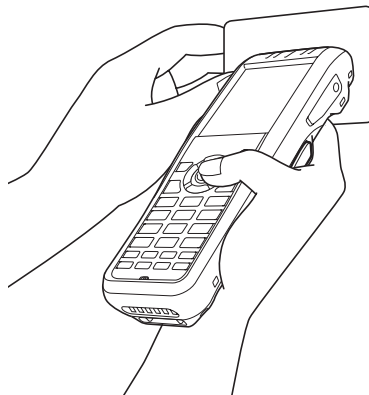

Important!

Both contactless IC cards and RFID tags

- The NFC employs a low power radio wave which does not require regulatory station license.
- Frequency band used by the NFC is 13.56 MHz. Secure a sufficient space between DT-X8 and other reader/writer located in the vicinity. Make sure also that a radio station employs the same frequency band does not locate near by prior to using DT-X8.
- Read a contactless IC card or RFID tag by holding the Handheld Terminal so that the reader port is flush against the card or tag.
- When holding up the Handheld Terminal, take care not to strike the reader port against the card or tag.
- If the card or tag cannot be read, try moving the Handheld Terminal back and forth or side to side.

Contactless IC cards

- Metal objects near a contactless IC card will interfere with successful reading. Take the card out of a wallet if the wallet is with metal object before applying it to the reader port.
- The card may not be read correctly if it is overlapped by one or more other cards.

RFID tags

- Metal objects near an RFID tag will interfere with successful reading. Move the tag away from any nearby metal objects or use a tag designed for use with metal.
- The tag may not be read correctly if it is overlapped by one or more other tags. Set up the Handheld Terminal so that tags can be kept completely apart during reading.

Handling microSD Cards

The Handheld Terminal supports microSD card.
Install (or remove) a microSD card according to the procedure described below.

Installing

1. Open the cover of the microSD card slot (1) and insert a microSD card all the way in until the top of the microSD card aligns with the entrance of the slot of the Handheld Terminal (2).
- Insert the card firmly all the way into the slot.
 - Avoid inserting the card diagonally.

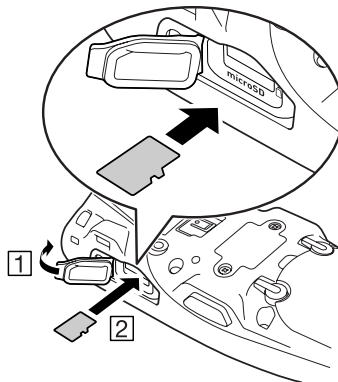

2. Close the cover of the microSD card slot.

Removing

1. Open the cover of the microSD card slot and press on the microSD card (1).
The microSD card is pushed out (2).

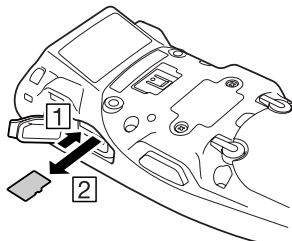

2. Pull out the microSD card and close the cover of the microSD card slot.

Important!

- A microSD card must be inserted with the top and bottom properly aligned and in the proper direction. Attempt in inserting it with an excessive force in incorrect orientation can risk damage to the connectors and slot.
- Never turn off the power or remove a microSD card from the slot while the card is being accessed. Doing so can damage the microSD card or data in the card.
- Do not drop the card or lose it.

Performing Bluetooth® Communication

Bluetooth® interface can also be used to transfer data between two Handheld Terminals. With Bluetooth® the two Handheld Terminals should be located within about three meters (9'10³/₈"") from each other, as long as there is nothing blocking the path between them.



Important!

Observe the following precautions to help ensure that Bluetooth communication is successful.

- **Make sure two Handheld Terminals face each other within three meters (9'10³/₈""). Surroundings (obstacles) between the Handheld Terminals may cause a shorter distance.**
- **Make sure there is at least two meters (6'7"") between the Handheld Terminal and other equipment (electrical appliances, audio-visual equipment, OA equipment, and digital cordless telephones, facsimile machines, etc.). Take special care with microwave ovens. Allow at least three meters (9'10³/₈"") between the Handheld Terminals in wireless operation and a microwave oven. When operating the terminal in Bluetooth nearby these devices and electrical appliances with their powers being turned on, communication may be interrupted or TV and radio receptions may be interfered (images on the screen produced by certain channels of UHF and broadcast satellite may become blurry).**
- **Normal communication may not be possible in an area near a broadcast transmitter or wireless transmitter. If this happens, move the Handheld Terminal to a different location. Normal communication may not be possible in areas exposed to strong radio waves.**
- **Interference by WLAN**
Because Bluetooth® and WLAN use the same frequency band (2.4GHz), radio interference can occur if there is a WLAN device nearby. This can result in lower communication speed, or even make it impossible to establish a connection. If this happens, try the following countermeasures.
 - Move at least 10 meters (32'10³/₄"") away from the WLAN device.
 - If you cannot keep the distance at least 10 meters (32'10³/₄"") or more between the Handheld Terminal and a WLAN device, turn off the power of either the Handheld Terminal or the WLAN device.
 - Although the Handheld Terminal enables WLAN and Bluetooth® communication to be used simultaneously as a result of being equipped with Bluetooth® Ver.2.0, communication may not be possible depending on the surrounding radio wave environment.

Resetting the Handheld Terminal

Resetting the terminal is the same as resetting a PC. Performing a reset causes all unsaved RAM data to be lost that are in mid-course of inputting and editing, but data and settings that are already stored in the FlashROM should be unaffected. Perform a reset to restore normal operation whenever the Handheld Terminal operates abnormally due to misoperation or some other reason.

Use the pen (stylus) to press the reset switch on the back of the terminal. This starts the reset operation.

* Do not use a toothpick or pencil or other sharp object whose tip may break off the reset switch.

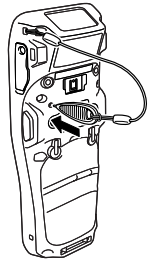

Performing a Full Reset (Initialization)

Performing a full reset deletes all data and resets various settings to their defaults.

*Data stored in the Flashdisk folder remain unaffected.

Perform a full reset whenever any one of the following conditions exists.

- When you want to delete installed programs and settings, and resume the terminal to the initial condition.
- When you are no longer able to use the Handheld Terminal because you forgot your password.
- When the Handheld Terminal does not operate normally due to a memory problem.

Important!

- **Performing a full reset resets all data to their defaults except stored in the Flashdisk folder. If possible, backup data of the terminal to a PC or to the Flashdisk folder. The reset procedure and display message appeared on performing the reset is according to the model you operate.**

-
1. While holding down the Fn key and CLR key, push down the reset switch for about 3 seconds with the pen (stylus) until the message shown below appears on the display.
 - To cancel the full reset operation, press the L Trigger key.

*Full Reset Warning
The following operation
initializes the Root Disk.
Press the [R Trigger key] to proceed
or the [L Trigger key] to cancel.*

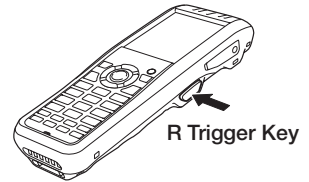

2. Press the R Trigger key. This causes the message shown below to appear.
 - To cancel the full reset operation, press the L Trigger key.

*Full Reset Warning
The following operation deletes all data
stored in the Root Disk.
Press the [R Trigger key] to proceed
or the [L Trigger key] to cancel.*

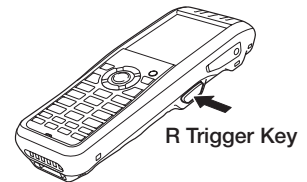

3. Press the R Trigger key again to perform the full reset.
 - The full reset starts and all data in the memory are erased, and the start-up screen appears.
Data stored in the Flashdisk folder remain unaffected.

DT-X8 Specifications

Model: DT-X8-10E/10C/11E/11C/20E/20C/21E/21C/40E/40C/41E/41C

CPU: Marvell® PXA320 624MHz

Memory: 128MB RAM, 256MB Flash ROM (user defined: 160MB)

OS: Microsoft® Windows® Embedded CE 6.0 R3 operating system

Display: 6.9 cm (2.7 inches), 240 × 320-dot Blaview® TFT Color LCD

Laser Scanner (DT-X8-10E/10C/11E/11C):

Readable symbologies: UPC-A/UPC-E/EAN8 (JAN8)/EAN13 (JAN13)/Codabar (NW-7)/Code39/Interleaved 2 of 5 (ITF)/MSI/Industrial 2 of 5/Code93/Code128 (GS1-128 (EAN128))/IATA/GS1 DataBar Omnidirectional (RSS-14)/GS1 DataBar Limited (RSS Limited)/GS1 DataBar Expanded (RSS Expanded)/GS1 DataBar Stacked (RSS-14 Stacked)/GS1 DataBar Expanded Stacked (RSS Expanded Stacked)/GS1 DataBar Truncated (RSS-14 Truncated)/GS1 DataBar Stacked Omnidirectional (RSS-14 Stacked)

Scanning distance: Within approximately 40-400 mm ($1^{9/16}$ "- $15^{3/4}$ ")

CMOS Imager (DT-X8-20E/20C/21E/21C):

Readable symbologies: 1D: UPC-A/UPC-E/EAN8 (JAN8)/EAN13 (JAN13)/Codabar (NW-7)/Code39/Interleaved 2 of 5 (ITF)/MSI/Code93/Code128 (GS1-128 (EAN128))/Code11/IATA/GS1 DataBar Omnidirectional (RSS-14)/GS1 DataBar Limited (RSS Limited)/GS1 DataBar Expanded (RSS Expanded)/Code32/GS1 DataBar Truncated (RSS-14 Truncated)/ISBT
Stacked 2D: PDF417/Micro PDF/CODE49/Composite/Codablock F/TLC39/GS1 DataBar Stacked Omnidirectional (RSS-14 Stacked)/GS1 DataBar Expanded Stacked (RSS Expanded Stacked)/GS1 DataBar Stacked (RSS-14 Stacked)
Matrix 2D: Aztec/DataMatrix/Maxicode/QR Code/Micro QR/Chinese Sensible Code (Han Xin Code)

Scanning distance: 1D: 45 – 410 mm ($1^{3/4}$ "- $16^{1/8}$ ")
Stacked 2D: 65 – 260 mm ($2^{9/16}$ "- $10^{1/4}$ ")
Matrix 2D: 55 – 195 mm ($2^{3/16}$ "- $7^{11/16}$ ")

Full Range Imager (DT-X8-40E/40C/41E/41C):

Readable symbologies: 1D: UPC-A/UPC-E/EAN8 (JAN8)/EAN13 (JAN13)/Codabar (NW-7)/Code39/Interleaved 2 of 5 (ITF)/MSI/Code93/Code128 (GS1-128 (EAN128))/Code11/IATA/GS1 DataBar Omnidirectional (RSS-14)/GS1 DataBar Limited (RSS Limited)/GS1 DataBar Expanded (RSS Expanded)/Code32/GS1 DataBar Truncated (RSS-14 Truncated)/ISBT
Stacked 2D: PDF417/Micro PDF/Composite/Codablock F/GS1 DataBar Stacked Omnidirectional (RSS-14 Stacked)/GS1 DataBar Expanded Stacked (RSS Expanded Stacked)/GS1 DataBar Stacked (RSS-14 Stacked)
Matrix 2D: Aztec/DataMatrix/Maxicode/QR Code(Model2)/Micro QR

Scanning distance: 1D: 130 – 2,500 mm ($5^{1/8}$ "- $98^{7/16}$ ")
Stacked 2D: 130 – 2,500 mm ($5^{1/8}$ "- $98^{7/16}$ ")
Matrix 2D: 100 – 20,000 mm ($3^{15/16}$ "- $65^{7/8}$ ")

Bluetooth® :

Protocol: Bluetooth® Specification Ver.2.0 + EDR
Communication Range: Approximately 3 m (9'10³/s") (depends on radio wave conditions and environment)
Output: 4dBm max. (PowerClass2)

WLAN:

Standards: IEEE 802.11b/g
Diffusion Modulation: DS: 802.11b
DS/OFDM: 802.11g
Frequency: 802.11b/g: 2.400-2.4835 GHz
Transmission Rate: 802.11b: Max. 11 Mbps
802.11g: Max. 54 Mbps
Communication Range: 50 m indoors, 150 m outdoors (varies according to usage environment and transmission rate)

NFC (DT-X8-11E/11C/21E/21C/41E/41C):

Frequency Band: 13.56 MHz ± 7 KHz
Antenna: Magnetic Loop Antenna
Operating Magnetic Field: Magnetic Strength Output 1.5A/m or greater (when touching the case)
Bit Rate: 106 kbps, 212 kbps, 424 kbps, 1.65 kbps
Modulation: Amplitude Shift Keying
Modulation Degree: 10 % degree, 100 % degree
Communication Range: ISO14443TypeA/B, FeliCa: 0 mm (touching the case)
ISO15693: 0 mm (touching the case)
Communication Area: Area in 32 mm × 20 mm (card/tag dependent)
Supported Cards: ISO14443TypeA, ISO14443TypeB, FeliCa (JIS X 6319) , ISO15693

microSD Memory Card Slot:

Compatible with SDHC Memory Card

Power Requirements:

Power Source: Battery Pack (HA-K23XLBAT)
Memory Backup: Rechargeable Lithium Battery (Built-in)
Consumption Current: DC 2.2A: DT-X8-10E/10C/11E/11C
DC 2.4A: DT-X8-20E/20C/21E/21C/40E/40C/41E/41C

Battery Life:

Battery pack:
Approximately 25 hours*: DT-X8-10E/10C/11E/11C
Approximately 20 hours*: DT-X8-20E/20C/21E/21C/
40E/40C/41E/41C

* under the conditions that CPU speed is set to the auto power save mode, backlight is set to off, and the ratio of cyclic operation of “Standby, Key input, Scanning, and WLAN” is set at 20:1:1:1.

Memory backup: 10 minutes for protection of data in memory
3 days for backup of built-in clock

Operating Temperature: -20°C to 50°C (-4°F to 122°F)

Operating Humidity: 10% to 90% RH (non-condensation)

Dust and Water Splash Proof:

IP67-compliant

Dimensions: Refer to “Dimensional Drawings” on page 42.

Weight:

- DT-X8-10E/10C/20E/20C: Approximately 280g (9.9oz)
(when battery pack is installed)
- DT-X8-11E/11C/21E/21C: Approximately 285g (10.1oz)
(when battery pack is installed)
- DT-X8-40E/40C: Approximately 290g (10.2oz)
(when battery pack is installed)
- DT-X8-41E/41C: Approximately 295g (10.4oz)
(when battery pack is installed)

Dimensional Drawings

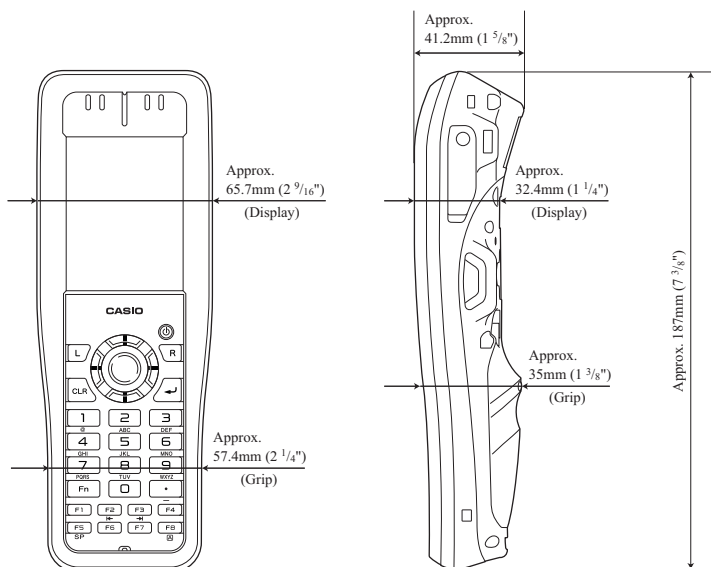

DT-X8-10E/10C/11E/11C/20E/20C/21E/21C

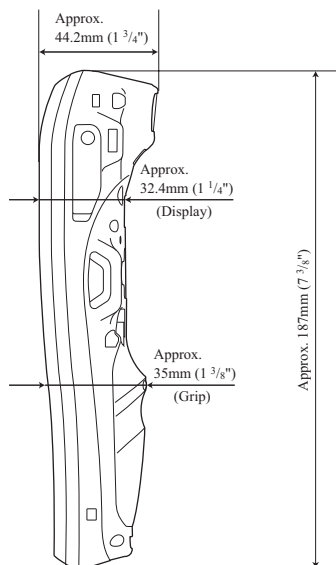

DT-X8-40E/40C/41E/41C

Handling the Hand Belt (HA-K95HB)

An optional hand belt (HA-K95HB) can be attached to the terminal.

Attaching the hand belt

1. As shown in the figure, align the metal part of the hand belt hook in line with the installation position on the terminal and then snap it into the ditch. Make sure that the metal part is firmly seated.

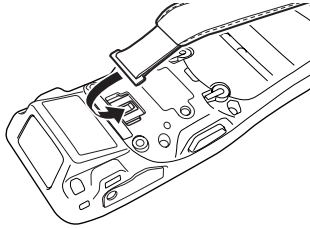

2. Thread one end of the hand belt through the hand belt hook. Then fold it back and set the belt in proper length by adjusting the hook-loop fastener.

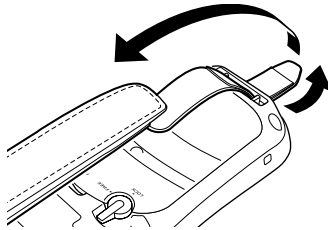

Removing the hand belt

1. As shown in the figure, pull out the metal part of the hook while pressing down the protrude part that has a small dimple on it.

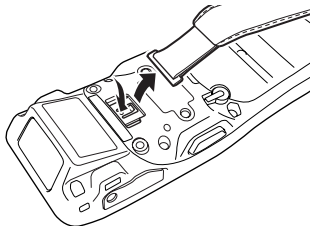

2. Loosen the hook-loop fastener and then pull out the belt through the hand belt hook as shown in the figure.

Using the USB Cradle (HA-K60IO)

The optional USB Cradle (HA-K60IO) makes it possible to transmit system data and file data between the Handheld Terminal and a PC via a USB connection (download or upload). You can also use the USB Cradle to charge the battery pack installed in the Handheld Terminal.

General Guide

Top

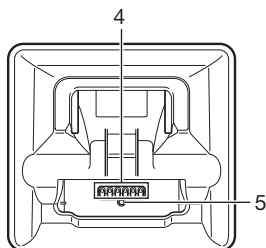

Front

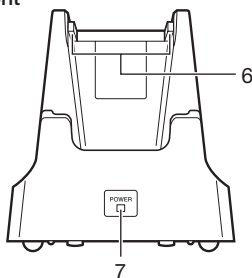

Right

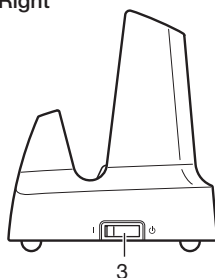

Back

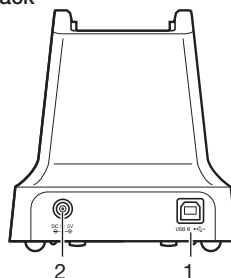

1	USB Client Port	This port is used to transmit system data and file data (download, upload) by connecting the Cradle to a PC using a USB cable (DT-380USB-A). A dedicated driver must be installed in the PC before connecting the Cradle to the PC.
2	AC Adaptor Jack	Connect the AC adaptor (sold separately) here.
3	Power Switch	Turns the power on and off.
4	Power Supply/Data Communication Terminals	Power is supplied to the DT-X8 via these contacts. Also used for data communication.
5	Terminal Detect Switch	This switch detects when the DT-X8 is seated correctly on the Cradle.
6	Mount Hooks	These hooks are used to stabilize the Handheld Terminal when mounting it on the cradle.
7	Power Indicator LED	This LED indicates the power status and the mounting status of the DT-X8. Off: DT-X8 is not installed. Green: Power on, DT-X8 mounted correctly.

Connecting the USB Cradle Power Supply

Use the optional AC adaptor (AD-S15050B) for the power supply of the USB Cradle. Always make sure to connect the AC adaptor to the USB Cradle before performing communication with the Handheld Terminal. Power to the Handheld Terminal is supplied from the USB Cradle.

1. Plug the AC adaptor into the AC adaptor jack on the back of the USB Cradle.

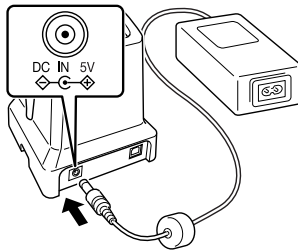

2. After connecting the power cable to the AC adaptor, plug the other end of it into an electrical outlet.

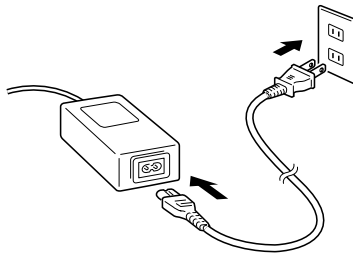

3. Connect the USB cable (DT-380USB-A) to the USB client port on the back of the USB Cradle, and then connect it to the PC.

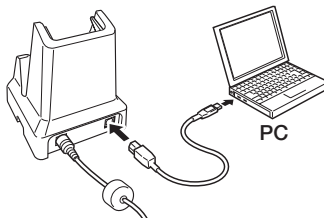

-
4. Turn on the power switch on the right side of the USB Cradle. The power LED on the front of the USB Cradle lights red.

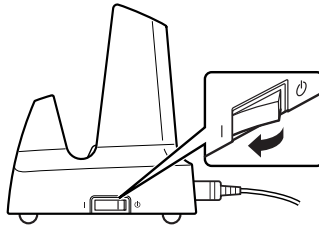

5. Align the terminals on the bottom of the DT-X8 with the power supply terminals in the USB Cradle before inserting the DT-X8 (1). Push the DT-X8 fully into the USB Cradle until the mount hooks in the cradle engage the mount holes in the DT-X8 (2).

Check that the power LED on the front of the USB Cradle lights green and that indicator 1 on the DT-X8 lights.

To remove the DT-X8 from the USB Cradle, tilt the DT-X8 forward to disengage the mount hooks from the mount holes and then lift the DT-X8 out of the cradle.

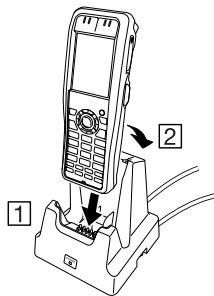

Status of Indicator 1 on DT-X8:

Orange: Charging the battery pack.

Red Flashing: Standby due to battery pack error or the surrounding temperature is out of the charging temperature range.
(charging begins when the temperature is within the charging temperature range)

Green: Charging the battery pack is complete.

Status of Indicator 2 on DT-X8:

Blue Flashing: Operating via Bluetooth®.

Orange Flashing: Operating via WLAN.

Magenta Flashing: Ready to communicate.

Important!

- Allowing the power supply terminals become wet can cause an electric shock or fire. In addition, if the terminals become soiled, contact may be impaired resulting in poor charging. For reasons of safety and maintaining charging battery pack(s) in optimum condition, clean the power supply terminals by wiping with a dry cloth or cotton swab after disconnecting the AC adaptor.
- Never short out the power supply terminals of the USB Cradle. This can damage the USB Cradle.
- Do not subject the Handheld Terminal and USB Cradle to vibration or impact during communication. This can cause communication to be interrupted.
- When mounting the DT-X8, securely attach to the mount hooks of the USB Cradle and make sure that the power LED at the front of the USB Cradle is lit in green. Charging and communication will not proceed properly if the DT-X8 is not mounted properly.
- Always cap ports that are not being used. Using the USB Cradle while the ports are uncapped can cause damage.
- If the hand strap is attached to the terminal, take care not to trap it when mounting the DT-X8. Pull the hand strap out as shown in the illustration. If you are having difficulties mounting the DT-X8, attach the hand strap using the strap hole on the top of the terminal.

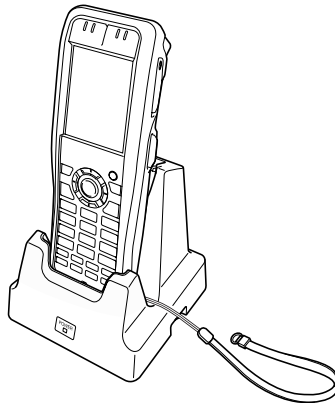

Specifications

1. USB

Protocol: USB Ver1.1 Standard
Transfer Rate: 12Mbps (max.)

2. Charging

Charging Method: Constant current/voltage
Charge Period: Approximately 4 hours

3. Power Supply

Power Source: AC adaptor (AD-S15050B)
Consumption Current: 5V DC approximately 3.0A
Output to Handheld Terminal: 5V DC 3.0A (max.)

4. AC Adaptor

Model: AD-S15050B
Input: 100V to 240V AC 50/60Hz 0.36-0.2A
Output: 5V DC 3.0A

5. Dimensions and Weight

Dimensions: Approximately 110(W) × 111(D) × 126(H) mm
(4⁵/₁₆"W × 4³/₈"D × 4¹⁵/₁₆"H)
Weight: Approximately 307g (10.8oz)

6. Operating Environment

Temperature: 0°C to 40°C (32°F to 104°F)
Humidity: 10% to 90% RH (non-condensation)

The AD-S15050 series comes available in the following models depending on area or region where you are in.

Model no. of AC Adaptor	Area/Region	Compliance
AD-S15050B	All except China	Compliant with CE, UL, FCC, and Energy Efficiency Standards.
AD-S15050B-CN	China only	Compliant with Energy Efficiency Standards and CCC.

Using the Ethernet Cradle (HA-K62IO)

The optional Ethernet Cradle (HA-K62IO) makes it possible to transmit system data and file data between the Handheld Terminal and a PC via a USB or LAN connection (download or upload). You can also use the Ethernet Cradle to charge the battery pack installed in the Handheld Terminal.

General Guide

Top

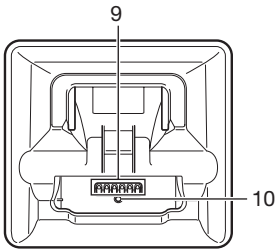

Front

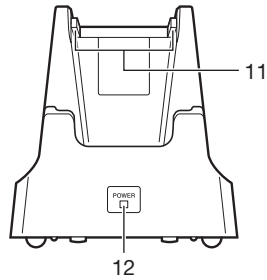

Left

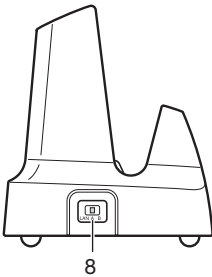

Right

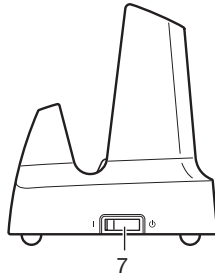

Back

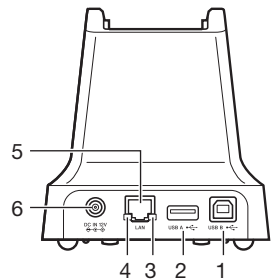

1	USB Client Port	This port is used to transmit system data and file data (download, upload) by connecting the Ethernet Cradle to a PC using a USB cable (DT-380USB-A). The dedicated driver must be installed in the PC before connecting the Ethernet Cradle to the PC.
2	USB Host Port	This port is used to connect a corresponding USB peripheral device.
3	LAN Connection Status LED	This LED shows the status of the LAN connection. Off: LAN cable not connected correctly. Lit orange: LAN cable connected correctly.
4	LAN Communication Status LED	This LED shows the LAN operation status. Off: No communication. Blinking: Communication in progress.
5	LAN Port	This port is used for connecting the cradle to a PC or hub via a LAN cable so that system data and file data can be transmitted (uploaded or downloaded). The special driver software must be installed in the DT-X8.
6	AC Adaptor Jack	Connect the AC adaptor (sold separately) here.
7	Power Switch	Turns the power on and off.
8	Selector Switch	This switch is used to switch between a USB connection and a LAN connection. LAN: LAN A: USB host B: USB client
9	Power Supply/Data Communication Terminals	Power is supplied to the DT-X8 via these contacts.
10	Terminal Detect Switch	This switch detects when the DT-X8 is seated correctly on the Ethernet Cradle.
11	Mount Hooks	These hooks are used to stabilize the Handheld Terminal when mounting it on the cradle.
12	Power Indicator LED	This LED indicates the power status and the mounting status of the DT-X8. Off: DT-X8 is not installed. Green: Power on, DT-X8 mounted correctly.

Connecting the Ethernet Cradle Power Supply

Use the optional AC adaptor (AD-S42120B/AD-S42120C) for the power supply of the Ethernet Cradle. Always make sure to connect the AC adaptor to the Ethernet Cradle before performing communication with the Handheld Terminal. Power to the Handheld Terminal is supplied from the Ethernet Cradle.

1. Plug the AC adaptor into the AC adaptor jack on the back of the Ethernet Cradle.

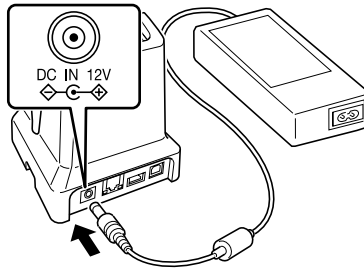

2. After connecting the power cable to the AC adaptor, plug the other end of it into an electrical outlet.

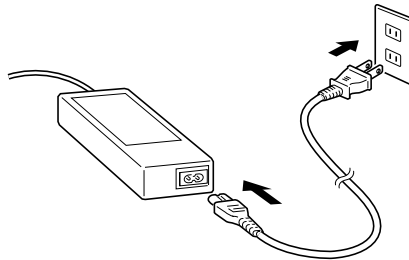

3. Use the selector switch on the left side of the Ethernet Cradle to select the port to be used. Set the switch to the “LAN” position when using the LAN port on the cradle. Set the switch to the “B” position when using the unit as a USB client, or set it to the “A” position when using the unit as a USB host.

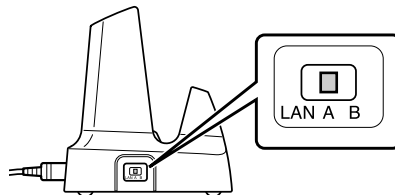

-
4. Before using the cradle ports, remove the caps from the ports.

When using a LAN, connect one end of the LAN cable to the LAN port and the other end to the PC or hub.

When using a USB connection, connect one end of the USB cable (DT-380USB-A) to the USB port and the other end to the PC.

The USB host port is used for connecting the cradle with other USB peripheral device.

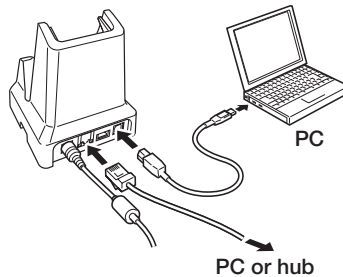

5. Turn on the power switch on the right side of the Ethernet Cradle. The power LED on the front of the Ethernet Cradle lights red.

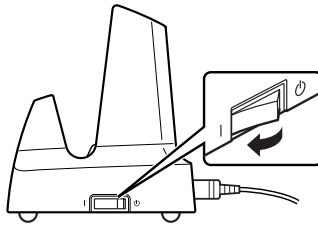

6. Align the terminals on the bottom of the DT-X8 with the power supply terminals in the Ethernet Cradle before inserting the DT-X8 (1). Push the DT-X8 fully into the Ethernet Cradle until the mount hooks in the cradle engage the mount holes in the DT-X8 (2).

Check that the power LED on the front of the Ethernet Cradle lights green and that indicator 1 on the DT-X8 lights.

To remove the DT-X8 from the Ethernet Cradle, tilt the DT-X8 forward to disengage the mount hooks from the mount holes and then lift the DT-X8 out of the cradle.

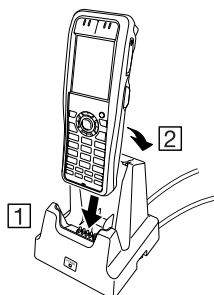

Status of Indicator 1 on DT-X8:

- Orange: Charging the battery pack.
Red Flashing: Standby due to battery pack error or the surrounding temperature is out of the charging temperature range.
(charging begins when the temperature is within the charging temperature range)
Green: Charging the battery pack is complete.

Status of Indicator 2 on DT-X8:

- Blue Flashing: Operating via Bluetooth®.
Orange Flashing: Operating via WLAN.
Magenta Flashing: Ready to communicate (when a USB connection is selected).

Important!

- Always make sure to first remove the Handheld Terminal from the Ethernet Cradle when switching the selector switch.
- Allowing the power supply terminals become wet can cause an electric shock or fire. In addition, if the terminals become soiled, contact may be impaired resulting in poor charging. For reasons of safety and maintaining charging battery pack(s) in optimum condition, clean the power supply terminals by wiping with a dry cloth or cotton swab after disconnecting the AC adaptor.
- Never short out the power supply terminals of the Ethernet Cradle. This can damage the Ethernet Cradle.
- Do not subject the Handheld Terminal and Ethernet Cradle to vibration or impact during communication. This can cause communication to be interrupted.
- When mounting the DT-X8, securely attach to the mount hooks of the Ethernet Cradle and make sure that the power LED at the front of the Ethernet Cradle is lit in green. Charging and communication will not proceed properly if the DT-X8 is not mounted properly.
- Always cap ports that are not being used. Using the Ethernet Cradle while the ports are uncapped can cause damage.
- If the hand strap is attached to the terminal, take care not to trap it when mounting the DT-X8. Pull the hand strap out as shown in the illustration. If you are having difficulties mounting the DT-X8, attach the hand strap using the strap hole on the top of the terminal.

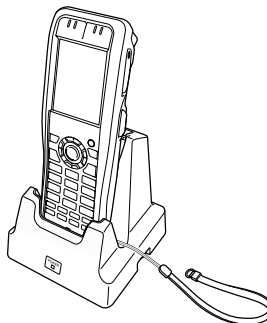

Specifications

1. LAN Specifications

Communications protocol: IEEE 802.3
Media type: 10base-T/100base-TX auto-switched

2. USB

Protocol: USB Ver1.1 Standard
Transmission Rate: 12Mbps (max.)

3. Charging

Charging Method: Constant current/voltage (the charging circuit is built in DT-X8)
Charge Period: Approximately 4 hours

4. Power Supply

Power Source: AC adaptor (AD-S42120B/AD-S42120C)
Consumption Current: 12V DC approximately 2.0A
Output to Handheld Terminal: 5V DC 3.0A (max.)
USB Host Output: 5V DC 0.5A (max.)

5. AC Adaptor

Model: AD-S42120B/AD-S42120C
Input: 100V to 240V AC 50/60Hz
Output: 12V DC 3.5A

6. Dimensions and Weight

Dimensions: Approximately 110(W) × 111(D) × 126(H) mm
(4⁵/₁₆"W × 4³/₈"D × 4¹⁵/₁₆"H)
Weight: Approximately 325g (11.5oz)

7. Operating Environment

Temperature: 0°C to 40°C (32°F to 104°F)
Humidity: 10% to 90% RH (non-condensation)

The AD-S42120 series comes available in the following models depending on area or region where you are in.

Model no. of AC Adaptor	Area/Region	Compliance
AD-S42120B	All except China	Compliant with CE, UL, FCC, and Energy Efficiency Standards.
AD-S42120C	China only	Compliant with Energy Efficiency Standards and CCC.

Using the Cradle-type Dual Battery Charger (HA-K36DCHG)

The optional Cradle-type Dual Battery Charger (HA-K36DCHG) can concurrently charge two battery packs installed in the respective DT-X8s.

General Guide

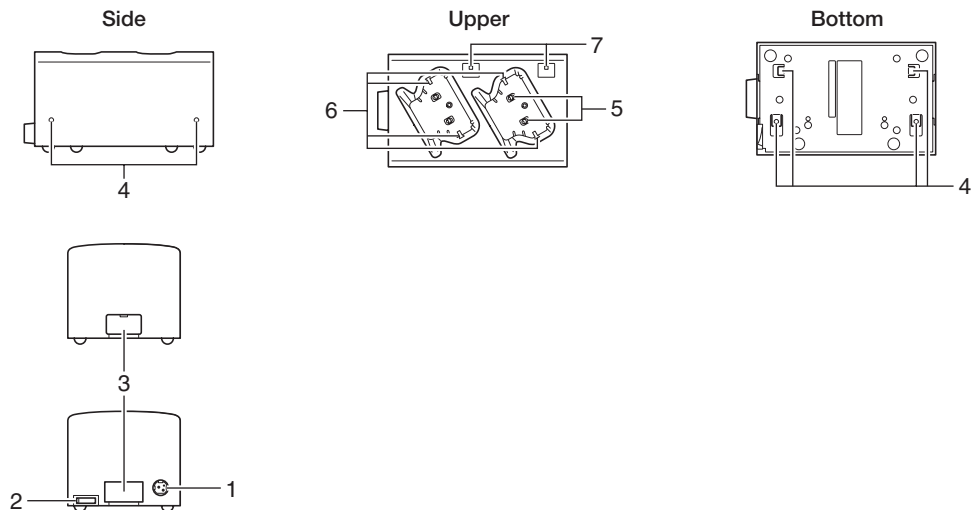

Bundled Items

Use these bundled items to join multiple chargers together.

Bottom bracket

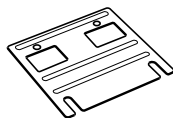

Side bracket

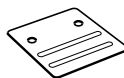

Screws (for brackets)
Two each for one bracket



1	AC Adaptor Jack	Connect the AC adaptor (sold separately) here.
2	Power Switch	Turns the power on and off.
3	Connectors	Use these connectors to connect multiple Cradle-type Dual Battery Chargers to each other.
4	Screw Holes for Brackets	The connection bracket attaches here when you connect multiple Cradle-type Dual Battery Chargers to each other.
5	Power Contacts	Power is supplied to the DT-X8 via these contacts.
6	Mount Hooks	These hooks are used to stabilize the Handheld Terminal when mounting it on the Cradle-type Dual Battery Charger.
7	Power LEDs	These LEDs indicate the power status and the mounting status of the DT-X8. Off: Power off Green: Power on, DT-X8 mounted correctly Red: Power on, DT-X8 not mounted

Charging Battery Pack

Use the optional AC adaptor (AD-S90190C) to supply power to the charger.

1. Plug the connector from the AC adaptor into the AC adaptor jack on the dual battery charger with the engraved side of the connector facing upwards. Push the connector firmly into the jack until it clicks into place.

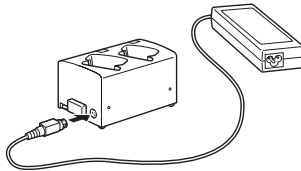

2. After connecting the power cable to the AC adaptor, plug the other end of it into an AC outlet.

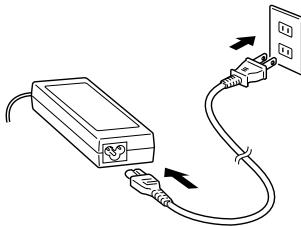

3. Turn on the power switch on the side of the charger. The power LEDs on the top of the charger light red.

-
4. Place DT-X8 in the charger as illustrated so that the terminals on the bottom of the DT-X8 make contact with the power contacts of the charger. Take care not to trap objects such as the hand strap in the charger.

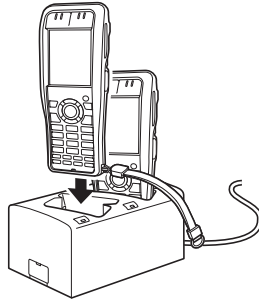

The power LEDs on the top of the charger light green and indicator 1 lights orange.

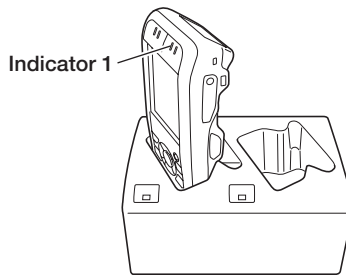

Status of Indicator 1 on DT-X8:

Orange: Charging the battery pack.

Red Flashing: Standby due to battery pack error or the surrounding temperature is out of the charging temperature range.
(charging begins when the temperature is within the charging temperature range)

Green: Charging the battery pack is complete.

Important!

- Water or moisture on the power contacts can cause a short-circuit and/or fire. Soil on the power contacts will deteriorate the conduction causing poor charge performance. When cleaning the power contacts, unplug the AC adaptor from the charger as safety precaution and wipe off soil on the power contacts with a dry and soft cloth or with cotton swab.
- Do not unplug the AC adaptor from the charger while charging battery packs continues.
- When disconnecting the AC adaptor, pull it out by gripping the plug, not by pulling on the cord.
- Turn off the power on DT-X8 before placing it in the charger.
- If the Indicator 1 on DT-X8 starts blinking, unplug the AC adaptor from the AC outlet and then plug in it back.
- When placing the DT-X8 into the charger, take care not to trap the pen cord or hand strap in the charger. Pull the hand strap out as shown in the illustration.
- If you are having difficulties mounting the DT-X8, attach the hand strap using the strap hole on the top of the terminal.

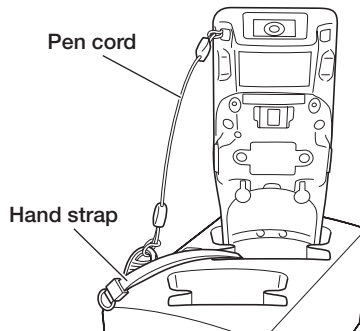

- * Pull the hand strap out from the left mount hole if it is attached to the left side of the terminal, and from the right mount hole if it is attached to the right side of the terminal.

Connecting Multiple Cradle-type Dual Battery Chargers

You can connect up to three Cradle-type Dual Battery Chargers. Doing so makes it possible to supply power to all the Cradle-type Dual Battery Chargers using one dedicated AC adaptor.

1. As shown in the illustrations below, remove the connector covers of the Cradle-type Dual Battery Chargers you want to connect to each other.

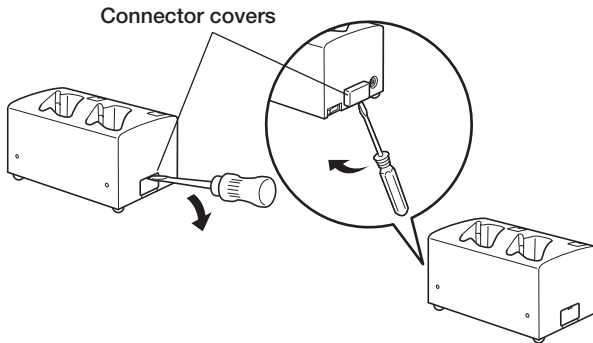

2. Connect the two Cradle-type Dual Battery Chargers as shown below.

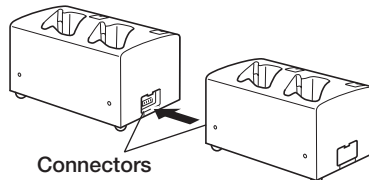

3. Fix the side and bottom brackets in place with two screws on each bracket.

You can repeat the above steps to connect up to 3 Cradle-type Dual Battery Chargers.

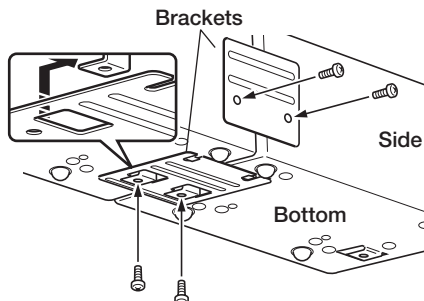

Important!

- Each unit of the charger comes with one piece each of the side and bottom brackets. After you join two chargers together using these two brackets, one side bracket and one bottom bracket will be left over. Keep these as spare for use in future.
- Always disconnect the AC adaptor before joining multiple chargers together.

Specifications

Charge period:	Approximately 4 hours
Power source:	AD-S90190C
Rated input:	DC19V 4.74A
Operating temperature:	0°C to 40°C (32°F to 104°F)
Operating humidity:	30% to 80%RH
Dimensions:	Approximately 159(W) × 100(D) × 85(H)mm (6 ¹ / ₄ "W × 3 ¹⁵ / ₁₆ "D × 3 ³ / ₈ "H)
Weight:	Approximately 495g (17.5oz)

Using the USB and Charging Unit (HA-K65US)

The optional USB and Charging Unit (HA-K65US) makes it possible to transmit system data and file data between the Handheld Terminal and a PC via a USB connection (download or upload). You can also use the USB and Charging Unit to charge the battery pack installed in the Handheld Terminal.

General Guide

Top

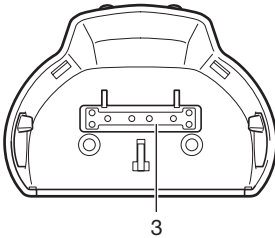

Bottom

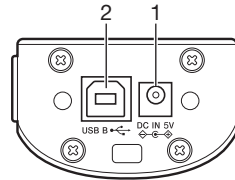

Left

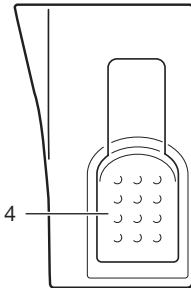

Right

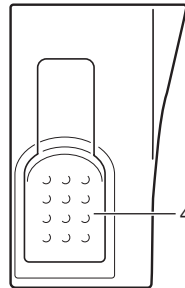

1	AC Adaptor Jack	This port is used to transmit system data and file data (download, upload) by connecting the USB and Charging Unit to a PC using a USB cable (DT-380USB-A). A dedicated driver must be installed in the PC before connecting the USB and Charging Unit to the PC.
2	USB Client Port	Connect the AC adaptor (sold separately) here.
3	Power Supply/Data Communication Terminal	Power is supplied to the DT-X8 via these contacts. Also used for data communication.
4	Stoppers	Secures the DT-X8.

Mount and use the USB and Charging Unit as described in the procedure below.

Mounting the USB and Charging Unit

1. Fit the USB and Charging Unit onto the bottom of the terminal as shown in the illustration.

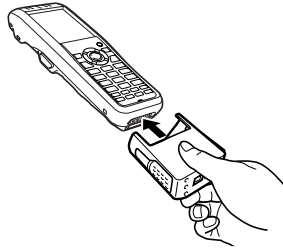

2. After mounting the unit onto the terminal, check that it is firmly locked in place using the stoppers.



Important!

- The USB and Charging Unit can only be mounted on the terminal in one direction. Do not use excessive force to attempt to push the terminal into the unit when it is facing the wrong way.
- Water or other liquids on the power supply/data communication terminals on the USB and Charging Unit or terminal can lead to an electric shock or fire. Note also that soiling on the terminals will impair the connection, leading to reduced charging functionality. As a safety precaution, disconnect the AC adaptor and USB cable before cleaning the power supply terminals with a dry cloth or cotton bud.
- If there is condensation or other moisture on the terminal, wipe it off thoroughly with a dry cloth.
- Never short-circuit the power supply/data communication terminals on the USB and Charging Unit or terminal as this could cause a fault.
- When mounting the USB and Charging Unit on the DT-X8, attach the hand strap to the top of the terminal.

Removing the USB and Charging Unit

1. Unlock the stoppers on the left and right sides of the USB and Charging Unit by pressing them inwards, as shown in the illustration.

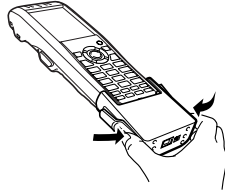

2. Keeping the stoppers pressed in, pull the USB and Charging Unit off the terminal.

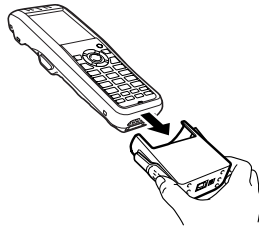

Connecting to a Computer

Connect to a computer using the USB and Charging Unit with the USB cable (DT-380USB-A).

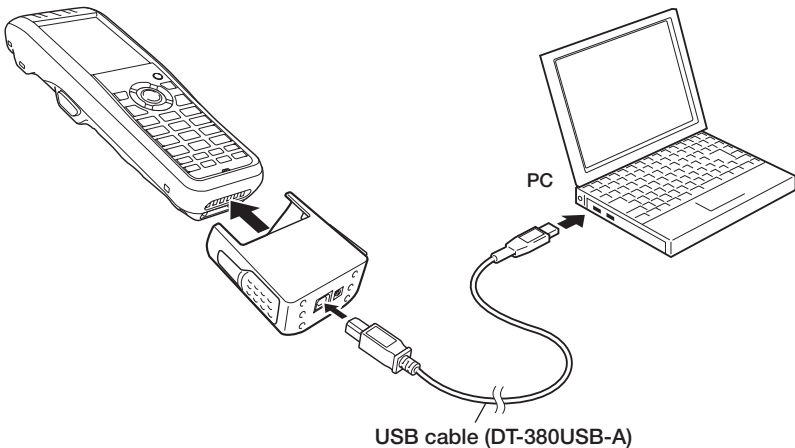

Charging the Battery Pack

The battery pack installed in the DT-X8 can be charged using the USB and Charging Unit with the optional AC adaptor (AD-S15050B). An indicator on the DT-X8 shows the level of charge.

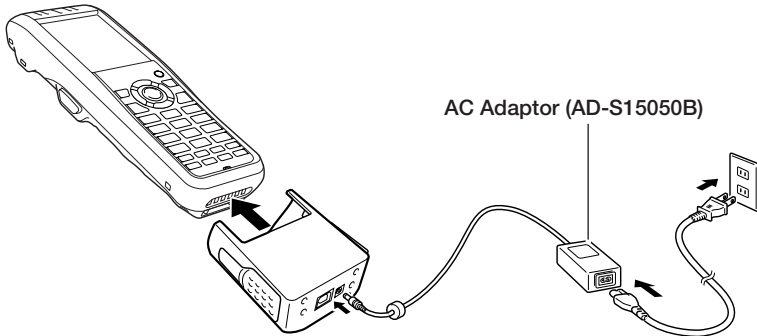

Status of Indicator 1 on DT-X8:

Orange: Charging

Red Flashing: Standby due to battery pack error or the surrounding temperature is out of the charging temperature range
(charging begins when the temperature is within the charging temperature range)

Green: Charging complete

Specifications

Charging:

Charging Method: Constant current/voltage
Charge Period: Approximately 4 hours (AD-S15050B)
Approximately 8 hours (USB-computer connection)

Power Supply:

Power Source: AC Adaptor (AD-S15050B*)
Consumption Current: 5V DC approximately 3.0A
Output to
Handheld Terminal: 5V DC 3.0A (max.)

AC Adaptor

Model: AD-S15050B
Input: 100V to 240V AC 50/60Hz 0.36 to 0.2A
Output: 5V DC 3.0A

Dimensions and Weight

Dimensions: Approximately 64(W) × 45(D) × 66(H) mm
(2¹/₂"W × 1³/₄"D × 2⁵/₈"H)
Weight: Approximately 57g (2oz)

Operating Environment

Temperature: 0°C to 40°C (32°F to 104°F)
Humidity: 10% to 90% RH (non-condensation)

*See page 49

Using the Dual Battery Charger (HA-F32DCHG)

The optionally available Dual Battery Charger (HA-F32DCHG) can be used to simultaneously charge two battery packs.

General Guide

Left

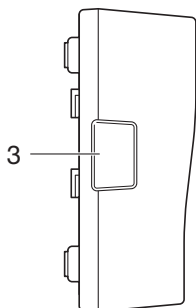

Top

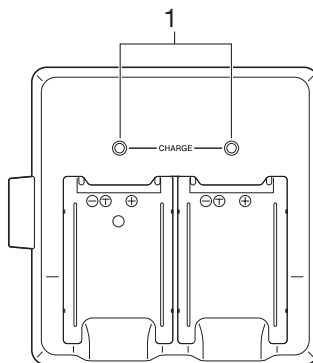

Right

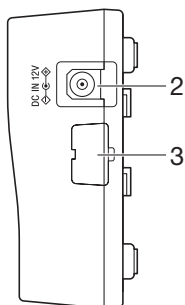

Bottom

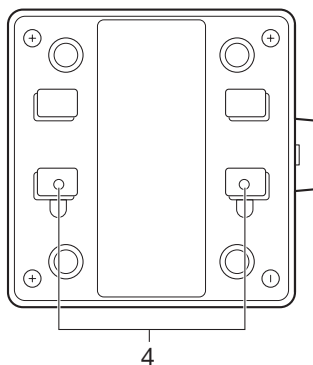

Front

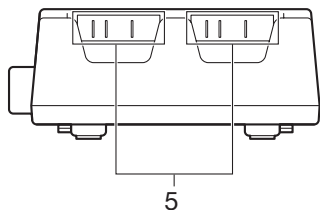

1	Charge Indicator LED
2	AC Adaptor Jack
3	Dual Battery Charger Connection Port
4	Connection Bracket Attachment Holes
5	Power Supply Terminals

Charging Battery Pack

Use the separately sold AC adaptor (AD-S42120B/AD-S42120C) for the power supply of the Dual Battery Charger.

1. Plug the cord from the AC adaptor into the AC adaptor jack of the Dual Battery Charger.
2. Plug the AC cord into a wall outlet.

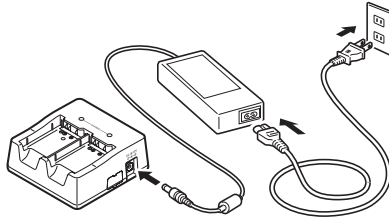

3. Taking care that the battery pack is oriented correctly, insert it into the Dual Battery Charger.
This causes the Charge Indicator LED to light in red, indicating that charging has started.

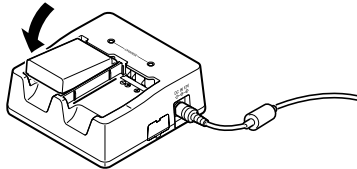

Status of Charge Indicator LED

- Off: Not charging the battery pack.
- Red: Charging the battery pack.
- Red Flashing: Battery pack problem
- Green: Charging the battery pack is complete.
- Green Flashing: Standby due to the surrounding temperature being beyond the specified temperature range (approximately 0°- 40°C). (charging resumes when the temperature reaches the range)

Connecting Multiple Dual Battery Chargers

You can connect up to three Dual Battery Chargers. Doing so makes it possible to supply power to all the Dual Battery Chargers using one dedicated AC adaptor.

1. As shown in the illustrations below, remove the connector covers of the Dual Battery Chargers you want to connect to each other.

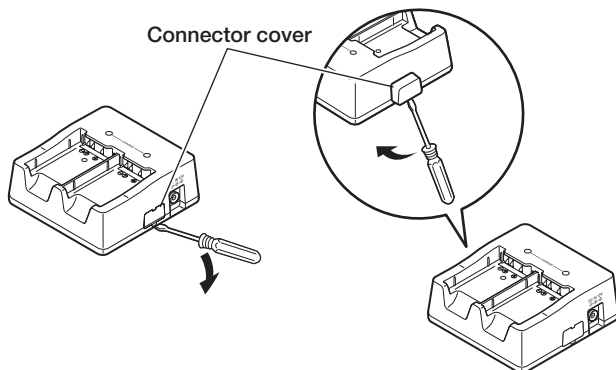

2. Connect the two Dual Battery Chargers as shown below.

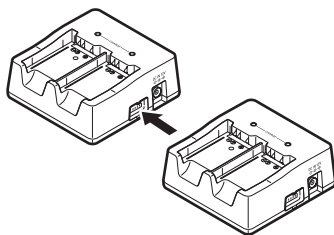

3. Turn over the connected Dual Battery Chargers and attach a connection bracket, securing it in place with screws.

You can repeat the above steps to connect up to 3 Dual Battery Chargers.

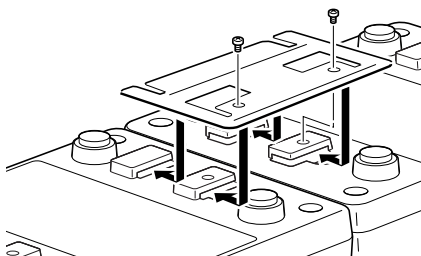

Specifications

1. Charging Specification

Charging Method:	Constant current/voltage
Charge Period:	Approx. 4.5 hours (1 battery pack, normal temperature) When charging two battery packs: Approx. 5 hours (2 battery packs, normal temperature)

2. Power Supply

Power Source:	AC adaptor (AD-S42120B/AD-S42120C*)
Consumption Current:	12V DC 3.5A
Output:	4.2V DC 1.1A (max.)

3. AC Adaptor

Model:	AD-S42120B/AD-S42120C
Input:	100V to 240V AC 50/60Hz 1.2A
Output:	12V DC 3.5A

4. Dimensions and Weight

Dimensions:	Approximately 108(W) × 104(D) × 45(H) mm (4 ¹ / ₄ "W × 4 ¹ / ₈ "D × 1 ³ / ₄ "H)
Weight:	Approximately 152g (5.4oz)

5. Operating Environment

Temperature:	Approximately 0°C to 40°C (32°F to 104°F)
Humidity:	30% to 80% RH (non-condensation)

*See page 55

Using Rechargeable Battery Pack

HA-K23XLBAT

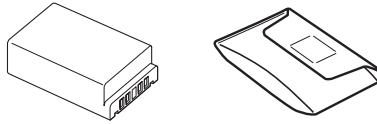

Important!

- Store a battery pack in its special soft case whenever you are not using it.
- If the battery pack has been left over unused for a long period of time, the capacity remained decreases due to spontaneous discharge or chemical decomposition by the battery pack itself. If the battery pack fails to hold its operating duration after it has been fully charged, replace it with a new one. The battery pack may reach the end of its service life.

Battery Pack Specifications

Model:	HA-K23XLBAT
Rated Capacity:	2860mAh (6.84 Wh)
Rated Voltage:	3.7V
Dimensions:	Approximately 36.15(W) × 55.40(D) × 18.10(H) mm (1 ⁷ / ₁₆ "W × 2 ³ / ₁₆ "D × 1 ¹ / ₁₆ "H)
Weight:	Approximately 65g (2.3oz)
Bundled Item:	Soft case

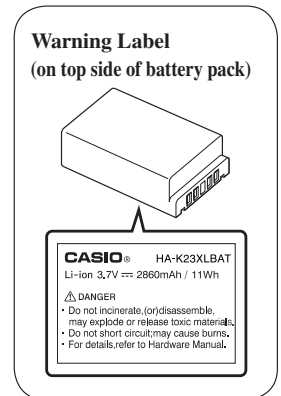

CASIO®

CASIO COMPUTER CO., LTD.

6-2, Hon-machi 1-chome
Shibuya-ku, Tokyo 151-8543, Japan

Free Manuals Download Website

<http://myh66.com>

<http://usermanuals.us>

<http://www.somanuals.com>

<http://www.4manuals.cc>

<http://www.manual-lib.com>

<http://www.404manual.com>

<http://www.luxmanual.com>

<http://aubethermostatmanual.com>

Golf course search by state

<http://golfingnear.com>

Email search by domain

<http://emailbydomain.com>

Auto manuals search

<http://auto.somanuals.com>

TV manuals search

<http://tv.somanuals.com>