



Supported Equipment Manual

For the DT-800RF Device Manufactured by Casio

Copyright © 1996 - 2006 by Connect, Inc.

All rights reserved. This document may not be reproduced in full or in part, in any form, without prior written permission of Connect Inc., 1701 Quincy Avenue, Suites 5 & 6, Naperville, IL 60540.

Connect, Inc. makes no representation or warranties with respect to the contents of this document and specifically disclaims any implied warranties of merchantability or fitness for any particular purpose. Further, Connect, Inc. reserves the right to revise this publication and to make changes to it from time to time without obligation to notify any person or organization of such revision or changes.

Trademarks

PowerNet OpenAir™, OpenAir Linux™, OpenAir Windows™, OpenAir 400™, PowerNet Twin Client™, and PowerNet AirLinc™ are trademarks of Connect, Inc.

Other product names mentioned in this manual may be trademarks or registered trademarks of their respective companies and are hereby acknowledged.

Production

This manual was written, edited, and produced by:

Connect, Inc.
1701 Quincy Avenue,
Suites 5 & 6
Naperville, IL 60540
www.connectrf.com

Printed in the U.S.A.

Please let us know about any errors in this document at:

<http://207.241.78.223/isoexpert/calltrak.nsf/WebTracking?OpenForm>

Table of Contents

Chapter 1 • Introduction.....	1-1
Description.....	1-1
Picture.....	1-2
Setup Requirements.....	1-2
Accessories.....	1-2
Operating System.....	1-4
Chapter 2 • Terminal Setup.....	2-1
Running Setup from a Download File	2-1
Installation.....	2-2
Running the Manager.....	2-4
Quick Start.....	2-5
Configuring the Manager	2-5
Configuring the Terminal for Download	2-9
Terminal Settings	2-10
Starting a Telnet Session	2-11
Standard Setup.....	2-12
Setup Using Twin Client Manager	2-12
Terminal Setup Using Twin Client Menus	2-18
Authorizing PowerNet.....	2-20
Software Management.....	2-22
Auto-Configuration	2-22
Chapter 3 • Keypad Configuration	3-1
Keypad Figures.....	3-1
Keypad Table.....	3-4
Chapter 4 • Error Message Resolution Guide	4-1

This page is intentionally blank.

Chapter 1 • Introduction

Description

The DT-800RF has a versatile high-speed scanning (100 scans per second) that ensures a rapid first-time read rate and high data integrity. Its combination of distance and contact laser scanning allows bar codes to be easily read even when badly printed on curved and irregular surfaces. Amongst the lightest weight terminals in its class, the compact lightweight design of the DT-800RF reduces operator fatigue over extended usage periods. Its backlit display can be illuminated, enabling readings to be clearly seen in the darkest of work environments.

This terminal has a world-class water splash proof (IPX II standard) that provides continuous operations, even in the rain. Using the latest multi-drop communications technology, data can be collected at many different networked points connected to a single PC. Low-power circuitry and an automatic power-off feature conserve battery life to the maximum and provide more usage time before replacement. A rechargeable battery reduces the need to dispose of dead batteries and helps to conserve the environment.

The DT-800RF's 160 x 160-dot screen displays extensive lines of information. This touch screen can also be used for entering data quickly and easily. You may choose between 2.6 or 10 Mbytes of memory to meet your specific requirements. Control functions (such as "Help" or "Send") can be assigned to the DT-800RF special function keys to further enhance operation.

Master I/O boxes, including SCSI or Ethernet connection, allow the configuration of a large-scale system with satellite I/O boxes for high speed, large volume data transfer. The DT-800RF can be set to read all common bar code symbologies with a narrow bar width as small as 0.125mm. Infrared communications on this terminal allow data to be downloaded or uploaded without the need to connect any cables, thus ensuring trouble-free connection to a host system.

For more information, contact www.casio.com.

Picture



Setup Requirements

Installation of PowerNet Twin Client requires, at a minimum, the following:

- A Pentium-class processor
- 32 MB of RAM
- 10 MB of free hard disk space available
- Microsoft Windows 95, 98, ME, XP, or NT/2000 operating system

Accessories

The following accessories are available for the DT-800RF:

I/O Box

- DT-860IOE (satellite I/O box)
- DT-865IOE (master I/O box)

Charger (Single-Pack)

- DT-820CHGE (Quick charger)

Lithium Ion Battery Pack

- DT-823LI

AC Adaptors

- DT-9020ADPG (AC adaptor (230V) for DT-820CHGE)
- DT-9020ADPU (AC adaptor (120V) for DT-820CHGE)
- DT-825ADP-G (AC adaptor (230V) for I/O boxes)
- DT-825ADP-U (AC adaptor (120V) for I/O boxes)

Cables

- DT-881RSC-E: RS232C Modem cable
- DT-882RSC-E: RS232C Cross cable
(between DT860IO-E and PC: 25pin male)
- DT-883RSC-E: RS232C Cross cable
(between DT860IO-E and PC: 25pin female)
- DT-887AX: RS232C Cross cable
(between DT860IO-E and PC: 9pin female)
- DT-888RSC: Modular Cable
- DT-889AX: Cable (between DT-800RF and PC)
- SB-751HF: SCSI cable
(between DT865IO-E and PC: Centro 50pin full male)
- SB-752HH: SCSI cable
(between DT865IO-E and PC: Centro 50pin half male)
- SB-753HP: SCSI cable
(between DT865IO-E and PC: Pin type half 50pin male)

Operating System

Version of the Operating System

The version of the operating system on a DT-800RF terminal is 2.00.

Finding the Version of the Operating System

The version of operating system will appear on a terminal screen when the terminal is rebooted. For rebooting instructions, see *Command Mode Boot* in the *Quick Start* section.

Chapter 2 • Terminal Setup

Running Setup from a Download File

The downloaded file is a compressed archive. After extraction using a utility such as *WinZip* or *PKWARE*, folders are created on the hard disk as shown in the following figure.

Name	Size	Type
disk1		File Folder
disk2		File Folder
disk3		File Folder
disk4		File Folder

Click on the **Disk1** folder to view the files as shown in the following figure.

Name	Size	Type
inst32i.ex	292KB	EX_ File
_ISDel.exe	27KB	Application
_Setup.dll	34KB	Application Extension
_sys1.cab	172KB	WinZip File
_sys1.hdr	4KB	HDR File
_user1.cab	1KB	WinZip File
_user1.hdr	5KB	HDR File
Data.tag	1KB	TAG File
data1.cab	3,501KB	WinZip File
data1.hdr	13KB	HDR File
lang.dat	5KB	DAT File
layout.bin	1KB	BIN File
os.dat	1KB	DAT File
setup.bmp	185KB	Bitmap Image
Setup.exe	70KB	Application
Setup.ini	1KB	Configuration Settings
setup.ins	58KB	Internet Communication
setup.lid	1KB	LID File

Click on the **Setup** application and proceed to the following section entitled *Installation* for further instructions.

Installation

The InstallShield wizard runs and presents the following screen.

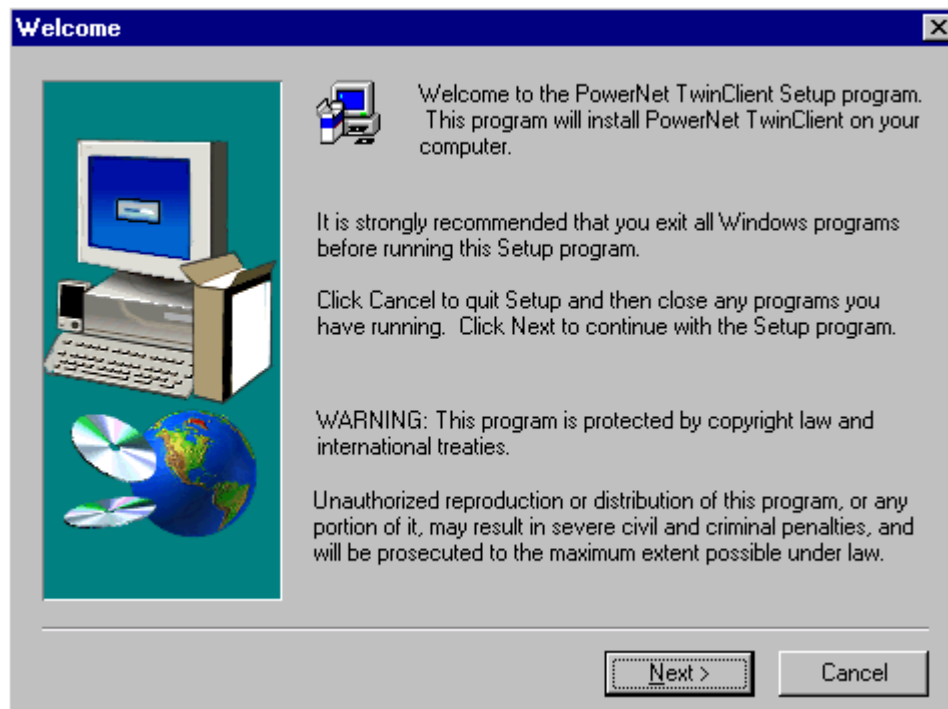

Click on **N**ext to begin the installation process.

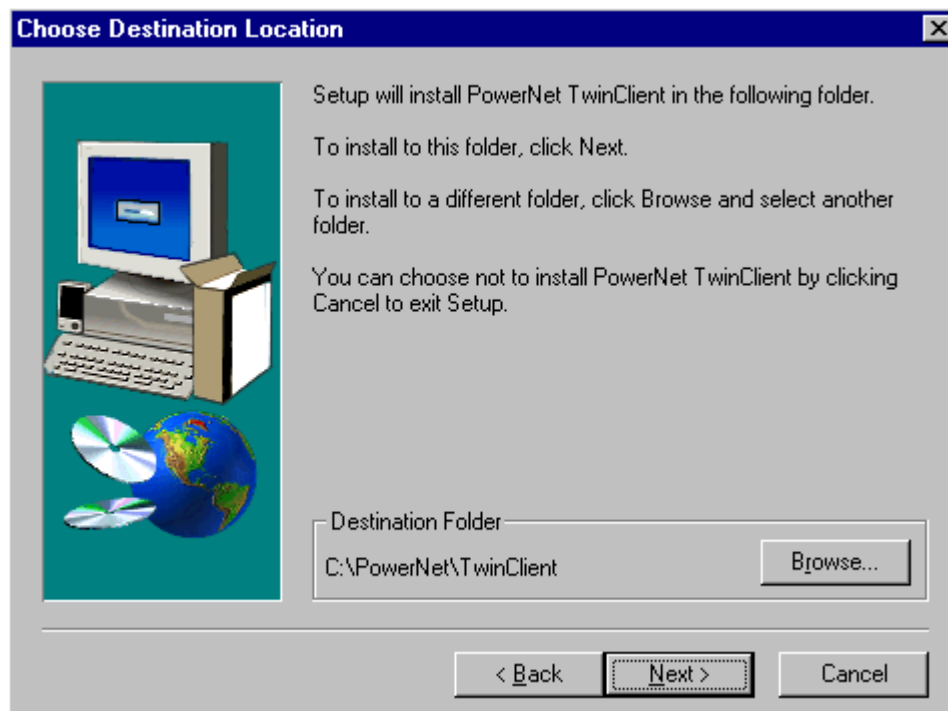

To change the default Destination Location, click on **Browse** and select a location. Then click on **Next**.

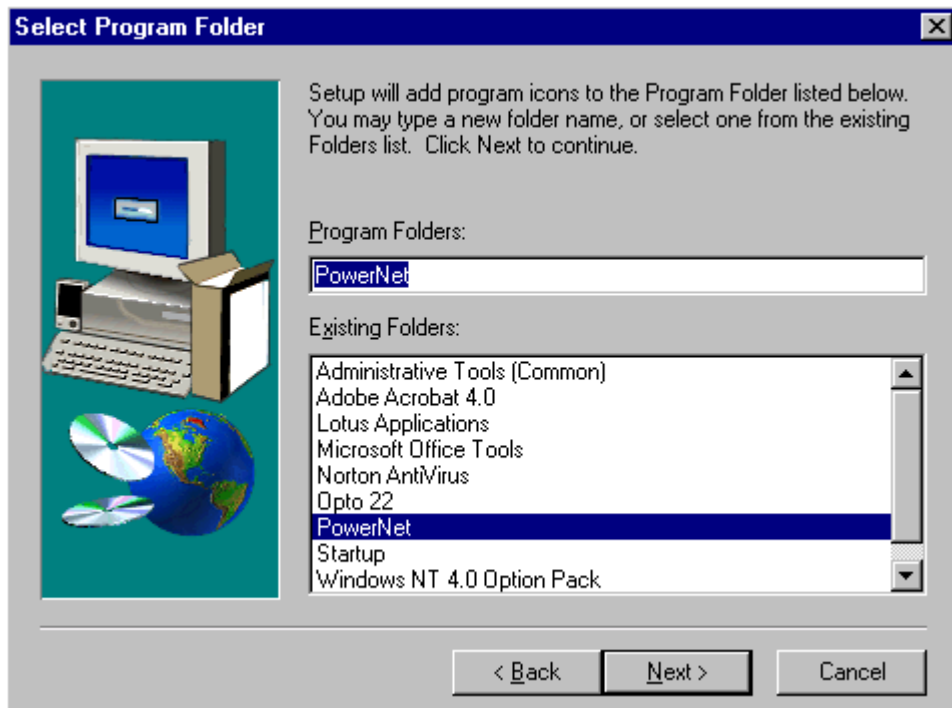

The default folder is **PowerNet**. This default may be changed either by selecting an existing program group or by typing in a new name at the prompt. Then click on **Next**.

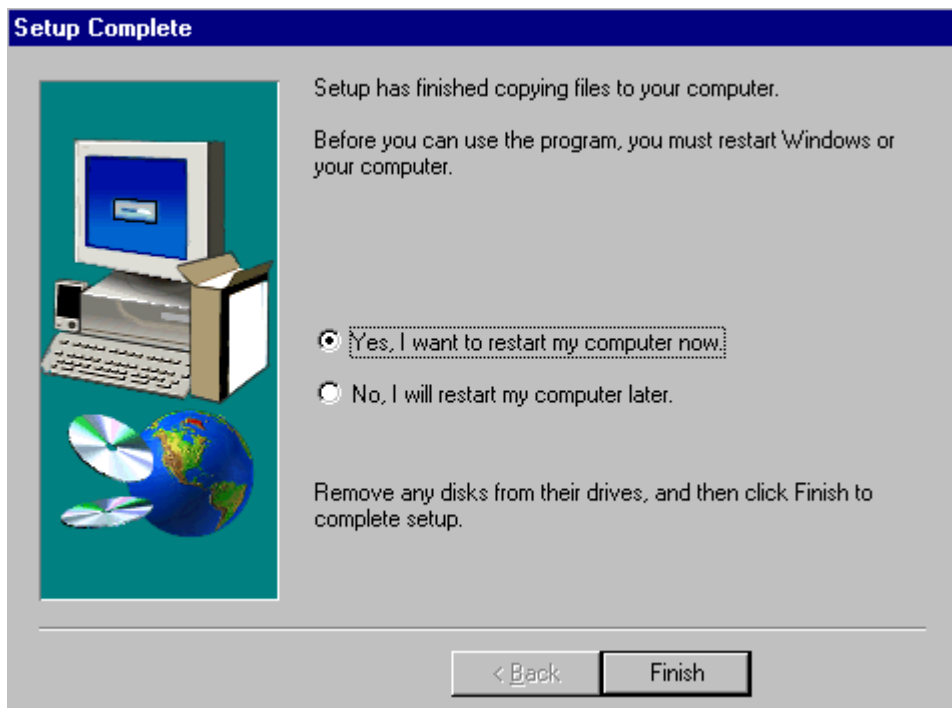

When the installation is complete, reboot the system to initialize the Twin Client software.

- a. To reboot the system immediately, click on **Finish**.
- b. To reboot later, click on the option to restart the computer later, and click on **Finish**.

Running the Manager

The PowerNet Twin Client Manager is the utility that manages the terminal software and configurations.

Select **Start**, **Programs**, **PowerNet**, and **Twin Client Manager**. The PowerNet Twin Client Manager screen appears as shown in the following figure. This is the administrator's main screen, and all functions are accessed from its menu bar, tool bar, and tabs.





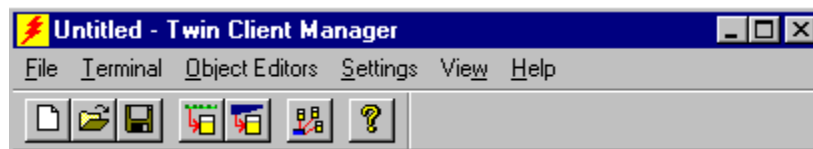

Menu Bar

The menu bar provides access to the functions used to configure the terminals and manage their software.



Toolbar

Under the menu bar, the tool bar provides shortcuts to major features. The toolbar can be turned on or off by changing the Toolbar parameter found on the **View** menu. The shortcuts available from the toolbar are as follows:

-  Create a new terminal configuration.
-  Open an existing terminal configuration.
-  Save the current terminal configuration.
-  Download the configuration to terminal.
-  Download software to terminal.
-  Configure terminals automatically over the wireless network.
-  View PowerNet Twin Client Manager version.

The PowerNet Twin Client Manager is now successfully installed and ready for use. The *Quick Start* section below provides detailed instructions for quickly configuring the terminal and starting a telnet session.

Quick Start

Quick Start describes how to prepare the Twin Client Manager and the Casio terminal for a Telnet session with the host. Following an initial serial download, the terminal software and configuration is managed automatically, over the wireless network.

Configuring the Manager

The first step is to configure the Twin Client Manager to meet site-specific requirements, and then prepare it for the automatic management of the terminal software and IP addresses. This simple procedure will require only a few minutes to complete.

Setting the Emulation

Click on **Start**, **Programs**, **PowerNet**, and **Twin Client Manager**. Select the **Settings** menu, as shown below.

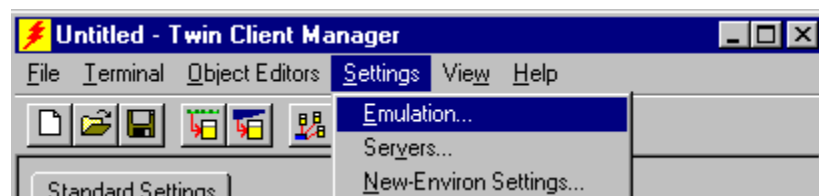

Click on **Emulation**, select the desired emulation, and click on **OK**.

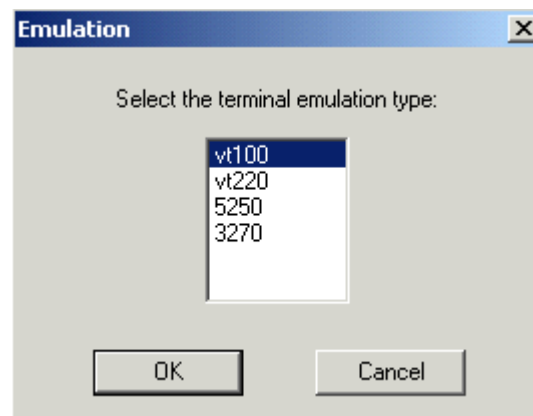

Setting the Servers

The Servers are the Telnet host systems the terminals will access.

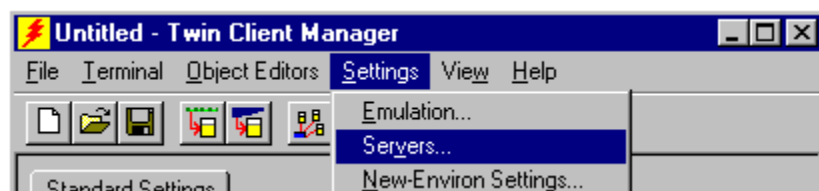

To set these addresses from the **Settings** menu, click on **Servers** and then click on **Add**. Enter the name of each server, its IP Address and IP port (normally 23 for Telnet servers), and emulation type. Then click on **OK**.

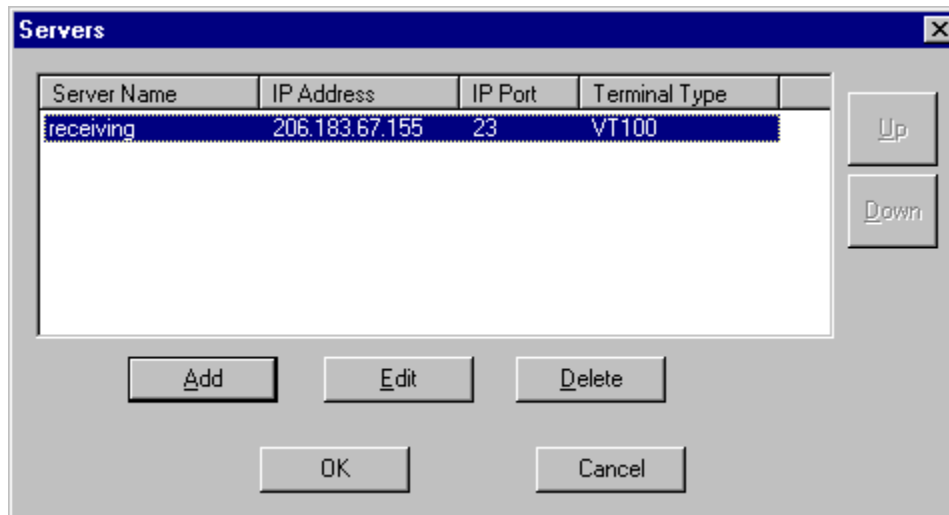

Repeat this step for each telnet server the terminals are required to access. If an error is made in the name, IP Address, IP Port number, or Terminal emulation type, click on the line that is in error and then click on the **Edit** button to make the corrections.

Setting Terminal Model and COM Port

The default terminal model is DT800, and the default serial connection to the Casio cradle is through COM1. To select a specific Casio terminal model and keypad, or to change the COM port assignment, click on the **Options** menu as shown.



The default terminal model, DT800, represents the default setup for all Casio terminals under PowerNet. To maintain compatibility with existing Casio Telnet client keyboard layouts, a specific terminal model and keypad must be selected from the Terminal Model window.

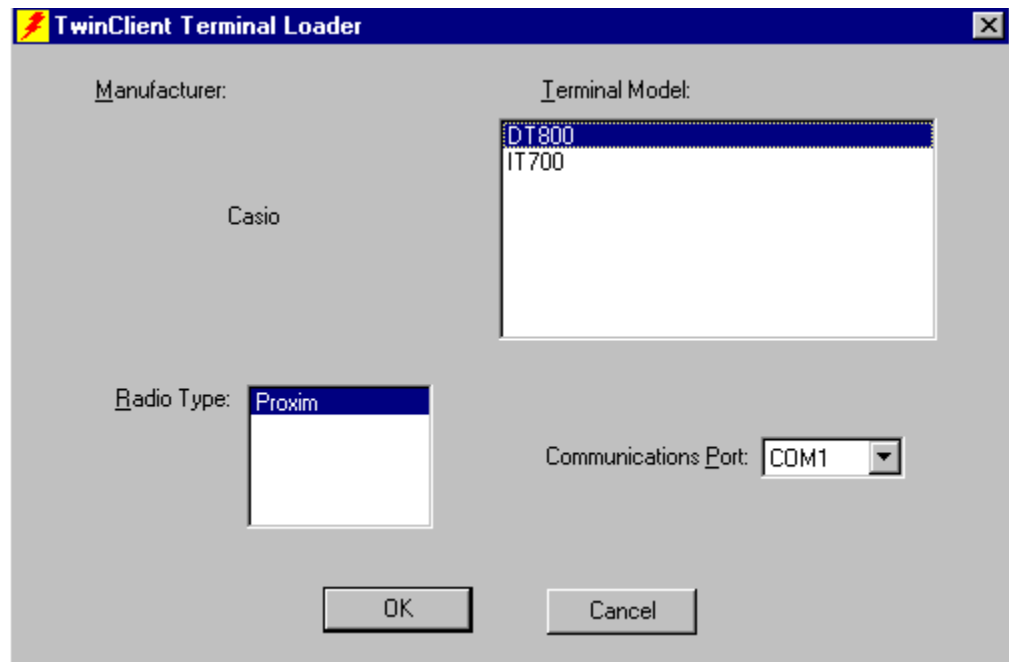

Saving the Configuration

Click **File** and **Save As**. Enter a name for this configuration.



For the purposes of this example, the name is vt100.

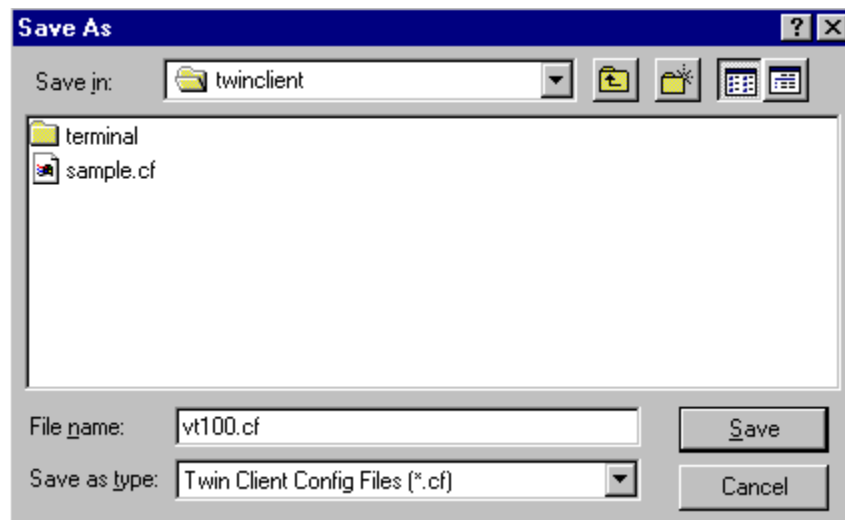

Download Files to Terminal

Select **T**erminal and **S**end **P**rogram **F**iles to **T**erminal from the menu bar.

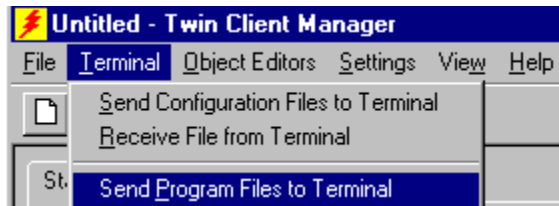

The program asks if you want to include configuration files.

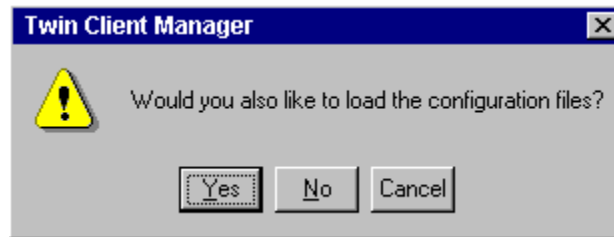

Select **Y**es.

The Casio Load Options screen appears telling you what actions to perform on the terminal. The first three of these instructions perform the terminal reboot. The remainder perform the actual download.

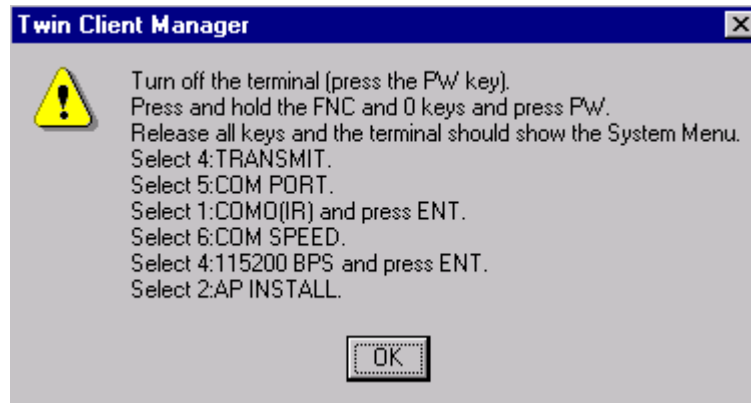

Click **O**K.

The Casio CD-ROM, distributed with Casio terminals, contains LMWIN2 in the directory \Tool\Dt800\LMWIN201. Copy the LMWIN2 utility into any directory on your PC. Next, install the PowerNet Twin Client software on the Casio terminal. To do this, connect the serial load cable from a serial port on the PC to the communications port of the terminal cradle or to a Casio terminal.

On the PC, the Download/Upload Utility screen is displayed. Note that this program is LMWIN.EXE, which is distributed separately.

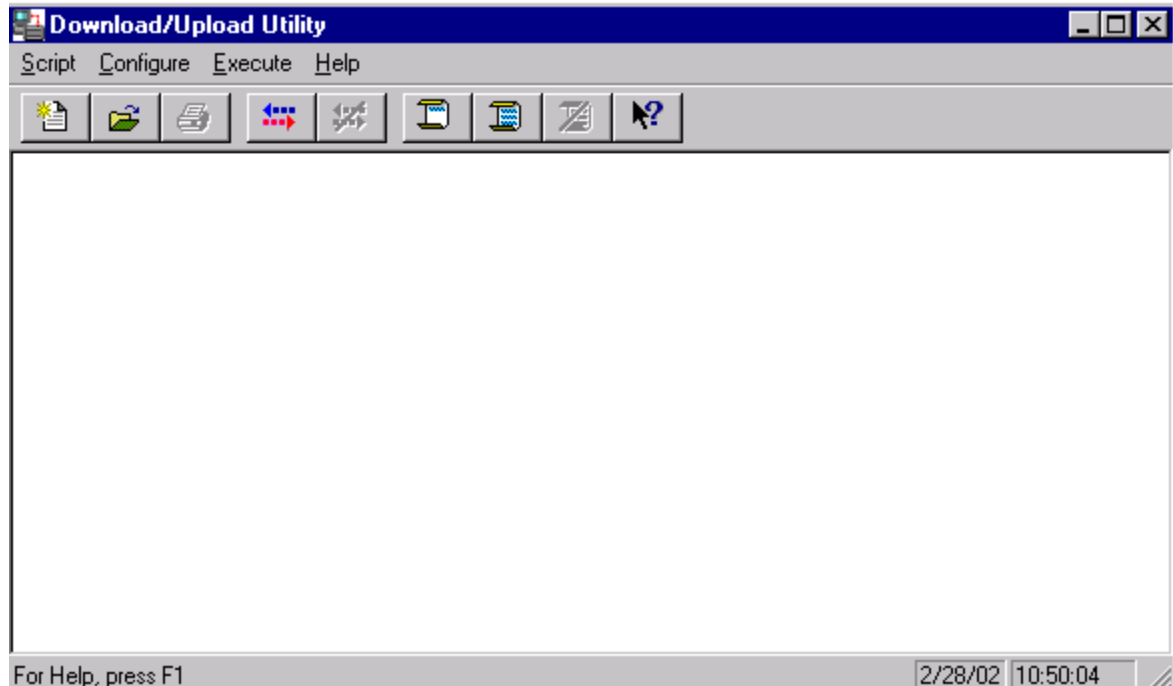

Select **Execute** from the menu bar, then select **Link Manager** and select **Start Link Manager**.

Note: A shortcut is to just click on the start  icon.

To stop the download, select **Execute** then **Link Manager Stop**, or press the **Stop** key, the fifth icon from the left under the Download/Upload Utility menu.

After the files are sent, close the Download/Upload Utility to return to the Twin Client Configuration Utility main screen and proceed.

The PowerNet Twin Client startup screen is displayed on the terminal as follows.

```
Twin Client
© 1991-2006 Connect,
Inc.
Keypress to Continue
```

Note: The date of 2006 is updated on the terminal at the time of a new release.

The terminal is now ready to establish a telnet session with the Host system.

Configuring the Terminal for Download

The terminal is prepared for the addition of Twin Client by booting to *command mode*, and setting the serial port parameters as described in this section. This simple procedure is described in the following sections, and requires only a few minutes to complete.

Connecting the Cradle

The terminal download requires a serial connection between the terminal and the PC through a cradle. Connect the serial load cable from a serial port on the PC to the communications port of the terminal cradle or to a Casio terminal.

In preparation for this download perform the following:

- Make sure you have copied the LMWIN utility to *any* directory on your PC.
- Connect the selected serial port on the PC to the cradle with a null modem cable. Use COM Port 1.
- Verify that the cradle is powered on.
- If you are using a cradle, configure the cradle baud rate to 115200.
- Set the dip switches on the bottom of the cradle. There are ten switches. The *up* position of a switch is the *on* position. The settings for the ten switches are shown below to set the cradle baud rate to 115200.

Switch	1	2	3	4	5	6	7	8	9	10
Setting	On	Off	Off	Off	On	Off	On	On	On	On

When using a cable, the baud rate to select is also 115200.

Terminal Settings

Command Mode Boot

On the portable terminal, power the terminal **OFF**, then boot the terminal using the key sequence as shown in the following table.

Command Mode Boot Sequences	
Following Power OFF	
Terminal Model & Keypad	Key Sequence
DT-800RF	Press the FNC and 0 keys, then press and release the PWR key, then release the FNC and 0 keys.

The System Menu is displayed.

SYSTEM MENU
1. EXECUTE AP
2. SET MODE
3. DATE/TIME
4. TRANSMIT
5. CALIBRATION
6. VERSION
7. SS UTILITY

1. Select **7: SS Utility** and then **1: Environment**.
2. Enter the IP Address, Netmask, Gateway, Domain, etc.

3. Press the **Clear** key.
4. Select **1: yes**.
5. Press the **Clear** key to return to the system menu.
6. Select **4: Transmit**, **4: Utility** and **4: Change memory size**.
7. Enter **640** and then press the **Enter** key.
8. Select **yes** to change the size.
9. Press the **Clear** key to return to the system menu.
10. Select **1: Execute AP**.
11. Select **Enter** for “yes” to execute the AP.

The terminal is now configured to accept a download from Twin Client Manager.

Starting a Telnet Session

At the Twin Client main menu on the terminal, press any key to establish the connection. Until the terminal has been authorized, the following screen is displayed.

```
RECOVERABLE ERROR
Terminal not
Authorized for
Twin Client

Keypress to Continue
```

It is not necessary to authorize the terminal at this time, so press any key to continue. The terminal will establish a connection with the host system and start emulation. If the terminal fails to connect to the host, refer to the following table for the possible causes and the related corrective actions.

Failure Cause	Corrective Action
Incorrect Host IP address	Correct the Host List address on the terminal. Refer to <i>Terminal Setup Using Twin Client Menus</i> under <i>Standard Setup</i> for instructions.
Incorrect netmask value	Access Radio Setup menu and correct the netmask value. Refer to <i>Terminal Setup Using Twin Client Menus</i> for instructions.

After a Telnet session has been successfully established, the terminal will remain in session for a maximum of 30 minutes at a time until it has been authorized. Once authorized, there is no software restriction on the session time. The instructions for authorizing the terminal are presented in *Authorizing PowerNet*.

Standard Setup

The default terminal setup is sufficient for most installations. However, to meet site-specific requirements, it may be necessary to customize terminal operation. The standard setup options simplify this process and can be modified using one of the following methods:

- Using the Twin Client Manager.
- Using the Twin Client terminal menu system.

Standard Setup describes how to use the Twin Client Manager and the terminal menu systems to set up the terminal. Also described are the methods for authorizing the terminal software.

Setup Using Twin Client Manager

The Twin Client Manager provides a **Standard Settings** tab for automatic setup of the terminals. The options within this tab vary according to the emulation selected, each of which is described below.

VT Settings

Select the VT emulation setup by clicking on the **S**ettings menu and then the **E**mulation menu, as shown below.



Then click on the **VT100** or **VT220** selection, as shown below.

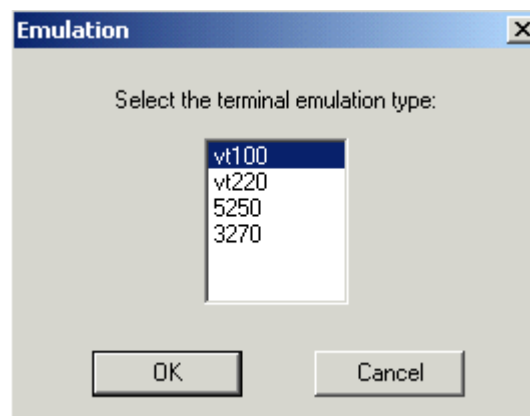

Click on **OK** after the selection is made, and return to the main Twin Client Manager menu. The standard settings tab will now reflect the settings for VT emulation.

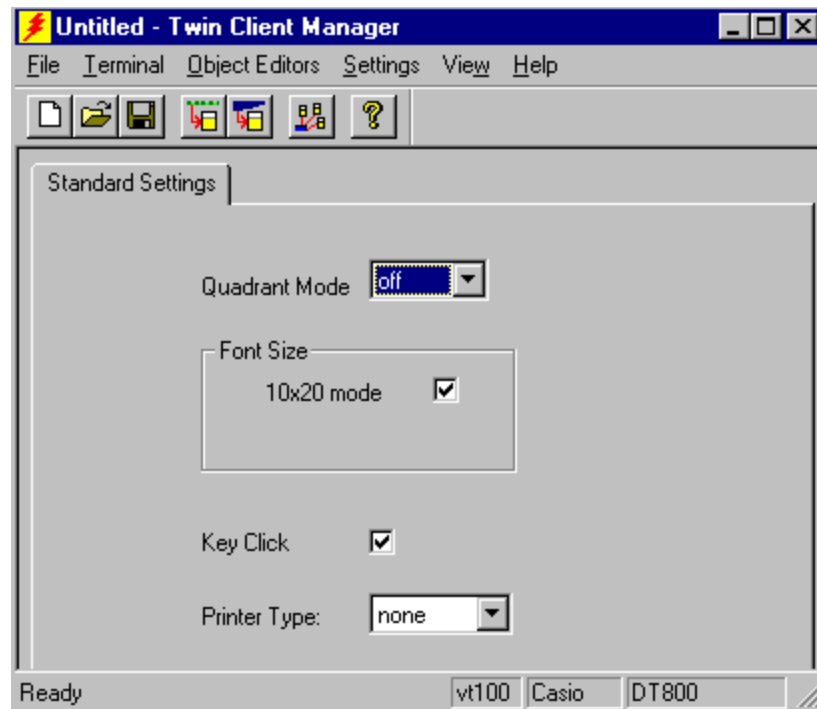

Quadrant Mode

The scrolling list defines the rules by which the terminal display is positioned in the larger host display. As defined by Twin Client, quadrants are fixed position “windows” in the host display, and the terminal display is located on whatever quadrant contains the current cursor position.

Off disables quadrant processing and Twin Client simply centers the current host input field in the terminal display.

On enables quadrant processing. However, input fields that cross quadrant boundaries result in a shift to the left in order to locate as much of the current input field on the terminal display.

Soft always positions on a quadrant boundary regardless of input field boundaries. Viewing keys are enabled.

Hard is the same as **Soft** except the viewing keys are disabled.

Lock locks the terminal display origin (upper left corner) to fixed row and column (x,y) coordinates in the host display. The coordinates are zero-based.

Font Size

This check box enables (checked) or disables (unchecked) the display of characters in 10x20 font.

Key Click

This check box enables (checked) or disables (unchecked) audible key clicks from the terminal. Default is on (checked).

Printer Type

This scrolling list selects the attached printer type. The default value is none, indicating no printer is attached.

5250 Settings

Select the **5250** emulation setup by clicking on the **S**ettings menu and then the **E**mulation menu, as shown below.

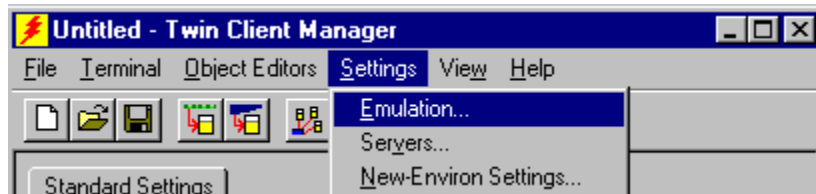

Then click on the 5250 selection, as shown below.

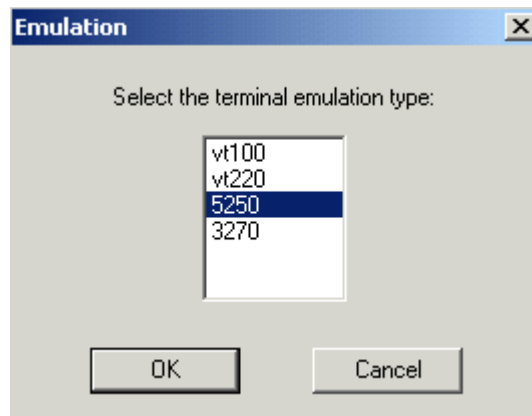

Click on **OK** after the selection is made, and return to the main Twin Client Manager menu. The standard settings tab will now reflect the settings for 5250 emulation.

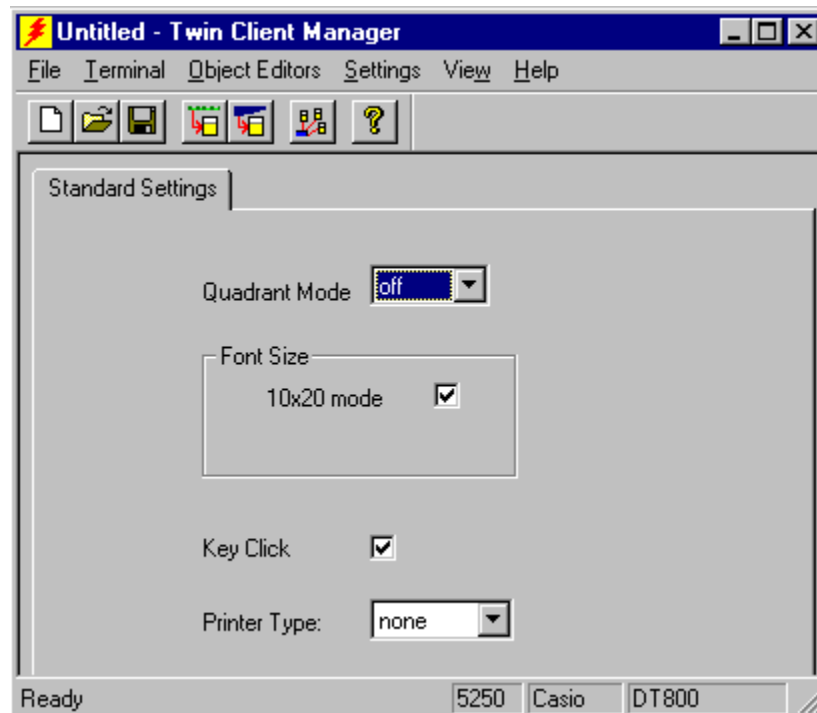

Quadrant Mode

The scrolling list defines the rules by which the terminal display is positioned in the larger host display. As defined by Twin Client, quadrants are fixed position “windows” in the host display, and the terminal display is located on whatever quadrant contains the current cursor position.

Off disables quadrant processing and Twin Client simply centers the current host input field in the terminal display.

On enables quadrant processing. However, input fields that cross quadrant boundaries result in a shift to the left in order to locate as much of the current input field on the terminal display.

Soft always positions on a quadrant boundary regardless of input field boundaries. Viewing keys are enabled.

Hard is the same as **Soft** except the viewing keys are disabled.

Lock locks the terminal display origin (upper left corner) to fixed row and column (x,y) coordinates in the host display. The coordinates are zero-based.

Font Size

This check box enables (checked) or disables (unchecked) the display of characters in 10x20 font.

Key Click

This check box enables (checked) or disables (unchecked) audible key clicks from the terminal. Default is on (checked).

Printer Type

This scrolling list selects the attached printer type. The default value is none, indicating no printer is attached.

3270 Settings

Select the **3270** emulation setup by clicking on the **Settings** menu and then the **Emulation** menu, as shown below.

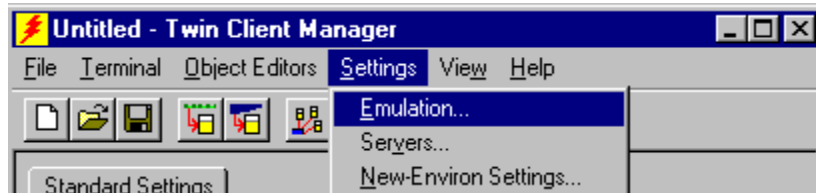

Then click on the 3270 selection, as shown below.

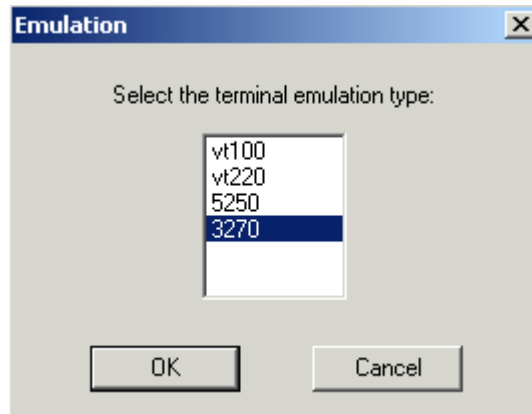

Click on **OK** after the selection is made, and return to the main Twin Client Manager menu. The standard settings tab will now reflect the settings for 3270 emulation.

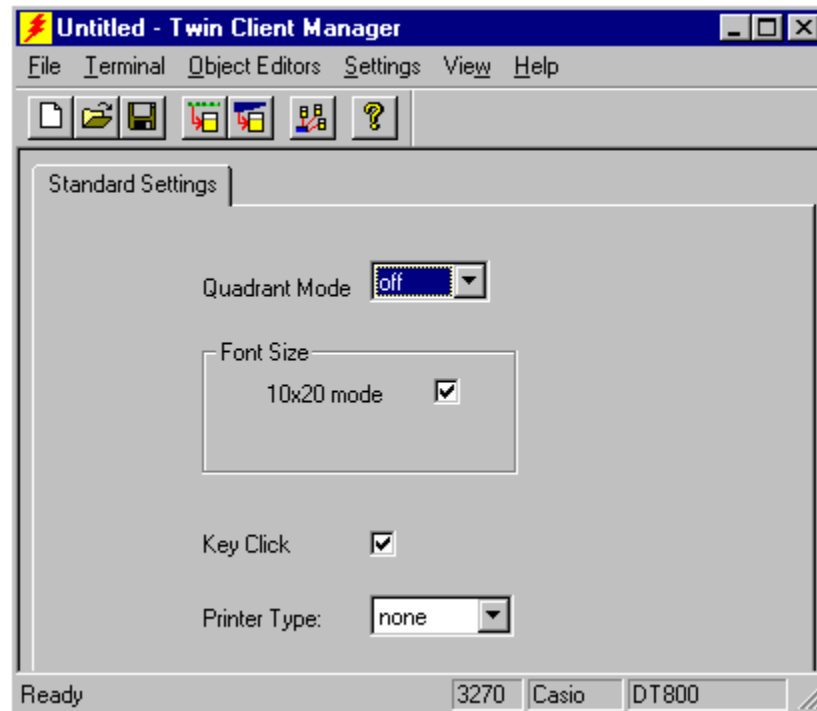

Quadrant Mode

The scrolling list defines the rules by which the terminal display is positioned in the larger host display. As defined by Twin Client, quadrants are fixed position “windows” in the host display, and the terminal display is located on whatever quadrant contains the current cursor position.

Off disables quadrant processing and Twin Client simply centers the current host input field in the terminal display.

On enables quadrant processing. However, input fields that cross quadrant boundaries result in a shift to the left in order to locate as much of the current input field on the terminal display.

Soft always positions on a quadrant boundary regardless of input field boundaries. Viewing keys are enabled.

Hard is the same as **Soft** except the viewing keys are disabled.

Lock locks the terminal display origin (upper left corner) to fixed row and column (x,y) coordinates in the host display. The coordinates are zero-based.

Font Size

This check box enables (checked) or disables (unchecked) the display of characters in 10x20 font.

Key Click

This check box enables (checked) or disables (unchecked) audible key clicks from the terminal. Default is on (checked).

Printer Type

This scrolling list selects the attached printer type. The default value is none, indicating no printer is attached.

Terminal Setup Using Twin Client Menus

The Twin Client terminal software provides an internal menu system for configuring certain parameters on the terminal and for switching between “server” and “telnet” mode of operation. To access this menu system, press the uppercase C at the startup screen as shown in the following figure.

```
Twin Client
© 1991-2006, Connect, Inc.

Keypress to Continue
```

The next screen displays the menu options. Cursor to the appropriate option and press **Enter**.

```
Edit Menu Options
Edit Mobile Unit IP
Edit Server/Host IPs
Edit License Key
Run Site Survey
Switch Client Modes
Run Client Emulator
Exit to OS
```

Use the **Up-Arrow** and **Down-Arrow** keys to navigate the menu, and press **Enter** to select the highlighted option. Each menu option is described below.

Edit Mobile Unit IP

The IP list contains the terminal IP address, the Subnet mask, and the Router IP address. Enter the appropriate address and select **F3** to save and/or **F7** to quit.

```
IP 206.232.71.38
SN 255.255.255.0
RT 206.232.71.1

<F3> Save <F7> Quit
```

Press **F3** to save the configurations.

Edit Server/Host IPs

If you wish to change the host IP address or addresses using the terminal menus, select this option and enter up to four Host IP addresses as required.

```
Host 0
IP 206.183.67.155
Port 23__
<F3> Save <F7> Quit
```

Press **F3** to save the configurations.

Edit License Key

The client software can be authorized automatically, as described in the next section, *Authorizing PowerNet*. This menu option permits authorization of each terminal manually. Select this option to obtain the terminal's Identification Code, which is used to obtain the Authorization code from the Connect web site, as described in the next section.

The 12-digit value displayed at the top of the terminal screen is the Identification Code for the terminal.

```
00A0F826E614
Authorization
_____
not authorized
<F3> Save <F7> Quit
```

Type the authorization code into the field as it appears on the WEB site. Punctuation characters, such as the hyphen (-), are not required. Press **F3** to save the authorization code.

Run Site Survey

This option (a feature of Spectrum 1) is applicable to Release 5.0 and may be obsolete for your terminal.

Switch Client Modes

The PowerNet Twin Client normally operates in "telnet" mode, which provides direct connection to Telnet hosts. It can also operate in "server" mode, through a PowerNet OpenAir server. Select this menu option to switch between server and telnet modes of operation. Note that the host socket address for the PowerNet OpenAir servers is 1800, which must also be changed in the **Edit Server/Host IPs** menu described at the beginning of this section.

Run Client Emulator

After all desired changes have been made, select this option to return to the Twin Client main menu. Then press any key to establish the Telnet session and begin emulation. Refer to *Starting a Telnet Session* under *Quick Start* for further instructions.

Authorizing PowerNet

Each PowerNet Twin Client will run for 30 minutes at a time without authorization. Uninterrupted operation for a production environment is the result of authorizing the software. Authorization codes are obtained from the Connect Website at <http://www.connectrf.com> on the Partner Services page. Click on the Generate Authorization icon at the top of the page.

Manual Authorization

The procedure for manually setting the Authorization code on the terminal is described in the section entitled Edit License Key in *Terminal Setup Using Twin Client Menus*.

Add Licenses

The Add Licenses feature is used when adding additional licenses to an already site licensed Twin Client manager. An example of this is the instance in which Twin Client manager is licensed for 10 licenses, and the customer purchases another 10 licenses to make a total of 20 licenses.

From Twin Client manager, choose **Authorization** from under the **Settings** menu. Click on the **Add Licenses** button.

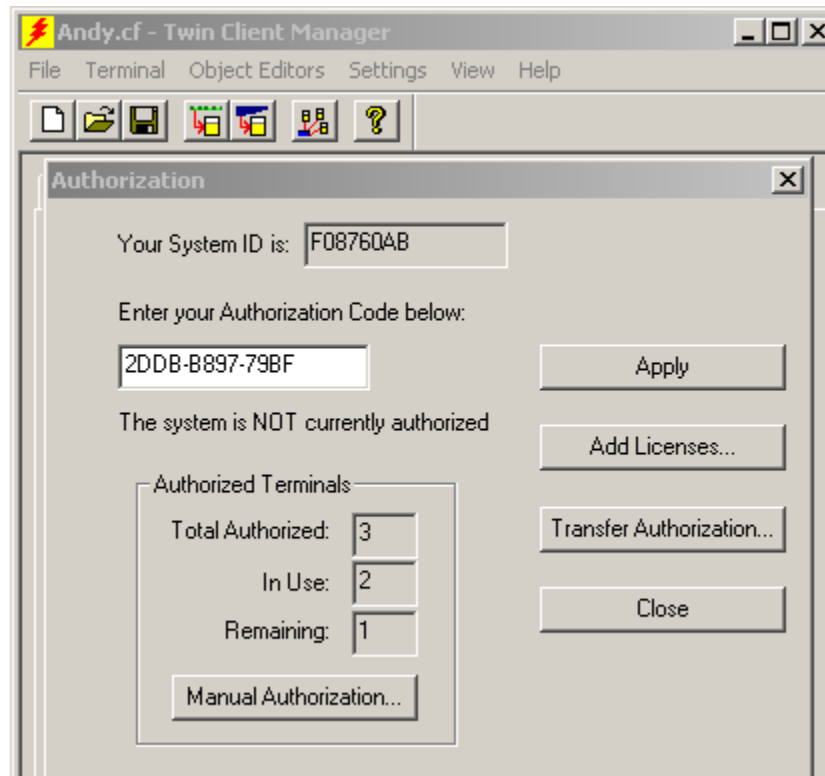

A pop-up box appears with the machine ID and a space for the additional licenses authorization code.

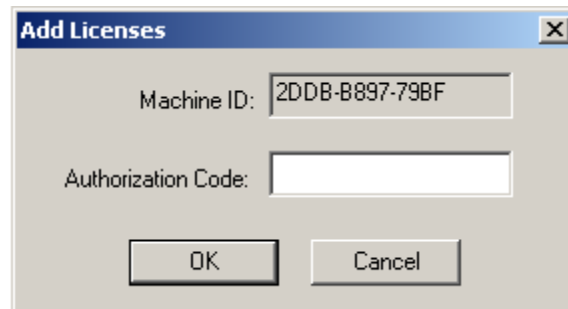

Enter the additional license's authorization code and click on OK.

Use the machine ID in the pop-up box instead of the original machine ID to get your authorization code.

If adding users, click on the Add Licenses button before generating the authorization code to get the most current machine ID.

Transfer Authorization

The Transfer Authorization feature is used when moving a site license from one PC to another. After Twin Client manager is installed on a new PC, you will need the system/machine ID for it.

From Twin Client manager, select **Authorization** from under the **Settings** menu.

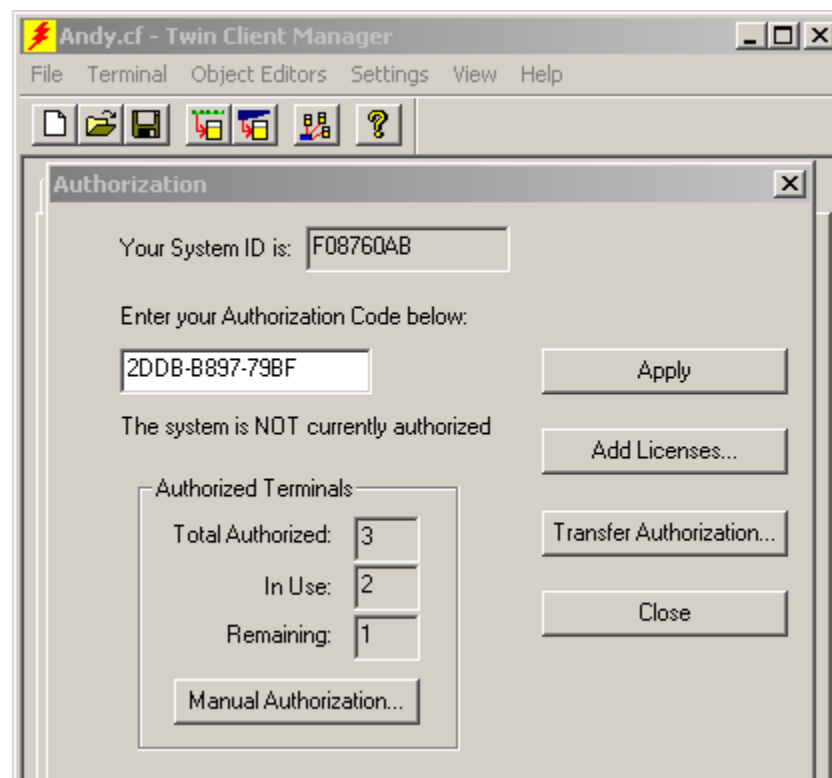

Note: This feature only works if there are licenses remaining on the old PC.

Software Management

In addition to providing functions for the download of files to the terminal via the traditional serial connection, the Twin Client Manager also provides for the management of terminal software and configurations automatically over the wireless network.

This section entitled *Software Management* describes the automated capability in detail. Additional manual operations involving serial download options are described at the end of this section.

Auto-Configuration

The Auto-Configuration form is accessed from the Twin Client Manager **Settings** menu.

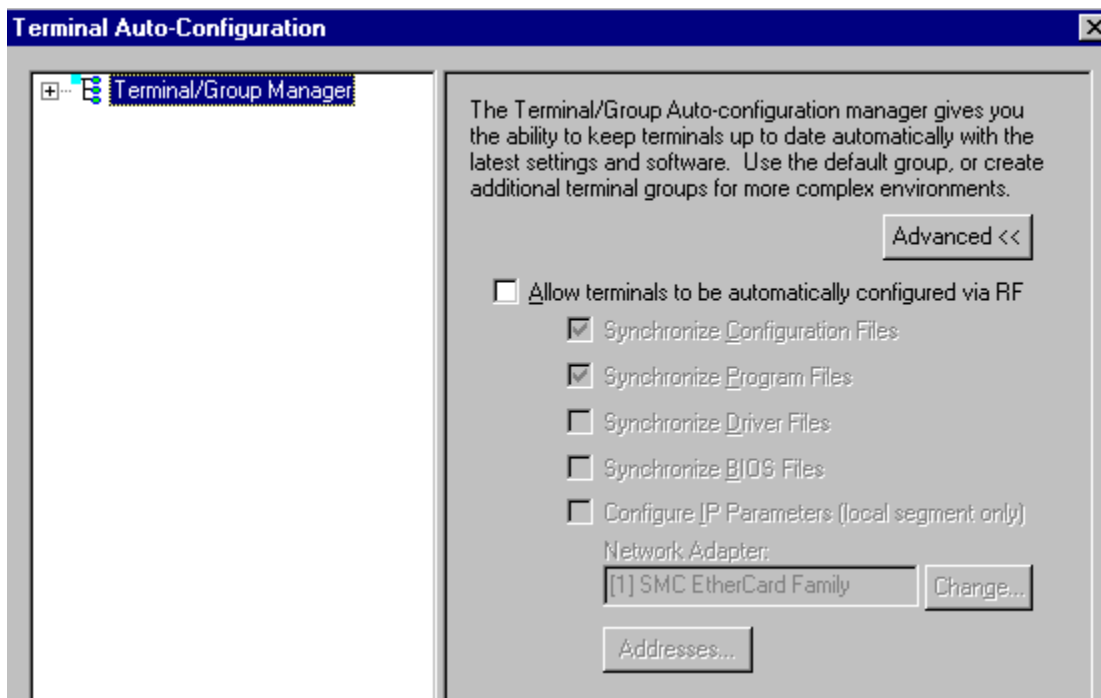

Note: If no options are displayed, click the Advanced<< button.

Enabling Automatic Downloads

Click to put a check in the box that allows terminal to be automatically configured via RF to enable automatic downloading. In the event another PC on the network is already configured and active, the following warning message is displayed.

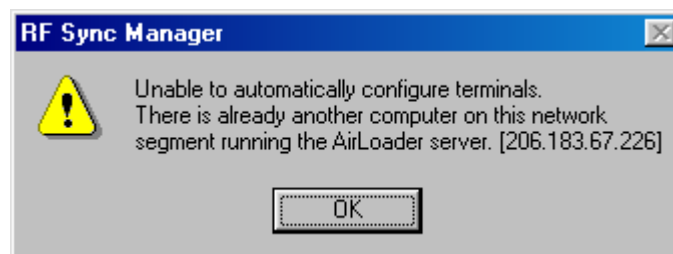

Synchronizing Configuration Files

Click to put a check in the Synchronize Configuration Files box to enable automatic synchronization of configuration files on the terminal. When the terminal is command booted, its configuration files will be compared with the most recent on the PC. The terminal is updated automatically if it does not have the latest revision.

Synchronizing Program Files

Click to put a check in the Synchronize Program Files box to enable automatic synchronization of program files on the terminal. When the terminal is command booted, its program files will be compared with the most recent on the PC. The terminal is updated automatically if it does not have the latest revision.

Automatic IP Address Assignment

New terminals will be assigned IP addresses automatically if the following box is checked.

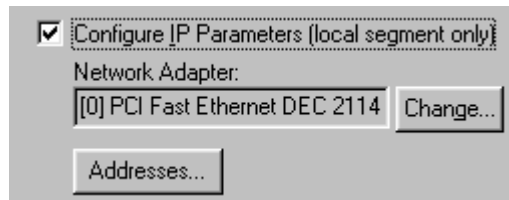

Note: Do not check this option if a DHCP server is configured to manage address assignments.

To set the addresses, click on the **Addresses** button to access the Segment Address Assignments dialog box, as shown in the following figure.

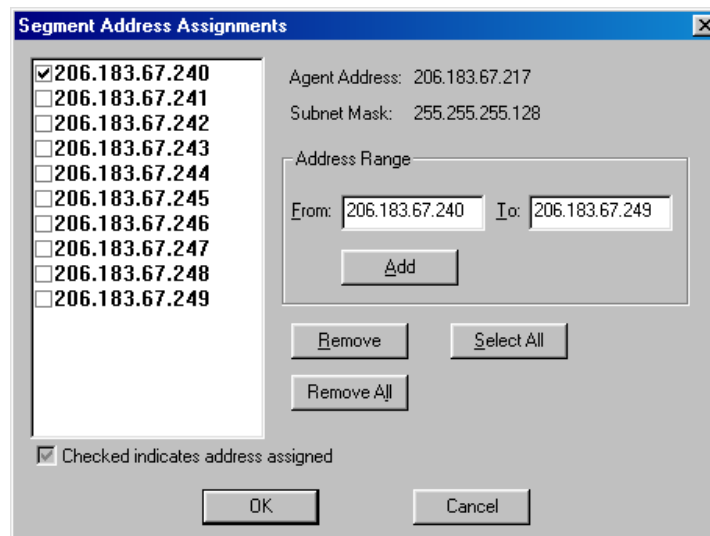

Enter the desired range in the **F**rom and **T**o boxes as shown above, and then click on **Add**.

Creating New Groups

New groups, with different configurations, can be created by clicking on **Terminal Group Manager**, and then clicking the right mouse button as shown.

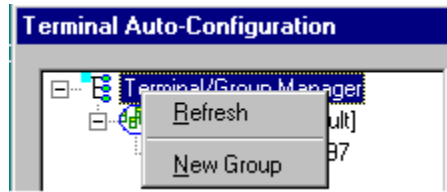

After the new group has been created, the group settings option becomes available for change, as shown below.

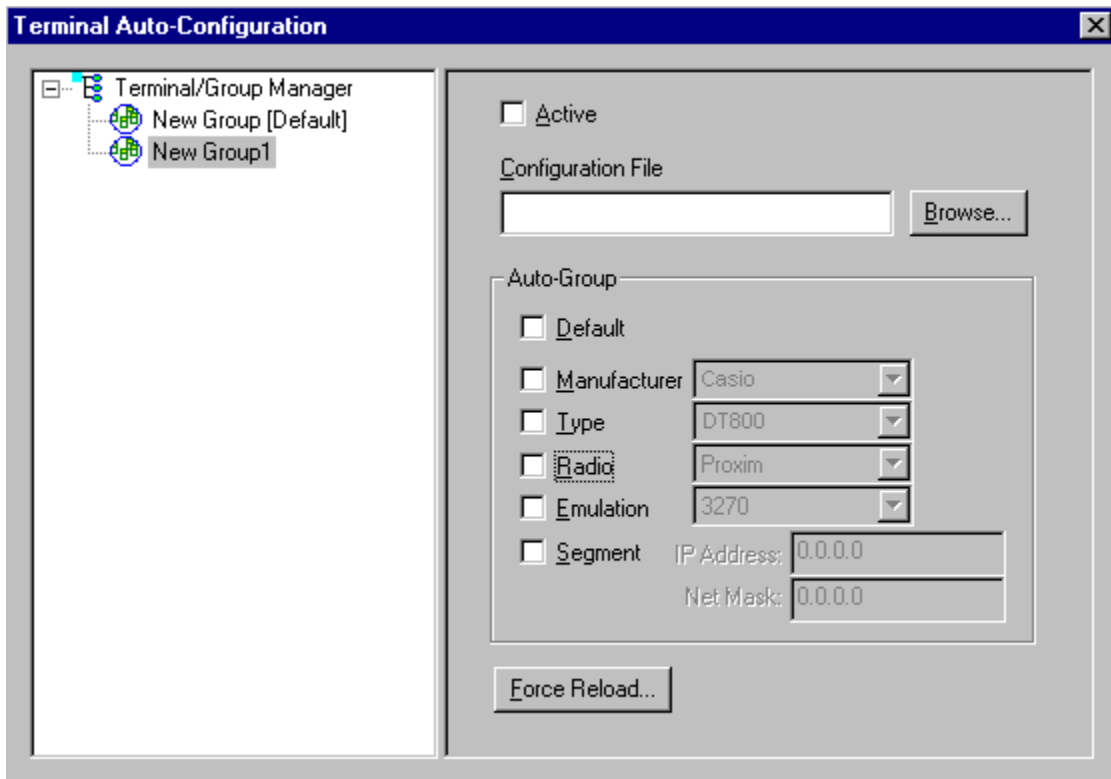

After the Configuration File and all of the other parameters have been set, the group is made active by clicking on the **Active** check box.

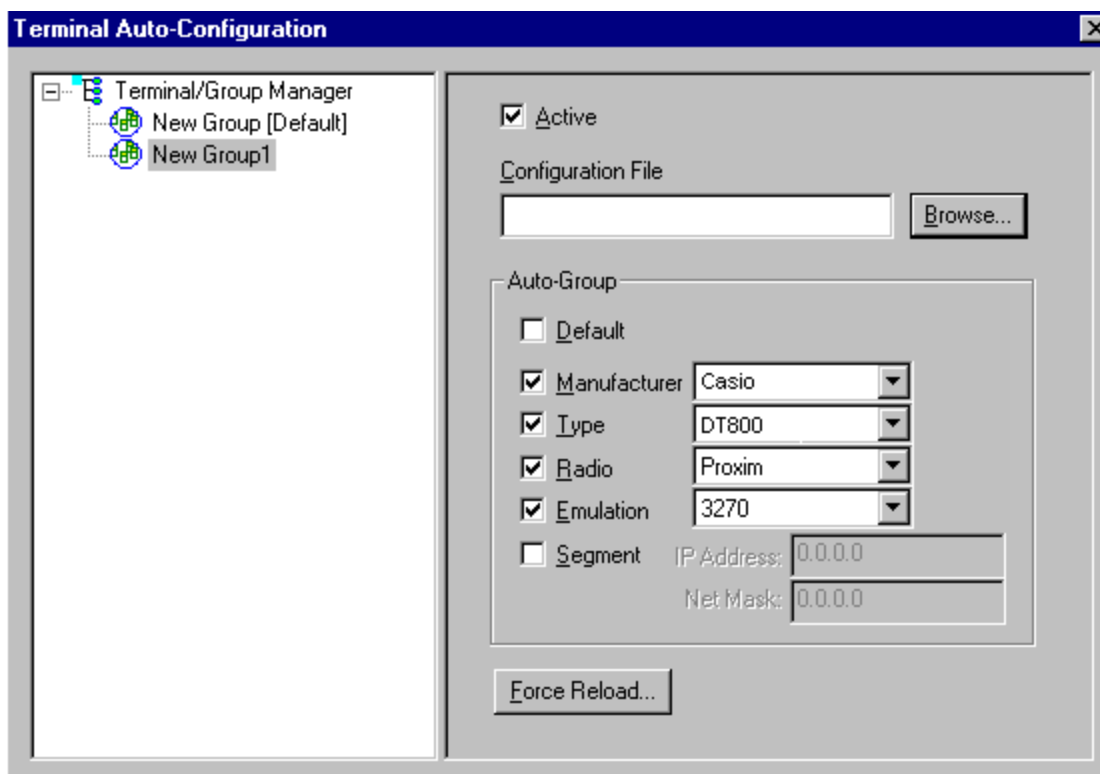

Setting the Segment

Checking the **Segment** button restricts a terminal group to a range of IP addresses. The IP Address can be any valid address on the segment, as it is used only to identify the segment. The setting of the Net Mask can be used to restrict the range. This feature is useful for segregating terminal groups by location.

Setting Force Reload

Clicking on the **Force Reload** button forces all terminals within a group to be automatically updated. The following warning message appears.

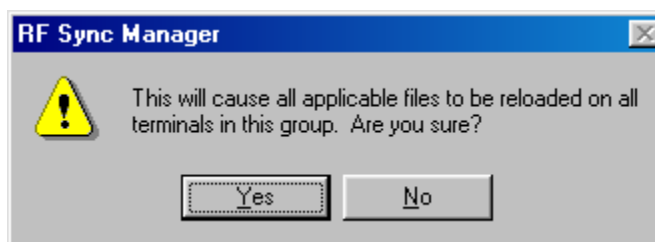

Click on the **Yes** button to force the reload.

Setting the Default Terminal Group

New terminals that have not yet been assigned to any group are initially assigned to the default group in effect when they are command booted.

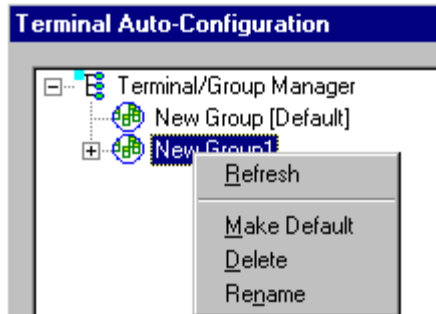

Any group can be made the default group by clicking on the group, and then clicking on the right mouse button. Then click on the **Make Default** option.

Reassigning Terminals

After a terminal has been configured and assigned to the default group, it can be reassigned to a new group by clicking on the terminal icon as shown below.

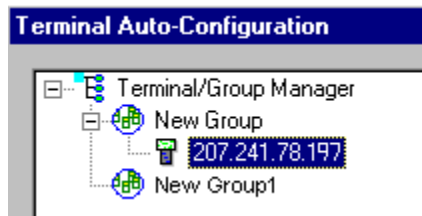

Then, holding the mouse button down, drag the terminal icon to the desired group as shown next.

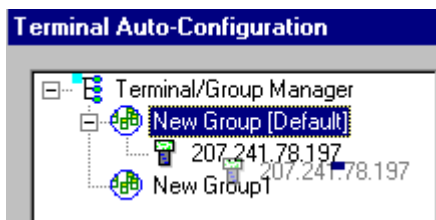

Release the mouse button, which reassigns the terminal.

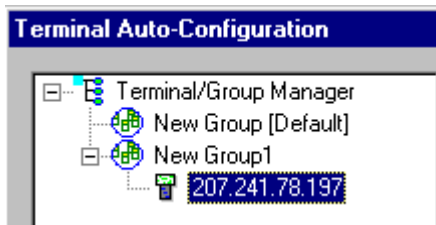

The next time the terminal is rebooted, it will be reconfigured as defined in the group specification.

Chapter 3 • Keypad Configuration

Keypad Figures

Casio DT-800RF 5250

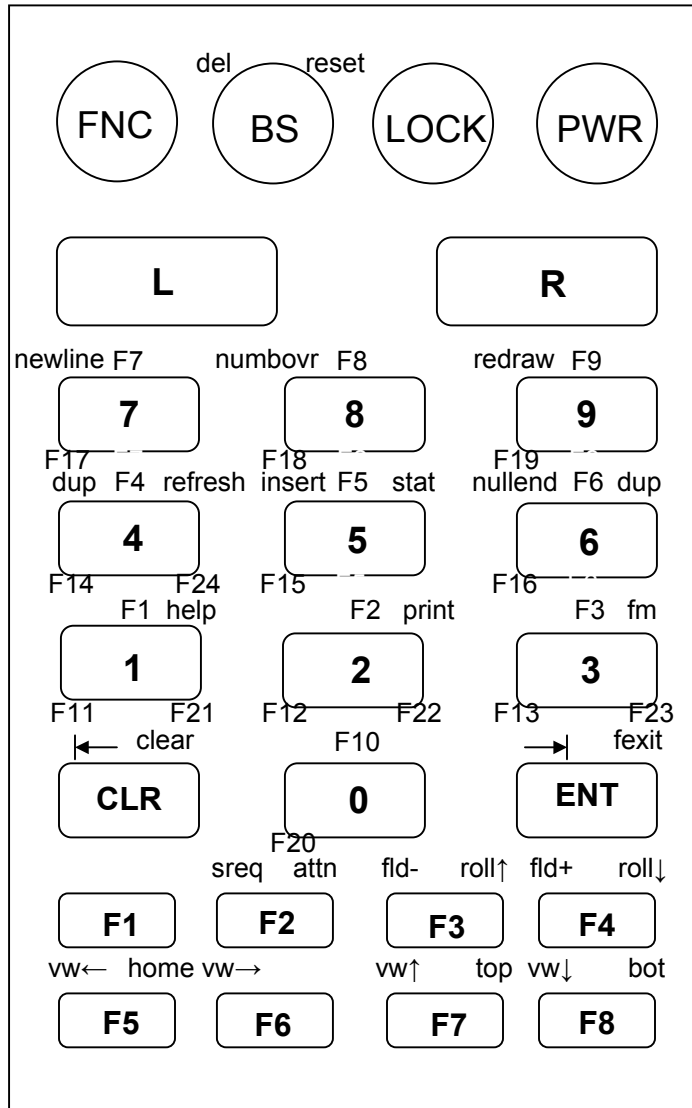

Left Func Right

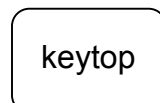

Left + Right +
Func Func

Casio DT-800RF, 3270

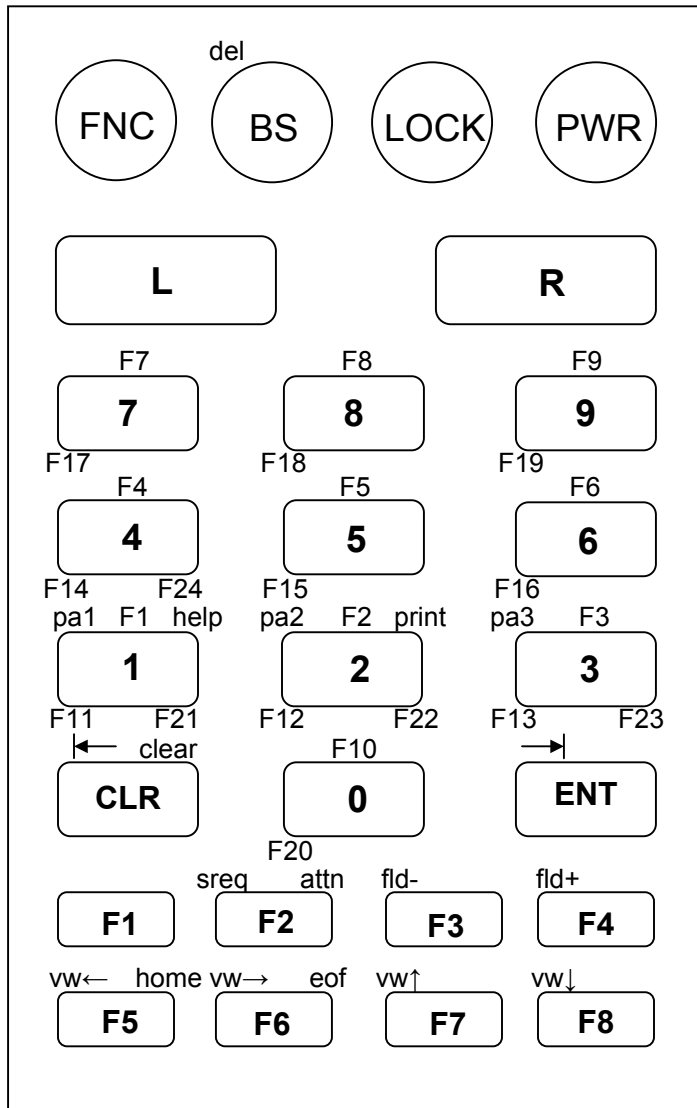

Left Func Right

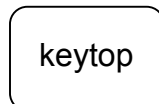

Left + Right +
Func Func

Casio DT-800RF, VT

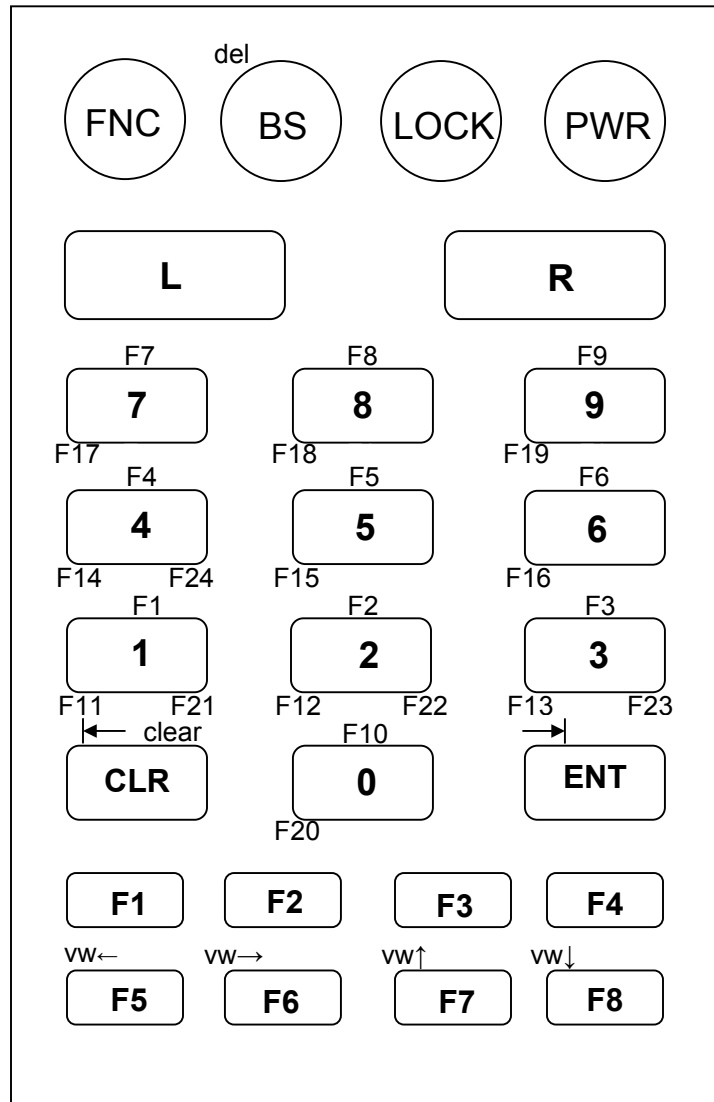

Left Func Right

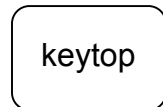

Left + Right +
Func Func

Keypad Table

The keypad tables in this section are organized by terminal model, keypad configuration, and emulation. The key values represent the default keypad assignments applied to the terminal in Twin Client advanced mode.

Table entries that are blank indicate the key is not assigned, or not relevant to the emulation.

KEY	5250	3270	VT
1	<1>	<1>	<1>
2	<2>	<2>	<2>
3	<3>	<3>	<3>
4	<4>	<4>	<4>
5	<5>	<5>	<5>
6	<6>	<6>	<6>
7	<7>	<7>	<7>
8	<8>	<8>	<8>
9	<9>	<9>	<9>
0	<0>	<0>	<0>
ATTENTION	<RIGHT><F2>	<RIGHT><F2>	
BACK TAB	<LEFT><CLR>	<LEFT><CLR>	<LEFT><CLR>
BACKSPACE	<BS>	<BS>	<BS>
BOTTOM	<RIGHT><F8>		
CLEAR	<RIGHT><CLR>	<RIGHT><CLR>	<CLR>
DELETE	<LEFT><BS>	<LEFT><BS>	<LEFT><BS>
DUP	<LEFT><4><RITE><6>		
ENTER	<ENT>	<ENT>	<ENT>
EOF		<RIGHT><F6>	
FIELD ADVANCE	<LEFT><F4>	<LEFT><F4>	
FIELD EXIT	<RIGHT><ENT>		
FIELD MINUS	<LEFT><F3>	<LEFT><F3>	
FM	<RIGHT><3>		
HELP	<RIGHT><1>	<RIGHT><1>	
HOME	<RIGHT><F5>	<RIGHT><F5>	
INSERT	<LEFT><5>		
LOCK	<LOCK>	<LOCK>	<LOCK>
NEWLINE	<LEFT><7>		
NULLEND	<LEFT><6>		
NUMBOVR	<LEFT><8>		
PRINT	<RIGHT><2>	<RIGHT><2>	
REDRAW	<LEFT><9>		
REFRESH	<RIGHT><4>		
RESET	<RIGHT><BS>		
ROLL DOWN	<RIGHT><F4>		
ROLL UP	<RIGHT><F3>		
SPACE	<F2>	<F2>	<F2>
STAT	<RIGHT><5>		
SYS REQUEST	<LEFT><F2>	<LEFT><F2>	
TAB	<LEFT><ENT>	<LEFT><ENT>	<LEFT><ENT>
TOP	<RIGHT><F7>		
VIEW DOWN	<LEFT><F8>	<LEFT><F8>	<LEFT><F8>
VIEW LEFT	<LEFT><F5>	<LEFT><F5>	<LEFT><F5>
VIEW RIGHT	<LEFT><F6>	<LEFT><F6>	<LEFT><F6>
VIEW UP	<LEFT><F7>	<LEFT><F7>	<LEFT><F7>
PA1		<LEFT><1>	
PA2		<LEFT><2>	
PA3		<LEFT><3>	
F1	<FUNC><1>	<FUNC><1>	<FUNC><1>
F2	<FUNC><2>	<FUNC><2>	<FUNC><2>

F3	<FUNC><3>	<FUNC><3>	<FUNC><3>
F4	<FUNC><4>	<FUNC><4>	<FUNC><4>
F5	<FUNC><5>	<FUNC><5>	<FUNC><5>
F6	<FUNC><6>	<FUNC><6>	<FUNC><6>
F7	<FUNC><7>	<FUNC><7>	<FUNC><7>
F8	<FUNC><8>	<FUNC><8>	<FUNC><8>
F9	<FUNC><9>	<FUNC><9>	<FUNC><9>
F10	<FUNC><0>	<FUNC><0>	<FUNC><0>
F11	<LEFT><FUNC><1>	<LEFT><FUNC><1>	<LEFT><FUNC><1>
F12	<LEFT><FUNC><2>	<LEFT><FUNC><2>	<LEFT><FUNC><2>
F13	<LEFT><FUNC><3>	<LEFT><FUNC><3>	<LEFT><FUNC><3>
F14	<LEFT><FUNC><4>	<LEFT><FUNC><4>	<LEFT><FUNC><4>
F15	<LEFT><FUNC><5>	<LEFT><FUNC><5>	<LEFT><FUNC><5>
F16	<LEFT><FUNC><6>	<LEFT><FUNC><6>	<LEFT><FUNC><6>
F17	<LEFT><FUNC><7>	<LEFT><FUNC><7>	<LEFT><FUNC><7>
F18	<LEFT><FUNC><8>	<LEFT><FUNC><8>	<LEFT><FUNC><8>
F19	<LEFT><FUNC><9>	<LEFT><FUNC><9>	<LEFT><FUNC><9>
F20	<LEFT><FUNC><0>	<LEFT><FUNC><0>	<LEFT><FUNC><0>
F21	<RIGHT><FUNC><1>	<RIGHT><FUNC><1>	<RIGHT><FUNC><1>
F22	<RIGHT><FUNC><2>	<RIGHT><FUNC><2>	<RIGHT><FUNC><2>
F23	<RIGHT><FUNC><3>	<RIGHT><FUNC><3>	<RIGHT><FUNC><3>
F24	<RIGHT><FUNC><4>	<RIGHT><FUNC><4>	<RIGHT><FUNC><4>
- dash	<F3>	<F3>	<F3>
. period	<F4>	<F4>	<F4>
▲	<F7>	<F7>	<F7>
▼	<F8>	<F8>	<F8>
◀	<F5>	<F5>	<F5>
▶	<F6>	<F6>	<F6>

This page is intentionally blank.

Chapter 4 • Error Message Resolution Guide

Twin Client Error Message Resolution Guide

Message	Reason	Solution	Reference Tech Note
ENTRY TOO LONG;	Trying to key beyond the field size.	Ensure that you are entering input into the correct field.	---
ALPHABETIC ONLY;	Trying to key a character that is not alphabetic.	Ensure that you are entering input into the correct field.	---
MINUS NOT VALID;	Trying to key a Minus sign.	Ensure that you are entering input into the correct field.	---
DECIMAL NOT VALID;	Trying to key a Decimal (period).	Ensure that you are entering input into the correct field.	---
ALPHANUMERIC ONLY;	Trying to key characters other than Alphabetic and numeric.	Ensure that you are entering input into the correct field.	---
NUMERIC ONLY;	Trying to key characters other than numeric.	Ensure that you are entering input into the correct field.	---
ENTRY TOO SHORT;	Trying to exit the field before it is filled.	Ensure that you are entering input into the correct field.	---

Message	Reason	Solution	Reference Tech Note
INVALID KEY;	The key pressed is not valid.	Ensure that you are entering input into the correct field.	---
MUST CLEAR FIELD;	Trying to enter data in a field that must be cleared first.	Ensure that you are entering input into the correct field.	---
SCAN NOT ALLOWED;	Trying to scan into a key only field.	Ensure that you are entering input into the correct field.	---
KEY NOT ALLOWED;	Trying to key into a scan only field.	Ensure that you are entering input into the correct field.	---
ENTRY TOO SHORT;	Trying to exit the field before it is filled.	Ensure that you are entering input into the correct field.	---
RECOVERABLE ERROR;	Encountered an error from which you can continue.	Verify that your configuration settings for the hardware being used, usually a printer and cable issue.	---
UNRECOVERABLE ERROR;	Encountered an error from which you can NOT continue.	Verify that your Network settings are correct and you are in the correct mode using the correct Port.	T1113, T1114, T1161, T1171, T1187 and T1194
FUNCTION: \n\nFILE: \nLINE: \nCODE;	Encountered an error from which you can NOT continue.	Notify Connect over the WEB incident reporting system.	---
Press any key\nFor More Details...;	Press Enter for more information.	Advisory message.	---
Press any key;	Press a key to continue.	Advisory message.	---

Message	Reason	Solution	Reference Tech Note
Connection ERROR.\nREBOOT MOBILE UNIT;	Could not Connect.	Verify that your Network settings are correct and you are in the correct mode using the correct Port.	T1113, T1114, T1161, T1171, T1187 and T1194
Disconnect ERROR.\nREBOOT MOBILE UNIT;	Could not Disconnect.	Verify that your Network settings are correct and you are in the correct mode using the correct Port.	T1113, T1114, T1161, T1171, T1187 and T1194
RF Send ERROR.\nREBOOT MOBILE UNIT;	Could not Send.	Most likely a range, access point, radio, host or network issue. Troubleshoot the customer's environment.	T1113, T1114, T1161, T1171, T1187 and T1194
RF Receive ERROR.\nREBOOT MOBILE UNIT;	Could not Receive.	Most likely a range, access point, radio, host or network issue. Troubleshoot the customer's environment.	T1113, T1114, T1161, T1171, T1187 and T1194
RF Check ERROR.\nREBOOT MOBILE UNIT;	Could not run the RF Survey.	Most likely a range, access point, radio, host or network issue. Troubleshoot the customer's environment.	T1113, T1114, T1161, T1171, T1187 and T1194
RF Timeout ERROR.\nREBOOT MOBILE UNIT;	Have been trying to contact the host for the radio timeout period (2 minutes default).	Most likely a range, access point, radio, host or network issue. Troubleshoot the customer's environment.	T1113, T1114, T1161, T1171, T1187 and T1194
REBOOT MOBILE UNIT;	Reboot the Mobile Unit do to loss of connection.	Most likely a range, access point, radio, host or network issue. Troubleshoot the customer's environment.	T1113, T1114, T1161, T1171, T1187 and T1194
Retry (Y/N)?;	Try again.	Try to send or receive again, or perhaps ensure that the printer is cabled to the Mobile Unit and is on.	---

Message	Reason	Solution	Reference Tech Note
TIMEOUT\n\nSending Data;	Mobile Unit out of the coverage area.	Most likely a range, access point, radio, host or network issue. Troubleshoot the customer's environment.	T1113, T1114, T1161, T1171, T1187 and T1194
TIMEOUT\n\nReceiving Data;	Mobile Unit out of the coverage area.	Most likely a range, access point, radio, host or network issue. Troubleshoot the customer's environment.	T1113, T1114, T1161, T1171, T1187 and T1194
Host Received Data\nAwaiting App Reply!;	Mobile Unit has sent and received an acknowledgement from the IP stack and is waiting for the application to return data.	Most likely a host or network issue. Troubleshoot the customer's environment. Probable causes are Database record locking, application program failure, Host failure or network failure.	T1113, T1114, T1161, T1171, T1187 and T1194
* WAITING TO SEND *;	Mobile Unit out of the coverage area.	Most likely a range, access point, radio, host or network issue. Troubleshoot the customer's environment.	T1113, T1114, T1161, T1171, T1187 and T1194
TCP Error Reading\nMAC Address.\nREBOOT MOBILE UNIT;	Could not obtain the Mac Address from the Mobile Unit.	Possible hardware, driver or stack problem Contact the Mobile Unit manufacturer.	---
Invalid TIP Command;	Bad internal protocol.	Notify Connect over the WEB incident reporting system.	---
Session Ended\nBy User or Host;	User, Host, application or network has ended the session.	If the user did not end the session, most likely host or network issues. Troubleshoot the customer's environment.	T1113, T1114, T1161, T1171, T1187 and T1194
Server Packet Error;	Bad Protocol detected.	Usually a result of bad cabling, power or faulty transceiver. Also, will receive this if the Mobile Unit is in the wrong mode for server operation.	---

Message	Reason	Solution	Reference Tech Note
Error receiving host\nlist from Server;	Bad Protocol detected.	Usually a result of bad cabling, power or faulty transceiver. Also, will receive this if the Mobile Unit is in the wrong mode for server operation.	---
Unexpected Server\ndata received;	Bad Protocol detected.	Usually a result of bad cabling, power or faulty transceiver. Also, will receive this if the Mobile Unit is in the wrong mode for server operation.	---
Error starting\nhost application;	Connected to the server but can not connect to the distant end.	Configure the server handler to access the host application.	---
Select Host or App;	Need to choose your Host/application destination.	User selection required.	---
Connecting...;	Attempting to connect to the Host/application.	Advisory message.	---
TCP Error\nReading IP Address\nREBOOT MOBILE UNIT;	Mobile Unit missing Network IP information.	Configure the Mobile Unit with the correct network IP information.	---
Printer start error;	Could not initialize the printer.	Cable or power issue with the printer.	---
Battery too low\nTo print;	Not enough power to print.	Replace the battery with a fully recharged battery.	---
Paper Feed Error\nFix Then Hit Enter;	Paper in the printer is not ready.	Replace the paper or rethread the paper in the printer.	---
Printer Error\nPrint Ended;	Can not print.	Check cable, battery, communication settings and paper in the printer.	---

Message	Reason	Solution	Reference Tech Note
User Count Exceeded.\n Session Ended;	Possible authorization issue.	Verify that you have the correct number of licenses for the number of Mobile Units you are using.	---
Primary Unavailable\nTrying Alternate;	First Host IP address not available trying the remaining addresses in the Host list.	Verify the host address.	---
APMAC.DAT Error\nSession Ended;	Access point Media Access Control error.	Most likely a range, access point, radio, host or network issue. Troubleshoot the customer's environment.	T1113, T1114, T1161, T1171, T1187 and T1194
MUIP.DAT Error\nSession Ended;	Mobile Unit IP Error.	Most likely a Mobile Unit network setting issue. Troubleshoot the customer's environment.	T1113, T1114, T1161, T1171, T1187 and T1194
Missing Subnet IP\nSession Ended;	Mobile Unit IP Netmask Error.	Most likely a Mobile Unit network setting issue. Troubleshoot the customer's environment.	T1113, T1114, T1161, T1171, T1187 and T1194
Error Opening File;	File is missing.	Verify that the configuration files are on the Mobile Unit. Or perhaps there is a hardware failure.	---
Telnet API\nnot found;	Program files are missing.	Reload program files.	---
Battery Low Warning\n\nReplace Battery Soon;	Not enough power to operate the Mobile Unit.	Replace the battery with a fully recharged battery.	---
No Host List.\nPress any key\nTo Edit Host IP's;	Have not configured your target hosts.	Configure the target host IP addresses.	---
Unable to Allocate\nFont Memory;	Mobile Unit does not have enough memory to load the fonts.	Reduce the fonts in use or expand the memory in the Mobile Unit.	---

Message	Reason	Solution	Reference Tech Note
Font Loading Error;	Could not load the font.	Ensure that the font is available to load.	---
Printer Not Ready\nPress R to Retry\nC to Cancel Print;	Can not print.	Check cable, battery, communication settings and paper in the printer.	---
Mobile Unit in\nDemonstration Mode\nfor TwinClient;	Running in demo mode.	Purchase a license from Connect.	---
Connected to Host;	Successful connection to the target Host.	Advisory message.	---
Telnet Mode not\nsupported on\nthis Mobile Unit;	This Mobile Unit must be used with a Connect Server.	Order a Connect Server.	---
Telnet Setup files\nnot found. Reload\nfiles then switch;	Customer specific configuration files are missing.	Load the configuration files into the Mobile Unit from Twin Client Manager.	---
Switched Client to\nTelnet Direct Mode;	Mobile Unit running in Telnet mode direct to the target Host.	Advisory message.	---
Switched Client to\nServer Based Mode;	Mobile Unit running through a Connect server in server mode usually at port 1800.	Advisory message.	---
Port 23 is only\nallowed in Telnet Mode;	Can not set the port to 23 in server mode. Port 23 is the standard Telnet port.	Advisory message.	---
Not Enough Memory\nTo Run;	Mobile Unit does not have the capacity to run the program do to memory restrictions.	Expand the Mobile Unit memory.	---
Press any key;	Press a key to continue.	Advisory message.	---

Message	Reason	Solution	Reference Tech Note
TwinClient Telnet;	Prompt.	Advisory message.	---
TwinClient Server;	Prompt.	Advisory message.	---
TwinClient TN3270;	Prompt.	Advisory message.	---
TwinClient TN5250;	Prompt.	Advisory message.	---
TwinClient TNVT;	Prompt.	Advisory message.	---
(c) 1991-2006 Connect;	Prompt.	Advisory message.	---
Edit Menu Options;	Menu Title.	Advisory message.	---
Edit Mobile Unit IP;	Menu Option.	Advisory message.	---
Edit Server/Host IPs;	Menu Option.	Advisory message.	---
Edit Radio Option;	Menu Option.	Advisory message.	---

Message	Reason	Solution	Reference Tech Note
Edit License Key;	Menu Option.	Advisory message.	---
Run Site Survey;	Menu Option.	Advisory message.	---
Switch Client Modes;	Menu Option.	Advisory message.	---
Run TwinClient;	Menu Option.	Advisory message.	---
Exit to OS;	Menu Option.	Advisory message.	---
Printer may not be plugged in or turned on!	Can not print.	Check cable, battery, communication settings and paper in the printer.	---
OUT OF RANGE OF BASE;	Mobile Unit out of the coverage area.	Most likely a range, access point, radio, host or network issue. Troubleshoot the customer's environment.	T1113, T1114, T1161, T1171, T1187 and T1194
CONNECT SERIAL CABLE;	Serial cable not connected to the Mobile Unit.	Check cable, battery and communication settings for the Mobile Unit.	---
REMOVE SERIAL CABLE;	Remove serial cable from to the Mobile Unit.	Check cable, battery and communication settings for the Mobile Unit.	---
PLACE IN CRADLE;	Place the Mobile Unit in the cradle.	Advisory message.	---

Message	Reason	Solution	Reference Tech Note
REMOVE FROM CRADLE;	Remove Mobile Unit from the cradle.	Advisory message.	---
ACQUIRING CRADLE BUS;	Attempting to access the cradle through the serial port you have configured.	Advisory message.	---
Printer Out\nOf Range;	Printer out of the coverage area.	Most likely a range, access point or radio issue. Troubleshoot the customer's environment.	T1113, T1114, T1161, T1171, T1187 and T1194
Connection Refused\nBy Host;	You connected to the target host but the host disconnected you.	Verify that the configuration file has the correct Mobile Unit type and New environment variable set. Fallback to the Connect Default to verify the connection.	---
Connection Timed Out;	You connected to the host but did not logon in the appropriate time so the host disconnected you.	Modify the Host parameters for login.	---
Connection Failed\nHost Not Responding;	Could not connect to the Host.	Most likely a range, access point, radio, host or network issue. Troubleshoot the customer's environment.	T1113, T1114, T1161, T1171, T1187 and T1194
Connection Failed\nHost Unreachable;	Could not connect to the Host.	Most likely a range, access point, radio, host or network issue. Troubleshoot the customer's environment.	T1113, T1114, T1161, T1171, T1187 and T1194
Mobile Unit Out\nOf Range, Unable\nTo Transmit;	Mobile Unit out of the coverage area.	Most likely a range, access point, radio, host or network issue. Troubleshoot the customer's environment.	T1113, T1114, T1161, T1171, T1187 and T1194

Message	Reason	Solution	Reference Tech Note
Mobile Unit Out\nOf Range, Unable\nTo Receive;	Mobile Unit out of the coverage area.	Most likely a range, access point, radio, host or network issue. Troubleshoot the customer's environment.	---
Printer Not\nResponding;	Can not print.	Check cable, battery, communication settings and paper in the printer.	---
Printer Out\nOf Range;	Printer out of the coverage area.	Most likely a range, access point or radio issue. Troubleshoot the customer's environment.	T1113, T1114, T1161, T1171, T1187 and T1194
Print Complete;	Prompt.	Advisory message.	---
Reprint (Y/N)?;	Yes or No prompt for a reprint.	Advisory message.	---
WARNING;	Prompt.	Advisory message.	---
Turning power off\nduring a session\nwill cause the\nprogram to restart;	This Mobile Unit will disconnect the session if powered off.	Mobile Unit manufacturer limitation. Advisory message.	---
Are you sure (y/n)?;	Yes or No prompt for a confirmation.	Advisory message.	---
You Sure? (YyNn);	Yes or No prompt for a confirmation.	Advisory message.	---

Message	Reason	Solution	Reference Tech Note
Domain Name Server\n\nNot Set;	DOMAIN NAME SERVER not configured.	Configure the Mobile Unit with the correct network IP information.	---
Domain Name Server\n\nQuery Memory Error;	Memory error on the Mobile Unit	Expand the Mobile Unit memory or return the Mobile Unit for repair.	---
Domain Name Server\n\nQuery Sending Error;	Mobile Unit out of the coverage area.	Most likely a range, access point, radio, host or network issue. Troubleshoot the customer's environment.	T1113, T1114, T1161, T1171, T1187 and T1194
Domain Name Server\n\nQuery Receive Error;	Mobile Unit out of the coverage area.	Most likely a range, access point, radio, host or network issue. Troubleshoot the customer's environment.	T1113, T1114, T1161, T1171, T1187 and T1194
Domain Name Server\n\nUnavailable;	Could not connect to the DOMAIN NAME SERVER.	Most likely a range, access point, radio, host or network issue. Troubleshoot the customer's environment.	T1113, T1114, T1161, T1171, T1187 and T1194
Error loading\n\nparameter file;	Could not load the parameter file.	Reload the correct configuration files.	---
Could not open\n\nintelnet interface;	Could not telnet.	Reload the program files.	---
Could not set\n\nmtelnet options;	Could not use the telnet configuration.	Reload the correct configuration files.	---
Setup file\n\nsetting mismatch\n\nReload Setup;	Emulation program selected is not compatible with the configuration file on the Mobile Unit.	Remove the emulation and configuration files. Run clear Telnet on the Mobile Unit then reload the Mobile Unit with the proper emulation and configuration files.	---

Message	Reason	Solution	Reference Tech Note
Display formatting\ntoo large for\ncurrent screen;	Mobile Unit does not have enough memory to run your configured reformatted screens.	Expand the Mobile Unit memory or order a server from Connect.	---
Mobile Unit\ninitialization error;	Mobile Unit problem.	Return the Mobile Unit to the manufacturer for repair.	---
Host/App/Network\nclosed the session;	Customer's environment disconnected the Mobile Unit session.	Most likely a range, access point, radio, host or network issue. Troubleshoot the customer's environment.	T1113, T1114, T1161, T1171, T1187 and T1194
Disconnecting...;	Prompt.	Advisory message.	---
Scan Barcode;	Bar code scanning test.	Advisory message.	---
Enter Setup\nPassword;	Prompt.	Advisory message.	---
Enter Profile \nPassword;	Prompt.	Advisory message.	---
Host IP;	Host IP address prompt.	Enter target host IP address.	---
Host Name;	Host name prompt.	Enter target host Name.	---
Port;	Host IP port required.	Enter 23 for telnet or 1800 for a Connect server. Could also be a different number depending on the customer's environment.	T1113, T1114, T1161, T1171, T1187 and T1194

Message	Reason	Solution	Reference Tech Note
Mobile Unit Type;	Prompt.	Advisory message.	---
WARNING: This will \nend any\ncurrent session;	Prompt.	Advisory message.	---
Continue (Y/N)?;	Prompt.	Advisory message.	---
HOST ENTRY;	Prompt.	Advisory message.	---
VT(100/220) Setup;	Prompt.	Advisory message.	---
Mobile Unit Info;	Prompt.	Advisory message.	---
Emulation Setup;	Prompt.	Advisory message.	---
ANSI Setup;	Prompt.	Advisory message.	---
Miscellaneous Setup;	Prompt.	Advisory message.	---
Mobile Unit Type;	Prompt.	Advisory message.	---

Message	Reason	Solution	Reference Tech Note
Control Codes;	Prompt.	Advisory message.	---
Local Echo;	Prompt.	Advisory message.	---
<BK SP> Sends;	Prompt.	Advisory message.	---
New Line Mode;	Prompt.	Advisory message.	---
Insert Mode;	Prompt.	Advisory message.	---
Autowrap Mode;	Prompt.	Advisory message.	---
Cursor;	Prompt.	Advisory message.	---
EMULATION SETUP;	Prompt.	Advisory message.	---
Mobile Unit Type;	Prompt.	Advisory message.	---
Local Echo;	Prompt.	Advisory message.	---

Message	Reason	Solution	Reference Tech Note
Map Underline;	Prompt.	Advisory message.	---
Break Key;	Prompt.	Advisory message.	---
ANSI Setup;	Prompt.	Advisory message.	---
Control Codes;	Prompt.	Advisory message.	---
Backspace Key;	Prompt.	Advisory message.	---
MISCELLANEOUS SETUP;	Prompt.	Advisory message.	---
Test Options;	Prompt.	Advisory message.	---
Login Options;	Prompt.	Advisory message.	---
TEST OPTIONS;	Prompt.	Advisory message.	---
Printer Test;	Prompt.	Advisory message.	---

Message	Reason	Solution	Reference Tech Note
Scan Code Test;	Prompt.	Advisory message.	---
LOGIN OPTIONS;	Prompt.	Advisory message.	---
User Name;	Prompt.	Advisory message.	---
User Password;	Prompt.	Advisory message.	---
ON;	Prompt.	Advisory message.	---
OFF;	Prompt.	Advisory message.	---
Map;	Prompt.	Advisory message.	---
Don't Map;	Prompt.	Advisory message.	---
Enable Break;	Prompt.	Advisory message.	---
Disable Break;	Prompt.	Advisory message.	---

Message	Reason	Solution	Reference Tech Note
7 bit;	Prompt.	Advisory message.	---
8 bit;	Prompt.	Advisory message.	---
Send Delete;	Prompt.	Advisory message.	---
Send Backspace;	Prompt.	Advisory message.	---
Mobile Unit Setup;	Prompt.	Advisory message.	---
Scanner Options;	Prompt.	Advisory message.	---
Program Options;	Prompt.	Advisory message.	---
Special Options;	Prompt.	Advisory message.	---
Beeper Options;	Prompt.	Advisory message.	---
Exit to DOS;	Prompt.	Advisory message.	---

Message	Reason	Solution	Reference Tech Note
Backlight Time;	Prompt.	Advisory message.	---
Enter Key Action;	Prompt.	Advisory message.	---
Reset Options;	Prompt.	Advisory message.	---
Font Size;	Prompt.	Advisory message.	---
Portable Printer;	Prompt.	Advisory message.	---
Reprint Option;	Prompt.	Advisory message.	---
Data IDs;	Prompt.	Advisory message.	---
Internal/External;	Prompt.	Advisory message.	---
Modify Beeps;	Prompt.	Advisory message.	---
Message Beeps;	Prompt.	Advisory message.	---

Message	Reason	Solution	Reference Tech Note
Scan Identifier;	Prompt.	Advisory message.	---
AID Scan Setup;	Prompt.	Advisory message.	---
Long Scans;	Prompt.	Advisory message.	---
Scan Send;	Prompt.	Advisory message.	---
Yes;	Prompt.	Advisory message.	---
No;	Prompt.	Advisory message.	---
Normal;	Prompt.	Advisory message.	---
Double Wide;	Prompt.	Advisory message.	---
Double High;	Prompt.	Advisory message.	---
Double High and Wide;	Prompt.	Advisory message.	---

Message	Reason	Solution	Reference Tech Note
Errors Only;	Prompt.	Advisory message.	---
Automatic;	Prompt.	Advisory message.	---
All Messages;	Prompt.	Advisory message.	---
Reject;	Prompt.	Advisory message.	---
Truncate;	Prompt.	Advisory message.	---
Split;	Prompt.	Advisory message.	---
Do Not Send;	Prompt.	Advisory message.	---
Always Send;	Prompt.	Advisory message.	---
Last Field Only;	Prompt.	Advisory message.	---
Internal;	Prompt.	Advisory message.	---

Message	Reason	Solution	Reference Tech Note
External;	Prompt.	Advisory message.	---
none;	Prompt.	Advisory message.	---
monarch;	Prompt.	Advisory message.	---
pddumb;	Prompt.	Advisory message.	---
comtec;	Prompt.	Advisory message.	---
rascal;	Prompt.	Advisory message.	---
codewriter;	Prompt.	Advisory message.	---
comtec(S);	Prompt.	Advisory message.	---
User Name;	Prompt.	Advisory message.	---
Password;	Prompt.	Advisory message.	---

Message	Reason	Solution	Reference Tech Note
Frequency: Hz;	Prompt.	Advisory message.	---
Duration: ms;	Prompt.	Advisory message.	---
Delay: ms;	Prompt.	Advisory message.	---
Select Scanner;	Prompt.	Advisory message.	---
Setup Scanner;	Prompt.	Advisory message.	---
Scan Test;	Prompt.	Advisory message.	---
Scan Operation;	Prompt.	Advisory message.	---
Laser;	Prompt.	Advisory message.	---
Contact/Pulse;	Prompt.	Advisory message.	---
Contact/No Pulse;	Prompt.	Advisory message.	---

Message	Reason	Solution	Reference Tech Note
Auto/Pulse;	Prompt.	Advisory message.	---
Auto/No Pulse;	Prompt.	Advisory message.	---
Wand Simulation;	Prompt.	Advisory message.	---
VT100;	Prompt.	Advisory message.	---
VT220;	Prompt.	Advisory message.	---
SETUP;	Prompt.	Advisory message.	---
Mobile Unit IP/Radio;	Prompt.	Advisory message.	---
Host List;	Prompt.	Advisory message.	---
NULL;	Prompt.	Advisory message.	---

Free Manuals Download Website

<http://myh66.com>

<http://usermanuals.us>

<http://www.somanuals.com>

<http://www.4manuals.cc>

<http://www.manual-lib.com>

<http://www.404manual.com>

<http://www.luxmanual.com>

<http://aubethermostatmanual.com>

Golf course search by state

<http://golfingnear.com>

Email search by domain

<http://emailbydomain.com>

Auto manuals search

<http://auto.somanuals.com>

TV manuals search

<http://tv.somanuals.com>