

HG20 HG21

HD Camcorder

Instruction Manual



Important Usage Instructions

WARNING!

TO REDUCE THE RISK OF ELECTRIC SHOCK, DO NOT REMOVE COVER (OR BACK). NO USER SERVICEABLE PARTS INSIDE. REFER SERVICING TO QUALIFIED SERVICE PERSONNEL.

WARNING!

TO REDUCE THE RISK OF FIRE OR ELECTRIC SHOCK, DO NOT EXPOSE THIS PRODUCT TO RAIN OR MOISTURE.

CAUTION:

TO REDUCE THE RISK OF ELECTRIC SHOCK AND TO REDUCE ANNOYING INTERFERENCE, USE THE RECOMMENDED ACCESSORIES ONLY.

CAUTION:

DISCONNECT THE MAINS PLUG FROM THE SUPPLY SOCKET WHEN NOT IN USE.

The Mains plug is used as the disconnect device. The Mains plug shall remain readily operable to disconnect the plug in case of an accident.

While using the compact power adapter, do not wrap it or cover it with a piece of cloth, and do not place it in confined narrow spaces. Heat may build up, the plastic case may deform and it could result in electric shock or fire.

CA-570 identification plate is located on the bottom.



Using any device other than the Compact Power Adapter CA-570 may damage the camcorder.

European Union (and EEA) only.

These symbols indicate that this product is not to be disposed of with your household waste, according to the WEEE Directive (2002/96/EC), the Battery Directive (2006/66/EC) and/or your national laws implementing those Directives.

This product should be handed over to a designated collection point, e.g., on an authorized one-for-one basis when you buy a new similar product or to an authorized collection site for recycling waste electrical and electronic equipment (EEE) and batteries and accumulators. Improper handling of this type of waste could have a possible impact on the environment and human health due to potentially hazardous substances that are generally associated with EEE. Your cooperation in the correct disposal of this product will contribute to the effective usage of natural resources.

For more information about the recycling of this product, please contact your local city office, waste authority, approved scheme or your household waste disposal service or visit www.canon-europe.com/environment. (EEA: Norway, Iceland and Liechtenstein)

Trademark Acknowledgements

- The SD logo is a trademark. The SDHC logo is a trademark.
- Microsoft, Windows and Windows Vista are trademarks or registered trademarks of Microsoft Corporation in the United States and/or other countries.
- Macintosh and Mac OS are trademarks of Apple Inc., registered in the U.S. and other countries.
- HDMI, the HDMI logo and High-Definition Multimedia Interface are trademarks or registered trademarks of HDMI Licensing LLC.
- "AVCHD" and the "AVCHD" logo are trademarks of Matsushita Electric Industrial Co., Ltd. and Sony Corporation.
- Manufactured under license from Dolby Laboratories.
"Dolby" and the double-D symbol are trademarks of Dolby Laboratories.
- Other names and products not mentioned above may be trademarks or registered trademarks of their respective companies.
- This product is licensed under AT&T patents for the MPEG-4 standard and may be used for encoding MPEG-4 compliant video and/or decoding MPEG-4 compliant video that was encoded only (1) for a personal and non-commercial purpose or (2) by a video provider licensed under the AT&T patents to provide MPEG-4 compliant video. No license is granted or implied for any other use for MPEG-4 standard.



Enjoying High-Definition Video with your Camcorder

Preserve your most treasured memories, be it unforgettable scenery or cherished moments spent with family and friends, with high-definition video recordings of a quality second only to actually being there.

What is High-Definition Video?



Your camcorder features a full high-definition image sensor (Full HD CMOS) that captures video at a resolution of 1,920 x 1,080 pixels¹. This results in video recordings of unparalleled high quality, fine detail and lifelike vivid colors.

How does full high definition compare with standard-definition TV broadcasts?



5 Approximately 5 times the number of pixels.

1.9 Almost 90% more scanning lines.

“Full HD 1080” refers to Canon camcorders compliant with high-definition video composed of 1,080 vertical pixels (scanning lines).



What is Cinema Mode?

Give your recordings a cinematic look by using the [ Cine Mode] recording program ( 45). Combine this recording program with the 25 fps progressive frame rate [ PF25] to get the enhanced effect of the 25p Cinema Mode.

¹ Video is recorded at this resolution only when the recording mode is set to MXP or FXP mode. In other recording modes, the picture is resized to 1,440 x 1,080 pixels before being recorded. Even in that case, the picture captured is detailed enough to render richly detailed recordings.

What are the advantages of a hard disk?

Your videos and photos are recorded on the built-in hard disk or commercially available SD/SDHC memory cards² using AVCHD specifications³. This Double Media recording system gives you longer recording times for more high-definition videos and photos.

- You can shoot approximately 11 hours (**HG21** 120 GB HDD) or 5.5 hours (**HG20** 60 GB HDD) of video in MXP mode, which offers the highest video quality under AVCHD specifications.
- The camcorder records video and photos in unused space on the recording media so you need not worry about accidentally recording over important videos.
- You can immediately access the scenes you want to play back from an index menu.
- You can easily manage your video and photo collections with the supplied editing software: **ImageMixer 3** (movies) and **DIGITAL VIDEO Solution Disk** (photos).

Can I play back my high-definition video on other devices?

Needless to say, you can connect your camcorder to an HDTV to enjoy your recordings with family and friends (□□ 79). You also have the following options:

- You can easily play back video recorded on the memory card by inserting the memory card directly into AVCHD-compatible TV sets and HDD or DVD recorders that feature an SD/SDHC memory card slot⁴. For details, refer to the instruction manual of your TV or digital video recorder.
- You can play back AVCHD discs of your recordings created using the optional DW-100 DVD Burner (□□ 80) on the DVD Burner itself or on AVCHD-compatible DVD players or Blu-ray Disc players⁵.

² For details about memory cards that can be used with this camcorder refer to *Using a Memory Card* (□□ 29).

³ AVCHD is the new standard for recording high-definition video. With AVCHD specifications the video signal is recorded using MPEG-4 AVC/H.264 compression and the audio signal is recorded in Dolby Digital.

⁴ Depending on the device used, correct playback may not be possible even if the device is AVCHD-compatible. In such case, play back the recordings on the memory card using the camcorder.

⁵ AVCHD discs containing scenes recorded in MXP mode cannot be created with the optional DW-100 DVD burner. Use the supplied software ImageMixer 3 to back up such scenes.

Important Notes About the Hard Disk Drive

Your hard disk camcorder allows you to shoot and store many hours of video. However, there are differences between recording onto a hard disk and recording onto other media. Make sure to follow the points below when using your camcorder. For more details, refer to *Handling Precautions* (□ 113).

Back up your recordings periodically

Make sure to transfer your movies and photos to an external device such as a computer or digital video recorder (□ 80) and back them up regularly and especially after making important recordings. Canon shall not be liable for any loss or corruption of data.

Do not subject the camcorder to vibrations or strong impacts

The hard disk is a high-precision device. Vibrations, strong impacts or dropping the camcorder may result in permanent data loss.

Keep the drop sensor activated whenever possible

The drop sensor (□ 96) detects when the camcorder is dropped and activates a protection mechanism to help prevent hard disk damage. Turning this function off will disable the mechanism. Even if this function is set to [ON On] and the camcorder is dropped, hard disk damage can occur.

Do not disconnect the power source while the camcorder is on

Always turn the camcorder off before removing the battery or compact power adapter.



Do not turn off the camcorder while the camcorder is on and the ACCESS indicator is on or flashing or while the camcorder is in standby mode

Doing so may result in hard disk damage or permanent data loss.

Use the camcorder within its operating temperature range

If the camcorder's temperature becomes too hot or too cold, recording/playback may stop in order to prevent hard disk damage.

Do not use the camcorder at high altitudes

Turning on or using the camcorder in places with low atmospheric pressure, such as at altitudes higher than 3,000 m, may result in hard disk damage.

Initialize the hard disk when movies cannot be recorded/played back normally

As movies are recorded and deleted over time, hard disk fragmentation may occur, which may reduce performance. Initialize the hard disk should this happen.

Protect personal information on the hard disk

When the hard disk is initialized or recordings are deleted, stored data is not physically erased. Remember this when disposing of the camcorder or giving it to another person.



Table of contents

■ Introduction

- 4 Enjoying High-Definition Video with your Camcorder
- 6 Important Notes About the Hard Disk Drive
- 12 About this Manual
- 14 Getting to Know the Camcorder**
- 14 Supplied Accessories
- 15 Components Guide
- 18 Screen Displays

■ Preparations

- 21 Getting Started**
- 21 Charging the Battery Pack
- 22 Preparing the Wireless Controller and Accessories
- 24 Adjusting the Position and Brightness of the LCD Screen
- 25 Basic Operation of the Camcorder**
- 25 The **EASY** Button: **EASY** Mode or Flexible Recording
- 26 Joystick and Joystick Guide
- 26 Using the Menus
- 28 First Time Settings**
- 28 Setting the Date and Time
- 28 Changing the Language
- 29 Changing the Time Zone
- 29 Using a Memory Card**
- 29 Memory Cards Compatible for Use with the Camcorder
- 30 Inserting and Removing a Memory Card
- 31 Selecting the Recording Media
- 31 Initializing the Hard Disk or Memory Card

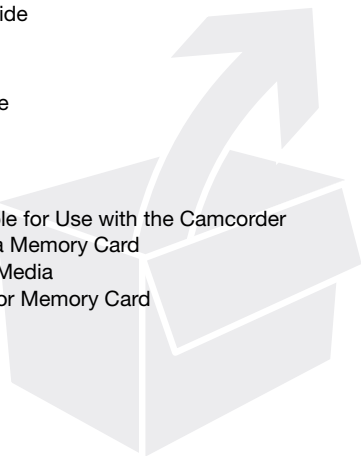

■ Video

32 Basic Recording

- 32 Shooting Video
- 33 Selecting the Video Quality (Recording Mode)
- 34 Zooming
- 35 Quick Start Function
- 35 Reviewing and Deleting the Last Scene Recorded

36 Basic Playback

- 36 Playing Back the Video
- 38 Changing the Index Screen Selection
- 39 Selecting Scenes by Recording Date
- 40 Selecting the Playback Starting Point from the Movie Timeline
- 41 Selecting Recordings from the Index Screen
- 42 Deleting Scenes

43 Advanced Functions

- 43 Special Scene Recording Programs
- 44 Changing the Shutter Speed and Aperture
- 45 Cinema Mode: Giving a Cinematic Look to your Recordings
- 46 Self Timer
- 46 Manual Exposure Adjustment and Automatic Backlight Correction
- 47 Manual Focus Adjustment
- 48 White Balance
- 49 Image Effects
- 50 Digital Effects
- 51 On-Screen Displays and Data Code
- 51 Audio Recording Level
- 52 Using Headphones
- 53 Using the Mini Advanced Shoe
- 54 Using an External Microphone
- 55 Using a Video Light

55 Playlist and Scene Operations

- 55 Dividing Scenes
- 56 Editing the Playlist: Adding, Moving and Deleting Playlist Scenes
- 58 Copying Scenes

■ Photos

59 Basic Recording

- 59 Taking Photos
- 60 Selecting Photo Size and Quality
- 61 Deleting a Photo Right After Recording It

61 Basic Playback

- 61 Viewing Photos
- 63 Deleting Photos

64 Additional Functions

- 64 Magnifying Photos during Playback
- 64 Flash
- 65 Histogram Display
- 65 Drive Mode: Continuous Shooting and Exposure Bracketing
- 66 Taking Photos while Recording Movies (Simultaneous Recording)
- 67 Light Metering Mode
- 67 Capturing a Photo from the Playback Scene
- 68 Protecting Photos
- 68 Copying Photos
- 69 Other Functions You Can Use when Taking Photos

70 Printing Photos

- 70 Printing Photos (Direct Print)
- 71 Selecting the Print Settings
- 73 Trimming Settings
- 74 Print Orders

■ External Connections

76 Terminals on the Camcorder

- 77 Connection Diagrams
- 79 Playback on a TV Screen

80 Saving and Backing Up Your Recordings

- 80 Backing Up Your Recordings on a Computer
- 80 Authoring High-Definition (AVCHD) Discs and Photo DVDs
- 84 Copying your Recordings to an External Video Recorder
- 84 Transferring Photos to a Computer (Direct Transfer)
- 87 Transfer Orders

■ Additional Information

88 Appendix: Menu Options Lists

88 FUNC. Menu

90 Setup Menus

98 Trouble?

98 Troubleshooting

104 List of Messages

113 Do's and Don'ts

113 Handling Precautions

117 Maintenance/Others

118 Using the Camcorder Abroad

119 General Information

119 System Diagram

120 Optional Accessories

124 Specifications





126 Index



About this Manual



Thank you for purchasing the Canon HG21/HG20. Please read this manual carefully before you use the camcorder and retain it for future reference. Should your camcorder fail to operate correctly, refer to *Troubleshooting* (□ 98).

Conventions Used in this Manual

-  **IMPORTANT:** Precautions related to the camcorder's operation.
-  **NOTES:** Additional topics that complement the basic operating procedures.
-  **POINTS TO CHECK:** Restrictions or requirements regarding the function described.
-  Reference page number within this manual.

To complete some operations you will need to refer also to other instruction manuals. This will be indicated with the following icons:

-  Refer to the "Digital Video Software" instruction manual, included as a PDF file in the supplied **DIGITAL VIDEO Solution Disk** CD-ROM.
-  Refer to the instruction manual of the optional DW-100 DVD Burner.

-  : Text that applies only to the model shown in the icon.
- The following terms are used in this manual:
 - “Screen” refers to the LCD and the viewfinder screen ( only).
 - “Hard disk” and “HDD” are used interchangeably to refer to the camcorder's built-in hard disk drive.
 - “Media” is used to refer collectively to either the built-in hard disk or an external memory card.
- The photos included in this manual are simulated pictures taken with a still camera. Unless indicated otherwise, illustrations and menu icons refer to the .

Names of buttons and switches other than the joystick are indicated within a “button” frame.



For example FUNC..

Brackets [] are used to refer to menu options as they are displayed on screen. In tables in this manual the default value is shown in boldface.

For example **[On]**, [Off].







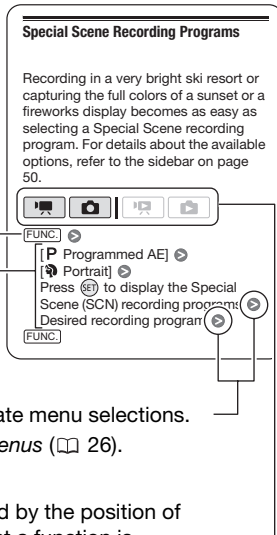

In this manual, the  arrow is used to abbreviate menu selections.

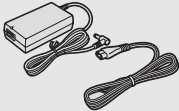
For a detailed explanation refer to *Using the Menus* (📖 26).

The camcorder's operating mode is determined by the position of the mode dial. In this manual,  indicates that a function is available and  indicates that the function is not available. When no operating mode icons are given, the function is available in all operating modes.

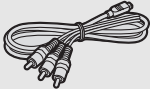

Supplied Accessories

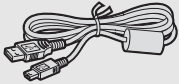
| | | | |
|--|---|---|---|
|  | <p>CA-570 Compact Power Adapter (incl. power cord)</p> |  | <p>BP-807 Battery Pack</p> |
| <p>WL-D88 Wireless Controller</p> |  | <p>Lithium Button Battery CR2025 for Wireless Controller</p> |  |
|  | <p>CTC-100/S Component Cable Red • Green • Blue plugs</p> |  | <p>Software CD-ROM¹ and Installation Guide PIXELA ImageMixer 3 SE</p> |
| <p>STV-250N Stereo Video Cable Yellow • Red • White plugs</p> |  | <p>Software CD-ROM² DIGITAL VIDEO Solution Disk</p> |  |
|  | <p>IFC-400PCU USB Cable</p> | | |

¹ Software for saving, managing, editing and playing back movies on your computer (□ 80). The CD-ROM includes the instruction manual of the software (electronic version on PDF file).

² Software for saving, managing, retouching and printing photos (□ 84). The CD-ROM includes the instruction manual of the software (electronic version on PDF file).

Components Guide

Left side view

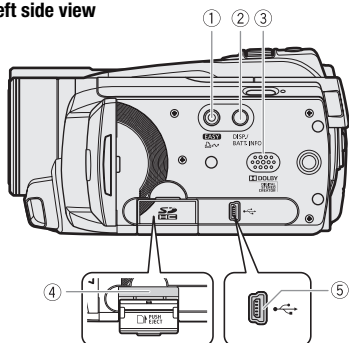

- ① **EASY** button (☞ 25)/
☞ (print/share) button (☞ 71, 84)
- ② **DISP.** (on-screen display) button
(☞ 40, 51)/
BATT. INFO button (☞ 20)
- ③ **Speaker** (☞ 37)
- ④ **Memory card slot** (☞ 30)
- ⑤ **USB terminal** (☞ 78)
- ⑥ **HDMI OUT terminal** (☞ 77, 79)
- ⑦ **AV OUT**/☞ terminal (☞ 77)
- ⑧ **COMPONENT OUT** terminal (☞ 77)
- ⑨ **MIC** terminal (☞ 54)
- ⑩ **Strap mount** (☞ 23)
- ⑪ **Grip belt**
- ⑫ **Instant AF sensor** (☞ 91)
- ⑬ **Flash** (☞ 64)
- ⑭ **Stereo microphone**

Right side view

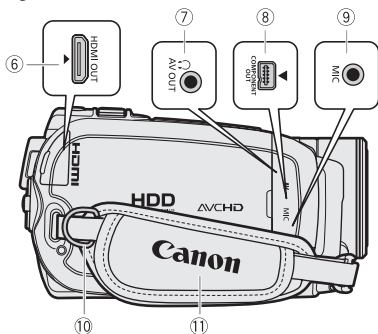

Front view

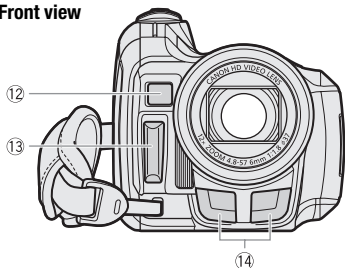

Back view

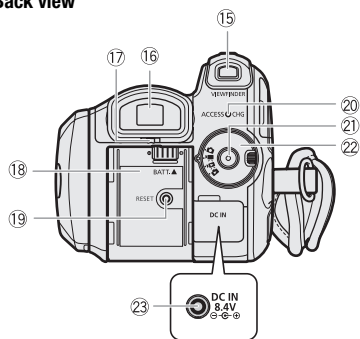

LCD panel

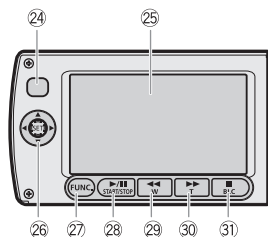

Top view

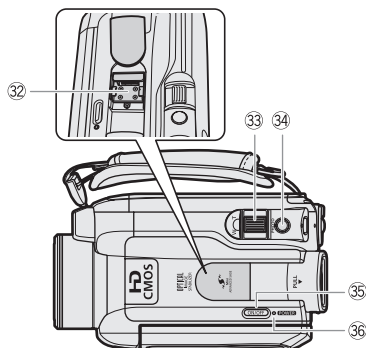

- 15 VIEWFINDER button* (□ 33)
- 16 Viewfinder* (□ 24, 33)
- 17 Dioptic adjustment lever* (□ 33)
- 18 Battery attachment unit (□ 21)
- 19 RESET button (□ 101)
- 20 ACCESS indicator (□ 32, 59)/
CHG (charge) indicator (□ 21)
- 21 Start/Stop button (□ 32)
- 22 Mode dial
 - ▶ Recording movies (□ 32)
 - ▶ Taking photos (□ 59)
 - ▶ Playing back movies (□ 36)
 - ▶ Viewing photos (□ 61)
- 23 DC IN terminal (□ 21)
- 24 Remote sensor (□ 23)
- 25 LCD screen (□ 24)
- 26 Joystick (□ 26)
- 27 FUNC. button (□ 26, 88)
- 28 ▶ / || (play/pause) button (□ 36)/
START/STOP button (□ 32)
- 29 ◀◀ (fast reverse) button (□ 36)/
Zoom out **W** (wide-angle) button (□ 34)
- 30 ▶▶ (fast forward) button (□ 36)/
Zoom in **T** (telephoto) button (□ 34)
- 31 ■ (stop) button (□ 36)/
BLC (backlight correction) button (□ 46)
- 32 Mini advanced shoe (□ 53)
- 33 Zoom lever (□ 34)
- 34 PHOTO button (□ 59)
- 35 ON/OFF button
- 36 **POWER** indicator

* **HG21** only.

Bottom view

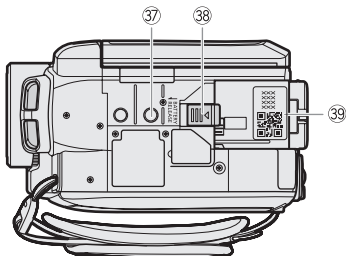

- 37 Tripod socket (□ 114)
- 38 BATTERY RELEASE switch (□ 22)
- 39 **Serial number**

The serial number label is located on the top surface of the battery attachment unit. Remove the battery pack to find it.

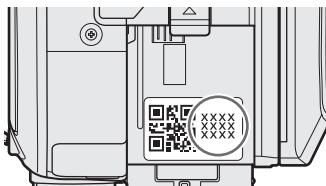

Wireless Controller WL-D88

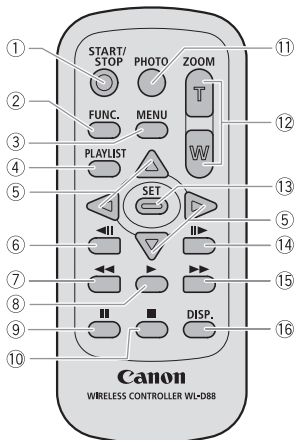

- 1 START/STOP button (□ 32)
- 2 FUNC. button (□ 26, 88)
- 3 MENU button (□ 27, 90)
- 4 PLAYLIST button (□ 56)
- 5 Navigation buttons (▲/▼/◀/▶)
- 6 ◀◀ (frame reverse) button (□ 37)
- 7 ◀◀ (fast reverse) button (□ 37)
- 8 ▶ (play) button (□ 36)
- 9 || (pause) button (□ 36)
- 10 ■ (stop) button (□ 36)
- 11 PHOTO button (□ 59)
- 12 Zoom buttons (□ 34)
- 13 SET button
- 14 ▶▶ (frame advance) button (□ 37)
- 15 ▶▶ (fast forward) button (□ 37)
- 16 DISP. (on-screen display) button (□ 40, 51)

Screen Displays

Recording Movies

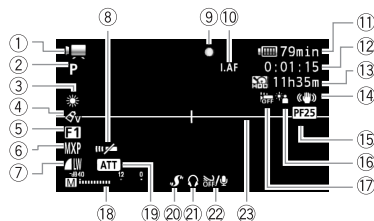

Playing Movies (During Playback)



- ① Operating mode
- ② Recording program (□ 43, 44)
- ③ White balance (□ 48)
- ④ Image effect (□ 49)
- ⑤ Digital effect (□ 50)
- ⑥ Recording mode (□ 33)
- ⑦ Photo quality/size (simultaneous recording) (□ 66)
- ⑧ Remote sensor off (□ 95)
- ⑨ Hard disk/memory card operation (□ 20)
- ⑩ **I.A.F.** Instant AF (□ 91), MF Manual focus (□ 47)
- ⑪ Remaining battery time (□ 20)
- ⑫ While recording/during playback:
Scene counter (hours : minutes : seconds)
Record pause mode: Total number of scenes
- ⑬ Remaining recording time
 On the hard disk
 On the memory card
- ⑭ Image stabilizer (□ 92)
- ⑮ 25F progressive frame rate (□ 20)
- ⑯ Backlight correction (□ 47)
- ⑰ Drop sensor off (□ 96)
- ⑱ Audio level indicator (□ 51)
- ⑲ Microphone attenuator (□ 92)
- ⑳ Mini advanced shoe (□ 53)
- ㉑ Headphone output (□ 52)
- ㉒ Wind screen off (□ 92)
- ㉓ Level marker (□ 91)
- ㉔ Scene number
- ㉕ Data code (□ 51)

Recording Photos

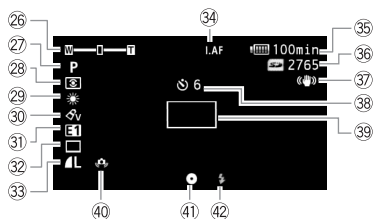

Viewing Photos

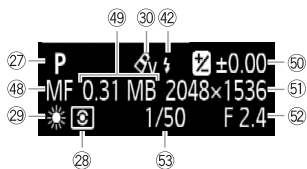
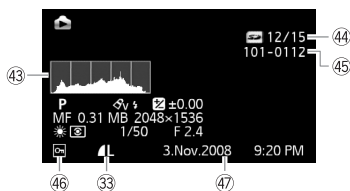

- 26 Zoom (□ 34), Exposure (●—|—○ (□ 46)
- 27 Recording program (□ 43, 44)
- 28 Light metering mode (□ 67)
- 29 White balance (□ 48)
- 30 Image effect (□ 49)
- 31 Digital effect (□ 50)
- 32 Drive mode (□ 65)
- 33 Photo quality/size (□ 60)
- 34 **I.A.F** Instant AF (□ 91), MF Manual focus (□ 47)
- 35 Remaining battery time (□ 20)
- 36 Number of available photos
 - On the hard disk
 - On the memory card
- 37 Image stabilizer (□ 92)
- 38 Self timer (□ 46)
- 39 AF frame (□ 92)
- 40 Camcorder shake warning (□ 92)
- 41 Focus and exposure lock (□ 59)
- 42 Flash (□ 64)
- 43 Histogram (□ 65)
- 44 Current photo / Total number of photos
- 45 Photo number (□ 96)
- 46 Protected photo mark (□ 68)
- 47 Date and time of recording
- 48 Manual focus (□ 47)
- 49 File size
- 50 Manual exposure (□ 46)
- 51 Photo size (□ 60)
- 52 Aperture value (□ 44)
- 53 Shutter speed (□ 44)

⑨ Hard disk/memory card operation

- Record, ● ||| Record pause,
- ▶ Playback, ||| Playback pause,
- ▶▶ Fast playback,
- ◀◀ Fast reverse playback,
- ▶ Slow playback,
- ◀ Slow reverse playback,
- ||| Frame advance,
- ◀||| Frame reverse

⑪, 35 Remaining battery time

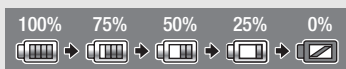

- The icon shows a rough estimate of the remaining charge as a percentage of the full charge of the battery pack. The remaining recording/playback time of the battery pack is displayed, in minutes, next to the icon.
- When is displayed in red, replace the battery pack with a fully charged one.
- When you attach an empty battery pack, the power may turn off without displaying .
- Depending on the conditions under which the camcorder and the battery pack are used, the actual battery charge may not be indicated accurately.
- When the camcorder is off, press **BATT.INFO** to display the charge status of a battery pack. The Intelligent System will display the charge status (as a percentage) and the remaining recording time (in minutes) for 5 seconds. If the battery pack is exhausted, the battery information may not be displayed.

13 Remaining recording time

When there is no more free space on the recording media, “ END” (built-in hard disk) or “ END” (memory card) will be displayed and the recording will stop.

15 25F progressive frame rate

Select the 25F progressive frame rate (45) to give your recordings a cinematic look. You can combine this frame rate with the [Cine Mode] recording program to enhance the effect.

36 Number of available photos

in red: No card

in green: 6 or more photos

in yellow: 1 to 5 photos

in red: No more photos can be recorded

- When viewing the photos, the display will always be in green.
- Depending on the recording conditions, the number of available photos displayed may not decrease even after a recording has been made, or may decrease by 2 photos at once.

45 Photo number

The photo number indicates the name and location of the file on the memory card. For example, the file name of a photo numbered 101-0107 is “IMG_0107.JPG”, stored under the folder “DCIM\101CANON”.



Preparations

This chapter describes basic operations, such as navigating the menus, and first time settings to help you learn more about your camcorder.

Getting Started

Charging the Battery Pack

The camcorder can be powered with a battery pack or directly using the compact power adapter. Charge the battery pack before use.

For approximate charging times and recording/playback times with a full battery pack, refer to the tables on pages 120-121.

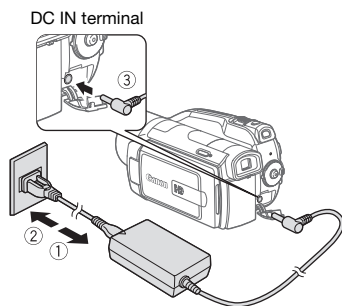

- 1 Connect the power cord to the compact power adapter.
- 2 Plug the power cord into a power outlet.

- 3 Connect the compact power adapter to the camcorder's DC IN terminal.

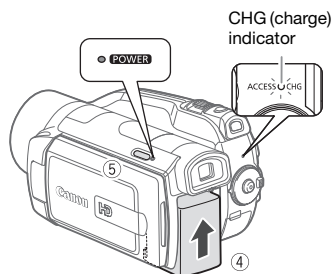

- 4 Attach the battery pack to the camcorder.

Press the battery pack softly into the battery attachment unit and slide it up until it clicks in place.

- 5 Charging will start when the camcorder is turned off (the **POWER** indicator is off).

- The CHG (charge) indicator starts flashing. The indicator will stay on when the charging is completed.
- If the indicator flashes quickly, refer to *Troubleshooting* (□ 98).

TO REMOVE THE BATTERY PACK

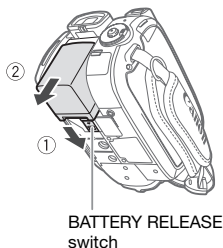

- 1 Slide **BATTERY RELEASE** in the direction of the arrow and hold it pressed down.
- 2 Slide the battery pack down and then pull it out.

! IMPORTANT

- Turn off the camcorder before connecting or disconnecting the compact power adapter. After pressing **ON/OFF** to turn off the camcorder, important data is updated on the hard disk. Be sure to wait until the **POWER** indicator turns off.
- We recommend charging the battery pack in temperatures between 10 °C and 30 °C. Outside the temperature range of 0 °C to 40 °C, charging will not start.
- Do not connect to the camcorder's DC IN terminal or to the compact power adapter any electrical equipment that is not expressly recommended for use with this camcorder.
- To prevent equipment breakdowns and excessive heating, do not connect the supplied compact power adapter to voltage converters for overseas travels or special power sources such as those

on aircraft and ships, DC-AC inverters, etc.

i NOTES

- The battery pack will be charged only when the camcorder is off.
- If remaining battery time is an issue, you can power the camcorder using the compact power adapter so the battery pack will not be consumed.
- Charged battery packs continue to discharge naturally. Therefore, charge them on the day of use, or the day before, to ensure a full charge.
- We recommend that you prepare battery packs to last 2 to 3 times longer than you think you might need.

Preparing the Wireless Controller and Accessories

First, insert the supplied lithium button battery CR2025 into the wireless controller.

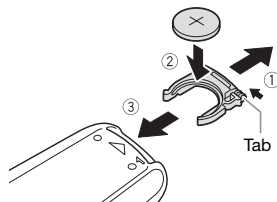

- 1 Press the tab in the direction of the arrow and pull out the battery holder.
- 2 Place the lithium button battery with the + side facing up.
- 3 Insert the battery holder.



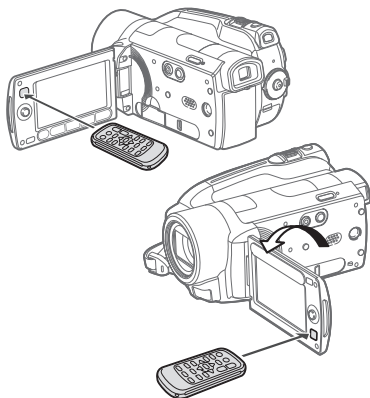

TO USE THE WIRELESS CONTROLLER



Point the wireless controller at the camcorder's remote sensor when you press the buttons.

You can rotate the LCD panel 180 degrees to use the wireless controller from the front of the camcorder.

i NOTES

- The wireless controller may not work properly when the remote sensor is situated under strong light sources or direct sunlight.
- If the wireless controller does not work, check that  [Wireless Remote Control] is not set to [OFF Off ] ( 95). Otherwise, replace the battery.

Accessories

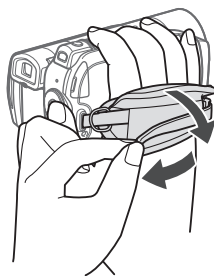

Fasten the grip belt.

Adjust the grip belt so that you can reach the zoom lever with your index finger, and the **[Start/Stop]** button with your thumb.

TO ATTACH A SHOULDER STRAP

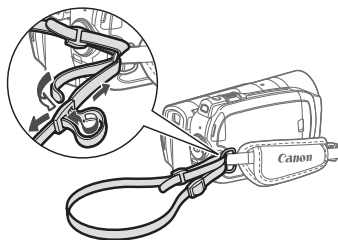

Pass the ends of the shoulder strap through the strap mount on the grip belt and adjust the length of the strap.

Adjusting the Position and Brightness of the LCD Screen

Rotating the LCD Panel

Open the LCD panel 90 degrees.

- You can rotate the panel 90 degrees downward.
- You can rotate the panel 180 degrees toward the lens. Rotating the LCD panel 180 degrees can be useful in the following cases:

- **HG21** To allow the subject to monitor the LCD screen while you use the viewfinder.
- To include yourself in the picture when recording with the self timer.
- To allow the camcorder to be operated with the wireless controller from the front.

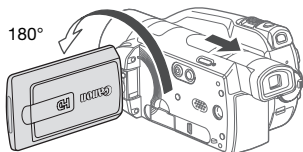
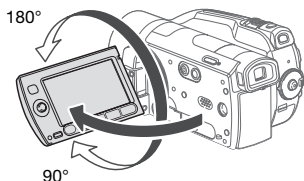

HG21 Subject can monitor the LCD screen while you use the viewfinder

i NOTES

About the LCD and viewfinder* screen: The screens are produced using extremely high-precision manufacturing techniques, with more than 99.99% of the pixels operating to specification. Less than 0.01% of the pixels may occasionally misfire or appear as black, red, blue or green dots. This has no effect on the recorded image and does not constitute a malfunction.

* **HG21** only.

LCD Backlight

You can set the brightness of the screen to normal or bright. This changes the brightness of both the LCD and viewfinder* screen.

* **HG21** only.

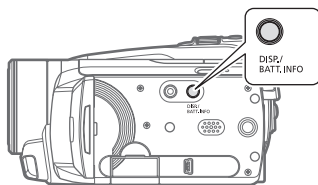

Hold **DISP.** pressed down for more than 2 seconds.

Repeat this action to toggle between the normal and bright settings.

i NOTES

- This setting does not affect the brightness of the recording.
- Using the bright setting will shorten the effective usage time of the battery pack.



Basic Operation of the Camcorder

The **EASY** Button: **EASY** Mode or Flexible Recording

The camcorder offers two basic modes for recording video or photos: **EASY** mode for beginners or if you just prefer not to bother with detailed camcorder settings, and **flexible recording** mode which lets you change the camcorder's settings to your preference.

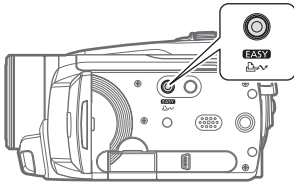

EASY MODE

Press the **EASY** button to enter the **EASY** mode (the button's blue light will be on). You do not need to worry about any settings and can shoot video using just the zoom lever (□ 34) and **[Start/Stop]** (□ 32) or take photos using just the zoom lever and **[PHOTO]** (□ 59). The viewfinder (**HG21** only) and Quick Start function can also be used in **EASY** mode.

FLEXIBLE RECORDING

Press the **EASY** button again to return to the flexible recording mode (the button's light is off). You can access the menus and change settings to your preference. Even in flexible recording mode, the camcorder can help you with the settings. For example, you can use the Special Scene recording programs (□ 43) to set at once all the optimal settings to match special recording conditions.

i NOTES

In **EASY** mode you cannot access the menus but you can change the following settings in advance, before setting the camcorder to **EASY** mode.

- Recording mode of movies
- Size/quality of photos
- Auto slow shutter
- All settings under the setup menu's **[P]**, **[F]** and **[M]** tabs.

Joystick and Joystick Guide

Use the joystick to operate the camcorder's menus.

Push the joystick up, down, left or right (▲▼, ◀▶) to select an item or change settings.



Press the joystick itself (SET) to save the settings or confirm an action. On menu screens, this is indicated by the icon (SET).

Press (SET) to display/hide the joystick guide. The functions that appear on the joystick guide will change depending on the operating mode.

Using the Menus

Many of the camcorder's functions can be adjusted from the menus that open after pressing the FUNC. button (FUNC.). To access the menu set the camcorder to flexible recording mode. In EASY mode, except for a few exceptions, most menu settings will return to their default values (□ 25). For details about the available menu options and settings, refer to the appendix *Menu Options Lists* (□ 88).

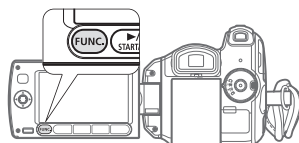

Selecting a FUNC. Menu Option

Following is an example of selecting a FUNC. menu option in a recording mode.

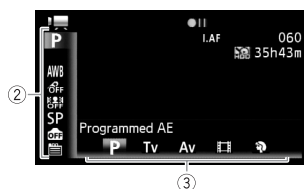

- 1 Press (FUNC.).
- 2 Select (▲▼) the icon of the function you want to change from the left side column.
Menu items not available will appear grayed out.
- 3 Select (◀▶) the desired setting from the available options at the bottom bar.
 - The selected option will be highlighted in orange.
 - With some settings you will need to make further selections and/or press (SET). Follow the additional operation guides that will appear on the screen (such as the (SET) icon, small arrows, etc.).
- 4 Press (FUNC.) to save the settings and close the menu.
You can press (FUNC.) to close the menu at any time.



Selecting an Option from the Setup Menus



i NOTES

A small font size is used in menu screens so you can see all options and current settings in one screen. You can enlarge the font size by setting [Font Size] to [Large] but you may have to scroll down to find some menu options and only the icons of the current settings will be displayed.

- 1 Press [FUNC.].
- 2 Select (▲▼, ◀▶) the  icon and press (SET) to open the setup menus.
You can also hold [FUNC.] pressed down for more than 1 second or press [MENU] on the wireless controller to open directly the setup menu screen.
- 3 Select (◀▶) the tab of the desired menu.
The settings available will change as you move between the menu tabs.
- 4 Select (▲▼) the setting you want to change and press (SET).
 - The orange selection bar indicates the menu setting currently selected. Menu items not available appear grayed out.
 - Move (▲▼) the orange selection bar to the tabs at the top of the screen to select a different menu (step 3).
- 5 Select (▲▼) the desired option and press (SET) to save the setting.
- 6 Press [FUNC.].
You can press [FUNC.] to close the menu at any time.

First Time Settings

Setting the Date and Time

You will need to set the date and time of the camcorder before you can start using it. The [Date/Time] screen will appear automatically when the camcorder's clock is not set.

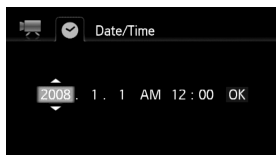

When the [Date/Time] screen appears, the year will be displayed in orange and indicated with up/down arrows.

- 1 Change (▲▼) the year and move (▶) to the month.
- 2 Change the rest of the fields (month, day, hour and minutes) in the same way.
- 3 Select (▶) [OK] and press (SET) to start the clock and close the setup screen.

! IMPORTANT

- When you do not use the camcorder for about 3 months, the built-in rechargeable lithium battery may discharge completely and the date and time setting may be lost. In such case, recharge the built-in lithium battery (□ 116) and set the time zone, date and time again.

- The date appears in a year-month-day format only in the first setup screen. In subsequent screen displays the date and time will appear as day-month-year (for example, [1.Jan.2008 12:00 AM]). You can change the date format (□ 97).
- You can also change the date and time later on (not during the initial setup). Open the [Date/Time] screen from the setup menu:

[FUNC.] (▶) [Menu] (▶)
 (▶) (▶) [Date/Time]

Changing the Language

Options

♦ Default value

| | | |
|-------------------|--------------|-----------|
| [ČEŠTINA] | [MAGYAR] | [العربية] |
| [DEUTSCH] | [MELAYU] | [فارسی] |
| [ΕΛΛΗΝΙΚΑ] | [POLSKI] | [ไทย] |
| [ENGLISH]♦ | [ROMÂNĂ] | [简体中文] |
| [ESPAÑOL] | [TÜRKÇE] | [繁體中文] |
| [FRANÇAIS] | [РУССКИЙ] | [한국어] |
| [ITALIANO] | [УКРАЇНСЬКА] | [日本語] |

[FUNC.] (▶)
 [Menu] (▶) (▶)
 [Language] (▶)
 Desired language (▶)
 [FUNC.]

i NOTES

The displays (SET) and (FUNC) that appear in some menu screens refer to the name of buttons on the camcorder and will not change, regardless of the language selected.



Changing the Time Zone

Change the time zone to match your location. The default setting is Paris.

TO SET THE HOME TIME ZONE





WHEN YOU TRAVEL



* To adjust for daylight saving time, select the area name marked with a .

Using a Memory Card



Memory Cards Compatible for Use with the Camcorder

You can use commercially available  SDHC (SD high capacity) memory cards and  SD memory cards with this camcorder. However, depending on its Speed Class, you may not be able to record movies on the memory card. Refer to the table on page 30.

As of June 2008, the movie recording function has been tested using SD/SDHC memory cards made by Panasonic, Toshiba and SanDisk. We recommend using memory cards with a Speed Class 4 or higher.

NOTES

About the SD Speed Class: The SD Speed Class is a standard that indicates the minimum guaranteed data transfer speed of SD/SDHC memory cards. When you buy a new memory card, look for the Speed Class logo on the package.

| Memory card | Capacity | SD Speed Class | Recording movies | Recording photos |
|--|----------------|------------------|------------------|------------------|
|  SD memory cards | 64 MB or less | Not applicable | – | ● |
| | 128 MB or more | Not compatible | ● ^{1,2} | |
| | | CLASS② | ● ¹ | |
| CLASS④ or higher | ● | | | |
|  SDHC memory cards | Over 2 GB | CLASS② | ● ¹ | |
| | | CLASS④ or higher | ● | |

¹ Movies cannot be recorded when the recording mode is set to MXP (24 Mbps) or FXP (17 Mbps).

² On some memory cards you may not be able to record movies at all.

Inserting and Removing a Memory Card

Make sure to initialize all memory cards before using them with this camcorder (□ 31).

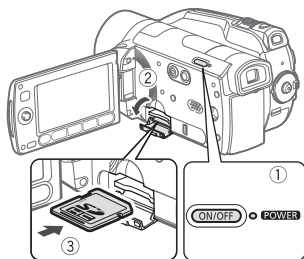

1 Turn off the camcorder.

Make sure the **POWER** indicator is off.

2 Open the memory card slot cover.

3 Insert the memory card straight, with the label facing up, all the way into the memory card slot until it clicks.

4 Close the memory card slot cover.

Do not force the cover closed if the memory card is not correctly inserted.

! IMPORTANT

Memory cards have front and back sides that are not interchangeable. Inserting a memory card facing the wrong direction can cause a malfunction of the camcorder.

i NOTES

To remove the memory card: Push the memory card once to release it. When the memory card springs out, pull it all the way out.



Selecting the Recording Media

You can select to record your movies and photos on the built-in hard disk or on a memory card. The hard disk is the default media for recording both.



TO CHANGE THE MEDIA FOR RECORDING MOVIES

FUNC.

Menu or
[Rec Media for Movies] or
[Rec Media for Photos] Select
the hard disk or memory card*

FUNC.

* For each media, you can check the total, used and available space. Available space is estimated based on the recording mode (movies) or photo size/quality (photos) currently in use.

Initializing the Hard Disk or Memory Card

Initialize memory cards when you use them with this camcorder for the first time. You can also initialize a memory card or the hard disk to permanently delete all the recordings it contains. Initializing the recording media also eliminates fragmentation. Fragmentation becomes more serious as recordings are repeatedly added and deleted and can eventually result in reduced performance.

Options

[Quick Initialization]

Clears the file allocation table but does not physically erase the stored data.

[Complete Initialization]

Erases all data completely. The complete initialization of the hard disk requires a longer time (**HG21** approx. 2 hr., **HG20** approx. 1 hr.).

FUNC.

Menu
[Initialize /]
[HDD] or [Mem. Card]
Initialization method
[Yes]* [OK]

FUNC.

* Press to cancel the complete initialization while it is in progress. All recordings will be erased and the recording media can be used without any problem.

IMPORTANT

- Initializing the recording media will permanently erase all recordings. Lost original recordings cannot be recovered. Make sure you back up important recordings in advance using an external device (80).
- Power the camcorder using the compact power adapter to initialize the hard disk. While the initialization is in progress, do not disconnect the power source.



Video

This chapter covers functions related to shooting movies, including recording, playback, menu options and playlist and scene operations.

Basic Recording

Shooting Video

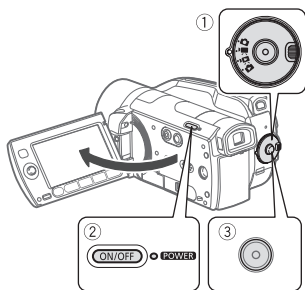



1 Set the mode dial to .

2 Turn on the camcorder.

By default, movies are recorded on the hard disk. You can also set the memory card as the recording media for movies ( 31).

3 Press  to begin recording.

- Recording starts; press  again to pause the recording.
- You can also press  on the LCD panel.



WHEN YOU HAVE FINISHED RECORDING

- 1 Make sure that the ACCESS indicator is off.**
- 2 Turn off the camcorder.**
- 3 Close the LCD panel.**

! IMPORTANT

- Observe the following precautions while the ACCESS indicator is on or flashing. Failing to do so may result in permanent data loss or damage to the hard disk/memory card.
 - Do not subject the camcorder to vibrations or strong impacts.
 - Do not open the memory card slot cover.
 - Do not disconnect the power source or turn off the camcorder.
 - Do not change the position of the mode dial.
- Be sure to back up your recordings regularly ( 80), especially after making important recordings. Canon shall not be liable for any loss or corruption of data.

i NOTES

- **About the Power Save mode:** To save power when the camcorder is powered by a battery pack, the camcorder will automatically shut off if left without any operations for 5 minutes ( 95). Press  to turn on the camcorder.



- When recording in very loud places (such as fireworks shows or concerts), sound may become distorted or it may not be recorded at the actual levels. This is not a malfunction.

HG21 Using the Viewfinder

When recording in bright places it may be difficult to use the LCD screen. In such case, change the brightness of the LCD screen* (□ 24) or use the viewfinder instead. Press **VIEWFINDER** to activate the viewfinder along with the LCD panel. Close the LCD panel to use only the viewfinder.

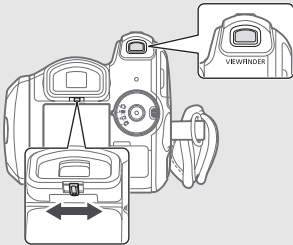

- You can pull out the viewfinder if it is more convenient. Hold out both sides of the viewfinder firmly and pull it out until it clicks.
 - Adjust the viewfinder as necessary with the dioptic adjustment lever.
- * The brightness setting is common to the LCD screen and the viewfinder.

Selecting the Video Quality (Recording Mode)

The camcorder offers 5 recording modes. Changing the recording mode will change the recording time available. Select MXP or FXP mode for better movie quality; select LP mode for longer recording times. The table on page 34 gives approximate recording times.



FUNC.

[SP Standard Play 7 Mbps]
Desired recording mode

FUNC.

i NOTES

- AVCHD discs containing scenes recorded in MXP mode cannot be created with the optional DW-100 DVD burner. Use the supplied software ImageMixer 3 to back up such scenes.
- The camcorder uses a variable bit rate (VBR) to encode video so the actual recording times will vary depending on the content of the scenes.
- The camcorder retains the last setting used even if you set the camcorder to **EASY** mode.

Approximate recording times

♦ Default value

| Recording mode → | MXP* | FXP* | XP+ | SP♦ | LP |
|------------------------------|---------------|----------------|----------------|---------------|----------------|
| Recording media ↓ | | | | | |
| HG20 60 GB Hard disk | 5 hr. 30 min. | 7 hr. 50 min. | 10 hr. 50 min. | 18 hr. | 22 hr. 55 min. |
| HG21 120 GB Hard disk | 11 hr. 5 min. | 15 hr. 45 min. | 21 hr. 40 min. | 36 hr. | 45 hr. 55 min. |
| 4 GB Memory card | 20 min. | 30 min. | 40 min. | 1 hr. 10 min. | 1 hr. 30 min. |
| 8 GB Memory card | 40 min. | 1 hr. | 1 hr. 25 min. | 2 hr. 20 min. | 3 hr. |
| 16 GB Memory card | 1 hr. 25 min. | 2 hr. 5 min. | 2 hr. 50 min. | 4 hr. 45 min. | 6 hr. 5 min. |
| 32 GB Memory card | 2 hr. 55 min. | 4 hr. 10 min. | 5 hr. 45 min. | 9 hr. 35 min. | 12 hr. 15 min. |

* Recorded in 1,920 x 1,080 resolution. Movies recorded using other recording modes are recorded in 1,440 x 1,080 resolution.

Zooming



mode: In addition to the optical zoom, digital zoom is also available (91).

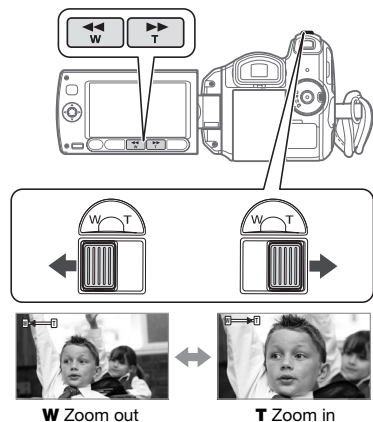

12x Optical Zoom

Move the zoom lever toward **W to zoom out (wide angle). Move it toward **T** to zoom in (telephoto).**

Press gently for a slow zoom; press harder for faster zooms. You can also set [Zoom Speed] (91) to one of three constant speeds (3 is the fastest, 1 the slowest).

NOTES

- Keep at least 1 m away from the subject. At full wide angle, you can focus on a subject as close as 1 cm.
- When [Zoom Speed] is set to [**VAR** Variable]:
 - When you use the **T** and **W** buttons on the wireless controller or LCD panel, the zoom speed will be constant at [Speed 3].
 - The zoom speed will be faster in record pause mode than when actually recording.



Quick Start Function

When you close the LCD panel with the camcorder on, the camcorder enters the standby mode. In standby mode the camcorder consumes only about half the power used when recording, saving energy when you are using a battery pack. Additionally, when you open the LCD panel, the camcorder is ready to start recording in approximately 1 second*, ensuring you do not miss important shooting opportunities.

* The actual time required varies depending on the shooting conditions.



1 With the camcorder on and in a recording mode, close the LCD panel.

- **HG21** If you are using the viewfinder and the LCD panel is closed, press **VIEWFINDER** to enter the standby mode.
- A beep will sound and the **POWER** indicator will change to orange to indicate the camcorder entered the standby mode.

2 When you wish to resume recording, open the LCD panel.

- The **POWER** indicator turns back green and the camcorder is ready to record.
- **HG21** You can also press **VIEWFINDER** to resume recording using the viewfinder with the LCD panel closed.

! IMPORTANT

Do not disconnect the power source during standby mode (while the **POWER** indicator is lit in orange).

i NOTES

- If you close the LCD panel under some circumstances (for example, while the **ACCESS** indicator is flashing or a menu is being displayed), the camcorder may not enter standby mode. Check that the **POWER** indicator changes to orange.
- The camcorder will shut off if left in standby mode for 10 minutes, regardless of the **Power Saving Mode** setting (□ 95). Press **ON/OFF** to turn on the camcorder.
- You can select the length of time until shut-off or turn off the Quick Start function altogether with the **Quick Start** setting (□ 96).
- Changing the position of the mode dial while the camcorder is in standby mode will reactivate the camcorder in the operating mode selected.

Reviewing and Deleting the Last Scene Recorded

Even in **Review** mode you can play back the last scene recorded in order to check it. You can also delete the scene while reviewing it.





1 Press **SET to display the joystick guide.**

If **G** does not appear on the joystick guide, repeatedly push the joystick (**▼**) toward [Next] to display it.

2 Push the joystick (◀**) toward **G**.**

The camcorder plays back the last scene (but without sound) and returns to record pause mode.

Deleting a Scene After Recording It

After recording a scene:

1 Review the scene as described in the previous section.

2 While reviewing the scene, select (▶**) the **🗑️** icon and press **SET**.**

3 Select (▶**) [Yes] and press **SET**.**

i NOTES

- Avoid any other operations on the camcorder while the scene is being deleted.
- You will not be able to delete the last scene this way if after the scene was recorded you changed the operating mode or turned the camcorder off.

Basic Playback

Playing Back the Video

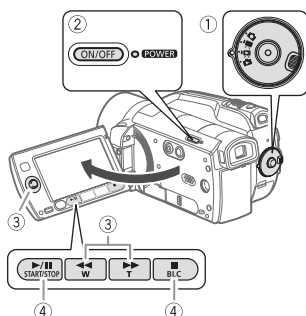

1 Set the mode dial to **▶.**

2 Turn on the camcorder.

The scene index screen appears after a few seconds.

3 Move (▲▼**, **◀▶**) the selection frame to the scene you want to play back.**

When you have recorded a large number of scenes, repeatedly press **◀◀** or **▶▶** to move between index screen pages.

4 Press **▶|| or **SET** to begin the playback.**



- Playback will start from the scene selected and continue until the end of the last scene recorded.
- Press **▶||** again to pause the playback.

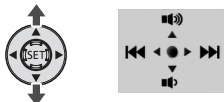

- Press  to stop the playback and return to the scene index screen.

ADJUSTING THE VOLUME



- 1 During playback, press  to display the joystick guide.
- 2 Adjust () () the volume.

! IMPORTANT

- Observe the following precautions while the ACCESS indicator is on or flashing. Failing to do so may result in permanent data loss.
 - Do not subject the camcorder to vibrations or strong impacts.
 - Do not open the memory card slot cover.
 - Do not disconnect the power source or turn off the camcorder.
 - Do not change the position of the mode dial.
- You may not be able to play back with this camcorder movies recorded on a memory card using another device.



i NOTES

- Depending on the recording conditions, you may notice brief stops in video or sound playback between scenes.
- Sound from the speaker will be muted when you close the LCD panel.
HG21 Use a pair of headphones when you want to use the viewfinder for playback.



Special playback modes

To enter the special playback modes, you can use the buttons on the LCD panel or wireless controller ( 17). There is no sound during the special playback modes.

Fast playback



During normal playback, press  or . Press again to increase the playback speed to approximately 5x → 15x → 60x the normal speed.

Slow playback





In playback pause mode, press * or . Press again to increase the playback speed 1/8 → 1/4 the normal speed.

* Slow reverse playback will look the same as continuous frame reverse.



Frame Advance/Reverse

In playback pause mode, press  or  on the wireless controller to reverse a few frames (approx. 0.5 seconds) or to advance one frame. Hold the button pressed for continuous playback.

Skipping scenes

During normal playback push the joystick () or press  on the wireless controller to skip to the next scene. Push the joystick () or press  on the wireless controller once to return to the beginning of the current scene or twice to skip to the previous scene.

Ending special playback modes

During any special playback mode, press  on the camcorder or  on the wireless controller.

i NOTES

During some special playback modes, you may notice some anomalies (blocky video artifacts, banding, etc.) in the playback picture.

Changing the Index Screen Selection

Use the tabs on top of the index screen to switch between playback of the scenes and photos recorded on the hard disk and those recorded on the memory card. After creating a playlist (□ 56), you can switch between the original movies and the playlist you edited to your liking.



Selecting the Media for Playback

- 1** In the index screen, move (▲▼) the orange selection frame to the tabs on the top of the screen.
- 2** Select (◀▶) the media or location from where you want to play back scenes/photos.
- 3** Return (▲▼) to the index screen to select the scene or photo.

Example of changing the index screen in mode:

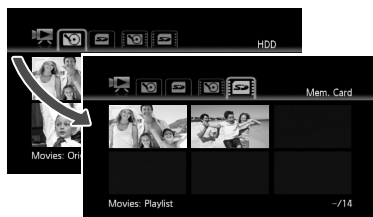

- Original movies or photos on the hard disk
 - Original movies or photos on the memory card
 - Playlist on the hard disk*
 - Playlist on the memory card*
- * mode only.

i NOTES

In mode, you can press **PLAYLIST** on the wireless controller to switch between the original movies and the playlist of the respective media.

Changing the Number of Items in the Index Screen

By default, the index screen will show up to 6 items (scenes or photos). Move the zoom lever toward **W** to show up to 15 items per screen. Move it toward **T** to return to the default index screen display.

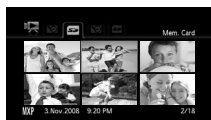

W 6 scenes/photos

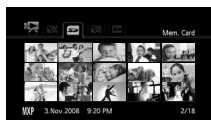
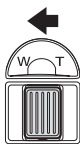

T 15 scenes/photos

and the total recording time for the same day.

3 Select (◀▶) the date, month or year and move (▲▼) between recording dates.

4 After selecting the desired date, press **SET.**

The index screen will appear with the selection frame on the first scene recorded on the selected date.

i NOTES

You can press **FUNC.** to return to the index screen at any time.

Selecting Scenes by Recording Date

From the original movies index screen, you can search for recordings you made on a particular date (for example, to find all the movies you shot during a special event).



Selecting from the List of Recordings

1 Select the original movies index screen.

Select the (hard disk) or (memory card) tab (□ 38).

2 Open the list of recordings.

FUNC. [**Q** Scene Search]
[Date Selection]

- The list of recordings displays all dates in which recordings were made. An orange selection frame appears on the day.
- The thumbnail shows a still image from the first scene recorded on that day. Below it will appear the number of scenes recorded ()

Selecting from the Calendar Screen

1 Select the original movies index screen.

Select the (hard disk) or (memory card) tab (□ 38).

2 Open the calendar screen.

FUNC. [**Q** Scene Search]
[Calendar Screen]

- The calendar screen appears.
- Dates that contain scenes (that is, movies were recorded on that date) appear in white. Dates without recordings appear in black.

3 Move (▲▼, ▶◀) the cursor to the desired date.

- When you move the cursor to a date displayed in white, a thumbnail showing a still image from the first scene recorded on that date will be displayed next to the calendar. Below it will appear the number of scenes recorded () and the total recording time for the same day.

- You can select ($\blacktriangle/\blacktriangledown$) the year or month field and change ($\blacktriangleleft/\blacktriangleright$) the year or month to move faster between calendar months.
- You can press (\blacktriangleleft) or (\blacktriangleright) to skip directly to the previous/next date that contains scenes.

4 Press **SET** to return to the index screen.

The orange selection frame will appear on the first scene recorded on the selected date.

i NOTES

- You can change on what day to start the week for the calendar display (\square 97).
- You can press **FUNC.** to return to the index screen at any time.

Selecting the Playback Starting Point from the Movie Timeline

You can display a timeline of the scene and select where to begin the playback. This is very convenient when you want to play back a long scene from a specific point.

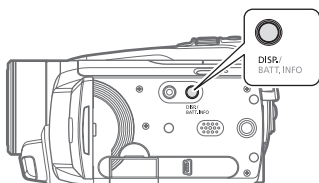

1 Select ($\blacktriangle/\blacktriangledown$, $\blacktriangleleft/\blacktriangleright$) the scene you want to view and press **DISP.**

- The timeline screen appears. The large thumbnail will show the first frame of the scene. Below it, the timeline ruler shows frames taken from the scene at fixed intervals.
- Press **DISP.** again to return to the index screen.

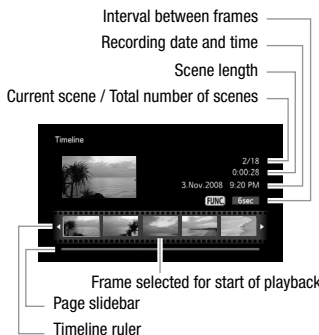

2 Select ($\blacktriangleleft/\blacktriangleright$) the playback starting point from the timeline ruler.

3 Press **▶/||** to begin the playback.

TO SELECT ANOTHER SCENE

Move ($\blacktriangle/\blacktriangledown$) the orange selection frame to the large thumbnail and change ($\blacktriangleleft/\blacktriangleright$) the scene.

TO MOVE BETWEEN TIMELINE RULER PAGES

Move ($\blacktriangle/\blacktriangledown$) the orange selection frame to the sidebar below the ruler and display ($\blacktriangleleft/\blacktriangleright$) the previous/next 5 frames in the scene.



TO CHANGE THE INTERVAL BETWEEN FRAMES

[FUNC.] Desired interval [FUNC.]

Selecting Recordings from the Index Screen

You can select in advance a number of original movies or photos from the index screen in order to perform certain actions on them collectively, all at once.

mode: Delete (□ 42), copy (□ 58) or add the selected scenes to the playlist (□ 56).

mode: Delete (□ 63), copy (□ 69) or protect (□ 68) the selected photos or mark all of them with print orders (□ 74) or transfer orders (□ 87).



1 Select the original movies or the photo index screen.

- mode: Select the (hard disk) or (memory card) tab (□ 38).
- mode: Move the zoom lever toward **W** to display the index screen.

2 Open the selection screen.

[FUNC.] [Select]
[Individual Scenes] or
[Individual Photos]

- The selection screen appears.

3 Move (,) between the scenes or photos in the index

screen and press to select an individual scene/photo.

- A checkmark will appear on the selected scenes/photos.
- Repeat this step to add all the scenes/photos you want to include in your selection (up to 100).

Total number of scenes selected

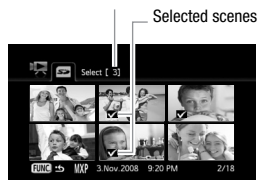

4 Press [FUNC.] twice to close the menu.

TO CANCEL ALL THE SELECTIONS

[FUNC.]
[Select]
[Remove All Selections] [Yes]
[FUNC.]

NOTES

- The selection of scenes/photos will be canceled if you turn off the camcorder or change the operating mode.
- Scenes in the playlist cannot be included in the selection.

Deleting Scenes

You can delete those scenes that you are not interested in keeping. Deleting scenes allows you also to free up space on the recording media.



Options

| |
|--|
| [All Scenes] |
| Deletes all the scenes. |
| [All Scenes (this date)] |
| Deletes all the scenes recorded on the same day as the selected scene. |
| [This Scene] |
| Deletes only the scene marked with the orange selection frame. |
| [Selected Scenes] |
| Deletes all the scenes selected in advance (marked with a ✓ checkmark). Refer to <i>Selecting Recordings from the Index Screen</i> (□ 41). |

1 Select (▲▼, ◀▶) the scene you want to delete, or a scene recorded on the date you want to delete.

This step is not necessary to delete all scenes or previously selected scenes.

2 Delete the scene(s).

[FUNC.] ➤ [Delete] ➤
 Desired option ➤ [Yes]* ➤ [OK] ➤
 [FUNC.]

* If you selected any option other than [This Scene], you can press **SET** to interrupt the operation while it is in progress. Some scenes will be deleted nevertheless.

! IMPORTANT

- Be careful when deleting original recordings. Once deleted, original scenes cannot be recovered.
- Back up important scenes before deleting them (□ 80).
- Observe the following precautions while the ACCESS indicator is on or flashing (while scenes are being deleted).
 - Do not subject the camcorder to vibrations or strong impacts.
 - Do not open the memory card slot cover.
 - Do not disconnect the power source or turn off the camcorder.
 - Do not change the position of the mode dial.

i NOTES

- Deleting a scene from the original index screen also deletes that scene from the playlist.
- To delete all movies and make all recordable space available again you may prefer to initialize the recording media (□ 31).
- You may not be able to delete scenes recorded or edited using another device.



Advanced Functions

Special Scene Recording Programs

Recording in a very bright ski resort or capturing the full colors of a sunset or a fireworks display becomes as easy as selecting a Special Scene recording program. For details about the available options, refer to the sidebar below.



FUNC.

[P Programmed AE]

[Portrait]

Press **SET** to display the Special Scene (SCN) recording programs

Desired recording program

FUNC.

NOTES

- [Night]
 - Moving subjects may leave a trailing afterimage.
 - Picture quality may not be as good as in other modes.

Portrait

The camcorder uses a large aperture, achieving a focus on the subject while blurring other distracting details.



Sports

Use this mode to record sports scenes such as tennis or golf.



Night

Use this mode to record in dimly lit places.



Snow

Use this mode to record in bright ski resorts. It prevents the subject from being underexposed.



Beach

Use this mode to record on a sunny beach. It prevents the subject from being underexposed.



Sunset

Use this mode to record sunsets in vibrant colors.



Spotlight

Use this mode to record spotlight scenes.



Fireworks

Use this mode to record fireworks.



- White points may appear on the screen.
- Autofocus may not work as well as in other modes. In such case, adjust the focus manually.
- [🎆 Fireworks]
 - To avoid camcorder shake, we recommend using a tripod. Make sure to use a tripod especially in [📷] mode, as the shutter speed slows down.
- [👤 Portrait]/[🏖️ Sports]/[🏖️ Beach]/[❄️ Snow]
 - The picture may not appear smooth during playback.
- [👤 Portrait]
 - The blur effect of the background increases the more you zoom in (T).
- [❄️ Snow]/[🏖️ Beach]
 - The subject may become overexposed on cloudy days or in shaded places. Check the image on the screen.

Changing the Shutter Speed and Aperture

Use the automatic exposure (AE) program to use functions like the white balance or image effects, or give priority to the exposure value or the shutter speed.

Use faster shutter speeds to record subjects moving quickly; use slower shutter speeds to add motion blur, emphasizing the feel of movement.

Use low aperture values (larger lens opening) to softly blur the background in a portrait; use high aperture values (smaller lens opening) to get a wider

depth of field, giving a sharp focus all throughout a landscape.



Options

◆ Default value

| |
|--|
| [P Programmed AE]◆ |
| The camcorder automatically adjusts the aperture and shutter speed to obtain the optimal exposure for the subject. |
| [Tv Shutter-Priority AE] |
| Set the shutter speed value. The camcorder automatically sets the appropriate aperture value. |
| [AV Aperture-Priority AE] |
| Set the aperture value. The camcorder automatically sets the appropriate shutter speed. |

[FUNC.] ⏪

[P Programmed AE] ⏪ Desired recording program ⏩

[FUNC.]

TO SET THE SHUTTER SPEED OR APERTURE VALUE

When you select [Tv Shutter-Priority AE] or [AV Aperture-Priority AE], a numeric value will appear next to the recording program icon.

- 1 If the joystick guide appears on the screen, press [SET] to hide it.
- 2 Adjust (◀▶) the shutter speed or aperture value to the desired value.

Shutter speed guidelines

Note that on screen only the denominator is displayed – [Tv 250] indicates a shutter speed of 1/250 second, etc.



| |
|---|
| 1/2*, 1/3*, 1/6, 1/12, 1/25 |
| To record in dimly lit places. |
| 1/50 |
| To record under most ordinary conditions. |
| 1/120 |
| To record indoor sports scenes. |
| 1/250, 1/500, 1/1000** |
| To record from within a moving car or train or to shoot fast-moving subjects such as roller coasters. |
| 1/2000** |
| To record outdoor sports scenes on sunny days. |

* mode only. ** mode only.

Available Aperture Values

[F1.8], [F2.0], [F2.4], [F2.8], [F3.4],
[F4.0], [F4.8], [F5.6], [F6.7], [F8.0]

NOTES

- [TV Shutter-Priority AE]
 - If you use a slow shutter speed in dark places, you can obtain a brighter image, but image quality may be lower, and autofocus may not work well.
 - The image may flicker when recording with fast shutter speeds.
- [AV Aperture-Priority AE]
The actual range of values available for selection will vary depending on the initial zoom position.
- When setting a numeric value (aperture or shutter speed), the number displayed will flash if the aperture or shutter speed is not appropriate for the recording conditions. In such case, select a different value.

Cinema Mode: Giving a Cinematic Look to your Recordings

Give your recordings a cinematic look by using the [Cine Mode] recording program. Combine this recording program with the 25 fps progressive frame rate [PF25 PF25] to get the enhanced effect of the 25p Cinema Mode.



TO SET THE [CINE MODE] RECORDING PROGRAM

[FUNC.]
[P Programmed AE]
[Cine Mode]
[FUNC.]

TO CHANGE THE FRAME RATE

[FUNC.]
[Menu] [Cine Mode]
[Frame Rate]
[PF25 PF25]



Self Timer



FUNC.

[Menu] [Video] or [Photo]
 [Self Timer] [On]

FUNC.

appears.

mode:

In record pause mode, press

[Start/Stop].

The camcorder starts recording after a 10-second countdown*. The countdown appears on the screen.

mode:

Press [PHOTO], first halfway to activate the autofocus and then fully.

The camcorder will record the photo after a 10-second countdown*. The countdown appears on the screen.

* 2 seconds when using the wireless controller.

NOTES

Once the countdown has begun, you can press [Start/Stop] (when recording movies), press [PHOTO] fully (when recording photos) or turn off the camcorder to cancel the self timer.

Manual Exposure Adjustment and Automatic Backlight Correction

At times, backlit subjects may appear too dark (underexposed) or subjects under very strong lights may appear too bright or glaring (overexposed). To correct this, you can manually adjust the exposure or use the automatic backlight correction.



POINTS TO CHECK

Select a recording mode other than [* Fireworks].

Manual Exposure Adjustment

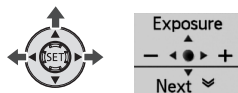

1 Press [SET] to display the joystick guide.

If [Exposure] does not appear on the joystick guide, repeatedly push the joystick () toward [Next] to display it.

2 Push the joystick () toward [Exposure].

- The exposure adjustment indicator and the neutral value "±0" appear on the screen.
- The adjustment range and the length of the exposure adjustment indicator will vary depending on the initial brightness of the picture.



- If you operate the zoom, the brightness of the image may change.

3 Adjust the (◀▶) the brightness of the image as required and press

SET.

- The exposure adjustment indicator will change to white and the exposure will be locked.
- During exposure lock, press **SET** and push the joystick (▲) toward [Exposure] again to return the camcorder to automatic exposure.

Automatic Backlight Correction

When shooting subjects with a strong light source behind them, you can have the camcorder automatically correct for the backlight with the press of a single button.

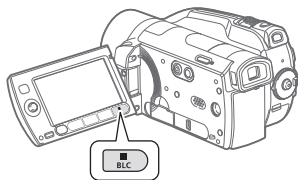

Press **BLC**.

-  appears.
- Press **BLC** again to turn off the backlight correction.

Manual Focus Adjustment

Autofocus may not work well on the following subjects. In such case, focus manually.

- Reflective surfaces
- Subjects with low contrast or without vertical lines
- Fast moving subjects
- Through wet windows
- Night scenes



POINTS TO CHECK

Adjust the zoom before you start the procedure.



1 Press **SET** to display the joystick guide.

If [Focus] does not appear on the joystick guide, repeatedly push the joystick (▼) toward [Next] to display it.

2 Push the joystick (▲) toward [Focus].

“MF” appears.

3 Push the joystick (◀) or (▶) once to verify if the image is focused.

The center of the screen will be magnified and outlines will be emphasized to help you focus more easily. You can also turn off the focus assist function ( 90).

4 Adjust (◀▶) the focus as necessary and press **SET**.

- The focus will be locked.
- During focus lock, press **SET** and push the joystick (▲) toward [Focus] again to return the camcorder to autofocus.

Infinity Focus

Use this function when you wish to focus on faraway subjects such as mountains or fireworks.

Instead of step 2 in the previous procedure:

Push the joystick (▲) toward [Focus] and hold it for more than 2 seconds.

- ∞ appears.
- Push the joystick (▲) toward [Focus] again to return the camcorder to autofocus.
- If you operate the zoom or joystick (◀▶), ∞ changes to “MF” and the camcorder returns to manual focus.

White Balance

The white balance function helps you to accurately reproduce colors under different lighting conditions so that white objects will always look truly white in your recordings.



POINTS TO CHECK

Select a recording mode other than the Special Scene recording programs.

Options

◆ Default value

| |
|---|
| [Automatic]◆ |
| Settings are automatically set by the camcorder. Use this setting for outdoor scenes. |
| [Daylight] |
| For recording outdoors on a bright day. |

| |
|--|
| [Shade] |
| For recording in shaded places. |
| [Cloudy] |
| For recording on a cloudy day. |
| [Tungsten] |
| For recording under tungsten and tungsten type (3-wavelength) fluorescent lighting. |
| [Fluorescent] |
| For recording under warm white, cool white or warm white type (3-wavelength) fluorescent lighting. |
| [Fluorescent H] |
| For recording under daylight or daylight type (3-wavelength) fluorescent lighting. |
| [Custom WB] |
| Use the custom white balance setting to make white subjects appear white under colored lighting. |

[FUNC.]
 [Automatic]
 Desired option*

[FUNC.]

* When you select [Custom WB], do not press [FUNC.] and continue instead with the following procedure.

TO SET THE CUSTOM WHITE BALANCE

- 1 Point the camcorder at a white object, zoom in until it fills the whole screen and press .** When the adjustment is completed, stops flashing and stays on. The camcorder retains the custom setting even if you turn off the camcorder.
- 2 Press [FUNC.] to save the setting and close the menu.**



NOTES

- **When you select the custom white balance:**
 - Set the custom white balance in a sufficiently illuminated place.
 - Turn off the digital zoom (91).
 - Reset the white balance when the lighting conditions change.
 - Depending on the light source, may keep flashing. The result will still be better than with [Automatic].
- Custom white balance may provide better results in the following cases:
 - Changing lighting conditions
 - Close-ups
 - Subjects in a single color (sky, sea or forest)
 - Under mercury lamps and certain types of fluorescent lights
- Depending on the type of fluorescent light, optimal color balance may not be obtained with [Fluorescent] or [Fluorescent H]. If the color looks unnatural, adjust it using [Automatic] or [Custom WB].

Image Effects

You can use the image effects to change the color saturation and contrast to record movies and photos with special color effects.



POINTS TO CHECK

Select a recording mode other than the Special Scene recording programs.

Options

◆ Default value

| |
|---|
| [Image Effect Off] [◆] |
| Records with no image enhancing effects. |
| [Vivid] |
| Emphasizes the contrast and color saturation. |
| [Neutral] |
| Tones down the contrast and color saturation. |
| [Low Sharpening] |
| Records subjects with softened outlines. |
| [Soft Skin Detail] |
| Softens the details in the skin tone area for a more complimentary appearance. To obtain the best effect, use this setting when recording a person in close-up. Note that areas similar to the skin color may lack in detail. |
| [Custom Effect] |
| Allows you to adjust the color depth, brightness, contrast, and sharpness of the image. |
| [Color Depth]: (-) Shallower colors, (+) Richer color tonality |
| [Brightness]: (-) Darker picture, (+) Brighter picture |
| [Contrast]: (-) Flatter picture, (+) More defined light and shade |
| [Sharpness]: (-) Vaguer outlines, (+) Sharper outlines |

FUNC.

[**Image Effect Off**]
Desired option*

FUNC.

* When you select [**Custom Effect**], do not press **FUNC.** and continue instead with the following procedure.

TO SET THE CUSTOM IMAGE EFFECT

- 1 Press **SET** and select (**▲▼**) the custom setting options.
- 2 Adjust (**◀▶**) each setting as desired.
- 3 When you finish all the adjustments, press **SET** then **FUNC.** to save the setting and close the menu.

Digital Effects



Options

◆ Default value

| |
|---|
| [OFF] Digital Effect Off ◆ |
| Select this setting when you do not intend to use the digital effects. |
| [F1] Fade Trigger , [F2] Wipe |
| Select one of the faders to begin or end a scene with a fade from or to a black screen. |
| [E1] B&W * |
| Records movies and photos in black and white. |
| [E2] Sepia * |
| Records movies and photos in sepia tones for an "old" look. |
| [E3] Art |
| Select this effect to add "flavor" to your recordings. |

* Only these digital effects are available in mode.

Setting

FUNC. **[OFF] Digital Effect Off**
 Desired fader/effect*

FUNC. **

* You can preview the digital effect on the screen.

**The icon of the selected digital effect appears.

Applying



- 1 Press **SET** to display the joystick guide.

If does not appear on the joystick guide, repeatedly push the joystick (**▼**) toward [Next] to display it.

- 2 Push the joystick (**▲**) toward .
 - The icon of the selected effect turns green.
 - Push the joystick (**▲**) again to deactivate the digital effect (its icon will turn white again).

TO FADE IN

Activate the selected fader in record pause mode (**●||**), then press **Start/Stop** to start recording with a fade in.

TO FADE OUT

Activate the selected fader while recording (**●**), then press **Start/Stop** to fade out and pause the recording.



TO ACTIVATE AN EFFECT

mode: Activate the selected effect while recording or in record pause mode.

mode: Activate the selected effect and then press **PHOTO** to record the photo.

NOTES

- When you apply a fader, not only the picture but also the sound will fade in or out. When you apply an effect, the sound will be recorded normally.
- The camcorder retains the last setting used even if you turn off the digital effects or change the recording program.

On-Screen Displays and Data Code

You can turn most on-screen displays on or off.

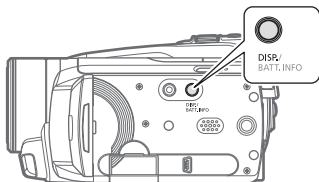

Repeatedly press **DISP.** to turn the on-screen displays on/off in the following sequence:

- , mode:
- All displays on
 - Most displays off*

- mode:
- All displays on
 - Data code only
 - All displays off

- mode:
- All displays on
 - Regular displays only (removes the histogram and information icons)
 - All displays off

* The following icons will appear even when all other on-screen displays are turned off: The icons and (in mode), the icon and AF frames when the autofocus is locked (in mode), screen markers (both recording modes).

About the Data Code

With every scene or photo recorded, the camcorder keeps a data code (date/time of recording, information about the camera setup, etc.). In mode, this information is displayed on the bottom bar and as information icons; in mode, you can select the information to be displayed with the [Data Code] setting (93).

Audio Recording Level

You can adjust the audio recording level of the built-in or an external microphone. You can display the audio level indicator while recording.



Manual Adjustment of the Audio Recording Level

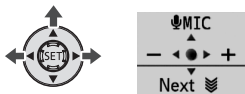

1 Press **SET** to display the joystick guide.

If [MIC] does not appear on the joystick guide, repeatedly push the joystick (**▼**) toward [Next] to display it.

2 Push the joystick (**▲**) toward [MIC].

The manual adjustment icon **M** will appear to the left of the audio level indicator and the manual adjustment bar (orange) will appear below it.

Manual audio level adjustment

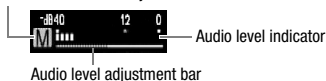

3 Adjust (**◀▶**) the audio level as necessary.

As a guideline, adjust the audio recording level so that the audio level meter will go to the right of the -12 dB mark only occasionally.

4 Press **SET** to save the setting and hide the joystick guide.

- The audio level selected will be locked and the audio level adjustment bar will disappear from the indicator.
- During manual adjustment, press **SET** and push the joystick (**▲**) toward [MIC] to return the camcorder to automatic audio adjustment.

TO DISPLAY THE AUDIO LEVEL METER

Usually, the audio level indicator will be displayed only after activating the manual adjustment of the audio recording level. You can choose to display it also when the audio level is adjusted automatically.

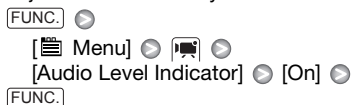

i NOTES

- When the 0 dB mark turns red, the sound may be distorted.
- If the audio level is too high and the sound gets distorted, activate the microphone attenuator (92).
- We recommend using headphones (52) to check the sound level while adjusting the audio recording level or when the microphone attenuator is activated.

Using Headphones

Use headphones for playback or to check the audio level while recording. The headphones are connected to the AV OUT/🎧 terminal, which is used for both the headphones and the audio/video output. Before connecting the headphones, follow the procedure below to change the function of the terminal from AV output to 🎧 (headphones) output.



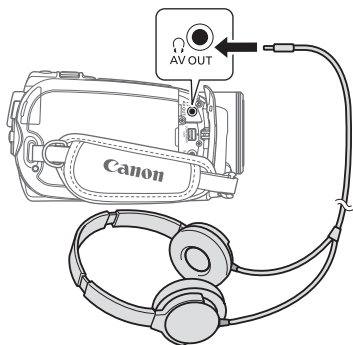

FUNC.
 [Menu]
 [AV/Headphones]
 [Headphones]
 FUNC.

appears.

TO ADJUST THE VOLUME OF THE HEADPHONES

In mode, adjust () the volume of the headphones with the [Headphone Volume] setting (□ 94). In mode, adjust the headphones volume the same way you adjust the speaker's volume (□ 37).

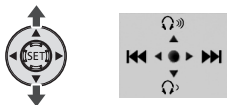

! IMPORTANT

- When using headphones, make sure to lower the volume to an appropriate level.

- Do not connect the headphones to the AV OUT/ terminal if the icon does not appear on the screen. Only noise will be output in such case.

i NOTES

- Use commercially available headphones with a \varnothing 3.5 mm minijack and a cable no longer than 3 m.
- When you change the operating mode, the [AV/Headphones] setting in mode will return to [AV AV].

Using the Mini Advanced Shoe

You can attach an optional DM-100 Directional Stereo Microphone or an optional VL-5 Video Light. For details about how to attach and use the accessories, refer also to the instruction manual of the each accessory.



* Only the optional VL-5 Video Light can be used in mode.

- 1 Pull out the viewfinder.
- 2 Lift and rotate the mini advanced shoe cover.
- 3 Attach the optional accessory to the mini advanced shoe.

When a compatible accessory is attached to the mini advanced shoe, will appear on the screen.

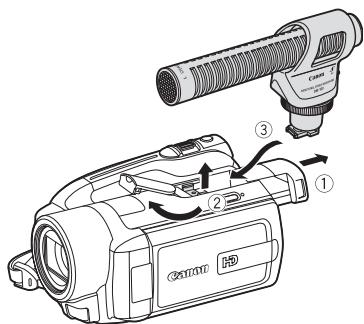

i NOTES

Accessories designed for the Advanced Accessory Shoe cannot be used with this camcorder. Look for video accessories bearing this logo to ensure compatibility with the **mini advanced shoe**.



Using an External Microphone

When recording in very quiet surroundings, the built-in microphone may pick up the sound of the camcorder's internal machinery. In such case, we recommend using an external microphone.

Using the DM-100 Directional Stereo Microphone



Attach the optional DM-100 Directional Stereo Microphone to the mini advanced shoe.

Refer to *Using the Mini Advanced Shoe* (□ 53).

“S” appears. For details about using the microphone, refer to the instruction manual of the DM-100.

Using other microphones

You can also use commercially available microphones. Connect the external microphone to the MIC terminal. Use commercially available condenser microphones with their own power supply and a cable no longer than 3 m. You can connect almost any stereo microphone with a $\varnothing 3.5$ mm plug but audio recording levels may vary.

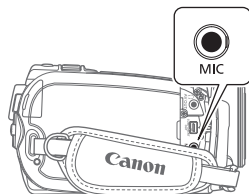

i NOTES

- When an external microphone is connected to the camcorder, [Wind Screen] will automatically be set to [OFF Off].
- If the audio level is too high and the sound gets distorted, activate the microphone attenuator (□ 92) or adjust the audio recording level manually (□ 51).



Using a Video Light

You can use the optional VL-5 Video Light to shoot video or take photos in dark places.



Attach the optional VL-5 Video Light to the mini advanced shoe.

Refer to *Using the Mini Advanced Shoe* (□ 53).

..S appears when you turn on the video light. For details about using the video light, refer to the instruction manual of the VL-5.



Playlist and Scene Operations

Dividing Scenes

You can divide scenes (original scenes only) in order to leave out the best parts and later cut out the rest.



1 Select the original movies index screen.

Select the  (hard disk) or  (memory card) tab (□ 38).



2 Select (▲▼, ◀▶) the scene you want to divide.

3 Open the scene division screen.

FUNC.  [ Divide]

The scene selected will start playing back.

4 Select (◀▶) the icon and press where you want to divide the scene.

- You can use the following icons and the special playback modes (□ 37) to bring the scene to a precise point.
 - : Skip to the beginning/end of the current scene.
 - : Frame advance/reverse.
- Press **FUNC.** or  to stop the playback and exit the scene division screen.

5 Select (◀▶) [Yes] and press .

The video from the division point to the end of the scene will appear as a new scene in the index screen.

NOTES

- In this mode, the scene playback will pause only at points where the scene can be divided. Advancing/reversing frames will skip only between such points as well, so the interval will be longer than in regular frame advance/reverse.
- The following scenes cannot be divided:
 - Scenes included in the scene selection (marked with a ✓ checkmark). Remove the selection mark in advance.
 - Scenes too short (3 seconds or shorter).
 - Scenes that were not recorded with this camcorder.
- Scenes cannot be divided within 0.5 seconds from the beginning or the end of the scene.
- During the playback of a scene that was divided you may notice some anomalies in the picture/sound at the point where the scene was cut. To avoid this, you can use the supplied software ImageMixer 3 to divide and edit scenes.

Editing the Playlist: Adding, Moving and Deleting Playlist Scenes

Create a playlist to play back only the scenes you prefer and in the order of your choice. Moving or deleting scenes in the playlist will not affect the original recordings.





Adding Scenes to the Playlist

Options

| |
|---|
| [All Scenes (this date)] |
| Adds to the playlist all the scenes that were recorded on the same day as the selected scene. |
| [This Scene] |
| Adds to the playlist only the scene marked with the orange selection frame. |
| [Selected Scenes] |
| Adds to the playlist all the scenes selected in advance (marked with a ✓ checkmark). Refer to <i>Selecting Recordings from the Index Screen</i> (□ 41). |

1 Select the original movies index screen.

Select the  (hard disk) or  (memory card) tab (□ 38).



2 Select (▲▼, ◀▶) the scene you want to add to the playlist, or a scene recorded on the date you want to add to the playlist.

3 Add the scene(s) to the playlist.

[FUNC.] 

 Add to Playlist] 

Desired option  [Yes]

- When the operation is completed [Scene(s) added to the playlist] will be displayed.
- Scenes are added to the playlist on the same media they are recorded on.
- To check the playlist, select the  (hard disk playlist) or  (memory card playlist) tab (□ 38).



i NOTES

- You can copy scenes from the hard disk to the memory card (□□ 58) to include in the memory card's playlist also scenes that were originally recorded on the hard disk.
- You may not be able to add scenes to the playlist if they were recorded or edited using another device or if there is not enough space available on the hard disk or memory card.

Deleting Scenes from the Playlist

Deleting scenes from the playlist will not affect your original recordings.

Options

| |
|--|
| [All Scenes] |
| Deletes all the scenes from the playlist. |
| [This Scene] |
| Deletes from the playlist only the scene marked with the orange selection frame. |

1 Select the playlist index screen.

Select the (hard disk playlist) or (memory card playlist) tab (□□ 38).

2 Select (▲▼, ◀▶) the scene you want to delete.

This step is not necessary to delete all scenes.

3 Delete the scene.

[FUNC.] ➤ [Delete] ➤
Desired option ➤ [Yes]* ➤ [OK] ➤
[FUNC.]

* If you selected [All Scenes], you can press to interrupt the operation while it is in progress. Some scenes will be deleted nevertheless.

Moving Scenes in the Playlist

Move the scenes in the playlist to play them back in the order of your choice.

1 Select the playlist index screen.

Select the (hard disk playlist) or (memory card playlist) tab (□□ 38).

2 Select (▲▼, ◀▶) the scene you want to move.

3 Open the scene moving screen.

[FUNC.] ➤ [Move]

4 Move (▲▼, ◀▶) the orange marker to the desired position of the scene and press .

The original position of the scene and the current position of the marker are displayed at the bottom of the screen.

5 Select (▶) [Yes] and press to move the scene.

i NOTES

You may not be able to move scenes in the playlist if there is not enough space available on the hard disk or memory card.



Copying Scenes

You can copy original movies or the entire playlist only from the hard disk to the corresponding location on the memory card.



Copying Original Movies

Options

| |
|---|
| [All Scenes] |
| Copies all the scenes to the memory card. |
| [All Scenes (this date)] |
| Copies to the memory card all the scenes that were recorded on the same day as the selected scene. |
| [This Scene] |
| Copies only the scene marked with the orange selection frame to the memory card. |
| [Selected Scenes] |
| Copies to the memory card all the scenes selected in advance (marked with a ✓ checkmark). Refer to <i>Selecting Recordings from the Index Screen</i> (□□ 41). |

1 Select the index screen of original movies recorded on the hard disk.

Select the tab (□□ 38).

2 Select (▲▼, ◀▶) the scene you want to copy to the memory card, or a scene recorded on the date you want to copy.

This step is not necessary to copy all scenes or previously selected scenes.

3 Copy the scene(s).

[FUNC.] [Copy (→)]
 Desired option [Yes]*
 [OK] [FUNC.]

* Press (SET) to interrupt the operation while it is in progress.

Copying the Entire Playlist

1 Select the index screen of the hard disk's playlist.

Select the tab (□□ 38).

2 Copy the playlist.

[FUNC.] [Copy (→)]
 [Yes]* [OK] [FUNC.]

* Press (SET) to interrupt the operation while it is in progress.

! IMPORTANT

- Observe the following precautions while the ACCESS indicator is on or flashing. Failing to do so may result in permanent data loss.
 - Do not subject the camcorder to vibrations or strong impacts.
 - Do not open the memory card slot cover.
 - Do not disconnect the power source or turn off the camcorder.
 - Do not change the position of the mode dial.

i NOTES

- If the memory card slot cover is open, or the LOCK switch on the memory card is set to prevent writing, you will not be able to copy movies to the memory card.
- Scenes that were edited using the supplied software ImageMixer 3 and written back to the camcorder cannot be copied to the memory card. You may also not be able to copy scenes that were not recorded with this camcorder.



Photos

Refer to this chapter for details on shooting photos – taking photos and playing them back, capturing photos from video and printing photos.

Basic Recording

Taking Photos

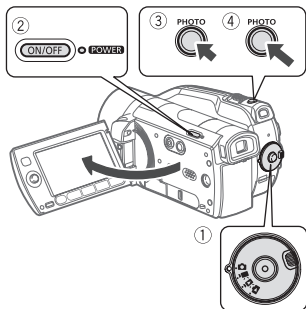



1 Set the mode dial to .

2 Turn on the camcorder.

By default, photos are recorded on the hard disk. You can also set the memory card as the recording media for photos (□ 31).

3 Press  halfway.

- Once the focus is automatically adjusted,  will turn green and one or more AF frames will appear.
- When you press  on the wireless controller, the photo is

recorded after the autofocus is activated and locked.

4 Press  fully.

The ACCESS indicator will flash as the photo is being recorded.

! IMPORTANT

Observe the following precautions while the ACCESS indicator is on or flashing. Failing to do so may result in permanent data loss.

- Do not subject the camcorder to vibrations or strong impacts.
- Do not open the memory card slot cover.
- Do not disconnect the power source or turn off the camcorder.
- Do not change the position of the mode dial.

i NOTES

- If the subject is not suitable for autofocus,  turns yellow. Adjust the focus manually (□ 47).
- When the subject is too bright, [Overexp.] starts flashing. In such case, use the optional FS-H37U ND filter.

Selecting Photo Size and Quality

Photos are recorded as JPG files. As a general rule, select a larger photo size for higher quality. Select the [LW 1920x1080] size for photos with an aspect ratio of 16:9.



Options

Photo size options and the approximate number of photos that can be recorded on memory cards of various sizes are given in the table below.

[FUNC.] [L 2048x1536]
Desired photo size*
Desired photo quality*

[FUNC.]

* Press to move back and forth between size and quality selection. The number displayed on the right corner indicates the approximate number of photos that can be recorded with the current quality/size setting.

NOTES

- The actual number of photos that can be recorded will vary depending on the subject and shooting conditions.
- The camcorder retains the last setting used even if you set the camcorder to **EASY** mode.

Approximate number of photos available on a memory card

♦ Default value

| Memory card | 128 MB | | | 512 MB | | | 1 GB | | |
|--------------------------------|--------|-----|-----|--------|-------|-------|-------|-------|---------------------|
| | | | | | | | | | |
| Photo quality ¹ → | | | | | | | | | |
| Photo size ↓ | | | | | | | | | |
| LW 1920x1080 | 50 | 75 | 150 | 315 | 470 | 925 | 670 | 1,000 | 1,970 |
| L 2048x1536♦ | 30 | 50 | 100 | 205 | 310 | 625 | 445 | 660 | 1,325 |
| M 1440x1080 | 65 | 100 | 200 | 420 | 625 | 1,225 | 890 | 1,325 | 2,595 |
| SW 848x480 ² | 260 | 370 | 740 | 1,585 | 2,245 | 4,495 | 3,360 | 4,760 | 9,325 |
| S 640x480 | 340 | 490 | 890 | 2,070 | 2,995 | 5,390 | 4,395 | 6,350 | 11,430 ³ |

¹ : [Super Fine], : [Fine], : [Normal].

² This size is only available for recording in mode (simultaneous recording) (66).

³ Approximate number of photos that can actually be recorded on the memory card. (The maximum number of remaining photos displayed on the screen is 9999.)



- When printing photos, use the following guidelines as a reference for selecting the print size.

| Photo size | Recommended use |
|---|---|
| L 2048x1536 | To print photos up to A4 size. |
| M 1440x1080 | To print photos up to L size (9 x 13 cm) or postcard size (10 x 14.8 cm). |
| S 640x480 | To send photos as e-mail attachments or to post on the Web. |
| LW 1920x1080, SW 848x480 | To print photos with a 16:9 aspect ratio. Wide-sized photo paper is required. |

Deleting a Photo Right After Recording It

You can delete the photo recorded last while reviewing it within the time set for the [Photo Review Time] option or immediately after recording it, if [Photo Review Time] is set to [OFF Off].



While reviewing the photo immediately after recording:

- 1 Push the joystick (▼) toward .
- 2 Select (▶) [Yes] and press .

Basic Playback

Viewing Photos

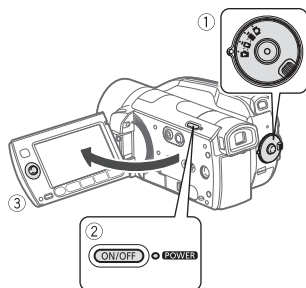

- 1 Set the mode dial to .
- 2 Turn on the camcorder.
- 3 Push the joystick (◀▶) to move between photos.

Push the joystick (◀▶) and hold it down to run quickly through the photos.

Slideshow

You can play a slideshow of all the photos.

- 1 Select (◀▶) the first photo of the slideshow.
- 2 Press to play back the photos one after another.
Press to stop the slideshow.

Index Screen

1 Move the zoom lever toward W.

- The photo index screen appears.
- You can switch to the index screen of the photos recorded on the memory card or change the number of photos displayed per page (□ 38).

2 Select (▲▼, ◀▶) a photo.

- Move the orange selection frame to the photo you want to view.
- Repeatedly press (◀◀) or (▶▶) to move between index screen pages.

3 Press (SET).

The index screen closes and the selected photo is displayed.

Photo Jump Function

When you have recorded a large number of photos, you can jump 10 or 100 photos at a time.



1 Press (SET) to display the joystick guide.

2 Push the joystick (▲) toward (◀▶).

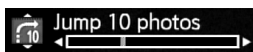

3 Select (▲▼) [◀▶ 10 Jump 10 photos] or [◀▶ 100 Jump 100 photos].

4 Jump (◀▶) the number of photos selected and press (SET).

Press (SET) again to hide the joystick guide.

! IMPORTANT

- Observe the following precautions while the ACCESS indicator is on or flashing. Failing to do so may result in permanent data loss.
 - Do not subject the camcorder to vibrations or strong impacts.
 - Do not open the memory card slot cover.
 - Do not disconnect the power source or turn off the camcorder.
 - Do not change the position of the mode dial.
- The following may not be displayed correctly.
 - Images not recorded with this camcorder.
 - Images edited on or uploaded from a computer.
 - Images whose file names have been changed.

Deleting Photos

You can delete those photos that you are not interested in keeping.



Deleting a Single Photo



- 1 Select (◀▶) the photo you want to delete.
- 2 Press (SET) to display the joystick guide.
- 3 Push the joystick (▼) toward .
- 4 Select (▶) [Yes] and press (SET) .

Deleting Photos from the Index Screen

Options

| |
|--|
| [All Photos] |
| Deletes all the photos. |
| [This Photo] |
| Deletes only the photo marked with the orange selection frame. |
| [Selected Photos] |
| Deletes all the photos selected in advance (marked with a ✓ checkmark). Refer to <i>Selecting Recordings from the Index Screen</i> (□ 41). |

1 Select the photo index screen.

Move the zoom lever toward **W** and then select the (hard disk) or (memory card) tab (□ 38).

2 Select (▲▼, ◀▶) the photo you want to delete.

This step is not necessary to delete all photos or previously selected photos.

3 Delete the photo(s).

[FUNC.] [Delete]
 Desired option [Yes]* [OK]
 [FUNC.]

* If you selected an option other than [This Photo], you can press (SET) to interrupt the operation while it is in progress. Some photos will be deleted nevertheless.

! IMPORTANT

Be careful when deleting photos. Deleted photos cannot be recovered.

i NOTES

Protected photos cannot be deleted.

Additional Functions

Magnifying Photos during Playback

During playback, photos can be magnified up to 5 times.  will appear for photos that cannot be enlarged.

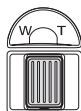

1 Move the zoom lever toward **T**.

- The photo is magnified by 2 times and a frame appears indicating the position of the magnified area.
- To further enlarge the photo, move the zoom lever toward **T**. To reduce the magnification to less than 2 times, move it toward **W**.

2 Move (, ,) the frame to the part of the photo you want to see enlarged.

To cancel the magnification, move the zoom lever toward **W** until the frame disappears.



Flash

You can use the flash to take photos in dark places.





Options

◆ Default value

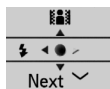

| |
|---|
|  (auto) ◆ |
| The flash fires automatically according to the brightness of the subject. |
|  (flash on) |
| The flash always fires. |
|  (flash off) |
| The flash does not fire. |



1 Press to display the joystick guide.

If  does not appear on the joystick guide, push the joystick () toward [Next] to display it.

2 Push the joystick () toward .

- Repeatedly push the joystick () to cycle between the flash modes.
- The icon of the flash mode appears.  disappears after 4 seconds.

3 Press , first halfway to activate the autofocus and then fully to record the photo.



i NOTES

- The flash will not fire in the following cases:
 - When you manually adjust the exposure in $\frac{1}{A}$ (auto) mode.
 - During auto exposure bracketing.
 - In the [⚡ Fireworks] recording program.
 - When using the optional VL-5 Video Light.
- The practical range of the flash is approx. 1 to 2 m. The actual range will depend on the recording conditions.
- The range of the flash decreases in continuous shooting mode.
- The flash mode cannot be selected when the exposure is locked.
- We recommend not using the flash while the optional Wide-converter or Tele-converter is attached; its shadow can appear on the screen.

Histogram Display

When viewing photos you can display the histogram and the icons of all the functions used at the time of recording. The histogram will be displayed also immediately after taking a photo. Use the histogram as a reference to verify the correct exposure of the photo.



The area to the right of the histogram represents highlights and the left side represents shadows. A photo whose histogram skews to the right is relatively

bright; while one whose histogram peaks to the left, is relatively dark.

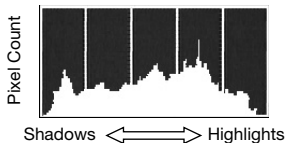

Drive Mode: Continuous Shooting and Exposure Bracketing

Take a series of photos of a moving subject or record the same picture in 3 levels of exposure in order to choose later the photo you like the best.



✓ POINTS TO CHECK

Select a recording mode other than [⚡ Fireworks].

Options

◆ Default value

| |
|---|
| <input type="checkbox"/> Single ◆ |
| Records a single photo. |
| <input type="checkbox"/> Continuous Shooting], <input type="checkbox"/> Hi-Speed Continuous Shooting] |
| Captures a series of up to 60 photos as long as you hold [PHOTO] pressed down. There are two continuous shooting speed settings: normal (approx. 2.5 photos/second) and high speed (approx. 4.1 photos/second). |

[ Auto Exposure Bracketing]

The camcorder records 3 photos using 3 different exposures (dark, normal, light in 1/2 EV steps), allowing you to choose the photo you like the best.

FUNC.  Single  Desired option 

FUNC.

**CONTINUOUS SHOOTING/
HI-SPEED CONTINUOUS SHOOTING**

- 1 Press **[PHOTO]** halfway to activate the autofocus.
- 2 Press **[PHOTO]** fully and hold it pressed down.

AUTO EXPOSURE BRACKETING

Press **[PHOTO]**, first halfway to activate the autofocus and then fully to record the photos.





 NOTES

- Continuous shooting speeds are approximate and vary depending on recording conditions and subjects.
- When using the flash, continuous shooting speed will decrease to approx. 1.7 photos/second. Continuous shooting speed will decrease also when using slow shutter speeds (1/25 or slower).

**Taking Photos while Recording Movies
(Simultaneous Recording)**

You can record photos even while the camcorder is set to  mode. Moreover, you can capture the photo at the same time you are recording video. Photos recorded with simultaneous recording will have the same aspect ratio of movies (16:9).

FUNC. 



[ Simultaneous Recording Off] 
 Desired photo size* 
 Desired photo quality* 

FUNC.

* Press **[]** to move back and forth between size and quality selection. The number displayed on the right corner indicates the approximate number of photos that can be recorded with the current quality/size setting.

While recording, or in record pause mode, press **[PHOTO] to capture the photo.**

 NOTES

- Photos cannot be recorded simultaneously while the digital zoom or a digital effect is activated.
- To take photos we recommend using the  mode, which offers the best quality for photos.
- Photos will be recorded on the media selected for recording photos ( 31).



Light Metering Mode

The camcorder measures the light reflected from the subject in order to calculate the optimal exposure settings. Depending on the subject, you may want to change the way the light is measured and evaluated.



Options

◆ Default value

| |
|--|
| <input checked="" type="checkbox"/> Evaluative* ◆ |
| Appropriate for standard shooting conditions, including backlit scenes. The camcorder divides the picture into several areas and the light is measured in all of them to achieve the optimal exposure for the subject. |
| <input type="checkbox"/> Center-Weighted Average] |
| Averages the light metered from the entire screen, giving more weight to the subject in the center. |
| <input type="checkbox"/> Spot] |
| Meters only the area within the spot AE point frame. Use this setting to adjust the exposure to match the subject in the center of the screen. |

FUNC. >

Evaluative] >

Desired option >

FUNC.

Capturing a Photo from the Playback Scene

You can capture frames from a scene as photos. The size of the captured photo will be [LW 1920x1080] and it cannot be changed, but you can select the photo quality.



POINTS TO CHECK

Set [TV Type] to [16:9 Wide TV] before using this function (94).

FUNC. >

[Menu] > [Photo Capture Quality] >

[Desired photo quality*] >

FUNC.]

* The number displayed at the bottom indicates the approximate number of photos that can be recorded with the current quality setting.

TO CAPTURE THE PHOTO

- 1 Play back the scene containing the picture you want to capture.
- 2 Pause the playback at the point you want to capture.
- 3 Press [PHOTO] fully.

NOTES

- The data code of the photo will reflect the date and time of recording of the original scene.
- A photo captured from a scene with lots of fast movement may be blurred.

- Photos will be recorded on the media selected for recording photos (□ 31).

Protecting Photos

You can protect photos from accidental erasure.



Protecting Single Photos

1 Open the photo selection screen.

[FUNC.] ⏪ [On Protect] ⏩

[On Protect] appears on the screen.

2 Select (◀▶) the photo you want to protect.

3 Press (SET) to protect the photo.

[On] appears on the bottom bar and the photo cannot be deleted. Press (SET) again to remove the protection.

4 Repeat steps 2-3 to protect additional photos or press [FUNC.] twice to close the menu.

Protecting Photos from the Index Screen

Options

| |
|---|
| [Individual Photos] |
| Opens the same screen described in <i>Protecting Single Photos</i> (□ 68). Continue from step 3 of that procedure to protect the photo. |
| [Selected Photos] |
| Protects all the photos selected in advance (marked with a ✓ checkmark). Refer to <i>Selecting Recordings from the Index Screen</i> (□ 41). |

| |
|---|
| [Remove All] |
| Removes the protection from all photos. |

[FUNC.] ⏪ [On Protect] ⏩
 Desired option ⏪ [Yes] ⏩ [OK] ⏩
 [FUNC.]

! IMPORTANT

Initializing the recording media (□ 31) will permanently erase all recordings, including protected photos.

Copying Photos

You can copy photos only from the hard disk to the memory card.



Copying a Single Photo

1 Select to view the photos recorded on the hard disk.

Select the [H] tab (□ 38) and move the zoom lever toward **T** to return to single photo view.

2 Select (◀▶) the photo you want to copy.

3 Copy the photo to the memory card.

[FUNC.] ⏪ [Copy] (☑ → [S]) ⏩
 [Yes] ⏩ [FUNC.]



Copying Photos from the Index Screen

Options









| |
|---|
| [All Photos] |
| Copies all the photos. |
| [This Photo] |
| Copies only the photo marked with the orange selection frame. |
| [Selected Photos] |
| Copies all the photos selected in advance (marked with a ✓ checkmark). Refer to <i>Selecting Recordings from the Index Screen</i> (□ 41). |

1 Select the index screen of the photos recorded on the hard disk.

Move the zoom lever toward **W** and then select the  (hard disk) tab (□ 38).

2 If you want to copy only one photo, select (▲▼, ◀▶) the photo you want to copy.

3 Copy the photo(s).

  Copy ( → ) 
Desired option  [Yes]*  [OK]** 

* If you selected [Selected Photos] or [All Photos], you can press  to interrupt the operation while it is in progress.

** This step is not required when copying a single photo.

IMPORTANT

Observe the following precautions while the ACCESS indicator is on or flashing. Failing to do so may result in permanent data loss.

- Do not subject the camcorder to vibrations or strong impacts.
- Do not open the memory card slot cover.

- Do not disconnect the power source or turn off the camcorder.
- Do not change the position of the mode dial.

NOTES

- If there is not enough space on the memory card, as many photos as possible will be copied before stopping the operation.
- If the memory card slot cover is open, or the LOCK switch on the memory card is set to prevent writing, you will not be able to copy photos to the memory card.
- You may not be able to copy photos that were not recorded with this camcorder.

You can also use the following functions...

The following functions and features of the camcorder can be used either for shooting video or for taking photos. The way to set and use them was already explained in detail, so we refer you to the relevant page in the "Video" section.

- Zoom (□ 34)
- Quick Start (□ 35)
- Recording programs (□ 43, 44)
- Self timer (□ 46)
- Manual exposure adjustment and automatic backlight correction (□ 46)
- Manual focus adjustment (□ 47)
- White balance (□ 48)
- Image effects (□ 49)
- Digital effects (□ 50)

Printing Photos

Printing Photos (Direct Print)

The camcorder can be connected to any PictBridge-compatible printer. You can mark in advance the photos you want to print and set the desired number of copies as a print order (□ 74).



PictBridge

Canon printers: SELPHY printers of the CP, DS and ES series and inkjet printers marked with the PictBridge logo.







Connecting the Camcorder to the Printer

1 Select the media that contains the photos you want to print.

Select the  (hard disk) or  (memory card) tab (□ 38) and move the zoom lever toward **T** to return to single photo view.



2 Turn on the printer.

3 Connect the camcorder to the printer using the supplied USB cable.





- Connection . Refer to *Connection Diagrams* (□ 77).
- If the device type selection screen appears, select [Computer/Printer] and press .
-  appears and changes to .

- The  (print/share) button lights up and the current print settings will be displayed for approx. 6 seconds.

IMPORTANT

- If  continues to flash (for more than 1 minute) or if  does not appear, the camcorder is not correctly connected to the printer. In such case, disconnect the USB cable and turn off the camcorder and the printer. After a short while, turn them on again, set the camcorder to  mode and restore the connection.
- During the following operations, even if you connect a printer to the camcorder it will not be recognized.
 - Deleting all photos
 - Removing all transfer orders
 - Removing all print orders

NOTES

-  will appear for photos that cannot be printed.
- We recommend powering the camcorder using the compact power adapter.
- Refer also to the printer's instruction manual.
- If you have no intention to use the optional DW-100 DVD Burner, you can set  or   [USB Connection Type] to [ Computer/Printer] (□ 96) so the device type selection screen does not appear every time you connect the camcorder to a printer.
- Connection to a PictBridge-compatible printer will not work when the hard disk or memory card contains 1,800 photos or more. For best performance, we recommend keeping the number of photos under 100.



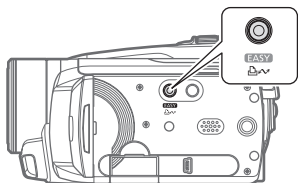

Printing with the (Print/Share) Button

You can print a photo without changing the settings simply by pressing .



1 Select () the photo you wish to print.

2 Press .

- Printing starts. The  button flashes and stays on when the printing is completed.
- To continue printing, select () another photo.

Selecting the Print Settings

You can select the number of copies and other settings for printing. Setting options vary depending on your printer model.



Options

[Paper Settings]

[ Paper Size]: Available paper sizes vary depending on the printer model.

[ Paper Type]: Select [Photo], [Fast Photo], [Plain] or [Default].

[ Page Layout]: Select [Default], [Bordered] or one of the following page layouts.

[Borderless]: The photo is enlarged and may be slightly cropped at the edges to fit the paper.

[x photos/sheet]: Refer to the sidebar on page 72.

[(Date print)]

Select [On], [Off] or [Default].

[(Print effect)]

Available only with printers compatible with the Image Optimize function. Select [On], [Off] or [Default].

Canon inkjet/SELPHY DS printers: You can also select [Vivid], [NR] and [Vivid+NR].

[] (Number of copies)

Select 1-99 copies.

NOTES

Print setting options and [Default] settings vary depending on the printer model. For details, refer to the printer's instruction manual.

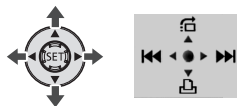

Printing after Changing the Print Settings



1 Press  to display the joystick guide.

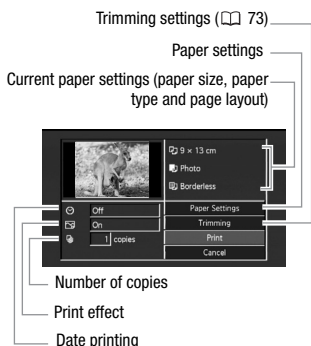

- 2 Push the joystick (▼) toward .**
The print settings menu appears.



- 3 In the print settings menu, select (▲▼, ◀▶) the setting you want to change and press .**
- 4 Select (▲▼) the desired setting option and press .**
- 5 Select (▲▼, ◀▶) [Print] and press .**
- Printing starts. The print settings menu disappears when the printing is completed.

- To continue printing, select (◀▶) another photo.

TO CANCEL THE PRINTING

- 1 Press  while printing.**
- 2 Select (◀) [OK] and press .**

WHEN YOU HAVE FINISHED PRINTING

Disconnect the cable from the camcorder and printer and turn off the camcorder.

PRINT ERRORS

If an error occurs while printing, an error message (for example, [No paper]) will appear on the camcorder's screen. Solve the problem referring to the error message list ( 110) and to the printer's instruction manual.

[x photos/sheet]: Printing multiple photos on the same sheet

When using Canon printers you can print the same photo multiple times on the same sheet of paper. Use the following table as a guideline for the recommended number of copies depending on the [ Paper Size] setting.

| [ Paper Size]→ | [CreditCard] | [9 x 13 cm] | [10 x 14.8 cm] | [A4] |
|--|------------------------|-------------|----------------------------|------|
| Canon printer ↓ | | | | |
| Inkjet printers SELPHY DS | – | – | 2, 4, 9 or 16 ¹ | 4 |
| SELPHY CP/ES | 2, 4 or 8 ² | 2 or 4 | 2 or 4 | – |

¹ You can also use the special sticker sheets.

² With the [8 photos/sheet] setting, you can also use the special sticker sheets.

SELPHY CP: When you use the wide-sized photo paper with the [Default] setting, you can also use [2 photos/sheet] or [4 photos/sheet].



- **Canon's PictBridge-compatible printers:** If printing does not resume automatically after you solved the problem, select [Continue] and press **SET** to resume printing. If that option is not available, select [Stop] and press **SET** and then restart printing from the beginning.
- **Other printers or if the error still persists with a Canon printer:** If printing does not resume automatically, disconnect the USB cable and turn off the camcorder. After a short while, turn on the camcorder and restore the USB connection.

! IMPORTANT

- You may not be able to print correctly with a PictBridge-compatible printer photos whose file names have been changed or that were recorded, created, edited or changed with any device other than this camcorder.
- If [Busy] does not disappear, disconnect the USB cable and restore the connection after a short while.

Trimming Settings

Set the paper size and page layout before changing the trimming settings. Trimming settings apply to one photo only.

1 Open the print settings menu.

Refer to steps 1-2 in *Printing after Changing the Print Settings* (□ 71).



2 Select (**▲▼**, **◀▶**) [Trimming] and press **SET**.

The trimming frame appears.

3 Change the size of the trimming frame.

- Move the zoom lever toward **T** to shrink the frame, and move it toward **W** to enlarge it. Press **SET** to change the orientation of the frame (portrait/landscape).
- To cancel the trimming settings, move the zoom lever toward **W** until the trimming frame disappears.



4 Move (**▲▼**, **◀▶**) the trimming frame to the area you want to print.

5 Press **FUNC** to return to the print settings menu.

- The print area selected will be indicated by a green frame within the thumbnail.
- To change other print settings and print the area you selected refer to steps 3-5 in *Printing after Changing the Print Settings* (□ 71).

i NOTES

- The trimming settings are canceled in the following cases:
 - When you turn off the camcorder.
 - When you disconnect the USB cable.
 - When you expand the trimming frame beyond its maximum size.
 - When you change the [Paper Size] setting.
- You may not be able to set the trimming settings for photos that were not recorded with this camcorder.

Print Orders

You can mark in advance the photos you want to print and set the desired number of copies as a print order. Later, you can easily print out the print orders by connecting the camcorder to a PictBridge-compatible printer (□ 70). You can set print orders for up to 998 photos.

**Selecting Photos for Printing (Print Order)**

Set the print orders before connecting the supplied USB cable to the camcorder.

Marking Single Photos with Print Orders**1 Open the photo selection screen.**

[FUNC.] > [Print Orders]
 appears on the screen.

2 Select (◀▶) the photo you want to mark with a print order.**3 Press (SET) to set the print order.**

The number of copies appears in orange.

4 Set (▲▼) the number of copies desired and press (SET).

To cancel the print order, set the number of copies to 0.

5 Repeat steps 2-4 to mark additional photos with print orders or press [FUNC.] twice to close the menu.**Setting Print Orders from the Index Screen****Options**

| |
|--|
| [Individual Photos] |
| Opens the same screen described in <i>Marking Single Photos with Print Orders</i> (□ 74). Continue from step 3 of that procedure to set the print order. |
| [Selected Photos (1 copy each)] |
| Sets a print order of 1 copy of each of the photos selected in advance (marked with a ✓ checkmark). Refer to <i>Selecting Recordings from the Index Screen</i> (□ 41). |
| [Remove All] |
| Removes all the print orders. |



[FUNC.] >
 Print Orders >
 Desired option > [Yes] > [OK] >
 [FUNC.]

Printing Photos Marked with Print Orders**1 Connect the camcorder to the printer using the supplied USB cable.**

Connection (D). Refer to *Connection Diagrams* (□ 77).

2 Open the print menu.

[FUNC.]  [Menu]   
[  Print]

- The print menu appears.
- If there are no photos marked with print orders, [No  print orders have been set] appears.
- Depending on the connected printer, you may be able to change some print settings ( 71).

3 Select (,) [Print] and press

.

Printing starts. The print menu disappears when the printing is completed.

NOTES

- To cancel the printing, refer to page 72.
- **Restarting printing:** Open the print menu as explained in step 2. In the print settings menu, select [Print]* or [Resume] and press . The remaining photos will be printed.

Printing cannot be restarted when the print order settings have been changed or if you deleted a photo with print order settings.

* In case the print order was interrupted after the first photo.



4



External Connections

This chapter explains how to connect your camcorder to an external device such as a TV, VCR, or computer.

Terminals on the Camcorder

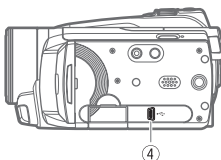
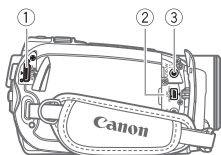

① HDMI OUT Terminal*

Access: Open the rear terminal cover.
The HDMI OUT terminal offers a high-quality digital connection that combines audio and video in a single convenient cable.



② COMPONENT OUT Terminal*

Access: Open the front terminal cover.
The component video terminal is for video only. When you use connection **(B)** do not forget the audio connections using the AV OUT/  terminal.



③ AV OUT/ Terminal

Access: Open the front terminal cover.
Sound from the built-in speaker will be muted while the STV-250N Stereo Video Cable is connected to the camcorder.



④ USB Terminal

Access: Open the LCD panel.

* When connecting a cable to the camcorder, make sure to align the triangle marks on the cable's connector and on the camcorder's terminal (▶ ◀).

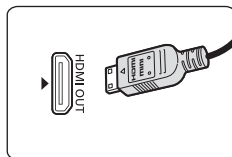
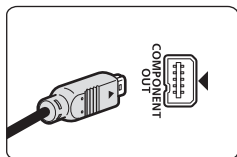



Connection Diagrams

Connections that can be used to connect the camcorder to a TV are listed in falling order of picture quality.

Connection A

Type: Digital • Quality: High definition • Output only

Connect to a high-definition TV (HDTV) with an HDMI input terminal.

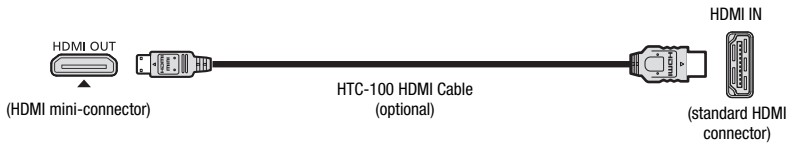

Connection B

Type: Analog • Quality: Depends on the settings • Output only





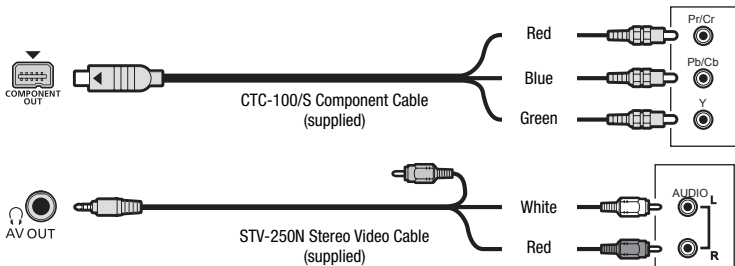

Connect to a high-definition TV (HDTV) or a standard TV with component video input terminals. Change the following settings on the camcorder:

- [TV] [Component Output] according to the TV set (standard or high definition) (94)
- [TV] [AV/Headphones] to [AV] (94)



Type: Analog • Quality: Standard definition • Output only
 Connect to a standard TV or a VCR with audio/video input terminals. Change the following settings on the camcorder:

Connection 

-   [AV/headphones] to [**AV** AV] ( 94).
-   [TV Type] according to the TV set (widescreen or 4:3), if the TV cannot automatically detect and change the aspect ratio ( 94)



In all respects, exactly the same connection as connection  above.
 Connect to a standard TV or VCR with SCART input terminal. Requires a SCART adapter (commercially available).

Connection 

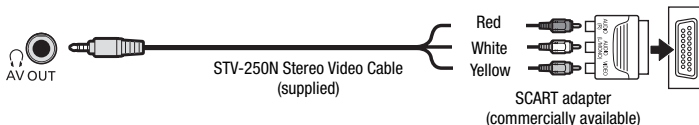

Type: Digital data connection
 Connect to a computer to transfer and back up your recordings, to the optional DW-100 DVD Burner to create DVD discs from them, or to a printer to print out photos.

Connection 





Playback on a TV Screen

Connect the camcorder to a TV to enjoy your recordings with family and friends. Playback on an HDTV using one of the high-definition connections will ensure the best playback quality.



1 Turn off the camcorder and the TV.

2 Connect the camcorder to the TV.

Refer to *Connection Diagrams* (□ 77) and select the most appropriate connection for your TV.



3 Turn on the connected TV.

On the TV, select as the video input the same terminal to which you connected the camcorder. Refer to the instruction manual of the connected TV.

4 Turn on the camcorder and set it to mode (□ 36) or mode (□ 61).



Start the playback of movies or photos.

NOTES

- We recommend powering the camcorder using the compact power adapter.
- Connection  or : When you play back your 16:9 movies on standard TV sets with a 4:3 aspect ratio, the TV set will switch automatically to widescreen mode if it is compatible with the WSS system. Otherwise, change the aspect ratio of the TV manually.

About the HDMI™ connection

The HDMI (High-Definition Multimedia Interface) connection () is a convenient all-digital connection using a single cable for both video and audio. When you connect the camcorder to an HDTV equipped with an HDMI terminal, you can enjoy video and audio playback at the highest quality.

- The HDMI OUT terminal on the camcorder is for output only. Do not connect it to an HDMI output terminal on an external device, as this may damage the camcorder.
- Correct operation cannot be guaranteed when connecting the camcorder to DVI monitors.
- Depending on the HDTV, correct playback of personal video content may not be possible using connection . Try one of the other connections.
- While the camcorder is connected to an HDTV using connection , there will be no video output from other terminals.

Saving and Backing Up Your Recordings

Backing Up Your Recordings on a Computer

Movies recorded with this camcorder are saved on the hard disk or memory card. Because space is limited, make sure to back up your movies onto a computer on a regular basis.

PIXELA ImageMixer 3 SE

With the software supplied on the **PIXELA ImageMixer 3 SE** CD-ROM you can select scenes and back them up on your computer's hard disk. If necessary, backup video files previously saved on a computer can be restored back to the camcorder. ImageMixer 3 offers also many options for organizing your video library, editing video and more.

For details about installing the software refer to **PIXELA ImageMixer 3 SE Installation Guide**.

Saving your Recordings without a Computer

The following options are also available:

- Use the optional DW-100 DVD Burner to create high-definition (AVCHD) discs of your movies and Photo DVDs of your photos (□ 80).
- Connect the camcorder to an external recording device (DVD or HDD recorder, VCR, etc.) to save standard-

definition copies of your movies (□ 84).

! IMPORTANT

When the camcorder is connected to a computer: Do not access, change or delete any of the camcorder's folders or files directly from the computer as this may result in permanent data loss. Always back up your recordings to the computer and restore the backup files to the camcorder using only the supplied software, ImageMixer 3.

Authoring High-Definition (AVCHD) Discs and Photo DVDs

You can connect the camcorder to the optional DW-100 DVD Burner to create high-definition DVD discs (AVCHD specifications). This way, you can preserve your video recordings in the highest video quality available. You can also create Photo DVDs from your photos that you can play back with most standard DVD players. Refer to this section along with the relevant sections in the instruction manual of the DW-100.





Options for creating AVCHD discs (mode)

| |
|--|
| [All Scenes] |
| Add all the scenes to the disc(s). |
| [Remaining Scenes] |
| Add only those scenes that have not been previously added to a disc. |
| [Playlist] |
| Add only the scenes included in the playlist (56). |

Options for creating Photo DVDs (mode)

| |
|---|
| [All Photos] |
| Add all the photos to the slideshow on the disc. |
| [Transfer Orders] |
| Add only photos marked with transfer orders (87). |

Preparations on the Camcorder

1 Turn on the camcorder and set it to mode to create high-definition discs of your movies or mode to create Photo DVDs of your photos.

- Power the camcorder using the compact power adapter.
- Select in advance the media that contains the recordings you want to add to the disc (38).

2 Select the scenes or photos you want to add to the disc.

[FUNC.] [Menu]
 or
[Add Recordings to Disc]
Desired option
[FUNC.]

Connecting to the DW-100 DVD Burner and Creating a Disc

1 Turn on the DVD Burner.

Refer to *Creating DVDs*.

2 Connect the camcorder to the DVD Burner using the supplied USB cable.

- Connection (). Refer to *Connection Diagrams* (77) and *Connections*.
- If the device type selection screen appears, select [DVD Burner] and press .
- When the connection is completed, [No disc] will be displayed.

3 Insert a brand new disc into the DVD Burner.

- Use the OPEN/CLOSE button on the DVD Burner to open and close the disc tray.
- After the disc is recognized, an information screen will display the type of DVD you are creating and the estimated time and number of discs it will require (based on the disc you inserted).
- If you inserted a DVD-RW disc that already contains data, [The disc already contains data.] will be displayed. To overwrite the data (erasing the previous content of the disc), press , select [Yes] and press again.

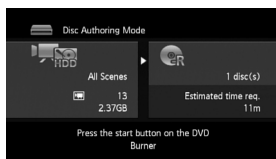

4 Press the start button on the DVD Burner.

- A progress bar will be displayed on the screen.
- After pressing the start button (while the current disc is being written) the operation cannot be canceled.
- When the last disc is finalized, [Task completed] will be displayed. Take out the disc and close the disc tray.

WHEN THE DATA REQUIRES MULTIPLE DISCS

After a disc is finalized it will be ejected automatically and a message will appear. Insert the next disc and close the disc tray.

TO CREATE AN ADDITIONAL COPY OF THE SAME DISC

After the operation is finished, insert a brand new disc, close the disc tray and repeat the operation.

! IMPORTANT

- To create discs that can be played back with AVCHD-compatible devices, add to the playlist in advance the scenes you want on the disc, leaving out all scenes recorded in MXP mode. Then, select the [Playlist] option to create the disc.
- AVCHD discs containing scenes recorded in MXP mode cannot be created with the optional DW-100 DVD burner. Use the supplied software ImageMixer 3 to back up such scenes.
- While the camcorder is connected to the DVD Burner, do not open the memory card slot cover and do not remove the memory card.
- Observe the following precautions while the ACCESS indicator on the camcorder is on or flashing. Failing to do so may result in permanent data loss.
 - Do not subject the camcorder to vibrations or strong impacts.
 - Do not open the memory card slot cover.
 - Do not disconnect the USB cable.
 - Do not disconnect the power source or turn off the camcorder or the DVD Burner.
 - Do not change the position of the mode dial.
- For important information on handling your discs, refer to **DW-100** > *Cautions on handling*.

Playing back high-definition (AVCHD) discs created with the DW-100 DVD Burner

| Type of external player → | DVD players or Blu-ray Disc players compatible with AVCHD | DVD players not compatible with AVCHD* |
|---|---|--|
| Disc content ↓ | | |
| Discs containing only scenes recorded in FXP/XP+/SP/LP mode | Can be played back | Cannot be played back* |

* Do not insert a disc into an incompatible device, as you may not be able to eject the disc.



i NOTES

If a scene does not fit entirely in one disc, it may be divided and continue on the next disc.

Playing Back AVCHD Discs Using the DW-100 DVD Burner

You can use the optional DW-100 DVD Burner and the camcorder also to play back high-definition (AVCHD) discs on a TV. This is very convenient, for example to play back your discs even in a location where an AVCHD-compatible DVD player is not available.



1 Connect the camcorder to the TV.

Refer to *Connection Diagrams* (□ 77). Select connection **(A)** or **(B)** to enjoy high-definition playback.

2 Turn on the DVD Burner and set it to Disc Playback mode.

[DW-100] Refer to *Playing DVDs*.

3 Connect the camcorder to the DVD Burner using the supplied USB cable.

- Connection **(D)**. Refer to *Connection Diagrams* (□ 77) and **[DW-100]** *Connections*.
- If the device type selection screen appears, select [DVD Burner] and press **(SET)**.

4 Insert the disc you want to play back into the DVD Burner.

- Use the OPEN/CLOSE button on the DVD Burner to open and close the disc tray.
- After the disc is recognized, the disc's content will be displayed in an index screen.

5 Select (▲▼, ◀▶) the scene you want to play back and press (SET) to begin the playback.

! IMPORTANT

While the camcorder is connected to the DVD Burner, do not open the memory card slot cover and do not remove the memory card.

i NOTES

- Only AVCHD discs created with the DW-100 DVD Burner can be played back using the DVD Burner.
- The FUNC. menu and setup menus cannot be accessed while the camcorder is connected to the DVD Burner.
- With the exception of fast playback at 60x speed, special playback modes (□ 37) can be used also for disc playback.

TO PLAY BACK PHOTO DVDs

Photo DVDs are created using DVD-Video specifications (standard definition). Play back your Photo DVDs using standard DVD players.

If your computer has a DVD drive, you can play back the slideshow as a DVD and you can also access individual photos as JPG files.

i NOTES

Photo DVDs cannot be played back using the DW-100 DVD Burner.

Copying your Recordings to an External Video Recorder

You can copy your recordings by connecting the camcorder to a VCR or a digital video device. Video output will be in standard definition, although the original scenes are in high definition.



Connecting

Connect the camcorder to the VCR using Connection or . Refer to *Connection Diagrams* (□□ 77).

Recording

- External device: Load a blank cassette or disc and set the device to record pause mode.**
- Camcorder: Locate the scene you wish to copy and pause playback shortly before the scene.**
- Camcorder: Resume playback.**
- External device: Begin recording when the scene you wish to copy appears. Stop recording when copying is complete.**
- Camcorder: Stop playback.**

NOTES

- We recommend powering the camcorder using the compact power adapter.
- By default, on-screen displays will be embedded in the output video signal. You can change the displays by repeatedly pressing (□□ 51).

Transferring Photos to a Computer (Direct Transfer)

With the software supplied on the **DIGITAL VIDEO Solution Disk** CD-ROM you can transfer photos to a computer simply by pressing . Refer also to the relevant sections in the “Digital Video Software” instruction manual (PDF file).



Preparations

Install the software before you connect the camcorder to the computer for the first time. (Windows users only: you also need to select CameraWindow's auto-launch setting.) After that, just connect the camcorder to the computer (steps 2 and 3) and proceed directly to transfer the photos (□□ 86).

- Install the supplied Digital Video Software.**
 Refer to *Installing the Digital Video Software*.
- Set the camcorder to mode.**
- Select the media that contains the photos you want to transfer.**
 - Select the (hard disk) or (memory card) tab (□□ 38) and move the zoom lever toward **T** to return to single photo view.
- Connect the camcorder to the computer using the supplied USB cable.**
 - Connection . Refer to *Connection Diagrams* (□□ 77).



- If the device type selection screen appears, select [Computer/Printer] and press **SET**.
- The direct transfer menu appears on the camcorder screen and the button lights up.

FIRST-TIME CONNECTION TO A COMPUTER RUNNING WINDOWS

Windows users only: The first time you connect the camcorder to the computer, you also need to select the CameraWindow auto-launch setting.

DVSD > Refer to *Starting CameraWindow*.

! IMPORTANT

- While the camcorder is connected to the computer, do not open the memory card slot cover and do not remove the memory card.
- Observe the following precautions while the ACCESS indicator is on or flashing. Failing to do so may result in permanent data loss.
 - Do not subject the camcorder to vibrations or strong impacts.
 - Do not open the memory card slot cover.
 - Do not disconnect the USB cable.
 - Do not turn off the camcorder or the computer.
 - Do not change the position of the mode dial.
- Operation may not work correctly depending on the software and the specifications/settings of your computer.
- If you wish to use the image files on your computer, make copies of them first. Use the copied files, retaining the originals.

- During the following operations, even if you connect the camcorder to the computer it will not be recognized.
 - Deleting all photos
 - Removing all transfer orders
 - Removing all print orders

i NOTES

- We recommend powering the camcorder using the compact power adapter.
- Refer also to the computer's instruction manual.
- **Users of Windows Vista, Windows XP and Mac OS X:** Your camcorder is equipped with the standard Picture Transfer Protocol (PTP) allowing you to transfer photos (JPEG only) simply by connecting the camcorder to a computer using the supplied USB cable, without having to install the supplied software.
- If you have no intention to use the optional DW-100 DVD Burner, you can set or [USB Connection Type] to [Computer/Printer] (p. 93) so the selection screen does not appear every time you connect the camcorder to a computer.
- Depending on the number of photos on the memory card (Windows: 1,800 photos or more; Macintosh: 1,000 photos or more), you may not be able to transfer photos to a computer. Try using a card reader.

Transferring Photos



Automatic Transfer Options

All the relevant photos will be transferred to the computer in one batch and their thumbnails will be displayed on the computer.

| |
|---|
| [📷 All Photos] |
| Transfers all photos. |
| [📷 New Photos] |
| Transfers only those photos that have not yet been transferred to the computer. |
| [📷 Photos with Transfer Orders] |
| Transfers photos marked with transfer orders (📷 87). |

Manual Transfer Options

You can select the photo(s) to transfer.

| |
|--|
| [📷 Select and Transfer] |
| Select the photo(s) to transfer. |
| [📷 Set as Desktop Wallpaper] |
| Select a photo and set it as your computer's desktop background. |

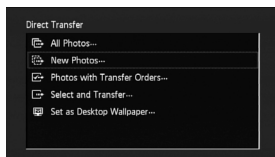
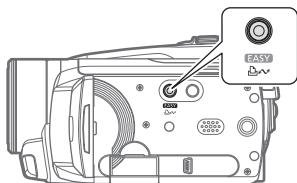

AUTOMATIC TRANSFER OPTIONS

Select (▲▼) a transfer option and press [📷].

- The camcorder returns to the transfer menu once the transfer is completed.
- To cancel the transfer, select (◀▶) [Cancel] and press [SET], or press [FUNC].

MANUAL TRANSFER OPTIONS

- 1 Select (▲▼) a transfer option and press [📷].
- 2 Select (◀▶) the photo you wish to transfer and press [📷].
 - [📷 Select and Transfer]: Repeat this step to select other photos to transfer.
 - The 📷 button will flash while the photos are being transferred.
- 3 Press [FUNC.] to return to the transfer menu.

NOTES

When the camcorder is connected to the computer and the photo selection screen is displayed, press [FUNC.] to return to the transfer menu.



Transfer Orders

You can mark in advance the photos you want to transfer to the computer as transfer orders. You can set transfer orders for up to 998 photos.



Selecting Photos to Transfer (Transfer Order)

Set the transfer orders before connecting the camcorder to the computer.

Marking Single Photos with Transfer Orders

1 Open the photo selection screen.

[FUNC.] ➤ [Transfer Orders]

[Transfer Orders] appears on the screen.

2 Select (◀▶) the photo you want to mark with a transfer order.

3 Press (SET) to set the transfer order.

A checkmark ✓ appears in the box next to the transfer order icon [Transfer Orders].

Press (SET) again to cancel the transfer order.

4 Repeat steps 2-3 to mark additional photos with transfer orders or press [FUNC.] twice to close the menu.

Setting Transfer Orders from the Index Screen

Options

[Individual Photos]

Opens the same screen described in *Marking Single Photos with Transfer Orders* (□ 87). Continue from step 3 of that procedure to set the transfer order.

[Selected Photos]

Marks all the photos selected in advance (marked with a ✓ checkmark) with a transfer order. Refer to *Selecting Recordings from the Index Screen* (□ 41).

[Remove All]

Removes all the transfer orders.

[FUNC.] ➤

[Transfer Orders] ➤

Desired option ➤ [Yes] ➤ [OK] ➤

[FUNC.]

TO TRANSFER PHOTOS MARKED WITH TRANSFER ORDERS

Connect the camcorder to the computer and select [Photos with Transfer Orders] in the transfer menu (□ 86).



Additional Information

This chapter contains troubleshooting advice, screen messages, handling and maintenance tips, and other information.

Appendix: Menu Options Lists

Menu items not available appear grayed out. For details about how to select an item, refer to *Using the Menus* (□ 26). For details about each function, see the reference page. Menu options without a reference page are explained below the tables.

FUNC. Menu - Recording Modes



| Menu item | Setting options | | | |
|---------------------|---|---|---|----|
| Recording programs | [P Programmed AE], [TV Shutter-Priority AE], [AV Aperture-Priority AE] | ● | ● | 44 |
| | [Cine Mode] | ● | – | 45 |
| | [Portrait], [Sports], [Night], [Snow], [Beach], [Sunset], [Spotlight], [Fireworks] | ● | ● | 43 |
| Light metering mode | [Evaluative], [Center-Weighted Average], [Spot] | – | ● | 67 |
| | [Automatic], [Daylight], [Shade], [Cloudy], [Tungsten], [Fluorescent], [Fluorescent H], [Custom WB] | ● | ● | 48 |
| Image effects | [Image Effect Off], [Vivid], [Neutral], [Low Sharpening], [Soft Skin Detail], [Custom Effect] | ● | ● | 49 |
| Digital effects | [Digital Effect Off], [Fade Trigger], [Wipe], [B&W], [Sepia], [Art] | ● | – | 50 |
| | [Digital Effect Off], [B&W], [Sepia] | – | ● | |
| Drive mode | [Single], [Continuous Shooting], [Hi-Speed Continuous Shooting], [Auto Exposure Bracketing] | – | ● | 65 |



| Menu item | Setting options | | | |
|------------------------|---|---|---|----|
| Recording mode | [MP High Quality 24 Mbps], [FP High Quality 17 Mbps], [XP+ High Quality 12 Mbps], [SP Standard Play 7 Mbps], [LP Long Play 5 Mbps] | ● | – | 33 |
| Simultaneous recording | [Simultaneous Recording Off], [LW 1920x1080], [SW 848x480] [Super Fine], [Fine], [Normal] | ● | – | 66 |
| Photo size/quality | [LW 1920x1080], [L 2048x1536], [M 1440x1080], [S 640x480] [Super Fine], [Fine], [Normal] | – | ● | 60 |

FUNC. Menu - Playback Modes













| Menu item | Setting options | | | |
|--------------------------------|---|---|---|----|
| [Select] | [Individual Scenes], [Remove All Selections] From the index screen: [Individual Photos], [Remove All Selections] | ● | – | 41 |
| [Copy (→)] | Original movies: [All Scenes], [All Scenes (this date)], [This Scene], [Selected Scenes] Playlist: [No], [Yes] From the index screen: [All Photos], [This Photo], [Selected Photos] From single photo view: [No], [Yes] | ● | – | 58 |
| [Add to Playlist] ¹ | [All Scenes (this date)], [This Scene], [Selected Scenes] | ● | – | 56 |
| [Divide] ¹ | – | ● | – | 55 |
| [Move] ² | – | ● | – | 57 |
| [Protect] | From single photo view: – From the index screen: [Individual Photos], [Selected Photos], [Remove All] | – | ● | 68 |
| [Print Orders] | From single photo view: 0-99 copies From the index screen: [Individual Photos], [Selected Photos (1 copy each)], [Remove All] | – | ● | 74 |

| Menu item | Setting options |  |  |  |
|-------------------|---|---|---|---|
| [Transfer Orders] | From single photo view: – From the index screen: [Individual Photos], [Selected Photos], [Remove All] | – | ● | 87 |
| [Delete] | Original movies: [All Scenes], [All Scenes (this date)], [This Scene], [Selected Scenes] | ● | – | 42 |
| | Scenes in the playlist: [All Scenes], [This Scene] | ● | – | 57 |
| | From the index screen: [All Photos], [This Photo], [Selected Photos] | – | ● | 63 |
| [Scene Search] | [Calendar Screen], [Date Selection] | ● | – | 39 |

¹ Option available only from the original movies index screen.

² Option available only from the playlist index screen.

/ Camera Setup 1

| Menu item | Setting options |  |  |  |
|--------------------------|---|---|---|---|
| [Rec Media for Movies] | [HDD], [Mem. Card] | ● | ● | 31 |
| [Rec Media for Photos] | [HDD], [Mem. Card] | ● | ● | |
| [Frame Rate] | [50i 50i (Standard)], [PF25 PF25] | ● | – | – |
| [Self Timer] | [ON On ], [OFF Off] | ● | ● | 46 |
| [Focus Assist Functions] | [ON On], [OFF Off] | ● | ● | – |
| [Onscreen Markers] | [OFF Off], [ Level (White)], [ Level (Gray)], [ Grid (White)], [ Grid (Gray)] | ● | ● | – |
| [Audio Level Indicator] | [ON On], [OFF Off] | ● | – | 52 |
| [Photo Review Time]* | [OFF Off], [ 2 sec], [ 4 sec], [ 6 sec], [ 8 sec], [ 10 sec] | – | ● | – |

* Option available only when the drive mode is set to Single.

[Frame Rate]: Selects the frame rate to be used when recording.

[PF25 PF25]: 25 frames per second, progressive. Using this frame rate will give your recordings a cinematic look. When combined with the [ Cine Mode] recording program (45), the cinematic look will be enhanced.

[Focus Assist Functions]: When the focus assist functions are activated, the image at the center of the screen is magnified and outlines are emphasized to help you focus manually (47).

- Using the focus assist functions will not affect the recordings - they will be cancelled when you start recording.



[Onscreen Markers]: You can display a grid or a horizontal line at the center of the screen. Use the markers as a reference to make sure your subject is framed correctly (vertically and/or horizontally).

- Using the onscreen markers will not affect the recordings.

[Photo Review Time]: Selects the time to display a photo after it has been recorded on the hard disk or memory card.

- If you press **[DISP.]** while reviewing a photo it will continue to be displayed indefinitely. Press **[PHOTO]** halfway to return to the normal display.

/ Camera Setup 2

| Menu item | Setting options | | | |
|-------------------------|--|---|---|----|
| [Digital Zoom] | [OFF Off], [40x 40x], [200x 200x] | ● | – | – |
| [Zoom Speed] | [VAR Variable], [>>> Speed 3], [>> Speed 2], [> Speed 1] | ● | ● | 34 |
| [AF Mode] | [IAF Instant AF], [AF Normal AF] | ● | ● | – |
| [Focus Priority] | [AiAF AiAF Frames], [CF Center Frame], [OFF Off] | – | ● | – |
| [Image Stabilizer] | [ON On], [OFF Off] | ● | ● | – |
| [Auto Slow Shutter] | [ON On], [OFF Off] | ● | ● | – |
| [Wind Screen] | [A Automatic], [OFF Off] | ● | – | – |
| [Microphone Attenuator] | [ON On ATT], [OFF Off] | ● | – | – |

[Digital Zoom]: Determines the operation of the digital zoom. The color of the indicator indicates the zoom.

- When activated, the camcorder will switch automatically to digital zoom when you zoom in beyond the optical zoom range.
- With the digital zoom the image is digitally processed, so the image resolution will deteriorate the more you zoom in.

| Optical zoom | Digital zoom | |
|--------------|--------------|------------|
| | | |
| White | Light blue | Dark blue |
| Up to 12x | 12x - 40x | 40x - 200x |

[AF Mode]: Select how fast the autofocus will operate.

- With [**IAF** Instant AF] the autofocus adjusts quickly to a new subject. This is convenient for example when changing the focus from a near subject to a far subject in the background, or when recording fast-moving subjects.
- When the optional Wide-converter or Tele-converter is attached to the camcorder, it may partially obstruct the Instant AF sensor. Set the AF mode to [**AF** Normal AF].

[Focus Priority]: When the focus priority is activated, the camcorder records a photo only after the focus has been adjusted automatically. You can also select which AF frames to use.

[ AiAF Frames]: One or more AF frames out of the nine frames available are automatically selected and the focus is fixed on them.

[ Center Frame]: A single focusing frame appears in the center of the screen and the focus is automatically fixed on it.

[ Off]: No AF frame will appear and the photo will be recorded immediately after you press **[PHOTO]**.



- When the recording mode is set to [ Fireworks], focus priority is automatically set to [ Off].

[Image Stabilizer]: The image stabilizer compensates for camcorder shake even at full telephoto.

- The image stabilizer is designed to compensate for a normal degree of camcorder shake.
- We recommend setting the image stabilizer to [ Off] when using a tripod.



[Auto Slow Shutter]: The camcorder automatically uses slow shutter speeds to obtain brighter recordings in places with insufficient lighting.

• The setting will not change even if you set the camcorder to **[EASY]** mode.



• In **[ mode]**, set the flash mode to **[]** (flash off).

• If a trailing afterimage appears, set the slow shutter to [ Off].

• If **[]** (camcorder shake warning) appears, we recommend stabilizing the camcorder, for example, by mounting it on a tripod.

| Operating mode | Shutter speed used |
|--|--------------------|
|  mode | As low as 1/25 |
|  mode with [PF25 PF25] frame rate | As low as 1/12 |
|  mode | |

[Wind Screen]: The camcorder automatically reduces the background sound of wind when recording outdoors.

• Some low-frequency sounds will be suppressed along with the sound of wind. When recording in surroundings unaffected by wind or if you want to record low-frequency sounds, we recommend setting the wind screen to [ Off ].

[Microphone Attenuator]: Helps prevent audio distortions in due to high audio recording levels.

• Set the microphone attenuator to [**ON** On] when the audio recording level (**[ 51**]) is set correctly but the audio still sounds distorted. When the microphone attenuator is activated, **[ATT]** appears on the screen.

/ Playback Setup

| Menu item | Setting options | | | |
|--------------------------|--|---|---|----|
| [Rec Media for Photos] | [HDD], [Mem. Card] | ● | – | 31 |
| [Photo Capture Quality] | [Super Fine], [Fine], [Normal] | ● | – | – |
| [Data Code] | [Date], [Time], [Date and Time], [Camera Data] | ● | – | – |
| [USB Connection Type] | [DVD Burner], [Computer/Printer], [Connect and Set] | ● | ● | – |
| [Add Recordings to Disc] | [All Scenes], [Remaining Scenes], [Playlist] | ● | – | 80 |
| | [All Photos], [Transfer Orders] | – | ● | |
| [Print] | – | – | ● | 74 |

[Photo Capture Quality]: Select the quality of a photo captured from a scene.

[Data Code]: Displays the date and/or time when the scene was recorded.

[Camera Data]: Displays the aperture (f-stop) and shutter speed used when recording the scene.









[USB Connection Type]: Select the connection protocol to use when connecting the camcorder to an external device using the supplied USB cable.

[DVD Burner]: To connect exclusively to the optional DW-100 DVD Burner.

[Computer/Printer]: To connect to a computer, printer or similar USB peripheral.

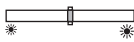
[Connect and Set]: To make the selection from a screen that appears at the time of the connection to the external device.

 System Setup 1

| Menu item | Setting options |  |  |  |  |  |
|---|---|---|---|---|---|---|
| [Font Size] | [A Large], [A Small] | ● | ● | ● | ● | – |
| [Output Onscreen Displays] | [ON On], [OFF Off] | ● | ● | – | – | – |
| [LCD Brightness] |  | ● | ● | ● | ● | – |
| [Language  | [ČEŠTINA], [DEUTSCH], [ΕΛΛΗΝΙΚΑ] [ENGLISH], [ESPAÑOL], [FRANÇAIS], [ITALIANO], [MAGYAR], [MELAYU], [POLSKI], [ROMÂNĂ], [TÜRKÇE], [РУССКИЙ], [УКРАЇНСЬКА], [العربية], [فارسی], [ភាសាខ្មែរ], [简体中文], [繁體中文], [한국어], [日本語] | ● | ● | ● | ● | 28 |
| [Component Output]* | [576i 576i], [1080i 1080i] | ● | ● | ● | ● | – |
| [TV Type]* | [4:3 Normal TV], [16:9 Wide TV] | – | – | ● | – | – |
| [AV/Headphones] | [AV AV], [ Headphones] | ● | – | ● | – | 52 |
| [Headphone Volume] |  | ● | – | ● | – | 53 |
| [Speaker Volume] |  | – | – | ● | – | – |
| [Demo Mode] | [ON On], [OFF Off] | ● | ● | – | – | – |

* Option not available when the camcorder is connected to an HDTV using the HDMI cable.

[Font Size]: Changes the size of the font for the menu and other screens.

- When the font size is set to [**A** Large], some information may be displayed in shortened form (icons only, etc.). Some screens cannot be displayed using the larger font size.

[Output Onscreen Displays]

- When set to [**ON** On], the camcorder's on-screen displays will appear also on the screen of a TV or monitor connected to the camcorder.

[LCD Brightness]: Adjusts the brightness of the LCD screen.

- Changing the brightness of the LCD screen does not affect the brightness of your recordings, the brightness of the viewfinder (**[HG21]** only) or the brightness of the playback image on a TV.

[Component Output]: You can select the video specifications to use when connecting the camcorder to a high-definition TV using the component video connection.

[**576i** 576i]: To use the 576i specification (standard definition).

[**1080i** 1080i]: To use the full 1080i high definition specification.

[TV Type]: In order to display the picture in full and in the correct aspect ratio, select the setting according to the type of television to which you will connect the camcorder.

[**4:3** Normal TV]: TV sets with 4:3 aspect ratio.



[16:9 Wide TV]: TV sets with 16:9 aspect ratio.

- When the TV type is set to [4:3 Normal TV], during the playback of video originally recorded with an aspect ratio of 16:9, the picture will not be displayed full screen.
- When the TV type is set to [4:3 Normal TV], photos cannot be captured from the playback scene (□ 67). Set it to [16:9 Wide TV] before capturing the photos.

[Speaker Volume]: Adjust (◀▶) the volume of the playback. You can also adjust the volume using the joystick guide (□ 37).

[Demo Mode]: The demonstration mode displays the camcorder's main features. It starts automatically when the camcorder is powered with the compact power adapter if you leave it turned on for more than 5 minutes.

- To cancel the demo mode once it has started, press any button or turn off the camcorder.

System Setup 2

| Menu item | Setting options | | | | | |
|---------------------------------|--|---|---|----------------|---|-----------|
| [Wireless Remote Control] | [ON], [Off] | ● | ● | ● | ● | – |
| [Notification Sounds] | [High Volume], [Low Volume], [Off] | ● | ● | ● | ● | – |
| [Power Saving Mode] | [ON], [Off] | ● | ● | ● | ● | – |
| [Quick Start] | [Off], [10 min], [20 min], [30 min] | ● | ● | – | – | – |
| [Control for HDMI] ¹ | [ON], [Off] | ● | ● | ● | ● | – |
| [Initialize /] | [HDD], [Mem. Card], [Cancel] [Quick Initialization], [Complete Initialization], [Cancel] | ● | ● | ● ² | ● | 31 |
| [Photo Numbering] | [Reset], [Continuous] | ● | ● | ● | ● | – |
| [Drop Sensor] | [ON], [Off] | ● | ● | ● | ● | 6, 113 |
| [Firmware] | – | – | – | – | ● | – |

¹ Option not available when the camcorder is connected to an HDTV using the HDMI cable.

² Option available only from the original movies index screen.

[Wireless Remote Control]: Allows the camcorder to be operated with the wireless controller.

[Notification Sounds]: A beep will accompany some operations like turning on the camcorder, the self-timer countdown, etc.



[Power Saving Mode]: In order to save power when the camcorder is powered by a battery pack, it will automatically shut off if left without any operation for 5 minutes.

- Approximately 30 seconds before the camcorder shuts off, [Auto power off] will appear.

- In standby mode, the camcorder will shut off after the time selected for the [Quick Start] setting.

[Quick Start]: Select whether to activate the Quick Start function when you close the LCD panel in a recording mode ( 35) and the length of time after which the camcorder will end the standby mode and shut off automatically.

[Control for HDMI]: Activates the HDMI-CEC (Consumer Electronics Control) function. When you connect the camcorder to an HDTV compatible with HDMI-CEC using an HDMI cable, you can control the camcorder's playback using the TV's remote control. Also, turning on the camcorder will automatically turn on the TV and select the camcorder's video input and turning off the TV will automatically turn off the camcorder.

- Use the up/down/left/right buttons and the OK or SET button on the TV's remote control to play back your recordings.
- Depending on the TV set, additional settings may be required on the TV itself to activate the HDMI-CEC function. Refer to the TV's instruction manual.
- Correct operation of the HDMI-CEC function cannot be guaranteed even when connecting the camcorder to compatible TV sets. If you cannot use the TV's remote control, operate the camcorder directly or use the camcorder's wireless controller.
- The remote control of the TV can only be used to play back movies or photos ( or  mode only). If the camcorder is connected to the TV while it is set to  mode, depending on the TV used, turning off the TV will automatically turn off the camcorder even if it is recording at the time.





[Photo Numbering]: Select the photo numbering method to be used on a new memory card. Photos are automatically assigned consecutive numbers from 0101 to 9900, and stored in folders containing up to 100 photos. Folders are numbered from 101 to 998.

[ Reset]: Photo numbers will restart from 101-0101 every time you insert a new memory card.

[ Continuous]: Photo numbers will continue from the number following that of the last photo recorded with the camcorder.

- If the memory card you insert already contains a photo with a larger number, a new photo will be assigned a number one higher than that of the last photo on the memory card.
- We recommend using the [ Continuous] setting.

[Drop Sensor]: Detects when the camcorder is dropped and activates a protection mechanism to help prevent hard disk damage. While the mechanism is active,  appears in red on the screen and playback/recording may stop.

- Keep the drop sensor set to [ ON On] in most situations. Deactivating this function can increase the likelihood of hard disk damage should the camcorder be dropped.
- When the drop sensor is set to [ ON On], recording/playback may stop when the camcorder approaches a weightless state, which the sensor can detect as a fall or drop. To record under such situations, set the drop sensor to [ OFF Off ].

[Firmware]: You can verify the current version of the camcorder's firmware. This menu option is usually unavailable.

Date/Time Setup

| Menu item | Setting options | | | | | |
|----------------------|--|---|---|---|---|----|
| [Time Zone/DST] | List of world time zones. | ● | ● | ● | ● | 29 |
| [Date/Time] | – | ● | ● | ● | ● | 28 |
| [Date Format] | [Y.M.D (2008.1.1 AM 12:00)], [M.D,Y (Jan. 1, 2008 12:00 AM)], [D.M.Y (1.Jan.2008 12:00 AM)] | ● | ● | ● | ● | – |
| [Calendar Start Day] | [Saturday], [Sunday], [Monday] | – | – | ● | – | – |

[Date Format]: Select the date format to be used for most on-screen displays, and (if selected) for the date printed on photos.

[Calendar Start Day]: Select the day on which the week starts for the calendar display (39).

Information Screens

| Menu item | Setting options | | | | | |
|--------------------|-----------------|---|---|---|---|---|
| [HDD Info] | – | ● | ● | ● | ● | – |
| [Memory Card Info] | – | ● | ● | ● | ● | – |
| [Battery Info] | – | ● | ● | ● | ● | – |
| [HDMI Status] | – | ● | ● | ● | ● | – |

[HDD Info]/[Memory Card Info]: Displays a screen where you can verify how much of the hard disk or the memory card is currently in use (total recording time and total number of photos) and how much space remains available for recording.

- Estimated figures about available movie recording time and available number of photos are approximate and based on the recording mode and photo quality/size settings currently in use.
- In the [Memory Card Info] screen you can verify also the Speed Class of the memory card.

[Battery Info]: Displays a screen where you can verify the battery charge (as a percentage) and the remaining recording time (, mode) or playback time (, mode).

[HDMI Status]: Displays a screen where you can verify the standard of the video output signal from the HDMI OUT terminal.

Troubleshooting



If you have a problem with your camcorder, refer to this section. Sometimes what you think is a malfunction of the camcorder may have the simplest of solutions - please read the "CHECK THIS FIRST" box before going on to the more detailed problems and solutions. Consult your dealer or a Canon Service Center if the problem persists.

CHECK THIS FIRST



Power supply

Is the battery charged? Is the compact power adapter correctly connected to the camcorder? (□ 21)

Recording

Did you turn the camcorder on and set the mode dial to  or ? If you are recording on a memory card, is one correctly inserted into the camcorder? (□ 30)

Playback

Did you turn the camcorder on and set the mode dial to  or ? If you are playing back recordings from a memory card, is one correctly inserted into the camcorder? (□ 30) Does it contain any recordings?

Power source

The camcorder will not turn on or it turns off by itself.

- The battery pack is exhausted. Replace or charge the battery pack (□ 21).
- Remove the battery pack and reattach it correctly.

Cannot charge the battery pack.

- Make sure the camcorder is off so charging can start.
- The battery pack is too hot. Charging will start once the battery pack temperature is below 40 °C.
- Charge the battery pack in temperatures between 0 °C and 40 °C.
- The battery pack is damaged. Use a different battery pack.

A noise can be heard from the compact power adapter.

- A faint sound can be heard while the compact power adapter is connected to a power outlet. This is not a malfunction.

After using the camcorder for a long time, it becomes hot.

- This is not a malfunction. Turn off the camcorder and let it cool down before resuming use.

The battery pack is exhausted extremely quickly even at normal temperatures.

- The battery may have reached the end of its battery life. Buy a new battery pack.



Recording

Pressing **[Start/Stop]** will not start recording.

- You cannot record while the camcorder is writing previous recordings on the hard disk/memory card (while the ACCESS indicator is on or flashing).
- The recording media is full or it already contains the maximum number of scenes. Delete some recordings (□ 42, 63) or initialize the recording media (□ 31) to free some space.
- Recording may not be possible while the drop protection mechanism (□ 96) is active (🔒 appears).
- The camcorder has exceeded its operational temperature (🔥 appears). Turn off the camcorder and let it cool down before resuming use.
- The camcorder has fallen below its operational temperature (❄️ appears). Turn it off and use it in a warmer location. Make sure to avoid rapid temperature changes.

The point where **[Start/Stop]** was pressed does not match the beginning/end of the recording.

- There is a slight interval between pressing **[Start/Stop]** and the actual start of recording. This is not a malfunction.

The recording suddenly stops shortly after starting recording.

- If recording near loud sounds or strong vibrations, move to another location.
- The camcorder has exceeded its operational temperature (🔥 appears). Turn off the camcorder and let it cool down before resuming use.

The camcorder will not focus.

- Autofocus does not work on the subject. Focus manually (□ 47).
- **[C2]** Adjust the viewfinder with the dioptic adjustment lever (□ 33).
- The lens or Instant AF sensor is dirty. Clean the lens or sensor with a soft lens-cleaning cloth (□ 117). Never use tissue paper to clean the lens.

When a subject flits across in front of the lens, the image appears slightly bent.

- This is a phenomenon typical of CMOS image sensors. When a subject crosses very quickly in front of the camcorder, the image may seem slightly warped. This is not a malfunction.

Changing the operating mode between recording (●)/record pause (●|||)/playback (▶) takes longer than usual.

- When the media contains a large number of scenes, some operations may take longer than usual. Back up your recordings (□ 80) and initialize the recording media (□ 31).

Reviewing the last scene recorded takes longer than usual.



- When the media contains a large number of scenes, some operations may take longer than usual. Back up your recordings (□ 80) and initialize the recording media (□ 31).

Cannot record a photo.

- In **[📷]** mode: You cannot take photos in this mode if the simultaneous recording option in the FUNC. menu is set to [Simultaneous Recording Off] (□ 66), or if either the digital zoom (□ 91) or a digital effect (□ 50) is activated.

Playback

Pressing the playback button does not start playback.

- The camcorder has exceeded its operational temperature ( appears). Turn off the camcorder and let it cool down before resuming use.
- The camcorder has fallen below its operational temperature ( appears). Turn it off and use it in a warmer location. Make sure to avoid rapid temperature changes.



Cannot add scenes to the playlist.

- You cannot add more than 999 scenes to the playlist. If the playlist includes scenes recorded in MXP or FXP mode, the maximum number of scenes in the playlist may be less than 999.
- You may not be able to add scenes to the playlist if they were recorded or edited using another device.

Cannot delete a scene.

- You may not be able to delete scenes recorded or edited using another device.

Deleting scenes takes longer than usual.

- When the media contains a large number of scenes, some operations may take longer than usual. Back up your recordings ( 80) and initialize the recording media ( 31).

Cannot delete a photo.

- The photo is protected. Remove the protection ( 68).

Indicators and Onscreen Displays



lights up in red.

- Battery pack is exhausted. Replace or charge the battery pack ( 21).

appears on the screen.

- The camcorder cannot communicate with the battery pack attached so the remaining battery time cannot be displayed.

lights up in red.

- A memory card error occurred. Turn off the camcorder. Remove and reinsert the memory card. Initialize the memory card ( 31) if the display does not change back to normal.
- The memory card is full. Replace the memory card or delete some recordings ( 42, 63) to free some space on the memory card.

lights up in red.

- The camcorder has exceeded its operational temperature. This is not a malfunction. Turn off the camcorder and let it cool down before resuming use.

flashes in red on the screen.

- The camcorder has malfunctioned. Consult a Canon Service Center.

Even after stopping recording, the ACCESS indicator does not go off.

- The scene is being recorded on the hard disk/memory card. This is not a malfunction.

The camcorder is on and the ACCESS indicator has been on or flashing longer than usual.

- This is not a malfunction. The camcorder may be recovering data on the hard disk. Do not disconnect the power source or turn off the camcorder.



The CHG (charge) indicator flashes rapidly.

-  (one flash at 0.5-second intervals)

Charging has stopped because the compact power adapter or the battery pack is faulty. Consult a Canon Service Center.

The CHG (charge) indicator flashes very slowly.

-  (one flash at 2-second intervals)

The battery pack is too hot. Charging will start once the battery pack temperature is below 40 °C.

- Charge the battery pack in temperatures between 0 °C and 40 °C.
- The battery pack is damaged. Use a different battery pack.

The CHG (charge) indicator does not turn on even though a battery pack is attached.

- The camcorder cannot communicate with the battery pack attached. Such battery packs cannot be charged using this camcorder.

Picture and Sound

Screen displays turn on and off repeatedly.

- The battery pack is exhausted. Replace or charge the battery pack (□ 21).
- Remove the battery pack and reattach it correctly.

Abnormal characters appear on the screen and the camcorder does not operate properly.

- Disconnect the power source and reconnect it after a short time. If the problem still persists, disconnect the power source and press the RESET button with a pointed item. Pressing the RESET button resets all settings.

Video noise appears on screen.

- Keep a distance between the camcorder and devices that emit strong electromagnetic fields (plasma TVs, cellular phones, etc.).

Horizontal bands appear on the screen.

- This is a phenomenon typical of CMOS image sensors when recording under some types of fluorescent, mercury or sodium lamps. To reduce the symptoms set the camcorder to **EASY** mode. This is not a malfunction.

HG21 No picture appears on the viewfinder.

- Press **VIEWFINDER** to activate the viewfinder (□ 33).

HG21 Viewfinder picture is blurred.

- Adjust the viewfinder with the dioptic adjustment lever (□ 33).

Sound is distorted or is recorded at lower levels.

- When recording near loud sounds (such as fireworks, shows or concerts), sound may become distorted or it may not be recorded at the actual levels. Activate the microphone attenuator (□ 92) or adjust the audio recording level manually (□ 51).

Noise can be heard.

- If the camcorder is moved suddenly while recording, sound from the hard disk may be recorded.

The hard disk's rotation can be heard faintly.

Occasionally, the camcorder's operation sound can be heard.

- When recording onto the hard disk or playing back recordings from it, the hard disk is activated from time to time. This is not a malfunction.

The picture is displayed correctly but there is no sound from the built-in speaker.

- Open the LCD panel.
- Speaker volume is turned off. Adjust the volume (□□ 37).
- If the STV-250N Stereo Video Cable is connected to the camcorder, disconnect it.

A rattling can be heard from the camcorder.

- The internal lens fixture can move when the camcorder is turned off. This is not a malfunction.

The camcorder vibrates.





- When recording onto the hard disk or playing back recordings from it, the camcorder may vibrate occasionally. This is not a malfunction.

Memory Card and Accessories



Cannot insert the memory card.

- The memory card was not facing the correct direction. Turn the memory card over and insert it (□□ 30).

Cannot record on the memory card.

- The memory card is full. Delete some recordings (□□ 42, 63) to free some space or replace the memory card.
- Initialize the memory card (□□ 31) when you use it with the camcorder for the first time.
- The LOCK switch on an SD or SDHC memory card is set to prevent accidental erasure. Change the position of the LOCK switch (□□ 116).
- The folder and file numbers have reached their maximum value. Set   [Photo Numbering] to [Reset] (□□ 96) and insert a new memory card.
- The simultaneous recording option in the FUNC. menu is set to [Simultaneous Recording Off]. Change the setting to take photos while recording video (□□ 66).
- Photos cannot be captured from the playback scene when   [TV Type] is set to [Normal TV]. In such case,  appears. Set it to [Wide TV] (□□ 94).

The wireless controller will not work.

- Set   [Wireless Remote Control] to [On].
- Replace the battery of the wireless controller.

Connections with External Devices

Video noise appears on the TV screen.

- When using the camcorder in a room where a TV is located, keep a distance between the compact power adapter and the power or antenna cables of the TV.

Playback looks fine on the camcorder but there is no image on the TV screen.

- The video input on the TV is not set to the video terminal to which you connected the camcorder. Select the correct video input.

There is no sound from the TV.



- When connecting the camcorder to an HDTV using the CTC-100/S Component Cable, make sure to connect also the audio connections using the white and red plugs of the STV-250N Stereo Video Cable.





The camcorder is connected using the optional HTC-100 HDMI Cable, but there is no picture or sound from the HDTV.

- Disconnect the HTC-100 HDMI Cable and then restore the connection or turn the camcorder off and then on again.



The camcorder is connected using the optional HTC-100 HDMI Cable, but HDMI-CEC does not work (cannot play back using the TV's remote control).

- Disconnect the HTC-100 HDMI cable and turn off the camcorder and the TV. After a short while turn them on again and restore the connection.
-   [Control for HDMI] is set to [Off]. Set it to [On] (□□ 96).
- HDMI-CEC is not activated on the connected TV. Activate this function on the TV.
- Even with TV sets compatible with HDMI-CEC the range of functions available differs depending on the type of TV. Refer to the instruction manual of the connected TV.

The computer doesn't recognize the camcorder even though the camcorder is connected correctly.

-  or   [USB Connection Type] is set to [DVD Burner]. Set it to [Computer/Printer] or to [Connect and Set] (□□ 93).
- Disconnect the USB cable and turn off the camcorder. After a short while, turn it on again and restore the connection.
- Connect the camcorder to a different USB port on the computer.

The printer is not working even though the camcorder and printer are connected correctly.

-  or   [USB Connection Type] is set to [DVD Burner]. Set it to [Computer/Printer] or to [Connect and Set] (□□ 93).
- Disconnect the USB cable and turn off the printer. After a short while turn it on again and restore the connection.

The camcorder doesn't recognize the DW-100 DVD Burner even though it is connected correctly.

-  or   [USB Connection Type] is set to [Computer/Printer]. Set it to [DVD Burner] or to [Connect and Set] (□□ 93).

List of Messages (in alphabetical order)

Following the list of messages for the camcorder you can find separate lists for print-related messages (□ 110) and for messages that appear only when using the optional DW-100 DVD Burner (□ 109).

Access error

- There was an error when reading the hard disk or attempting to write onto it.
- This message can also appear if condensation has formed (□ 118). Wait until the camcorder dries completely before resuming use.

Accessing the memory card. Do not remove the memory card.

- You opened the memory card slot cover while the camcorder was accessing the memory card or the camcorder started accessing the memory card as you opened the memory card slot cover. Do not remove the memory card until this message disappears.

Avoid moving the camcorder

- Try not to move the camcorder while the image is being recorded.

Back up recordings regularly

- This message may appear when you turn on the camcorder. In the event of a malfunction, recordings may be lost so back up your recordings regularly.

Buffer overflow. Recording was stopped.

- While recording on the hard disk, drops were detected repeatedly and the buffer became full. Move to a more stable location and allow data to be written onto the hard disk. If you are using the camcorder in such a situation that vibrations or drop-like conditions (for example, weightlessness) are likely to occur, set [Drop Sensor] to [Off] (□ 96).
- The data transfer rate was too high for the memory card in use and the recording was stopped. Replace the memory card with one rated Speed Class 2 or higher.

Cannot access the HDD

- There is a problem with the hard disk.

Cannot communicate with the battery pack. Continue using this battery pack?

- You attached a battery pack that is not recommended by Canon for use with this camcorder.

Cannot copy

- The total size of the scenes you selected to copy exceeds the available space on the memory card. Delete some recordings on the memory card (□ 42, 63) or reduce the number of scenes to copy (□ 58).

Cannot divide the scene. Initialize only using the camcorder.

- The scene could not be divided because the camcorder's internal scene management data log is full. Back up your recordings (□ 80) and initialize the recording media (□ 31). Write back the backup files and try dividing the scene again.

Cannot edit

- Cannot divide original scenes and cannot move/delete original scenes or scenes in the playlist of the selected media.

**Cannot edit Check the memory card**

- The memory card in the camcorder was initialized using a computer. Initialize the memory card with this camcorder (□ 31).

Cannot enter standby mode now

- The camcorder cannot enter standby mode if the remaining battery charge is too low.

Cannot play back

- There is a problem with the hard disk/memory card.

Cannot play back due to high temperature

- The camcorder has exceeded its operational temperature (Ⓢ appears). Turn off the camcorder and let it cool down before resuming use.

Cannot play back Cannot access the HDD

- There is a problem with the hard disk.

Cannot play back Check the memory card

- There is a problem with the memory card.

Cannot play the movies on the HDD Initialize only using the camcorder

- The camcorder's hard disk was initialized using a computer. Initialize the hard disk with this camcorder (□ 31).

Cannot play the movies on this memory card

- Movies cannot be played back from a 64 MB or smaller memory card.

Cannot play the movies on this memory card Initialize only using the camcorder

- The memory card in the camcorder was initialized using a computer. Initialize the memory card with this camcorder (□ 31).

Cannot read the HDD

- The hard disk could not be read.
- This message can also appear if condensation has formed (□ 118). Wait until the camcorder dries completely before resuming use.
- This message can also appear if the camcorder has exceeded its operational temperature (Ⓢ appears). Turn off the camcorder and let it cool down before resuming use.

Cannot record

- There is a problem with the recording media.
- This message can also appear if condensation has formed (□ 118). Wait until the camcorder dries completely before resuming use.

Cannot record due to high temperature

- The camcorder has exceeded its operational temperature. Disconnect the compact power adapter and remove the battery pack. Let the camcorder cool down before resuming use.

Cannot record movies in MXP/FXP mode on this memory card

- Movies cannot be recorded in MXP or FXP mode on a memory card if it is rated Speed Class 2. Select a different recording mode (□ 33) or replace the memory card with one rated Speed Class 4 or higher.

Cannot record movies on the HDD (Initialize only using the camcorder)

- The camcorder's hard disk was initialized using a computer. Initialize the hard disk with this camcorder (□ 31).

Cannot record movies on this memory card

- Movies cannot be recorded on a 64 MB or smaller memory card.

Cannot record movies on this memory card Initialize only using the camcorder

- The memory card in the camcorder was initialized using a computer. Initialize the memory card with this camcorder (□ 31).

Cannot record Cannot access the HDD

- There is a problem with the hard disk.



Cannot record Check the memory card

- There is a problem with the memory card.

Change the battery pack

- Battery pack is exhausted. Replace or charge the battery pack (□ 21).

Check the memory card

- Cannot access the memory card. Check the memory card and make sure it is inserted correctly (□ 30).
- A memory card error occurred. The camcorder cannot record or display the image.
- You inserted a MultiMedia Card (MMC) into the camcorder. Replace it with an SD/SDHC memory card compatible for use with this camcorder (□ 29).
- If after the message disappears,  appears in red, perform the following: Turn off the camcorder and remove and reinsert the memory card. If  turns back to green you can resume recording/playback.
- Initialize the memory card (□ 31). (Doing so will erase all the recordings on the memory card.)

Connect the compact power adapter

- When the camcorder is in  mode and is connected to a computer, this message will appear if the camcorder is being powered by the battery pack. Connect the compact power adapter to the camcorder.

Could not add the scene(s) to the playlist

- One or more scenes could not be added to the playlist (□ 56). You cannot add more than 999 scenes to the playlist. If the playlist includes scenes recorded in MXP or FXP mode, the maximum number of scenes in the playlist may be less than 999. Delete some recordings (□ 42, 63).

Data includes scenes in MXP/FXP mode. Cannot copy to this memory card.

- Movies recorded in MXP or FXP mode cannot be copied onto a memory card if it is rated Speed Class 2. Replace the memory card with one rated Speed Class 4 or higher.

Data is protected

- Scenes edited or protected using another device cannot be deleted with this camcorder.

Do not disconnect the USB cable or the power source while the camcorder is connected to a computer.

Cannot turn off the camcorder or change the operating mode.

- When the camcorder is in  mode and is connected to the computer with the supplied USB cable, the camcorder cannot be operated. Disconnecting the USB cable or power source while this message appears may result in permanent loss of the recordings in the camcorder. Use the computer's Safely Remove Hardware function to end the connection and disconnect the USB cable before using the camcorder.

Drop detected. Power was turned off.





- When the camcorder is dropped while it is on, the camcorder automatically turns off to protect the hard disk. This message appears the next time the camcorder is turned on. This is not a malfunction.



Error writing on the memory card. Data may be recovered if the memory card has not been removed. Attempt recovering the data?

- This message will appear the next time you turn on the camcorder if power supply was accidentally interrupted while the camcorder was writing on the memory card. Select [Yes] to try to recover the recordings. If you removed the memory card and used it with another device after this happened, we recommend you select [No].

File name error

- The folder and file numbers have reached their maximum value. Set  [Photo Numbering] to [Reset] ( 96) and delete all the photos on the memory card ( 63) or initialize it ( 31).



Function not available in **EASY mode**

- You pressed a button that cannot be used in **EASY** mode (while the **EASY** button's blue light is on). Press the **EASY** button to set the camcorder to flexible recording mode.

HDD error

- There is a problem with the hard disk. Initialize the hard disk ( 31).

HDD is full

- The hard disk is full ("END" appears on the screen). Delete some recordings ( 42,  63) to free some space.

Initialize only using the camcorder

- There is a problem with the file system that prevents accessing the selected media. Initialize the recording media with this camcorder ( 31).

May not be possible to record movies on this memory card

- You may not be able to record movies on a memory card without a Speed Class rating. Replace the memory card with one rated Speed Class 2 or higher.

Memory card cover is open

- After inserting a memory card, close the memory card slot cover ( 30).



Memory card is full

- The memory card is full. Delete some recordings ( 42,  63) to free some space or replace the memory card.

Memory card is write-protected

- The LOCK switch on an SD or SDHC memory card is set to prevent accidental erasure. Change the position of the LOCK switch ( 116).

Memory card Number of scenes already at maximum

- The memory card already contains the maximum number of scenes; no further scenes can be copied onto the memory card. Delete some recordings ( 42,  63) to free some space.

Memory card Unable to recognize the data

- The memory card contains scenes recorded in a different television system (NTSC).

Need to recover files from the memory card. Change the position of the LOCK switch on the memory card.

- This message will appear the next time you turn on the camcorder if power supply was accidentally interrupted while the camcorder was writing on the memory card and later the position of the card's LOCK switch was changed to prevent erasure. Change the position of the LOCK switch ( 116).

No memory card

- There is no memory card in the camcorder.

No photos

- There are no photos to play back.

No scenes

- There are no scenes in the recording media selected.

Number of scenes already at maximum

- The maximum number of scenes has been reached. Delete some scenes (□ 42) to free some space.

Operation canceled

- The operation was canceled following user intervention.

Playlist is full. Cannot divide the scene.

- Scenes cannot be divided when the playlist already contains 999 scenes. Delete some scenes from the playlist (□ 57).

Reading the HDD

- Reading data from the hard disk.

Reading the memory card

- Reading data from the memory card.

Scene recorded using another device. Cannot divide the scene.

- Scenes recorded using another device cannot be divided with this camcorder.

Some  photos could not be deleted

- Protected photos () cannot be deleted. Remove the protection (□ 68).

Some scenes could not be deleted

- Movies that were protected/edited with other devices cannot be deleted with this camcorder.

Task in progress. Do not disconnect the power source.

- The camcorder is updating the hard disk/memory card. Do not disconnect the compact power adapter or remove the battery pack.

Temperature too high. Turn off the camcorder and wait.

- The camcorder has exceeded its operational temperature. Disconnect the compact power adapter and remove the battery pack. Let the camcorder cool down before resuming use.



Temperature too low. Keep the camcorder on and wait.

- The camcorder's temperature is too low. Keep the power on until the  icon disappears.

Temperature too low. Use the camcorder in a warmer location.

- The outside temperature is too low and the camcorder will not operate. Move to a location between 0 °C and 40 °C.

The camcorder is set to photo mode

- You pressed  while recording photos ( mode).

The drop sensor is turned off

- The camcorder was turned on while  [Drop Sensor] is set to [Off ]. In such case, dropping the camcorder can increase the likelihood of hard disk damage.





The lens cover is not fully closed. Turn the camcorder off, then on again.

- The lens cover did not close completely when you set the camcorder to a playback mode. Turn the camcorder off and then on again. If the problem persists, contact a Canon Service Center.

The lens cover is not fully open. Turn the camcorder off, then on again.

- The lens cover did not open completely when you set the camcorder to a recording mode. Turn the camcorder off and then on again. If the problem persists, contact a Canon Service Center.

This  photo could not be deleted

- Protected photos () cannot be deleted. Remove the protection ( 68).

This photo cannot be displayed

- You may not be able to display photos taken with other devices or image files created or edited on a computer.

Too many photos. Disconnect the USB cable.

- Disconnect the USB cable. Try using a memory card reader or decrease the number of photos on the memory card (Windows: fewer than 1,800 photos, Macintosh: fewer than 1,000 photos). If a dialog box appeared on the computer screen, close it and then reconnect the USB cable.

 **Transfer order error**

- You attempted to set more than 998 transfer orders. Reduce the number of photos marked with transfer orders.

Unable to recognize the data

- You transferred data to the camcorder recorded in a different television system (NTSC).

Unable to recover data

- Could not recover a corrupted file.
- This message can also appear if condensation has formed ( 118). Wait until the camcorder dries completely before resuming use.

Messages Related to the Optional DW-100 DVD Burner

If an error message appears while the camcorder is connected to the optional DW-100 DVD Burner, refer to the following section and also to the instruction manual of the DVD Burner.

Cannot read the disc. Check the disc.

- During disc recording mode, this message can appear when a commercially available DVD disc (a DVD disc containing movies, software, etc.) or an 8 cm mini DVD disc is inserted.
- During disc playback mode, this message can appear when a commercially available DVD disc or a brand new DVD disc is inserted.

Close the memory card slot cover

- The memory card slot cover is open. Close the cover after correctly inserting the memory card ( 30).

Connect the compact power adapter

- The camcorder is being powered by the battery pack. Connect the compact power adapter to the camcorder.

Disc access failure. Check the disc.

- There was an error when reading the disc or attempting to write onto it.
- This message can appear also if condensation has formed (□□ 118). Wait until the DVD burner dries completely before resuming use.
- The disc may not be loaded correctly. Try removing the disc and reinserting it.

Error reading the data

- Error while reading the recordings from the camcorder.
- Check that the USB cable was not accidentally disconnected.

No disc

- Insert a disc into the DVD Burner.
- This message can appear also if condensation has formed (□□ 118). Wait until the DVD burner dries completely before resuming use.

No photos

- There are no photos to add to the disc.

No scenes

- There are no movies to add to the disc.

No scenes left to add

- There are no scenes that have not already been added to discs created previously.

No transfer orders

- No photos have been marked with transfer orders (□□ 87).

Operation canceled

- The USB cable was disconnected and the operation was canceled. Check the USB connection.

Reading the disc

- Reading data from the disc.

Unable to recover data

- Could not recover a corrupted file.

Direct Print Related Messages

Cannot print this photo

- You attempted to print a photo that was recorded with another camcorder, has a different compression, or was edited on a computer.



Cannot trim this photo

- You attempted to trim a photo that was recorded with another camcorder.

Check print settings

- Current print settings cannot be used for printing with the   button.

Data transfer error

- The printer is experiencing a data transfer error. Cancel printing, disconnect the USB cable and turn off the printer. After a while, turn the printer back on and reconnect the USB cable. When you are printing using the   button, check the print settings.
- You attempted to print from a memory card that contains a large number of photos. Reduce the number of photos.

**File error**

- You attempted to print a photo that was recorded with another camcorder, has a different compression, or was edited on a computer.

Hardware error

- Cancel printing. Turn off the printer and turn it back on. Check the printer status. If the printer is equipped with a battery, it might be exhausted. In such case, turn off the printer, replace the battery and turn it back on.

Incompatible paper size

- The paper settings of the camcorder conflict with the printer's settings.

Ink absorber full

- Select [Continue] to resume printing. Consult a Canon Service Center (refer to the list included with the printer) to replace the ink absorber.

Ink error

- There is a problem with the ink. Replace the ink cartridge.

Low ink level

- The ink cartridge needs to be replaced soon. Select [Continue] to restart printing.

No print orders have been set

- No photos have been marked with a print order.

No ink

- The ink cartridge is not inserted or is out of ink.

No paper

- Paper is not correctly inserted or there is no paper.

Paper error

- There is a problem with the paper. The paper is not correctly loaded or the paper size is wrong. Alternatively, if the paper output tray is closed, open it to print.

Paper jam

- The paper jammed during printing. Select [Stop] to cancel printing. After removing the paper, set some paper again and retry printing.

Paper lever error

- Paper lever error occurred. Adjust the paper selection lever to the proper position.

X photos could not be printed

- You attempted to use the print order settings to print X photos that were recorded with another camcorder, with a different compression or were edited on a computer.

Print head not installed

- No print head is installed in the printer or the print head is defective.

Print order error

- You attempted to set more than 998 photos in the print order.

Printer cover open

- Close the printer cover securely.



Printer error

- A malfunction has occurred that may require repairs. (Canon inkjet printers: the printer's green power lamp and orange error lamp flash alternately.)
- Disconnect the USB cable and turn off the printer. Unplug the printer's power cord from the power outlet and contact the appropriate customer support center or service center.

Printer in use

- The printer is in use. Check the printer status.

Printing error

- Cancel printing, disconnect the USB cable and turn off the printer. After a while, turn the printer back on and reconnect the USB cable. Check the printer status.
- When you are printing using the   button, check the print settings.

Readjust trim settings

- The trimming settings for this photo were lost as a result of changes in the paper-related settings.

 **NOTES**

About Canon Inkjet/SELPHY DS Printers: If the printer's error indicator flashes or an error message appears on the printer's operation panel, refer to the printer's instruction manual.

- If you cannot solve the problem even after consulting this list and the printer's instruction manual, contact the closest Canon Service Center (refer to the list included with the printer).



Handling Precautions

Camcorder

Make sure to observe the following precautions to ensure maximum performance. Make sure to also observe the precautions pertaining to the hard disk, as hard disk damage may result in permanent data loss.

- **Back up your recordings periodically.** Make sure to transfer your recordings to an external device such as a computer or digital video recorder (□ 80) and back them up on a regular basis and especially after making important recordings. This will protect your important recordings in case of damage and create more free space on the hard disk or memory card. Canon shall not be liable for any data loss.
- **Do not subject the camcorder to vibrations or strong impacts.** The hard disk is a high-precision device. Vibrations, strong impacts or dropping the camcorder may result in the hard disk not being recognized or may cause recording/playback to stop unexpectedly. Be especially careful while the ACCESS indicator is on or flashing. Avoid recording in very loud places. When using a shoulder strap, do not allow the camcorder to swing and hit an object.
- **Keep the drop sensor activated whenever possible.** This camcorder is equipped with a sensor that detects acceleration. Should the camcorder be dropped or subject to a similar condition, a mechanism designed to help prevent hard disk damage will activate and recording/playback may stop or the camcorder may turn off. Deactivating this function (□ 96) can increase the likelihood of hard disk damage should the camcorder be subject to such conditions. Even if this function is set to [ON On], hard disk damage can occur if the camcorder is dropped.
- **Do not use the camcorder in very loud places.** When using the camcorder in extremely loud surroundings, recording/playback may stop unexpectedly. In such case, you can continue recording on the memory card.
- **Do not disconnect the power source while the camcorder is on.** Always turn the camcorder off before removing the battery pack or compact power adapter.
- **Do not turn off the camcorder while the ACCESS indicator is on or flashing or while the camcorder is in standby mode.** While data is being written onto the hard disk, disconnecting the power source or turning off the camcorder may result in hard disk damage or permanent data loss.

- **Use the camcorder within its operating temperature range.** If the camcorder's temperature becomes too hot or too cold, recording/playback may stop in order to prevent hard disk damage. In such case, a warning will appear on the screen.
- **Do not use the camcorder at high altitudes.** To prevent hard disk damage, do not turn on or use the camcorder at altitudes higher than 3,000 m above sea level or in other places with low atmospheric pressure.
- **Initialize the hard disk when movies cannot be recorded/played back normally.** As movies are recorded and deleted over time, hard disk fragmentation may occur, which may reduce performance. Initialize the hard disk should this happen (□ 31). When you initialize the hard disk, all recordings will be erased. Before doing so, back up important recordings using an external device.
- Do not carry the camcorder by the LCD panel or the viewfinder (HG21 only). Be careful when closing the LCD panel.
- Do not leave the camcorder in places subject to high temperatures (like the inside of a car under direct sunlight), or high humidity.
- Do not use the camcorder near strong electromagnetic fields such as above TVs, near plasma TVs or mobile phones.
- Do not point the lens or viewfinder (HG21 only) at strong light sources. Do not leave the camcorder pointed at a bright subject.
- Do not use or store the camcorder in dusty or sandy places. The

camcorder is not waterproof – avoid also water, mud or salt. If any of the above should get into the camcorder it may damage the camcorder and/or the lens.

- Be careful of heat generated by lighting equipment.
- Do not disassemble the camcorder. If the camcorder does not function properly, consult qualified service personnel.
- Handle the camcorder with care. Do not subject the camcorder to shocks or vibrations as this may cause damage.
- When mounting the camcorder on a tripod, make sure that the tripod's fastening screw is shorter than 5.5 mm. Using other tripods may damage the camcorder.

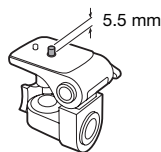

- **When recording movies, try to get a calm, stable picture.** Excessive camcorder movement while shooting and extensive use of fast zooms and panning can result in jittery scenes. In extreme cases, the playback of such scenes may result in visually induced motion sickness. If you experience such a reaction, immediately stop the playback and take a rest break as necessary.

Long-term storage

If you do not intend to use the camcorder for a long time, store it in a place free of dust, in low humidity, and at temperatures not higher than 30 °C.



Battery Pack

DANGER!

Treat the battery pack with care.

- Keep it away from fire (or it might explode).
 - Do not expose the battery pack to temperature higher than 60 °C. Do not leave it near a heater or inside a car in hot weather.
 - Do not try to disassemble or modify it.
 - Do not drop it or subject it to shocks.
 - Do not get it wet.
-
- Dirty terminals may cause a poor contact between the battery pack and the camcorder. Wipe the terminals with a soft cloth.



Long-term storage

- Store battery packs in a dry place at temperatures no higher than 30 °C.
- To extend the battery life of the battery pack, discharge it completely before storing it.
- Charge and discharge all your battery packs fully at least once a year.

Remaining battery time

If the remaining battery time displayed is not correct, charge the battery pack fully. However, the correct time may not be displayed if a fully charged battery pack is used continuously in high temperatures or it is left unused for long periods of time. Additionally, depending on the battery life, the correct time may not be displayed. Use the time shown on the screen as an approximation.

Regarding the use of non-Canon battery packs

- For your safety, battery packs that are not genuine Canon battery packs will not be charged even if you attach them to this camcorder or to the optional CG-800E Battery Charger.
- We recommend using genuine Canon battery packs bearing the  Intelligent Li-Ion Battery mark.
- If you attach to the camcorder battery packs that are not genuine Canon battery packs,  will appear and the remaining battery time will not be displayed.

Memory Card

- We recommend backing up the recordings on the memory card onto your computer. Data may be corrupted or lost due to memory card defects or exposure to static electricity. Canon shall not be liable for lost or corrupted data.
- Do not touch or expose the terminals to dust or dirt.
- Do not use memory cards in places subject to strong magnetic fields.
- Do not leave memory cards in places subject to high humidity and high temperature.
- Do not disassemble, bend, drop, or subject memory cards to shocks and do not expose them to water.

- Check the direction before inserting the memory card. Forcing a memory card into the slot if it is not correctly oriented may damage the memory card or the camcorder.
- Do not attach any labels or stickers on the memory card.
- SD/SDHC memory cards have a physical switch to prevent writing on the card so as to avoid the accidental erasure of the card's content. To write-protect the memory card set the switch to the LOCK position.



Built-in Rechargeable Lithium Battery

The camcorder has a built-in rechargeable lithium battery to keep the date/time and other settings. The built-in lithium battery is recharged while you use the camcorder; however, it will become totally discharged if you do not use the camcorder for about 3 months.

To recharge the built-in lithium battery:

Connect the compact power adapter to the camcorder and leave it connected for 24 hours with the camcorder off.

Lithium Button Battery

WARNING!

- The battery used in this device may present a fire or chemical burn hazard if mishandled.
 - Do not disassemble, modify, immerse in water, heat above 100 °C or incinerate the battery.
 - Replace with a CR2025 battery made by Panasonic, Hitachi Maxell, Sony, Sanyo, or with Duracell2025. Use of other batteries may present a risk of fire or explosion.
 - Do not insert the battery into the mouth. If swallowed, seek medical assistance immediately. The battery case may break and the battery fluids may cause internal injuries.
 - Keep the battery out of the reach of children.
 - Do not recharge, short-circuit or insert the battery in the wrong direction.
 - The used battery should be returned to the supplier for safe disposal.
-
- Do not pick up the battery using tweezers or other metal tools, as this will cause a short circuit.
 - Wipe the battery with a clean dry cloth to ensure proper contact.



Disposal

When you delete movies or initialize the hard disk or memory card, only the file allocation table is altered and stored data is not physically erased. Take the necessary precautions when you dispose of the camcorder or memory card, for example by physically damaging it to prevent the leakage of private data.

If giving the camcorder to another person, initialize the built-in hard disk or memory card using the [Complete Initialization] option (□ 31). Fill it up with unimportant recordings, and then initialize it again using the same option. This makes recovering the original recordings very difficult.

Maintenance/Others

Cleaning

Camcorder Body

- Use a soft, dry cloth to clean the camcorder body. Never use chemically treated cloths or volatile solvents such as paint thinner.

Lens, Viewfinder (**HG21** only) and Instant AF Sensor

- If the lens surface or Instant AF sensor is dirty, autofocus may not work properly.
- Remove any dust or dirt particles using a non-aerosol type blower brush.
- Use a clean, soft lens-cleaning cloth to gently wipe the lens or viewfinder. Never use tissue paper.

LCD Screen

- Clean the LCD screen using a clean, soft lens-cleaning cloth.
- Condensation may form on the surface of the screen when the temperature changes suddenly. Wipe it with a soft dry cloth.

Condensation

Moving the camcorder rapidly between hot and cold temperatures may cause condensation (water droplets) to form on its internal surfaces. Stop using the camcorder if condensation is detected. Continued use may damage the camcorder.

Condensation may form in the following cases:

- When the camcorder is moved quickly from cold to warm places
- When the camcorder is left in a humid room
- When a cold room is heated rapidly

TO AVOID CONDENSATION

- Do not expose the camcorder to sudden or extreme changes in temperature.
- Place the camcorder in an airtight plastic bag and let it adjust gradually to temperature changes before removing it from the bag.

WHEN CONDENSATION IS DETECTED

The camcorder automatically shuts off. The precise time required for water droplets to evaporate will vary depending on the location and weather conditions. As a general rule, wait for 2 hours before resuming use of the camcorder.

Using the Camcorder Abroad

Power Sources

You can use the compact power adapter to operate the camcorder and to charge battery packs in any country with power supply between 100 and 240 V AC, 50/60 Hz. Consult a Canon Service Center for information on plug adapters for overseas use.

Playback on a TV Screen

You can only play back your recordings on TVs compatible with the PAL system. PAL (or the compatible SECAM system) is used in the following regions/countries:

Europe: All of Europe and Russia.

Americas: Only in Argentina, Brazil, Uruguay and French territories (French Guiana, Guadeloupe, Martinique, etc.).

Asia: Most of Asia (except in Japan, the Philippines, South Korea, Taiwan and Myanmar).

Africa: All of Africa and African islands.

Australia/Oceania: Australia, New Zealand, Papua New Guinea; most Pacific islands (except for Micronesia, Samoa, Tonga and US territories like Guam and American Samoa).



System Diagram (Availability differs from area to area)

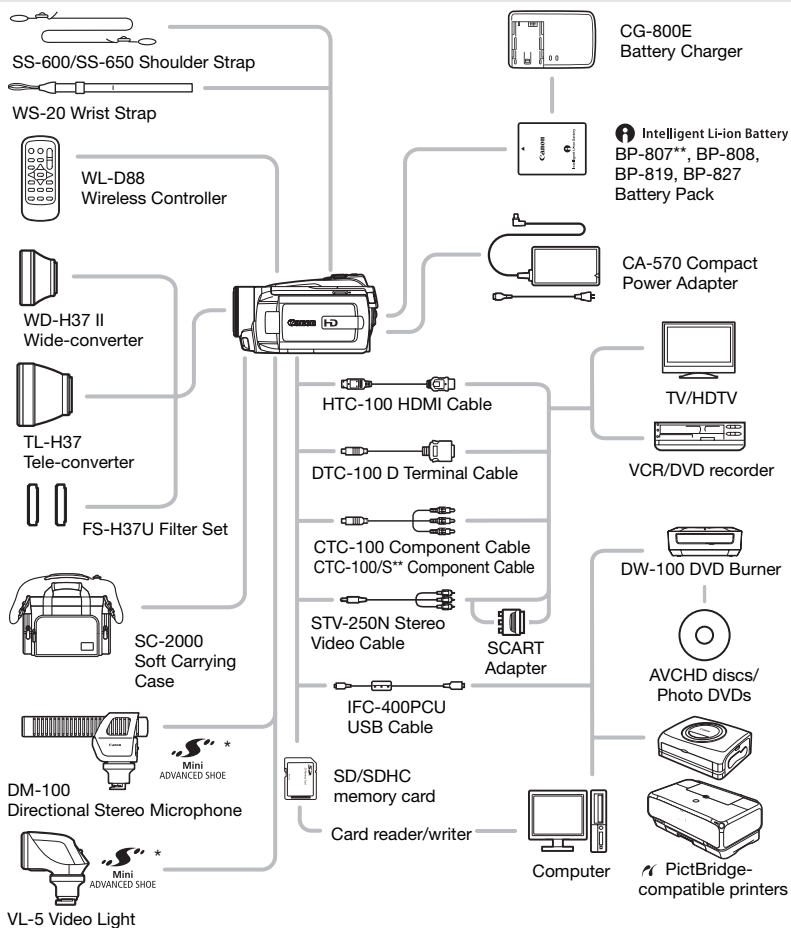

* Accessories that are compatible with the Advanced Accessory Shoe cannot be attached to this camcorder. Look for the **Mini ADVANCED SHOE** logo to ensure compatibility with the mini advanced shoe.

** Supplied with the camcorder; not available as an optional accessory.

Optional Accessories

Use of genuine Canon accessories is recommended.

This product is designed to achieve excellent performance when used with genuine Canon accessories. Canon shall not be liable for any damage to this product and/or accidents such as fire, etc., caused by the malfunction of non-genuine Canon accessories (e.g., a leakage and/or explosion of a battery pack). Please note that this warranty does not apply to repairs arising out of the malfunction of non-genuine Canon accessories, although you may request such repairs on a chargeable basis.

Battery Packs

When you need extra battery packs, select one of the following models: BP-808, BP-819 or BP-827.

 Intelligent Li-ion Battery

When you use battery packs bearing the Intelligent System mark, the camcorder will communicate with the battery and display the remaining usage time (accurate to 1 minute). You can only use and charge these battery packs with camcorders and chargers compatible with Intelligent System.

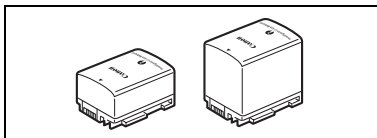

CG-800E Battery Charger

Use the battery charger to charge the battery packs.

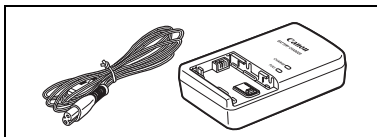

Charging Times

The charging times given in the following table are approximate and vary according to charging conditions and initial charge of the battery pack.

| Battery pack→ | BP-807 | BP-808 | BP-819 | BP-827 |
|-----------------------------------|----------|----------|----------|----------|
| Charging conditions↓ | | | | |
| Using the camcorder | 155 min. | 155 min. | 275 min. | 395 min. |
| Using the CG-800E Battery Charger | 105 min. | 105 min. | 190 min. | 260 min. |



Recording and Playback Times

Recording and playback times given in the following tables are approximate and vary according to recording mode and charging, recording or playback conditions. The effective usage time of the battery pack may decrease when recording in cold surroundings, when using the brighter screen settings, etc.

Using the hard disk

| Battery pack | Recording mode→ | MXP | FXP | XP+ | SP | LP |
|------------------|-------------------------|----------|----------|----------|----------|----------|
| | Usage time↓ | | | | | |
| BP-807 BP-808 | Maximum recording time | 80 min. | 85 min. | 90 min. | 95 min. | 95 min. |
| | Typical recording time* | 50 min. | 50 min. | 55 min. | 60 min. | 60 min. |
| | Playback time | 100 min. | 115 min. | 115 min. | 120 min. | 120 min. |
| BP-819 | Maximum recording time | 170 min. | 170 min. | 185 min. | 190 min. | 190 min. |
| | Typical recording time* | 105 min. | 105 min. | 115 min. | 115 min. | 115 min. |
| | Playback time | 205 min. | 235 min. | 235 min. | 245 min. | 245 min. |
| BP-827 | Maximum recording time | 265 min. | 270 min. | 290 min. | 290 min. | 295 min. |
| | Typical recording time* | 170 min. | 170 min. | 175 min. | 175 min. | 180 min. |
| | Playback time | 325 min. | 360 min. | 370 min. | 380 min. | 380 min. |

Using a memory card

| Battery pack | Recording mode→ | MXP | FXP | XP+ | SP | LP |
|------------------|-------------------------|----------|----------|----------|----------|----------|
| | Usage time↓ | | | | | |
| BP-807 BP-808 | Maximum recording time | 90 min. | 95 min. | 95 min. | 95 min. | 95 min. |
| | Typical recording time* | 55 min. | 55 min. | 60 min. | 60 min. | 60 min. |
| | Playback time | 125 min. | 125 min. | 130 min. | 130 min. | 130 min. |
| BP-819 | Maximum recording time | 185 min. | 190 min. | 200 min. | 200 min. | 200 min. |
| | Typical recording time* | 110 min. | 115 min. | 120 min. | 120 min. | 120 min. |
| | Playback time | 260 min. | 260 min. | 265 min. | 265 min. | 265 min. |
| BP-827 | Maximum recording time | 285 min. | 290 min. | 295 min. | 295 min. | 295 min. |
| | Typical recording time* | 175 min. | 175 min. | 180 min. | 180 min. | 180 min. |
| | Playback time | 380 min. | 380 min. | 380 min. | 385 min. | 385 min. |

* Approximate times for recording with repeated operations such as start/stop, zooming, and power on/off.

TL-H37 Tele-converter

This Tele-converter lens increases the focal length of the camcorder lens by a factor of 1.5.

- The image stabilizer is not as effective when the Tele-converter is attached.
- The minimum focusing distance at full telephoto with the TL-H37 is 3 m.
- When the Tele-converter is attached, a shadow may appear in the picture when you use the flash.

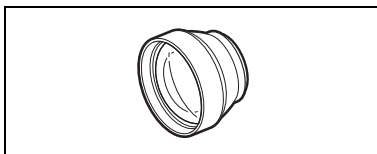

WD-H37 II Wide-converter

This lens decreases focal length by a factor of 0.7, giving you a wide perspective for indoor shots or panoramic views.

- When the Wide-converter is attached, a shadow may appear in the picture when you use the flash.

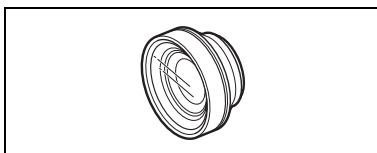

FS-H37U Filter Set

Neutral density and MC protector filters help you to control difficult lighting conditions.

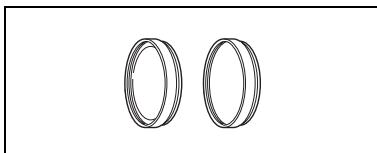

HTC-100 HDMI Cable

Use this cable to connect the camcorder to an external device using an all-digital connection, allowing you to enjoy playback at the highest quality. This cable sends both video and audio signals.

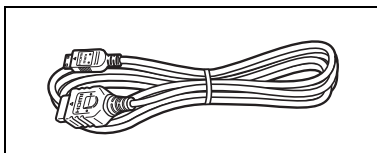

VL-5 Video Light

This video light enables you to record brightly in color even in dark places. It attaches to the camcorder's mini advanced shoe for cable-free operation.

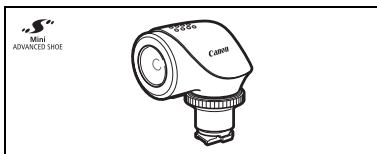



DM-100 Directional Stereo Microphone

This highly sensitive, super-directional microphone attaches to the camcorder's mini advanced shoe. It can be used as directional microphone (monaural) or stereo microphone.

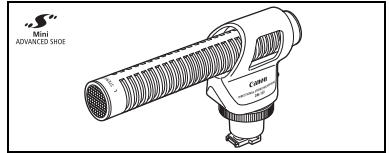

Shoulder Strap

You can attach a shoulder strap for more security and portability.

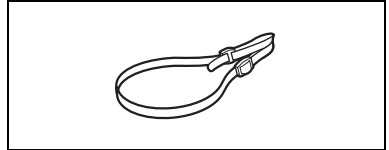

SC-2000 Soft Carrying Case

A handy camcorder bag with padded compartments and plenty of space for accessories.



This mark identifies genuine Canon video accessories. When you use Canon video equipment, we recommend Canon-brand accessories or products bearing the same mark.



Specifications

HG21/HG20

System

| | |
|---|---|
| Recording System | Movies: AVCHD Video compression: MPEG-4 AVC/H.264; Audio compression: Dolby Digital 2ch Photos: DCF (Design rule for camera system), compatible with Exif ¹ Ver. 2.2 and with DPOF Image compression: JPEG (Super Fine, Fine, Normal) |
| Size of Video Recordings | MXP, FXP mode: 1920 x 1080 pixels Other recording modes: 1440 x 1080 pixels |
| Size of Photos |  mode: 2048 x 1536, 1920 x 1080, 1440 x 1080, 640 x 480 pixels Simultaneous recording: 1920 x 1080, 848 x 480 pixels |
| Television System | 1080/50i ² |
| Recording Media | Built-in hard disk: HG21 120 GB, HG20 60 GB SD or SDHC memory card (not included) |
| Maximum Recording Time (approximate figures) | HG21 Built-in hard disk: MXP mode: 11 hr. 5 min. FXP mode: 15 hr. 45 min. XP+ mode: 21 hr. 40 min. SP mode: 36 hr. LP mode: 45 hr. 55 min. HG20 Built-in hard disk: MXP mode: 5 hr. 30 min. FXP mode: 7 hr. 50 min. XP+ mode: 10 hr. 50 min. SP mode: 18 hr. LP mode: 22 hr. 55 min. 32 GB memory card: MXP mode: 2 hr. 55 min. FXP mode: 4 hr. 10 min. XP+ mode: 5 hr. 45 min. SP mode: 9 hr. 35 min. LP mode: 12 hr. 15 min. |
| Image Sensor | 1/3.2-inch CMOS, approx. 3,310,000 pixels Effective pixels: Movies: approx. 2,070,000 Photos (LW): approx. 2,070,000 Photos (L, M, S): approx. 2,760,000 |
| LCD Screen | 2.7 in., wide, TFT color, approx. 211,000 dots |
| HG21 Viewfinder | 0.27 in., wide, TFT color, approx. 123,000 dots |
| Microphone | Stereo electret condenser microphone |
| Lens | f=4.8-57.6 mm, F/1.8-3.0, 12x optical zoom 35 mm equivalent: Movies: 42.9 – 514.8 mm Photos (LW): 42.9 – 514.8 mm Photos (L, M, S): 39.3 – 471.6 mm |
| Lens Configuration | 11 elements in 9 groups (2 aspheric elements) |
| AF System | Autofocus (TTL + external distance sensor when set to [Instant AF]) or Manual focus |
| Filter Diameter | 37 mm |
| Minimum Focusing Distance | 1 m; 1 cm at full wide angle |
| White Balance | Auto white balance, custom white balance and preset white balance settings: Daylight, Shade, Cloudy, Tungsten, Fluorescent, Fluorescent H |
| Minimum Illumination | 0.2 lx ([Night] recording program, Shutter speed at 1/2) 2.5 lx ([Programmed AE], Auto slow shutter [On], Shutter speed at 1/25) |
| Recommended Illumination | More than 100 lx |
| Image Stabilization | Optical-Shift Image Stabilizer |

¹ This camcorder supports Exif 2.2 (also called "Exif Print"). Exif Print is a standard for enhancing the communication between camcorders and printers. By connecting to an Exif Print-compliant printer, the camcorder's image data at the time of shooting is used and optimized, yielding extremely high quality prints.

² Recordings made with the [PF25] frame rate are converted and recorded on the hard disk/memory card as 50i.



Terminals

| | |
|--|--|
| AV OUT/  Terminal | Ø 3.5 mm minijack; Output only (dual purpose terminal also for headphones stereo output) Video: 1 Vp-p / 75 ohms unbalanced Audio: -10 dBV (47 kohm load) / 3 kohm or less |
| USB Terminal | mini-B, USB 2.0 (Hi-Speed USB) |
| COMPONENT OUT Terminal (Proprietary mini-D terminal) | Luminance (Y): 1 Vp-p / 75 ohms; Chrominance (P _B /P _R (C _B /C _R)): ±350 mV 1080i (D3) / 576i (D1) compatible; Output only |
| HDMI OUT Terminal | HDMI mini connector; Output only; compatible with HDMI-CEC |
| MIC Terminal | Ø 3.5 mm stereo minijack -57 dBV (with 600 ohm microphone) / 5 kohms or more |

Power/Others

| | |
|---|--|
| Power supply (rated) | 7.4 V DC (battery pack), 8.4 V DC (compact power adapter) |
| Power consumption (SP mode, AF on) | 3.8 W (LCD screen, normal brightness, recording on the hard disk) 3.7 W (LCD screen, normal brightness, recording on a memory card) HG21 3.7 W (viewfinder, normal brightness, recording on the hard disk) 3.5 W (viewfinder, normal brightness, recording on a memory card) |
| Operating temperature | 0 – 40 °C |
| Dimensions [W x H x D] (excluding the grip belt) | HG21 80 x 77 x 139 mm HG20 80 x 77 x 138 mm |
| Weight (camcorder body only) | HG21 490g HG20 465g |

CA-570 Compact Power Adapter

| | |
|-----------------------------------|---|
| Power supply | 100 – 240 V AC, 50/60 Hz |
| Rated output / consumption | 8.4 V DC, 1.5 A / 29 VA (100 V) – 39 VA (240 V) |
| Operating temperature | 0 – 40 °C |
| Dimensions | 52 x 29 x 90 mm |
| Weight | 135 g |

BP-807 Battery Pack

| | |
|------------------------------|--|
| Battery type | Rechargeable lithium ion battery, compatible with Intelligent System |
| Rated voltage | 7.4 V DC |
| Operating temperature | 0 – 40 °C |
| Battery capacity | 890 mAh |
| Dimensions | 30.7 x 35.2 x 40.2 mm |
| Weight | 49 g |

Weight and dimensions are approximate. Errors and omissions excepted.
The information in this manual is verified as of June 2008. Subject to change without notice.

Index

25F progressive frame rate 20, 90
 25p Cinema Mode 45

A

Abroad, using the camcorder 118
 Aperture (f number) 44
 Aspect ratio of a connected TV
 (TV type) 94
 Audio recording level 51
 Auto exposure bracketing 65
 Auto slow shutter 92
 Autofocus (AF)
 AF frame
 (9-point AiAF/Center point) 92
 Instant AF/Normal AF 91
 Av (recording program) 44
 AV OUT/ terminal 52, 76
 AVCHD specifications 4

B

Backing up recordings 80
 Backlight correction 47
 Battery pack
 Battery information 20
 Charging 21
 Remaining charge indicator 20
 Beach (recording program) 43
 Built-in backup battery 116

C

Calendar display 39
 Capturing photos from video 67
 Cine Mode (recording program) 45
 COMPONENT OUT terminal 77
 Condensation 118
 Connections to external devices 77
 Continuous shooting 65

Copying

Movies 58
 Photos 68

D

Data code 51, 93
 Date and time 28
 Date format 97
 Daylight saving time 29
 Time zone 29
 Deleting
 Movies 35, 42, 57
 Photos 61, 63
 Digital effects 50
 Direct print 70
 Direct transfer 84
 Dividing scenes 55
 Drive mode 65
 Drop sensor 96
 DVD authoring 80

E

EASY mode 25
 Error messages 104
 Exposure 46

F

Fireworks (recording program) 43
 Flash 64
 Flexible recording 25
 Focus
 Assist functions 47
 Focus priority 92
 Manual 47
 Frame rate 45, 90
 FUNC. menu 26, 88

H

Hard disk precautions 6
 HDMI OUT terminal 77, 79
 HDMI-CEC 96
 Headphones 52



Histogram65

I

Image effects49

Image stabilizer92

Index screen36, 37, 62

Initialization (hard disk/memory card) .31

J

Joystick26

Joystick guide26

L

Language28

LCD screen24

Light metering mode67

M

Magnifying photos63

Maintenance117

Manual exposure adjustment46

Markers91

Memory card115

MIC terminal54

Microphone54

Microphone attenuator92

Mini advanced shoe53

N

Night (recording program)43

Notification sounds95

O

Onscreen display selection51

Original recordings56

P

P (recording program)44

Photo numbers96

Photo quality60

Photo size60

Playback

 Movies36

 Photos61

Playlist56

Portrait (recording program)43

Power save32

Print order74

Print/share button71, 85

Printing photos70

Protecting photos68

Q

Quick Start function35

R

Recording

 Movies32

 Photos59

Recording mode33

Recording programs43, 44

Recording time34

Remote sensor23

RESET101

Reviewing

 Movies (Record review)35

 Photos91

S

Screen icons18

SD/SDHC memory card29

Searching scenes by date39

Selecting recordings41

Selecting the media

 for playback38

 for recording31

Self timer46

Serial number16

Setup menus27, 90

Shutter speed44

Simultaneous recording66

Slideshow61

Snow (recording program)43

| | |
|---|----|
| Special Scene (recording programs) | 43 |
| Sports (recording program) | 43 |
| Spotlight (recording program) | 43 |
| Sunset (recording program) | 43 |

T

| | |
|----------------------------------|-----|
| Telephoto | 34 |
| Timeline | 40 |
| Transfer order | 87 |
| Transferring to a computer | |
| Movies | 80 |
| Photos | 84 |
| Tripod | 114 |
| Troubleshooting | 98 |
| Tv (recording program) | 44 |

U

| | |
|------------------------|----|
| USB terminal | 76 |
|------------------------|----|

V

| | |
|-----------------------|--------|
| Viewfinder* | 33 |
| Volume | 37, 95 |

W

| | |
|-------------------------------|----|
| White balance | 48 |
| Wide angle | 34 |
| Wind screen | 92 |
| Wireless controller | 22 |

Z

| | |
|------------------------|--------|
| Zoom | 34 |
| Digital zoom | 91 |
| Zoom speed | 34, 91 |

* **HG21** only.



DIE-310

Canon

Canon Europa N.V.

Bovenkerkerweg 59-61, 1185 XB Amstelveen, The Netherlands

Canon UK Ltd.

CCI Service Centre, Unit 130

Centennial Park, Borehamwood, Hertfordshire, WD6 3SE, England

Telephone 0870-241-2161

Canon Australia Pty. Ltd.

Info-Line: 131383

www.canon.com.au

Canon New Zealand Ltd.

Customer Care: (09) 489 0470

www.canon.co.nz

Canon Singapore Pte. Ltd

1 HarbourFront Avenue, #04-01 Keppel Bay Tower, Singapore 098632

Tel: (65) 6799 8888

Fax: (65) 6799 8882

Canon Hongkong Company Ltd

19/F, The Metropolis Tower, 10 Metropolis Drive,

Hunghom, Kowloon, Hong Kong

Canon Latin America, Inc.

Sales & Enquiries: 703 Waterford Way, Suite 400, Miami, FL 33126 USA

For support concerning Pixela ImageMixer 3 SE, please call Pixela customer support (details in the PIXELA ImageMixer 3 SE Installation Guide).

0121W054 PUB. DIE-310B

© 2008 CANON INC.

30-2, Shimomaruko 3-chome, Ohta-ku, Tokyo 146-8501, Japan

Free Manuals Download Website

<http://myh66.com>

<http://usermanuals.us>

<http://www.somanuals.com>

<http://www.4manuals.cc>

<http://www.manual-lib.com>

<http://www.404manual.com>

<http://www.luxmanual.com>

<http://aubethermostatmanual.com>

Golf course search by state

<http://golfingnear.com>

Email search by domain

<http://emailbydomain.com>

Auto manuals search

<http://auto.somanuals.com>

TV manuals search

<http://tv.somanuals.com>