

GT-782

INSTRUCTION MANUAL

Please read this manual before using the printer.
Please keep this manual within easy reach for quick reference.

GARMENT PRINTER

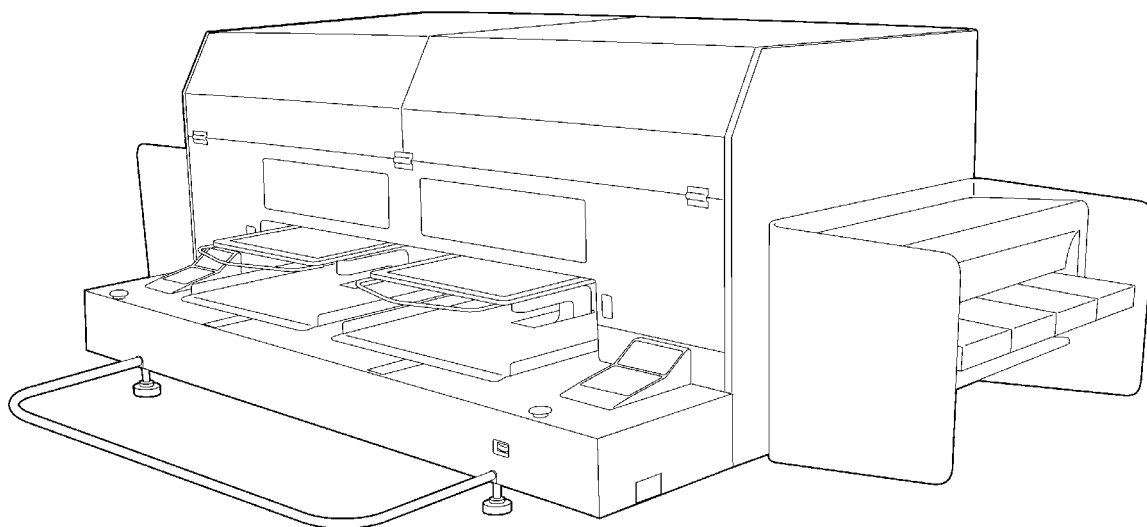

brother[®]

GT-782 US support homepage <http://www.brother-usa.com/Garmentprinters/>

Note based on California law (USA) on the use and handling of Perchlorate

This product contains a CR Coin Lithium Battery which contains Perchlorate Material – special handling may apply.

See <http://www.dtsc.ca.gov/hazardouswaste/perchlorate>.



Thank you very much for buying a BROTHER printer. Before using your new printer, please read the safety instructions below and the explanations given in the instruction manual.

SAFETY INSTRUCTIONS







[1] Safety indications and their meanings

This instruction manual and the indications and symbols that are used on the printer itself are provided in order to ensure safe operation of this printer and to prevent accidents and injury to yourself or other people. The meanings of these indications and symbols are given below.

Indications





 DANGER	The instructions which follow this term indicate situations where failure to follow the instructions will result in death or serious injury.
 WARNING	The instructions which follow this term indicate situations where failure to follow the instructions could result in death or severe injury.
 CAUTION	The instructions which follow this term indicate situations where failure to follow the instructions could cause injury when using the machine or physical damage to equipment and surroundings.

Symbols

-  This symbol () indicates something that you should be careful of. The picture inside the triangle indicates the nature of the caution that must be taken.
(For example, the symbol at left means "beware of injury".)
-  This symbol () indicates something that you must not do.
-  This symbol () indicates something that you must do. The picture inside the circle indicates the nature of the thing that must be done.
(For example, the symbol at left means "you must make the ground connection".)

[2] Notes on safety

 DANGER	
	Wait at least 5 minutes after turning off the power switch and disconnecting the power cord from the wall outlet before opening the cover of the control unit. Do not touch as high voltage can result in severe injury.

 WARNING	
Basic precautions	
 Do not disassemble or modify the printer, otherwise it may cause fire or electric shocks or problems with correct operation.	 Do not handle the power cord with wet hands, otherwise it may cause electric shocks.
 Ask the place of purchase or a qualified technician to carry out any internal inspections, adjustments or repairs that may be required. (Any problems with correct operation that occur as a result of the customer attempting to disassemble or modify the printer will not be covered by the warranty.)	

WARNING

Installation



Do not set up the printer in a dusty environment. If dust collects inside the printer, it may cause fire or electric shocks or problems with correct operation.



Do not bend the cords excessively or fasten them too hard with staples or anything similar to secure cords, otherwise there is the danger that fire or electric shocks could occur.



Be sure to connect the ground. If the ground connection is not secure, you run a high risk of receiving a serious electric shock, and problems with correct operation may also occur.

Printing



If a foreign object gets inside the printer, immediately turn off the power switch and disconnect the power cord, and arrange for a service call to resolve.



If you continue to use the printer while there is a foreign object inside, it may result in fire or electric shocks or problems with correct operation.



Do not use the printer when smoke or a bad odor coming from the printer, otherwise it may cause fire or electric shocks or problems with correct operation.



Immediately turn off the power switch and disconnect the power cord, and arrange for a service call to resolve.



Do not allow water or oil to get onto the printer, otherwise it may cause fire or electric shocks or problems with correct operation.



If any liquids get onto the printer, immediately turn off the power switch and disconnect the power cord, and arrange for a service call to resolve.

Maintenance



Do not put your hands in the ink cartridge slot, otherwise the needle inside the slot may cause injury.

CAUTION

Environmental requirements



Use the printer in an area which is free from sources of strong electrical noise such as electrical line noise or static electric noise. Sources of strong electrical noise may cause problems with correct operation.



Any fluctuations in the power supply voltage should be within $\pm 10\%$ of the rated voltage for the printer. Voltage fluctuations which are greater than this may cause problems with correct operation.



The power supply capacity should be greater than the requirements for the printer's power consumption. Insufficient power supply capacity may cause problems with correct operation.



The ambient temperature should be within the range of 18°C to 30°C during use. Temperatures which are lower or higher than this may cause problems with correct operation.



The relative humidity should be within the range of 20% to 85% during use, and no dew formation should occur in any devices. Excessively dry or humid environments and dew formation may cause problems with correct operation.









Use the printer in a place which is adequately ventilated. A slight odor is generated when the printed articles are being fixed by heat.









In the event of an electrical storm, turn off the power and disconnect the power cord from the wall outlet. Lightning may cause problems with correct operation.

CAUTION







Installation

-  Setting up and moving of the printer should only be carried out by a qualified technician.
-  The printer machine weighs approximately 230 kg (507 lb). Transporting and setting up of the printer should be held in proper way.
-  The machine may fall down and cause injury.
-  The printer must be used on a suitable stable surface, otherwise it may tip over or fall down and cause injury. Furthermore, the table that supports the printer should be at least 180 cm (70.9 inch) in width and 90 cm (35.4 inch) in depth, and should be able to bear a weight of 250 kg (555 lb) or more.
-  Do not set up the printer in a place where it will be affected by vibration. It may become unbalanced and fall down, which cause injury or damage to the printer.
-  Do not connect the power cord until setup is complete, otherwise the printer may operate if the power switch is turned on by mistake, which could result in injury.
-  Do not climb onto the printer or place heavy objects on top of it, otherwise it may become unbalanced and tip over or fall down and cause injury.

Printing

-  This printer should only be used by operators who are appropriately trained in its operation.
-  Ensure there is adequate space left for safe working. The Platen moves forward while operating and it may be injured.
-  Do not handle the platen while printing. If your hand gets caught between the platen or the T-shirt tray and the covers, it may be injured.
-  Do not move the Platen by hand. The Printer may be mechanically and electrically damaged.
-  Do not put your hands inside the covers while the printer's power is turned on, otherwise your hands may touch against moving parts and this may result in injury.
-  When a problem occurs with the operation of the printer, contact the place of purchase or a qualified technician.

Maintenance

-  Wait at least 1 minute after turning off the power switch before opening the front cover. Do not touch the head heat sink as it may be HOT and may cause a burn.
-  Be careful not to get your fingers caught when closing the front cover, otherwise it may result in injury to your fingers.
-  Do not move the Platen by hand. The Printer may be mechanically and electrically damaged.
-  Do not disassemble the ink cartridge.
-  Take care not to let the ink, Wash Liquid, Maintenance Solution, Pretreatment or waste liquid—come into contact with your eyes or onto your skin, otherwise inflammation can result. In case of contact with eyes, do not rub but immediately rinse the eyes with water. Furthermore, do not drink the ink, Wash Liquid, Maintenance Solution, Pretreatment or waste liquid under any circumstances, as they can cause vomiting and diarrhea. Keep the ink, waste liquid and wash liquid out of the reach of children.
-  Use only the proper replacement parts as specified by Brother.

[3] Warning labels

The following warning labels appear on the printer.

Please follow the instructions on the labels at all times when using the printer. If the labels have been removed or are difficult to read, please contact your nearest Brother dealer.

1

	▲ 危険 高電圧部分にふれて、大けがをすることがある。電源を切り、5分たってからカバーをはずすこと。	▲ 危険 触媒高電圧部分。会导致受伤。在切断电源5分钟后。再开启盖罩。
	▲ DANGER Hazardous voltage will cause injury. Turn off main switch and wait 5 minutes before opening this cover.	▲ GEFAHR Hochspannung verletzungsgefahr! Bitte schalten sie den hauptschalter aus und warten sie 5 minuten, bevor sie diese abdeckung öffnen.
	▲ PELIGRO Un voltaje inadecuado puede provocar les heridas. Apagar el interruptor principal y esperar 5 minutos antes de abrir esta cubierta.	

2

Watch your fingers, or you may be injured.

3

	▲ 警告 内部の針でけがをする恐れがある。カートリッジ口の内部に手を入れない。	▲ WARNING Needle inside can cause injury. Do not put hands in ink cartridge slot.	▲ WARNING Nadel im Inneren kann Verletzungen verursachen. Führen Sie die Hände nicht in den Tinte Kartuschen Schlitz ein.
▲ AVERTISSEMENT L'aiguille à l'intérieur peut blesser. Ne pas mettre la main dans l'emplacement de cartouche.	▲ AVISO La aguja interior puede causar heridas. No ponga las manos en la ranura de cartucho de tinta.	▲ AVVERTENZE La presenza di aghi può causare infortuni. Non infilare le mani nella fessura delle cartucce.	

4

High temperature warning display

5

	▲ 注意 プラテンやTシャツトレイと各カバーとの間に手をはさみ、けがをする。印刷中はプラテンから手を離すこと。
▲ CAUTION Moving platen, T-shirt tray and covers can cause bodily injury. Keep hands off platen while printing.	▲ ACHTUNG Druckplatte, T-Shirt-Ablage und Abdeckungen können körperliche Verletzungen verursachen. Halten Sie die Hände von der Auflage während des Druckvorganges fern.
▲ ATTENTION Déplacement du plateau, chargeur T-shirt et couvercle peut blesser le corps. Garder les mains éloignées lors de l'impression.	▲ ATENCIÓN Moviendo la placa, la bandeja de camiseta y las cubiertas pueden causar una herida personal. Retire las manos de la placa durante la impresión.
▲ ATTENZIONE Tavoletta mobile, il ripiano per la T-shirt ed il carter potrebbero causare infortuni. Tenere le mani lontane dalla tavoletta durante la stampa.	

6

▲ 注意 炎症を起こす可能性がある。液体が目や皮膚に付かないようにする。下痢・おう吐する可能性がある。廃液を飲まないこと。子供の手の届かないところに置くこと。
▲ CAUTION Waste liquid can cause inflammation. Avoid contact with eyes and skin. Waste liquid can cause vomiting and diarrhea. Do not drink. Keep waste ink cartridge out of reach of children.
▲ ACHTUNG Rest Flüssigkeit kann Entzündung verursachen. Vermeiden Sie Kontakt mit Augen und Haut. Rest Flüssigkeit kann das Erbrechen und Diarrhöe verursachen. Trinken Sie diese nicht. Halten Sie den Rest Tinte Behälter aus Reichweite Ihrer Kinder.
▲ ATTENTION Liquide déchet peut causer une inflammation. Eviter contact avec les yeux et la peau. Liquide déchet peut provoquer vomissement et diarrhée. Ne pas boire. Garder cartouche déchet d'encre hors de portée des enfants.
▲ ATENCIÓN El líquido de desecho puede causar inflamación. Evitar el contacto con los ojos y la piel. El líquido de desecho puede causar vómitos y diarreas. No ingerir. Guarde el cartucho de tinta gastada fuera del alcance de niños.
▲ ATTENZIONE Il liquido di scarto può causare infiammazioni. Evitare il contatto con gli occhi e con la pelle. Il liquido di scarto può causare vomito e diarrea. Non bere. Tenere la cartuccia dell'inchiostro di scarto lontano dalla portata dei bambini. 地域の法令に従って廃棄してください。 Gebrauchte es gemäß örtlichen Richtlinien entsorgen. Jetez conformément à la réglementation locale en vigueur. Deseche siguiendo la normativa local. Smaltire in conformità alle normative locali.

7

▲ 注意 炎症を起こす可能性がある。液体が目や皮膚に付かないようにする。下痢・おう吐する可能性がある。廃液を飲まないこと。子供の手の届かないところに置くこと。	▲ CAUTION Ink can cause inflammation. Avoid contact with eyes and skin. Ink can cause vomiting and diarrhea. Do not drink. Keep ink cartridge out of reach of children.	▲ ACHTUNG Die Tinte kann Entzündungen verursachen. Vermeiden Sie Kontakt mit Augen und Haut. Tinte kann das Erbrechen und Diarrhöe verursachen. Trinken Sie diese nicht. Halten Sie die Tintenpatrone aus der Reichweite Ihrer Kinder.
▲ ATTENTION L'encre peut provoquer inflammation. Eviter le contact avec les yeux et la peau. L'encre peut provoquer vomissement et diarrhée. Ne pas boire. Garder les cartouches d'encre éloignées des enfants.	▲ ATENCIÓN La tinta puede causar inflamaciones. Evite el contacto con los ojos y la piel. Puede causar diarreas y vómitos. No ingerir. Mantenga los cartuchos de tinta fuera del alcance de los niños.	▲ ATTENZIONE L'inchiostro può causare infiammazioni. Evitare il contatto con occhi e pelle. L'inchiostro può causare vomito e diarrea. Non bere. Tenere le cartucce di inchiostro lontano dalla portata dei bambini.

8

brother
ウォッシュ液 / Wash Liquid
Reinigungsflüssig / Liquide nettoyage
Líquido de lavar / Líquido detergente

▲ 注意 下痢・おう吐する可能性があります。廃液を飲んではけません。目に入った場合は、絶対に、直ちに水で洗い流すこと。
▲ CAUTION Wash liquid can cause vomiting and diarrhea. Do not drink. In case of contact with eyes, do not rub but immediately rinse the eyes with water.
▲ ACHTUNG Reinigungsflüssigkeit kann das Erbrechen und Diarrhöe verursachen. Trinken Sie diese nicht. Sollte es zum Kontakt mit Augen kommen, reiben Sie diese nicht, spülen Sie aber sofort die Augen mit Wasser aus.
▲ ATTENTION Liquide de nettoyage peut provoquer vomissement et diarrhée. Ne pas boire. En cas de contact avec les yeux, ne pas froter mais rincer abondamment les yeux à l'eau.
▲ ATENCIÓN El líquido de lavar puede causar vómitos y diarreas. No ingerir. En caso de contacto con los ojos, láveselos inmediatamente con agua abundante sin frotar.
▲ ATTENZIONE Il liquido detergente può causare vomito e diarrea. Non bere. In caso di contatto con gli occhi, non strofinarli ma lavare immediatamente gli occhi con acqua.

9

	▲ 注意 本体の上に乗らないこと。	▲ CAUTION Do not climb onto the printer.
▲ ACHTUNG Niemals auf den Drucker steigen.	▲ ATTENTION Ne montez pas sur l'imprimante.	
▲ ATENCIÓN No se suba encima de la impresora.	▲ ATTENZIONE Non salire sulla stampante.	

テーブルの耐荷重は 300 kg 以上のこと。 The table should be able to bear a weight of 300 kg or more.
 テーブルサイズは 910 x 1270 mm 以上のこと。 The table should be at least 1270 x 910 mm.
 Der Tisch sollte ein Mindestgewicht von 300 kg tragen können. Le plan doit également être capable de supporter une charge de 300 kg ou plus.
 Der Tisch sollte mindestens 1270 x 910 mm groß sein. Le plan sur lequel elle est installée doit avoir 1270 x 910 mm.
 La mesa debe soportar un peso de 300 kg o más. El plano debe essere in grado di sostenere un peso pari o superiore a 300 kg.
 La mesa debe tener al menos 1270 x 910 mm. Il piano deve avere dimensioni di almeno 1270 x 910 mm.

10

	飲んではいけません。 / Do not drink. Trinken Sie nicht. / Ne pas boire. No ingerir. / Non bere.	brother
--	---	----------------

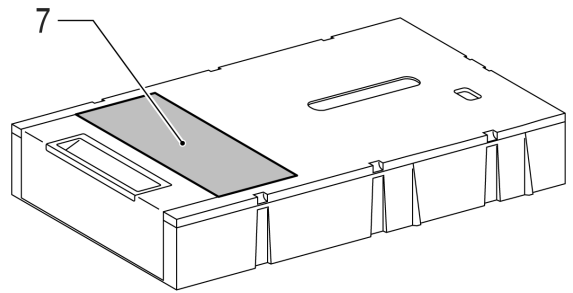
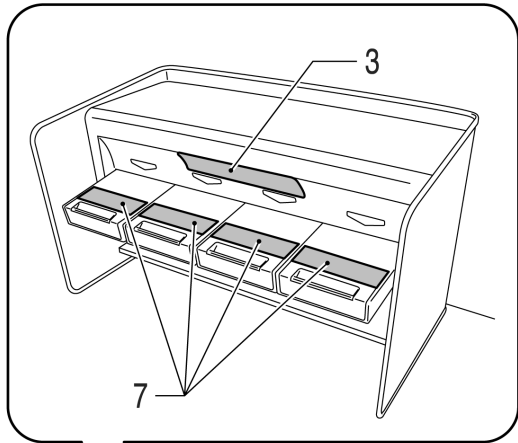

Ink Cartridge

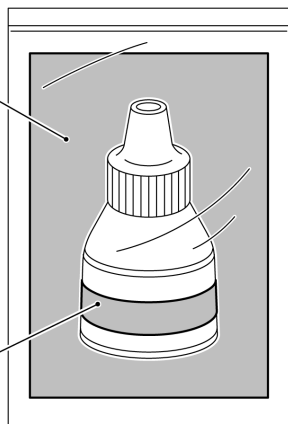
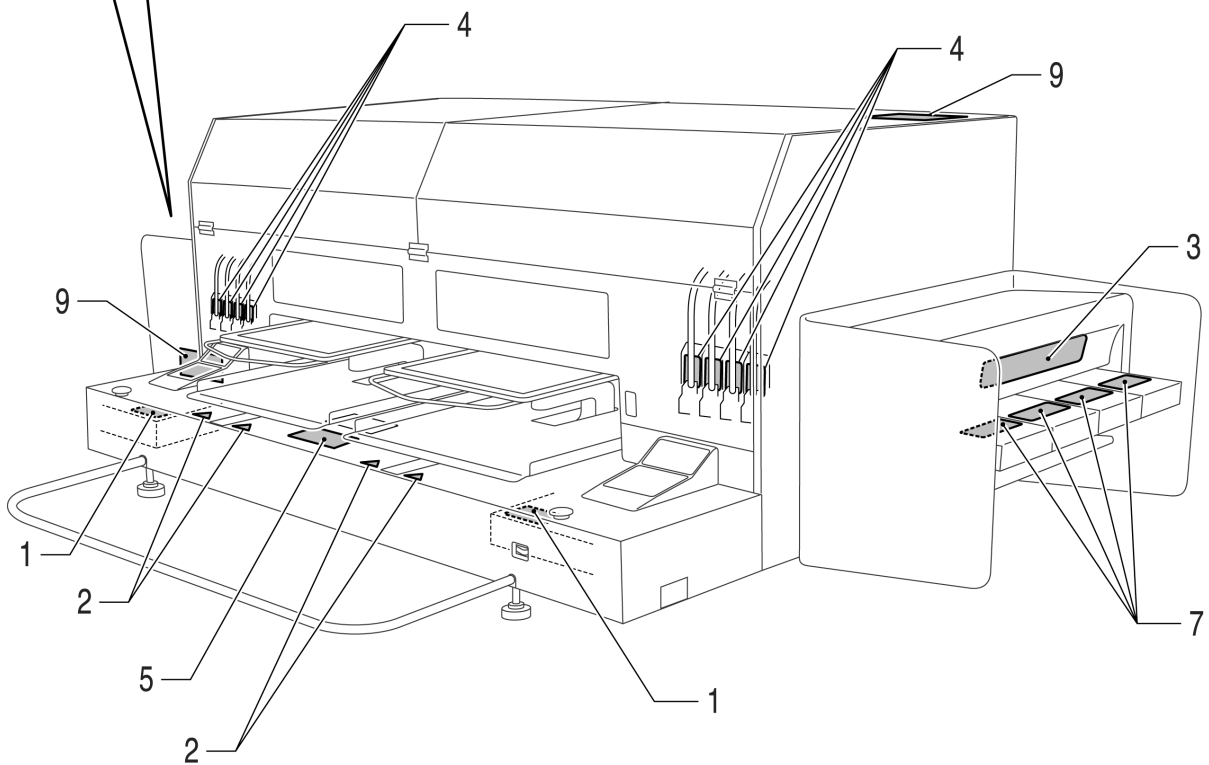

Wash Liquid

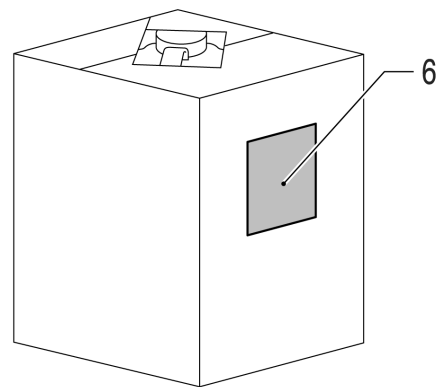

Maintenance Solution
Pretreatment

4321M

Table of Contents

1. Read This First	1
1-1. Precautions	1
1-2. Unpacking Your Printer	3
1-3. Required Condition.....	3
1-3-1. Environment.....	3
1-3-2. Electrical Requirements.....	3
1-3-3. Software Information.....	4
1-3-4. Other Requirements.....	4
1-3-5. Consumable Requirements.....	5
2. Identifying Your Printer's Parts.....	6
2-1. Front	6
2-2. Left.....	7
2-3. Right	7
2-4. Inside of the Front Cover.....	8
2-5. Under the Platen.....	9
2-6. Control Panel	10
2-6-1. Indication Lamps.....	11
2-6-2. Display	12
2-6-3. Menu List.....	13
3. Getting Started.....	15
3-1. Placing Your Printer	16
3-2. Turning On/Off Your Printer.....	17
3-2-1. Turning On Your Printer.....	17
3-2-2. Turning Off Your Printer	17
3-3. Preparing Your PC.....	18
3-3-1. When you already have GT-541	18
3-3-2. PC preparation: For Windows XP (32 bit).....	19
3-3-3. Connection with USB 2.0 Cable: for Windows XP.....	20
3-3-4. Opening the installed manuals	22
3-3-5. Opening the Useful Tools.....	23
3-3-6. Installation of PC for Windows Vista / Windows 7 (32 bit / 64 bit).....	24
3-3-7. Connection with USB 2.0 Cable: for Windows Vista / Windows 7	25
3-4. Setting Up Your Printer.....	26
3-4-1. Adjusting the Display Contrast.....	26
3-4-2. Adjusting the Speaker Volume.....	26
3-4-3. Language	26
3-4-4. Temperature	26
4. Printing Directly from Applications.....	27
4-1. Basic Printing Procedure	28
4-2. Setting the Applications' Print Condition.....	28
4-2-1. Common Notice for All Applications	28
4-2-2. Settings for CorelDRAW	30
4-2-3. Settings for Adobe Photoshop	34
4-2-4. Settings for Adobe Illustrator	39
4-2-5. Settings for Adobe Photoshop Elements	44
4-2-6. Setting Paint Shop Pro Print Condition	45
4-2-7. Printing From Other Applications	45
4-3. Setting the Printer Driver Condition.....	46
4-3-1. Entering the Job Comment.....	47
4-3-2. Selecting the Platen Size	47

4-3-3. Setting the Ink.....	47
4-3-4. Setting the White Volume.....	48
4-3-5. Selecting the Color Processing for increasing the Vividness.....	49
4-3-6. Selecting the White Mask for White ink only.....	49
4-3-7. CMYK Color Inks for Color ink only.....	50
4-3-8. Setting Print Direction as Uni-Directional.....	51
4-3-9. Printing Color Chart.....	51
4-4. Uninstalling / Installing the Platen.....	52
4-4-1. Uninstalling the Platen.....	52
4-4-2. Installing the Platen.....	53
4-4-3. Lowering the Platen height.....	54
4-5. Placing the T-shirt on the Platen.....	55
4-6. Printing.....	58
4-6-1. Applying the Pretreatment.....	58
4-6-2. Making One Print.....	59
4-6-3. Printing More than One Print Using the Same Print Data.....	59
4-7. Removing the T-shirt from the Platen.....	60
4-8. Curing the Ink onto the T-shirt.....	60
5. Printing ARP Files.....	61
5-1. Making Print Data in ARP File.....	61
5-2. Reading ARP Files Saved in a CompactFlash.....	63
5-3. Sending ARP Files from GT File Viewer to your Printer.....	64
6. Maintenance.....	68
6-1. Replacing Consumables.....	69
6-1-1. Replacing the Ink Cartridge.....	69
6-1-2. Replacing the Wiper Cleaner.....	70
6-1-3. Loading / Retrieving White Ink.....	74
6-1-4. Waste Ink Disposal.....	75
6-1-5. Replacing the Platen Sheet.....	75
6-1-6. Required Maintenance for the Long Storage.....	76
7. Troubleshooting.....	78
7-1. Solving Printer Problems.....	79
7-2. Solving Print Quality Problems.....	81
7-2-1. Procedure for Solving the Print Quality Problems.....	82
7-2-2. Cleaning the Print Heads.....	85
7-2-3. Checking Print Quality with Nozzle Check Pattern.....	85
7-2-4. Changing the Print Direction.....	87
7-2-5. Changing the Auto Head Cleaning Setting.....	87
7-2-6. Cleaning the Print Head Nozzles.....	88
7-2-7. Replacing the Print Head.....	90
7-2-8. Adjustment after the Print Head has been replaced.....	97
7-2-9. Replacing the Wiper Blade.....	98
7-2-10. Setting Extra Wipe.....	103
7-3. Solving Application Problems.....	104
7-4. Error Messages.....	105
8. Specifications.....	116
8-1. Mechanical Specification.....	116
8-2. Software Specification.....	116

1. Read This First

1-1. Precautions

Please observe the following precautions before using your printer.

- Please advise the following to customers.
Printed colors may transfer when a printed surface rubs on a white or light-colored synthetic leather made of PVC (polyvinyl chloride). When printing CMYK-only garments, the CMYK ink may transfer to the White-only printed garment when they rub against each other. In those cases, clean the stains with a soft cloth or toothbrush with a household cleaner or alcohol.
- The machine is designed to be used within the temperature and humidity levels below. Less humidity may cause ink clogging in Print Head nozzles. Print speed decreases by 20 percent in low temperature (lower than 64 °F).

	Temperature	Humidity
Keeping your printer	32 °F to 104 °F (0 °C to 40 °C)	20 % to 85 % (no condensation)
Operating your printer	50 °F to 95 °F (10 °C to 35 °C)	
For the best print result	64 °F to 86 °F (18 °C to 30 °C)	35 % to 85 % (no condensation)

- Do not pull out Ink Cartridge(s) during the operation; it may result in poor print quality or cause damage to your printer.
- Do not turn off your printer, or open the Front Cover during the operation; otherwise the printer may be damaged or spoil the print job.
- Be careful in handling a printed T-shirt that has not yet fixed by heat. Ink is difficult to wash from stained clothes.
- Clean the Head Caps and Wiper Blade at this time and replace Wiper Cleaner with Cap Cleaning Kit when the warning is shown on the display of the control panel. This regular maintenance helps you keep your printer in good condition. If not, it may cause poor print quality or your printer may be damaged.
- Never use alcohol when you clean Head Caps and Wiper Blade; it will cause damage to the Print Heads. Use Wash Liquid.
- Install the Ink Cartridges in the correct positions as shown. Confirm both the colors of labels on your printer and the Ink Cartridges.
- When the ink cartridge is used your printer will show "empty" status. At this point you will need to replace with a new Ink Cartridge. A small amount of ink remains to avoid damage to your printer.
- New consumables should be stored away from direct sunlight until they are required. Use up within six months by the date written on the CMYK ink cartridge.
- Never refill ink, never reconstruct ink cartridges; ink may cohere inside the cartridge bag, tube or even Print Head and may cause serious damage to your printer. We assume no responsibility for any problem caused by using them. Only genuine new ink cartridges should be used.
- The ink cartridges should always be installed; otherwise the needles may stopped up with ink and your printer may be damaged.

- Tubes and Print Heads for White must be cleaned with Maintenance Solution once a week by the menu Tube Cleaning. The Warning "Clean Tube W*" is indicated on the display of the right Control Panel after a week passes since the last Tube Cleaning.
- If the printer is unused for a period of time there is a possibility that Print Heads may become blocked as ink dries. To avoid this, we recommend that the printer should be turned on at least once a week and press the Head Cleaning Button to clean the Print Head. If you are planning not to use your printer for more than two weeks, follow "6-1-6. Required Maintenance for the Long Storage" to prevent ink clogging.
- Shake the White Ink Cartridges once a day before you start printing (30 seconds to 1 minute for each).
- If CMYK inks are printed on a Pretreatment applied T-shirt, ink may wash off. Do not apply Pretreatment when you print without using White ink.
- Pre-treatment on some T-shirts may be seen after applied and cured, wash lightly with water to remove mark. Some dyes may be decolorized by Pretreatment; we recommend you test the garment before printing.
- Use only Print Head W for White Ink.

<Note> Only for the use in the United States

This device complies with Part 15 of the FCC Rules. Operation is subject to the following two conditions: (1) this device may not cause harmful interference, and (2) this device must accept any interference received, including interference that may cause undesired operation.

<Note>

Product names used in this manual are, in general, trademarks or registered trademarks of their respective developer or manufacture. However, in this manual, the © marks or TM marks are not used.

Microsoft and Windows are either registered trademarks of Microsoft Corporation in the United States and/or other countries.

Corel, CorelDRAW and Paint Shop Pro are registered trademarks of Corel Corporation.

Adobe, Adobe Photoshop, Adobe Illustrator and Adobe Photoshop Elements are either registered trademarks of Adobe Systems Incorporated in the United States and/or other countries.

CompactFlash is a trademark of SanDisk Corporation.

Beefy-T is a trademark of Hanes Corporation.

Other product and company names mentioned herein may be the trademarks or registered trademarks of their respective owners.

Screen shots used in this document are in accordance with the guidelines of Microsoft Corporation.

1. Read This First

1-2. Unpacking Your Printer

<Note>

Your printer must be unpacked by a Brother representative or a Brother authorized shipping company.

After unpacking, check that the following parts are included.

Contact Brother Customer Service Hot Line if any of these is missing.

- GT-782 Printer
- Install CD
- AC cord, UL/CSA 13A
- Nozzle Cleaning Kit
- 4 Print Heads for CMYK, 4 Print Heads W for White
- 2 Waste Ink Tanks
- Basic Operation Manual
- "How to uncrate" Manual

<Note>

Eight Filter Cartridges are installed in both Ink Cartridge Slots. Keep them since they should be used for maintenance & transport operations.

1-3. Required Condition

Please use your printer under the conditions described in this section.

1-3-1. Environment

	Temperature	Humidity
Keeping your printer	32 °F to 104 °F (0 °C to 40 °C)	20 % to 85 % (no condensation)
Operating your printer	50 °F to 95 °F (10 °C to 35 °C)	
For the best print result	64 °F to 86 °F (18 °C to 30 °C)	35 % to 85 % (no condensation)

If your room is dry, we recommend using a humidifier to avoid Print Heads from clogging with dried ink.

1-3-2. Electrical Requirements

Power:

Single-phase 100-230 V, 50/60 Hz

Power Consumptions:

0.8 A (average)

1-3-3. Software Information

Supported OS:

Latest Windows XP (32 bit), Windows Vista (32 bit / 64 bit), Windows 7 (32 bit / 64 bit)

Supported Interface:

USB 1.1/ 2.0

Minimum System Requirements:

256 MB RAM (512 MB or more is recommended),
128 MB free disk space (256 MB or more is recommended),
1 GHz CPU (2 GHz or more is recommended.)

Recommended Applications for precise output:

Adobe Photoshop, Adobe Photoshop Elements, Paint Shop Pro (for BMP editing)
Adobe Illustrator, CorelDRAW (for Vector Data editing)

1-3-4. Other Requirements

When purchasing optional tools, choose one that meets the following requirements.

USB cable:

USB 2.0-compliant device cable (A/B)

<Note>

Using other USB 2.0-compliant device cable may result in improper connection.

CompactFlash:

Type I Memory Card, Capacity of 128 MB to 2 GB,
FAT16/32 formatted,
SanDisk CompactFlash is recommended.

Heat Press:

Must be able to handle the Platen 14 x 16, or the extra-large LL Platen 16x18 (406.4 mm x 457.2 mm) and maintain heat production of 356 °F (180 °C) for 35 seconds. Pretreatment must be cured with the heat press instead of oven.

<Note>

When you print with White ink, we recommend using oven instead of heat press. (320°F (160 °C), 5 minutes)

Separator sheet:

When you cure Pretreatment, use this to make the surface smooth and flat. When you cure printed ink, use this for separation.

Urethane mat (continuous foam):

When you cure Pretreatment, use this to release the hot air.

T-shirt:

Made with 100 % cotton, or 50 % cotton and 50 % polyester
“Hanes Beefy-T” is recommended.

<Note>

- *Pretreatment on some T-shirts may be seen after applied and cured. In that case, wash lightly with water to remove mark. Some dyes may be decolorized by Pretreatment.*
- *Some manufacturing brands may not work as good as 100% cotton garment. You need to test prior to your production.*

1. Read This First

1-3-5. Consumable Requirements

For ordering new or replacement items please use the codes below.

Consumable	Item Code
Black Ink Cartridge	GC-50K50
Magenta Ink Cartridge	GC-50M50
Cyan Ink Cartridge	GC-50C50
Yellow Ink Cartridge	GC-51Y50
White Ink Cartridge	GC-50W50
Maintenance Solution	GC-50S2L
Pretreatment	GC-50P2L
Cap Cleaning Kit	SA5774
Nozzle Cleaning Kit	SA5885
Platen Sheet	SA5620
Platen Sheet S	SA6401
Platen Sheet SS	SA8211
Platen Sheet L	SB0527
Wash Liquid	SA6248
Print Head for CMYK	SA5846
Print Head W for White	SA9153

2. Identifying Your Printer's Parts

2-1. Front

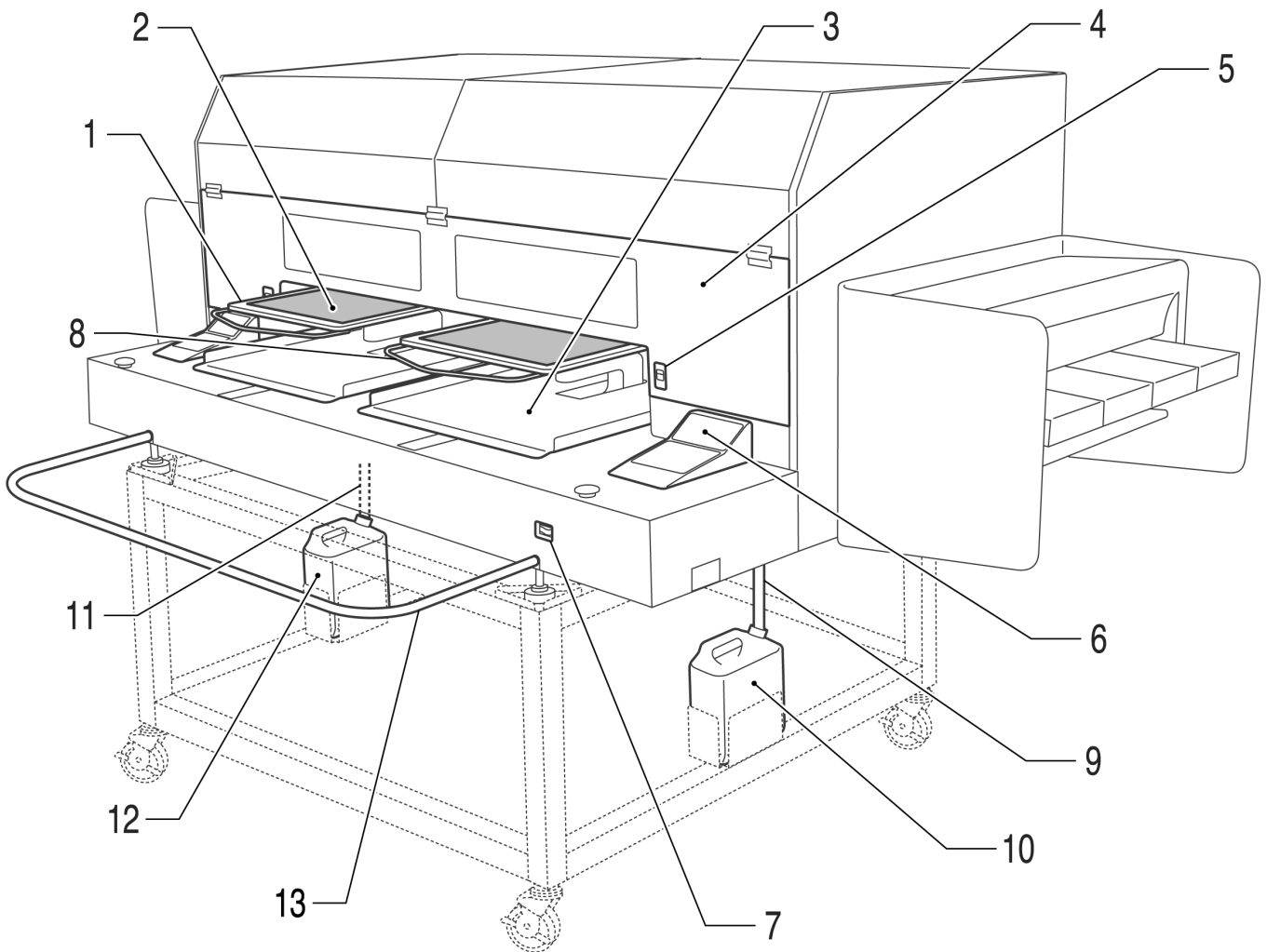

4322M

No.	Name	Description
1	Platen	Holds the T-shirt to be printed.
2	Platen Sheet	Prevents a T-shirt from slipping so that an image is printed on your desired position.
3	T-shirt Tray	Keeps parts of T-shirt hanging from the Platen (e.g. sleeves) on this T-shirt Tray.
4	Front Cover	Open this to work on the inside of your printer. Open it after you turn OFF the printer. (If you open the Front Cover while operating, the power automatically turns off.)
5	Cover Locks	Push this up to open the Front Cover.
6	Control Panel	Use this to operate your printer. See "2-6. Control Panel" for the details.
7	Power Switch	Turns on/off your printer.
8	Shoulder Bar	Adjusts the T-shirt position.
9	Waste Ink Tube (White)	Drains the waste ink (White)
10	Waste Ink Tank (White)	Holds the waste ink (White). Be aware of the room.
11	Waste Ink Tube (Color)	Drains the waste ink (Color)
12	Waste Ink Tank (Color)	Holds the waste ink (Color). Be aware of the room.
13	Guard Bar	Keeps the loading space of the Platens.

2. Identifying Your Printer's Parts

2-2. Left

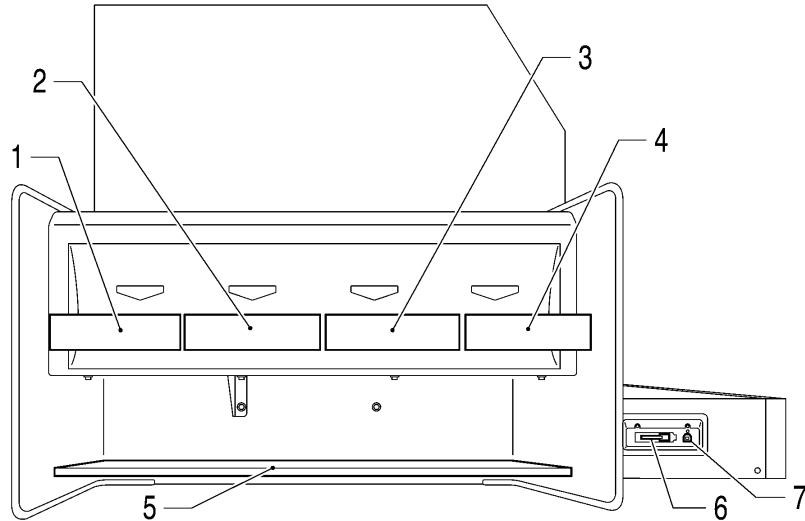

4323M

No.	Name	Description
1	Ink Cartridge Slot	Load the Ink Cartridges of the appropriate color Black (1), Magenta (2), Cyan (3), Yellow (4).
2		
3		
4		
5	Ink Cartridge Storage	Store the new Ink Cartridges.
6	CompactFlash slot	Inserts CompactFlash.
7	USB port	Inserts USB cable to PC.

2-3. Right

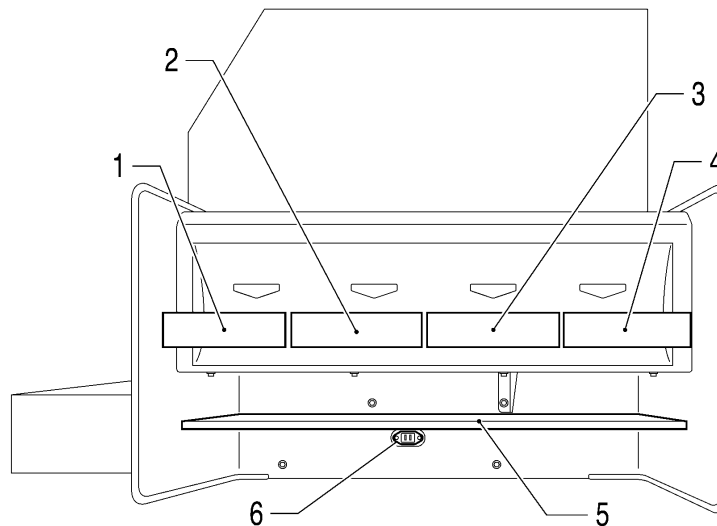

4324M

No.	Name	Description
1	White Ink Cartridge Slot	W1 is the front side and W4 is the back side.
2		
3		
4		
5	Ink Cartridge Storage	Store the new Ink Cartridges.
6	AC cord socket	Inserts AC cord.

2-4. Inside of the Front Cover

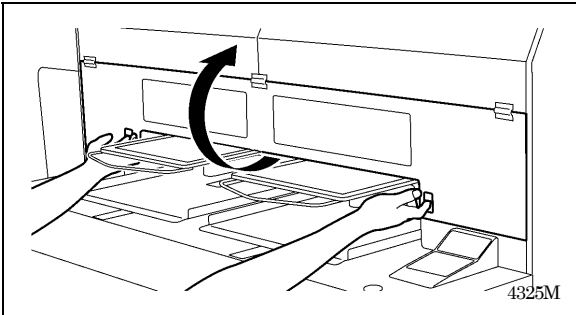

Cancel any operation, restore the Platens and turn off your printer before opening the Front Cover.
 Open the Front Cover with both hands after unlocking the cover locks and slide the Latch to fix the Front Cover.

<Note> If you open the Front Cover while operating, the power automatically turns off.

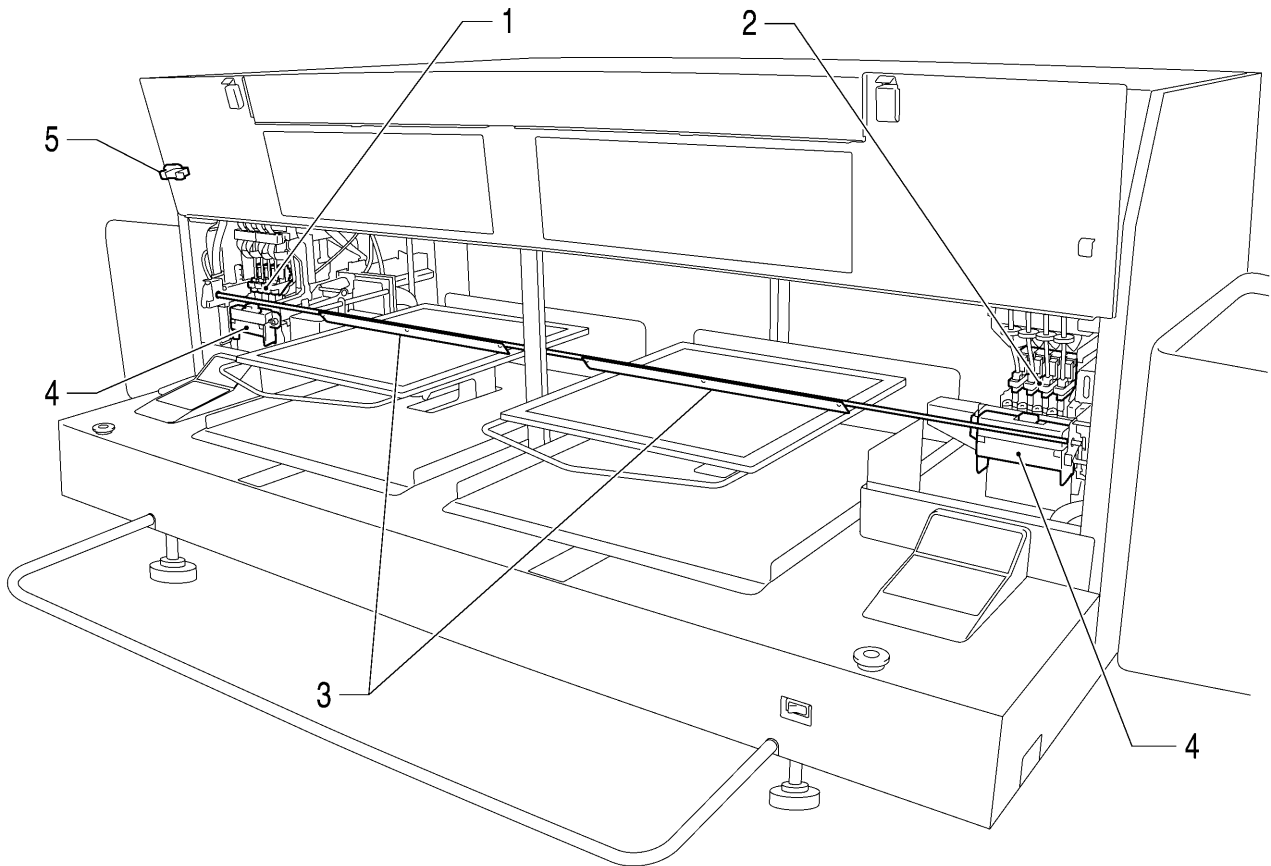

4326M

No.	Name	Description
1	Print Heads (Left)	Jets the Color Ink to the platen. From the left black, magenta, cyan, and yellow.
2	Print Heads (Right)	Jets the White Ink to the platen. From the left W1, W2, W3 and W4.
3	Obstruction Sensor (Left / Right)	Cancels an operation for safety, if it detects obstructions on the Platen. When you lower the platen for printing thicker materials, use Platen Button on the Control Panel and check the movement if the material does not hit the Obstruction Sensor (app. 2 mm gap from the surface of the material).
4	Wiper Cleaner Cassette (Left / Right)	Contains the Wiper Cleaner. Replace the Wiper Cleaner in the inside regularly.
5	Latch	Slide the lever and fix the Front Cover when it is kept open.

2-5. Under the Platen

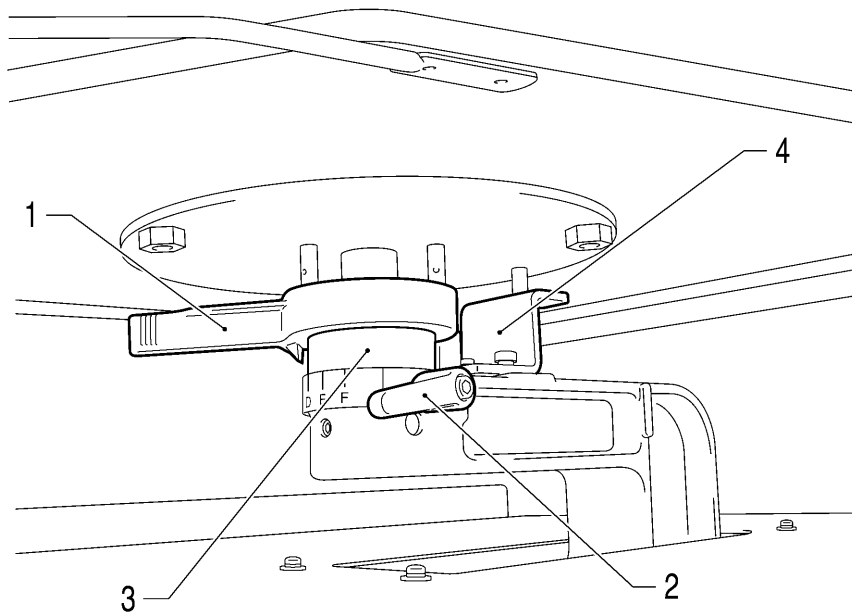

4327M

No.	Name	Description
1	Platen Height Adjustment Lever	Adjusts the Platen height. Leftmost "A" is the normal T-shirt position. Check the exact height with Platen Button on Control Panel when you print on thicker material.
2	Platen Fixing Lever	Fixes the Platen. Tighten/Loosen this lever to install/uninstall the Platen and to adjust the Platen height.
3	Bush Platen Shaft	Fixes and holds the Platen.
4	Platen Positioning Plate	

<Note>

If you print on thick material all the time, you can lower the highest position of the Platen by 10 mm. Replace the Bush Platen Shaft and Platen Positioning Plate to the ones of GT-541. Refer to "4-4-3. Lowering the Platen height"

2-6. Control Panel

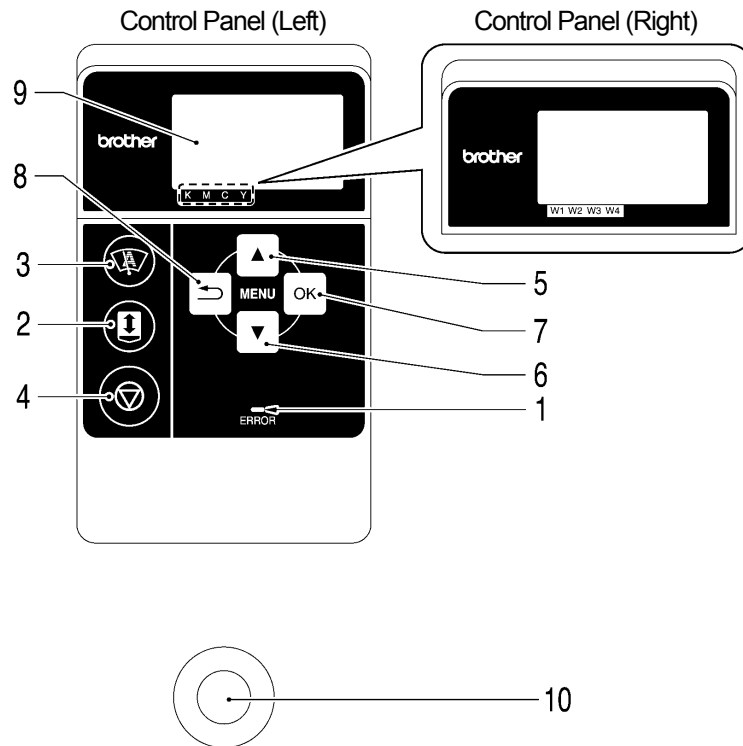

4328M

No.	Name	Description
1	Error Lamp	Indicates errors or warnings. See "2-6-1. Indication Lamps" for the details.
2	Platen Button	Loads / Ejects the Platen.
3	Head Cleaning Button	Cleans the Print Heads. See "7-2-2. Cleaning the Print Heads" in the Instruction Manual for the details.
4	Stop Button	Cancels printing or Print Head cleaning. Returns to Standby mode.
5	Up Button	Selects the previous (upper) item. Increases a numeric value. Opens the Menu display.
6	Down Button	Selects the next (lower) item. Decreases a numeric value. Opens the Menu display.
7	OK Button	Executes the selected command. Opens the Menu display. Clears the error status.
8	Back Button	Returns to the previous display. Opens the Menu display.
9	Display	Displays the Job Comment of the print data received, the status of the printer, and the menu items for various settings.
10	Print Button	Starts printing operation.

2. Identifying Your Printer's Parts

2-6-1. Indication Lamps

The lamps on the control panel indicate the status of your printer as shown below.

Lamp	Printer Status
Print Button	Off: No print data has been received.
	Flashing: Receiving a print data.
	On: Printing data has been received.
Error Lamp	Off: No error is detected.
	On: One or more errors have been detected (See "7-4. Error Messages" in the Instruction Manual for the details).

<Note>

On machine initialization these lamps have a 30 second self check time.

2-6-2. Display

Menu Display:

This display is used to select an operation for maintenance or setting up.



Left Menu

Right Menu

Job/ Status Display:

When your printer has received a print data, it shows the Job/ Status Display: it displays the information needed for printing operations.

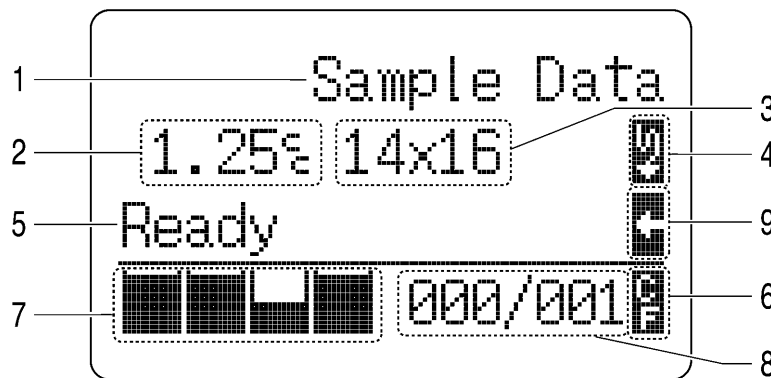

4329M

No.	Item Shown	Description
1	Job Comment	Shows the last 17 characters of a received data.
2	Amount of Ink Required	Shows how much ink (cc) is required for making one print of the received data. Shows warning message(s) if necessary.
3	Platen Size	Shows Platen Size set by Printer Driver.
4	Double Print Icon	Appears when "Double Printing" is checked in "Color Only" or Highlight White data is included in "Color + White" and "White Only".
5	Printer Status	Shows the printer status.
6	CF Icon	Appears when a CompactFlash is inserted.
7	Amount of Ink Remained	Shows amount of ink remained in each cartridge. (from the left, Color: <K (Black)>/ <M (Magenta)>/ <C (Cyan)>/ <Y (Yellow)>, White <W1><W2><W3><W4>) It flashes when ink is low. Prepare the new cartridge(s).
8	Number of Print	Shows "total number of prints completed (L/R platens)"/ "Total number of prints set by Printer Driver".
9	Uni-Direction Icon	Shows when the printer or the print data is set to uni-directional printing.

<Note> When one or more errors are detected, error message(s) will be displayed instead.

2. Identifying Your Printer's Parts

2-6-3. Menu List

There are some differences in Left/Right menu. White Ink menus are in the right and CompactFlash and general menus are in the left control panels

Left Menu	Content
Head Cleaning	Executes Head Cleaning by one or all four Print Heads. Refer to "7-2-2. Cleaning the Print Heads" Normal: normal mis-firing Powerful: After cleaning the Print Head nozzles, when normal head cleaning does not work.
Test Print	Prints to check mis-firing and print quality. Nozzle Check: shows mis-firing Standard Check: shows general print quality
Card Data Load	Reads print data (ARP file) in CompactFlash. The inside folder shows with [...].
Print Direction	Sets the print direction. This setting is prior to Printer Driver setting. Auto: Default bi-directional, Printer Driver setting is available. Always Uni- : always prints uni-directionally. Always Bi- : always prints bi-directionally. Refer to "7-2-4. Changing the Print Direction".
Maintenance	Goes into the maintenance submenu. Cap/Wiper Clean: "6-1-2. Replacing the Wiper Cleaner" Nozzle Cleaning: "7-2-6. Cleaning the Print Head Nozzles" Head Replacement: "7-2-7. Replacing the Print Head" Auto Cleaning: "7-2-5. Changing the Auto Head Cleaning Setting" Initial Cleaning: Loads ink into the tube and Print Heads. Tube Cleaning: 3-time Initial Cleaning to flush the whole tube and Print Heads. (CMYK) CR Speed Adjust: Adjusts the increase/decrease of the Carriage speed. Extra Wipe Set: "7-2-10. Setting Extra Wipe"
Total Print	Shows the number of prints on the left Platen.
Speaker Volume	Adjusts the speaker volume.
LCD Contrast	Adjusts the Display contrast.
Whole Update	Updates the firmware.
Auto Power-Off	Stops the controllers automatically and save the power after the set hour(s). Default is [0] (no power off). Turn ON the printer for re-start.
Platen Reset	Restores the left Platen.
Language	Sets the language shown on the display.
Temperature	Sets Fahrenheit / Centigrade
Auto Job Delete	Delete the print data automatically after the print number which is set with Printer Driver is finished. Default is OFF.
Version	Shows versions.

Right Menu	Content
Head Cleaning	Executes Head Cleaning by one or all four Print Heads.
Test Print	Prints to check mis-firing and print quality.
White Retrieval	After printing, retrieves White Ink and loads Maintenance Solutions. "6-1-3. Loading / Retrieving White Ink"
Load White	Loads White Ink into the tubes and Print Heads. "6-1-3. Loading / Retrieving White Ink"
Maintenance	Goes into the maintenance submenu. Tube Cleaning: "6-1-3. Loading / Retrieving White Ink" (White)
Total Print	Shows the number of prints on the right Platen.
LCD Contrast	Adjusts the Display contrast.
Platen Reset	Restores the right Platen.
Version	Shows versions.

3. Getting Started

Before using your printer, it needs to be correctly setup as described in this chapter.



WARNING



Do not handle the power cord with wet hands, otherwise it may cause electric shocks.



Do not set up the printer in a dusty environment. If dust collects inside the printer, it may cause fire or electric shocks or problems with correct operation.



Be sure to connect the ground. If the ground connection is not secure, you run a high risk of receiving a serious electric shock, and problems with correct operation may also occur.



Do not bend the cords excessively or fasten them too hard with staples or anything similar to secure cords, otherwise there is the danger that fire or electric shocks could occur.



CAUTION



Setting up and moving of the printer should only be carried out by a qualified technician.



The printer machine weighs approximately 230 kg (507 lb). Transporting and setting up of the printer should be held in proper way. The machine may fall down and cause injury.



The printer must be used on a suitable stable surface, otherwise it may tip over or fall down and cause injury.



Furthermore, the table that supports the printer should be at least 180 cm (70.9 inch) in width and 90 cm (35.4 inch) in depth, and should be able to bear a weight of 250 kg (555 lb) or more.



Do not set up the printer in a place where it will be affected by vibration. It may become unbalanced and fall down, which cause injury or damage to the printer.



Do not connect the power cord until setup is complete, otherwise the printer may operate if the power switch is turned on by mistake, which could result in injury.



Do not climb onto the printer or place heavy objects on top of it, otherwise it may become unbalanced and tip over or fall down and cause injury.

3-1. Placing Your Printer

Locate your printer taking the following into account

- Environmental conditions are suitable.
- Avoid direct sunlight, dust and extremes of humidity.
- Never use an extension cable.
- A working space must be left around the printer.
Minimum space of 80 cm (31.5 inch) on the front, 5 cm (1.97 inch) on the rear, 50 cm (19.7 inch) on the both side.
Body size is about 267 cm (105.1 inch) x 115 cm (45.3 inch) x 83 cm (32.7 inch). See the figure below.
- The table that supports the printer should be at least 180 cm (70.9 inch) in width and 90 cm (35.4 inch) in depth, and should be able to bear a weight of 250 kg (555 lb) or more.

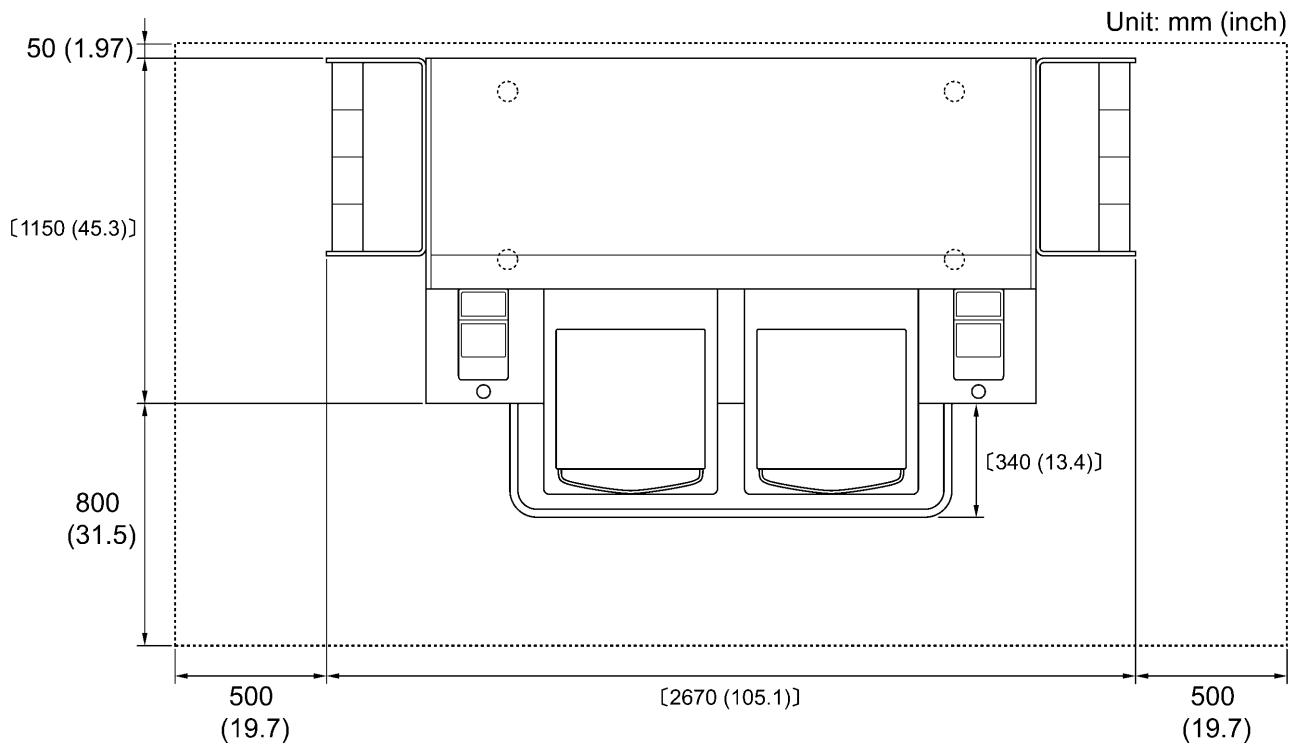

4446M

3-2. Turning On/Off Your Printer

<Note>

Before you connect the power cord, make sure:

- The Ink Cartridges and Wiper Cleaner Cassette are installed.
- Waste ink tubes are properly set the waste ink tanks.
- Keep the front space inside the Guard Bar as the Platen slides out approximately 30 cm (12 inches) when operating.

3-2-1. Turning On Your Printer

- (1) Shake the White Ink Cartridges beforehand (30 seconds to 1 minute for each).
- (2) Connect the power cord (included) to the power cord socket of your printer.
- (3) Connect the power plug to the power outlet.
Ensure the printer is connected to a suitable earth point
- (4) Press the Power Switch to turn on your printer.
Your printer turns on, displays "Welcome to GT-782", and lights up the Error Lamp and the Print Button while initializing. The initialization requires approx. 40 seconds and will indicate when it is completed.
When the installation finishes, the machine enters standby mode.

3-2-2. Turning Off Your Printer

When you have finished using your printer, follow the instructions below to turn it off.

- (1) Make sure that your printer is "standby" or "ready" mode.
- (2) Select "Platen Reset" in Menu or press Platen Button to store the Platen.
- (3) Press Power Switch to turn off your printer.
- (4) If you are planning not to use your printer for over-two-week periods of time, disconnect the power plug from the power outlet.

<Note>

- Do not leave the White ink inside the printer. White pigment precipitates and may cause serious damage to your printer. Before you start your job, retrieve the White Ink, shake the cartridges for 30 seconds to 1 minutes, and then load the White Ink again to start your printing. Clean the tubes once a week with Maintenance Solution. Follow the steps of "6-1-3. Loading /Retrieving White Ink".
- Do not turn off your printer when it is operating. It may cause serious damage to your printer. If you turn off your printer accidentally during the operation, immediately restart it, and then turn it off correctly following the steps described in this section.
- If the printer is unused for a long time we recommend turning on your printer once a week and press the left Head Cleaning Button to clean the CMYK Print Heads. This ensures the ink is kept free flowing. As for White Print Heads, do the powerful cleaning with maintenance solution.
If you are planning not to use your printer for more than two weeks, follow "6-1-6. Required Maintenance for the Long Storage" to prevent ink clogging.

3-3. Preparing Your PC

This section describes how to install the GT-782 Printer Driver (FileOutput), manuals (Basic Operation Manual/ Instruction Manual), Brother GT File Viewer, and other tools. Make sure the steps because there are some different dialogs shown between Windows XP and Vista / Windows 7.

After those installations are over, install GT-782 Printer Driver (USB) by connecting USB 2.0 cable.

3-3-1. When you already have GT-541

When you already have GT-541, upgrade first to the latest printer driver (ver. 2.0.6 or above) before installing GT-782 to your PC. If you install GT-782 first and then need installing GT-541 later, be sure to install the latest printer driver (ver. 2.0.6 or above).

You can get the latest version by downloading the Web site. Or make contact to your dealer or Brother.

<Note>

- In case that the GT-541 is not the latest version, you can normally install GT-782 but can not uninstall GT-541 normally: the relation between ARP files and GT File Viewer disappears. In this case, re-install GT-782. See "3-3-2. PC preparation: For Windows XP" or "3-3-6. Installation of PC for Windows Vista / Windows 7" and execute "Setup.exe".

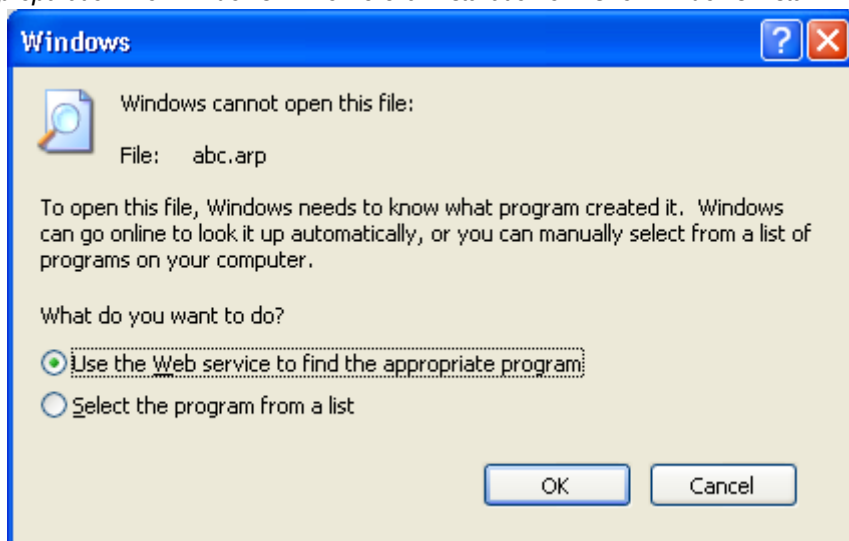

- In case that you install the lower version GT-541 (below 2.0.6) to the PC that GT-782 has been already installed, installation fails and the error message below appears. Install the latest version.

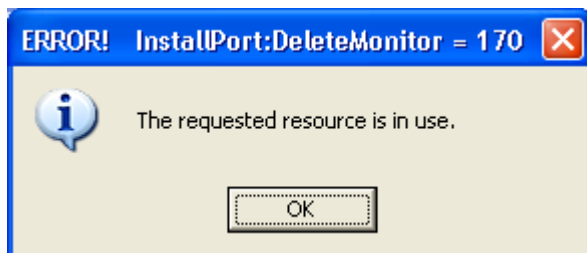

(Continued on the next page)

3. Getting Started

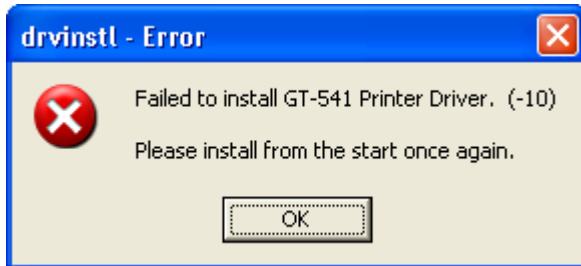
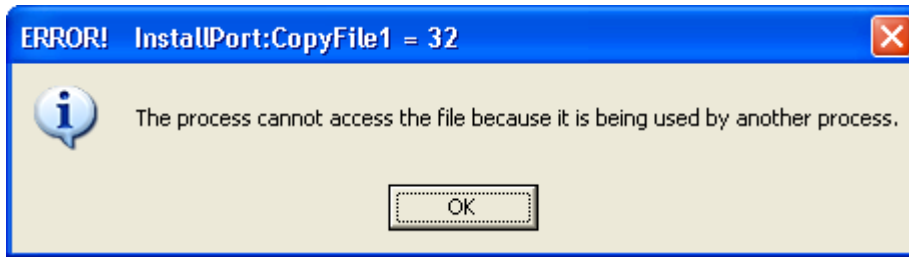

3-3-2. PC preparation: For Windows XP (32 bit)

Do not connect the printer to the PC at this stage.

<Note>

You must be logged on with Administrator rights on the PC.

- (1) Turn on your PC.
- (2) Close all open applications
- (3) Insert the Install CD (included) to your PC.
Open the CD-ROM drive, move to [32bit_OS] and double-click "Setup.exe".
- (4) The Installer starts installation. Follow the indications of the dialogs.

<Note>

When you install to the PC that the printer drivers and tools are already installed, the message to confirm uninstallation appears. If you click "Yes", uninstallation starts to uninstall the necessary tools but Printer Driver(s) is/are not uninstalled. If uninstallation fails, a dialog box appears "Uninstallation of the former version failed. Do you want to continue installing the new version?". Click [No] and quit the installer. Open "Add or Remove Programs" of Control Panel and remove "Brother GT-782 Tools". Then start the installation from the beginning.

- (5) During the installation, the following warning appears. Click "Continue Anyway" and continue.

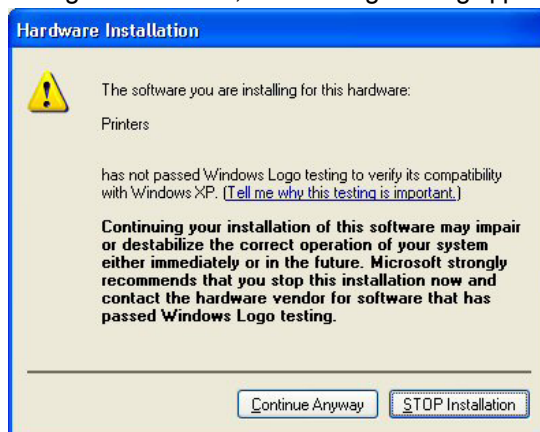

Windows XP

- (6) After installation, your PC will need to restart. Restart your PC. If you are going to use your printer without connecting it to your PC, this will be the end of PC preparation.

3-3-3. Connection with USB 2.0 Cable: for Windows XP

- (1) Connect the USB 2.0 cable to your printer (power OFF).

<Note>

We do not recommend connection via a USB hub to the printer.

- (2) Connect the other end of the USB 2.0 Cable to your PC.
- (3) Turn on your GT-782 printer. The following window appears.

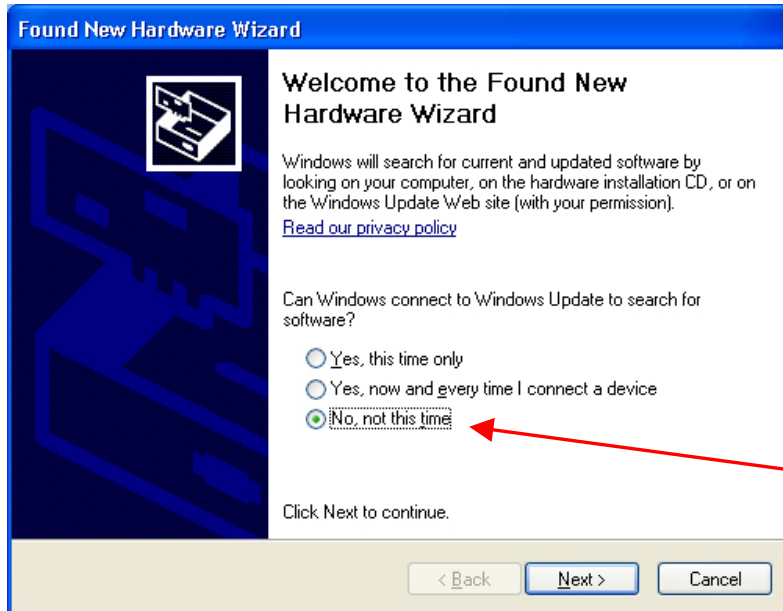

Select "No, not this time", and then click "Next".

- (4) Insert the Install CD. The following window appears.

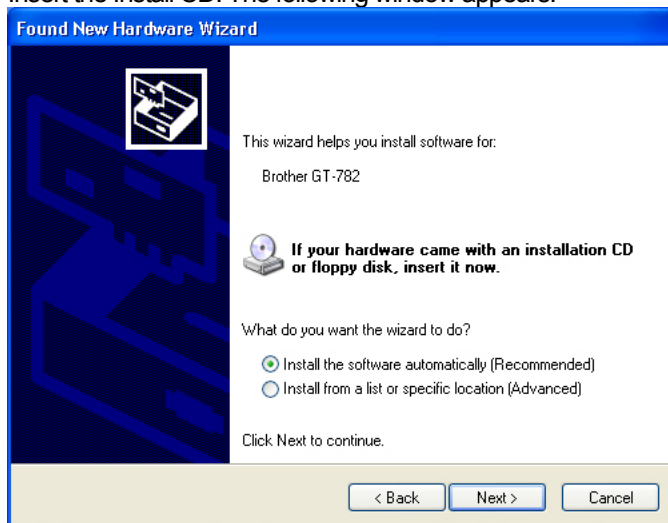

3. Getting Started

- (5) Select "Install the software automatically (Recommended)", and then click "Next". The installation starts. When "Hardware installation" dialog (not passed Windows Logo testing, see 3-3-2. (5)) appears during installation, Click "Continue Anyway". The installation continues.

<Note>

- If you connect the USB 2.0 cable anyway, the dialog to insert the install CD appears. Confirm that the Install CD is inserted properly, and then click "OK".
- If install CD is not in drive [D:], the following window appears. Click "Browse..." to select the CD drive, select GT-782.gpd in [32bit_OS] the folder and then click "OK". The installation continues.

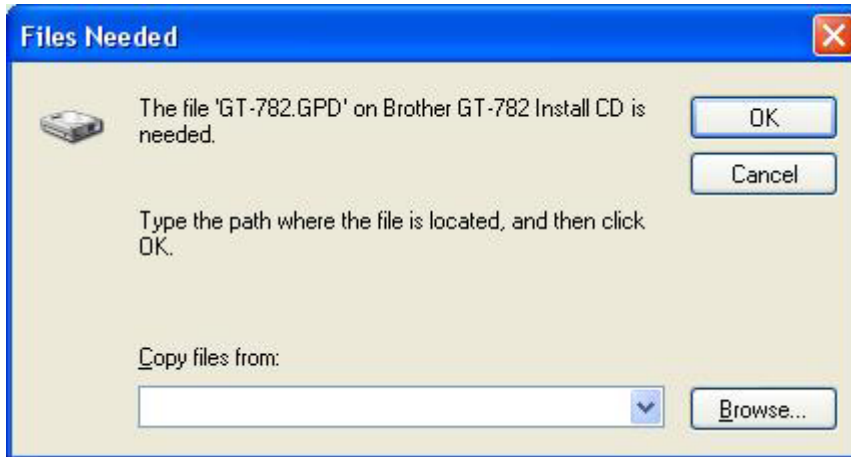

- (6) Click "Finish" when "Completing the Found New Hardware Wizard" dialog.
- (7) Open "Printers and Faxes" in "Control Panel".
- (8) Click either "Brother GT-782" "Brother GT-782 FileOutput" icon and select "Set as Default Printer" on "File" menu. "Brother GT-782" icon is checked and Brother GT-782 is set as the default printer. This will help to do the layout with your application software.

The PC setup is now completed.

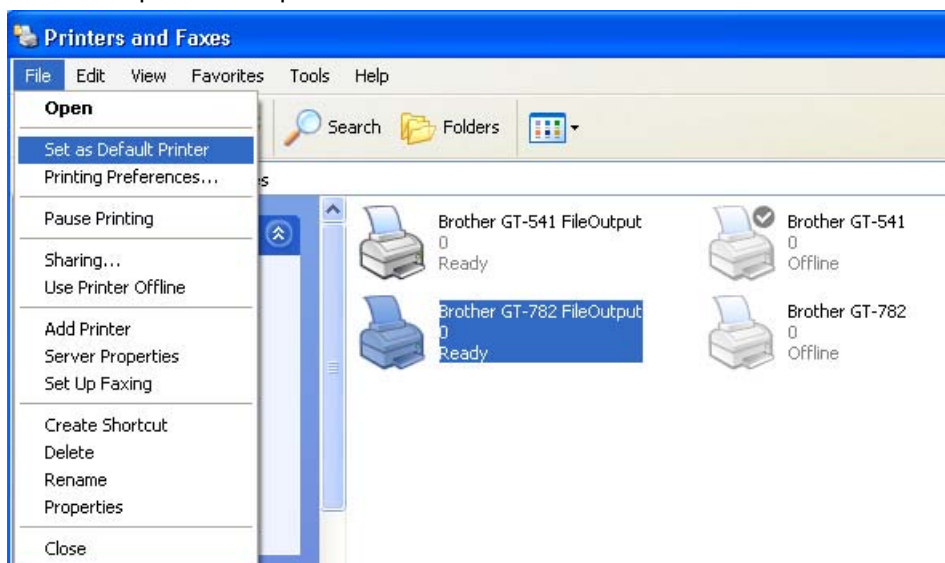

<Note> for installations of more than one GT-782 printer.

To connect another GT-782 to the PC, repeat the steps of 3-3-3. Connection with USB 2.0 Cable: for Windows XP. From the second GT-541, the printer names automatically become "GT-541 (copyX)". You can change the names as "GT-541 xxx" in the "Printer and Faxes" in the "Control Panel" for your workability.

3-3-4. Opening the installed manuals

- (1) Click "All Programs" on "Start" menu.
- (2) Select "Manuals" in "Brother GT-782 Tools".

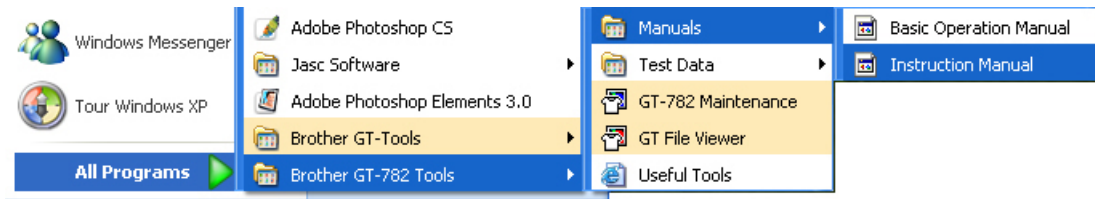

- (3) Click the manual you want to open. The language is the same that is selected in installation.

<Note>

Only manuals with selected language are installed to your PC. Others PDF files are in the folder "Manual" on Install CD.

3. Getting Started

3-3-5. Opening the Useful Tools

Useful Tools are installed in "Useful Tools" in "Brother GT-782 Tools".

Color Palettes for Adobe Photoshop, Illustrator and CoreIDRAW

Color Palettes "GT_Colors_T.aco" for Adobe Photoshop, "GT_Colors_T.ai" for Illustrator, "GT_Colors.cpl" and "GT_Tshirts.cpl" for CoreIDRAW are available. The colors are the same in GT Color Chart "ColorChart.arp" in "Test Data" in "Brother GT-782 Tools", which are GT-541 Colors plus T-shirt body colors in the list of transparent colors in the Advanced Menu of Printer Driver. Print "ColorChart.arp" to check the colors that your Printer actually provides as color formula guide. (CoreIDRAW does not allow to put the same colors in one color palette so we provide two different color palettes.)

- (1) Select "All Programs" in PC "Start".
- (2) Select "Useful Tools" in "Brother GT-782 Tools".

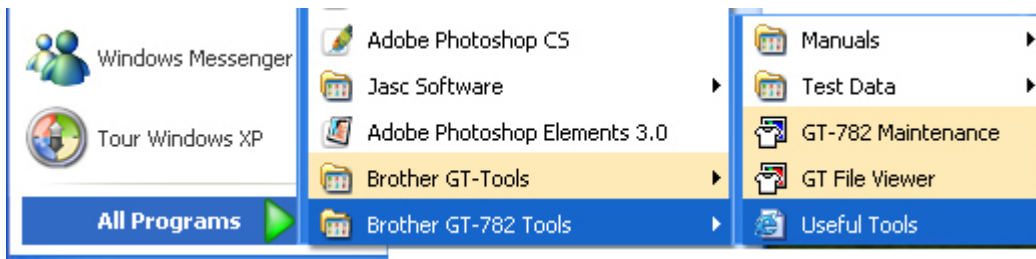

- (3) Click the files you want to download as indicated.
- (4) To use Color Palettes in the applications, see "4-2. Setting the Applications' Print Condition " or refer to the Help of the applications.

Printing Grid data on the Platen Sheet

- (1) Select "Useful Tools" in "Brother GT-782 Tools".
- (2) Double-click the Grid print data that fits the Platen size (e.g. Grid14x16.arp) and send it to the printer.
- (3) Print the data on the Platen directly, with no T-shirt on. Touch the surface with paper or cloth to dry the ink after printing.

<Note>

Print on a new Platen Sheet when you exchange to a new one.

Color Lists (PDF)

Color Lists are available as the image data (PDF) along with the print data "ColorChart.arp" (ARP). Blues, Greens, Oranges, Reds and Color Chart image data are in Useful Tools. You can change the printer driver menus to see how the colors change with the settings. Use PLTN 14x16.

- (1) Select "Useful Tools" in "Brother GT-782 Tools".
- (2) Open or save the files "GT_Blues.pdf"(blue-violet), "GT_Greens.pdf"(green-yellow), "GT_Oranges.pdf"(orange), "GT_Reds.pdf"(red-purple) or "GT_ColorChart.pdf".

3-3-6. Installation of PC for Windows Vista / Windows 7 (32 bit / 64 bit)

Refer first to "3-3-3. Connection with USB 2.0 Cable: for Windows XP" first and confirm the procedures and notes.

In brief, like for Windows XP and Windows 2000, GT-782 FileOutput Printer Driver, tools and manuals are installed first from Install CD, and PC must be restarted. Then PC is connected to USB 2.0 cable, the printer turned ON, and USB 2.0 cable connected to the printer.

Installation of GT-782 FileOutput Printer Driver

Do not connect the printer to the PC at this stage.

<Note>

You must be logged on with Administrator rights on the PC.

- (1) Turn on your PC.
- (2) Close all open applications
- (3) Insert the Install CD (included) to your PC.
Select either [32bit_OS] or [64bit_OS] (depends on your PC) and execute " Setup.exe".
- (4) The monitor turns dark and the following dialog appears when User Account Control is ON. Select "Continue".

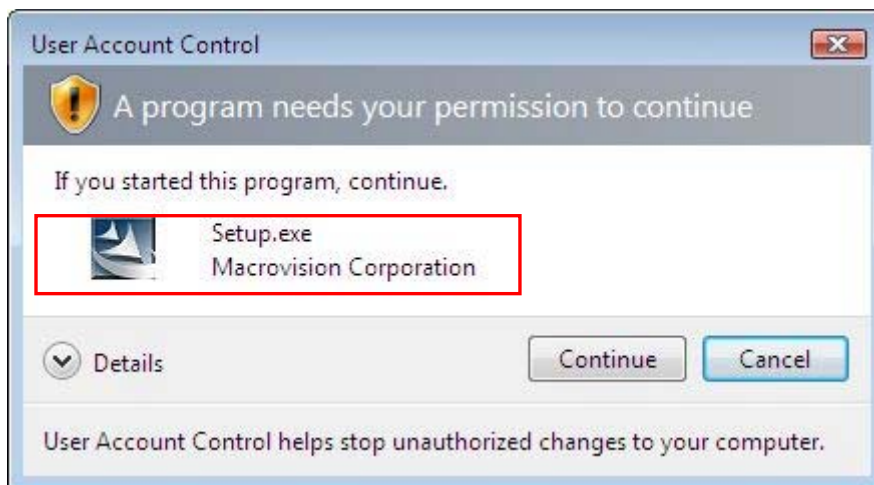

(Continued on the next page)

3. Getting Started

- (5) The Installer starts installation. Follow the indications of the dialogs.
- (6) During the installation, the following warning appears. Click "Install this driver software anyway" and continue.

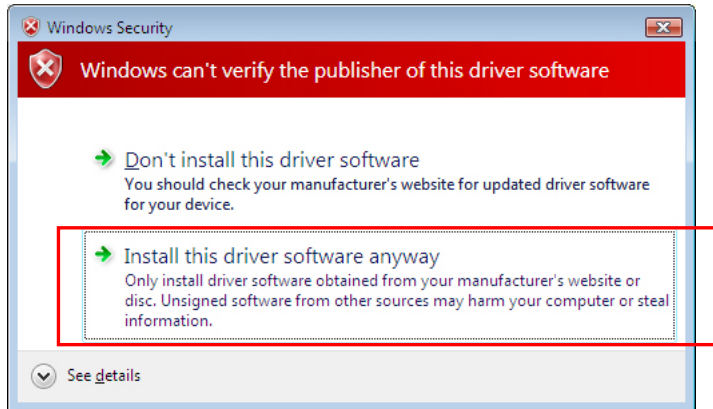

- (7) After installation, your PC will need to restart. Remove your Install CD and restart your PC. If you are going to use your printer without connecting it to your PC, this will be the end of PC preparation.

3-3-7. Connection with USB 2.0 Cable: for Windows Vista / Windows 7

- (1) Connect the USB 2.0 cable to your printer (power OFF).
- (2) Connect the other end of the USB 2.0 Cable to your PC.
- (3) Turn on your GT-782 printer. Installation starts automatically. The information appears at the right bottom of the PC monitor.
- (4) After installation, open "Printers" in "Control Panel" of PC.
- (5) Click either "Brother GT-782" or Brother GT-782 FileOutput icon and select "Set as Default Printer" on "File" menu. "Brother GT-782" icon is checked and Brother GT-782 is set as the default printer. This will help to do the layout with your application software. The PC setup is now completed.

3-4. Setting Up Your Printer

Adjust the display contrast and the speaker volume as required.

3-4-1. Adjusting the Display Contrast

- (1) Press the OK Button on your printer's Control Panel.
- (2) Use the Up/Down Button to highlight "LCD Contrast", and then press the OK Button.
The following display appears.



- (3) Use the Up/Down Button to select your desired contrast from 0 to 7, and then press the OK Button.

3-4-2. Adjusting the Speaker Volume

- (1) Press the OK Button on the left Control Panel.
- (2) Use the Up/Down Button to select "Speaker Volume", and then press the OK Button.
The following display appears.



Left menu

- (3) Use the Up/Down Button to select your desired volume from 0 (silent) to 7, and then press the OK Button.

3-4-3. Language

- (1) Press the OK Button on the left Control Panel.
- (2) Use the Up/Down Button to select "Language", and then press the OK Button.
- (3) Use the Up/Down Button to select your desired language from English / Español (Français / Deutsch / Italiano in higher version) and then press the OK button.

3-4-4. Temperature

- (1) Press the OK Button on the left Control Panel.
- (2) Use the Up/Down Button to select "Temperature", and then press the OK Button.
- (3) Use the Up/Down Button to select from Fahrenheit / Centigrade and then press the OK button.

4. Printing Directly from Applications



WARNING



If a foreign object gets inside the printer, immediately turn off the power switch and disconnect the power cord, and arrange for a service call to resolve.



If you continue to use the printer while there is a foreign object inside, it may result in fire or electric shocks or problems with correct operation.



Do not allow water or oil to get onto the printer, otherwise it may cause fire or electric shocks or problems with correct operation.



If any liquids get onto the printer, immediately turn off the power switch and disconnect the power cord, and arrange for a service call to resolve.



Do not use the printer when smoke or a bad odor coming from the printer, otherwise it may cause fire or electric shocks or problems with correct operation. Immediately turn off the power switch and disconnect the power cord, and arrange for a service call to resolve.



CAUTION



This printer should only be used by operators who are appropriately trained in its operation.



Do not move the Platen by hand.
The Printer may be seriously damaged by this.



When a problem occurs with the operation of the printer, contact the place of purchase or a qualified technician.

4-1. Basic Printing Procedure

- (1) Set the proper color settings and print conditions of the application. For precise editing and output, applications such as Adobe Photoshop, Illustrator, CorelDRAW, Paint Shop Pro are recommended.
See "4-2. Setting the Applications' Print Condition" for further details.
- (2) Create the artwork using a suitable graphic application. Use RGB=254 (=254, 254, 254) white for white color. RGB=255 (=255, 255, 255) white (paper color) is transparent color with no ink printed.
- (3) Select [File] > [Print] menu of your application and set Printer Driver conditions.
See "4-3. Setting the Printer Driver Condition".
- (4) Turn on your printer:
See "3-2-1. Turning On Your Printer".
- (5) Load White ink to the printer. See "6-1-3. Loading / Retrieving White Ink".
- (6) Send data to your Printer. Select Printer Driver: either GT-782 Printer Driver (USB 2.0 Cable) for direct print or GT-782 FileOutput Printer Driver to make print data file (.arp).
As for sending .arp file to your Printer, see "5. Printing ARP Files".
- (7) Install the Platen of the size you have selected in step (3).
See "4-4. Uninstalling / Installing the Platen".
- (8) Set the T-shirt (as for dark garments, pretreated) on the Platen and adjust the Platen height. The operation on the both platens (Left/Right) is the same. See "4-5. Placing the T-shirt on the Platen".
- (9) Press the Print Button on the Control Panel to start printing. When you print more than two T-shirts, set the second T-shirt on the other platen and press the Print Button.
- (10) Remove the "printed" T-shirt from the Platen.
See "4-7. Removing the T-shirt from the Platen".
- (11) Fix the ink with heat onto the T-shirt.
Use a conveyer oven or a heat press to fix the ink onto the T-shirt. See "4-8. Curing the Ink onto the T-shirt".
- (12) Repeat (8) to (11) until all the prints are finished.
- (13) When all printing is completed, retrieve the White ink and then load the Maintenance Solution. See "6-1-3. Loading / Retrieving White Ink".
- (14) Turn off your printer. See "3-2-2. Turning Off Your Printer".

4-2. Setting the Applications' Print Condition

This section describes the settings for correct printing of garments.

4-2-1. Common Notice for All Applications

Color Mode / Color Space:

GT-782 Printer is **RGB (Red Green Blue) printer**. If you use Adobe, Corel applications, please note that some colors in CMYK (Cyan Magenta Yellow Black) mode cannot be printed as expected because of the color matching process. We strongly recommend that the artwork should be made in RGB mode and working space should be always **"sRGB IEC61966-2.1"**.

4. Printing Directly from Applications

Print Layout:

Your printer has a large print area 14x 16 inches (35 x 40 cm), Any application has a rule to do the layout in printing, e.g. Microsoft Internet Explore sets the artwork at the center top, Microsoft Power Point does at the center middle. The GT-782 Printer does not have Letter or A4 paper size. To avoid this issue, please set the paper size as 14x 16 inches (35 x 40 cm) and do the layout manually by yourself. Use GT-782 FileOutput Printer Driver to see the final layout with GT File Viewer.

We recommend that GT-782 Printer should be your PC's default printer. See the last section of "3-3-3. Connection with USB 2.0 Cable: for Windows XP" or "3-3-7. Connection with USB 2.0 Cable: for Windows Vista / Windows 7".

How to make White data:

Printer Driver makes either White-only print data or Color-on-White-mask (under base) print data from one image data. When you print colorful image by selecting "White-only", then the output is monochrome. Set RGB=254 white for white image. RGB=255 (paper color) is transparent with no ink printed. When there are some spots in RGB=255 color in a photo, e.g. those spots will never be printed. Use GT-782 FileOutput Printer Driver to see the final layout with GT File Viewer. As for the operations for each application, refer to the following pages or application help.

Print Cancel:

Your printer does not start printing until you press the Print Button; The printer memory only holds one print job data at any time.

<Important!>

Do not use canceling command from "Printer and Faxes (for Windows XP)" / "Printers (for Windows Vista)" / "Devices and Printers (for Windows 7)" in "Control Panel". Doing so causes an error and you may have to restart your printer.

Print ARP files:

Use "GT-782 FileOutput" Printer Driver, which saves print data in ARP format. With this you can see the detailed print conditions and estimated ink cost. See "5. Printing ARP Files." for the details.

<Important!>

Do not use "Print to File" command in the applications' Print window. File extension may be different.

<Note>

- *The settings of printer driver may be applied for one print; it depends on the application.*
- *The settings made with Control Panel of your PC sometimes may not be applied to the application. If so, make the settings again in the menu of printer driver; these are applied to the actual settings.*

4-2-2. Settings for CoreIDRAW

Color settings:

- (1) Select [Tools] > [Color Management]
- (2) **CoreIDRAW 10/11/12:** Select "Color Management off" as the style.

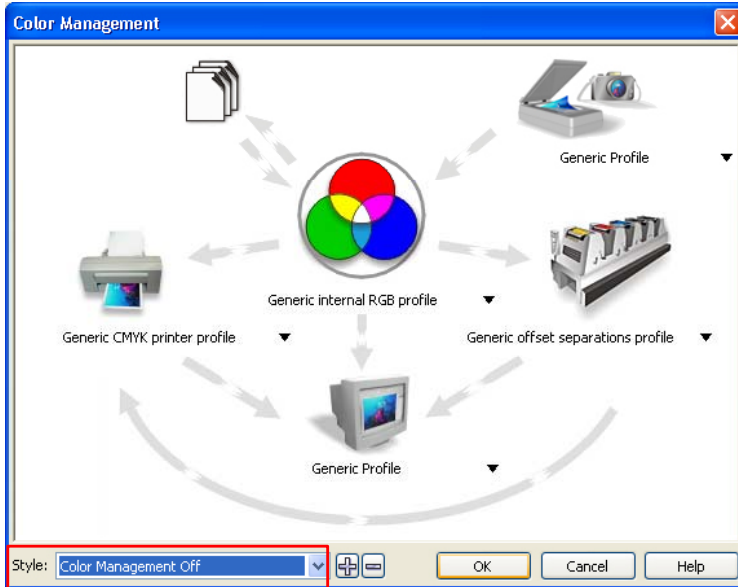

CoreIDRAW 10/11/12

CoreIDRAW X3/X4: Select RGB radio button. Check the left top menu: it changes [default settings] to [Custom (Current settings not saved)]. Also click the orange arrow from [Generic CMYK printer profile] to [Generic Profile]

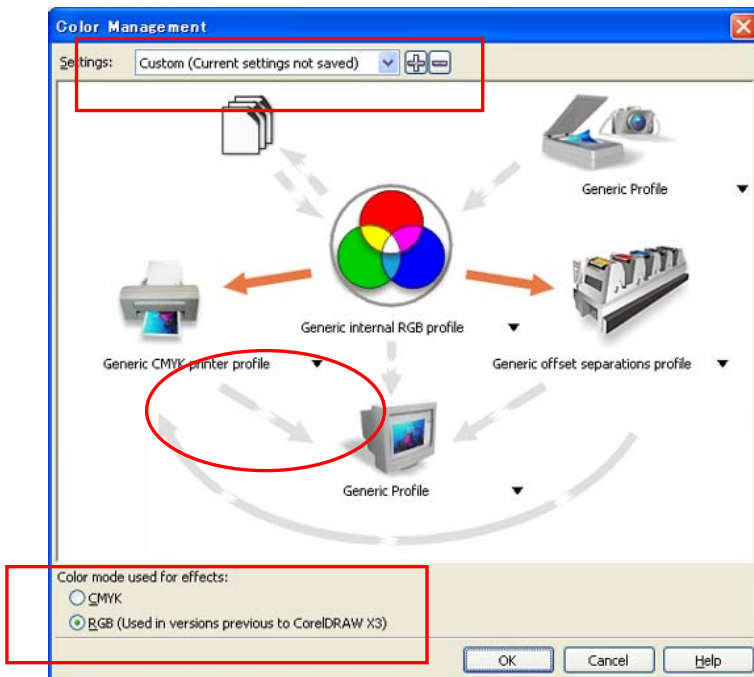

CoreIDRAW X3/X4

4. Printing Directly from Applications

Print Area:

- (1) Select [File] > [Print Setup] menu.
- (2) Select "Brother GT-782" or "Brother GT-782 FileOutput" for the printer to be used. Your PC's default printer is recommended.
- (3) Select [Layout] > [Page Setup] menu.
<Note> These steps can be applied to set an accurate layout for already existing files.
- (4) Click "Set From Printer" to preview the created image in the Platen size.

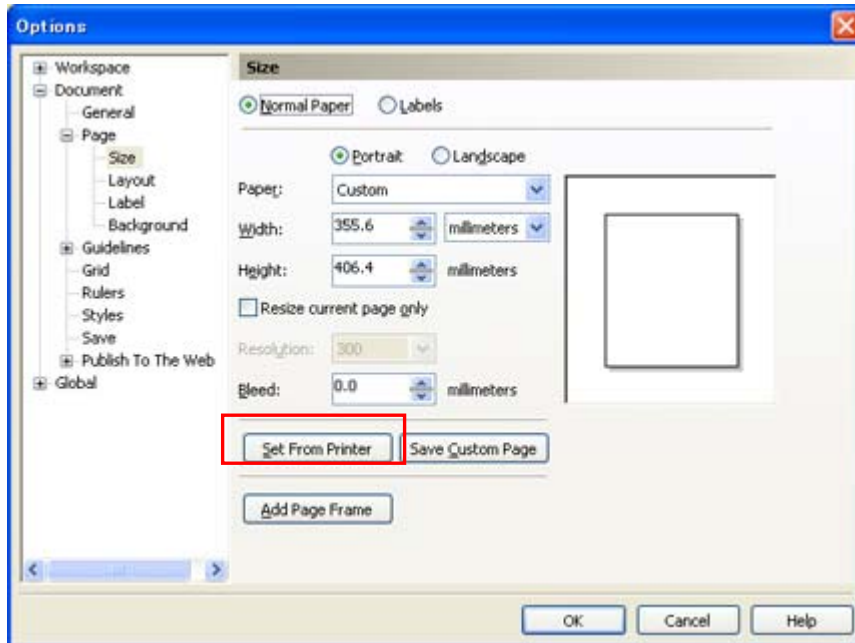

Use Color Palettes in Useful Tools:

- (1) See "3-3-5. Opening the Useful Tools " and download CorelDRAW Color Palettes "GT_Colors.cpl," "GT_Tshirts.cpl".
- (2) Select the [Window] > [Color Palette] > [Open palette] menu.
- (3) Select "GT_Colors.cpl," "GT_Tshirts.cpl". Use them with the Color Chart "GT_ColorChart.arp". See "4-3-9. Printing Color Chart".

<Important!>

Do not use HKS, Pantone and other licensed palettes. Those spot Colors are treated "special" for screen-printing Color separation (remember you can print each Color by print menu). GT-782 Printer Driver cannot deal with these information in Color matching.

Print: (CorelDRAW 10/11/12/X3):

- (1) Select [File] > [Print] menu.
Click "Properties" to do Printer Driver settings.

<Important!>

Do not check "Print to File" on Print window to make print files. Use GT-782 FileOutput Printer Driver.

Convert to Bitmap:

- (1) Select [Bitmaps] > [Convert to Bitmap...] menu.
- (2) **CorelDRAW 10/11/12:** Make sure that "Color" is RGB and "Apply ICC Profile" is OFF. 200 dpi is enough for solid clipart.

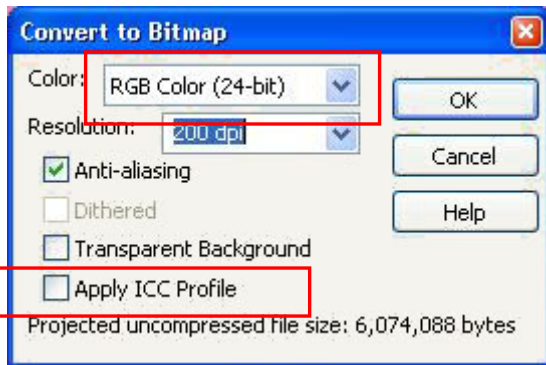

CorelDRAW 10/11/12

CorelDRAW X3/X4: Make sure that "Color" is RGB and "Apply ICC Profile" is ON.

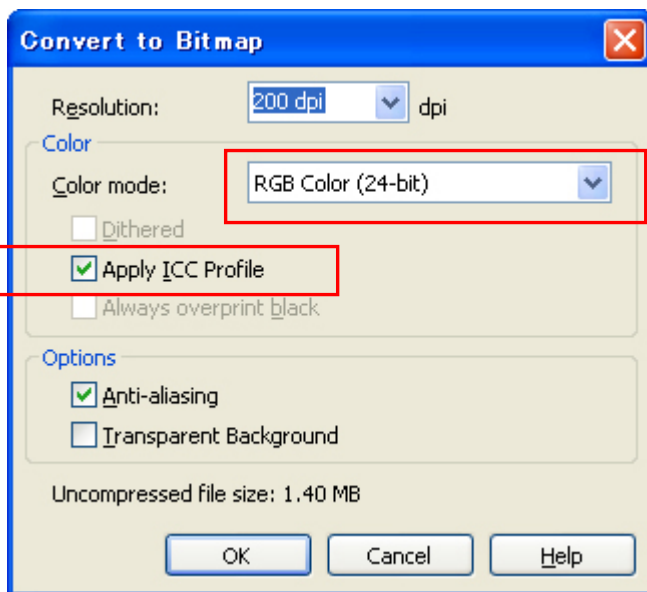

CorelDRAW X3/X4

<Important!>

- The platen size may become 14x16 inches when pressing Set From Printer, even after setting the size of 10x12 inches at "Document Properties" dialog box of Printer Driver. To make print data in platen size of 10x12 inches, set Width : 254 mm (10 inch), Height : 304.8 mm (12 inch).
- If the print data file is not saved from the printer driver menu but application menu, the extension of the print data is automatically ".prm" although you added ".arp". Before you use GT File Viewer to print, change the extension to ".arp" manually.
- There are some cases reported in CorelDRAW 11/12 that outline Colors of curved texts (often by Envelop Effects) are not fully printed. In those cases, convert the text object into Bitmap before you print or check "Rasterize entire page (DPI)" checkbox in [Misc] tag of [Print] menu. The default DPI is 400, but 200-300 dpi will be enough to save time.

4. Printing Directly from Applications

Change RGB=255 bitmap white to RGB=254:

RGB=255 (paper color) white is always transparent with no ink printed. When you print an image like photo, there may be RGB=255 white spots and they will be ink holes. Follow the steps below to change RGB=255 white to RGB=254 white.

- (1) Select [Effect (Image for CoreDRAW 12 or under)] > [Adjust] > [Replace Colors] menu. Set RGB=255 white to [Old color] and RGB=254 to [New color]. Set [Range] to [1] and click "OK".

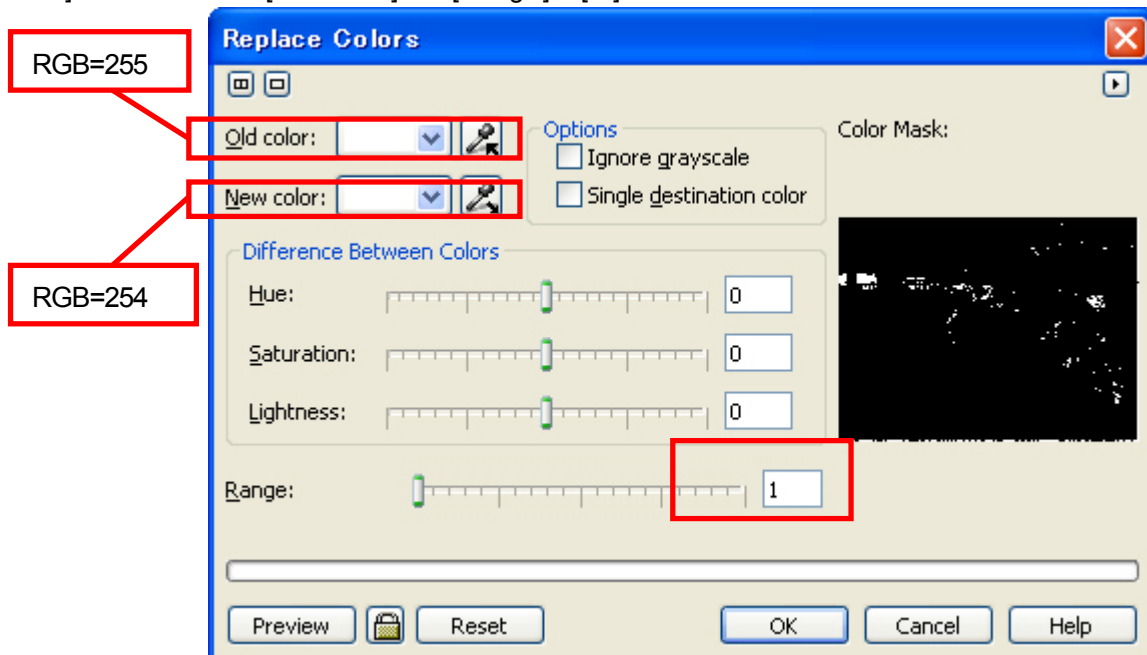

CoreDRAW X3

- (2) RGB=255 white are replaced to RGB=254 white.

<Note>

Vector objects should be filled with RGB=254.

4-2-3. Settings for Adobe Photoshop

Color settings:

- (1) Select [Edit] > [Color Settings] menu. The Color Settings window appears.
- (2) Make Color settings as follows, and then click "OK".

Advanced Mode: Check

Working Spaces: RGB: sRGB IEC61966-2.1

CMYK: U.S. Web Coated (SWOP) v2 / Europe ISO Coated FOGRA27

Conversion Options/ Intent: Relative Colorimetric

<Important!>

GT-782 is an RGB printer. Make the artwork in RGB mode because CMYK artwork is printed, colors e.g. black, yellow and purple turn vague and dull. Convert to RGB in sRGB IEC61966-2.1 profile Color space and improve the Color saturation: select [Image] > [Arrangements] to select the proper menu. Or use Color Processing in Printer Driver (see "4-3. Setting the Printer Driver Condition").

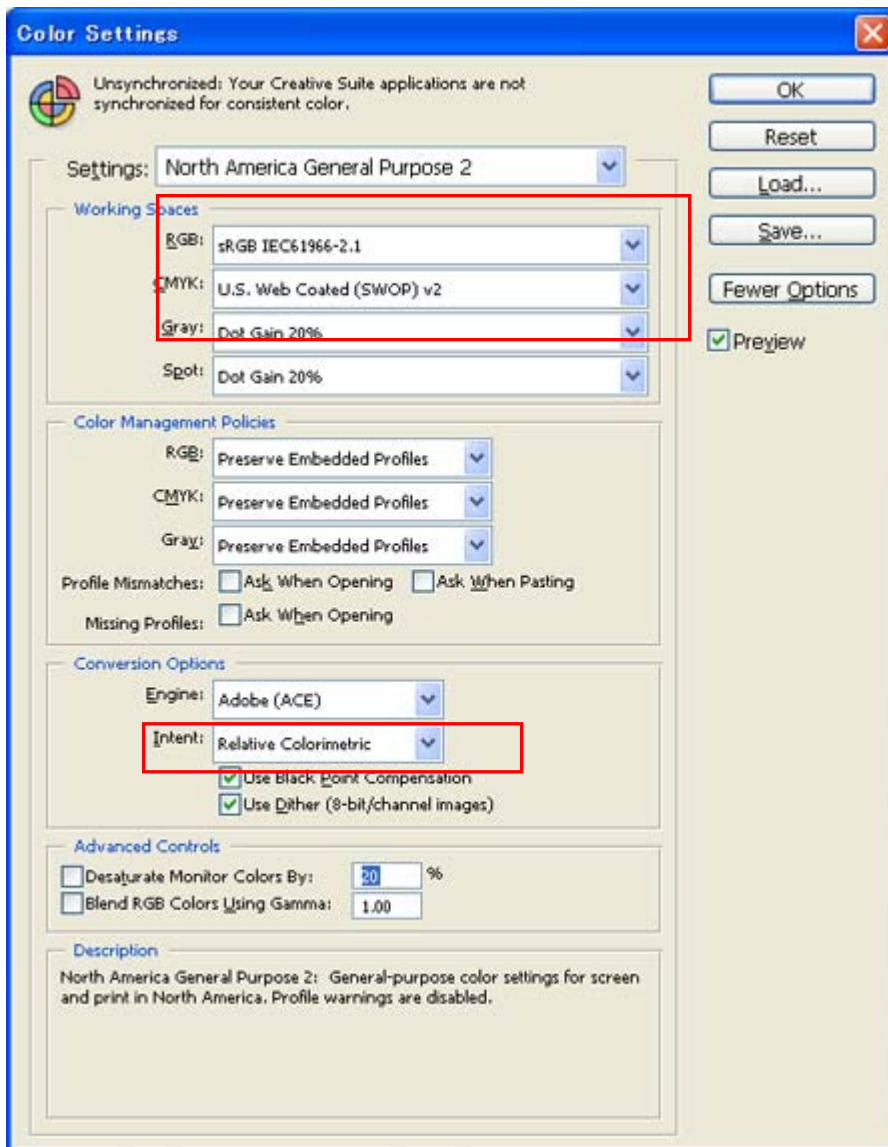

Photoshop CS2

4. Printing Directly from Applications

Print:

- (1) Select [File] > [Print with Preview Alt + Ctrl + P] menu (depends on versions).
When the default printer of the PC used is set "Brother GT-782", the layout is set in this window.
- (2) Settings are different from the versions.

Photoshop 6/7/CS:

Make print options as follows, go to "Page Setup..." to do Printer Driver settings, and then click "Print".

Show More Options: Check

Pull-down menu: Color Management

Source Space/ Document: sRGB IEC61966-2.1 or Untagged RGB

Print Space/ Profile: Printer Color Management

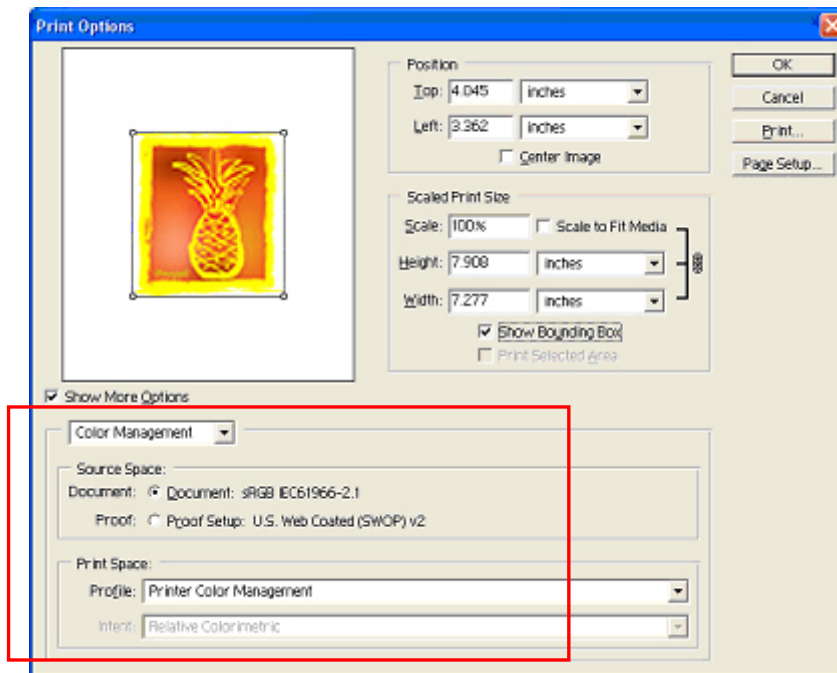

Photoshop CS

Photoshop CS2/CS3

Make print options as follows, go to "Page Setup..." to do Printer Driver settings, and then click "Print".

More Options: click

Pull-down menu: Color Management

Print: Document: Profile: sRGB IEC IEC61966-2.1 or untagged

Options: Color Handling: Let Printer Determine Colors

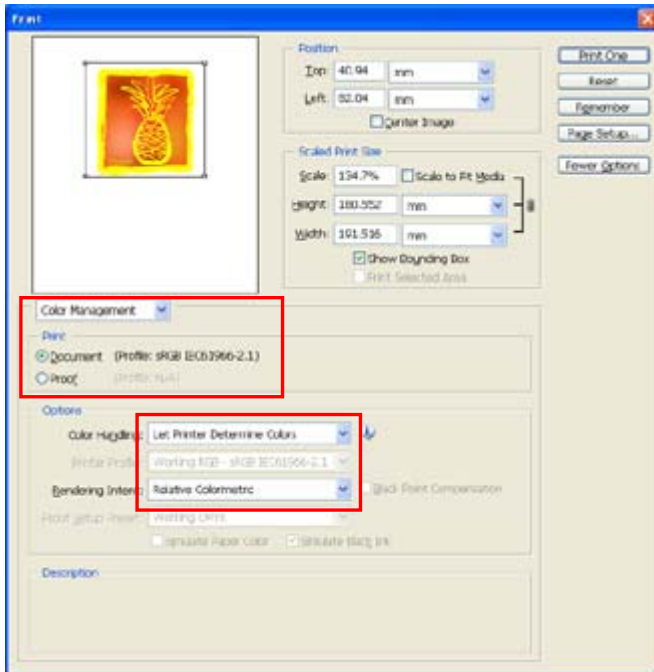

Photoshop CS2

(3) Go on to the Page Setup dialog and click "OK".

< Note >

- Do not check "Print to File" on Print window to make print files. Use GT-782 FileOutput Printer Driver.
- Photoshop CS2 and CS3 use lots of PC memories in executing and it may take more time to make print data compared with the former versions. Check your PC specifications.

4. Printing Directly from Applications

Color Swatch in Useful Tools:

- (1) See "3-3-5. Opening the Useful Tools" and download Photoshop Color Swatch (called palette in CoreIDRAW) GT_Colors_T.aco.
- (2) Select [Window] and check [Swatches] to show. Click the little triangle at the right top of the window (in the orange circle below) to show the submenu.



Photoshop CS2

- (3) Select [Replace Swatches...] and select file "GT_Colors_T.aco". The swatch replaced. Use them with the Color Chart "GT_ColorChart.arp". See "4-3-9. Printing Color Chart".

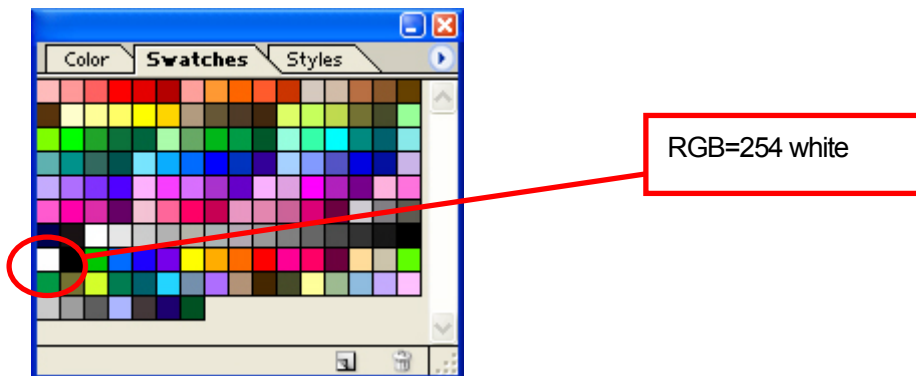

<Important!>

Do not use HKS, Pantone and other licensed palettes. Those spot Colors are treated "special" for screen-printing Color separation (remember you can print each Color by print menu). GT-782 Printer Driver cannot deal with these information in color matching.

Change RGB=255 bitmap white to RGB=254:

RGB=255 (paper color) white is always transparent with no ink printed. When you print an image like photo, there may be RGB=255 white spots and they will be ink holes. Normally you can select RGB=255 white directly with the menu in select and replace to RGB=254 white. If you can not select directly RGB=255 in the image, follow the steps below to change RGB=255 white to RGB=254 white.

- (1) Select [Layer] > [New Adjustment Layer] > [Selective Color ...] menu and make a new adjustment layer. Set [Opacity] as [20%] and click "OK".

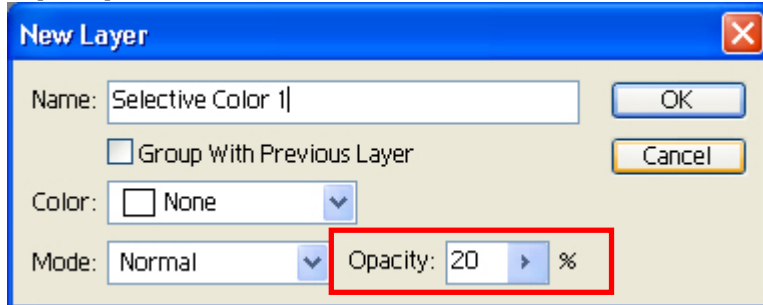

Photoshop 7

- (2) In Selective Color Options dialog, change [Colors] to [Whites], move [Black] slider to [1%], make [Method] to [Absolute] and then click "OK".

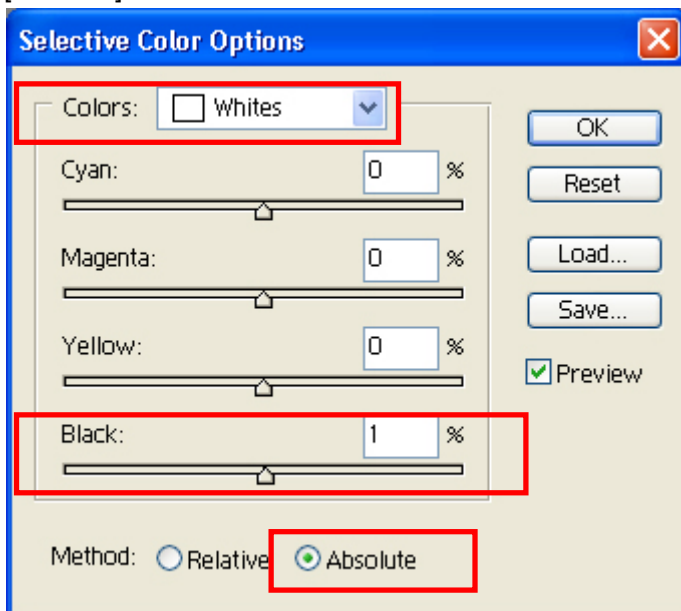

4. Printing Directly from Applications

4-2-4. Settings for Adobe Illustrator

<Important!>

- Set Brother GT-782 as the default printer before you go on to the following steps, otherwise, an image may be printed incorrectly.
- GT-782 is an RGB printer. Make the print data in RGB Color mode to get the best Color accuracy. In CMYK color mode artwork may be printed dark and unclear. Transforming it to RGB ("Document Color Mode" on "File" menu) may improve the result, but black, yellow, and purple cannot be printed accurately. We recommend you edit the artwork or use Color Processing (see "4-3. Setting the Printer Driver Condition").

Color settings:

- (1) Select [Edit] > [Color Settings] menu. The Color Settings window appears.
- (2) Make Color settings as follows, and then click "OK".

Advanced Mode: Check

Working Spaces: RGB: sRGB IEC61966-2.1

CMYK: U.S. Web Coated (SWOP) v2 / Europe ISO Coated FOGRA27

Conversion Options/ Intent: Relative Colorimetric

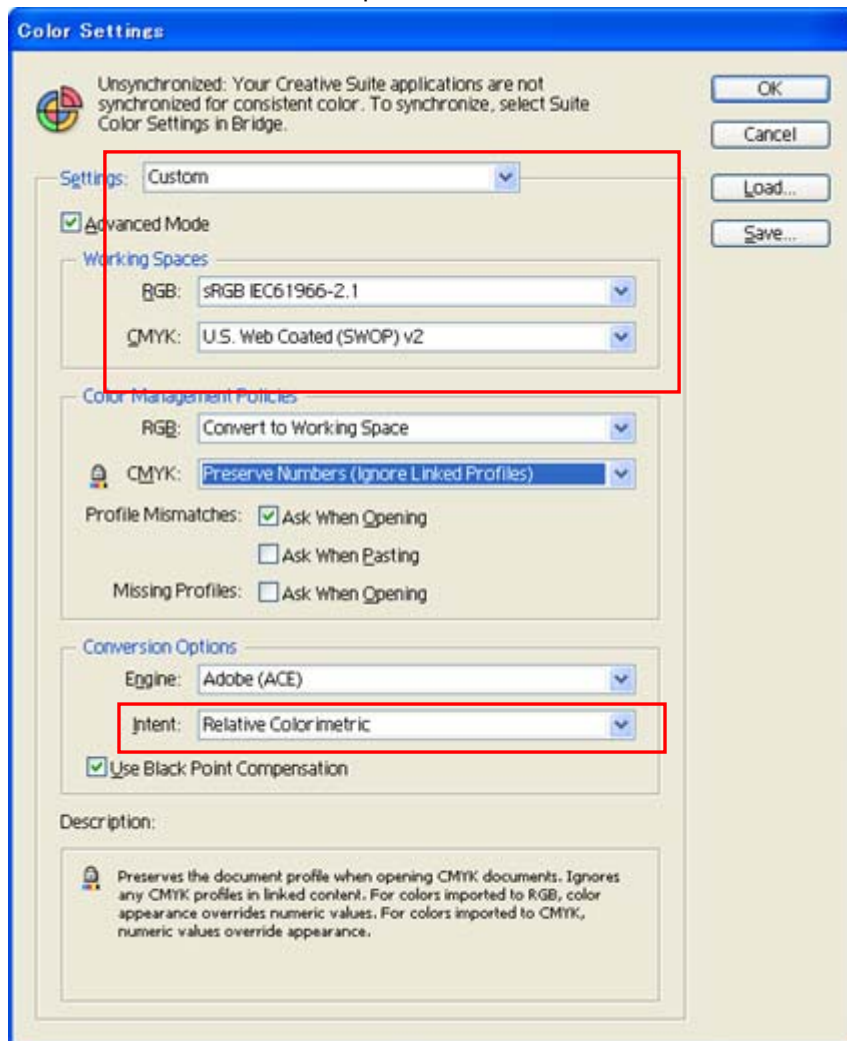

Illustrator CS2

Opening the new file:

Set the New Document settings as follows:

- Width: 14 in (355.6 mm)
- Height: 16 in (406.4 mm)
- Orientation: Portrait
- Color Mode: RGB Color

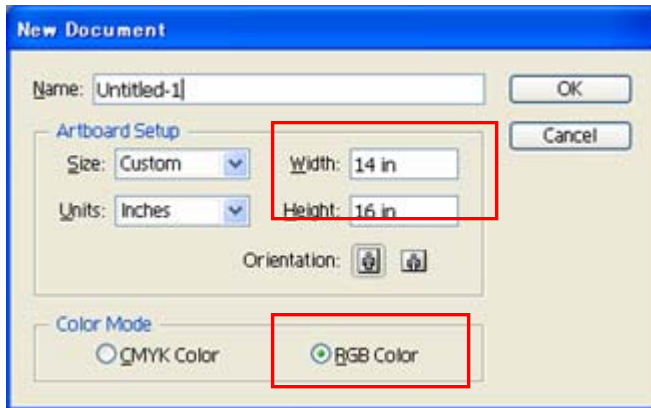

Illustrator CS2

Printing:

- (1) Click [File] > [Print] menu.
- (2) **Illustrator 10/CS:** Make sure the following settings.

Source Space is either "sRGB IEC61966-2.1" or "Untagged RGB".
 Print Space/ Profile: Same As Source

Click "Properties" (Illustrator 10) or "Setup" (Illustrator CS) to do Printer Driver Settings.

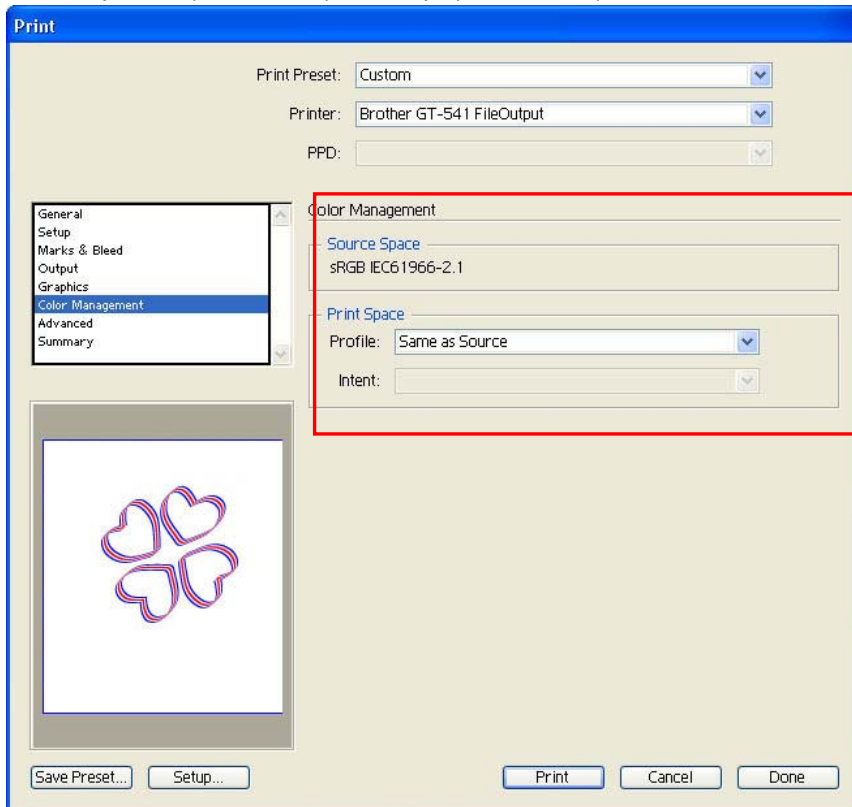

Illustrator CS

4. Printing Directly from Applications

Illustrator CS2/CS3: Make sure the following settings.

Document Profile and Printer Profile are either "sRGB IEC61966-2.1" or "Untagged RGB".

Color Handling: Let Illustrator determine Colors

Click "Setup" to do Printer Driver Settings.

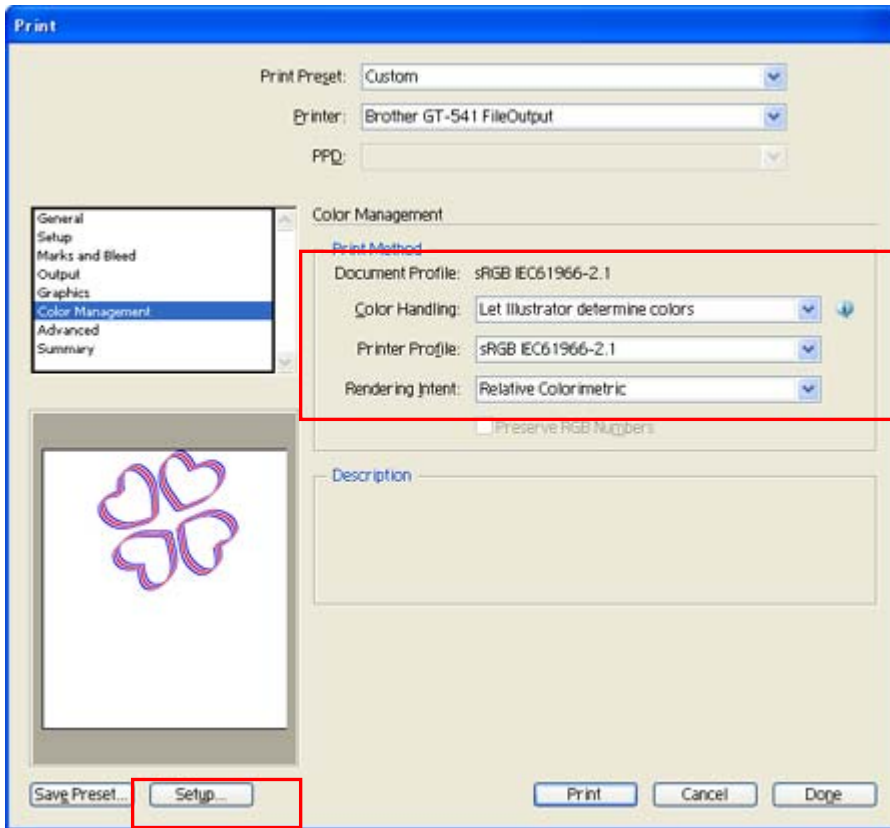

Illustrator CS2

Color Swatch in Useful Tools:

- (1) See "3-3-5. Opening the Useful Tools" and download Illustrator Color swatch "GT_Colors_T.ai".
- (2) Select [Window] and check [Swatches] to show. Click the little triangle at the right top of the window (in the orange circle below) to show the submenu. Select [Open Swatch Library] and [Other Library ...] at the bottom.

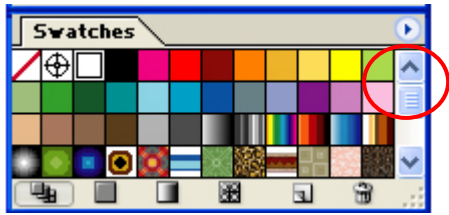

Illustrator CS

- (3) Select "GT_Colors_T.ai".
The swatch replaced. Use them with the Color Chart "GT_ColorChart.arp". See "4-3-9. Printing Color Chart".

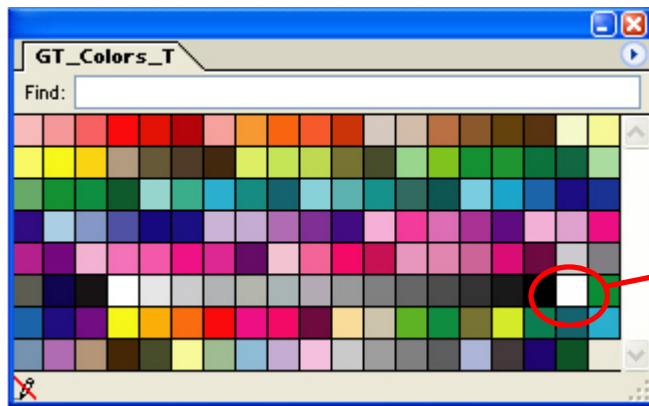

RGB=254 white

<Important!>

- In Illustrator 10, if "Use Print Setup" is selected as the Artboard and "Single Full Page" is selected as the View in "Document Setup" window, proper print image will not be sent to your printer. If you want to use "Use Print Setup", apply "Tile Full Pages" or "Tile Imageable Areas" as the View, and then select "Use Print Setup".
- The tile print is not available; only the last-received image will be printed.
- When printing a small image (especially an image smaller than 14 x 16 inches), the Platen Size may be set to Platen 10 x 12 automatically. Confirm the Platen Size in the Printer Driver window before you print.
- Do not check "Print to File" on Print window to make print files.

(Continued on the next page)

4. Printing Directly from Applications

- **An image that is smaller than 14 x 16 inches (e.g. a letter-size image) may not be printed on proper positions, or may result in errors. If this happens follow the steps below to correct.**
 - (1) Open "Document Setup" on "File" menu.
 - (2) Select "Artboard".
 - (3) Check "Use Print Setup", and then click "Print Setup...".
The Print Setup window appears.
If "Platen 14x16" is selected for "Size", temporarily change it to "Platen 10x12", and then click "OK".
If "Platen 10x12" is selected for "Size", temporarily change it to "Platen 14x16", and then click "OK".
 - (4) Click "OK" on the Document Setup window.
 - (5) Open "Document Setup" in "File" menu again, and select "Artboard".
 - (6) Click "Print Setup..." to open the Print Setup window.
 - (7) Change "Size" back to the original setting, and then click "OK".
 - (8) Click "OK" on the Document Setup window.

- **Landscape images may not be printed properly. Check the preview on Print window, and if it is not correct, follow the procedure below to solve the problem.**
 - (1) Confirm the Media Size in Print window is "Defined by Driver (it is set as default; do not change it)".
 - (2) Change the Orientation to portrait.
To change the Platen Size, go on to the next step. If not, skip to step (6).
 - (3) Click "Setup...". Click "Continue" when the warning window appears.
 - (4) Another Print window appears. Click "Preferences".
 - (5) Change the Platen Size on Printer Driver window, and then click "OK".
 - (6) Confirm the preview on the original Print window, and then click "Print".

4-2-5. Settings for Adobe Photoshop Elements

Color settings and print settings are required before printing. After the printer driver is installed, set the Colors before editing the document.

Color settings:

- (1) Select "Color Settings..." on "Edit" menu.
The Color Settings window appears.
- (2) Select "Limited Color management", and then click "OK".

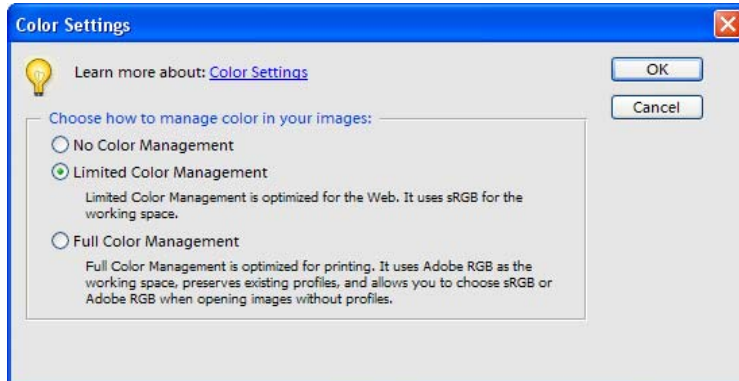

Photoshop Elements 3 (English Version)

Printing

Refer to Photoshop page in "4-2-3. Settings for Adobe Photoshop".

- (1) Select [File] > [Print...] menu.
The Print Preview window appears.
- (2) Do the settings as follows:
Show More Options: Check
Print Space/ Profile: Printer Color Management
- (3) Click "Properties" on Print dialog to do Printer Driver settings.

Color Palette (swatch) in install CD:

Color Palette GT_Colors_T.aco is available for Photoshop Element. See "4-2-3 Settings for Adobe Photoshop".

4. Printing Directly from Applications

4-2-6. Setting Paint Shop Pro Print Condition

Color settings:

- (1) Select [File] > [Preferences] menu.
- (2) Select "Color Management".
The Color Management window appears.
- (3) Uncheck "Enable Color Management", and then click "OK".

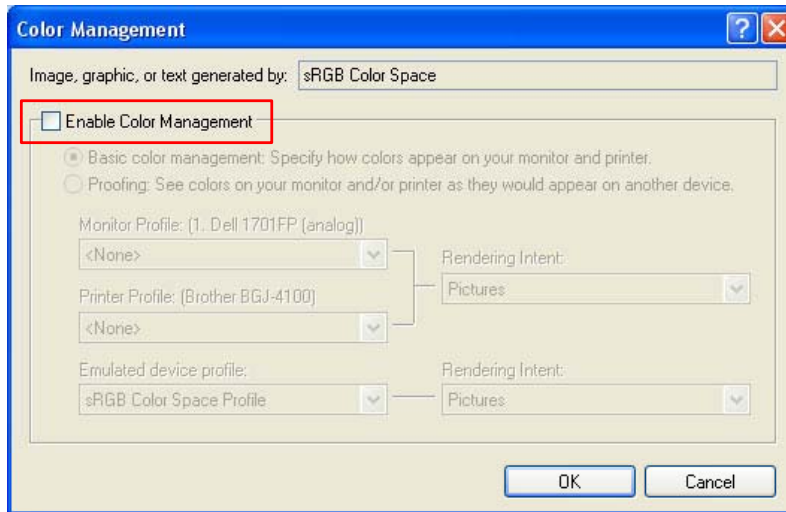

Paint Shop Pro 9 (English Version)

Printing:

Select [File] > [Print] menu. Click "Properties" to do Printer Driver Settings.

<Important!>

- **Leaving the Job Comment blank displays Windows files system name called "PSP PRINT" which indicates the application name on your printer's display. If you have entered the Job Comment, it will be displayed.**
- **Do not check "Print to File" on Print window to make print files.**

4-2-7. Printing From Other Applications

If the application does not have Color Settings, the Color space is sRGB (Windows standard). Just select [File] > [Print] menu to print.

<Important!>

Fit Paper size / Page size to the Platen size you are going to use.

4-3. Setting the Printer Driver Condition

<Important!>

RGB-255 (paper color) is transparent with no ink printed. When there are some spots in RGB=255 color in a photo, e.g. those spots will never be printed. Set RGB=254 white for white image. As for the operations for each application, see "4-2. Setting the Applications' Print Condition" or application help.

Set the printer driver condition following the procedure below.

- (1) Select [File] > [Print] menu of the graphic application.
The Print window appears.
- (2) Select "Brother GT-782" for the printer, and then click "Properties ...".
The following window appears: make the necessary settings, and then click "OK".

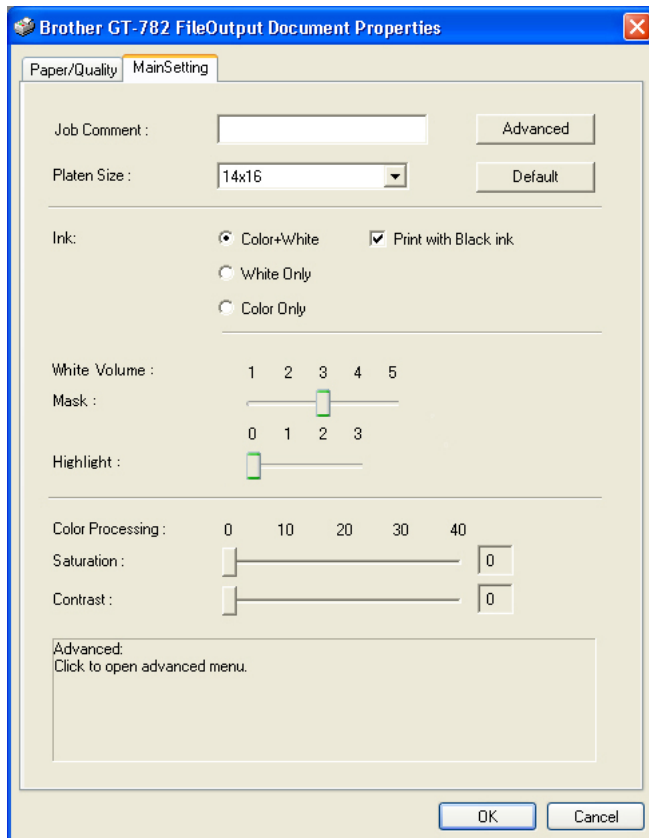

The following items can be set in this window.

"Rollover help" indicates in the bottom of the dialog. Move the pointer on the menu. The information can be seen with GT File Viewer when you use Brother GT-782 FileOutput Printer Driver to make ARP file. See the following pages for details.

4. Printing Directly from Applications

- (3) Click "Advanced " button and open the Advanced Menu. The upper menu is only for White ink and the middle menu is only for CMYK Color inks. Additionally you can make a print data as Uni-Directional printing. This settings is available only When GT-782 printer's [Print Direction] menu is [Auto]. If the setting is either [Always Bi-] or [Always Uni-], the setting of the printer is prior to the Printer Driver setting.

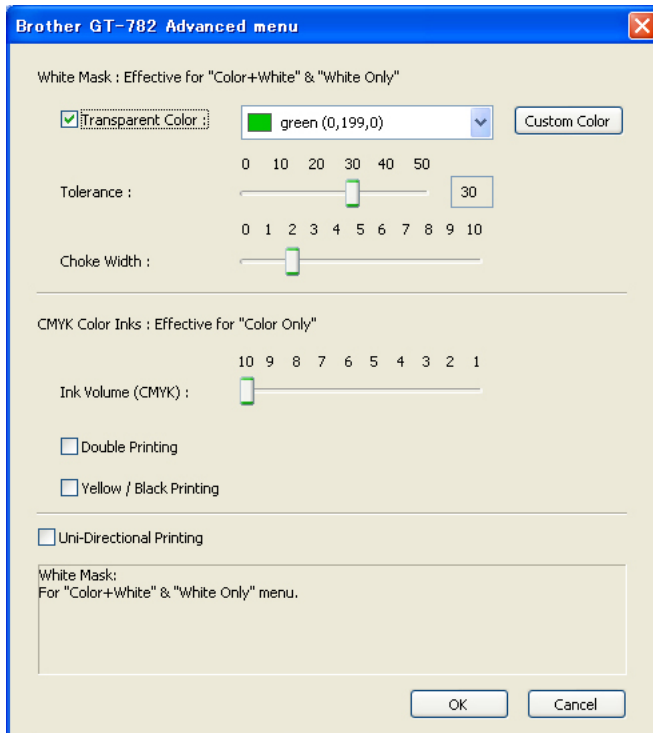

4-3-1. Entering the Job Comment

You can enter a comment (max 17 characters) to display on your printer's Control Panel. It is used to advise the operator.

4-3-2. Selecting the Platen Size

Select the appropriate Platen size from the pull-down menu. The Print Size: standard Platen (14x16): 355.6 mm x 406.4 mm
Baby Platen (7 x 8) : 177.8 mm x 203.2 mm, option), Youth Platen (10 x 12): 254 mm x 304.8 mm, XL Platen (16x18) : 406.4 mm x 457.2 mm.

4-3-3. Setting the Ink

Select the combination of CMYK Color or White inks.

[Color + White] prints CMYK Color Inks on the mask White. Additional Highlight is available. [White Only] prints with no Color inks. A colorful image is printed as monochrome. [Color Only] is the same as GT-541, with no White ink but CMYK Color inks.

When you print on a black T-shirt, you can check OFF [Print with Black ink] not to use Black ink but express the black with the body color. In this case both RGB=255 and RGB=0 black are transparent.

4-3-4. Setting the White Volume

Adjust the amount of Mask / Highlight White ink.

Mask

[3] makes the smoothest gradation. When you print on a vivid and deep color T-shirt, adjust the mask to [4] or [5]. When you print on a light color T-shirt, select either [1] or [2] to make the mask thinner. When [Print with Black Ink] is OFF, select [3] for smooth and accurate colorization. If you make the print image more vivid and bright rather than accurate, select [4] or [5].

Highlight

Add more White ink by double printing to make white and highly-saturated colors (e.g. orange, yellow) brighter. It takes time but the print output will be improved.

<Note>

- When there is no highlighted colors in the image, even if you select Highlight and GT File Viewer shows the setting, the printer does not execute double printing. Confirm the Double Print Icon on the display of the Control Panel.
- Print "GT-WhiteVolume.arp" to find out the necessary mask/highlight. It is in [All Program] > [Brother GT-782 Tools] > [Test Data].

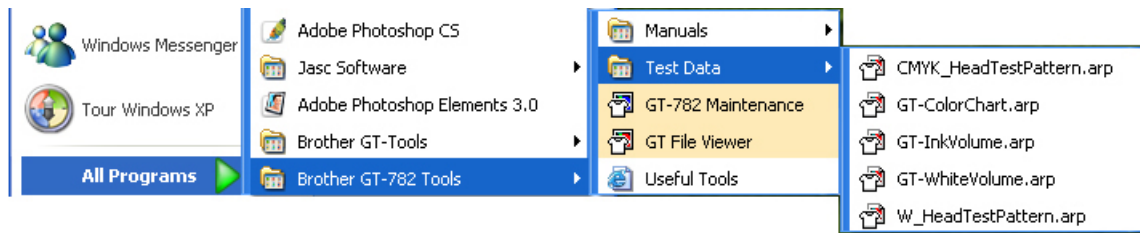

How to open the GT-WhiteVolume.arp

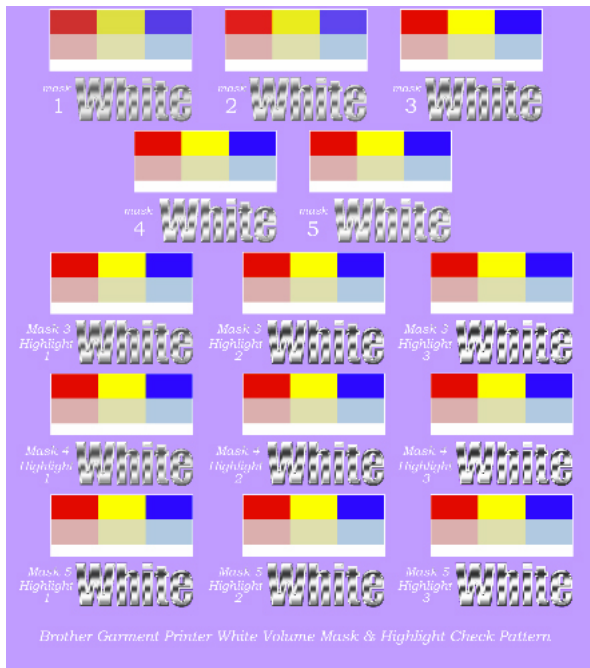

Image of print on Lavender T-shirt (R=174, G=111, B=255)

4. Printing Directly from Applications

4-3-5. Selecting the Color Processing for increasing the Vividness

This menu is an advanced Vivid Processing of GT-541. You can arrange the saturation (the strength of the colors) and the contrast separately. GT-541 Vivid Processing is equal to GT-782 Contrast and you can adjust more precisely by 0-40. Vivid Processing 1 is identical to Contrast 10. When the image data is well-contrasted, adjust mainly with Saturation. When the image data is plain and dull, adjust mainly with Contrast.

	[0]	no additional processing
around	[10]	no change in tone, a little brighter, good for photos
around	[20]	more vivid, for dull photo or RGB images
around	[30]	for light CMYK images
	[40]	maximum adjustment, for dull and plain CMYK images

The bigger value, more adjustment. When the image data is in CMYK mode, change the RGB mode and print with both Saturation and Contrast around [30]. Better to do test print in advance because sometimes the print data is unexpectedly changed.

4-3-6. Selecting the White Mask for White ink only

This menu is available only for White ink ([Color + White] and [White Only]). RGB=255 white (paper color) is always transparent with no ink printed. RGB=0 black is transparent too when [Print with Black ink] is checked OFF, when black color is expressed with the background T-shirt body color.

Transparent Color

You can select one transparent RGB color so that you can use red T-shirt color in the print data by changing R=255 GB=0 red as transparent.

- (1) Check [Transparent Color] checkbox then the pull-down menu in the right will be available.
- (2) Select one color from the pull-down menu (T-shirt simulation colors) or click [Custom Color] button and input RGB values.

<Note>

Only one Custom Color is available at a time. This RGB values will not be added to the list.

Tolerance

Select the range from the transparent color to the normally-masked color. The gradation range becomes wider when the value is bigger.

<Note>

Smooth gradation depends on the original image data. Better to do test print in advance.

Choke Width

Sometimes the mask White ink can be shown, which depends on the thickness of the T-shirt, humidity of the room, etc. You can choke (cut out) the outline by one dot (1/600 dpi). Select the value.

<Note>

If the value is bigger, some thin lines (in the letters, photos, etc) might disappear. Better to do test print in advance.

4-3-7. CMYK Color Inks for Color ink only

This menu is available only for [Color Only]. It is the same menu in GT-541.

Ink Volume (CMYK)

To get the best print result, you may need to adjust the amount of ink depending on the fabric of the T-shirt to prevent blurring. Print "GT_InkVolume.arp" first and select the best ink volume by sliding the Ink Volume tab. It is in [All Program] > [Brother GT-782 Tools] > [Test Data].

Example 1 (50% cotton 50% polyester thin T-shirt)

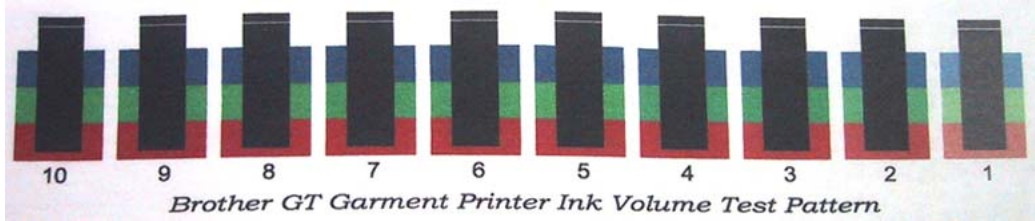

Example 2 (100% polyester synthetic leather fabric)

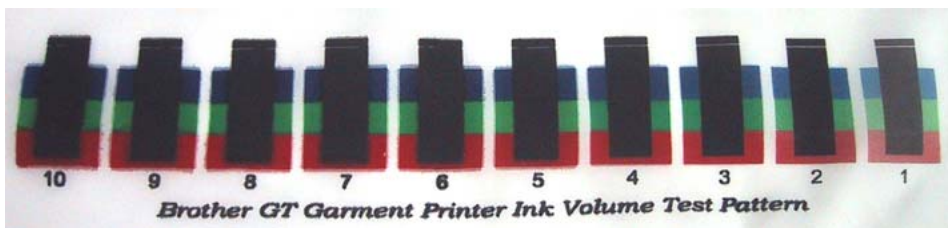

Double Printing

Check the Double Printing to print an image clearer and sharper by widening the Color gamut. This is recommended especially for black and white images.

<Note>

When you are using this function, you cannot select the "Ink Volume" or "Yellow / Black Printing".

Yellow / Black Printing

Yellow/black printing can sometimes show the problem below.

Check the Yellow / Black Printing check box to solve the problem.

Checking the Yellow / Black Printing means the printer prints with yellow ink first, and then prints with other Colors, to optimize quality.



Yellow / Black Printing off



Yellow / Black Printing on

<Note>

When you are using this function, you cannot select the "Double Printing".

4. Printing Directly from Applications

4-3-8. Setting Print Direction as Uni-Directional

This settings is available only When GT-782 printer's [Print Direction] menu is [Auto]. You can set the Print Direction when you make print data so that mis-print may be decreased in print operation.

<Note>

If the printer's setting is [Always Bi-], the printer does bi-directional print even if the Printer Driver sets in Uni-Directional printing. The printer's setting is prior to the Printer Driver's.

4-3-9. Printing Color Chart

For your information, GT-782 Color Chart "GT_ColorChart.apr" is available to understand Color gamut. Print the T-shirt and Color Chart will work something like Pantone's Color Formula Guide. It is in [All Program] > [Brother GT-782 Tools] > [Test Data].

The colors in this chart corresponds to the Color Palettes (Swatches) for CorelDRAW, Adobe Photoshop and Illustrator. See "3-3-5. Opening the Useful Tools".

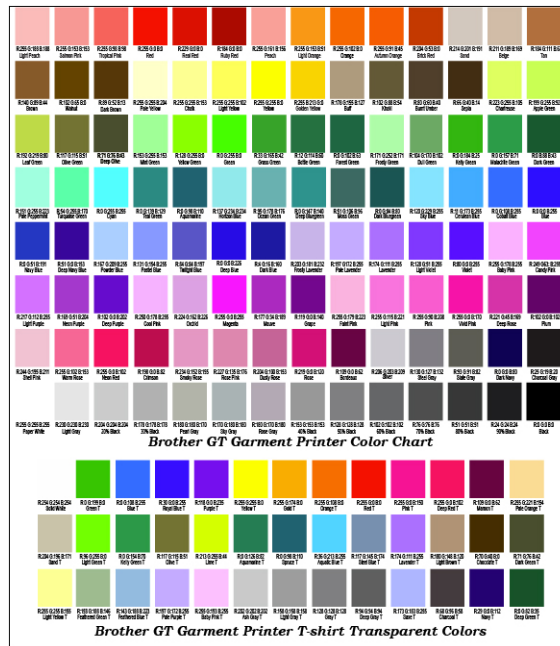

<Note>

The image data (PDF) is in Useful Tools. Print the image data when you want to know how the Printer Driver changes the colors with the settings. See "3-3-5. Opening the Useful Tools".

4-4. Uninstalling / Installing the Platen

Replace the Platen for your print material. When the option Platen e.g. Youth Platen is used, be sure to set "Platen Size" in Printer Driver menu (see "4-3-2. Selecting the Platen Size").

4-4-1. Uninstalling the Platen

- (1) Press the Platen Button to eject the Platen.
- (2) Loosen the Platen Fixing Lever underneath the Platen.

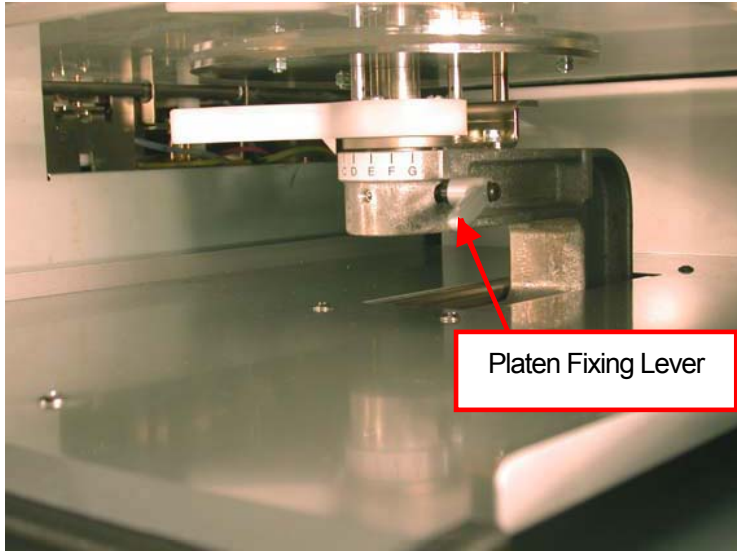

- (3) Uninstall the Platen by lifting it up straight.

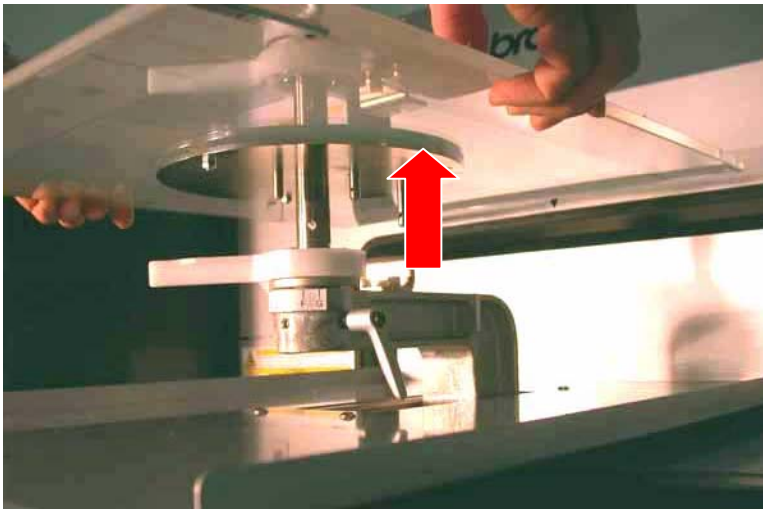

4. Printing Directly from Applications

4-4-2. Installing the Platen

- (1) Place the Platen.

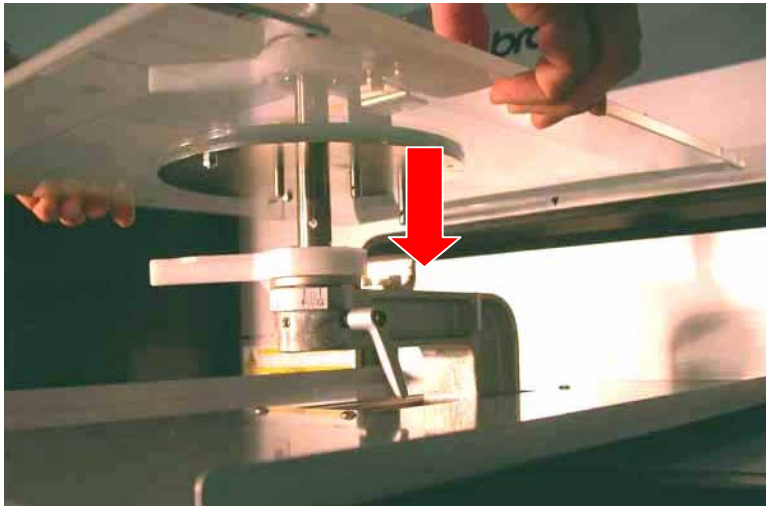

- (2) Tighten the Platen Fixing Lever securely.

<Note>

Adjust the Platen Height (see "4-5. Placing the T-shirt on the Platen").

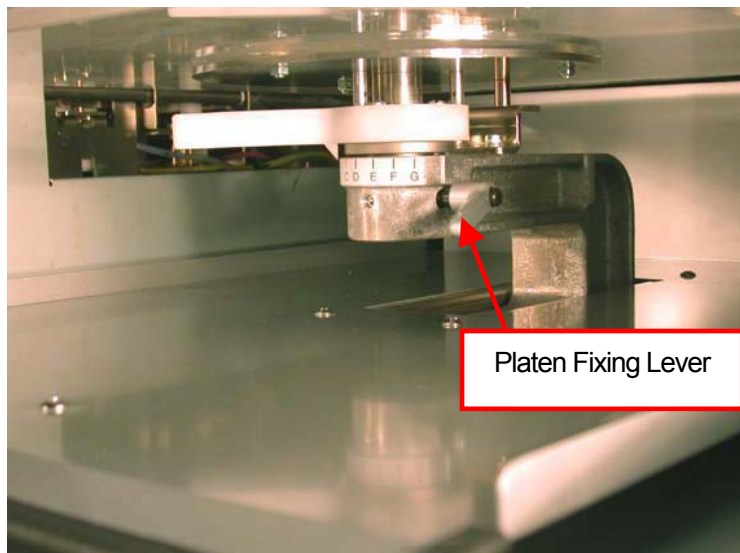

4-4-3. Lowering the Platen height

By replacing to the GT-541's parts the Platen height can be lower by 10 mm (12 - 22 mm from the surface of the Print Heads). Prepare a screw driver and hexagon wrench.

- (1) Loosen the Platen Fixing Lever and uninstall the Platen by lifting it up straight.
- (2) Remove the three screws that fix the Platen Height Adjustment Lever, and remove the two nuts that fix the Platen Positioning Plate.

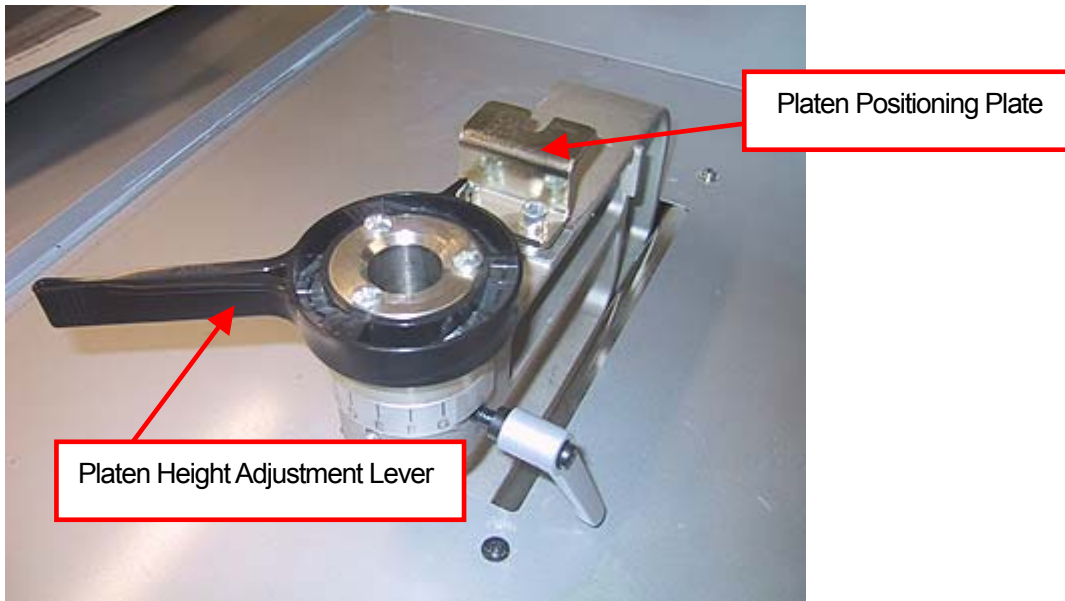

- (3) Replace the Bush Platen Shaft which is under the Height Adjusting Lever and Platen Positioning Plate to the GT-541's parts.
- (4) Install the Platen as it is and fix it. Insert the Platen Fixing Lever into the lower hole and tighten it. The upper hole is for GT-782.

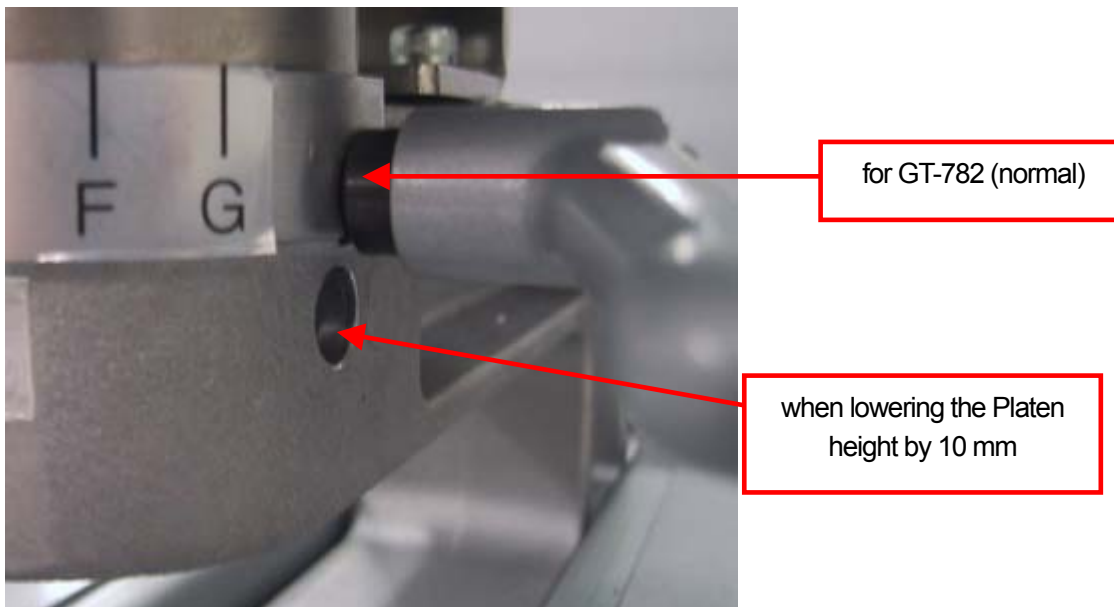

4. Printing Directly from Applications

4-5. Placing the T-shirt on the Platen

CAUTION



Ensure there is adequate space left for safe working. The Platen moves forward while operating.



Do not handle the platen while printing. If your hand gets caught between the platen or the T-shirt tray and the covers, it may be injured.



Do not move the Platen by hand.
The Printer may be seriously damaged by this.

To get the optimum quality print result, you need to adjust the Platen height depending on the thickness of the T-shirt.

<Note>

- If Platen height is too low, the result may be poor quality (e.g. a straight line becomes double). Adjust it properly by test moving the platen in with Platen Button on the Control Panel. When you have to lower the Platen to avoid any material which is thicker i.e. hems the hems, use Uni-Directional print (see "7-2-4. Changing the Print Direction"). You can set a print data as Uni-Directional by the Printer Driver. See "4-3-8. Setting Print Direction as Uni-Directional".
- By replacing to the GT-541's parts the Platen height can be lower by 10 mm (12 - 22 mm from the surface of the Print Heads). Replace the Bush Platen Shaft and Platen Positioning Plate to the GT-541's parts. See "4-4-3. Lowering the Platen height".

- (1) If the Platen is not ejected, press the Platen Button to eject it.
- (2) Gently turn the Platen Height Adjustment Lever to the left until it stops. Turn the Platen Height Adjustment Lever to the "A" position (leftmost), where is best for normal T-shirts. Set it to the "C" position when you print on a sweater or a towel. If the Platen height is too low, the print quality turns worse.

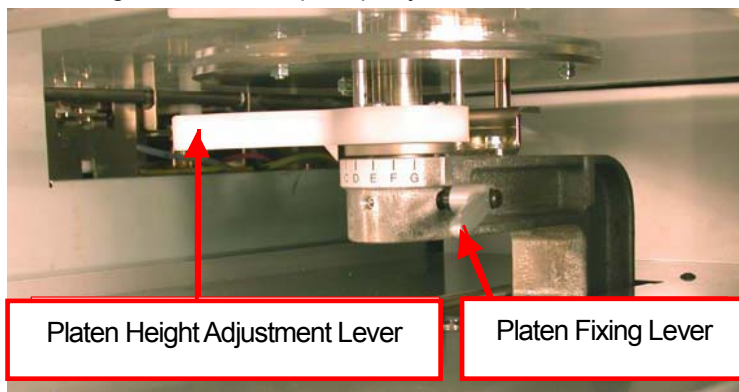

<Note> Do not use force.

- (3) Tighten the Platen Fixing Lever securely.

- (4) Place the T-shirt, with its print side on the top of Platen and the other side underneath the Platen, as shown below. The Pretreatment must be applied first when you print on dark-colored T-shirts with White ink. (See "4-6-1. Applying the Pretreatment".)



<Note>

- Pay attention to the hems; neck, arm holes, tags, and the bottom. The side edges may raise and hit the Print Head during printing operation. It is important to ensure the t shirt surface is flat and smooth.
- To align a T-shirt easily, you can print a grid on the Platen Sheet. It is in [All Program] > [Brother GT-782 Tools] > [Useful Tools]. Grid14x16.arj is for the standard Platen 14x16. (See "3-3-5. Opening the Useful Tools".)

- (5) Smooth the surface to remove wrinkles and threads with your hands. It is easier to smooth from the center of the shirt outwards.

<Note>

- If the surface of T-shirt is not smooth enough, the Obstruction Sensor may be activated
- When placing a thick fabric such as a sweatshirt, keep its surface as flat as possible.

- (6) Keep the sleeves and overflows on the T-shirt Tray to avoid jamming.



4. Printing Directly from Applications

- (7) Press the Platen Button to insert the Platen, and check the gap between the Obstruction Sensor and the T-shirt. If the Platen height is appropriate, the space is around 2.0 mm.

<Note>

- *Make sure you check the space when the Platen is moving, so that the Obstruction Sensor works properly. While the platen stops, it is in upper position.*
- *When the surface/back of the Obstruction Sensor is dirty, it may damage the printing material when loading. Wipe off the dirt with a soft wet cloth with water. (See "6-1-2. Replacing the Wiper Cleaner")*
- *If the Platen height is too high, the T-shirt, Print Head, or both of them may be damaged when printing.*

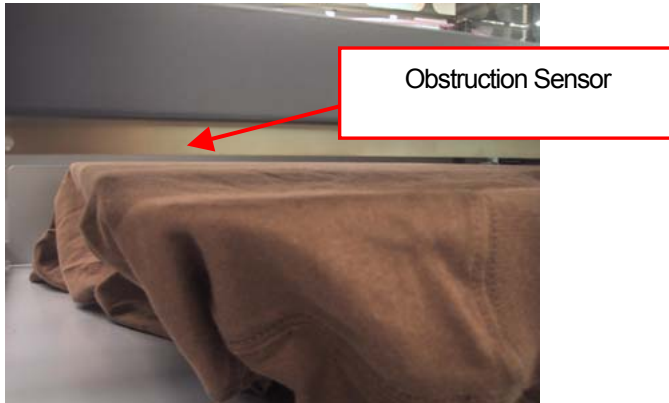

- (8) Press the Platen Button to eject the Platen. Adjust the height by repeating the following steps (9)-(12). If the Platen height is appropriate, you can go to "4-6. Printing" to start printing.
If not, go on to the following steps.
- (9) Loosen the Platen Fixing Lever.
- (10) Adjust the Platen height by turning the Platen Height Adjustment Lever. The alphabets are the guide scales.
- (11) Tighten the Platen Fixing Lever securely.
- (12) Repeat steps (9) and (10) and check the Platen height.
Repeat steps (11) to (14) until the Plate height becomes appropriate.

4-6. Printing

CAUTION



Ensure there is adequate space left for safe working. The Platen moves forward while operating.



Do not handle the platen while printing. If your hand gets caught between the platen or the T-shirt tray and the covers, injury may result.



Do not move the Platen by hand.
The Printer may be mechanically and electrically damaged.



Do not put your hands inside the covers while the printer's power is turned on, otherwise your hands may touch against moving parts and this may result in injury.



Take care not to let the ink, Wash Liquid, Maintenance solution, Pretreatment or waste liquid come into contact with your eyes or onto your skin, otherwise inflammation can result. In case of contact with eyes, do not rub but immediately rinse the eyes with water.

Furthermore, do not drink the ink, Wash Liquid, Maintenance Solution, Pretreatment or waste liquid under any circumstances, as they can cause vomiting and diarrhea.

Keep the ink, waste liquid and wash liquid out of the reach of children.

4-6-1. Applying the Pretreatment

Pretreatment must be applied on a T-shirts to keep the White ink on the surface of a T-shirt. Wear gloves to keep Pretreatment from the skin.

<Note>

- Use a heat press to cure the Pretreatment. The surface must be as flat as possible in curing. If you use an oven, the fibers may not lay down flat causing low print quality.
- Water drops on the Pretreatment-cured surface turn stains. Do not wet the cured surface. Do not leave a Pretreatment-cured T-shirt in a humid space.
- Be aware of the temperature of the heat press in curing the Pretreatment. Temperature easily drops by continual curing. If the temperature is low, the Pretreatment can not make ink barrier on the surface of the T-shirt and the White ink may easily sink into the fibers and can not produce enough white.
- Better to use an Urethane mat (continuous foam) to release more steam while curing.
- If CMYK inks are printed on a Pre-treatment applied T-shirt, ink may washed off. Do not apply Pretreatment when you print without using White ink.
- Pretreatment on some T-shirts may be seen easier after applied and cured. Wash lightly with water. Some dyes may be decolorized by Pretreatment, we recommend you test the garment before printing.

- (1) Put the Pretreatment into the spray. Use an spray which can produce fine mists.
- (2) Put a T-shirt flat and apply by spraying the Pretreatment. Insert some plate so that the Pretreatment will not go into the back side. The amount of Pretreatment should be 15 g by 25 x 30 cm (either Letter or A4 size), about 36 g (the surface is wet enough) by maximum 40 x 45 cm (Platen XL).

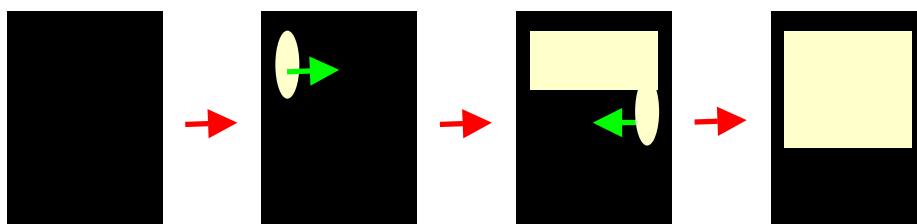

How to spray the Pretreatment

(Continued on the next page)

4. Printing Directly from Applications

- (3) Roll a roller on the surface so that the Pretreatment can sink equally.
- (4) Put the T-shirt on the heat press. Keep the surface flat without wrinkles. Use a separator sheet and press with high pressure. Curing condition is the same as ink: 180°C (356°F) in 35 seconds.
- (5) Remove the T-shirt from the heat press and cool.

4-6-2. Making One Print

GT-782 receives the next print data from PC in printing. The print data is replaced after the print is finished. (This means when a print data has both Color and White data, the white print data starts being replaced after the White Print Heads finish printing.) If you press the Print Button under this situation then it seems that different print data seems to be printed at the same time. When you press the Print Button, confirm the Job Comment (or file name) and the counter on the display of the Control Panel.

- (1) Make sure the Print Button has been turned on, which indicates your printer has received the print data successfully.
- (2) Make sure that the Platen is ejected. If not, press the Platen Button.
- (3) Confirm the Job Comment on the Display shows the correct print job details. Check the counter whether it is 000 (new) or not (previous).
- (4) Press the Print Button to start printing operation
When the printing is completed, the Platen is ejected and an audible indication is given.
If printing is to be stopped before it is finished the Stop button can be used.

<Note>

- *By pressing the Print Button, your printer automatically starts cleaning the Print Head every 24 prints (default) or every numbers of prints you have set (see "7-2-5. Changing the Auto Head Cleaning Setting"), or after your printer has not been used for more than two hours. In this case, wait until the cleaning completes (takes about 20 seconds), and then printing will automatically start.*
- *Keep away from the moving platen.*
- *If the Platen is not at the appropriate position when the Print Button is pressed, it automatically adjusts the position to start printing. Press the Print Button again to start printing after the Platen is available*
- *Do not open unlock or open the Cover during printing. If you do the power is turned off for safety reasons.*

4-6-3. Printing More than One Print Using the Same Print Data

After making one print following the procedure in "4-6-2. Making One Print", you can continue making more prints using the same print data.

- (1) Confirm the Platen height and the Print Direction.
- (2) Press the Print Button of the other side of the Platen to start printing. The counter indicates how many images are printed by both Platens.

<Note>

- *The counter indicates the total prints of one print data with both Platens.*
- *You can press the Print Button in advance while the other Platen is printing. In this case the print starts after the Print Heads finish printing the data.*

4-7. Removing the T-shirt from the Platen

- (1) Hold the shirt slightly to allow air to get between the shirt and the platen.
- (2) Hold both shoulders of the T-shirt, and then pull it out straight from the Platen.

<Note>

Be careful not to get "wet" ink on your hands or printed material. Wash your hands or clothes with soap if stained.

4-8. Curing the Ink onto the T-shirt

To cure (fix) the ink onto the T-shirt, a heat press is convenient in time and temperature control. When you print with White ink, use separate paper. Also an oven is more recommended for washability (but it takes 5 minutes).

Follow the instruction manual that comes with your Heat Press.

<Note>

- *An appropriate heat treatment with a heat press requires 180 °C (356 °F) of heat for 35 seconds, with an oven requires 160°C (320 °F) for 5 minutes.*
- *The fixing is important and if not done correctly the image may fade or have other symptoms.*
- *The heat press and the oven should be used in a well ventilated environment. When curing the White ink, better to use an oven with much ink on the surface. The surface of an T-shirt by an oven feels more natural and by an heat press more flat and glittering.*
- *After using the Heat Press, always confirm if the ink is completely dry and cured.*
- *Make sure the surface of the Heat Press or the separate sheet is clean before and after fixing the t shirt.*
- *Depending on the material, curing conduction may vary, be sure to test new materials before you use. Pretreated garment is easier to be burnt than the normal garment.*
- *Printed colors may transfer when a printed surface rubs on a white or light-colored synthetic leather made of PVC (polyvinyl chloride). When printing CMYK-only garments, the CMYK ink may transfer to the White-only printed garment when they rub against each other. In those cases, clean the stains with a soft cloth or toothbrush with a household cleaner or alcohol.*

5. Printing ARP Files

When saving a print data in ARP format file, you can select the printing procedure by either of these two methods

- Print an ARP file with GT File Viewer. You can check the detailed print conditions and ink cost before sending a print data to your printer.
- Save ARP files in a CompactFlash. You can print with Stand-alone printer without using PC.

The procedure of printing ARP files:

- (1) Use GT-782 FileOutput Printer Driver and save the print data in ARP file format.
See "5-1. Making Print Data in ARP File".
- (2) Send the ARP file to your printer using GT File Viewer or a CompactFlash.
See "5-2. Reading ARP Files Saved in a CompactFlash" or "5-3. Sending ARP Files from GT File Viewer to your Printer".
- (3) Place the T-shirt on the Platen, adjust the Platen height and then print.
See "4-5. Placing the T-shirt on the Platen", "4-6. Printing", "4-7. Removing the T-shirt from the Platen" and "4-8. Curing the Ink onto the T-shirt".

5-1. Making Print Data in ARP File

GT-782 can print the ARP file made by GT-541 Printer Driver. GT-541 can not print the one made by GT-782 Printer Driver.

<Note>

You cannot edit ARP files; we recommend you save the data in the original format as well.

- (1) Create the artwork using a graphic application. See "4-2. Setting the Applications' Print Condition" for proper settings.
- (2) Select "Print" on "File" menu of the application.
Print dialog box appears.
- (3) Select "Brother GT-782 FileOutput " Printer Driver and click "Properties" for Printer Driver settings. (See "4-3. Setting the Printer Driver Condition ".)

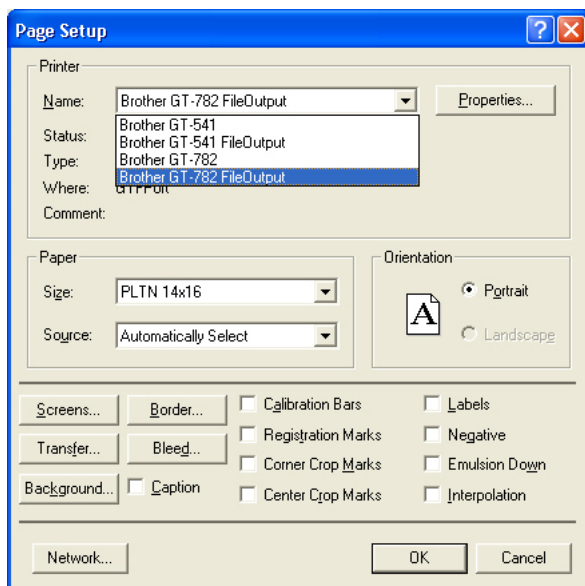

- (4) Print with the application's print menu. Wait for a while until the following preview window appears. Click [Save] button.

<Important!>

Depending on the application or the image, it may take a few minutes to open the Preview window after clicking "OK" or "Print". Do not click "Print" or "OK" again.

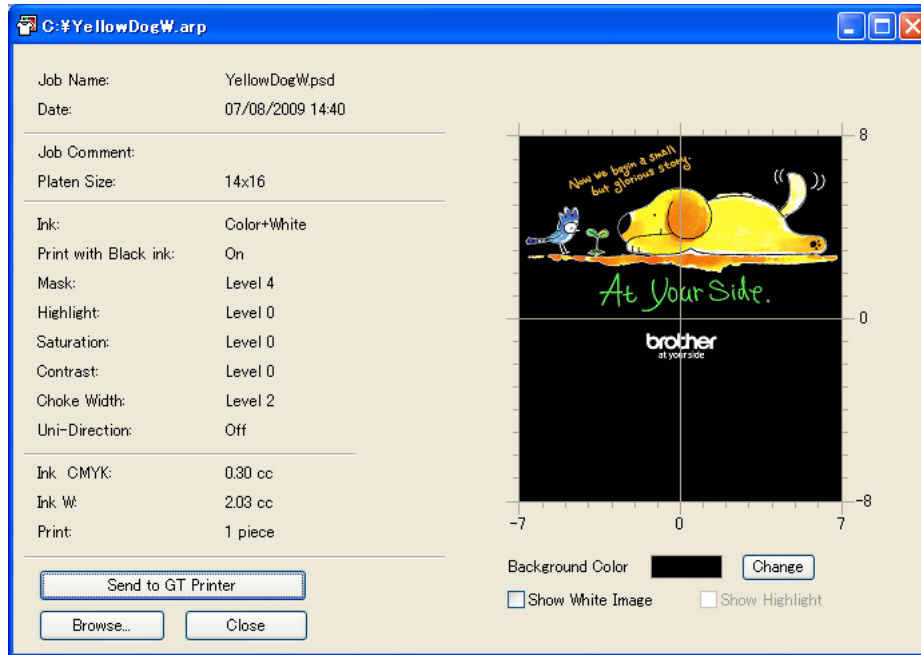

A print data example with White data

- (5) "Save As" dialog appears. Select where to save the data, enter the file name, select "GT Print File (*.arp)" as the file type, and then click "Save".

The ARP file is created and saved in the selected location.

<Note>

To read the file name of data saved in a CompactFlash and display it correctly on your printer's Display, the file name should be 8 characters (ASCII) or less.

5. Printing ARP Files

5-2. Reading ARP Files Saved in a CompactFlash

<Note>

- Use a CompactFlash that meets the requirements (see “1-3-4. Other Requirements”).
- Your printer can only read ARP files from a CompactFlash.
- The names of ARP files must be less than 8 characters (ASCII).

- (1) Open the CompactFlash Slot Cover and insert the CompactFlash, and then close the CompactFlash Slot Cover.

<Note> Do not insert the CompactFlash by force; it may destroy the data saved in it.

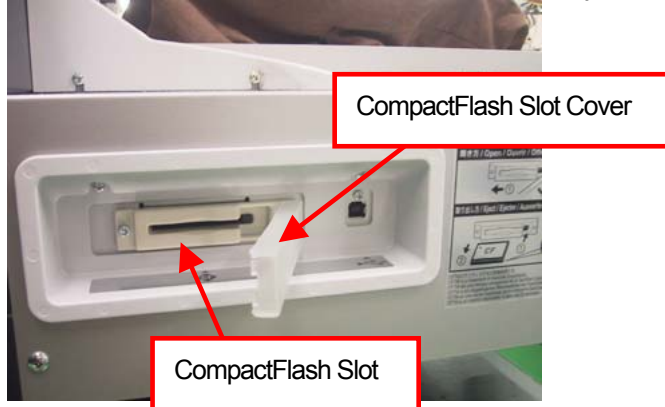

- (2) Press the OK Button of the left Control Panel and show the Menu.
- (3) Press the Up/Down Button to select “Card Data Load”, and then press the OK Button.
The file information (file names, Job Comments, Platen Sizes, etc.) of the data in the CompactFlash is displayed (one display per data) one by one. The folders in the CompactFlash indicates with [].
- (4) Press the Up/Down Button to select the file to be printed, and then press the OK Button.
Your printer starts reading the CompactFlash and the Print Button on your printer’s Control Panel starts flashing. When the ARP file finished reading, the printer bells and the Print Button turns on.

<Note>

If a file name of the data saved in a CompactFlash cannot read properly, see “7-1. Solving Printer Problems”.

Do not touch the CompactFlash while the Print Button is flashing; it may destroy the saved data.

Reading the CompactFlash may take more than two minutes depending on the stored data sizes.

- (5) Pull out the CompactFlash when you have finished printing the data, and then close the CompactFlash Slot Cover.

5-3. Sending ARP Files from GT File Viewer to your Printer

- (1) Double-click the ARP file directly or select the GT File Viewer in your PC's [All Program] > [Brother GT-782 Tools] and click [Browse...] to open the ARP file.
- (2) The file's print condition by the Printer Driver and the preview (layout) appear in the following window. If the White data is included ("Color + White" or "White Only"), the background indicates either black or "Transparent Color". If no White data is included, the background indicates white.

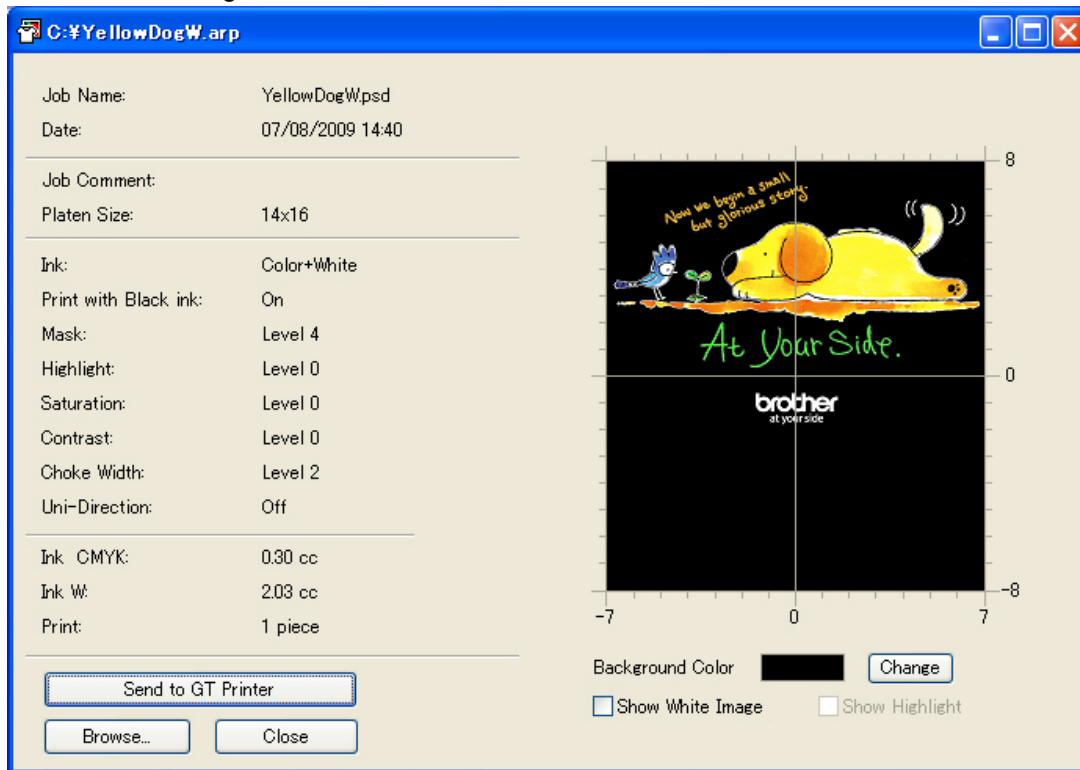

A print data example with White data

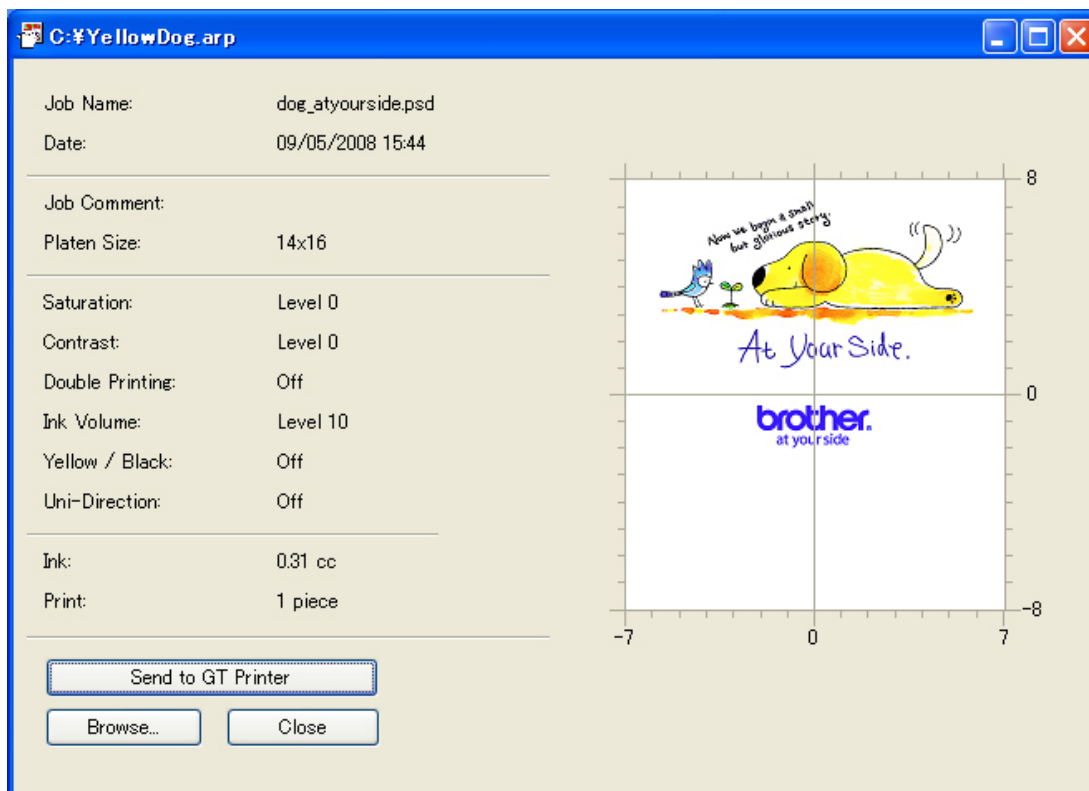

A print data example only with Color data

(Continued on the next page)

5. Printing ARP Files

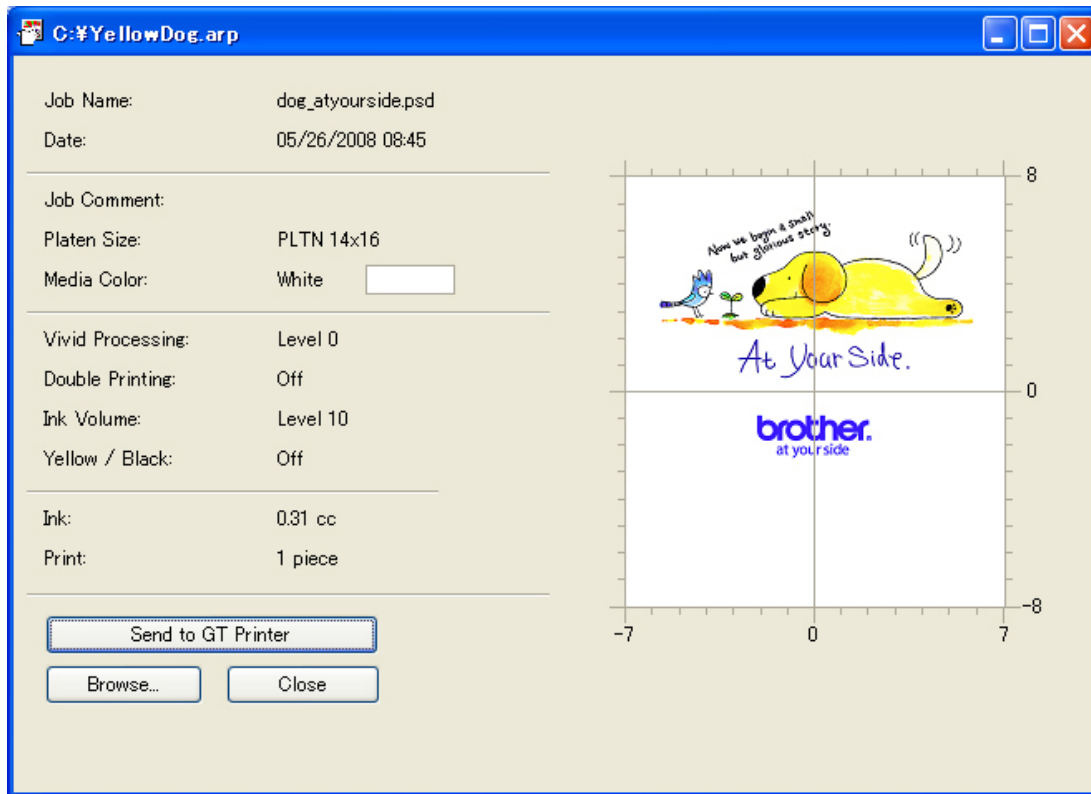

A print data example made by GT-541 Printer Driver

(Continued on the next page)

(3) When the White data is included, you can simulate the print by changing the background color. Click [Change] button and select the color. When [Show White Image] is checked, Mask White data is indicated. When [Show Highlight] is checked, only Highlight White data is indicated.

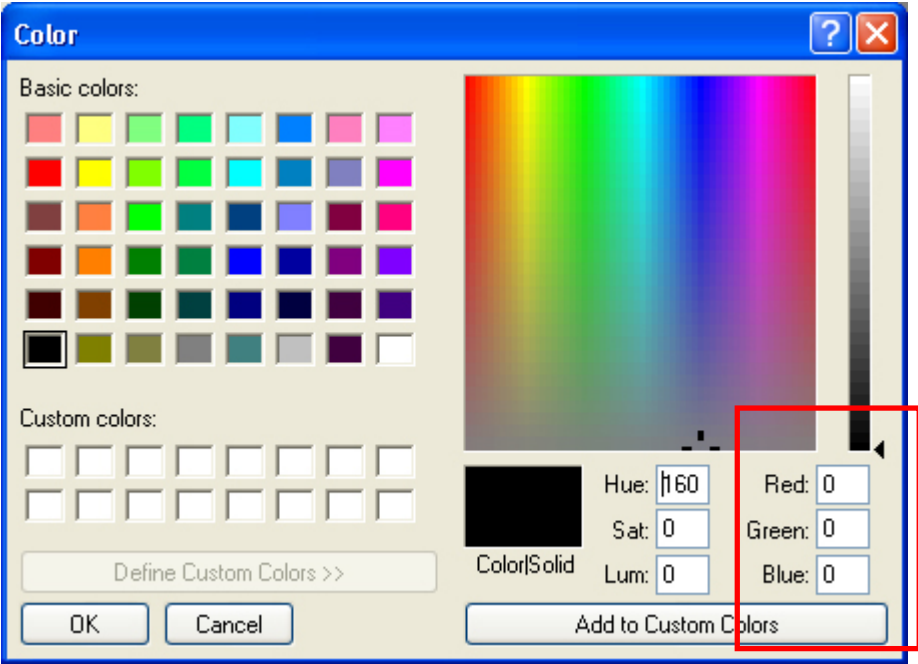
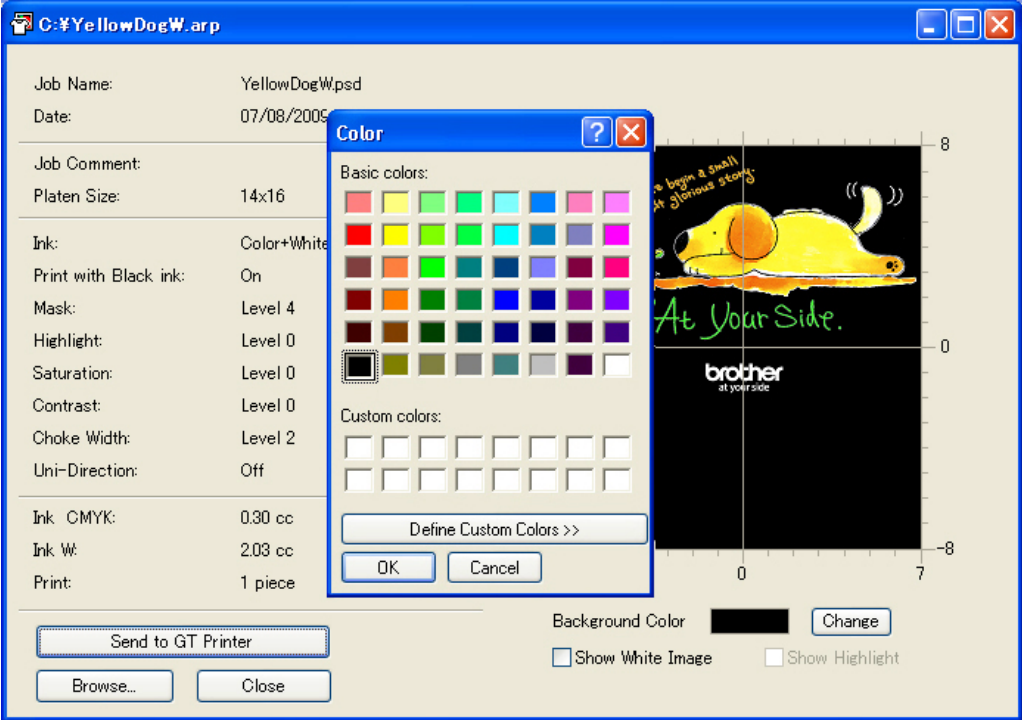

Input the RGB values directly

(Continued on the next page)

5. Printing ARP Files

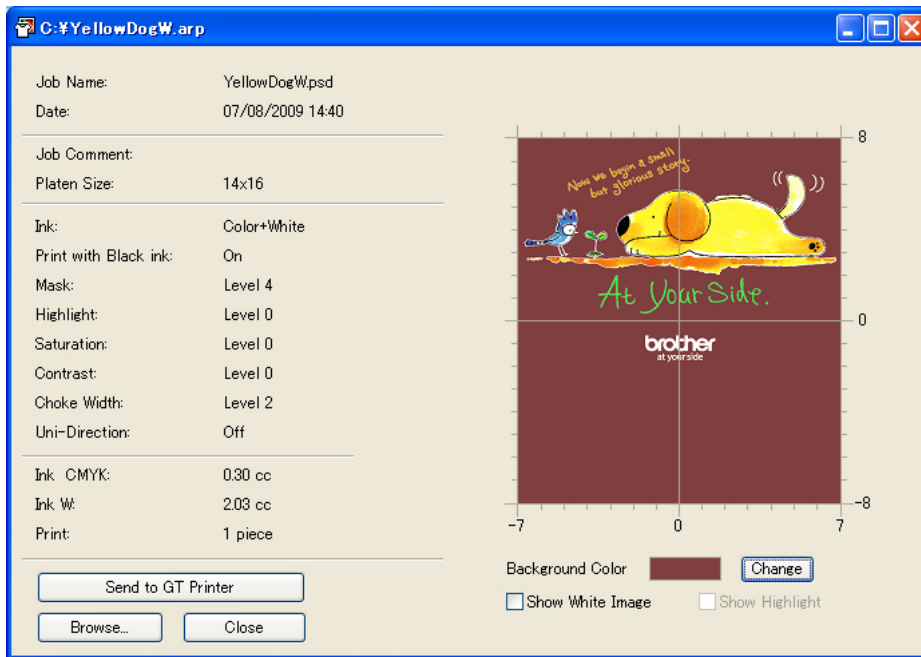

Simulation with the brown background (R=128, G=64, B=64)

- (4) Confirm the print conditions and layout, then click "Send to GT Printer". Also confirm that your printer is connected to PC with USB 2.0 Cable.
The ARP file has been sent to your printer.

<Note>

If more than one GT-541 are installed in your PC, the Select Printer dialog appears.
Select the one to send the data to, and then click OK. PC starts sending the print data.

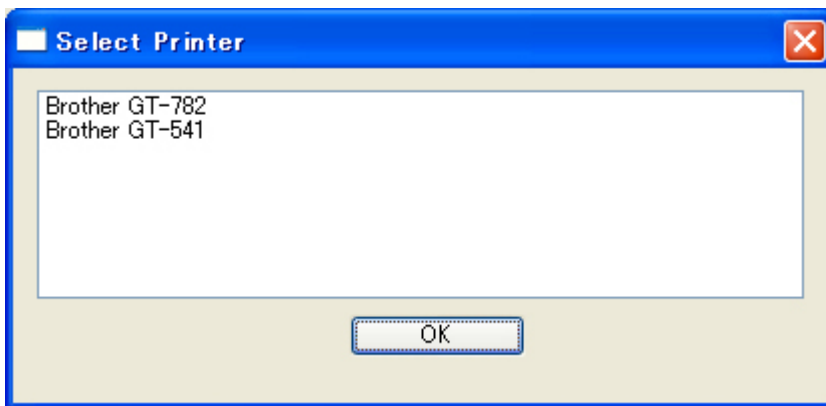

6. Maintenance

For optimum product performance regular maintenance is required.

DANGER



Wait at least 5 minutes after turning off the power switch and disconnecting the power cord from the wall outlet before opening the cover of the control unit. Do not touch as high voltage can result in severe injury.

WARNING



Do not put your hands in the ink cartridge slot, otherwise the needle inside the slot may cause injury.

CAUTION



Wait at least 1 minute after turning off the power switch before opening the front cover.

Do not touch the head heat sink as it may be HOT and may cause a burn.



Be careful not to get your fingers caught when closing the front cover, otherwise it may result in injury to your fingers.



Do not move the Platen by hand.

The Printer may be seriously damaged by this.



Do not disassemble the ink cartridge.



Take care not to let the ink, Wash Liquid, Maintenance Solution, Pretreatment or waste liquid come into contact with your eyes or onto your skin, otherwise inflammation can result. In case of contact with eyes, do not rub but immediately rinse the eyes with water.

Do not drink the ink, Wash Liquid, Maintenance Solution, Pretreatment or waste liquid under any circumstances, as they can cause vomiting and diarrhea.

Keep the ink, waste liquid and wash liquid out of the reach of children.



Use only the proper replacement parts as specified by Brother.

6-1. Replacing Consumables

This section describes how to replace the consumables and the maintenance of the printer.

6-1-1. Replacing the Ink Cartridge

The ink indicator on the Display flashes when the Ink Cartridge is getting low. Prepare the new Ink Cartridge, and replace it when "Empty XXXX (color)" is displayed.

<Note>

- Use the Ink Cartridges described in "1-3-5. Consumable Requirements".
- Be careful not to get ink on your hands or clothing. Wash with soap if stained with ink.
- Do not replace cartridges while printing or head cleaning; is in operation it may cause damage to your printer.
- Do not disassemble the Ink Cartridge.
- Replace the Wiper Cleaner regularly to keep the print quality. The timing will be indicated on the Display of the Control Panel. See "6-1-2. Replacing the Wiper Cleaner".
- To keep the best print result, your printer will show empty status for the color cartridge that is empty. To keep print quality, a small amount of ink remains to avoid damage to your printer.

- (1) Remove the new Ink Cartridge from its packing.
- (2) Carefully remove the used Ink Cartridge from your printer.

<Note>

Leave the used Ink Cartridge installed until just before the replacement. Leaving your printer with no Ink Cartridge installed may cause ink leakage or other serious damages.

Do not put your finger to the Ink Cartridge Slot; otherwise you may get injured with the needle inside.

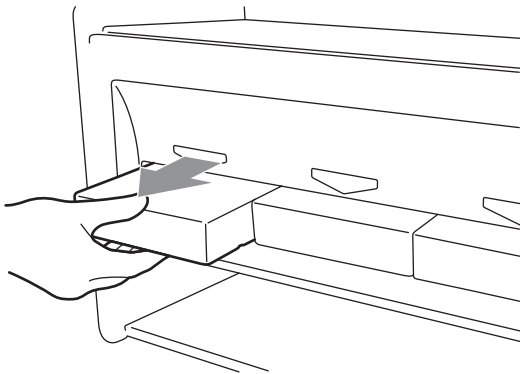

- (3) Insert the new Ink Cartridge securely and ensure the direction and the color are correct.

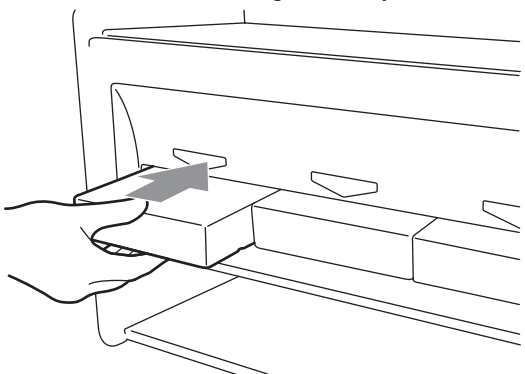

(Continued on the next page)

<Note>

Confirm the color of the ink cartridge. Loading a wrong color causes serious damage to print quality, and could damage the Print Heads. If you have installed a wrong color, immediately contact Brother or your dealer for a service call.

- (4) When you have replaced the Black Ink Cartridge, refer to “6-1-2. Replacing the Wiper Cleaner” and replace the attached Wiper Cleaner and clean the surroundings. This is really important to keep your printer in good condition.

<Note>

- Do not repeat uninstalling / installing the Ink Cartridge.
- Dispose the used Ink Cartridge in compliance with your local regulations.

6-1-2. Replacing the Wiper Cleaner

The Wiper Cleaner needs to be replaced regularly. Keep the Print Head Cap and Wiper Blade clean when replacing the Wiper Cleaner. If not, the waste ink may drop on a T-shirt in printing or mis-firing may not be easily improved.

- (1) Press the OK Button that you are going to replace and show the Menu.
- (2) Press the Up/Down Button to select the “Maintenance”, and then press the OK Button.
- (3) Press the Up/Down Button to select the “Cap/Wiper Clean”, and then press the OK Button.
The Wiper Blade will be at the cleaning position. Follow the message and turn off the printer.
- (4) Open the Front Cover with both hands after unlocking the cover locks and slide the Latch to fix the Front Cover.

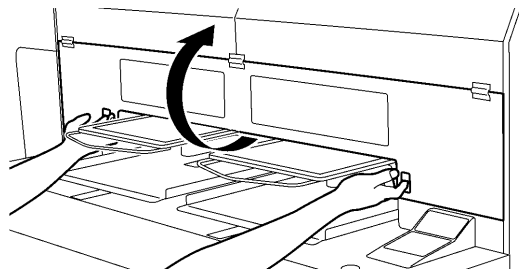

4325M

- (5) Pull out the Wiper Cleaner Cassette straight and slowly.

<Note>

Do not tilt the Wiper Cleaner Cassette; ink may get on your hands or clothing.
Do not touch the Clearance Sensor (the bar above the Wiper Cleaner Cassette).

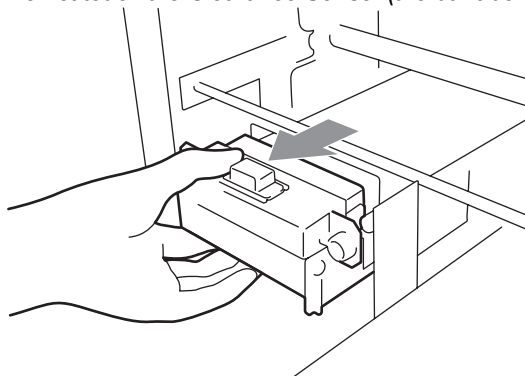

(Continued on the next page)

6. Maintenance

- (6) If the ink inside of the Wiper Cleaner Cassette is soiled with ink:
Wear gloves and remove the ink with a dry cloth, and then clean with a moist cloth.

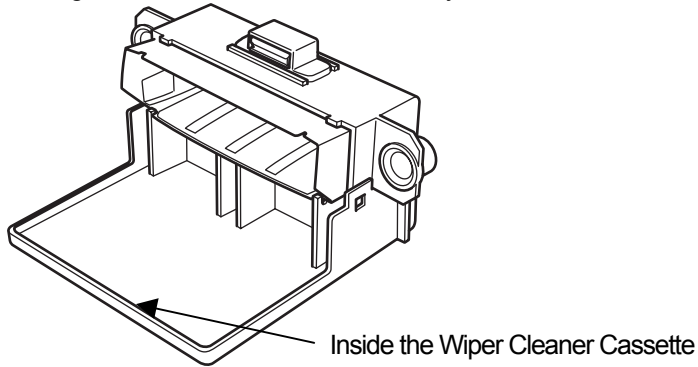

- (7) Push both sides of the Wiper Cleaner Cassette to open it.

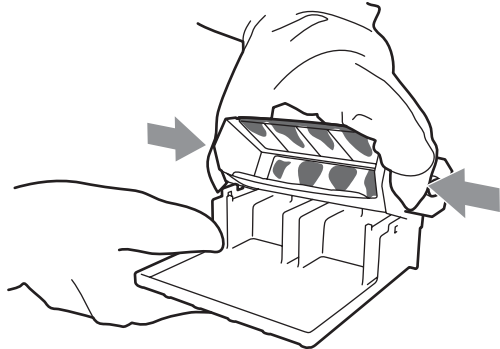

- (8) Carefully drop off the used Wiper Cleaner and dispose of in accordance with local regulations.

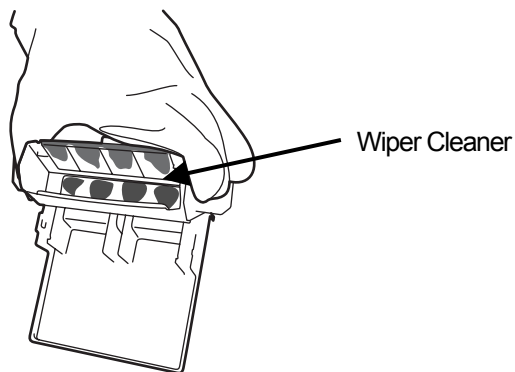

<Note>

Dispose the used Wiper Cleaner in compliance with your local regulations.

- (9) Insert the two projections of the Wiper Cleaner Cassette into the holes on the new Wiper Cleaner.

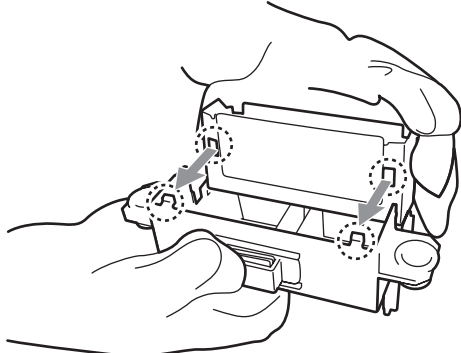

(10) Close the Wiper Cleaner Cassette.

Make sure that the bottom of the Wiper Cleaner is set within the two projections on the Wiper Cleaner Cassette. Push in the Wiper Cleaner after closing.

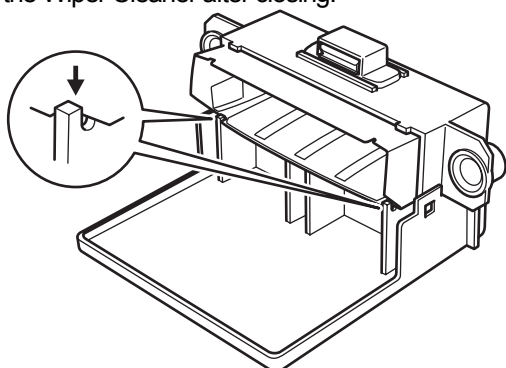

(11) Open the Wiper Cleaning Kit which comes with the new Black Ink Cartridge.

The following items are included.

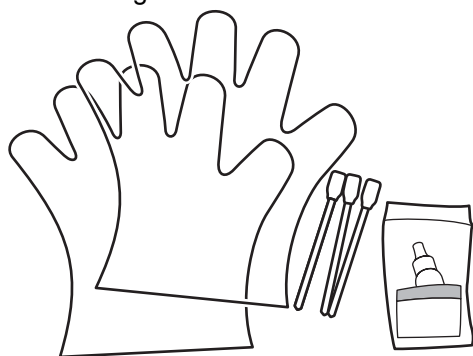

(12) Wear the gloves, and wet both sides of a Clean Applicator with the Wash Liquid.

<Note>

Use only the Wash Liquid included to wet the Clean Applicators; using other liquid will cause damage to the Print Heads.

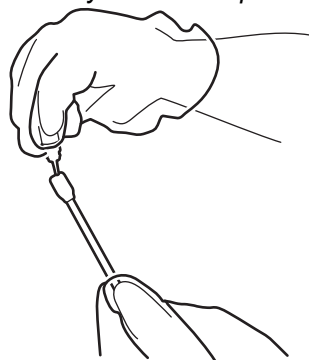

(13) Use the one side of wet Clean Applicator to clean the front side of the Wiper Blade.

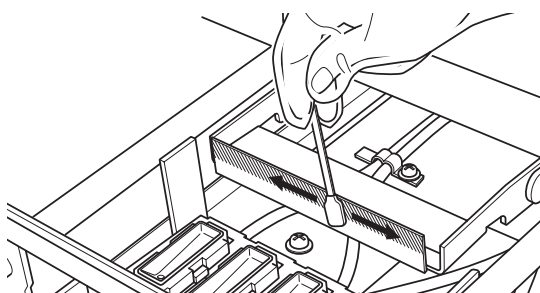

6. Maintenance

- (14) Use the other side of the wet Clean Applicator to clean the rear of the Wiper Blade.

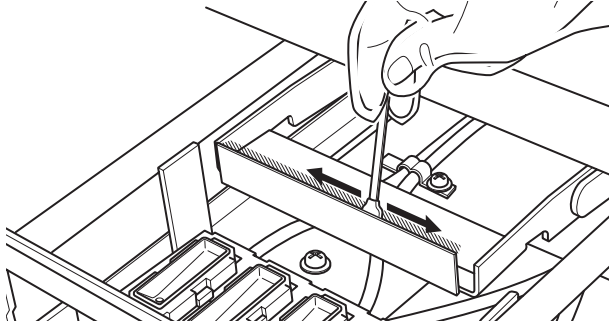

- (15) Wet other two Clean Applicators and use them to remove ink or dust from the Print Head Caps. Use one side of the Clean Applicator to clean one Print Head Cap.

<Note>

Do not use dry Clean Applicator; it cannot clean ink or dust. It may damage the Print Head Caps. Wipe off the dirty ink of Clean Applicator with soft cloth if it is too dirty and wet with Wash Liquid.

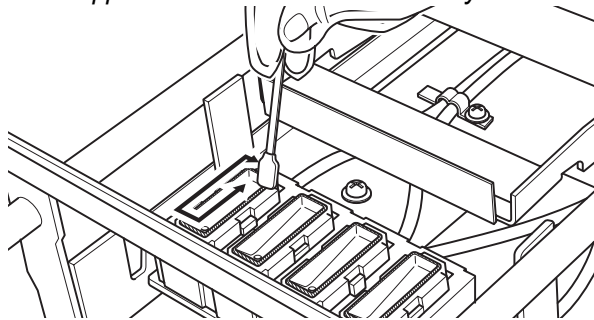

- (16) Insert the Wiper Cleaner Cassette straight into your printer.

<Note>

Do not touch the Clearance Sensor (the bar above the Wiper Cleaner Cassette).

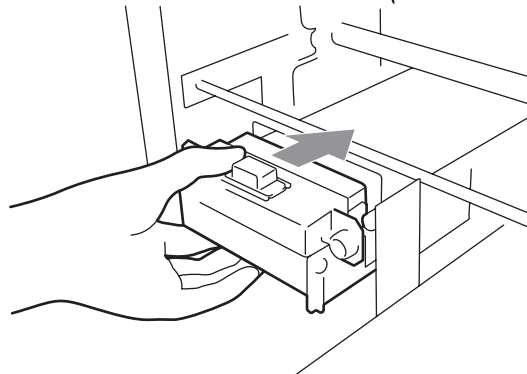

- (17) Check the top edge of the black Flash Plate on the right and the front/back surface of the Obstruction Sensor, if they are dirty with ink and/or dust wipe off the dirt with a soft wet cloth with water.

<Note>

When ink or dust is mounted high on the top edge of the Flash Plate, it may touch the surface of the print head during printing, this may cause misfiring. When the surface/back of the Obstruction Sensor is dirty, it may damage the printing material when loading.

- (18) Close the Front Cover, and then turn on your printer.

If your printer turns on with no errors, replacement of the Wiper Cleaner has been completed.

If there is problem (abnormal noise or error "No Wiper Cleaner "), turn off your printer, and check if the Wiper Cleaner and the Wiper Cleaner Cassette are correctly installed.

6-1-3. Loading / Retrieving White Ink

Do not leave the White ink inside the printer. White pigment precipitates and may cause serious damage to your printer. Before you start your job, retrieve the White Ink, shake the cartridges for 30 seconds to 1 minutes, and the load the White Ink again to start your printing. Clean the tubes once a week with Maintenance Solution. Load the white ink again when you start the print job.

Retrieving White ink:

- (1) Press the OK Button on the right Control Panel and show the Menu.
- (2) Press the Up/Down Button to select the "White Retrieval", and then press the OK Button.
- (3) Make sure that four White Ink Cartridges are installed. Press OK button and White Ink Retrieval starts.(it takes 5 minutes).
- (4) When finished, "Standby" (no print data) or "Ready" (with print data) indicates on the Display.

Shaking White Ink:

- (1) Hold the White Ink Cartridge upside down with a hand.
- (2) Shake the cartridge horizontally and rather slowly so that the White Ink inside can move upside-down. Shake it for 30 seconds to one minute. Shake the cartridge longer (for about 2 minutes) if it has been left for a week or more or the consumption date is coming.

<Note>

Even if you use an automatic shaker, shake by hand horizontally and widely after shaking by the machine.

Loading White Ink:

- (1) Install White Ink Cartridges (once shaken is completed).
- (2) Press the OK Button on the right Control Panel and show the Menu.
- (3) Select "Load White". Select "All White" to do in one time or select the each Print Head to do one by one. Press OK button and White Ink loading starts.
- (4) When finished, "Standby" (no print data) or "Ready" (with print data) indicates on the Display.

Tube Cleaning (White, once a week) :

- (1) Confirm in advance the amount of the Waste Ink in the Waste Ink Tank when you do the maintenance.
- (2) Fill the bottle with Maintenance Solution (500 ml, at least more than 250 ml per one Print Head), tighten the cap and set it in the hole of the Maintenance Cartridge (1 in the right fig.).
- (3) Insert the tube of the Maintenance Cartridge to the bottom of the bottle (2 in the right fig.).
- (4) Retrieve the White Ink (follow the above-mentioned steps), remove one White Ink Cartridge and insert the Maintenance Cartridge (3 in the right fig.). Be sure that the Air-in Cap is capped (closed).
- (5) Select "Maintenance" and "Tube Cleaning" in the right menu from the right Control Panel. Select the Print Head and press OK button.
- (6) The pump starts turning. After 30 seconds, the message indicates on the Control Panel. Uncap (open) the air-in cap and press OK button. The air goes into the tube and wash away the remained White Ink. It takes about 10 minutes to wash one tube.
- (7) After washing with air bubbles, only air is put through the tube to remove the bubbles. Follow the Control Panel and insert the Filter Cartridge with slot closed with the seal and press OK button.
- (8) After all Print Heads are finished, confirm that the tube cleaning is successfully done (check if the tube before/after the Pre-filter is transparent). Select "Maintenance" and "Initial Cleaning" to let the White Ink in the tube. If you leave the printer unused, fill the Maintenance Solution in the tube. (See "6-1-6. Required Maintenance for the Long Storage".

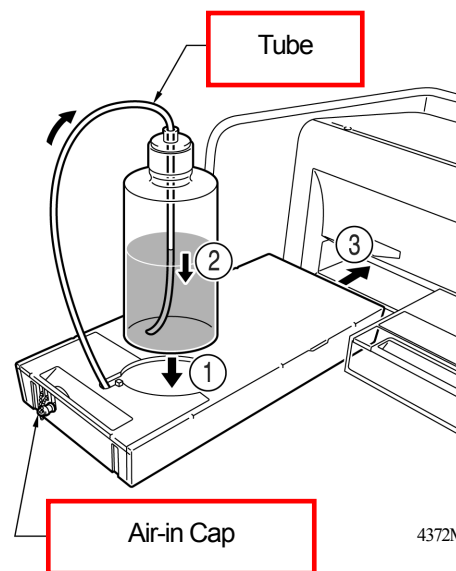

4372M

6. Maintenance

6-1-4. Waste Ink Disposal

Use a polyethylene tank for additional Waste Ink Tank. The amount of the Waste Ink in the White Ink side (White Ink plus Maintenance Solution) is huge rather than the one in the Color Ink side. Confirm in advance the amount of the Waste Ink when you do the maintenance. Deal with care because it is heavy.

- (1) Prepare a new polyethylene tank.
- (2) Pull off the Waste Ink Tube carefully and insert it to the new Waste Ink Tank.
- (3) Remove the full Waste Ink Tank and cap tightly and carefully.
- (4) Install the new Waste Ink Tank in a proper position.

<Note>

Dispose the used Waste Ink in accordance with your local regulations. Or make contact to your dealer.

6-1-5. Replacing the Platen Sheet

The Platen Sheet gets dirty in operation. Please replace the Platen Sheet to avoid making smudges on a T-shirt. To help align a T-shirt, you can print a grid on the Platen Sheet. It is in [All Program] > [Brother GT-782 Tools] > [Useful Tools]. Grid14x16.asp is for the standard Platen 14x16. (See "3-3-5. Opening the Useful Tools".)

- (1) Press the Platen Button to eject the Platen.
- (2) Remove the Platen Sheet and the adhesive tape from the Platen.

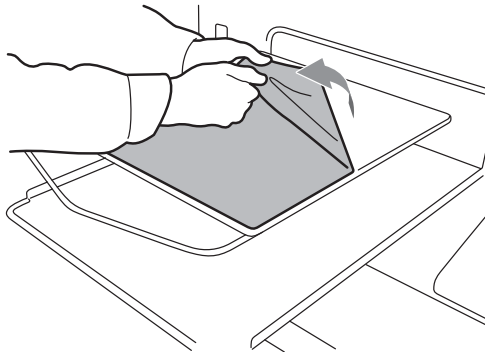

- (3) Clean the surfaces of the Platen using a soft cloth damped with mild detergent, and then wipe it using a soft and dry cloth.
- (4) Make sure the surface of the Platen is completely dry, and then put the new Platen Sheet on the Platen. It is easier if you peel off the release-coated paper little by little as you put the new Platen Sheet.

<Note>

Put the Platen Sheet straight against the Platen without making creases.

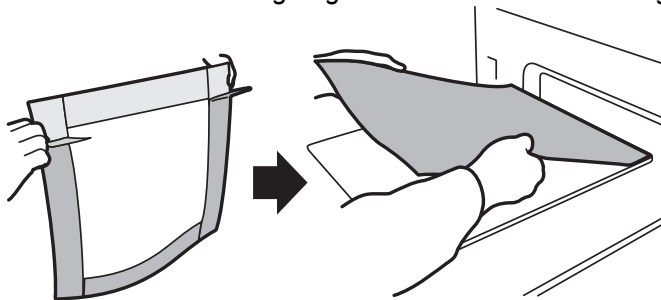

- (5) Press the Platen Button to install the Platen and check it is flat.

6-1-6. Required Maintenance for the Long Storage

If you are not going to use your printer for about two weeks, clean the Print Head Caps before storage to prevent ink drying on the print heads. White Ink should be washed away with Maintenance Solution by Tube Cleaning and then the tubes should be filled with Maintenance Solution.

<Note>

The Wash Liquid is used for this cleaning. You can use the one in the Nozzle Cleaning Kit, the Cap Cleaning Kit, or you can purchase one. If you use the Wash Liquid in the Nozzle Cleaning Kit or the Cap Cleaning Kit, make sure you replace it with the new one.

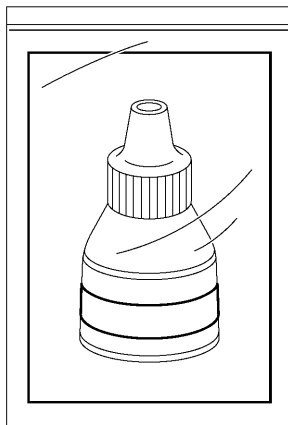

4371M

Cleaning Print Heads (Color & White) :

- (1) Press the OK Button to open the Menu Display.
- (2) Select "Maintenance", and then press the OK Button.
- (3) Select "Cap/Wiper Cleaning", and then press the OK Button.
The Platen moves.
- (4) Turn off your printer when the following display appears.

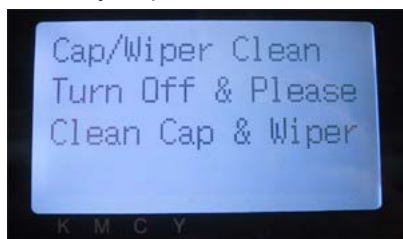

- (5) Open the Front Cover with both hands after unlocking the cover locks and slide the Latch to fix the Front Cover.

(Continued on the next page)

6. Maintenance

- (6) Fill the Print Head Caps with Wash Liquid to prevent from ink clogging inside.

<Note>

Be careful not to spill the Wash Liquid around the Print Head Caps.

If the Wiper Cleaner and the surroundings are dirty, refer to "6-1-2. Replacing the Wiper Cleaner" and clean them.



- (7) Close the Front Cover.
- (8) Turn on your printer wait for initialization to finish.
- (9) After "Standby" is indicated, turn machine off.
- (10) When the machine is first switch on after a long storage period. The heads are automatically cleaned. If print quality is not good, refer to "7-2-6. Cleaning the Print Head Nozzles" and clean the nozzles (the surface of the Print Heads) softly with Nozzle Cleaning Kit or Wash Liquid and Clean Applicators.

Loading Maintenance Solution for White Tubes:

Execute the Tube Cleaning in advance not to leave the White Ink inside the printer. After that, load the Maintenance Solution into the tubes instead of White Ink with Initial Cleaning menu and turn OFF the printer.

- (1) Follow the steps of "6-1-3. Retrieving White Ink" and "Tube Cleaning" and clean the tubes in advance.
- (2) Remove the Maintenance Cartridge and the bottle.
- (3) Fill the bottle with Maintenance Solution (more than 500 ml is necessary).
- (4) Cap (close) the Air-in Cap of the Maintenance Cartridge.
- (5) Press the OK Button to open the Menu Display.
- (6) Select "Maintenance", "Initial Cleaning", select the Print Head in the submenu, and then press the OK Button.
- (7) After loading the Maintenance Solution, insert the Capping Cartridge (option) for covering the needles. Do not use the Filter Cartridges packed with the printer. The inside may be dry.
- (8) After all the Print Heads are finished, turn OFF the printer.

<Note>

- When you want to print again, load the White Ink with "Maintenance", "Initial Cleaning" menu with the Maintenance Solution is loaded.
- Do not print a print data with White data while Maintenance Solution is loaded, which spoils the print data.

7. Troubleshooting

WARNING



Do not put your hands in the ink cartridge slot, otherwise the needle inside the slot may cause injury.

CAUTION



Ensure there is adequate space left for safe working. The Platen moves forward while operating and it may be injured.



Do not handle the platen while printing. If your hand gets caught between the platen or the T-shirt tray and the covers, it may be injured.



Do not move the Platen by hand.
The Printer may be seriously damaged by this.



Do not put your hands inside the covers while the printer's power is turned on, otherwise your hands may touch against moving parts and this may result in injury.



Wait at least 1 minute after turning off the power switch before opening the front cover.
Do not touch the head heat sink as it may be HOT and may cause a burn.



Be careful not to get your fingers caught when closing the front cover, otherwise it may result in injury to your fingers.



Do not disassemble the ink cartridge.



Take care not to let the ink, Wash Liquid, Maintenance Solution, Pretreatment or waste liquid come into contact with your eyes or onto your skin, otherwise inflammation can result. In case of contact with eyes, do not rub but immediately rinse the eyes with water.

Furthermore, do not drink the ink, Wash Liquid, Maintenance Solution, Pretreatment or waste liquid under any circumstances, as they can cause vomiting and diarrhea.

Keep the ink, waste liquid and wash liquid out of the reach of children.

7. Troubleshooting

7-1. Solving Printer Problems

Use the table below to help solve printer problems.

Problem	Cause	Solution
<i>Cannot send print data from the PC.</i>	<i>You have selected the wrong printer.</i>	<i>Confirm the selected printer, and select the correct one.</i>
	<i>USB cable not connected</i>	<i>Disconnect and re-connect the USB 2.0 cable</i>
	<i>Your PC and OS do not satisfy the requirements of GT-782.</i>	<i>See "1-3-3. Software Information" and check your PC properties.</i>
	<i>Using an USB cable that does not meet the requirement.</i>	<i>Use the USB cable that meets the requirement. See "1-3-4. Other requirements".</i>
	<i>The USB hub is not working properly.</i>	<i>Connect GT-782 directly to PC with USB. USB hub is not operationally approved.</i>
	<i>Noise is disturbing the communication between GT-782 and the PC.</i>	<i>Disconnect the USB 2.0 cable once, and wait for 5 seconds and connect it again. If this does not solve the problem, turn off GT-782, wait for 5 seconds and restart.</i>
	<i>The PC is not working properly.</i>	<i>Restart the PC. Try another inlet of USB port.</i>
	<i>Added USB card in PC and GT-782 do not match.</i>	<i>Connect GT-782 with the original USB port in PC</i>
	<i>Other USB device is connected with your PC.</i>	<i>Remove the other USB device and restart your PC, and check if GT-782 works properly.</i>
	<i>Something is wrong with the USB cable.</i>	<i>Try other or shorter USB 2.0 cables.</i>
<i>Display turned OFF but Error LED ON</i>	<i>Auto Power-off worked.</i>	<i>Turn OFF and ON the power switch.</i>
<i>Pressing the Print Button does not start printing.</i>	<i>GT-782 is indicating an error</i>	<i>Solve the cause of the error, and try again.</i>
	<i>"Ready" or "Print Ready" is not indicated on the Display, the other Control Panel is in the menu or operating.</i>	<i>Confirm the status of the other Control Panel. Wait till the operation is over.</i>
	<i>Auto Head Cleaning is in process.</i>	<i>Wait until the Head Cleaning finishes.</i>
	<i>The room temperature does not meet the requirements.</i>	<i>Adjust the room temperature. See "1-3-1 Environment".</i>
	<i>The printer has not received/read a data, or is now receiving/reading the data.</i>	<i>Machine will not print until print job has been received.</i>
	<i>The Print Heads are overheated and the message "Fail: Head Temp (***)" appears.</i>	<i>Wait until the heads cool down.</i>
<i>GT-782 does not turn on.</i>	<i>There is no power.</i>	<i>Check the power cable connections.</i>
	<i>The Front Cover is open or not closed properly.</i>	<i>Close the Front Cover properly.</i>

Problem	Cause	Solution
<i>An error occurred just after turning on GT-782.</i>	<i>An error occurred.</i>	<i>Check the error code with "7-4. Error Messages" and restart GT-782. If the error is not cleared, please contact Brother or your dealer.</i>
<i>GT-782 cannot read data from CompactFlash.</i>	<i>No CompactFlash is inserted in the slot, or it is not inserted properly.</i>	<i>Insert CompactFlash properly.</i>
	<i>That CompactFlash is not supported.</i>	<i>Use the supported CompactFlash. See "1-3-4. Other Requirements".</i>
	<i>The CompactFlash is not FAT16/32 formatted.</i>	<i>Use the CompactFlash that is FAT16/32 formatted.</i>
	<i>The CompactFlash has poor quality.</i>	<i>Use the recommended CompactFlash. See "1-3-4. Other Requirements".</i>
<i>The file name of the print data saved in a CompactFlash is not displayed properly.</i>	<i>The file name has been changed when saving it in the CompactFlash because it had 9 or more characters.</i>	<i>Rename the file with characters of 8 or less, and then save it again in the CompactFlash.</i>
<i>Cannot do Uni-Directional / Bi-Directional Printing.</i>	<i>The setting between the Printer Driver and the Printer does not match.</i>	<i>The printer setting is prior to the Printer Driver. Uni-Directional setting in the Printer Driver is only available when the printer setting is [Auto].</i>
<i>No highlight printed.</i>	<i>There is no highlighted colors in the image.</i>	<i>When there is no highlighted colors in the image, even if you select Highlight and GT File Viewer shows the setting, the printer does not execute double printing. Confirm the Double Print Icon on the display of the Control Panel. Also you can check the actual highlight data with the check box [Show Highlight] of the GT File Viewer.</i>

7-2. Solving Print Quality Problems

Use the table below to solve print quality problems.

Problem	Cause	Solution
<i>Print is faded.</i>	<i>The graphic applications' settings are not appropriate. Maybe CMYK mode is being used for data.</i>	<i>See "4-2 Setting the Applications' Print Condition" and modify the artwork.</i>
	<i>The print condition is not appropriate. (less saturation)</i>	<i>See "4-3. Setting the Printer Driver Condition" and select proper Color Processing to adjust saturation and contrast & Ink Volume. Vivid Processing in GT-541 is identical with Contrast (Vivid 1 = Contrast 10).</i>
	<i>Ink in the Ink Cartridge may be getting low.</i>	<i>See "6-1-1. Replacing the Ink Cartridge".</i>
<i>Your print has horizontal stripes (banding).</i>	<i>Some nozzles misfired by checking the Nozzle Check Pattern (see "7-2-3. Checking Print Quality with Nozzle Check Pattern "). The Print Heads need to be cleaned.</i>	<i>Press the Head Cleaning Button to clean the Print Heads. Or select "Head Cleaning" menu. After Head Cleaning, check the nozzles with "Nozzle Check Pattern. If repeating this 5 times does not solve the problem, see "7-2-2. Cleaning the Print Heads".</i>
	<i>Printing on very high absorbent material.</i>	<i>Select "uni-directional" of Print Direction. See "7-2-4. Changing the Print Direction".</i>
	<i>The Platen is too low. Printing by wider gaps between Print Heads and printed medium.</i>	<i>Adjust the Platen height. If the Platen Positioning Plate and Bush Platen Shaft are replaced to the GT-541's, put something flat under the paper or try Uni-Directional Printing, or put them back to the original GT-782 parts.</i>
<i>The ink runs and blurs on the edge.</i>	<i>Too much ink is used. Using a thin T-shirt that is not made with 100% cotton.</i>	<i>Adjust the Ink Volume. See "4-3-7. CMYK Color Inks for Color ink only".</i>
<i>The outlines of printed image are not clear, or texts and outlines are printed doubled.</i>	<i>The Platen height may be wrong with a too large gap.</i>	<i>Adjust the Platen Height. See "4-5. Placing the T-shirt on the Platen". If the Platen Positioning Plate and Bush Platen Shaft are replaced to the GT-541's, put something flat under the paper or try Uni-Directional Printing, or put them back to the original GT-782 parts.</i>

Problem	Cause	Solution
<i>T-shirt is smudged with ink.</i>	<i>Print Heads hit garment</i>	<i>Keep the surface flat (esp. both edges) and take care in removing the wet T-shirt.</i>
	<i>Waste ink spreads over the Wiper Cleaner and spoils around the Print Heads.</i>	<i>See "6-1-2. Replacing the Wiper Cleaner".</i>
	<i>The Platen Sheet needs to be replaced and is dirty.</i>	<i>See "6-1-5. Replacing the Platen Sheet".</i>
<i>Ink dots smudged yellow area where is next to black area.</i>	<i>Select Yellow / Black Printing of Printer Driver.</i>	<i>See "4-3-7. CMYK Color Inks for Color ink only".</i>
<i>Pale colors are getting disappeared while printing.</i>	<i>The nozzles of the Print Heads are getting dried under the humid high-temperature condition.</i>	<i>See "7-2-10. Setting Extra Wipe".</i>
<i>White is uneven.</i>	<i>Pretreatment was not applied enough or done unevenly.</i>	<i>Apply evenly. See "4-6-1. Applying the Pretreatment".</i>
	<i>Water drops on the Pretreatment-cured surface cause stains.</i>	<i>Do not wet the cured surface. See "4-6-1. Applying the Pretreatment".</i>
<i>White is not white enough.</i>	<i>Pretreatment was not applied enough.</i>	<i>See "4-6-1. Applying the Pretreatment".</i>
	<i>Temperature was too low in curing Pretreatment.</i>	
	<i>Some nozzles misfired by checking the Nozzle Check Pattern (see "7-2-3. Checking Print Quality with Nozzle Check Pattern "). The Print Heads need to be cleaned.</i>	<i>Press the Head Cleaning Button to clean the Print Heads. Or select "Head Cleaning" menu. After Head Cleaning, check the nozzles with "Nozzle Check Pattern. If repeating this 5 times does not solve the problem, see "7-2-2. Cleaning the Print Heads".</i>
	<i>White Ink Cartridges were not shaken enough.</i>	<i>Do the steps in "6-1-3. Loading / Retrieving White Ink". Shake the White Ink Cartridges well.</i>

7-2-1. Procedure for Solving the Print Quality Problems

Follow the procedure (Step 1 to 7) below until the print quality problem is solved.

<Note>

The following steps are shown with CMYK Print Heads and do the same in case of White Print Heads.

Step 1: Clean the Print Heads by pressing the Head Cleaning Button.

Head Cleaning with flushing fresh ink can solve most print quality problems. See "7-2-2. Cleaning the Print Heads / Using the Head Cleaning Button" and do it a maximum of five times. Check the nozzles by test printing of Nozzle Check Pattern (see "7-2-3. Checking Print Quality with Nozzle Check Pattern "). If the problem is not solved, go on to the next step.

(Continued on the next page)

7. Troubleshooting

<Note>

- It is very important the machine is used in an environment as specified. Use a humidifier to keep the humidity up to 35% to keep print quality.
- Your printer automatically cleans its Print Heads every 24 prints; however more frequent Print Heads cleaning may need to be done depending on the environment. In this case, change the Auto Head Cleaning frequency (see "7-2-5. Changing the Auto Head Cleaning Setting").

Step 2: Check the Wiper Cleaner, replace it when it is full.

The Wiper Cleaner absorbs some waste ink carried by the Wiper Blade. If Wiper Cleaner cannot absorb waste ink any more, the dirty Wiper Blade wipes the Print Head Nozzles and this causes misfiring or damage the Print Head. Please replace the Wiper Cleaner and clean the Wiper Blade and caps; Check if it is too dirty to wipe off the waste ink. Please use Cap Cleaning Kit. If the black ink is not changed frequently please consider the wiper.

How to Check:

- (1) See "6-1-2. Replacing the Wiper Cleaner" and select "Cap/Wiper Clean" and then turn off your printer.
- (2) Open the Front Cover with both hands after unlocking the cover locks and slide the Latch to fix the Front Cover.
- (3) Pull out the Wiper Cleaner Cassette in the left.

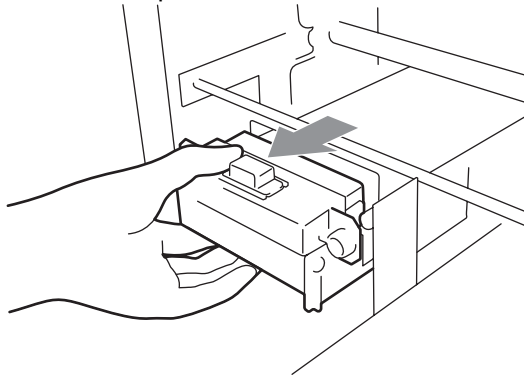

<Note>

Do not tilt the Wiper Cleaner Cassette; ink may get on your hands or clothing.

- (4) Check the Wiper Cleaner, and if it is heavily soiled, replace it using the Cap Cleaning Kit (see "6-1-2. Replacing the Wiper Cleaner"). If the Wiper Cleaner is not heavily soiled, go on to the next step.



The condition of the left photo is "not yet but soon". When the bottom absorber is full it must be changed.

(Continued on the next page)

- (5) Check the Wiper Blade, and if it is damaged or worn, replace it using the Wiper ASSY (see "7-2-9. Replacing the Wiper Blade" for the details).

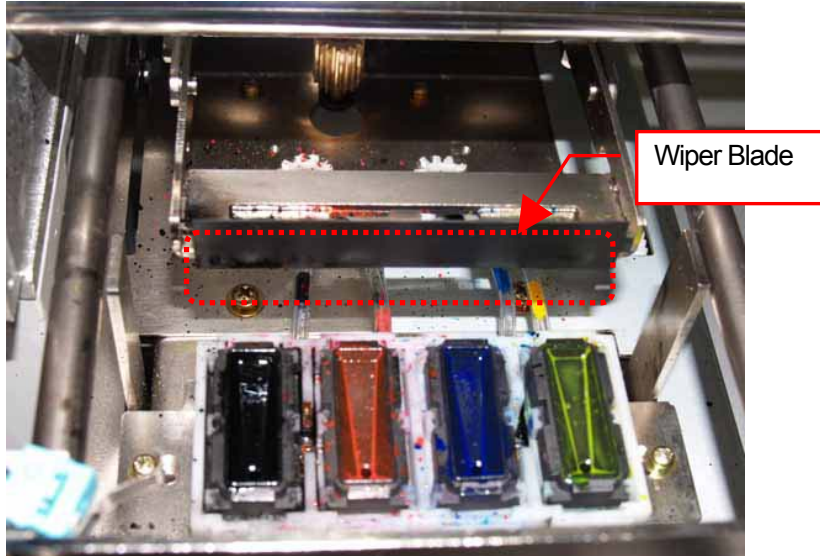

Step 3: Check the ink tubes and do "Powerful" head cleaning.

Check the ink tube inside to see if there is any "empty" air space longer than 5 mm. If so, do "Powerful" head cleaning to fill the tube with ink. If not enough, please do "Initial" head cleaning (you can cancel if the empty air space disappears.)
If the problem is not solved, proceed to the next step.

Step 4: Clean the Print Heads with the "Powerful" mode.

- (1) Print the Nozzle Check Pattern, and check which Print Head has the problem (see "7-2-3. Checking Print Quality with Nozzle Check Pattern").
 - (2) Clean the Print Head that has the problem with the "Powerful" mode (see "7-2-2. Cleaning the Print Heads").
 - (3) Print the Nozzle Check Pattern and check if the problem is solved. If you still notice the problem, repeat steps (1) to (3) up to five times.
- If the problem is not solved, proceed to the next step.

Step 5: Clean the Print Head Nozzles.

- (1) Clean the Print Head Nozzle using the Nozzle Cleaning Kit (see "7-2-6. Cleaning the Print Head Nozzles").
<Note> Purchase the new one after use.
- (2) Clean the Print Head with the "Powerful" mode and do test print with "Nozzle Check Pattern" (see "7-2-3. Checking Print Quality with Nozzle Check Pattern"). If the problem is not solved, try the Step 6 two or three times.

<Note>

Make sure you always clean the Print Head with either "Powerful" or "Initial" mode after the Print Head Nozzle cleaning.

If the problem is not solved, proceed to the next step.

Step 6: Contact Brother Customer Service or your dealer.

If you are asked to replace the Print Head by yourself, see "7-2-7. Replacing the Print Head" for the procedure.

7. Troubleshooting

7-2-2. Cleaning the Print Heads

Your printer automatically cleans its Print Heads every 24 prints (you can change the frequency; see "7-2-5. Changing the Auto Head Cleaning Setting"), or when your printer has not been used for more than two hours. The auto-cleaning starts when you press the Print Button in these situations. However, the auto-cleaning may not be enough and cannot solve print quality problems (e.g. stripes/ banding appears on the printed image). Please do the "manual" head cleaning.

Using the Head Cleaning Button

- (1) Make sure your printer is either Standby or Ready mode.
- (2) Press the Head Cleaning Button.
The message "Head Cleaning..." appears and your printer starts "Normal" head cleaning.
(Press the Stop Button to cancel cleaning.)
The message changes to "Stand By" or "Ready" when the head cleaning has been completed.

Normal/ Powerful/ Initial Head Cleaning

- (1) Make sure your printer is either Standby or Ready mode.
- (2) Press the OK Button to display the Menu Display.
- (3) Press the Up/Down Button to select "Head Cleaning", and then press the OK Button.
- (4) Press the Up/Down Button to select the mode (Normal/Powerful), and then press the OK Button. Select "Normal" or "Powerful" by the steps shown in "7-2-1. Procedure for Solving the Print Quality Problems". After a long storage, or when you find ink tubes have "empty air" space inside, try "Initial" head cleaning first to replace all the ink inside the tube. Select "Initial Cleaning" in "Maintenance" menu and execute Initial Head Cleaning.

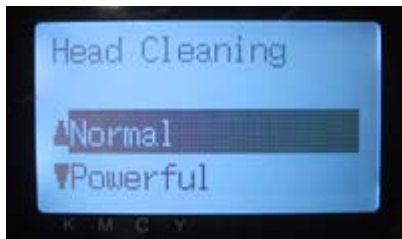

- (5) Press the Up/Down Button to select which Print Head (color) to clean (can select "All Colors" for Normal mode), and then press the OK Button.
The message "Head Cleaning..." appears and your printer starts cleaning the Print Heads.
The message changes to "Stand By" when the head cleaning has been completed.

<Note>

The "Initial" cleaning cannot be done with the Waste Ink Cartridge is full. Confirm in advance the amount of the Waste Ink when you do the maintenance. (see "6-1-4. Waste Ink Disposal.")

7-2-3. Checking Print Quality with Nozzle Check Pattern

You can identify which Print Head has the problem by using the Nozzle Check Pattern. Do when some white lines can be seen in the print data or white is not white enough.

<Note>

- If the Platen Positioning Plate and Bush Platen Shaft are replaced to the GT-541's, put something flat under the paper or try Uni-Directional Printing, or put them back to the original GT-782 parts.
 - When you check the White print quality, use colored paper, plastic plate, etc.
- (1) Install the Platen 14 x 16 (see "4-4. Uninstalling / Installing the Platen").
 - (2) Set the Platen height to the "A" position (see "4-5. Placing the T-shirt on the Platen").

(Continued on the next page)

- (3) Place a sheet of paper (A4 or letter size) at the right corner of the Platen as shown below. You can use a T-shirt instead of paper (see "4-5. Placing the T-shirt on the Platen").

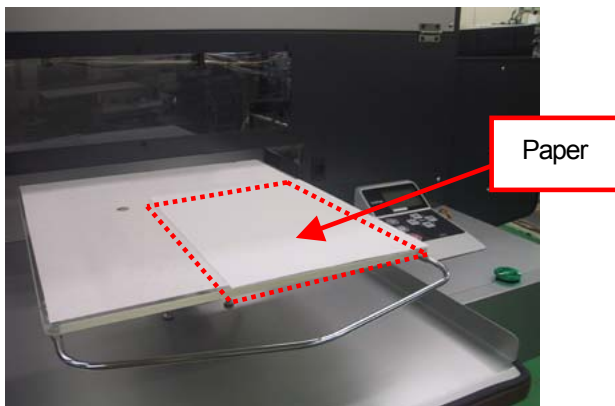

- (4) Press the OK Button to open the Menu Display.
 (5) Press the Up/Down Button to select "Test Print", and then press the OK Button.
 (6) Press the Up/Down Button to select "Nozzle Check", and then press the OK Button.
 The following message appears.

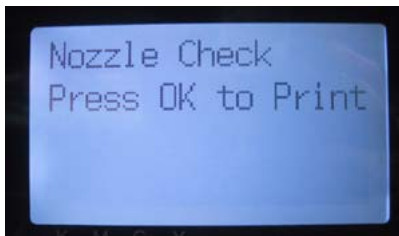

- (7) Press the OK Button to start printing the Nozzle Check Pattern.
 (8) Check the printed pattern to identify which Print Head has the problem.
 If there is stripes (arrow 1) or line breaks (arrow 2), the Print Head of the color (in the following example: Magenta) has the problem. The Print Heads need to be cleaned (see "7-2-2. Cleaning the Print Heads").

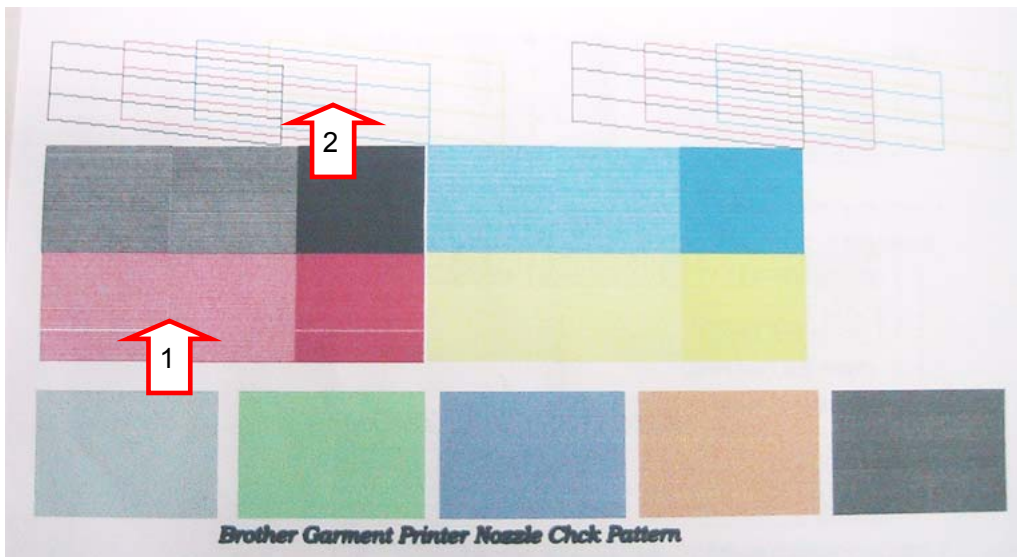

7. Troubleshooting

7-2-4. Changing the Print Direction

When there are large gaps between the Print Heads and printed medium, or when printing on very high absorbent material, horizontal stripes can appear on the printed image. You can solve this problem using one-way "Uni-Directional" print. If you adjust to a larger gap than we recommend this mode is used. Keep the gap by about 2-3 mm between the Obstruction Sensor and a T-shirt.

If you already know that a print data will be printed in uni-directional printing before you print, you can set with the Printer Driver. This setting is available when the printer's setting is [Auto]. See "4-3. Setting the Printer Driver Condition" and "4-3-8. Setting Print Direction as Uni-Directional".

- (1) Press the OK Button to display the Menu Display.
- (2) Press the Up/Down Button to select "Print Direction", and then press the OK Button.
Select "Always Uni-". This setting is always available until you change the setting.



<Note>

- Uni-Direction Icon indicates on the Display of the Control Panel.
- The default setting is "Auto", which follows the Printer Driver setting. (Check-OFF Uni-Directional Printing)
- The printer setting is prior to the Printer Driver setting. Even if the checkbox "Uni-Directional Printing" is checked, when the printer setting is "Always Bi-" then the print is Bi-Directional. Unlike GT-541, even the new print data is received, the printer setting does not change.

7-2-5. Changing the Auto Head Cleaning Setting

Your printer automatically cleans its Print Heads every 24 prints. However more frequent Print Heads cleaning needs to be done depending on the environment. In this case, change the Auto Head Cleaning frequency as follows.

<Note>

This setting is available with Color / White separately.

- (1) Press the OK Button to open the Menu Display.
- (2) Press the Up/Down Button to select "Maintenance", and then press the OK Button.
- (3) Press the Up/Down Button to select "Auto Cleaning", and then press the OK Button.
The following display appears.

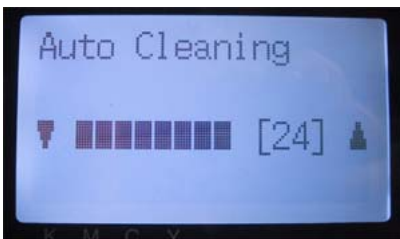

- (4) Press the Up/Down Button to select the frequency from 1 to 24, and then press the OK Button.
The Auto Head Cleaning will be executed at every number of prints you have set.

<Note>

Cleaning the Print Heads frequently may hasten the Wiper Cleaner consumption.

7-2-6. Cleaning the Print Head Nozzles

Use the Nozzle Cleaning Kit to clean the Head Nozzle.

<Note>

Pay careful attention in cleaning the clean Print Head Nozzles, which are both delicate and expensive. The Print Head Nozzle should be cleaned only when it is needed as follows in "7-2-1. Procedure for Solving the Print Quality Problems".

- (1) Make sure your printer is in either "Standby" or "Ready".
- (2) Press the OK Button to display the Menu Display.
- (3) Press the Up/Down Button to select "Maintenance", and then press the OK Button.
- (4) Press the Up/Down Button to select "Nozzle Cleaning", and then press the OK Button. The Head Caps and the Wiper Blade prepare for cleaning.

The following message appears.

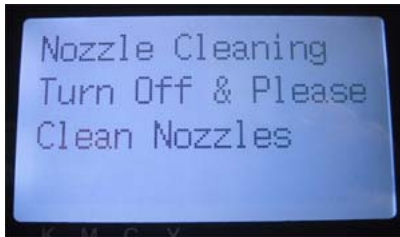

- (5) Turn off your printer.
- (6) Open the Front Cover with both hands after unlocking the cover locks and slide the Latch to fix the Front Cover.
- (7) Pull out the Wiper Cleaner Cassette.

<Note>

Do not tilt the Wiper Cleaner Cassette; ink may get on your hands or clothing.

Do not touch the Clearance Sensor (the bar above the Wiper Cleaner Cassette).

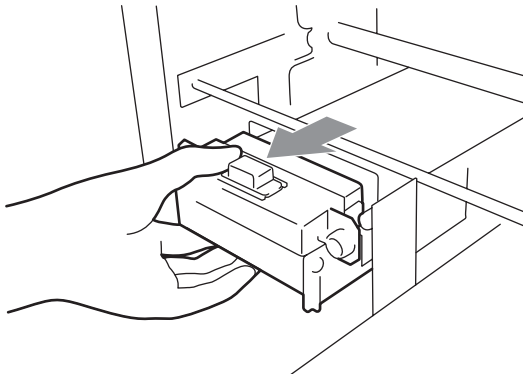

(Continued on the next page)

7. Troubleshooting

(8) Open the Nozzle cleaning Kit. Wear the gloves and wet a Clean Applicator with full of Wash Liquid.

<Note>

- Nozzle Cleaning Kit is available for CMYK / White inks.
- Use Clean Applicators in Nozzle Cleaning Kit (round form), not in Cap Cleaning Kit (green stick with flat form).
- Wet a Clean Applicator only with Wash Liquid, do not rub the Print Head with other liquid (e.g. ater). Print Head may be seriously damaged.



(9) Wet the surface (nozzle plate) of the Print Head with Wash Liquid. Then rub softly the nozzle plate to remove ink and debris from the nozzle plate until the nozzle plate is clean. Use a soft, clean and lint-free cloth to loosen and remove the dirty ink and debris from the Clean Applicator to keep its surface clean and wet again with Wash Liquid. Use one Clean Applicator for each color.



(Continued on the next page)

(10) Insert the Wiper Cleaner Cassette straight into your printer.

<Note>

Do not touch the Clearance Sensor (the bar above the Wiper Cleaner Cassette);

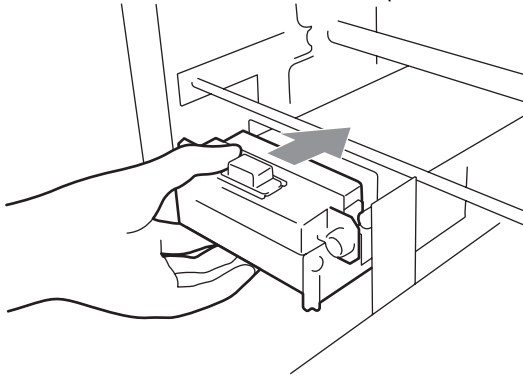

(11) Close the Front Cover, and then turn on your printer.

(12) Do the "Powerful" head cleaning and print the Nozzle Check Pattern until the print quality is satisfactory.

7-2-7. Replacing the Print Head

The print heads can be replaced following the "Replacing the print head procedure". Use only Print Head W for White Ink. If you have any questions please contact your service number.

<Note>

Replacement of the Black Print Head is shown as an example in this section. When the White Print Head is replaced, load the Maintenance Solution in advance. See "6-1-3. Loading / Retrieving White Ink".

- (1) Make sure your printer is in either "Standby" or "Ready" modes.
- (2) Press the OK Button to display the Menu Display.
- (3) Press the Up/Down Button to select "Maintenance", and then press the OK Button.
- (4) Press the Up/Down Button to select "Head Replacement", and then press the OK Button.
- (5) Press the Up/Down Button to select the color of Print Head to be replaced, and then press the OK Button. The following message appears. (e.g. Black)



(Continued on the next page)

7. Troubleshooting

- (6) Remove the Ink Cartridge (Color) or the Maintenance Solution (White) and then press the OK Button. The black example is shown.



The message "Set Filter Cartridge & Press OK" appears.

- (7) Insert the Filter Cartridge to the Ink Cartridge Slot, and then press the OK Button.



The ink draining of the head begins. Wait until the message "Turn Off & Change [X] Head" appears.

- (8) Turn off your printer.
(9) Open the Front Cover with both hands after unlocking the cover locks and slide the Latch to fix the Front Cover.

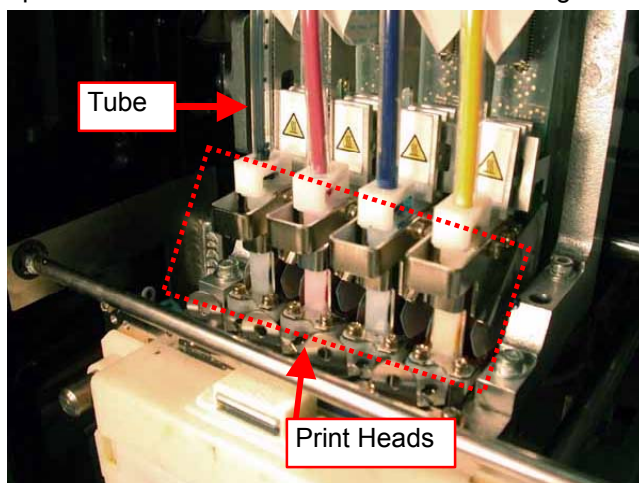

<Important!>

- *Print Head is very sensitive to static electricity and it may be seriously damaged when touching with charged hand. Follow the caution label inside the Front Cover on the printer and be sure to discharge static electricity that your body has and exchange the Print Head.*

<Note>

- *Make sure the color of the corresponding head tube is clear.*
- *Better to remove the Wiper Cleaner Cassette first before replacing Print Head. Otherwise the space is narrow and the edge of the cassette may hit and seriously damage the Print Head.*

(10) Turn up the appropriate flat cable connector tab, and then disconnect the flat cable.

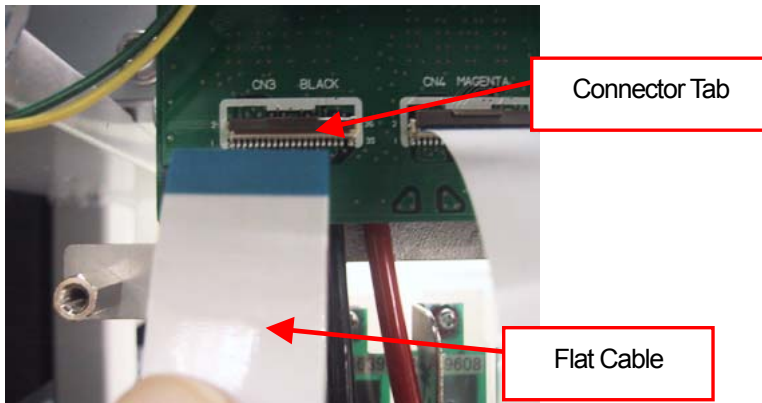
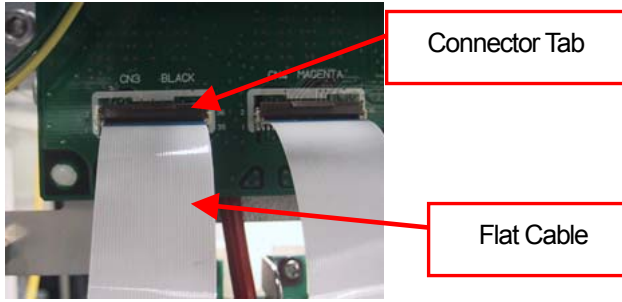

(11) Wear the gloves included with the new Print Head, and then remove the tube fitting from the new Print Head.

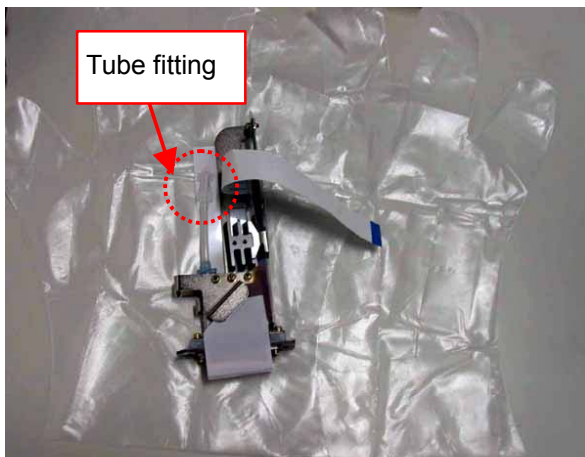

7. Troubleshooting

(12) Rotate the tube connector 90 degrees as shown below.

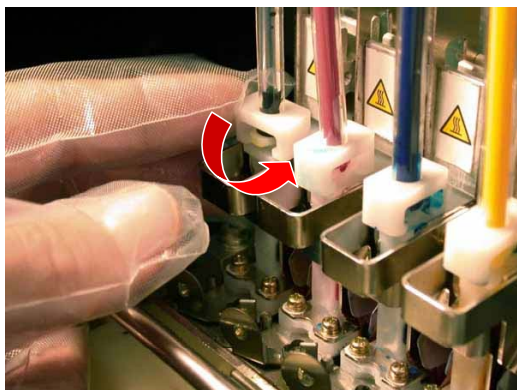

(13) Disconnect the tube and put the tube fitting removed from the new Print Head to prevent the ink from coming out.

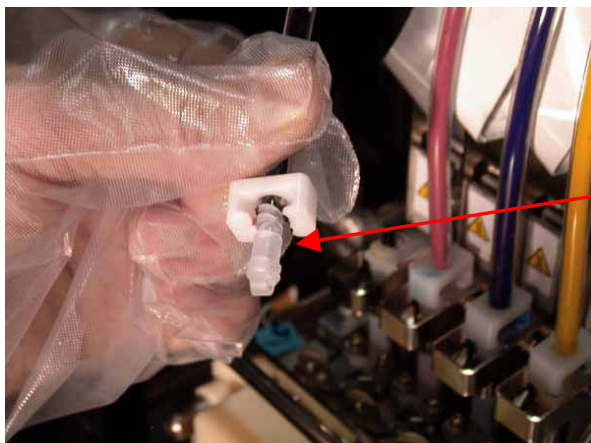

(14) Turn the lever to the direction of the arrow to unlock the Print Head.

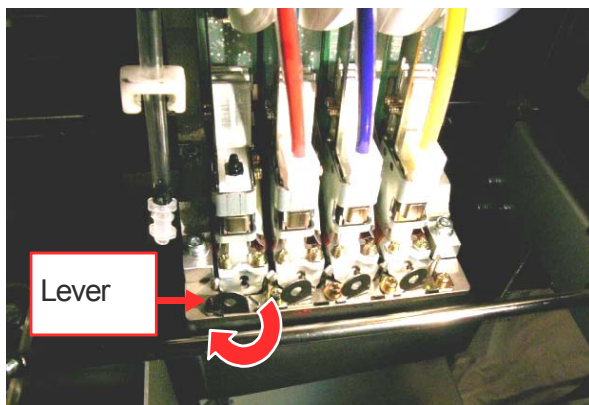

(15) Take off your gloves and remove the used Print Head by lifting up the knob.

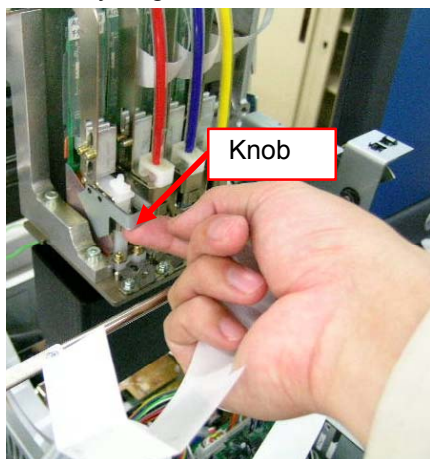

- (16) Remove the Protective Tube from the new Print Head, and then install the new Print Head by holding the knob, and holding the flat cable with the other hand. Make sure the V-shaped groove of the Print Head hits the pin.

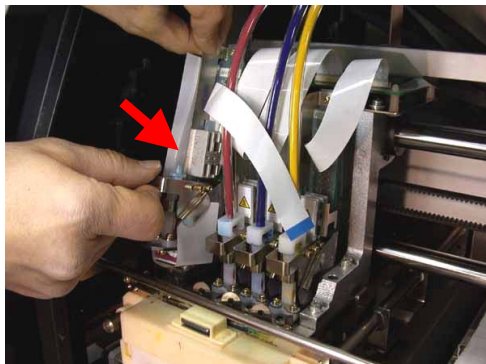
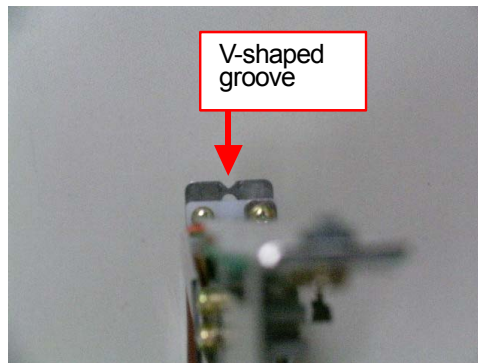
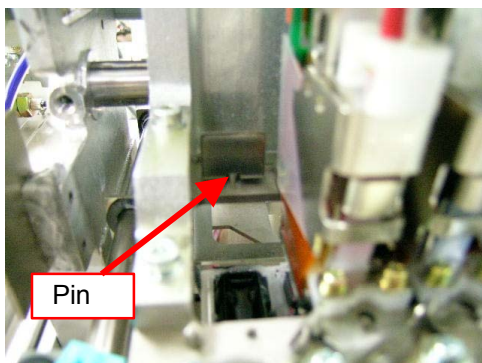
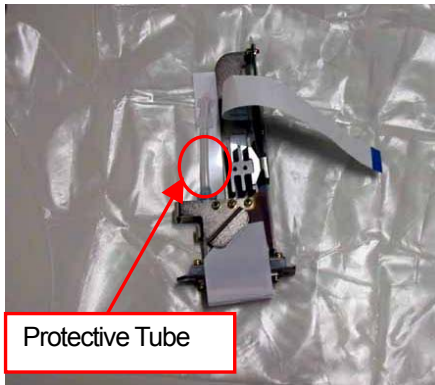

- (17) Press down the Print Head knob securely and push in the Print Head backward to align the Print Head properly.



7. Troubleshooting

(18) Turn the lever to the direction of the arrow to lock the Print Head.

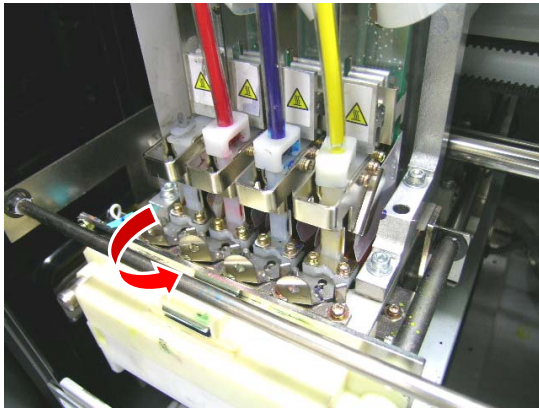

(19) Remove the Nozzle Protection Seal by pulling it up.



(20) Take off the gloves, insert the flat cable into the connector, and then turn down the connector tab to lock the cable.

<Note>

- Make sure the flat cable is inserted straight against the connector. If not, reconnect it correctly.
- The flat cable is very fragile. Be careful with handling it.

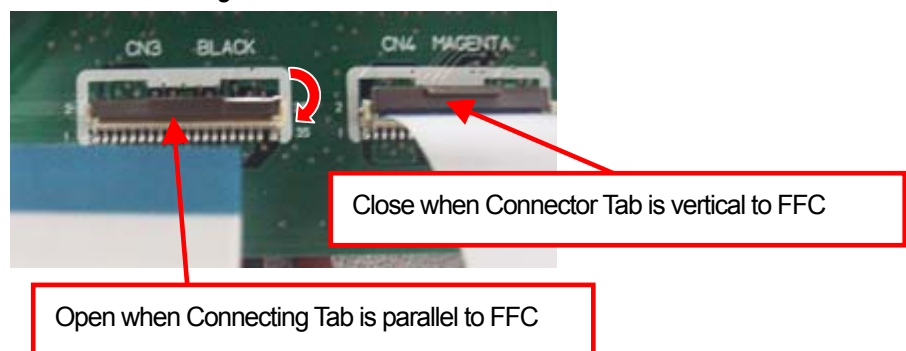

(21) Put on your gloves again, and then remove the tube fitting from the end of tube.



(22) Insert the tube into the new Print Head, and then rotate the tube connector 90 degrees to the direction of the arrow.

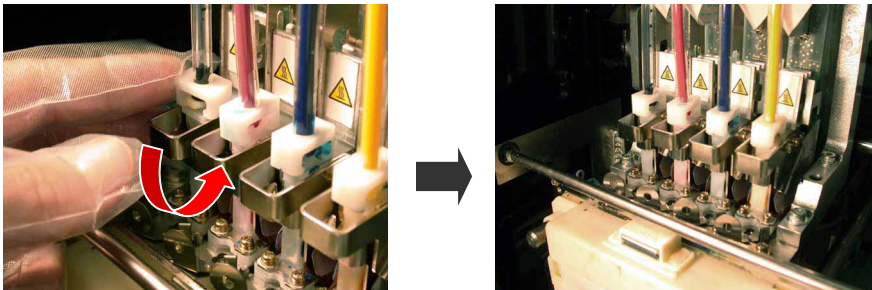

(23) Put the Wiper Cleaner Cartridge back to the position and close the Front Cover.

(24) Remove the Filter Cartridge, and then install the Ink Cartridge for CMYK and the Maintenance Solution for White which are previously removed.

(25) Turn on your printer.

(26) Press the Platen Button to eject the Platen.

(27) Press the OK Button to open the Menu Display.

(28) Press the Up/Down Button to select "Maintenance", and then press the OK Button.



(29) Press the Up/Down Button to select "Initial Cleaning" mode, and then press the OK Button.

7. Troubleshooting

- (30) Press the Up/Down Button to select the color of the Print Head you have replaced, and then press the OK Button.
The following message appears, and the initial cleaning starts.

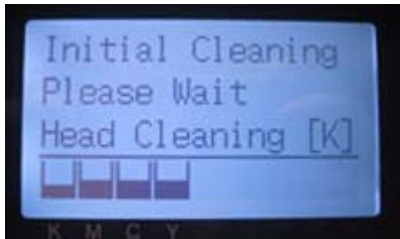

The display returns to the Print Head color-selecting display, when the initial cleaning has been completed.

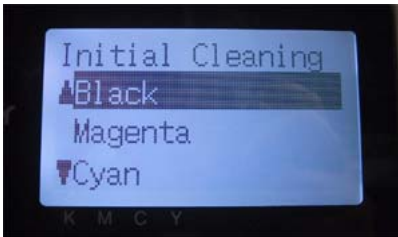

- (31) When replacing the White Print Head, select "Load White" and load the White Ink. See "6-1-3. Loading / Retrieving White Ink".
(32) Print and check the Nozzle Check Pattern (see "7-2-3. Checking Print Quality with Nozzle Check Pattern ") if the replaced Print Head works.
(33) Print the Standard Check Pattern to check the alignment if the Print Head is placed properly.

<Note>

If the Print Heads do not align properly, the printer cannot make correct colors. See the example below: Cyan Print Head does not align (shifted forward). Check (17) and (18) in former page.

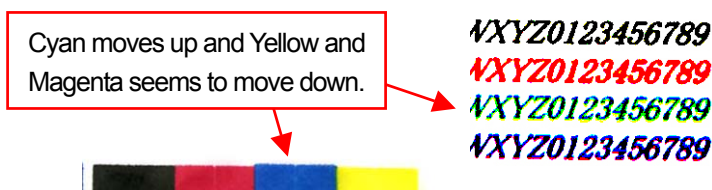

- (34) If the quality is OK go on to the next section "7-2-8. Adjustment after the Print Head has been replaced" to complete the adjustment after the Print Head replacement.
If you still see the problem in print quality, contact your Brother dealer for assistance.

7-2-8. Adjustment after the Print Head has been replaced

If the printed image is unclear then the print head timing may need to be adjusted.

- (1) Make sure your printer is connected to your PC with USB 2.0 cable.
- (2) Prepare some sheets of paper and tapes to fix on the Platen.
- (3) Execute GT-782 Maintenance in Brother GT-Tools.
Follow the instruction dialogs.



- (4) Adjust the firing timing of left/right Print Heads on the left/right Platens. Select "Firing Adjustment" and click "Next". Follow the steps.

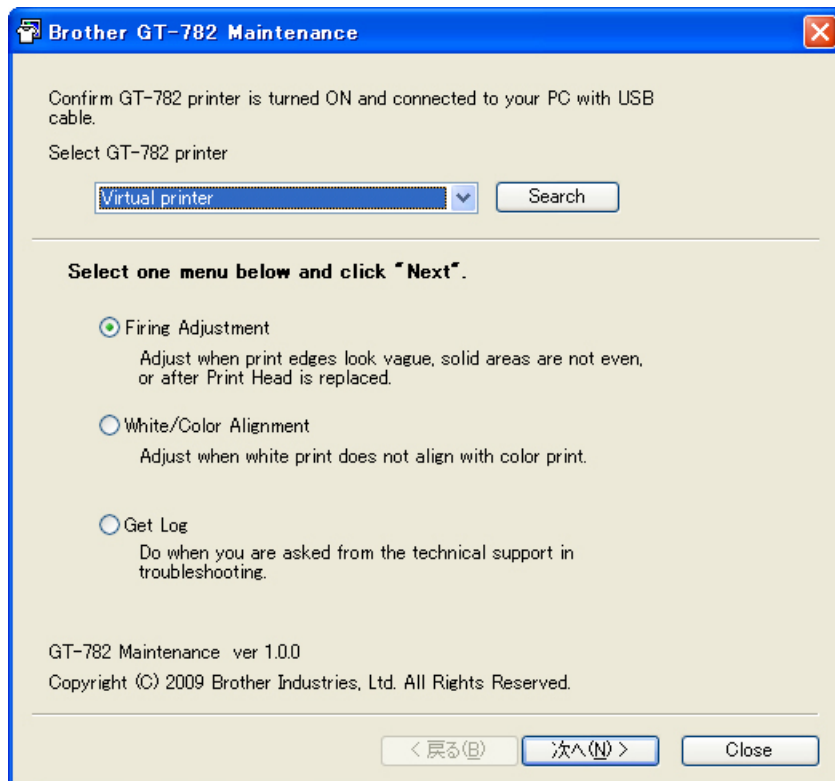

- (5) The dialog goes back to the main menu after finishing the firing adjustment. Then adjust the alignment between the White print data and Color print data. Select "White/Color Alignment" and click "Next". Follow the steps.

7-2-9. Replacing the Wiper Blade

The Wiper Blade needs to be replaced periodically because it is worn out, to solve the ink jetting problem. Use the Wiper ASSY (sold separately) for the replacement.

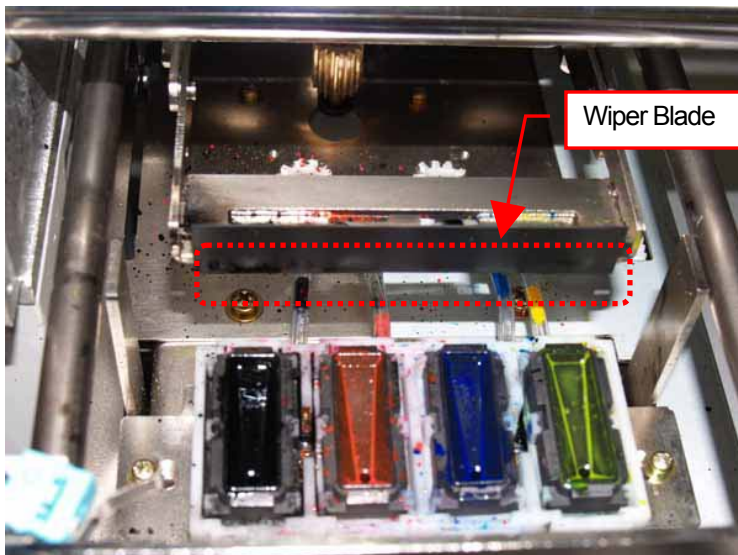

- (1) Turn on your printer if it is off.
- (2) Press the OK Button to open the Menu Display.
- (3) Press the Up/Down Button to select the "Maintenance", and then press the OK Button.

7. Troubleshooting

- (4) Press the Up/Down Button to select the "Cap/Wiper Clean", and then press the OK Button.
The following message appears.



- (5) Turn off your printer.
(6) Open the Front Cover with both hands after unlocking the cover locks and slide the Latch to fix the Front Cover.

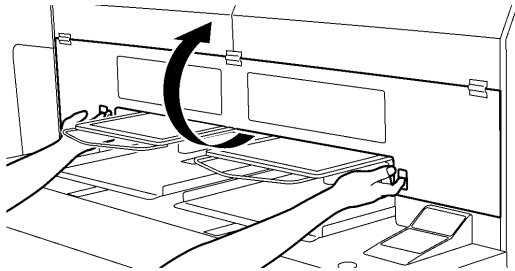

4325M

- (7) Pull out the Wiper Cleaner Cassette.

<Note>

Do not tilt the Wiper Cleaner Cassette; ink may get on your hands or clothing.

Do not touch the Clearance Sensor (the bar above the Wiper Cleaner Cassette); it may cause a malfunction.

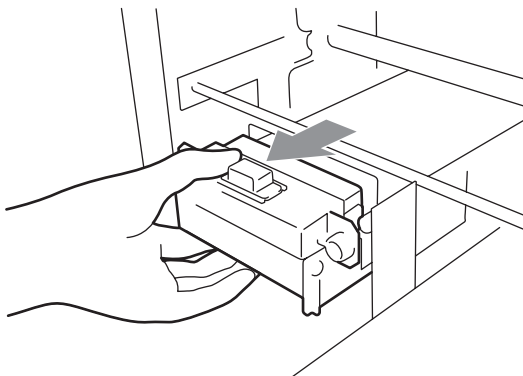

- (8) Open the Wiper Replacing Kit and put on the gloves.

(Continued on the next page)

- (9) Push the right Operation Arm about 5 mm (0.2 inches) to the right and pull out the Wiper Blade as holding its left.

<Note>

Do not push the Operation Arm by force.

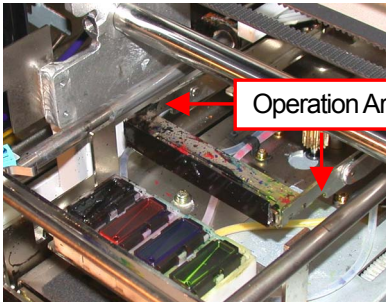

7. Troubleshooting

(10) Remove the Wiper Blade by pulling it to the left.

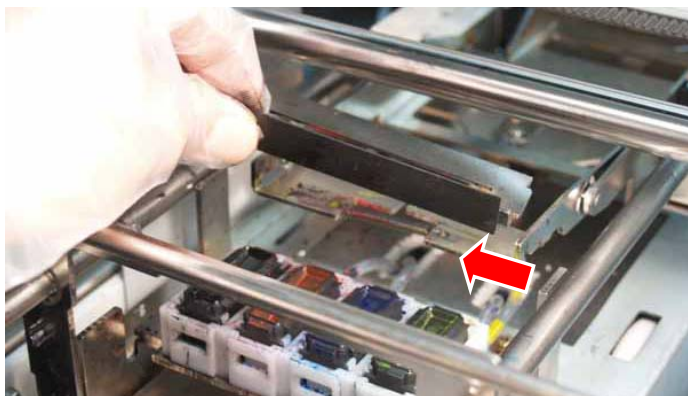

(11) Insert the left projection of the new Wiper Blade to the slit of the left Operation Arm.

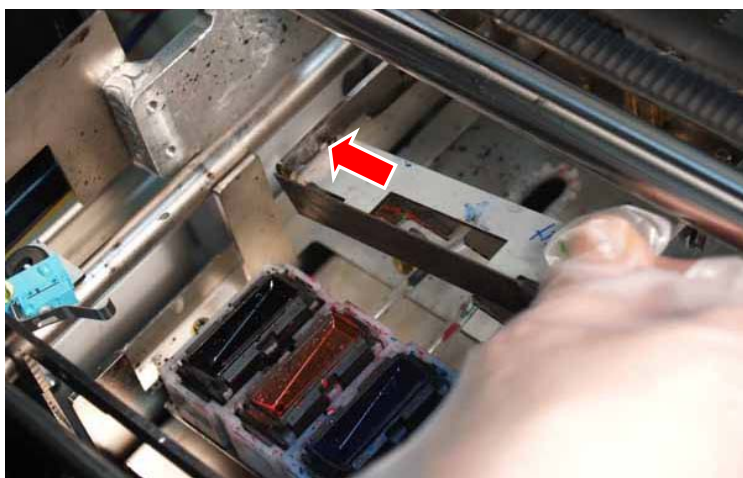
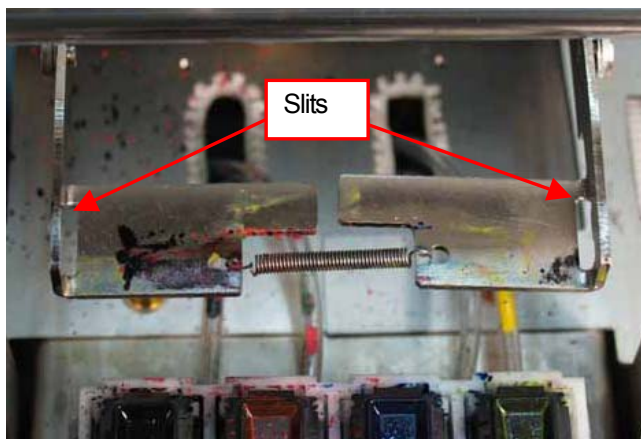
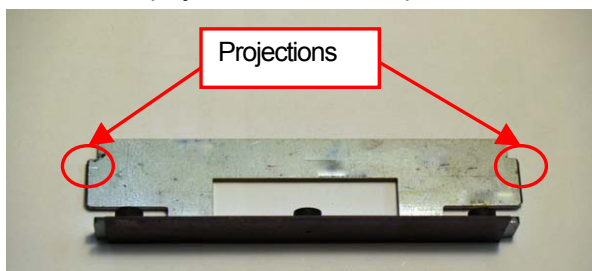

- (12) Insert the right projection of the new Wiper Blade to the slit of the right Operation Arm by pushing the right Operation Arm about 5 mm (0.2 inches) to the right.

<Note>

Do not push the Operation Arm by force. It may be distorted.

Take care not to push down the Wiper Blade and the Operation Arms by force. They can be easily damaged.

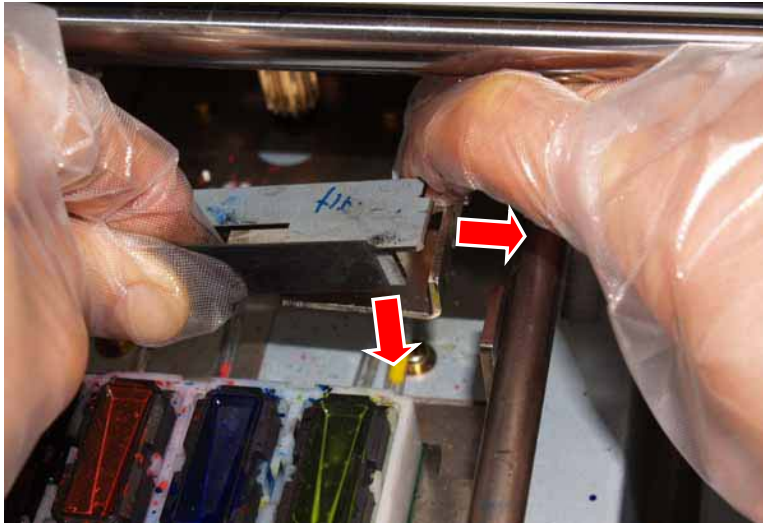

- (13) Confirm that both projections of the Wiper Blade are inserted to the slits of the Operation Arms.



- (14) Insert the Wiper Cleaner Cassette straight into your printer.

<Note>

Do not touch the Clearance Sensor (the bar above the Wiper Cleaner Cassette);

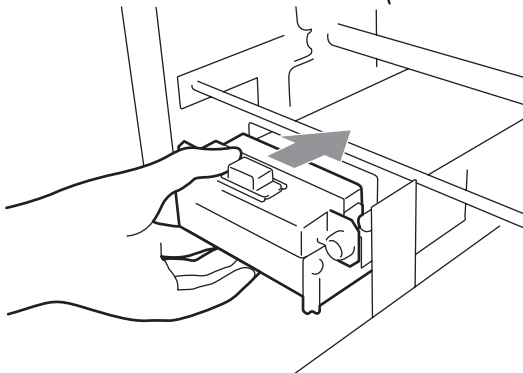

- (15) Close the Front Cover, and then turn on your printer.

If your printer turns on without any problem, replacement of the Wiper Blade has been completed.

If there is problem (such as abnormal noise or an error)then turn off your printer, and check if the Wiper Blade, the Wiper Cleaner and the Wiper Cleaner Cassette are correctly installed.

7. Troubleshooting

7-2-10. Setting Extra Wipe

When you print under the hot and dry condition, sometimes the printer can not keep the print quality. We recommend using a humidifier. To increase the wiping time in printing can improve the print quality. This setting can be done separately (CMYK / White).

- (1) Make sure your printer is in either "Standby" or "Ready" modes.
- (2) Press the OK Button to open the Menu Display.
- (3) Press the Up/Down Button to select the "Maintenance", and then press the OK Button.
- (4) Press the Up/Down Button to select the "Extra Wipe Set", and then press the OK Button.

The following message appears.

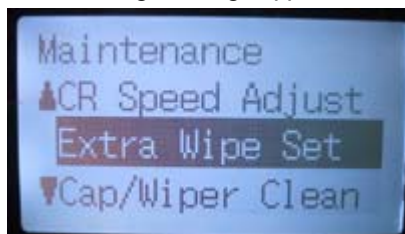

- (5) Normal setting is "52 lines". Select either "Every 20 lines" or "Every 10 lines".

7-3. Solving Application Problems

See also the pages of each application software in "4. Printing Directly from Applications".

Problem	Cause	Solution
<i>The image sent from Adobe Illustrator 10 is printed 90 degree rotated.</i>	<i>The Print Setup or Document Setup is not appropriate.</i>	<i>In Adobe Illustrator 10 follow the instruction below, and then try to send the print data again:</i> (1) Open "Print Setup" in the "File" menu. (2) Select GT-782 as the printer, and then click "OK". (3) Open "Document Setup" on "File" menu. (4) Check "Use Print Setup". (5) Confirm the "Orientation", "Width" and "Height". If they are not appropriate, correct them, and then click "OK".
<i>The image sent from Adobe Illustrator CS is printed 90 degree rotated.</i>	<i>The Print Setup or Document Setup is not appropriate.</i>	<i>With Adobe Illustrator CS, landscape image may not be printed properly. Correct the setting following the instruction below, and then try to send the print data again:</i> (1) Open "Print" in the "File" menu. (2) Confirm that the Media Size is "Defined by Driver". (3) Change the Media Orientation to the portrait. (4) If you are not changing the Platen size, skip to step (8). If you want to change the Platen Size, click "Setup...", and then click "Continue". Print window appears. (5) Click "Preference". (6) Change the Platen Size in the Printer Driver Window, and then click "OK". (7) Click "Print" in the Print window. (8) Confirm the preview, and then click "Print" to send the data to your printer.
<i>The Platen Size setting changes to Platen 10 x 12 (this happens especially when printing the image smaller than 14 x 16 inches).</i>	—	<i>Check the Platen Size in the Printer Driver window before you send the print data to your printer.</i>
<i>The image sent from Adobe Illustrator cannot be printed on proper position, or it cannot be sent and result in errors.</i>	—	<i>See "4-2-4. Setting for Adobe Illustrator".</i>
<i>There are some Properties windows shown in Photoshop. When the values of Printing Preferences in Windows are set beforehand and you modified the values from the printer driver Properties window of Photoshop, mismatching information appears among different dialog boxes.</i>	—	<i>The setting in the Properties of the Print window is applied.</i>
<i>It take long to make print data in Adobe Photoshop CS2/CS3</i>	—	<i>CS2 and CS3 use lots of PC memories in executing and it may take more time to make print data compared with the former versions. Check your PC specifications.</i>
<i>In CorelDRAW 12 and 11, sometimes outlines of warped artwork cannot be printed.</i>	—	<i>Upgrade CorelDRAW to X3 or higher.</i>

7. Troubleshooting

7-4. Error Messages

Here is a complete list of error messages that GT-782 shows. The "L" on the Display means error(s) in the left and "R" means error(s) in the right. When mark ** is in Solution, write down the error code number and the message, and then make contact to your dealer or Brother. Error codes of Warnings (#1xxx) are only written in Log file.

Error code	Message	Meaning	Solution
1000	(INK LOW Black)	Black ink level is too low.	Prepare a new Black ink cartridge.
1000	(INK LOW White-1)	White 1 ink level is too low.	Prepare a new White ink cartridge.
1001	(INK LOW Magenta)	Magenta ink level is too low.	Prepare a new Magenta ink cartridge.
1001	(INK LOW White-2)	White 2 ink level is too low.	Prepare a new White ink cartridge.
1002	(INK LOW Cyan)	Cyan ink level is too low.	Prepare a new Cyan ink cartridge.
1002	(INK LOW White-3)	White 3 ink level is too low.	Prepare a new White ink cartridge.
1003	(INK LOW Yellow)	Yellow ink level is too low.	Prepare a new Yellow ink cartridge.
1003	(INK LOW White-4)	White 4 ink level is too low.	Prepare a new White ink cartridge.
1021	Wp-Blade Life	The Print Head Wiper Blade needs to be replaced.	See "7-2-9. Replacing the Wiper Blade" and replace to a new one.
1051	CR Motor Life	The Carriage Motor is worn.	**
1060	Temp Low: xxx °F	The ambient temperature is below the range that maintains the print quality. "xxx" is the current temperature.	Raise the room temperature.
1061	Temp High: xxx °F	The ambient temperature is above the range that maintains the print quality. "xxx" is the current temperature.	Drop the room temperature.
1070	Battery Life	The battery ran out.	**
1080	RTC not Adjusted	The internal clock has not been set.	**
1090	Caps/Wiper Clean	Needs to clean Caps and Wiper	Clean the Print Head Caps and Wiper.
1111	Clean Tube W1	W1 needs to do Tube Cleaning.	Execute Tube Cleaning W1.
1112	Clean Tube W2	W2 needs to do Tube Cleaning.	Execute Tube Cleaning W2.
1113	Clean Tube W3	W3 needs to do Tube Cleaning.	Execute Tube Cleaning W3.
1114	Clean Tube W4	W4 needs to do Tube Cleaning.	Execute Tube Cleaning W4.
2000	NO INK Black	Black Ink Cartridge is not installed.	Install a Black Ink Cartridge.
2000	NO INK White-1	White 1 Ink Cartridge is not installed.	Install a White Ink Cartridge.
2001	NO INK Magenta	Magenta Ink Cartridge is not installed.	Install a Magenta Ink Cartridge.
2001	NO INK White-2	White 2 Ink Cartridge is not installed.	Install a White Ink Cartridge.
2002	NO INK Cyan	Cyan Ink Cartridge is not installed.	Install a Cyan Ink Cartridge.
2002	NO INK White-3	White 3 Ink Cartridge is not installed.	Install a White Ink Cartridge.
2003	NO INK Yellow	Yellow Ink Cartridge is not installed.	Install a Yellow Ink Cartridge.

Error code	Message	Meaning	Solution
2003	NO INK White-4	White 4 Ink Cartridge is not installed.	Install a White Ink Cartridge.
2020	EMPTY Black	Black Ink Cartridge ran out of ink.	Replace to a new Black Cartridge.
2020	EMPTY White-1	White 1 Ink Cartridge ran out of ink.	Replace to a new White Cartridge.
2021	EMPTY Magenta	Magenta Ink Cartridge ran out of ink.	Replace to a new Magenta Cartridge.
2021	EMPTY White-2	White 2 Ink Cartridge ran out of ink.	Replace to a new White Cartridge.
2022	EMPTY Cyan	Cyan Ink Cartridge ran out of ink.	Replace to a new Cyan Cartridge.
2022	EMPTY White-3	White 3 Ink Cartridge ran out of ink.	Replace to a new White Cartridge.
2023	EMPTY Yellow	Yellow Ink Cartridge ran out of ink.	Replace to a new Yellow Cartridge.
2023	EMPTY White-4	White 4 Ink Cartridge ran out of ink.	Replace to a new White Cartridge.
2040	No Wiper Cleaner	The Wiper Cleaner Cassette is not installed.	Install the Wiper Cleaner Cassette.
2050	Temp Low: xxx °F	The ambient temperature is under the operative temperature rage. "xxx" shows the current temperature.	Raise the room temperature.
2051	Temp High: xxx °F	The ambient temperature is over operative temperature rage. "xxx" is the current temperature.	Drop the room temperature.
2062	-	(1) Platen didn't return to the home position because Platen Motor stepped out. Or (2) Platen Org Sensor did not work while Platen returned correctly.	**
2070	OBSTACLE SENSED Push OK, Unload	GT-782 detected an obstacle on the Platen (or the media) when printing is started.	Remove the obstacle, flat the platen surface and then press OK Button.
2080	Sys Wrt Fault	Defect in FLASH ROM Check Sum on the SH side. When updating the firmware, no backup was made because of the defect of the current firmware.	**
2090	Not Initiated	No individual information (the serial number etc.) is recorded in GT-782.	**
2091	Fail: Head Temp	The Print Head temperature is raised too high while printing.	Wait until the head(s) cool down. Or contact Brother Customer Service Hot Line.
2092	Fail: Head Temp K		
2092	Fail: Head Temp W1		
2093	Fail: Head Temp M		
2093	Fail: Head Temp W2		
2094	Fail: Head Temp C		
2094	Fail: Head Temp W3		
2095	Fail: Head Temp Y		
2095	Fail: Head Temp W4		
2100	Card Not Ready Push OK Button		

7. Troubleshooting

Error code	Message	Meaning	Solution
2101	Not Enough Area	The Compact Flash does not have enough area for storing logs.	Check the free space of the Compact Flash with PC. Insert a Compact Flash with free area available.
2102	Card Access Error	Failure in file reading / writing	Push OK Button to escape menu and re-enter Compact Flash. Or see "7-1. Solving Printer Problems".
3000	PC Comm. Error Send data again	GT-782 failed to receive the print data (time out). This error occurs when the USB cable is disconnected during data transmission, or data transmission is canceled on the PC.	Check the connection between the PC and GT-782, and send print data again. If it has no effect, reboot both the PC and GT-782.
3001	-	The PC will not receive the data sent from GT-782 (transmission buffer overflow).	**
3002	PC Data Error	GT-782 received the data that is not supported.	Check the connection between the PC and GT-782, and send print data again. Or reboot both the PC and GT-782. Contact your dealer or Brother .
3003	PC Data Error	No compatibility of communication command between the PC driver and the GT-782 firmware. The versions of the PC driver and the GT-782 firmware do not correspond.	
3004	PC Data Error	The Check Sums of the received program data did not correspond when updating the firmware.	
3005	PC Data Error	The Check Sums of the received data did not correspond when updating EEPROM.	Reboot and update GT-782 again. Contact your dealer or Brother .
3006	Received NG Data	GT-782 received the data that is not supported, or the data transmission from the PC to GT-782 is interrupted in an inappropriate way. The data transmission might be made from the PC to GT-782 by using a printer driver not for GT-782.	Check the printer setting of the PC. Check the connection between the PC and GT-782 and send print data again.
3007	PC Data Error	GT-782 received a job in which commands are arranged improperly.	Reboot GT-782 and send print data again. Contact your dealer or Brother These errors might happen when GT-782 malfunctions by environmental reasons. If the error does not show, the printer is available.
3008	PC Data Error	The Check Sums of the received commands did not correspond.	
3009	PC Data Error	GT-782 received a command that is not supported.	
3010	PC Data Error	A maintenance command is mixed in normal jobs.	
3011	PC Data Error	Non-command data is mixed.	
3012	PC Data Error	The Check Sums of the received jobs did not correspond.	
4000	PC Data Error	GT-782 received the data that is not supported from the PC.	Reboot GT-782 and send print data again. Contact your dealer or Brother . These errors might happen when GT-782 malfunctions by environmental reasons. If the error does not show, the printer is available.
4001	PC Data Error		
4002	PC Data Error		
4003	PC Data Error		

Error code	Message	Meaning	Solution
4004	PC Data Error	GT-782 received the data that is not supported from the PC.	Reboot GT-782 and send print data again. Contact your dealer or Brother . These errors might happen when GT-782 malfunctions by environmental reasons. If the error does not show, the printer is available.
4005	PC Data Error		
4006	PC Data Error		
4007	Blank Data	GT-782 received blank print data from the PC. This error unintentionally occurs when the print data is simply white design (object or image), and when paper size of application is too small and the design is out of range, etc.	Check the print data with GT File Viewer. Check the print range set in the application on the PC. Check the "Print with Preview" screen in e.g. PhotoShop 7.0.
4008	PC Data Error	GT-782 received a print job that is improperly large in data size.	Reboot GT-782 and send print data again. Contact your dealer or Brother .
4009	PC Data Error	GT-782 received a print job in which commands are arranged improperly.	These errors might happen when GT-782 malfunctions by environmental reasons. If the error does not show, the printer is available.
4011	DT:ILGL MNT SEQ	Maintenance sequence data error	**
4020	PC Data Error	The received update program file is not for SH.	Reboot GT-782 and update firmware again. Contact your dealer or Brother .
4021	PC Data Error	The received update program file is not for BY.	
4022	PC Data Error	The received update program file is not for H8.	
4100	Card Access Error	The file cannot be opened.	Check the contents in the Compact Flash. Push OK Button to escape menu and re-enter Compact Flash. Or see " 7-1. Solving Printer Problems".
4101	Card Access Error	No file can be created.	**
4102	Card Access Error	The file cannot be closed.	Check the contents in the Compact Flash. Push OK Button to escape menu and re-enter Compact Flash. Or see " 7-1. Solving Printer Problems".
4103	Card Access Error	Failure in file seeking	
4104	Card Access Error	Failure in file reading	
4105	Card Access Error	Failure in file writing	**
4106	Card Access Error	File error	Check the contents in the Compact Flash.
4107	Card Access Error	File size error	
4108	Card Access Error	Failure in file size acquisition	Check the contents in the Compact Flash.
4109	No Files	Failure in file search	Check the contents in the Compact Flash. See " 7-1. Solving Printer Problems".
4110	No Files	No file is found.	Check the contents in the Compact Flash. Move ARP files out of the folder to the root folder.
4200	Language Error	Error in program of selected language	Update firmware again. Contact your dealer or Brother .

7. Troubleshooting

Error code	Message	Meaning	Solution
4201	Language Error	Error in program of selected language	Update firmware again. Contact your dealer or Brother .
4202	Language Error		
5000	Machine Error or SHBY: Send MSG TO	Communication error inside the firmware.	**
5001	Machine Error or SHBY:Recv MSG TO	Communication error inside the firmware.	**
5002	Machine Error or SHBY:ILGL MSG	Communication error inside the firmware.	**
5003	Machine Error or SHBY:ILGL MSGID	Communication error inside the firmware.	**
5004	Machine Error or SHBY:ILGL MSGLEN	Communication error inside the firmware.	**
5005	Machine Error or SHBY:CHECKSUM	Communication error inside the firmware.	**
5010	SHBY:BY INIT TO1	Communication error inside the firmware.	**
5011	SHBY:BY INIT TO2		
5012	SHBY:BY INIT TO3		
5020	Machine Error	Communication error inside the firmware.	**
5021	Machine Error		
5030	Machine Error		
5031	Machine Error		
5032	Machine Error	Communication error inside the firmware.	**
5033	Machine Error		
5034	Machine Error		
5035	Machine Error		
5036	Machine Error		
5080	BYSH: Send MSG TO	Communication error inside the firmware.	**
5081	BYSH:ILGL MSGID	Communication error inside the firmware.	**
5082	BYSH:ILGL MSGLEN		
5083	Machine Error or BYSH: CHECKSUM	Communication error inside the firmware.	**

Error code	Message	Meaning	Solution
5090	BYSH: Cap On TO	Cap opening request time-out (Cap opening completion message did not return within the predetermined time after sending the Cap opening request.)	**
5091	BYSH: Cap Off TO	Cap closing request time-out (Cap closing completion message did not return within the predetermined time after sending the Cap closing request.)	
5092	BYSH: WP FWD TO	Wipe (outward) command request time-out	
5093	BYSH: WP BWD TO	Wipe (homeward) command request time-out	
5094	BYSH: PLT LD TO	Platen loading request time-out	**
5095	BYSH: PLT UNLD TO	Platen unloading request time-out	
5096	BYSH: PLT LF TO	LF time-out	
5097	BYSH: CRG ORG TO	-	**
5098	BYSH:ILGL PLT NO	Defect in the Platen number from SH	
5099	BYSH:ILGL SIZE X	Defect in the Platen information from SH (x)	**
5100	BYSH:ILGL SIZE Y	Defect in the Platen information from SH (y)	
5101	BYSH:ILGL OFFSET	Defect in the scan print area from SH	**
5102	Machine Error	Time-out of sending print data from SH	
5200	SHMN: Response TO	Time-out of waiting for the Maintenance Unit response	**
5201	SHMN:ILGL RSP	Error in the Maintenance Unit response format	
5210	-	Received an error response from the Maintenance Unit.	**
5211	MNT RSP Error: XX	Received an error response from the Maintenance Unit while purging.	
5212	MNT RSP Error: XX	Received an error response from the Maintenance Unit while initializing.	
5213	MNT RSP Error: XX	Received an error response from the Maintenance Unit while printing.	
5214	MNT RSP Error: XX	Received an error response from the Maintenance Unit while wiping.	
5215	MNT RSP Error: XX	Received an error response from the Maintenance Unit while operating the Cap.	**
5216	MNT RSP Error: XX	Received an error response from the Maintenance Unit while initializing the Wiper Cleaner Cartridge after mounting it.	
5217	MNT RSP Error: XX	Received an error response from the Maintenance Unit while canceling purging.	

7. Troubleshooting

Error code	Message	Meaning	Solution
5218	MNT RSP Error: XX	An overrun, framing error or parity error has occurred.	**
5219	MNT ILGL VERSION	The Maintenance version is too old.	**
5220	Error: RSP10	Received an error response from the Maintenance Unit while measuring negative pressure.	**
5221	MNT RSP Error: XX	Received an error response from the Maintenance Unit while updating the firmware.	**
5222	MNT RSP Error: XX	Received an error response from the Maintenance Unit while re-initializing after inserting the Wiper Cleaner Cassette.	**
5300	SHSH:INIT TIMEOUT	Timeout of the other SH in initialization failure	**
6000	Fail: PLTN Load	Platen loading error	**
6001	Fail: PLTN Unload	Platen unloading error	
6002	Fail: PLTN LF	Platen moving error	**
6003	Fail: PLTN Put in	Platen moving error	**
6004	Fail: CLRNS SNSR	Clearance sensor error	**
6010	Fail: SH EEP WRT	Failure in writing to EEPROM of SH	
6011	Fail: SH FLSH ERS	Failure in clearing FLASH ROM of SH	
6012	Fail: SH FLSH WRT	Failure in writing to FLASH ROM of SH	
6013	Fail: SH FLSH CHK	Defect in FLASH ROM Check Sum of SH.	
6014	Fail: SH RAM Test	Defect in RAM check of SH	
6020	Fail: RTC Read	Defect in the real time clock	
6021	Fail: No Battery.	Battery exhaustion of the real time clock	
6031	Fail: Panel Button	Platen Button may be malfunctioning.	
6032	Fail: Panel Button	Print Button may be malfunctioning.	
6033	Fail: Panel Button	The Stop Button may be malfunctioning.	Check whether something is placed on the Control Panel. Contact your dealer or Brother .
6034	Fail: Panel Button	The Back Button may be malfunctioning.	
6035	Fail: Panel Button	The OK Button may be malfunctioning.	
6036	Fail: Panel Button	The Down Button may be malfunctioning.	
6037	Fail: Panel Button	The Up Button may be malfunctioning.	
6038	Fail: Panel Button	The Head Cleaning Button may be malfunctioning.	
6100	Fail: CRG Speed	Defect in the Carriage load (in the high level).	Clean the Carriage by referring to "7-2-9. Cleaning the Carriage shafts". If the cleaning has no effect, contact your dealer or Brother .
6101	Fail: CRG Move	An error occurred while moving the Carriage.	**

Error code	Message	Meaning	Solution
6102	Fail: CRG STOP 1	Failure in stopping the Carriage at the proper position	Check whether the media is jamming in the Carriage. Clean the Carriage by referring to "7-2-9. Cleaning the Carriage Shafts". If the cleaning has no effect, contact your dealer or Brother .
6103	Fail: CRG STOP 2	Failure in stopping the Carriage at the proper position (ASIC error)	**
6104	Fail: CRG STP PRT	CR time-out of the Carriage during printing	**
6105	Fail: CRG STP FLS	CR time-out of the Carriage during flashing	**
6110	Fail: BY EEP WRT	Failure in writing to EEPROM of BY	**
6111	Fail: BY FLSH ERS	Failure in clearing FLASH ROM of BY	**
6112	Fail: BY FLSH WRT	Failure in writing to FLASH ROM of BY	
6113	Fail: BY FLSH CHK	Defect in FLASH ROM Check Sum of BY	**
6114	Fail: BY RAM Test	Defect in RAM check of BY	**
6120	Fail: Head Temp K	Print Head temperature defect (K or W1)	**
6121	Fail: Head Temp M	Print Head temperature defect (M or W2)	
6122	Fail: Head Temp C	Print Head temperature defect (C or W3)	
6123	Fail: Head Temp Y	Print Head temperature defect (Y or W4)	
6134	Fail: Head VLTG	Print Head voltage defect	**
6150	Fail: Sur Temp	Ambient temperature sensor defect	**
6200	Fail: MNT Cap Drv	The operation stopped because the Cap Driver has overheated.	**
6210	Fail: MNT Pump Drv	The operation stopped because the Pump Driver has overheated.	
6220	Fail: MNT Wipe Drv	The operation stopped because the Wipe Driver has overheated.	
6230	Fail: MNT INK-PCBA	The Maintenance Unit failed to communicate with the Ink Sensor A PCB.	**
6240	Fail: MNT INK-PCB	The Maintenance Unit failed to communicate with either Ink Sensor A or Ink Sensor B PCB.	**
7000	PRG: SH SCER 1508	Carriage initialization failed.	**
	PRG: SH SCER 1757	Reading EEPROM Timeout (BY)	
	PRG: SH SCER 1788	Writing EEPROM Timeout (BY)	
	PRG: SH SCER XXXX	Communication timeout (SH to BY)	
7001	PRG: SH Exception	Error inside the program (Exceptionally occurs in CPU of SH)	**
7002	PRG: SH ILGL TMR	Error inside the program (Incorrect timer setting of SH)	**
7010	PRG: SH ILGL Arg	Error inside the program (Argument defect of SH)	**
7011	PRG: SH ILGL RTN	Error inside the program (Returning value defect of SH)	**

7. Troubleshooting

Error code	Message	Meaning	Solution
7012	PRG: SH Event TO	Error inside the program (Time-out of waiting for the vent/message of SH)	**
7013	PRG: SH Internal	Error inside the program (General program error of SH)	**
7100	PRG: BY SYSCALL	Error inside the program (System call error of BY)	**
7101	PRG: BY Exception	Error inside the program (Exceptionally occurs in CPU of BY)	**
7110	PRG: BY ILGL Arg	Error inside the program (Argument defect of BY)	
7111	PRG: BY ILGL RTN	Error inside the program (Returning value defect of SH)	
7112	PRG: BY Event TO	Error inside the program (Time-out of waiting for the vent/message of BY)	
7120	PRG: BY CRG Mode	Error inside the program (Mode for optimizing the undefined Print Head movement)	**
7121	PRG: BY No Line	Error inside the program (Error in the number of print lines (0 line))	**
7122	PRG: BY Line Over	Error inside the program (Error in the number of print lines (too many))	
7123	PRG: BY ILGL Cmd	Error inside the program (Commands other than CR/LF)	
7124	PRG: BY ILGL Dir	Error inside the program (Undefined print direction)	
7125	PRG: BY Too near	Error inside the program (Moving error: It is too close to move.)	**
7126	PRG: BY ILGL Mode	Error inside the program (Undefined print mode)	
7199	PRG:BY Internal	Internals error (general error defect of SH)	**
9001	LVDS: CHECK SUM NG	LVDS internal PCB comm. error (LVDS send check sum mismatch received)	**
9002	LVDS: ERROR STATUS	LVDS internal PCB comm. error (LVDS send error status received)	**
9003	LVDS: BUSY STATUS	LVDS internal PCB comm. error (LVDS send busy status received)	**
9012	LVDS: SND TIMEOUT2	LVDS internal PCB comm. error (LVDS send timeout 2)	**
9014	LVDS: SND TIMEOUT4	LVDS internal PCB comm. error (LVDS send timeout 4)	**
9101	LVDS: RCV SUM ERR	LVDS internal PCB comm. error (LVDS receive packet checksum error)	**
9102	LVDS: RCV DATA ERR	LVDS internal PCB comm. error (LVDS received packet data error)	**
9103	LVDS: RCV TSK BUSY	LVDS internal PCB comm. error (LVDS receive cannot receive next with un-done command)	**
9104	LVDS: RCV DUP PAKT	LVDS internal PCB comm. error (LVDS receive same sequence No packet received)	**

Error code	Message	Meaning	Solution
9111	LVDS: RCV TIMEOUT1	LVDS internal PCB comm. error (LVDS receive timeout 1)	**
9113	LVDS: RCV TIMEOUT3	LVDS internal PCB comm. error (LVDS receive timeout 3)	**
9200	LVDS:SEND TIMEOUT	LVDS internal PCB comm. error (No packet sent)	**
9201	LVDS:RCV TIMEOUT	LVDS internal PCB comm. error (No packet received)	**
9300	LVDS:SLEEP MASTER	LVDS internal PCB comm. error (no notice of start received from master)	**
9301	LVDS:SLEEP SLAVE	LVDS internal PCB comm. error (no notice of start received from slave)	**
9302	LVDS:P-PKT SEQ NO	LVDS internal PCB comm. error (disorder sequence no of print data packet)	**
9303	LVDS:F-PKT SEQ NO	LVDS internal PCB comm. error (disorder sequence no of firmware packet)	**
9304	LVDS:L-PKT SEQ NO	LVDS internal PCB comm. error (disorder sequence no of log data packet)	**
9400	LVDS:RCV EXE ERR	LVDS internal PCB comm. error (received command execution failure response)	**

7. Troubleshooting

Error Messages of Maintenance Unit

Error code	Message	Meaning	Solution
CA	Cap Driver Overheat	The operation stopped because the Cap Driver has overheated.	**
CC	Wiper Cleaner Cassette error	Wiper Cleaner Cassette is coming off.	**
CE	Communication error	Communication error other than FE, OE and PE	**
CI	Cap initialization error	The Cap initialization was not made before moving the Cap.	**
CO	Cap error	The Cap was in the raised position when moving the Wiper.	**
CP	Cap Sensor error	Failure of the Cap Sensor or Cap Motor	**
FE	Data framing error	Serial communication/data framing error occurred.	**
IE	Internal error	Incorrect program behavior	**
OB	Cap obstacle error	An obstacle prevents the Cap from being raised.	**
OE	Data overrun error	Serial communication/buffer overrun occurred.	**
PA	Pump Driver Overheat	The operation stopped because the Pump Driver has overheated.	**
PE	Parity error	Serial communication/parity error occurred.	**
PI	Pump initialization error	The Pump initialization was not made before operating the Pump.	**
PN	The number of arguments is different.	The number of arguments is abnormal.	**
PS	Pump Sensor Error	Failure in the Pump sensor or Pump motor	**
RT	Response timeout	Time-out of waiting for the Maintenance Unit response	**
SH	Ink Sensor error	Failure in the Ink Sensor harness	**
SR	Ink Sensor error	Defect in the Ink Sensor reading	**
VC	Valve error	The valve is closed when moving the Cap.	**
VO	Valve error	The valve is open when operating the Pump.	**
WA	Wiper Driver Overheat	The operation stopped because the Wipe Driver has overheated.	**
WI	Wiper initialization error	The Wiper initialization was not made before moving the Wiper.	**
WS	Wipe Sensor error	Failure in the Wiper Sensor or Wiper Motor	**

8. Specifications

8-1. Mechanical Specification

<i>Dimensions</i>	<i>2662 (W) × 1141 (D) × 830 (H) mm (104.8 × 44.9 × 32.7 inch)</i>	
<i>Weight (GT-782 including Platen)</i>	<i>Approx. 230 Kg (507 lb)</i>	
<i>Maximum print area</i>	<i>16 x 18 inches (406.4 x 457.2 mm)</i>	
<i>Print Resolution</i>	<i>600 x 600 dpi</i>	
<i>Power source</i>	<i>Single-phase 100-230 V</i>	
<i>Power supply frequency</i>	<i>50/60 Hz</i>	
<i>Power consumptions</i>	<i>0.8 A (average)</i>	
<i>Mechanical noise</i>	<i>Lower than 70 dB</i>	
<i>Temperature and Humidity</i>	<i>For operation:</i>	<i>Temperature: 50 °F to 95 °F (10 °C to 35 °C) Humidity: 20 % to 85 % (no condensation)</i>
	<i>For optimum print result:</i>	<i>Temperature: 64 °F to 86 °F (18 °C to 30 °C) Humidity: 35 % to 85 % (no condensation)</i>
	<i>For storage:</i>	<i>Temperature: 32 °F to 95 °F (0 °C to 35 °C) Humidity: 20 % to 85 % (no condensation)</i>

8-2. Software Specification

<i>Supported OS</i>	<i>Latest Windows XP 32bit / Windows Vista (32 bit / 64 bit) / Windows 7 (32 bit / 64 bit)</i>
<i>Supported interface</i>	<i>USB 1.1/2.0, CompactFlash</i>
<i>Minimum system requirements</i>	<i>256 MB RAM (512 MB or more is recommended) 128 MB free disk space (256 MB or more is recommended) 1 GHz CPU</i>
<i>Recommended Applications for precise output</i>	<i>Adobe Photoshop, Adobe Photoshop Elements, Adobe Illustrator, CorelDRAW, Paint Shop Pro</i>

brother®

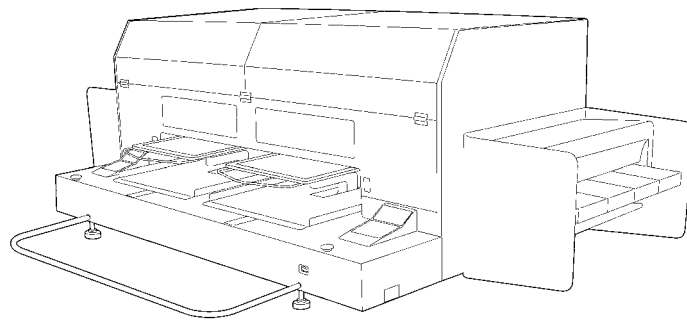

INSTRUCTION MANUAL

BROTHER INDUSTRIES, LTD. <http://www.brother.com/>
1-5, Kitajizoyama, Noda-cho, Kariya 448-0803, Japan. Phone: 81-566-95-0088

© 2009 Brother Industries, Ltd. All Rights Reserved.

GT-782
SB0304-101 E
2009.11. F (1)

Free Manuals Download Website

<http://myh66.com>

<http://usermanuals.us>

<http://www.somanuals.com>

<http://www.4manuals.cc>

<http://www.manual-lib.com>

<http://www.404manual.com>

<http://www.luxmanual.com>

<http://aubethermostatmanual.com>

Golf course search by state

<http://golfingnear.com>

Email search by domain

<http://emailbydomain.com>

Auto manuals search

<http://auto.somanuals.com>

TV manuals search

<http://tv.somanuals.com>