

OWNER'S MANUAL

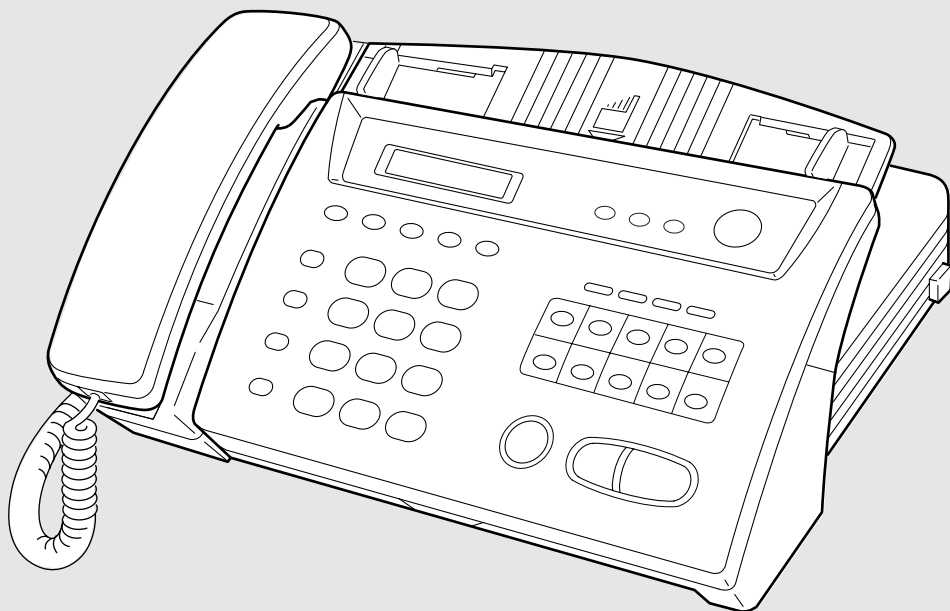

FAX 355MC

FAX 375MC

brother.

If You Need to Call Customer Service

Please complete the following information for future reference:

Model Number: FAX 355MC, FAX 375MC
(Circle your model number)

Serial Number:* _____

Date of Purchase: _____

Place of Purchase: _____

***The serial number is on the back of the unit. Retain this Owner's Manual with your *sales receipt* as a permanent record of your purchase, in the event of a theft, fire or warranty service.**

FAX 355MC is Available in CANADA Only

Brother Numbers

Fax-Back System

Brother Customer Service has installed an easy-to-use Fax-Back System, so you can get instant answers to common technical questions and product information for all Brother products. This system is available 24 hours a day, 7 days a week. You can use the system to send faxes to any fax machine, not just the one from which you are calling.

If you can't resolve a difficulty with your fax machine using this manual, call our Fax-Back System, and follow the voice prompts to receive faxed instructions about using the system and an index of Fax-Back subjects.

USA: 1-800-521-2846
From within Canada: 1-800-681-9838

The Brother Fax-Back System number (USA Only) has been preprogrammed on One Touch key **[01]**.

Brother on the World Wide Web

You can find more information about Brother products, from product specification sheets to Frequently Asked Questions (FAQs), on the World Wide Web. Visit us at

<http://www.brother.com>

Brother Bulletin Board

Brother's Bulletin Board Numbers are

USA: 1-888-298-3616
From within Canada: 1-514-685-2040

For Customer Service

USA: 1-800-284-4329 (voice)
1-908-575-8790 (fax)
From within Canada: 1-800-853-6660 (voice)
1-514-685-4898 (fax)
From within Montreal: 1-514-685-6464 (voice)

Ordering Accessories and Supplies

For best quality results use only genuine Brother accessories, available at most Brother retailers. If you cannot find the accessory you need and you have a Visa, MasterCard, Discover, or American Express credit card, you can order accessories directly from Brother. (In the USA, you can visit us online for a complete selection of Brother accessories and supplies available for purchase.

USA: 1-888-879-3232 (voice)
1-800-947-1445 (fax)
<http://www.brothermall.com>

From within Canada: 1-800-668-2768 (voice)

Description	Item
98' Therma Plus Paper "Feels like plain paper" (2 rolls per box)	6890
98' Therma Plus Paper "Feels like plain paper" (4 rolls per box)	6840
Original Document Catch Tray	CT-70
Document support	UF6820-000
Telephone Line Cord	UG1570001 (USA) UG3565001 (CANADA)
Telephone Handset	UF6857008
Handset Curled Cord	UG3543003
Owner's Manual for FAX 355MC/375MC	UF0839001
Optional Multi-Function Link®/Missing Link® software on floppy disks for Windows® 3.1x and Windows® 95/98	PCI-1

**Notice – Disclaimer of Warranties
(For USA and Canada)**

BROTHER'S LICENSOR(S), AND THEIR DIRECTORS, OFFICERS, EMPLOYEES OR AGENTS (COLLECTIVELY BROTHER'S LICENSOR) MAKE NO WARRANTIES, EXPRESS OR IMPLIED, INCLUDING WITHOUT LIMITATION THE IMPLIED WARRANTIES OF MERCHANTABILITY AND FITNESS FOR A PARTICULAR PURPOSE, REGARDING THE SOFTWARE. BROTHER'S LICENSOR(S) DOES NOT WARRANT, GUARANTEE OR MAKE ANY REPRESENTATIONS REGARDING THE USE OR THE RESULTS OF THE USE OF THE SOFTWARE IN TERMS OF ITS CORRECTNESS, ACCURACY, RELIABILITY, CURRENTNESS OR OTHERWISE. THE ENTIRE RISK AS TO THE RESULTS AND PERFORMANCE OF THE SOFTWARE IS ASSUMED BY YOU. THE EXCLUSION OF IMPLIED WARRANTIES IS NOT PERMITTED BY SOME STATES IN THE USA AND SOME PROVINCES IN CANADA. THE ABOVE EXCLUSION MAY NOT APPLY TO YOU.

IN NO EVENT WILL BROTHER'S LICENSOR(S) BE LIABLE TO YOU FOR ANY CONSEQUENTIAL, INCIDENTAL OR INDIRECT DAMAGES (INCLUDING DAMAGES FOR LOSS OF BUSINESS PROFITS, BUSINESS INTERRUPTION, LOSS OF BUSINESS INFORMATION, AND THE LIKE) ARISING OUT OF THE USE OR INABILITY TO USE THE SOFTWARE EVEN IF BROTHER'S LICENSOR HAS BEEN ADVISED OF THE POSSIBILITY OF SUCH DAMAGES. BECAUSE SOME STATES IN THE USA AND SOME PROVINCES IN CANADA DO NOT ALLOW THE EXCLUSION OR LIMITATION OF LIABILITY FOR CONSEQUENTIAL OR INCIDENTAL DAMAGES, THE ABOVE LIMITATIONS MAY NOT APPLY TO YOU. IN ANY EVENT BROTHER'S LICENSOR'S LIABILITY TO YOU FOR ACTUAL DAMAGES FROM ANY CAUSE WHATSOEVER, AND REGARDLESS OF THE FORM OF THE ACTION (WHETHER IN CONTRACT, TORT (INCLUDING NEGLIGENCE), PRODUCT LIABILITY OR OTHERWISE), WILL BE LIMITED TO \$50.

BROTHER FACSIMILE 90 DAY REPLACEMENT WARRANTY A LIMITED WARRANTY (For USA Only)

This warranty gives you certain rights and you may also have other rights that may vary from state to state.

This warranty is given only to the end-use purchaser of the accompanying product (referred to in this warranty as "this Product").

What is covered: Brother warrants to you for the Warranty Period that there are no defects in the materials, workmanship or Year 2000 compliance of this Product. The "Warranty Period" is 90 days from the date you purchased this product.

What is NOT covered: This warranty is VOID — that is, this Product has no warranty — if: (1) you did not purchase this Product from an authorized Brother reseller within the United States, (2) this Product has been serviced, modified or tampered with by anyone other than an Authorized Service Representative of Brother, (3) the serial number has been modified, defaced or removed from this Product, (4) this Product has been abused or damaged, or (5) non Brother®-brand or non Brother approved parts, supplies, or other accessories have been used with this Product.

What to do if you think your Product is defective:

Call our Customer Service Hotline at 1-800-284-4329, or if you suspect a defect in materials or workmanship in this Product, you can report it to a Brother Authorized Service Center. During the Warranty Period, supply Brother's representative with a copy of your dated bill of sale showing that this Product was purchased within the United States. For the name of your Brother Authorized Service Center, call 1-800-521-2846. After contacting the Brother Authorized Service Center, you may be required to deliver or send the Product properly packaged, freight prepaid, to the Authorized Service Center together with a photocopy of your bill of sale.

What Brother will do: Brother (or its Authorized Service Center) will evaluate your report of a possible defect to determine whether a defect exists, and if it does exist, Brother (or its Authorized Service Center) will repair or (at Brother's option) replace the Product with a product that performs the same functions and performs as well as the original Product. Brother reserves the right to supply refurbished or remanufactured replacement products provided that the replacement products conform to the manufacturer's specifications for new products. The repaired or replacement product will be returned to you at no cost.

Exchange Service:

Exchange service will expedite, in most instances by the next business day, the exchange of your non working Product with a supply refurbished or remanufactured product that conform to the manufacturer's specifications for new products. The supply refurbished or remanufactured Product you receive will be covered by the balance of the limited warranty period remaining on the original Product, plus an additional thirty (30) days. You will keep the replacement Product that is sent to you and must return (or be billed up to the cost of a new product) your original non working product, which shall become the property of Brother. You must call Brother Customer Service and if the representative cannot correct the product's malfunction over the telephone and you elect the exchange service, you must provide information pertaining to this Product and you must also provide a valid major credit card number. Your credit card will be charged up to the cost of a new Product if: (i) you do not return your original Product to Brother within five (5) business days; (ii) the malfunctions of your original Product are not covered by the limited warranty; (iii) the proper packaging instructions are not followed and has caused damage to the product; or (iv) the warranty period on your original

BROTHER FACSIMILE 90 DAY REPLACEMENT WARRANTY A LIMITED WARRANTY (For USA Only)

Product has expired or has not been sufficiently validated with a copy of the proof of purchase (bill of sale). The Brother Customer Service Representative will ship the exchange Product with return instructions and prepaid return airbill. Follow the return instructions. You must return the original Product in the same shipping carton in which the exchanged Product was received and include a copy of proof of purchase (bill of sale). Retain your original accessory items and a copy of the return airbill, signed by the courier.

Limitations:

Repair or replacement as described above is your sole and exclusive (that is, your only) remedy if this Product is defective. Brother is not responsible for damage to or loss of any equipment, media, programs or data related to the use of this Product. Except for that repair or replacement, *Brother shall not be liable for any direct, indirect, incidental or consequential damages or specific relief. Because some states do not allow the exclusion or limitation of consequential or incidental damages, the above limitation may not apply to you.*

THIS WARRANTY IS GIVEN IN LIEU OF ALL OTHER WARRANTIES, WRITTEN OR ORAL, WHETHER EXPRESSED BY AFFIRMATION, PROMISE, DESCRIPTION, DRAWING, MODEL OR SAMPLE. ANY AND ALL WARRANTIES OTHER THAN THIS ONE, WHETHER EXPRESS OR IMPLIED, INCLUDING IMPLIED WARRANTIES OF MERCHANTABILITY AND FITNESS FOR A PARTICULAR PURPOSE, ARE HEREBY DISCLAIMED.

This Limited Warranty is the only warranty that Brother is giving for this Product. It is the *final expression and the exclusive and only statement* of Brother's obligations to you. It replaces all other agreements and understandings that you may have with Brother or its representatives.

This Limited Warranty (and Brother's obligation to you) may not be changed in any way unless you and Brother sign the same piece of paper in which we (1) refer to this Product and your bill of sale date, (2) describe the change to this warranty and (3) agree to make that change.

Product Support: Toll-free customer service and technical support is available for hardware operational assistance at [1-800-284-4329](tel:1-800-284-4329). At any time, free technical support in the form of Frequently Asked Questions, troubleshooting tips and service center locator is available through our fax back system at [1-800-521-2846](tel:1-800-521-2846) or Brother's Internet Web Site (www.brother.com).

**BROTHER INTERNATIONAL CORPORATION
100 SOMERSET CORPORATE BLVD.
BRIDGEWATER, NEW JERSEY 08807-0911**

Please record your model and serial number and your date and location of Purchase below for your records. Keep this information with your proof of purchase (bill of sale) in case your Product is lost, stolen or requires service.

Model # _____
Serial # _____
Date of purchase: _____
Store where purchased: _____
Location of store: _____

Important: We recommend that you keep all original packing materials, in the event that you ship this product.

BROTHER MULTIFUNCTION CENTER/FACSIMILE MACHINE LIMITED WARRANTY (For Canada Only)

Pursuant to this limited warranty of 1 year from the date of purchase for labour and parts, Brother International Corporation (Canada) Ltd. ("Brother"), or its Authorized Service Centers, will repair this MFC/Facsimile machine free of charge if defective in material or workmanship. This Limited Warranty does not include cleaning, consumables (including, without limitation, print cartridges, print head, toner and drum) or damage caused by accident, neglect, misuse or improper installation or operation, any damage caused from service, maintenance, modifications, or tampering by anyone other than a Brother Authorized Service Representative, or from the use of supplies or consumable items that are non-Brother products. Operation of the MFC/Facsimile machine in excess of the specifications or with the Serial Number or Rating Label removed shall be deemed abuse and all repairs thereafter shall be the sole liability of the end-user/purchaser. In order to obtain warranty service, the MFC/Facsimile machine must be delivered or shipped freight prepaid by the end user/purchaser to a "Brother" Authorized Service Center, together with your Proof of Purchase in the form of a Sales Receipt.

For laser products: Failure to remove the Toner Cartridge (and Toner Drum Unit on applicable models) during shipping will cause severe damage to the MFC/Facsimile and will VOID the Warranty. (Refer to your Operation Manual for proper packaging.)

For ink-jet products: Do not remove the ink cartridges during shipping. Damage to your print head resulting from packing without the ink cartridges will VOID your warranty. (Refer to your Operation Manual for proper packaging.)

BROTHER DISCLAIMS ALL OTHER WARRANTIES EXPRESSED OR IMPLIED INCLUDING, WITHOUT LIMITATION, ANY IMPLIED WARRANTIES OF MERCHANTABILITY OR FITNESS FOR A PARTICULAR PURPOSE, EXCEPT TO THE EXTENT THAT ANY WARRANTIES IMPLIED BY LAW CANNOT BE VALIDLY WAIVED.

No oral or written information, advice or representation provided by Brother, its Authorized Service Centers, Distributors, Dealers, Agents or employees, shall create another warranty or modify this warranty. This warranty states Brother's entire liability and your exclusive remedy against Brother for any failure of the MFC/Facsimile machine to operate properly.

Neither Brother nor anyone else involved in the development, production, or delivery of this MFC/Facsimile machine shall be liable for any indirect, incidental, special, consequential, exemplary, or punitive damages, including lost profits, arising from the use of or inability to use the product, even if advised by the end user/purchaser of the possibility of such damages. Since some Provinces do not allow the above limitation of liability, such limitation may not apply to you.

This Limited Warranty gives you specific legal rights and you may also have other rights which vary from Province to Province.

Warranty Service is available at Brother Authorized Service Centers throughout Canada. For Technical Support or for the name and location of your nearest Authorized Service Center call 1-800-853-6660. Within Montreal, please call 685-6464. Internet support: support@brother.ca or browse Brother's Web Site: www.brother.com

Brother International Corporation (Canada) Ltd.
1 Rue Hôtel de Ville
Dollard-Des-Ormeaux, QC H9B 3H6

Year 2000 Compliant

Brother is addressing the Year 2000 related issues for all Brother fax machines and multi-function centers. Our focus is to ensure that our bundled third party software will continue to properly process date/time data after January 1, 2000.

Brother fax machines and multi-function centers will function properly after January 1, 2000, *provided that* all non-Brother hardware, software and firmware used by our customers in connection or combination with Brother fax machines, and bundled software, accurately exchange date data with the Brother products.

Please continue to check our Web page for updates at **<http://www.brother.com>**. All remedies will be provided to individual customers via software patches through software download or from Brother Customer Service.

Table of Contents

1 Introduction

- Using This Manual 1
 - Finding Information 1
- Test Sheet Procedures (for USA only) 2
- About Fax Machines 2
 - Fax Tones and Handshake 2
 - ECM (Error Correction Mode) 3
- Control Panel Overview 4
 - FAX 355MC and FAX 375MC 4

2 Set Up and Connections

- Caution 5
- Packing List 6
- Choosing a Location 7
- Assembly 7
 - Load the recording paper 7
 - About Brother Paper 9
 - Connect the handset 9
 - Connect the power cord 10
 - Connect the telephone line 10
 - Attach the document support 10
 - Special Line Considerations 11
 - Roll Over Phone Lines 11
 - Two-Line Phone System 11
 - Converting Telephone Wall Outlets 11
 - Installing fax machine, External Two-Line TAD, and Two-Line Telephone 12
 - Multi-Line Connections (PBX) 13
 - If you are installing the fax machine to work with a PBX: 14
 - Custom Features on Your Phone Line 14
 - Connecting an External Telephone Answering Device (TAD) 14
 - Sequence 14
 - Connections 15
 - Outgoing Message (OGM) 16
 - Connecting an External Telephone 16

<p>3 On-Screen Programming</p>	<p>User-Friendly Programming 17</p> <p> Function Mode 17</p> <p> Alternating Displays 18</p> <p> Function Selection Table 19</p>
<p>4 Initial Setup</p>	<p>Getting Started 23</p> <p> Setting Dialing Mode (Tone/Pulse) 23</p> <p> Setting Date and Time 23</p> <p> Setting Station ID 24</p> <p> Entering Text 25</p> <p> Inserting Spaces 25</p> <p> Making Corrections 25</p> <p> Repeating Letters 25</p> <p> Special Characters and Symbols 25</p> <p> Setting Up Your Area Code (For USA Only) 26</p> <p> Setting Beeper Volume 27</p> <p> Setting the Handset Volume 27</p> <p> Setting Volume Amplify 28</p> <p> Setting the Speaker Volume 28</p> <p> Setting the Ring Volume 29</p> <p> Memory Storage 29</p>
<p>5 Setup Receive</p>	<p>Basic Receiving Operations 31</p> <p> Select Answer Mode 31</p> <p> To select or change your Answer Mode 32</p> <p> Setting Ring Delay 33</p> <p> Setting F/T Ring Time 33</p> <p> Record FAX/TEL Outgoing Announcement (F/T OGM) 34</p> <p> Easy Receive 34</p> <p>Advanced Receiving Operations 35</p> <p> Operation from Extension Telephone 35</p> <p> For FAX/TEL Mode Only 35</p> <p> Changing Remote Codes 35</p> <p> To change Remote Codes 36</p> <p> Polling 36</p> <p> Setting Up Polling Receive 36</p> <p> Setting Up Sequential Polling Receive 37</p> <p> Canceling a Scheduled Job 37</p> <p> Setting Multi-Function Link[®] Mode (With Multi-Function Link[®] option) 38</p>
<p>Setup Send</p>	<p>Before You Begin 39</p> <p> ADF (Automatic Document Feeder) 40</p> <p> Resolution 40</p>

Contrast	40
Manual Transmission	41
Automatic Transmission	41
Manual and Automatic Fax Redial	41
Advanced Sending Operations	42
Overseas Mode	42
Quick Scan Fax Transmission	42
Delayed FAX	43
Broadcasting	43
Next-Fax Reservation	44
Multiple Resolution Transmission	44
Setting Up Polling Transmit	45
Canceling a Scheduled Job	45
Interrupting Delayed Fax and Polling Transmit Jobs	46
7 Setup Auto Dial Numbers	
Storing Numbers for Easy Dialing	47
Storing One Touch Dial Numbers	47
Access Codes and Credit Card Numbers	48
Storing Speed Dial Numbers	49
Changing One Touch and Speed Dial Numbers	50
Setting Up Groups for Broadcasting	51
8 Telephone Operation	
Dialing Options	53
Manual Dialing	53
One Touch Dialing	54
Speed Dialing	54
Hold	54
Pause	54
Tone/Pulse	55
Searching Telephone Index	55
Answering Calls with the Speaker Phone	55
9 Message Center	
Message Center Mode	57
Flexible Memory Settings (Message Storage)	57
Setting Up Message Center	58
Setting Message Storage	58
Recording Message Center Outgoing Message	59
Listening to Outgoing Message (OGM)	59
Erasing Outgoing Message (OGM)	59
Activating Message Center Mode	60
Message Indicator	60
Playing Voice Messages and Memos	60
Printing a Fax Message	61

Backup Printing Option 61

Erasing Messages 61

 To erase voice messages individually 62

 To erase messages all at once 62

Setting Maximum Time for Incoming Messages 62

Setting Toll Saver 63

ICM Recording Monitor 63

Recording a Memo 63

Recording a Conversation 64

Fax Forwarding/Paging 64

 Programming a Fax Forwarding Number 64

 Programming Paging Number 65

Remote Retrieval 66

 Using Remote Retrieval Access Code 66

 Changing Remote Retrieval Access Code 66

 Remote Control Commands 67

 Retrieving Memory Status List 68

 Retrieving Fax Messages 68

 Changing Fax Forwarding Number 69

Custom Features 71

 Distinctive Ring 71

 Registering the Distinctive Ring Pattern 72

 Caller ID 73

 Caller ID Log 73

 Printing the Caller ID Log 73

 Viewing the Caller ID Log 74

 Returning a Call from the Log 75

 Registering a Caller ID Number 76

Copy Functions 77

 Multiple Copies 77

FAX Settings 79

 To Print a Report 80

 Transmission Verification (Xmit) Report 80

 Using the Trans. Verify Key 80

Standard Telephone and FCC Notices 81

 These notices are in effect on models sold and used in the
 United States only. 81

 Federal Communications Commission Compliance Notice
 (For USA Only) 83

10 Telephone Services

11 Making Copies

12 Printing Reports

13 Important Information

	Industry Canada Compliance Statement (For Canada Only)	83
	Important Safety Instructions	84
	Compilation and Publication Notice	86
	Trademarks	86
14	Troubleshooting and Maintenance	
	Troubleshooting	87
	Fax-Back System	87
	Brother on the World Wide Web	87
	Brother Bulletin Board	87
	Error Messages	88
	Recording Paper Jam	91
	If You Are Having Difficulty with Your Fax Machine	92
	Printing or Receiving Faxes	92
	Condensed Print and Horizontal Streaks; Top and Bottom of Sentences Cut Off	92
	Enabling/Disabling Anti-Curl Check Sheet (ACS)	92
	Vertical Black Lines When Receiving	92
	Phone Line or Connections	92
	Fax Machine Does Not Answer When Called	92
	No Dial Tone on the Handset	93
	Sending Faxes	93
	Poor Transmitting Quality	93
	Dialing Does Not Work	93
	Vertical Black Lines When Sending	93
	Handling Incoming Calls	93
	Double Ring in FAX/TEL Mode	93
	Transferring a Call to the Fax Machine	94
	Fax Machine "Hears" Voice as CNG Tone	94
	Transmission Verification Report Prints "Result: NG"	94
	Custom Features on a Single Line	94
	For Customer Service	94
15	Multi-Function Link® (option)	
	Multi-Function Link® (option)	95
16	Specifications	
	Specifications	97
	Glossary	99
	Index	103

1 Introduction

Using This Manual

Thank you for purchasing a Brother fax machine. This fax machine has been designed to be simple to use, with LCD screen prompts to guide you through functions. However, you can use your fax machine to its fullest potential by taking a few minutes to read this manual.



Additionally, your fax machine has a Help Key. Press **Help/Q.Scan** to print a list of basic operational steps and functions.

Finding Information

All chapter headings and subheadings are listed in the Table of Contents. You will be able to find information about a specific feature or function by checking the Index at the back of this manual. Also, throughout this manual, you'll see special symbols alerting you to important information, cross-references, and warnings. Illustrations of some screen displays also help you choose the correct key-presses.

Test Sheet Procedures (for USA only)

*See
Setting
Station ID
p. 24*

After programming your Station ID, please fill out the TEST SHEET included with your fax machine and fax it to Brother's Automated Fax Response System as your first transmission. This will verify that your fax machine is properly installed.

When this document is received a confirmation sheet will be sent back to your machine. To get a response, be sure to set up your Station ID.

USA 1-908-685-9283 (fax)

About Fax Machines

If you're a first-time fax machine user, fax operation might seem a little mysterious. You'll soon get used to the unusual fax tones on your phone line, and be able to send and receive faxes easily.

Fax Tones and Handshake

When someone is sending a fax, the fax machine sends fax calling tones, (CNG tones) — soft, intermittent beeps at 4-second intervals. You'll hear them when you dial and press **[Start]**, and they continue for about 40 seconds after dialing. During that time, the sending machine must begin the "handshake" with the receiving machine. Each time you use automatic procedures to send a fax, you are sending CNG tones over the phone line. You'll soon learn to listen for these soft beeps each time you answer a phone on your fax line, so you know if you are receiving a fax message.

The receiving fax responds with fax receiving tones — loud, chirping sounds. A receiving fax chirps for about 40 seconds over the phone line, and the screen displays RECEIVE. If your fax machine is set to the FAX ONLY Mode, it will answer every call automatically with fax receiving tones. Even if the other party hangs up, your fax machine continues to send the "chirps" for about 40 seconds, and the screen continues to display RECEIVE. To cancel the receiving mode, press **[Stop]**.

When your fax machine answers in FAX/TEL Mode, the fax machine listens for CNG tones and then responds with receiving tones.

The fax “handshake” is the time in which the sending machine’s CNG tones and the receiving machines “chirps” overlap. This must be for at least 2 to 4 seconds, so the machines can understand how each is sending and receiving the fax. The handshake cannot begin until the call is answered, and the CNG tones only last for about 40 seconds after the number is dialed. Therefore, it’s important for the receiving machine to answer the call in as few rings as possible.



When you have an external telephone answering device (TAD) on your fax line, your TAD will determine the number of rings before the call is answered. Pay special attention to the directions in the Installation chapter for connecting a TAD to your fax machine.

ECM (Error Correction Mode)

The Error Correction Mode (ECM) is a way for the fax machine to check the integrity of a fax transmission while it is in progress. ECM transmissions are possible only between machines that both have the ECM feature. If they do, you may send and receive fax messages that are continuously checked for their integrity.

Sufficient memory must be available in your fax machine for this feature to work.

Control Panel Overview

FAX 355MC and FAX 375MC

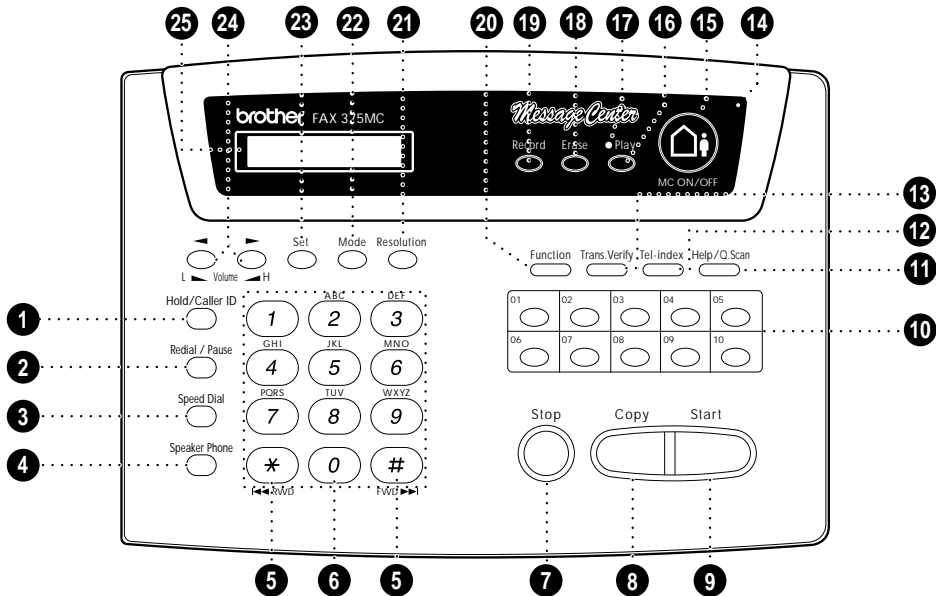

- 1 Hold/Caller ID**
Lets you put calls on hold. Also, lets you view or print the Caller ID list.
- 2 Redial / Pause**
Re-dials the last number called. Also inserts a pause in autodial numbers.
- 3 Speed Dial**
Lets you dial stored phone numbers by pressing a two-digit number.
- 4 Speaker Phone**
Lets you speak to the person at the other end and dial telephone numbers without lifting the handset.
- 5 RWD (*)
FWD (#)**
Use to repeat or skip to the next voice message during playback.
- 6 Dial Pad**
Dials phone and fax numbers, and can be used as a keyboard for entering information into the fax machine.
- 7 Stop**
Stops a fax, cancels an operation or exits from function mode.
- 8 Copy**
Makes a copy.
- 9 Start**
Starts an operation, such as sending a fax.
- 10 One Touch Dial Keys**
These ten keys give you instant access to previously stored phone numbers.
- 11 Help/Q. Scan**
Prints a quick reference Help List. Also, lets you take advantage of memory transmission.
- 12 Tel-index**
Lets you look up numbers stored in the dialing memory.
- 13 Trans. Verify**
Lets you print the Transmission Verification Report for your last transmission.
- 14 Microphone**
Picks up your voice when you speak to another party using speakerphone.
- 15 MC ON/OFF**
Lets you activate the Message Center.
- 16 Play**
Lets you listen to voice messages and outgoing messages, and print fax messages stored in memory.
- 17 Message Indicator Light**
Notifies you that you have voice or fax messages in the memory.
- 18 Erase**
Lets you delete voice messages, fax messages or all messages.
- 19 Record**
Lets you record an Outgoing Message (OGM), memos and telephone calls, and store information for Message Center features.
- 20 Function**
Lets you access the function and programming mode.
- 21 Resolution**
Sets the resolution when you send a fax or make a copy.
- 22 Mode**
Use to select how fax machine will handle incoming calls.
- 23 Set**
Stores a function setting into the fax machine.
- 24 ◀ (Left Arrow)
▶ (Right Arrow)
Volume**
Moves the LCD cursor to the left or right. Adjusts speaker, ring and handset volume.
- 25 Liquid Crystal Display**
Displays messages to help you set up and operate your fax machine.

Set Up and Connections

Caution

- 1 Never install telephone wiring during a lightning storm.
- 2 We recommend that this product be used with a surge protection device to protect the product against lightning storms.
- 3 Never install a telephone jack in a wet location unless the jack is specifically designed for a wet location.
- 4 Never touch telephone wires or terminals that are not insulated unless the telephone line has been disconnected at the network interface.
- 5 Use caution when installing or modifying telephone lines.
- 6 Avoid using a telephone (other than a cordless type) during an electrical storm. There may be a remote risk of electric shock from lightning.
- 7 Do not use the telephone to report a gas leak in the vicinity of the leak.
- 8 For PLUGGABLE EQUIPMENT, the socket-outlet should be installed near the equipment and should be easily accessible.

Packing List

Make sure you have the following items:

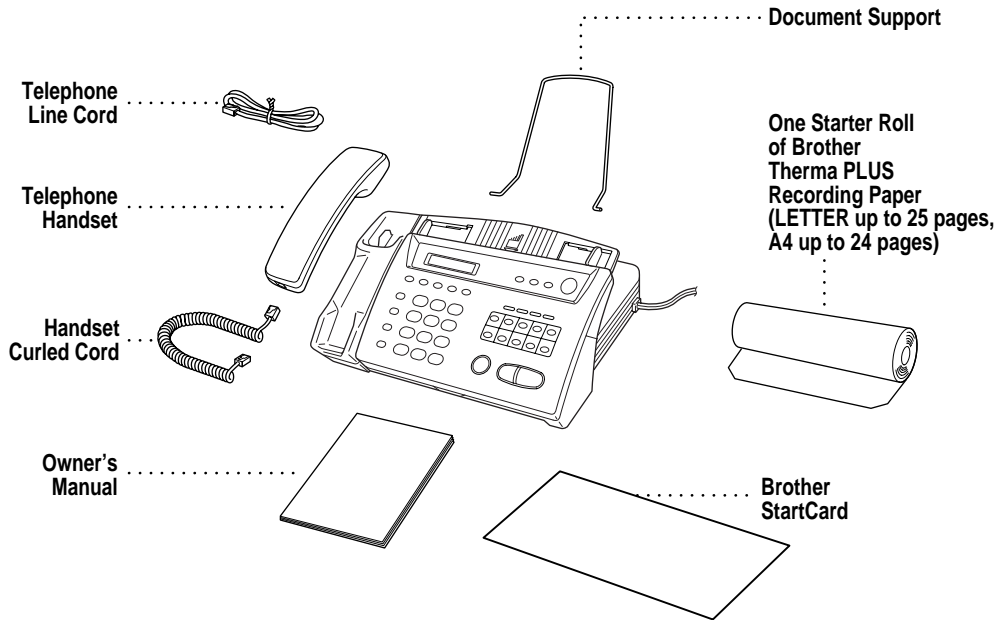

NOTICE: If an item is missing, call Brother Customer Service at 1-800-284-4329 (USA), 1-800-853-6660 (from within Canada) or 1-514-685-6464 (from within Montreal). See Ordering Accessories and Supplies on page ii for the correct item numbers.

Whenever you transport the fax machine, use the packing materials that came with your machine. If you do not pack the fax machine correctly, you may void your warranty.

Choosing a Location

Place your fax machine on a flat, stable surface, such as a desk. Select a place that is free of vibration and shocks. Locate the fax machine near a telephone jack and a standard, grounded power outlet.



Avoid placing your machine in a high-traffic area. Do not place near heaters, air conditioners, water, chemicals or refrigerators. Do not expose the fax machine to direct sunlight, excessive heat, moisture or dust. Do not connect your machine to electrical outlets controlled by wall switches or automatic timers. Disruption of power can wipe out information in the unit's memory. Do not connect your machine to electrical outlets on the same circuit as large appliances or other equipment that might disrupt the power supply. Avoid interference sources, such as speakers or the base units of cordless phones.

Assembly

Load the recording paper

- 1 Open the cover by placing your finger in the groove under the cover and lifting up.

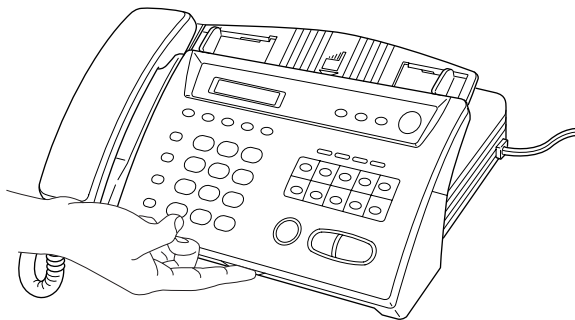

- 2 Pull up the blue release lever so you can remove the three protective sheets (initial set up) or any paper remaining in the machine from the last roll.

- 3** Unwrap the new recording paper roll and insert it into the paper bin, with the paper feeding from the bottom of the roll.

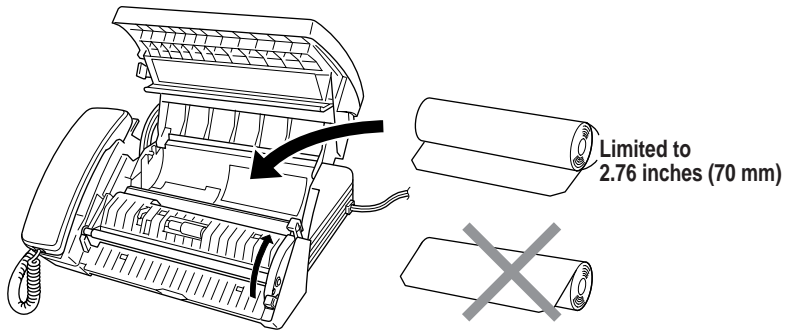

- 4** Raise the paper enough to pass it over the  until it feeds out the front of the machine. Make sure there is no slack.

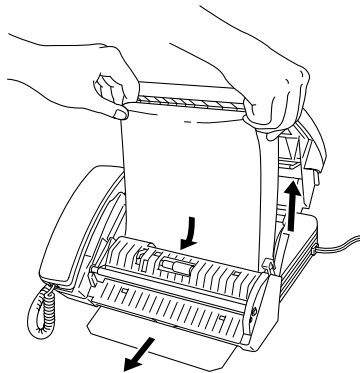

- 5** Pull down the blue lever and close the cover.

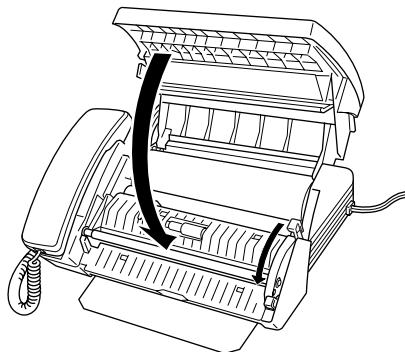

About Brother Paper

For the best print quality, use Brother Therma Plus Paper, Item Numbers 6890 (two 98' rolls) or 6840 (four 98' rolls). Therma Plus paper is thicker, like plain paper, and produces the best print quality.



The recording paper roll size for your fax machine is limited to a diameter of 2.76 inches (70 mm). You can use a 164' roll of thinner thermal paper as long as it meets these requirements.

Connect the handset

Connect the curled handset cord to the bottom of the handset and the side of the fax machine.

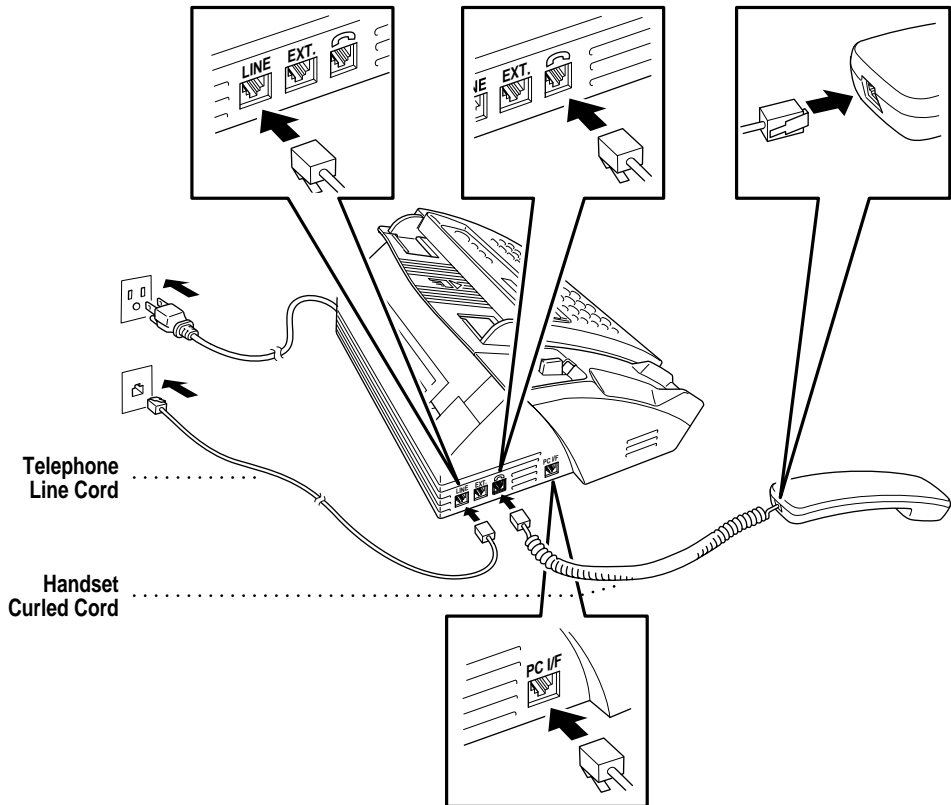



Connect the power cord

When you connect the power, the screen displays 01/01 00:00 FAX.

NOTICE:

- 1) This fax must be grounded using a three-prong plug.
- 2) Since the fax machine is grounded through the power outlet, you can protect yourself from potentially hazardous electrical conditions on the telephone network by keeping the power to your machine on when you connect it to a telephone line. Similarly, you can protect yourself when you want to move your machine, by disconnecting the telephone line first, and then the power cord.
- 3) Lightning and power surges can damage this product! We recommend that you use a quality surge protection device on the AC power line as well as on the telephone line, or unplug the telephone line and electrical cords during a lightning storm.

Connect the telephone line

Connect one end of the telephone line cord to the jack labeled **LINE** on the left side of the fax machine. Connect the other end to a modular wall jack.

Attach the document support

Attach the document support as shown in the illustration below.

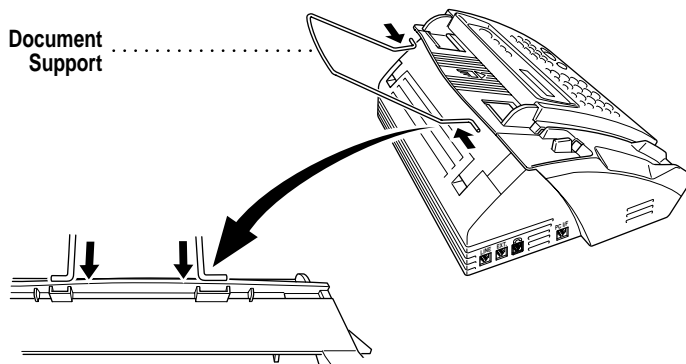

Special Line Considerations

Roll Over Phone Lines

A roll over phone system is a group of two or more separate telephone lines that pass incoming calls to each other if they are busy. The calls are usually passed down or “rolled over” to the next available phone line in a preset order.

Your fax machine can work in a roll over system as long as it is the last number in the sequence, so the call cannot roll away. Do not put the fax machine on any of the other numbers; when the other lines are busy and a second fax call is received, the fax call is transferred to a line that does not have a fax machine. Your fax machine will work best on a dedicated line.

Two-Line Phone System

A two-line phone system is nothing more than two separate phone numbers on the same wall outlet. The two phone numbers can be on separate jacks (RJ11) or combined into one jack (RJ14). Your fax machine must be plugged into an RJ11 jack. RJ11 and RJ14 jacks may be equal in size and appearance and both may contain four wires (black, red, green, yellow). To test the type of jack, plug in a two-line phone and see if it can access both lines. If it can, you must separate the line for your fax machine.

Converting Telephone Wall Outlets

There are three ways to convert to an RJ11 receptacle. The first two ways may require assistance from the telephone company. You can change the wall outlets from one RJ14 jack to two RJ11 jacks. Or, you can have an RJ11 wall outlet installed and slave or jump one of the phone numbers to it.

The third way is the easiest: Buy a triplex adapter. You can plug a triplex adapter into an RJ14 outlet. It separates the wires into two separate RJ11 jacks (Line 1, Line 2) and a third RJ14 jack (Lines 1 and 2). If your fax machine is on Line 1, plug the fax machine into L1 of the triplex adapter. If your fax machine is on Line 2, plug it into L2 of the triplex adapter.

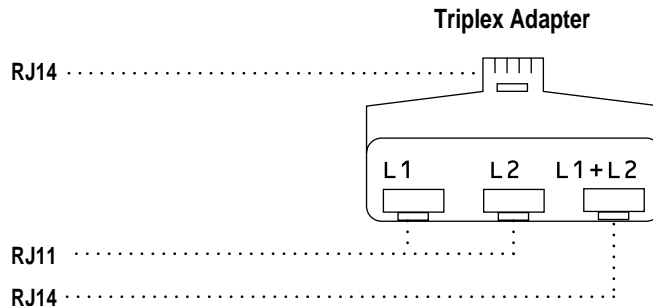

Installing fax machine, External Two-Line TAD, and Two-Line Telephone

When you are installing an **external** two-line telephone answering device (TAD) and a two-line telephone, your fax machine must be isolated on one line at both the wall jack and at the TAD. *The most common connection is to put the fax machine on Line 2, which is our assumption in the following steps.* The back of the two-line TAD must have two telephone jacks: one labeled L1 or L1/L2, and the other labeled L2. You will need at least three telephone line cords, the one that came with your fax machine and two for your external two-line TAD. You will need a fourth line cord if you add a two-line telephone.

- 1 Place the two-line TAD and the two-line telephone next to your fax machine.
- 2 Plug one end of the telephone line cord for your fax machine into the L2 jack of the triplex adapter. Plug the other end into the **LINE** jack on the left side of the fax machine.
- 3 Plug one end of the first telephone line cord for your TAD into the L1 jack of the triplex adapter. Plug the other end into the L1 or L1/L2 jack of the two-line TAD.

- 4 Plug one end of the second telephone line cord for your TAD into the L2 jack of the two-line TAD. Plug the other end into the **EXT.** jack on the left side of the fax machine.

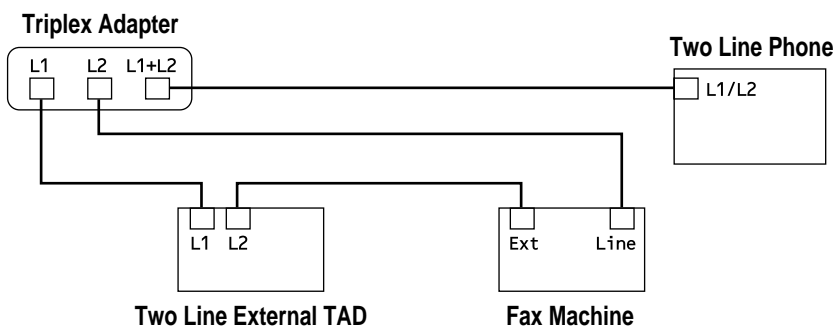

You can keep two-line telephones on other wall outlets as always. There are two ways to add a two-line telephone to the fax machine's wall outlet. You can plug the telephone line cord from the two-line telephone into the L1+L2 jack of the triplex adapter. Or, you can plug the two-line telephone into the TEL jack of the two-line TAD.

Multi-Line Connections (PBX)

Most offices use a central telephone system. While it is often relatively simple to connect the fax machine to a key system or a PBX (Private Branch Exchange), we suggest that you contact the company that installed your telephone system and ask them to connect the fax machine for you. It is advisable to have a separate line for the fax machine. You can then leave the fax machine in FAX ONLY Mode to receive faxes any time of day or night.

*See
Easy Receive
p. 34*



If the fax machine is to be connected to a multi-line system, ask your installer to connect the unit to the last line on the system. This prevents the unit from being activated each time a telephone call is received.

As with all fax units, this machine must be connected to a two wire system. If your line has more than two wires, proper connection of the fax machine cannot be made.

If you are installing the fax machine to work with a PBX:

- 1 It is not guaranteed that the unit will operate correctly under all circumstances with a PBX. Any cases of difficulty should be reported first to the company that handles your PBX.
- 2 If all incoming calls will be answered by a switchboard operator, it is recommended that the Answer Mode be set to MANUAL. All incoming calls should initially be regarded as telephone calls.
- 3 The unit may be used with either pulse or tone dialing telephone service.

Custom Features on Your Phone Line

If you have telephone services (offered by your telephone company) on your phone line, please see Telephone Services, chapter 10.

Connecting an External Telephone Answering Device (TAD)

Sequence

You might choose to connect an additional answering system. When you have an **external** TAD on the same telephone line as the fax machine, the TAD answers all calls. The fax machine “listens” for fax calling (CNG) tones. If it hears them, the fax machine takes over the call and receives the fax. If it doesn’t hear CNG tones, the fax machine lets the TAD continue playing your outgoing message so your caller can leave you a voice message.

The TAD must answer within four rings (the recommended setting is two rings). The fax machine cannot hear CNG tones until the TAD has answered the call, and with four rings there are only 8–10 seconds of CNG tones left for the fax “handshake.” Make sure you carefully follow instructions in this manual for recording your outgoing message. We do not recommend using the toll saver feature on your external TAD if it exceeds 4 rings.



Do not connect a TAD elsewhere on the same phone line—your fax machine and TAD will both try to control the line.

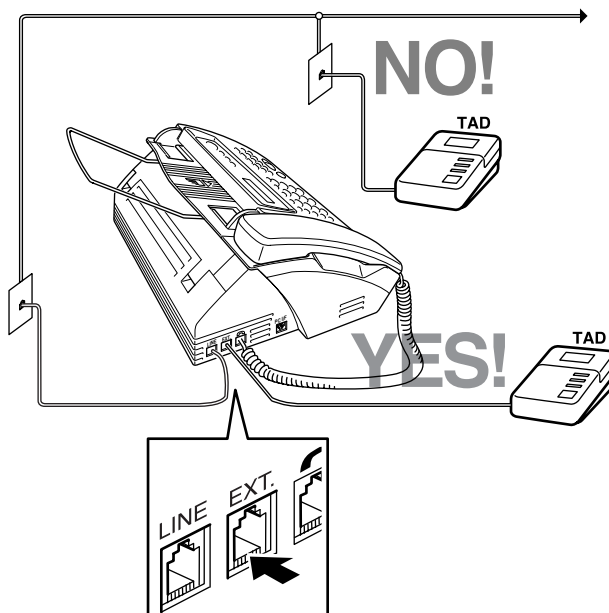

You may connect an external TAD to a separate wall jack only if you subscribe to your telephone company's Distinctive Ring Service, have registered the distinctive ring pattern on your fax machine and use that number as a fax number and set your fax machine's Answer mode to **MANUAL**.

Connections

The external TAD must be plugged into the left side of the fax machine, into the jack labeled EXT. Your fax machine cannot work properly if you plug the TAD into a wall jack.

- 1** Plug the telephone line cord from the wall jack into the left side of the fax machine, in the jack labeled LINE.
- 2** Plug the telephone line cord from your TAD into the left side of the fax machine, in the jack labeled EXT. (Make sure this cord is connected to the TAD at the TAD's telephone line jack, and not its telephone set jack.)
- 3** Set your external TAD to four rings or less. (The fax machine's Ring Delay setting does not apply).
- 4** Record the outgoing message (see next page).
- 5** Set the TAD to answer calls.
- 6** Set Message Storage (**[Function]**, **[8]**, **[1]**) to VOICE:EXT.
- 7** Set the Answer Mode to MC:MSG CTR.

Outgoing Message (OGM)

Timing is important in recording this message. The message sets up the ways to handle both manual and automatic fax reception.

- 1** Record 5 seconds of silence at the beginning of your message. (This allows your fax machine time to listen for the fax CNG tones of automatic transmissions before they stop.)
- 2** Limit your speaking to 20 seconds.
- 3** End your 20-second message by giving your Fax Receive Code for people sending manual faxes. For example:
“After the beep, leave a message or send a fax by pressing * 5 1 and Start.”



We recommend beginning your OGM with an initial 5-second silence because the fax machine cannot hear fax tones over a resonant or loud voice. You may try omitting this pause, but if your fax machine has trouble receiving, then you must rerecord the OGM to include it.

Connecting an External Telephone

Your fax machine is equipped with a handset that you can use as a regular phone. However, you can also connect a separate telephone (or telephone answering device) directly to your fax machine.

Connect the modular plug on the telephone's line cord to the jack labeled EXT. on the left side of the fax machine.

Whenever this phone (or TAD) is in use, the screen displays EXT. TEL IN USE, and, if the fax machine handset is lifted, an alarm sounds. To disconnect the call on the external phone and switch to the fax machine, press Speaker Phone.

3 On-Screen Programming

User-Friendly Programming

*See
Using This
Manual p. 1*

We have designed your fax machine with on-screen programming and a Help key. User-friendly programming helps you take full advantage of all the functions your fax machine has to offer.

Since your fax programming is done on the LCD, we created step-by-step on-screen prompts to help you program your fax machine. All you need to do is follow the prompts as they guide you through the function menu selections and programming options and settings.

Function Mode

You can access the function mode by pressing **[Function]**. When you enter the function mode, your fax machine displays a list of main menu options from which you can choose. These options appear one after the other on the display. Select a menu option by pressing **[Set]** when the option appears on the screen. The display will scroll the options within that menu.

You can “scroll” more quickly through options by pressing **[▶]**. When the screen displays your selection, press **[Set]**. (Use **[◀]** to scroll backward if you passed your choice or to save key strokes. Both arrow keys show all options, in the opposite order.)

Before you press **[Set]** after entering information in a field using the dial pad, you can correct a mistake. Use **[◀]** to back up and then type over the incorrect characters.

When you finish a function, the screen displays ACCEPTED.

If you want to exit the Function Mode, press **[Stop]**.



Alternating Displays

When you see alternating displays, the LCD sometimes alternates between the currently selected option, and a help message giving brief instructions about how to proceed. The display you'll probably see most often is shown below, showing you, when you place a document in the feeder, that you can dial a number and send a fax, or you can make a copy.



Function Selection Table

If you have a basic understanding of how to program your fax machine, you can perform most of the programming settings without the Owner's Manual. To help you understand the function selections, options, and settings that are found in your fax programs, use the Function Selection Table below.

1. INITIAL SETUP			
Function	Description	Factory Set	Page
1. TONE/PULSE	Selects dialing mode.	TONE	23
2. DATE/TIME	Enter date and time for LCD display and to print on transmissions.	2000 1/1 00:00	23
3. STATION ID	Program name, fax number to appear on each transmitted page.	—	24
4. BEEPER	Adjust volume level of beeper.	LOW	27
5. VOLUME AMPLIFY	For the hearing-impaired, you can set the volume to AMPLIFY:ON, on either a permanent or temporary basis.	OFF	27
2. SETUP RECEIVE			
Function	Description	Factory Set	Page
1. RING DELAY	Number of rings before fax machine answers in FAX/TEL, FAX, or MC modes.	RING DELAY: 04 TOLLSAVER: OFF	33
2. F/T RING TIME	Sets the time for "double ring" in FAX/TEL mode.	20	33
3. EASY RECEIVE	Receive fax messages without pressing the Start key.	ON	34
4. REMOTE CODE	Enter code to activate or deactivate machine from a remote location.	ON (*51, #51)	35
5. POLLING RX	Sets up your fax machine to poll another fax machine.	OFF	36
6. MF LINK	Fax Receive Only/PC Primary/PC Receive Only.	PC PRIMARY	38

3. SETUP SEND			
Function	Description	Factory Set	Page
1. CONTRAST	Change lightness or darkness of a fax you are sending.	AUTO	40
2. RESOLUTION	Allows you to change resolutions page by page.	STANDARD	44
3. OVERSEAS MODE	Adjusts for sometimes difficult overseas transmissions	OFF	42
4. DELAYED FAX	Send documents later.	—	43
5. POLLED TX	Sets up your fax machine with a document to be retrieved by another fax machine.	OFF	45

4. CANCEL JOB			
Function	Description	Factory Set	Page
	Cancel a delayed fax or polling job.		37, 45

5. INTERRUPT			
Function	Description	Factory Set	Page
	Send a fax now, even if you have the machine set to send a fax later, or if you have it set for Polling.		46

6. SET AUTO DIAL			
Function	Description	Factory Set	Page
1. ONE-TOUCH DIAL	Dial numbers stored in memory by pressing only one key.	—	47
2. SPEED-DIAL	Dial numbers stored in memory by pressing only three keys.	—	49
3. SETUP GROUPS	Set up a Group number for broadcasting.	—	51

7. PRINT REPORTS

Function	Description	Factory Set	Page
1. XMIT REPORT		OFF	79-80
2. ALL DIAL	Print lists and reports of activity. (Details in Chapter 12)	—	79-80
3. TEL. INDEX		—	79-80
4. USER SETTINGS		—	79-80
5. MEMORY STATUS		—	79-80

8. SETUP MSG CTR

Function	Description	Factory Set	Page
1. MSG STORAGE	Select if memory will store fax, voice or both.	FAX: OFF VOICE: ON	58
2. BACKUP PRINT	Prints copy of faxes received into memory.	ON	61
3. OGM	Select/Record outgoing message.	MSG CTR OGM	59
4. ICM MAX. TIME	Select maximum length of incoming messages.	30 seconds	62
5. ICM REC. MONITR	Select ON or OFF for voice messages as they come in.	ON	63
6. FAX FWD/PAGING	Set fax to forward fax/message — OR —to call your pager.	OFF	64
7. REMOTE ACCESS	Set code for retrieving messages.	159✳	66

0. TEL SERVICE

Function	Description	Factory Set	Page
1. DISTINCTIVE	Use with phone company distinctive ringing service to register the ring pattern with fax machine.	OFF	71
2. CALLER ID (For USA only)	Register your AREA CODE to dial from log.	000	26

4 Initial Setup

Getting Started

Setting Dialing Mode (Tone/Pulse)

Your fax machine comes set to accommodate tone (multi-frequency) dialing service. If you have pulse (rotary) dialing service, you need to change the dialing mode.

- 1 Press **[Function]**, **[1]**, **[1]**.

DIALING: TONE?

DIALING: PULSE?

- 2 Use **[Left Arrow]** or **[Right Arrow]** to select TONE or PULSE and press **[Set]**.
- 3 Press **[Stop]** to exit.

Setting Date and Time

Your fax machine displays the date and time, and prints it on every fax you send.

In the event of a power failure, the fax machine maintains date and time information for up to two hours. All other settings remain unaffected.

- 1 Press **[Function]**, **[1]**, **[2]**.

ENTER YEAR: XX

- 2 Enter the last two digits of the year and press **[Set]**.

ENTER MONTH: XX

- 3 Enter two digits for the month (for example, enter 09 for September, or 10 for October) and press **[Set]**.

ENTER DAY:XX

- 4 Enter two digits for the day (for example, 06) and press **[Set]**.

ENTER TIME:XX:XX

- 5 Enter the time in 24-hour format (for example, enter 15:25 for 3:25 PM) and press **[Set]**.
- 6 Press **[Stop]**. The screen now displays the date and time you set, and displays it whenever the fax machine is standing by.

Setting Station ID

You can store your name and fax number to be printed on all fax pages.

- 1 Press **[Function]**, **[1]**, **[3]**.

FAX:

- 2 Enter your fax number (up to 20 digits) and press **[Set]**.

NAME:

- 3 Use the dial pad to enter your name or company name (up to 20 characters) and press **[Set]**.
- 4 Press **[Stop]**. The screen returns to the date and time.

*See
Entering Text
p. 25*

Entering Text

When you are setting certain functions, such as the Station ID, you may need to enter text into the fax machine. Most keys on the dial pad have three or four letters printed above them. The keys for 0, # and * don't have printed letters because they are used for special characters.



By pressing the appropriate number on the dial pad the correct number of times, you can access the character you want.

Press Key	one time	two times	three times	four times
2	A	B	C	
3	D	E	F	
4	G	H	I	
5	J	K	L	
6	M	N	O	
7	P	Q	R	S
8	T	U	V	
9	W	X	Y	Z

Inserting Spaces

If you want to enter a blank space, press  twice.

Making Corrections

If you entered a letter incorrectly and want to change it, press  to move the cursor after the last correct letter. Then press ; the letters above and to the right of the cursor are deleted. Re-enter the correct text and/or digits. You can also back up and type over incorrect letters.

Repeating Letters

If you need to enter a character assigned to the same key as the previous character, press  to move the cursor to the right.

Special Characters and Symbols

Press * for (space) ! " # \$ % & ' () * + , - . /

Press # for : ; < = > ? @ [] ^ _

Press 0 for É À È Ê Î Ç Ë Ö 0

NOTICE

The Telephone Consumer Protection Act of 1991 makes it unlawful for any person to use a computer or electronic device to send any message via a telephone fax machine unless such messages clearly contain, in a margin at the top or bottom of each transmitted page, or on the first page of the transmission, the date and time it is sent and an identification of the business or other entity or other individual sending the message and the telephone number of the sending machines or such business, other entity or individual.



In order to program this information into your fax machine, complete the steps described on pages 23–25.



- If you do not enter a fax number, no additional information can be entered.
- To enter a space, press  once between numbers and twice between characters.
- If your Station ID has already been programmed, the screen prompts “1” to make a change, or “2” to exit without changing.

Setting Up Your Area Code (For USA Only)

You must set up your area code in Caller ID.

- 1 Press , , .

AREA CODE: 000

- 2 Use the dial pad to enter your area code and press .

AREA CODE: 908

- 3 Press  to exit.

Setting Beeper Volume

You can set the beeper to LOW, HIGH or OFF. The default setting is **LOW**. When the beeper is set to LOW or HIGH, the fax machine beeps every time you press a key or make an error, and at the end of fax sending or receiving.

- 1 Press **[Function]**, **[1]**, **[4]**.
- 2 Press **[◀]** or **[▶]** to select your setting and press **[Set]**.
- 3 Press **[Stop]** to exit.

Setting the Handset Volume

Before you begin to use the fax machine, you must decide if you need to set the handset volume to AMPLIFY:ON for a user who is hearing-impaired. The AMPLIFY volume level complies with FCC standards.

VOLUME AMPLIFY: OFF

This default setting is appropriate if none of the users are hearing-impaired. During a conversation, users can press **[L▶]** or **[▶H]** on the control panel to adjust the volume. When the handset is replaced, the handset volume remain until you change it again.

VOLUME AMPLIFY: ON-TEMPORARY

This setting is appropriate if *some* of the users are hearing-impaired. During a conversation, users can press **[L▶]** or **[▶H]** on the control panel to adjust the volume to LOW, HIGH or AMPLIFY. When the handset is replaced, the handset volume will returns to the default setting of LOW.

VOL AMPLIFY:ON-PERMANENT

Choose VOL AMPLIFY:ON-PERMANENT if *all* of the users are hearing-impaired. During a conversation, users can press **[L▶]** or **[▶H]** on the control panel to adjust the volume to LOW, HIGH or AMPLIFY. When the handset is replaced, the handset volume returns to the default setting of AMPLIFY.



When you press **[L▶]** or **[▶H]** on the control panel to adjust the volume, the display shows the setting you are choosing. Each key press changes the volume to the next setting.



It is important that you do not choose PERMANENT unless all users are hearing-impaired. Otherwise, the default setting of AMPLIFY may damage the hearing of some users.

Setting Volume Amplify

Please carefully read “Setting the Handset Volume” before you do the following steps:

- 1 Press **[Function]**, **[1]**, **[5]**.



- 2 Press **[Left Arrow]** or **[Right Arrow]** to select **VOL AMPLIFY:OFF?** if none of the users are hearing-impaired and go to Step 4—**OR**—If some or all of the users are hearing-impaired, select **VOL AMPLIFY:ON?**.



- 3 Press **[Left Arrow]** or **[Right Arrow]** to select **PERMANENT?** if all the users are hearing-impaired—**OR**—Select **TEMPORARY?** if only some of the users are hearing-impaired.
- 4 Press **[Set]**.
- 5 Press **[Stop]** to exit.

Setting the Speaker Volume

You can adjust the speaker volume when your fax machine is onhook (after you pressed **[Speaker Phone]**), by selecting a speaker volume level.

Press **[L]** or **[H]** to adjust the volume level. The display shows the setting you are choosing. Each key press changes the volume to the next setting. The new setting will remain until you change it again.





You can adjust the speaker volume while you are listening to your OGM (Outgoing Message) and ICMs (incoming messages).

If you turn the Incoming Recording Monitor to OFF (**[Function]**, **[8]**, **[5]**), the Speaker for screening calls will be disabled and you will not be able to hear callers leaving messages. The volume for other operations can still be controlled using **[L]** and **[H]**.

Setting the Ring Volume

You can adjust the ring volume when your fax machine is idle. You can select a ring volume level or press until the ring is off.

Press  or  to adjust the volume level. With each key press, the fax machine rings so you can hear the current setting and the display shows the setting you are choosing. Each key press changes the volume to the next setting. The new setting will remain until you change it again.

Memory Storage

In the event of a power failure, all settings in the INITIAL SETUP, SETUP RECEIVE and SET AUTO DIAL plus SETUP MSG CTR functions are stored permanently. You may have to reset the date and time.

5 Setup Receive

Basic Receiving Operations

Select Answer Mode

*See
Distinctive
Ring
p. 71*

MANUAL—You must answer all calls yourself. If you hear fax tones, press **[Start]** to begin receiving the fax, then hang up. You *must* use this mode with Distinctive Ringing.

FAX ONLY—The fax machine automatically answers every call as a fax call. You cannot receive a voice call, but you can dial out and make a voice call.

*See
For FAX/TEL
Mode Only
p. 35*

FAX/TEL—The fax machine automatically answers every call. If the call is a fax, it prints the fax. If the call is not a fax, it signals you with a double ring (ring-ring), different from the phone company ringing, to alert you to pick up the call. If you select this setting, you'll need to set the Ring Delay and F/T Ring Time features (on the following pages). If you have extension phones on the same line as the fax machine, set the Ring Delay to 4.

MSG CTR—The fax machine provides you with a built-in digital Message Center for fax and voice. When you set the machine to answer calls, it will record up to 15 minutes of messages. For more information about Message Center (MSG CTR) operation, please see Chapter 9.

Current
Answer Mode



MNL: MANUAL
FAX: FAX ONLY
F/T: FAX/TEL

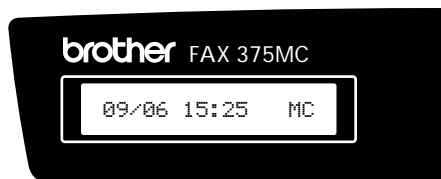
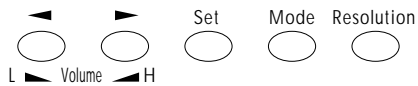

MC: MSG CTR



To select or change your Answer Mode

- 1 Press **[Mode]**. The screen displays your current selection.

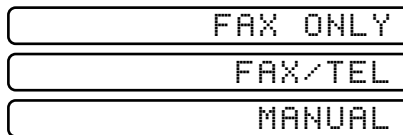

Or, if Message Center Mode is ON, it overrides your Answer Mode Setting, so the display shows:



- 2 Continue to press **[Mode]** until your new selection appears. After 2 seconds, the screen returns to the date and time display, along with your new Answer Mode setting.



If you're changing Answer Mode while in another operation, the screen returns to the current operation display.

See
Easy Receive
 p. 34
 and
*Operation from
 Extension
 Telephone*
 p. 35
 and For
*FAX/TEL
 Mode Only*
 p. 35

Setting Ring Delay

The Ring Delay setting determines the number of times the fax machine rings before it answers. If you have extension phones on the same line as the fax machine, keep the Ring Delay default setting of 4.

- 1 Press **[Function]**, **[2]**, **[1]**.
- 2 Press **[◀]** or **[▶]** to select Ring Delay and press **[Set]**.
- 3 Press **[◀]** or **[▶]** to select how many times the line rings before the fax machine answers (00 – 04). If you select 00, the line doesn't ring at all and press **[Set]**.
- 4 Press **[Stop]** to exit.

Setting F/T Ring Time

You need to determine how long the fax machine will notify you with its special double ring when you have a voice call. This double-ringing (F/T Ring Time) happens *after* the initial ringing from the telephone company (Ring Delay). Only the fax machine rings, for 20, 30, 40 or 70 seconds; no other phones on that number will ring the special double-ring. However, you can answer the call on any extension phone on the same phone number as the fax machine.

- 1 Press **[Function]**, **[2]**, **[2]**.
- 2 Press **[◀]** or **[▶]** to select how long the fax machine will ring to alert you that you have a voice call and press **[Set]**.

RING TIME: 20 SEC

- 3 Press **[Stop]** to exit.

Now, when a call comes in and the machine is set to FAX/TEL mode, all phones on this line will ring the number of times you selected in Ring Delay.

You can let the fax machine pick up and detect if it's a fax or voice call. If it's a fax call, the machine prints the fax. If it's a voice call, the machine signals you with a double ring for the length of time you selected in F/T Ring Time.

Even if the caller hangs up during the double ringing, the fax machine continues for the set time.



Record FAX/TEL Outgoing Announcement (F/T OGM)

This is the announcement played by your fax machine (not an external TAD) when someone calls and your machine is set to FAX/TEL mode. Although callers hear your announcement, they cannot leave a message. To erase the announcement, follow the directions on page 59. "Erasing Outgoing Message."

- 1 Press **[Function]**, **[8]**, **[3]**. The screen prompts you to choose F/T OGM or MSG CTR OGM.
- 2 Press **[◀]** or **[▶]** to select F/T OGM (not MSG CTR OGM) and press **[Set]**.
- 3 Press **[Record]**, then pick up the handset to record a message.
- 4 Replace the handset. Your OGM is played.
- 5 Press **[Stop]** to exit.

Easy Receive

When you use this feature, you don't have to press **[Start]** when you answer a fax call and hear calling beeps. Just hold the handset and wait a few seconds. When you see RECEIVE on the fax screen or when you hear "chirps" through the handset of an extension phone connected to another wall jack, just replace the handset, and your machine does the rest. Selecting **ON** allows the fax machine to receive fax calls automatically, even if you lift the handset of an extension or external phone. Selecting **SEMI** lets the machine receive the call only if you've answered it at the fax machine. Selecting **OFF** means you'll have to activate the fax machine yourself, by pressing **[Start]** or by pressing **[*] [5] [1]** if you are not at your machine.

If you've set the feature to **ON**, but your fax machine doesn't automatically connect a fax call when you lift an external or extension phone handset, press the Fax Receive code **[*] [5] [1]**. At the fax machine, lift the handset and press **[Start]**.

- 1 Press **[Function]**, **[2]**, **[3]**.
- 2 Use **[◀]** or **[▶]** to select **ON**, **SEMI** or **OFF** and press **[Set]**.
- 3 Press **[Stop]** to exit.

*See
Operation from
Extension
Telephone
p. 35*

*For FAX/TEL
Mode Only
p. 35*

Advanced Receiving Operations

See
Easy Receive
p. 34

See
Setting F/T
Ring Time
p. 33

Operation from Extension Telephone

If you answer a fax call on an extension phone or on an external phone in the EXT. jack, you can make your fax machine take over by using the Fax Receive Code. When you press the Fax Receive Code **[*] [5] [1]**, the fax machine starts to receive a fax.

If the fax machine answers a voice call and double-rings for you to take over, use the Telephone Answer Code **[#] [5] [1]** to take the call at an extension phone.

If you answer a call, and no one is on the line, assume you're receiving a fax. At the fax machine phone, press **[Start]**, then hang up. At an extension phone, press **[*] [5] [1]**, wait for fax receiving tones (chirps), then hang up. At an external phone, press **[*] [5] [1]** and wait for the phone to be disconnected (the screen displays RECEIVE) before you hang up. (Your caller will have to press **[Start]** to send the fax.)

For FAX/TEL Mode Only

When the fax machine is in FAX/TEL mode, it will use the F/T Ring Time (double ringing) to alert you to a voice call. If you're at the fax machine, you can lift the handset to answer.

If you're at an extension phone, you'll need to lift the handset during the F/T Ring Time and press **[#] [5] [1]** between the double rings. If no one is on the line, or if someone wants to send you a fax, send the call back to the fax machine by pressing **[*] [5] [1]**.

Changing Remote Codes

Remote Codes might not work with some telephone systems. The preset Fax Receive Code is **[*] [5] [1]**. The preset Telephone Answer Code is **[#] [5] [1]**.



If you are always disconnected when accessing your external TAD remotely, try changing the Fax Receive Code from **[*] [5] [1]** to **[#] [#] [#]** and the Telephone Answer Code from **[#] [5] [1]** to **[9] [9] [9]**.

To change Remote Codes

1 Press **[Function]**, **[2]**, **[4]**.

2 Press **[◀]** or **[▶]** to select ON (or OFF) and press **[Set]**.

REMOTE ACT.: ON?

3 If you want to, enter a new Fax Receive Code, then press **[Set]**.

FAX RECEIVE: *51

4 If you want to, enter a new Telephone Answer Code, then press **[Set]**.

TEL ANSWER: #51

5 Press **[Stop]** to exit.

Polling



Polling is the process of retrieving faxes from another fax machine. You can use your fax machine to “poll” other machines, or you can have someone poll your machine.

All parties involved in polling need to set up their fax machines to accommodate polling. When someone polls your machine to receive a fax, they pay for the call; if you poll someone’s fax machine to receive a fax, you pay for the call.



Some fax machines do not respond to the polling function.

Setting Up Polling Receive

Polling Receive is when you call another fax machine to receive a fax from it.

1 Press **[Function]**, **[2]**, **[5]**.

POLLING RX: OFF?

SELECT ← → & SET

2 Press **[◀]** or **[▶]** to choose ON and press **[Set]**.

ENTER FAX NO.

PRESS START KEY

3 Enter the fax number you are polling.

4 Press **[Start]**. The screen displays DIALING.

Setting Up Sequential Polling Receive

Your fax machine can request documents from several fax units in a single operation. Afterward, a Sequential Polling Report will be printed.

- 1 Press **[Function]**, **[2]**, **[5]**.

POLLING RX: OFF?
SELECT ← → & SET

- 2 Press **[Left Arrow]** or **[Right Arrow]** to select Polling ON and press **[Set]**.

POLLING RX: ON?
ENTER FAX NO.
PRESS START KEY

- 3 Specify the destination fax machines you wish to poll, using One Touch, Speed Dial, a Group or the dial pad.

- 4 Press **[Start]**.

ACCEPTED

Your fax machine will poll each number or group member in turn for a document.

DIALING

Canceling a Scheduled Job

You can cancel tasks you've scheduled, such as sequential Polling Receive.

- 1 Press **[Function]**, **[4]**. Any waiting jobs appear on the display. If no job is waiting, the screen displays NO JOB WAITING.

4. CANCEL JOB

- 2 If you have more than two jobs waiting, use **[Left Arrow]** or **[Right Arrow]** to select the job you want to cancel and press **[Set]**.

—OR—

If you have only one job waiting, go to Step 3.

- 3 Press **[1]** to cancel—OR—Press **[2]** to exit without canceling. To cancel another job, return to Step 2.
- 4 Press **[Stop]** to exit.

*See
Multi-Function
Link® (option)
p. 95*

Setting Multi-Function Link® Mode (With Multi-Function Link® option)

If you connect your fax machine to your PC, you can receive faxes into your PC. See the Multi-Function Link® manual for instructions. After completing all setup for Multi-Function Link®, you can select Multi-Function Link® Mode (PC Primary/PC Receive Only/Fax Receive Only) for routing incoming faxes.

- 1** Press **[Function]**, **[2]**, **[6]**.

6.MF LINK

- 2** Press **[◀]** or **[▶]** to select PC PRIMARY, PC RECEIVE ONLY or FAX RECEIVE ONLY and press **[Set]**.
- 3** Press **[Stop]** to exit.

Setup Send

Before You Begin

- Documents must be between 5.8 and 8.5 inches (148 and 216 mm) wide, and 5.9 and 23.7 inches (150 and 600 mm) long. Your fax machine can only scan an image 8.2 inches (208 mm) wide, regardless of how wide the paper is.
- Make sure you insert documents **face down, top edge first**.
- Adjust the paper guides to fit the width of your document.

Paper guides

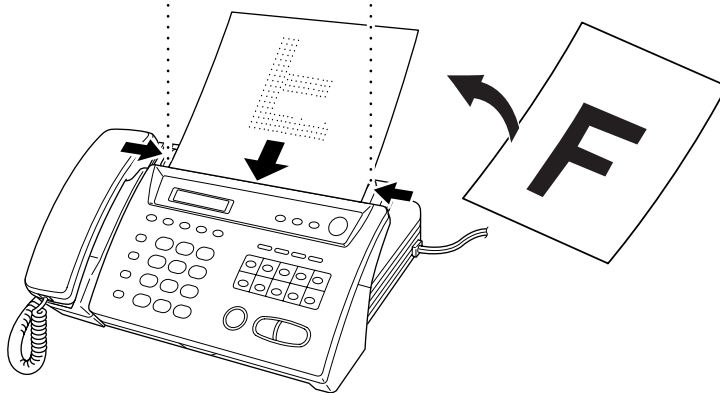

- **DO NOT** use curled, wrinkled, folded or ripped paper, or paper with staples, paper clips, paste or tape attached. **DO NOT** use cardboard, newspaper or fabric.
- Make sure documents written with ink are completely dry.

ADF (Automatic Document Feeder)

The automatic document feeder (ADF) can hold up to 10 pages, feeding each one individually through the fax machine. Use standard (17 lb–24 lb) paper when using the ADF; if you're using heavier paper, feed each sheet individually to prevent paper jams.

Resolution

*See
Multiple
Resolution
Transmission
p. 44*

Press **[Resolution]** (before you send the fax) to select the resolution for the document you're sending.

Standard—suitable for most typed documents.

Fine—good for small print; transmits a little slower than standard resolution.

S. Fine (Super Fine)—good for small print or artwork; transmits slower than fine resolution.

Photo—use when document has varying shades of gray; slowest transmission time.

If the receiving fax machine does not have the resolution you select, the transmission will fall back to the next available resolution on receiving machine.

Contrast

If your document is very light or very dark, you might want to set the contrast accordingly. Use S.LIGHT to send a very light document. Use S.DARK to send a very dark document.

- 1 Insert the document, face down, in the feeder.
- 2 Press **[Function]**, **[3]**, **[1]**.
- 3 Use **[◀]** or **[▶]** to select AUTO, S.LIGHT or S.DARK and press **[Set]**.

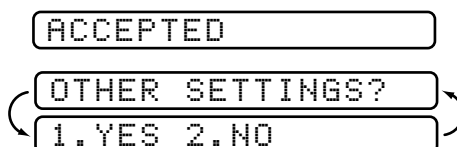

- 4 Press **[2]** if you are finished choosing settings, and go to Step 5—**OR**—Press **[1]** if you want to select additional settings. The display returns to the Setup Send menu.
- 5 Enter a fax number and press **[Start]** to send a fax.

To set the contrast for a copy, press **[Copy]** in Step 5.



Manual Transmission

Manual transmission lets you hear the dial tone, ringing and fax receiving tones before sending the fax.

- 1 Insert the document face down in the feeder.
- 2 Pick up the handset and listen for a dial tone
—OR—Press **Speaker Phone** and listen for a dial tone.
- 3 Enter the fax number you want to call (you can enter the digits using the dial pad, or you can enter a One Touch or Speed Dial number or you can call from the Tel-index).
- 4 When you hear the fax tone, press **Start**.
- 5 If you're using the handset, hang up.

*See
One-Touch
Dialing
p. 54*

Automatic Transmission

This is the easiest way to send a fax. **IMPORTANT:** Do **not** pick up the handset, or press **Speaker Phone**.

- 1 Insert the document face down in the feeder.
- 2 Enter the fax number from One Touch, Speed Dial, Tel-index or the dial pad.
- 3 Press **Start**.

*See
Speed Dialing
p. 54*

Manual and Automatic Fax Redial

If you're sending a fax manually and the line is busy, press **Redial/Pause** to retry the number.

If you're sending a fax automatically and the line is busy, the fax machine will redial automatically up to three times at 5 minute intervals.

Advanced Sending Operations

Overseas Mode

If you have difficulty sending a fax overseas, use the Overseas mode.

After you send a fax using this feature, the feature turns itself off.

- 1 Insert document.
- 2 Press **Function**, **3**, **3**.

3. OVERSEAS MODE

- 3 Press **◀** or **▶** to select ON (or OFF) and press **Set**.

ACCEPTED

OTHER SETTINGS?

1. YES 2. NO

- 4 Press **1** if you want to select additional settings. The display returns to the Setup Send menu—**OR**—Press **2** if you are finished choosing settings and go to Step 5.
- 5 Enter the fax number you're calling.
- 6 Press **Start**.

Quick Scan Fax Transmission

You can scan a fax into the fax machine's memory to be sent as soon as the scan is complete. This way, you don't have to wait for the entire fax to be transmitted before you retrieve your original.

If you get a "MEMORY FULL" message while scanning the first page of a fax, press **Stop** to cancel the scan. If you get a "MEMORY FULL" message while scanning in a subsequent page, you'll have the option to press **Start** to transmit the pages scanned so far, or to press **Stop** to cancel the Quick Scan operation.

- 1 Insert the document in the feeder.
- 2 Press **Help/Q.Scan**. The screen indicates how much memory is available.
- 3 Enter the fax number.
- 4 Press **Start** to begin scanning the document into memory. Once the scan is completed, the fax machine dials the call.

Delayed FAX

You can use this function to send a fax up to 24 hours later.

- 1 Insert the document in the feeder.
- 2 You can press **[Help/Q.Scan]** to use memory transmission.
- 3 Press **[Function]**, **[3]**, **[4]**.
- 4 Enter the time you want the fax to be sent, in 24-hour format (for example, enter 19:45 for 7:45 PM) and press **[Set]**.

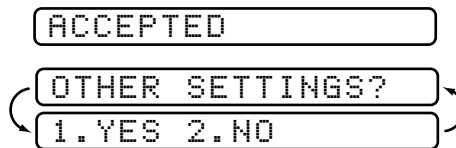

- 5 Press **[1]** if you want to select additional settings. The display returns to the Setup Send menu—**OR**—Press **[2]** if you are finished choosing settings and go to Step 6.

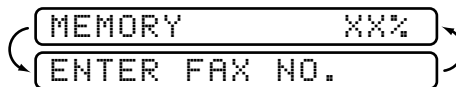

- 6 Enter the fax number.
- 7 Press **[Start]**. The fax machine will wait until the time you have entered to send the fax.

Broadcasting

Using the numbers you have stored in Groups, One Touch and Speed Dial memory, you can “broadcast” faxes automatically to a maximum of 60 different locations in a few simple steps.

After the Broadcast is completed, a Broadcast Report will be printed automatically to let you know the results.

- 1 Insert the document in the feeder.
- 2 Press **[Help/Q.Scan]**. The screen displays how much memory is available.
- 3 Enter the One Touch and Speed Dial numbers (one after the other) or a Group Number you have stored.
- 4 Press **[Start]**. The fax machine scans the document into memory, then transmits it to all the numbers you entered. If the line is busy, your machine will retry.

Press **[Stop]** during transmission to cancel sending to the current number.

*See
Setting Up
Groups for
Broadcasting
p. 51*



Next-Fax Reservation

Even if your fax machine is receiving another fax, you can set your machine to send your fax next. This way, you don't have to wait for it to finish sending or receiving the other fax. You can dial this fax call manually, or by using Redial, One Touch, Speed Dial, or Chain dialing. (When you use One Touch and Speed Dial, only the memory location—not the name of the person you're calling—is displayed.)

- 1 Insert the documents in the feeder. If necessary, press **[Resolution]** to adjust resolution.
- 2 Enter the fax number.
- 3 Press **[Start]**.
- 4 Press **[Set]**.

NEXT-FAX RESERVD

To cancel the reservation, remove the documents and press **[Stop]**.

You can't use this feature if there is a document waiting in the feeder (possibly for Delayed Fax or Polling Transmit).

Multiple Resolution Transmission

Use this feature to select separate resolution settings for each page of the fax you're sending. This could be useful if you're sending a fax with photos and letters, or some pages with small print and others with normal print. Resolution settings return to STANDARD after the fax is sent.

- 1 Insert documents in the feeder, then press **[Function]**, **[3]**, **[2]**.
- 2 Use **[◀]** or **[▶]** to select resolution for page 1, then press **[Set]**.
- 3 Repeat Step 2 for subsequent pages.
- 4 Press **[Stop]** when you're finished.

ACCEPTED

OTHER SETTINGS?

1. YES 2. NO

- 5 Press **[1]** if you want to select additional settings. The display returns to the Setup Send menu—**OR**—Press **[2]** if you are finished choosing settings, and go to Step 6.
- 6 Enter the fax number you're calling.
- 7 Press **[Start]**.

To copy a document using multiple resolutions, press **[Copy]** in Step 6.



*See
Resolution
p. 40*



Setting Up Polling Transmit

Polling Transmit is when you set up your fax machine to wait with a document so another fax machine can retrieve it.

- 1 Place document to be retrieved in the feeder.
- 2 Press **[Function]**, **[3]**, **[5]**.

POLLED TX:OFF?
SELECT ← → & SET

- 3 Press **[Left Arrow]** or **[Right Arrow]** to choose ON and press **[Set]**.

ACCEPTED
OTHER SETTINGS?
1. YES 2. NO

- 4 Press **[1]** if you want to select additional settings. The display returns to the Setup Send menu—**OR**—Press **[2]** if you are finished choosing settings and go to Step 5.
- 5 Press **[Start]**. The screen displays POLLED WAITING.

You can choose to have the document waiting in memory, by pressing **[Help/Q.Scan]** before pressing **[Start]**.



Canceling a Scheduled Job

You can cancel tasks you've scheduled, such as Delayed Fax or Polling Transmit.

- 1 Press **[Function]**, **[4]**. Any waiting jobs appear on the display. If there is no job waiting, the screen displays NO JOB WAITING.

4. CANCEL JOB

- 2 If you have more than two jobs waiting, use **[Left Arrow]** or **[Right Arrow]** to select the job you want to cancel and press **[Set]**.

—**OR**—

If you have only one job waiting, go to Step 3.

- 3 Press **[1]** to cancel—**OR**—Press **[2]** to exit without canceling.
- 4 Press **[Stop]** to exit.

Interrupting Delayed Fax and Polling Transmit Jobs

You can send a fax or make a copy now, even if you have the fax machine set to send a fax later, or if you have it set to be polled. However, you cannot use automatic redial or the function mode.

- 1 Press **[Function]**, **[5]**.
- 2 Wait 2 seconds, then remove the documents that are waiting in the feeder.

INSERT DOCUMENT

- 3 Place the document you want to send now in the feeder.
- 4 Enter the number for the fax you want to send now.
- 5 Press **[Start]**.
- 6 After the transmission is finished, return the first document to the feeder.
- 7 Press **[Function]**, **[5]** to restore the Delayed Fax and/or Polling.



If you have set up the Delayed Fax or Polling Transmit job in memory using **[Help/Q.Scan]**, you don't have to interrupt it to send a fax or make a copy.

Setup Auto Dial Numbers

Storing Numbers for Easy Dialing

You can set up your fax machine to do three types of easy dialing: One Touch, Speed Dial, and Groups for Broadcasting of faxes.

Storing One Touch Dial Numbers

*See
One Touch
Dialing
p. 54*

You can store ten fax/phone numbers that you can dial by pressing one key. You also can store names with these numbers. When you press a One Touch dial location, the screen displays the name or number as the call is dialed.

One Touch keys are not the dial pad keys. They are the ten keys (numbers 01–10) located to the right of the dial pad.

- 1 Press **[Function]**, **[6]**, **[1]**.
- 2 Press the One Touch key where you want to store a number. (One Touch key **[01]** is pre-programmed for Brother Fax-Back System, USA only. You can override it if you wish.)
- 3 Enter a number (up to 20 digits) and press **[Set]**. If you want to enter a pause in the dialing sequence (for example to wait for an “outside line”), press **[Redial/Pause]** as you’re entering digits. Pressing **[Redial/Pause]** enters a 3.5-second pause when the number is dialed, and a dash appears on the screen.

NAME :

- 4** Use the dial pad to enter the name (up to 15 characters) and press **[Set]**. You can use the chart on page 25 to help you enter letters—**OR**—Go to Step 5 to store the number without a name.

Use **[◀]** or **[▶]** to select the type you want and press **[Set]**.

FAX a fax only number

TEL a telephone (voice) number

FAX/TEL both a fax and telephone (voice) number

CHAIN a number (usually an access code) for chain dialing.

- 5** Return to Step 2 to store another One-Touch number—**OR**—Press **[Stop]** to exit.

When you dial an AUTO DIAL number, the screen displays the name you've stored, or, if you haven't stored a name, the number you've stored.



If you must wait for another dial tone at any point in the dialing sequence, store a pause at that point in the number by pressing **[Redial/Pause]**. Each key press adds a 3.5 seconds delay.

You can use chain dialing to store long dialing sequences. For example, to store **9 1 201 555 1234 987 65 4321**, divide the number into two parts. Store the first part as a Chain type number (this tells the system that the dialing sequence is not complete).

CHAIN—9 1 201 555 1234

The last part of the One-Touch number must be stored as any of the other following three types.

FAX or FAX/TEL or TEL—987 65 4321

Now, when you dial, just press the two keys (one after the other, in order) where you've stored the two parts of the number.

Access Codes and Credit Card Numbers

Sometimes you may want to choose from among several long distance carriers when you make a call. Rates may vary depending upon the time and destination. To take advantage of low rates, you can store the access codes or long-distance carriers as One Touch numbers. You can store these long dialing sequences by dividing them and setting them up on separate keys in any combination. You can even include manual dialing using the dial pad. The combined number will be dialed in the order you entered it, as soon as you press **[Start]**.

*See
Storing
One Touch Dial
Numbers
p. 47*

You can store "555" on One Touch key **[03]** and "7000" on One Touch key **[02]**. If you press One Touch **[03]**, **[02]**, and **[Start]**, you can dial "555-7000". To temporarily change a number, you can substitute part of the number with manual dialing using the dial pad. For example, to change the number to 555-7001 you could press One Touch **[03]** and press **[7]**, **[0]**, **[0]**, **[1]** using the dialing pad.

Storing Speed Dial Numbers

*See
Speed Dialing
p. 54*

You can store Speed Dial numbers, so when you dial you only have to press three keys. There are 50 Speed Dial locations. Even if you lose electrical power, numbers stored in memory will not be lost.

- 1 Press **[Function]**, **[6]**, **[2]**.

SPEED-DIAL? #

- 2 Use the dial pad to enter a two-digit location and press **[Set]** (01–50).

#05:
ENTER & SET

- 3 Enter the number you're storing (up to 20 digits) and press **[Set]**.

NAME:
ENTER & SET

- 4 Use the dial pad to enter the name (up to 15 characters) and press **[Set]**. You can use the chart on page 25 to help you enter letters—**OR**—Press **[Set]** and go to Step 5 to store the number without a name.

- 5 Use **[Left Arrow]** or **[Right Arrow]** to select the type you want and press **[Set]**.

FAX a fax number

TEL a telephone (voice) number

FAX/TEL both a fax and telephone number

CHAIN a number (usually an access code) for chain dialing

- 6 Return to Step 2 to store another Speed Dial number—**OR**—Press **[Stop]** to exit.

Changing One Touch and Speed Dial Numbers

If you try to store a One Touch or Speed Dial number in a location where a number is already stored, the screen displays the current name stored there, then prompts you to either

1. CHANGE—OR—2. EXIT.

- 1 Press **[1]** to change the number stored, or press **[2]** to exit without making a change.
- 2 Enter a new number and press **[Set]**.
 - If you want to erase the whole number, press **[Stop]** when the cursor is to the left of the digits. The letters above and to the right of the cursor are deleted.
 - If you want to change a digit, use **[◀]** or **[▶]** to position the cursor under the digit you want to change, then type over it.
- 3 Follow the directions from Step 3 in Storing One Touch Numbers or in Storing Speed Dial Numbers.

See
Storing
One Touch Dial
Numbers
p. 47
and
Storing Speed
Dial Numbers
p. 49
and
Broadcasting
p. 43

Setting Up Groups for Broadcasting

Groups allow you to send the same fax message to many fax numbers by pressing only one One Touch key (Broadcasting). **First**, you'll need to store each fax number as a One Touch or Speed Dial number. **Then**, you can combine them into a Group. Each Group uses up a One Touch key. Finally, you can have up to six small Groups, or you can assign up to 59 numbers to one large Group.

- 1 Press **[Function]**, **[6]**, **[3]**.

SELECT ONE-TOUCH

- 2 Select a One Touch key where you wish to store the number. (For example, press One Touch key **[02]**.)

SETUP GROUP: GO
ENTER & SET

- 3 Use the dial pad to identify the Group number and press **[Set]**. (For example, press **[1]** for Group 1).
- 4 To include One Touch or Speed Dial numbers in the Group, enter them as if you were dialing and press **[Set]**. For example, for One Touch key **[05]**, press One Touch key **[05]**. For Speed Dial location 09, press the Speed Dial button, then press **[0]**, **[9]** on the dial pad. The LCD shows *05, #09.

G01: *05#09_

NAME:
ENTER & SET

- 5 Use the dial pad and the chart on page 25 to enter a name for the group and press **[Set]**. (For example, NEW CLIENTS).
- 6 Press **[Stop]** to exit.

You can print a list of all One Touch and Speed Dial numbers. See Chapter 12, Printing Reports.



Telephone Operation

Dialing Options

You can use your fax machine to make voice telephone calls, by dialing manually, or by using Tel-index, One Touch or Speed Dial memory. You can use the handset, or you can use the Speaker Phone to make and receive calls.

The Speaker Phone allows you to operate the phone hands free, or allows more than one person in the room to participate in a two-way telephone conversation. When using the Speaker Phone, make sure to speak clearly and close to the microphone.

Manual Dialing

Manual dialing is simply pressing all of the digits of the phone number.

- 1** Pick up the handset—**OR**—Press **Speaker Phone**.
- 2** When you hear a dial tone, dial the call, using the dial pad.
You can switch from handset to Speaker Phone by pressing **Speaker Phone**, then replacing the handset. You can switch from Speaker Phone to handset by lifting the handset.
- 3** To hang up a voice call, replace the handset—**OR**—Press **Speaker Phone**.

See
Storing One
Touch Dial
Numbers
p. 47

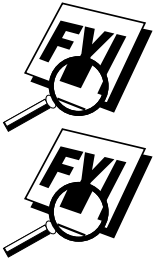

One Touch Dialing

- 1 Pick up the handset—**OR**—Press **[Speaker Phone]**.
- 2 When you hear a dial tone, press the One Touch key of the location you want to call.
- 3 To hang up a voice call, replace the handset—**OR**—Press **[Speaker Phone]**.
If you try to use a One Touch location with no number stored in it, you hear a warning sound, and screen displays NOT REGISTERED. The display returns to normal after 2 seconds.
If you are sending a fax, press **[Start]** after pressing the One Touch key. If you picked up the handset, press **[Start]** when the receiving fax machine answers with fax tones.

Speed Dialing

See
Storing Speed
Dial Numbers
p. 49



- 1 Pick up the handset—**OR**—Press **[Speaker Phone]**.
- 2 When you hear a dial tone, press **[Speed Dial]**, then press the two-digit Speed Dial number.
- 3 To hang up, replace the handset—**OR**—Press **[Speaker Phone]**.
If you are sending a fax, press **[Start]** after entering the Speed Dial number. If you picked up the handset, press **[Start]** when the receiving fax machine answers with fax tones.

Hold

- 1 Press **[Hold/Caller ID]** to put a call on Hold.
- 2 You can put down the handset without disconnecting the call.
- 3 Pick up the fax machine handset—**OR**—Press **[Speaker Phone]** to release the call from Hold. Picking up an extension handset will not release the call from Hold.

Pause

Press **[Redial/Pause]** to insert a pause between numbers. Each key press adds a 3.5 second delay.

Tone/Pulse

If you have pulse dialing service, but need to send tone signals (for telephone banking, for example), follow the directions below. If you have touch tone service, you do not need this feature to send tone signals.

- 1 Lift the handset.
- 2 Press **[#]**. Any digits dialed after this send tone signals.
- 3 When you hang up, the fax machine returns to pulse dialing service.

Searching Telephone Index

You can search for names you have stored in One Touch and Speed Dial memories. Names are stored alphabetically.

- 1 Press **[Tel-index]**, then enter the first letter of the name you're looking for.
- 2 Press **[◀]** or **[▶]** to search the memory.
- 3 When the screen displays the name you want to call, pick up the handset or press **[Speaker Phone]**.
- 4 Press **[Start]** to begin dialing.
- 5 When the call is over, hang up—**OR**—Press **[Speaker Phone]** to cancel the call.

Answering Calls with the Speaker Phone

When the fax machine rings, instead of lifting the handset, press **[Speaker Phone]**. Speak clearly, toward the microphone. To end the call, press **[Speaker Phone]**.

If you have a bad telephone line connection, the other party might hear your voice echoed during the call. Hang up and try the call again—**OR**—Pick up the handset.

*See
Storing One
Touch Dial
Numbers
p. 47
and
Storing Speed
Dial Numbers
p. 49*

Message Center

Message Center Mode

*See
Recording
Message Center
Outgoing
Message
p. 59*

Message Center Mode allows you to store incoming fax and voice messages in a flexible memory. The memory stores 15 minutes of voice messages, or up to 20 pages of fax memory. Any voice or fax message can be retrieved remotely. Memory is shared between fax and voice messages, which are stored on a “first-come, first-served” basis.

You must record an outgoing message in order to use the Message Center Mode.

Flexible Memory Settings (Message Storage)

Message Center Mode offers you six flexible memory settings, so that you can decide which kinds of messages you want to receive.

- 1. FAX:ON VOICE:ON** Both voice and fax messages are stored. You can use the Fax Forwarding or Paging features and retrieve voice and fax messages remotely.
- 2. FAX:ON VOICE:EXT** You need an external answering machine connected to the EXT jack for this setting. Fax messages are stored in the message center memory, but voice messages are stored in your external answering machine. Retrieve messages from the external answering machine. You cannot use the Paging feature for voice messages with this setting.
- 3. FAX:ON VOICE:OFF** All memory is used to store fax messages—no voice messages will be stored.

- 4. FAX:OFF VOICE:ON** All memory is used to store voice messages—no fax messages will be stored. Incoming faxes will print on paper. You can use the Paging feature, and retrieve voice messages remotely.
- 5. FAX:OFF VOICE:EXT** You need an external answering machine connected to the EXT jack for this setting. Incoming faxes are not stored in memory, but will print on paper. Voice messages are stored in the external answering machine.
- 6. FAX:OFF VOICE:OFF** Incoming faxes are not stored in memory, but will print on paper. Voice calls are not stored in memory.

Setting Up Message Center

You must set up Message Center in the following order:

See below

See p. 59

See p. 60

- 1** Turn Message Storage ON.
- 2** Record Message Center Outgoing Message (MSG CTR OGM).
- 3** Activate Message Center Mode.

Step 1: Setting Message Storage

Read the Flexible Memory Settings descriptions on pages 57–58 before you select the FAX and VOICE settings below:

- 1** Press **[Function]**, **[8]**, **[1]**.

The LCD display shows two lines of text. The top line reads "FAX: OFF?" and the bottom line reads "SELECT < > & SET". There are curved arrows on the left and right sides of the display, indicating that the left and right arrow keys can be used to navigate between the two lines.

- 2** Press **[Left Arrow]** or **[Right Arrow]** to select ON (or OFF) and press **[Set]**.

The LCD display shows two lines of text. The top line reads "VOICE: ON?" and the bottom line reads "SELECT < > & SET". There are curved arrows on the left and right sides of the display, indicating that the left and right arrow keys can be used to navigate between the two lines.

- 3** Press **[Left Arrow]** or **[Right Arrow]** to select your setting from the list on pages 57–58 (ON, OFF, EXT) and press **[Set]**.
- 4** Press **[Stop]** to exit.

Step 2: Recording Message Center Outgoing Message

Recording the Message Center Outgoing Message (MSG CTR OGM) is the second step you need to follow before you can turn on the Message Center. Make sure your OGM is less than 20 seconds long.

- 1 Press **[Function]**, **[8]**, **[3]**.



- 2 Press **[Left Arrow]** or **[Right Arrow]** to select MSG CTR OGM? and press **[Set]**.



This is the only setting you can select if you want to turn on the Message Center.

- 3 Press **[Record]**, then pick up the handset to record a message.

For example: *Hello. We are unable to take your call at this time. Please leave a message after the signal. If you wish to send a fax, please press * 5 1, wait for fax tones, then press the **Start** button.*

- 4 Replace the handset. The Message Center plays your OGM.
- 5 Press **[Stop]** to exit.

Listening to Outgoing Message (OGM)

- 1 Press **[Function]**, **[8]**, **[3]**.
- 2 Press **[Left Arrow]** or **[Right Arrow]** to select MSG CTR OGM (not F/T OGM) and press **[Set]**.
- 3 Press **[Play]** to hear the OGM. Adjust volume by pressing Speaker Volume **[L]** or **[H]**.
- 4 Press **[Stop]** to exit.

Erasing Outgoing Message (OGM)

- 1 Press **[Function]**, **[8]**, **[3]**.
- 2 Press **[Left Arrow]** or **[Right Arrow]** to select MSG CTR OGM (not F/T OGM) and press **[Set]**.
- 3 Press **[Erase]**.
- 4 Press **[1]** to erase the OGM—**OR**—Press **[2]** to exit without erasing.
- 5 Press **[Stop]** to exit.

Step 3: Activating Message Center Mode

*See Setting
Up Message
Center p. 58*

Press  until the screen displays

MC:MSG CTR

Message Indicator



The Message light flashes when you have voice messages and/or faxes waiting for your review. Once you listen to the message or print the fax, the light stops flashing.

The LCD screen displays the total number of voice (including memos) and/or fax messages stored in Message Center memory.

VOICE:03 FAX:02

Playing Voice Messages and Memos





Follow the steps below to listen to voice messages and memos.

- 1 Press . Adjust Volume by pressing arrow keys  or .

All messages and memos are played in the order they were recorded. The display shows the number of the current message, and the total number of messages.

If Caller ID information was received, the fax machine beeps during the message and displays the Caller ID information for one second.

During playback, the screen displays the time and date the message was recorded.

- 2 Press  (RWD) at the end of the message to repeat a message. Press  (FWD) to skip to the next message. You can press  and  repeatedly until you reach the message you want to play.
- 3 Press  to exit.

Printing a Fax Message

Once you print a new fax message stored in memory, it is erased from the memory automatically.

- 1 Press **[Play]**. After two seconds, the fax machine begins to play voice messages.
- 2 After playing voice messages, the display asks if you want to print fax messages that are in the memory. There is no display message if there are no faxes.

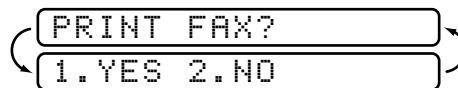

- 3 To print the faxes in memory, press **[1]**
—OR—
Press **[2]** to exit without printing.

Backup Printing Option

When you choose FAX: ON in the Message Center mode, all incoming fax messages are stored in the available memory for retrieval. To print a backup copy automatically, turn this option on.

- 1 Press **[Function]**, **[8]**, **[2]**.



- 2 Press **[Left Arrow]** or **[Right Arrow]** to display **ON** (or **OFF**) and press **[Set]**.
- 3 Press **[Stop]** to exit.

Erasing Messages

If you choose to erase all fax messages, the fax machine will print any previously unprinted fax messages before erasing them from memory. Fax messages cannot be erased individually.

You can erase voice messages and memos individually, or all at once.

To erase voice messages individually

- 1 Press **[Play]**. After two seconds, the fax machine beeps and begins message playback. Each message is preceded by one long beep, and followed by two short beeps.
- 2 To erase a specific message, press **[Erase]** immediately after the two short beeps, or while the message is playing.

```

ERASE THIS MSG.?
1.YES 2.NO
  
```

- 3 Press **[1]** to erase the message—**OR**—Press **[2]** to cancel.
- 4 Press **[Stop]** to exit.

To erase messages all at once

- 1 Press **[Erase]**. The screen displays **ERASE IS PRESSED**.

```

ERASE ALL VOICE?
SELECT ← → & SET
  
```

- 2 Press **[Left Arrow]** or **[Right Arrow]** to select erasing all voice messages (**VOICE**), all document messages (**FAX**), or all messages—both voice and fax—(**MSG**) and press **[Set]**.
- 3 Press **[1]** to erase—**OR**—Press **[2]** to cancel.
- 4 Press **[Stop]** to exit.

Setting Maximum Time for Incoming Messages

Your fax machine comes set to receive voice messages up to 30 seconds long. You can change this setting to any length from 20 seconds to 60 seconds, in 5-second increments. This setting also applies to the Memo.

- 1 Press **[Function]**, **[8]**, **[4]**.

```

MESSAGE 30 SEC?
SELECT ← → & SET
  
```

- 2 Press **[Left Arrow]** or **[Right Arrow]** to select the maximum time setting for incoming messages and press **[Set]**.
- 3 Press **[Stop]** to exit.

See
Setting
Ring Delay
p. 33



Setting Toll Saver

When you set the toll saver feature, the fax machine answers after four rings if you *don't* have messages, and after two rings if you *do* have messages. This way, when you call the fax machine, if it rings three times, you know you have no messages, and can hang up, avoiding any toll charge.

When Toll Saver is ON, it overrides your Ring Delay setting. Toll Saver must be off for the fax machine to operate using your Ring Delay setting.

- 1 Press **[Function]**, **[2]**, **[1]**.
- 2 Press **[◀]** or **[▶]** to select TOLL SAVER (or RING DELAY) and press **[Set]**.
- 3 Press **[◀]** or **[▶]** to select ON and press **[Set]**.
- 4 Press **[Stop]** to exit.

ICM Recording Monitor

This feature lets you turn OFF (or ON) the speaker volume for voice messages. When you turn the monitor OFF, you will not hear messages as they come in.

- 1 Press **[Function]**, **[8]**, **[5]**.
- 2 Use **[◀]** or **[▶]** to select OFF (or ON) and press **[Set]**.
- 3 Press **[Stop]** to exit.

Recording a Memo

A memo is stored and played as a voice message.

- 1 Press **[Record]**.
- 2 When the display prompts you to pick up the handset, speak into the handset to record your memo. Your recording can be as long as the Incoming Message Maximum Time (**[Function]**, **[8]**, **[4]**).
- 3 Press **[Stop]** or replace the handset when you're finished.

Recording a Conversation

You can record a telephone conversation by pressing **[Record]** during the conversation. Your recording can be as long as the Incoming Message Maximum Time. You and the other party will hear a beep every 15 seconds while recording. You cannot record a conversation using Speaker Phone.

Fax Forwarding/Paging

When Paging is set to ON, your fax machine dials the pager number you've programmed, and dials your Personal Identification Number (PIN) when connected, to activate your pager and let you know you have a fax or voice message in the Message Center memory.

When Fax Forwarding is set to ON, your fax machine dials the fax machine phone number you've programmed, and forwards any faxes you've received.



You cannot use Paging and Fax Forwarding at the same time.

Programming a Fax Forwarding Number

- 1 Press **[Function]**, **[8]**, **[6]**.
- 2 Press **[Left Arrow]** or **[Right Arrow]** until the screen displays

FAX FORWARD?

and press **[Set]**.

FWD#:
ENTER & SET

- 3 Enter the number of the fax machine where faxes will be forwarded (up to 20 digits) and press **[Set]**.
- 4 Press **[Stop]** to exit.

You can change a Fax Forwarding number remotely.

You cannot use Paging and Fax Forwarding at the same time.



Programming Paging Number

1 Press **[Function]**, **[8]**, **[6]**.

2 Press **[◀]** or **[▶]** until the screen displays

PAGING?

and press **[Set]**.

PAG#:

ENTER & SET

3 Enter your pager phone number (up to 20 digits) followed by **[#]** **[#]** and press **[Set]**. Do not include the area code if it is the same as that of your fax machine.

For example, **[1][8][0][0][5][5][5][1][2][3][4][#][#]**.

4 If your pager requires a PIN, enter the PIN, press **[#]**, press **[Redial/Pause]**, enter your fax machine telephone number, then press **[#]** **[#]** and press **[Set]**. *For example,*

[1][2][3][4][5][#][Redial/Pause][1][8][0][0][5][2][1][2][8][4][6][#][#].

—OR—

If you do not need a PIN, press **[Redial/Pause]**, enter the telephone number of your fax machine, then press **[#]** **[#]** and press **[Set]**.

For example, **[Redial/Pause][1][8][0][0][5][2][1][2][8][4][6][#][#]**.

5 Press **[Stop]** to exit.

You cannot change a Paging number or PIN remotely.



Remote Retrieval

Using Remote Retrieval Access Code

- 1 Dial your fax machine from any fax machine using a touch tone.
- 2 When your fax machine answers and beeps, immediately enter your Remote Retrieval Access Code 159*.
- 3 The fax machine signals the kinds of messages received:
 - 1 long beep—Fax message(s)
 - 2 long beeps—Voice message(s)
 - 3 long beeps—Fax and Voice message(s)
 - No beeps—No messages
- 4 The fax machine then prompts you with two short beeps to enter a command. If you wait longer than 30 seconds to enter a command, the fax machine hangs up. If you enter an invalid command, the fax machine beeps three times.
- 5 Press **[9] [0]** to reset the fax machine when you finish.
- 6 Hang up.

If your fax machine is set to MANUAL mode, you can access the Message Center by waiting about 2 minutes, then entering the Remote Access Code within 30 seconds.



Changing Remote Retrieval Access Code

Enter your Remote Retrieval Access Code when the fax machine picks up your call, so you can access features remotely. The access code is preset to 159*, but you can change this.

- 1 Press **[Function], [8], [7]**.
- 2 Enter a three-digit number from 000 to 999 and press **[Set]**. The “*” cannot be changed.
Do not use the same digits that appear in your Fax Receive Code or Telephone Answer Code.
- 3 Press **[Stop]** to exit.

*See
Operation from
Extension
Telephone
p. 35*

Remote Control Commands

Follow the commands below to access features remotely. When you call the fax machine and enter your Remote Retrieval Access Code (159*), the system will signal you with two short beeps to enter a remote control command.

Remote Commands		Operation Detail
91 Playing Voice Messages	1 ◀ (Go back)	Press [1] while listening to an ICM or Memo message to play it again. If you press [1] before a message, you will hear the previous message.
	2 ▶ (Skip to next)	While playing ICM or Memo, you can skip to next message.
	9 STOP Playing	Stop playing the ICM and Memo.
	92 Record Memo	After one long beep, you can record a memo. You can stop recording by pressing [9].
93 Erase all ICMs & Memo	If you hear one long beep, the erase is accepted. If you hear three short beeps, you cannot erase because all voice messages have not been played, or there is no voice message to erase. *This code erases all recorded messages, not one at a time.	
94 Play and Record OGM in Memory		
1 Play	1 MSG CTR OGM	The fax machine plays the selected OGM. You can stop playing OGMs by pressing [9].
	2 F/T OGM	
2 Record	1 MSG CTR OGM	After one long beep, start recording the OGM. To stop recording, press [9]. Your recorded message will be played when you finish speaking.
	2 F/T OGM	
95 Changing Fax Forwarding/Paging Setting		If you hear one long beep, the change is accepted. If you hear three short beeps, you cannot change it because the conditions have not been met (Example: registering paging number). You can register your fax forwarding number by using 4. FAX FWD NO (see page 69). Once you have registered the number, the fax machine will change automatically to FAXFWD:ON mode. Then retrieve a Memory Status List by entering [9] [6] [1] (see page 68) to make sure that the Fax Forwarding number you registered is correct in the List.
1 OFF		
2 Fax Forwarding		
4 FAX FWD NO.		
96 Retrieve a Fax		
1 Memory Status List	1 Memory Status List	Enter the fax number where the report or stored fax messages will be received. (See page 68.)
	2 Retrieve all faxes	
	3 Erase fax in the memory	If you hear one long beep, you can erase the fax message from the memory.
97 Check the Receiving Status		You can check whether your fax machine has received any FAX or VOICE messages. If yes, you will hear one long beep. If no, you will hear three short beeps.
1 FAX		
2 VOICE		
98 Change Answer Mode		If you hear one long beep, you can change the answer mode. If you hear three short beeps, you cannot change it. (Example: There is no MSG CTR OGM when you want to change to MSG CTR mode.)
1 MSG CTR		
3 FAX		
90 Exit		After a long beep, you can exit remote control.

Retrieving Memory Status List

You can retrieve the Memory Status List from a remote telephone or fax machine using touch tone to see if you have any fax messages.

- 1 Dial your fax number.
- 2 When you hear the beep, immediately enter your Remote Retrieval Access Code (1 5 9 *).
- 3 When you hear two short beeps, use the dial pad to press 9 6 1.
- 4 Using the dial pad, enter the number (up to 20 digits) of the remote fax machine where you want the Memory Status List forwarded, and then press # #.
You cannot use * and # as dial numbers. However, if you want to store a pause, press #.
- 5 After you hear your fax machine beep, hang up and wait.
Your fax machine calls the remote fax machine. The remote fax machine prints the Memory Status List.

Retrieving Fax Messages

- 1 Dial your fax machine from a remote telephone or fax machine using touch tone.
- 2 When you hear the beep, immediately enter your Remote Retrieval Access Code (1 5 9 *).
- 3 As soon as you hear two short beeps, use the dial pad to press 9 6 2.
- 4 Using the dial pad, enter the number (up to 20 digits) of the remote fax machine where you want your fax messages forwarded, and then press # #.
You cannot use * and # as dial numbers. However, if you want to store a pause, press #.
- 5 After you hear your fax machine beep, hang up and wait.
Your fax machine calls the remote fax machine. The remote fax machine prints your fax messages.



Changing Fax Forwarding Number

You can change the default setting of your fax forwarding number from a remote telephone or fax machine using touch tone.

- 1** Dial your fax machine number.
- 2** When you hear the beep, immediately enter your Remote Retrieval Access Code (**1** **5** **9** *****).
- 3** When you hear two short beeps, use the dial pad to press **9** **5** **4**.
- 4** Enter the new number of the remote fax machine where you want your fax messages forwarded, and then press **#** **#**.
You cannot use ***** and **#** as dial numbers. However, if you want to store a pause, press **#**.
- 5** To retrieve the Memory Status List, when you hear two short beeps, use the dial pad to press **9** **6** **1**.
- 6** Use the dial pad to enter the number of the remote fax machine (up to 20 digits), and then press **#** **#**.
- 7** After you hear your fax machine beep, hang up and wait.
Your fax machine calls the remote fax machine. The remote fax machine prints the Memory Status List showing the new forwarding number.
- 8** Check the forwarding number.
If the forwarding number is incorrect, return to Step 1 to reset it.

Telephone Services

Custom Features



Your fax machine supports the Distinctive Ring and Caller ID telephone services offered by some telephone companies.

If you have Call Waiting, Ring Master, Voice Mail, an answering service or an alarm system custom feature on your telephone line, it may create a problem in the operation of your fax machine.

Distinctive Ring

This fax machine feature lets you use the Distinctive Ring subscriber service offered by some telephone companies, which allows you to have several telephone numbers on one phone line. Each phone number has its own Distinctive Ring pattern, so you know which phone number is ringing. This is one way you can have a separate phone number for your fax machine.

Your fax machine has a Distinctive Ring function, allowing you to dedicate one phone number just for receiving faxes. You'll need to follow the directions below to "register" the new Distinctive Ring pattern, that was assigned by the Telephone Company, so your fax machine can recognize its incoming calls.



You can change or cancel the Distinctive Ring pattern at any time. You can switch it off temporarily, then turn it back on. When you get a new fax number, make sure you reset this function.



You can register only one Distinctive Ring pattern with the fax machine. Some ring patterns cannot be registered.

- The fax machine will answer only calls to its registered number.
- If using an external TAD to answer only the main number, the fax machine must be in **MANUAL** mode.
- In **FAX/TEL** or **FAX ONLY** mode, the fax machine will answer all numbers on the phone line.
- The first two rings are silent on the fax machine.

Registering the Distinctive Ring Pattern

- 1 If you have Voice Mail from the Telephone Company, you must disconnect it now (temporarily).
- 2 Disconnect the fax machine from any TAD or external telephone answering device.
- 3 Set the fax machine to **MANUAL** mode.
- 4 Press **[Function]**, **[0]**, **[1]**. The screen displays the current setting of this feature.
- 5 Press **[◀]** or **[▶]** to select the **DISTINCTIVE:SET?** mode and press **[Set]**.

DISTINCTIVE:OFF?

DISTINCTIVE:SET?

- 6 Press **[◀]** or **[▶]** to select the prestored ring pattern you want to assign and press **[Set]**. (You will hear each pattern as you scroll through the four patterns.) Be sure to choose the pattern assigned by the Telephone Company.

Ring Pattern	Rings	
1	long - long	
2	short - long - short	
3	short - short - long	
4	very long (normal pattern)	

7 Press **Stop** to exit.

Once you've registered the Distinctive Ring pattern in your fax machine, you can turn this feature ON (or OFF), by following Steps 1 to 5 above.

Caller ID

The Caller ID feature of this fax machine lets you use the Caller ID subscriber service offered by many local telephone companies. After at least two rings, the screen displays the telephone number of your caller (or up to 16 characters of the name, if available). Once you pick up the handset, the Caller ID information disappears from the screen, but the call information remains stored in the Caller ID memory.

- CALL PICKUP display remains on the screen when no Caller ID information was transmitted.
- OUT-OF-AREA display means the call originates outside your Caller ID service area.
- PRIVATE CALL display means the caller has intentionally blocked transmission of information.

Caller ID service varies with different carriers. Call your local telephone company to determine the kind of service available in your area.

Caller ID Log

Your fax machine stores up to 30 of the last caller IDs received into the fax machine's memory in the Caller ID Log. When the thirty-first call comes in, information about the first call is erased. You can print the report or scroll through Caller ID information to review those calls made to your fax machine.

Printing the Caller ID Log

1 Press **Hold/Caller ID**.

CALLER ID LOG

2 To print the Caller ID Log, press **Start**.

PRINTING

Viewing the Caller ID Log

- 1 Press **Hold/Caller ID**.

```
CALLER ID LOG
PRESS START KEY
SELECT ← → & SET
```

- 2 After 2 seconds, press **◀** or **▶** to scroll through the Caller ID Log.

```
01>MARY HENDERSON
02>TOM HENDERSON
03>ABC COMPANY
```

- 3 When you want to see more detailed information for a displayed ID (phone number and date and time call was received) press **Set**.

```
03>ABC COMPANY
03>9087772837
03>02/01 12:00
DIAL:PRESS START
```

- 4 To continue viewing the Caller ID Log (Step 2), press **◀** or **▶**.
—OR—

To exit the Caller ID Log, press **Stop**.



You can delete a name from the Caller ID Log, by pressing **Erase** in Step 2 or Step 3.

```
ERASE THIS DATA?
1.YES 2.NO
```

Press **1** to erase the selected Caller ID (or **2** to return to the Log without erasing).

See
Setting Up Your
Area Code
p. 26

Returning a Call from the Log

You can scroll through the Caller ID Log and select a call to return automatically.

You must set up your Area Code in advance. (USA only)

- 1** Press **[Hold/Caller ID]**.

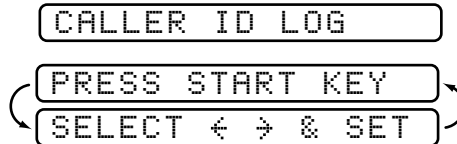

- 2** Press **[Left Arrow]** or **[Right Arrow]** to scroll through the Caller ID Log and when you see a call you want to return immediately, press **[Set]**.

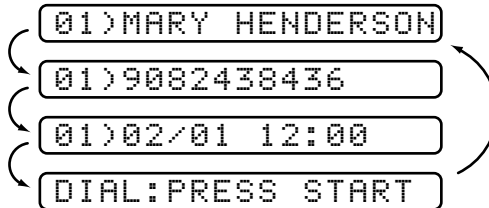

- 3** To begin dialing, press **[Start]**.
4 Begin speaking when the other party answers.

This feature may not be available in certain area of USA and Canada.



If your dialing plan does not follow the standard 1 + area code + 7-digit number dialing system for calling outside your area code, you may experience problems returning calls automatically from the Caller ID Log. Your fax machine will automatically dial "1" plus the area code for any number that does not originate in your area code. If this is not the procedure followed by your dialing plan you will not be able to return calls automatically.

Registering a Caller ID Number

You can set up a caller in the Caller ID Log as a One Touch or Speed Dial number.

- 1 Press **Hold/Caller ID**.

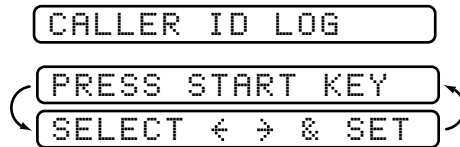

- 2 After 2 seconds, press **◀** or **▶** to scroll through the Log and when you see a caller you want to register, press **Set**.

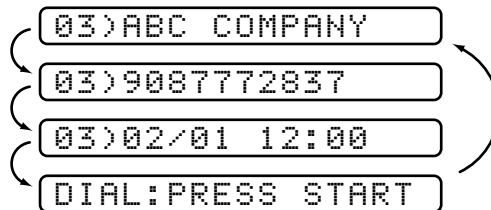

- 3 To register the caller as a One Touch number, press the One Touch key where you want the number to be stored.

—OR—

To register the caller as a Speed Dial number, press **Speed Dial** and use the dial pad to press the two-digit location code (01–50) and press **Set**.

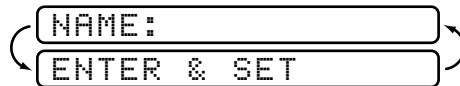

If the LCD shows REGISTERED, the auto dial location already has a number.

- 4 Enter the caller's name and press **Set**.
- 5 Press **◀** or **▶** to select the type of number and press **Set**:
- | | |
|---------|-----------------------------------------------------|
| FAX | A fax number |
| TEL | A telephone (voice) number |
| FAX/TEL | Both a fax and telephone number |
| CHAIN | A number, usually an access code, for chain dialing |
- 6 Return to Step 2 to store another auto dial number—OR—
Press **Stop** to exit.

Making Copies

Copy Functions

Your fax machine cannot scan anything closer than one-eighth inch from the edge of the paper. The default resolution for a single copy is Super Fine. Set the resolution to PHOTO for photographs.

- 1 Place document face down in the feeder.
- 2 Press **Copy**. (You can press **Copy** again for faster response—otherwise, copying begins in about 5 seconds.)

To cancel, press **Stop**.

Do NOT pull on the paper while copying is in progress.



Multiple Copies

You can make multiple copies using your fax machine, and you can choose whether the copies will be STACKED (all copies of page 1, then all copies of page 2, etc.) or SORTED (collated). The default resolution for multiple copies is Fine.

- 1 Place the document face down in the feeder, then press **Copy**.
- 2 Enter two digits for the number (up to 99) of copies you want.
For example, press **0** **3** for three copies.
- 3 Press **Copy**.
- 4 Use **◀** or **▶** to select **STACK** or **SORT**.
- 5 Press **Copy**.
Make sure you frequently empty the receiving tray.



If you get a MEMORY FULL message while you are scanning the first page, press **[Stop]** to cancel the job and restart to make a single copy. If the MEMORY FULL message appears while scanning subsequent pages, you can press **[Copy]** to copy the portion that is in memory, or press **[Stop]** to cancel. To restart the copy job using less memory, press **[Copy]** for stacked copies.

Printing Reports

FAX Settings

You can print the following lists and reports:

1. XMIT REPORT

Choose if you would like a Transmission Verification Report printed after all faxes you send.

2. ALL DIAL

Lists names and numbers stored in One Touch and Speed Dial memory, in numerical order.

3. TEL. INDEX

ALL DIAL list (above), alphabetically.

4. USER SETTINGS

Lists settings for INITIAL SETUP, SETUP RECEIVE, PRINT REPORTS and TEL SERVICE. The settings for SETUP MSG CTR are included.

5. MEMORY STATUS

Lists summary information and amount of occupied memory.

To Print a Report

- 1 Press **[Function]**, **[7]**.
- 2 Enter the number of the report you want to print. For example, press **[3]** to print the TEL-INDEX.
- 3 Press **[Start]**.
- 4 Press **[Stop]** to exit.

Transmission Verification (Xmit) Report

You can use the Xmit Report as proof that you sent a fax. This report lists the name or fax number of the receiving party, the time and date of transmission, and if the transmission was successful.

When the feature is OFF, the report is printed automatically only if there's an error during transmission. If the report indicates NG, send the document again. If the report indicates you should check the readability of certain pages, resend those pages. For successful transmissions, you can print the Xmit Report for the last fax by pressing **[Trans. Verify]**.

When the feature is ON, the report is printed with every fax you send.

- 1 Press **[Function]**, **[7]**, **[1]**.
- 2 Press **[◀]** or **[▶]** to select ON or OFF and press **[Set]**.
- 3 Press **[Stop]** to exit.

Using the Trans. Verify Key

To print the Transmission Verification (Xmit Report) for only a few important faxes, turn the report off (**[Function]**, **[7]**, **[1]**). Then you can press the **[Trans. Verify]** key to print the Xmit Report for the *last* fax you sent.

Important Information

Standard Telephone and FCC Notices

These notices are in effect on models sold and used in the United States only.

This equipment is hearing aid and volume control compatible.

When programming emergency numbers and/or making test calls to emergency numbers:

- Remain on the line and briefly explain to the dispatcher the reason for the call before hanging up.
- Perform such activities in the off-peak hours, such as early morning or late evening.

This equipment complies with Part 68 of FCC Rules. On the rear panel of this equipment is a label that contains, among other information, the FCC Registration Number and Ringer Equivalence Number (REN) for this equipment. You must, upon request, provide this information to your telephone company.

You may safely connect this equipment to the telephone line by means of a standard modular jack, USOC RJ11C.

An FCC compliant telephone cord with a modular plug is provided with this equipment. This equipment is designed to be connected to the telephone line or premise's wiring using a compatible modular jack that is Part 68 compliant. See the Installation section of this manual for details.

The REN is useful to determine the quantity of devices you may connect to your telephone line and still have those devices ring when your telephone number is called. In most, but not all areas, the sum of the RENs of all devices connected to one line should not exceed five (5). To be certain of the number of devices you may connect to your line, as determined by the REN, you should contact your local telephone company to determine the maximum REN for your calling area. If your fax damages the telephone line, the telephone company may discontinue your service temporarily. If possible, they will notify you in advance. But if advance notice is not practical, you will be notified as soon as possible. You will be informed of your right to file a complaint with the FCC.

Your telephone company may make changes to its facilities, equipment, operations or procedures that could affect the proper functioning of your equipment. If they do, you will be notified in advance to give you an opportunity to maintain uninterrupted telephone service.

If you experience trouble with this fax machine, please contact a Brother Authorized Service Center for information on obtaining service or repair. The telephone company may ask that you disconnect this equipment from the line until the problem has been corrected or until you are sure that the equipment is not malfunctioning.

If you are not able to solve a problem with your fax machine, contact Brother at

USA: *1-800-284-4329* (voice)

1-908-575-8790 (fax)

From within Canada: *1-800-853-6660* (voice)

1-514-685-4898 (fax)

From within Montreal: *1-514-685-6464* (voice)

Federal Communications Commission Compliance Notice (For USA Only)

This equipment has been tested and found to comply with the limits for a Class B digital device, pursuant to Part 15 of the FCC Rules. These limits are designed to provide reasonable protection against harmful interference in a residential installation. This equipment generates, uses, and can radiate radio frequency energy and, if not installed and used in accordance with the instructions, may cause harmful interference to radio communications. However, there is no guarantee that interference will not occur in a particular installation. If this equipment does cause harmful interference to radio or television reception, which can be determined by turning the equipment off and on, the user is encouraged to try to correct the interference by one or more of the following measures:

- Reorient or relocate the receiving antenna.
- Increase the separation between the fax equipment and the receiver.
- Connect the fax equipment on a separate circuit.
- Consult with the dealer or an experienced radio/TV technician for help.

Industry Canada Compliance Statement (For Canada Only)

This Class B digital apparatus complies with Canadian ICES-003.

Cet appareil numérique de la classe B est conforme à la norme NMB-003 du Canada.



WARNING

For protection against the risk of electrical shock, always disconnect all cables from the wall outlet before servicing, modifying or installing the equipment.

This equipment may not be used on coin service lines provided by the telephone company or connected to party lines.

Brother cannot accept any financial or other responsibilities that may be the result of your use of this information, including direct, special or consequential damages. There are no warranties extended or granted by this document.

The serial number may be found on the label affixed to the back of the unit. For your convenience, note the number below and retain this Owner's Manual to serve as a permanent record of your purchase, in the event of a theft or fire, or for future reference.

Important Safety Instructions

- 1** Read all of these instructions.
- 2** Save them for later reference.
- 3** Follow all warnings and instructions marked on the product.
- 4** Unplug this product from the wall outlet before cleaning. Do not use liquid or aerosol cleaners. Use a damp cloth for cleaning.
- 5** Do not use this product near water.
- 6** Do not place this product on an unstable cart, stand, or table. The product may fall, causing serious damage to the product.
- 7** Slots and openings in the cabinet and the back or bottom are provided for ventilation; to ensure reliable operation of the product and to protect it from overheating, these openings must not be blocked or covered. The openings should never be blocked by placing the product on a bed, sofa, rug, or other similar surface. This product should never be placed near or over a radiator or heater. This product should never be placed in a built-in installation unless proper ventilation is provided.
- 8** This product should be operated from the type of power source indicated on the label. If you are not sure of the type of power available, consult with your dealer or local power company.
- 9** This product is equipped with a 3-wire grounding type plug, a plug having a third (grounding) pin. This plug will fit into only a grounding-type power outlet. This is a safety feature. If you are unable to insert the plug into the outlet, contact your electrician to replace your obsolete outlet. Do not defeat the purpose of the grounding-type plug.
- 10** Do not allow anything to rest on the power cord. Do not place this product where people can walk on the cord.
- 11** If an extension cord is used with this product, make sure that the total ampere ratings on the products plugged into the extension cord do not exceed the extension cord ampere rating. Also, make sure that the total of all products plugged into the wall outlet does not exceed 15 amperes (USA only).
- 12** Do not place anything in front of the fax machine that will block received faxes. Do not place anything in the path of received faxes.
- 13** Do not touch a document during printing.
- 14** Never push objects of any kind into this product through cabinet slots, since they may touch dangerous voltage points or short out parts resulting in a risk of fire or electric shock. Never spill liquid of any kind on the product.

15 Do not attempt to service this product yourself, as opening or removing covers may expose you to dangerous voltage points and/or other risks, and may void your warranty. Refer all servicing to a Brother Authorized Service Center. A list of Brother Authorized Service Centers has been included for your convenience, or you may contact the following Brother Customer Service Numbers for your nearest Brother Authorized Service Center:

USA: *1-800-284-4329 (voice)*
1-908-575-8790 (fax)
1-800-521-2846 (Fax-Back System)

From within Canada: *1-800-853-6660 (voice)*
1-514-685-4898 (fax)
1-800-681-9838 (Fax-Back System)

From within Montreal: *1-514-685-6464 (voice)*

16 Unplug this product from the wall outlet and refer servicing to a Brother Authorized Service Center under the following conditions:

- A** When the power cord is damaged or frayed.
- B** If liquid has been spilled into the product.
- C** If the product has been exposed to rain or water.
- D** If the product does not operate normally when the operating instructions are followed. Adjust only those controls that are covered by the operating instructions. Improper adjustment of other controls may result in damage and will often require extensive work by a qualified technician to restore the product to normal operation.
- E** If the product has been dropped or the cabinet has been damaged.
- F** If the product exhibits a distinct change in performance, indicating a need for service.

17 To protect your product against power surges, we recommend the use of a power protection device (Surge Protector).

Compilation and Publication Notice

Under the supervision of Brother Industries, Ltd., this manual has been compiled and published, covering the latest product descriptions and specifications.

The contents of this manual and the specifications of this product are subject to change without notice.

Brother reserves the right to make changes without notice in the specifications and materials contained herein and shall not be responsible for any damages (including consequential) caused by reliance on the materials presented, including but not limited to typographical and other errors relating to the publication.

Trademarks

The Brother logo is a registered trademark of Brother Industries, Ltd.

Brother is a registered trademark of Brother Industries, Ltd.

Multi-Function Link is a registered trademark of Brother Industries, Ltd.

IBM, IBM PC, MWAVE and IBM Aptiva are registered trademarks of International Business Machines Corporation.

Visioneer PaperPort is a registered trademark of Visioneer, Inc.

Microsoft and MS-DOS are registered trademarks of Microsoft Corporation.

Windows and Windows NT are registered trademarks of Microsoft in the USA and other countries.

All other terms and brand and product names mentioned in this manual are registered trademarks of their respective companies.

Troubleshooting and Maintenance

Troubleshooting

Fax-Back System

Brother Customer Service has installed an easy-to-use Fax-Back System, so you can get instant answers to common technical questions and product information for all Brother products. This system is available 24 hours a day, 7 days a week. You can use the system to send faxes to any fax machine, not just the one from which you are calling.

If you can't resolve a difficulty with your fax machine using this manual, call our Fax-Back System, and follow the voice prompts to receive faxed instructions about using the system, and an index of Fax-Back subjects.

USA: *1-800-521-2846*

From within Canada: *1-800-681-9838*

The Brother Fax-Back System number (USA only) has been preprogrammed on One Touch key **[01]**.

Brother on the World Wide Web

You can find more information about Brother products, from product specification sheets to Frequently Asked Questions (FAQs), on the World Wide Web. Visit us at

<http://www.brother.com>

Brother Bulletin Board

Brother's Bulletin Board Numbers are

USA: *1-888-298-3616*

From within Canada: *1-514-685-2040*

Error Messages

You may occasionally encounter a difficulty with your fax machine or telephone line. If this happens, your fax machine often identifies the problem and displays an error message. The list below explains the most common error messages.

If you need additional help, call the Brother Fax-Back System at

USA: 1-800-521-2846

From within Canada: 1-800-681-9838

CLEAN UP SCANNER

The scanner is dirty; clean the white bar and the glass under the bar with isopropyl alcohol.

You should routinely clean the scanner to avoid this error.

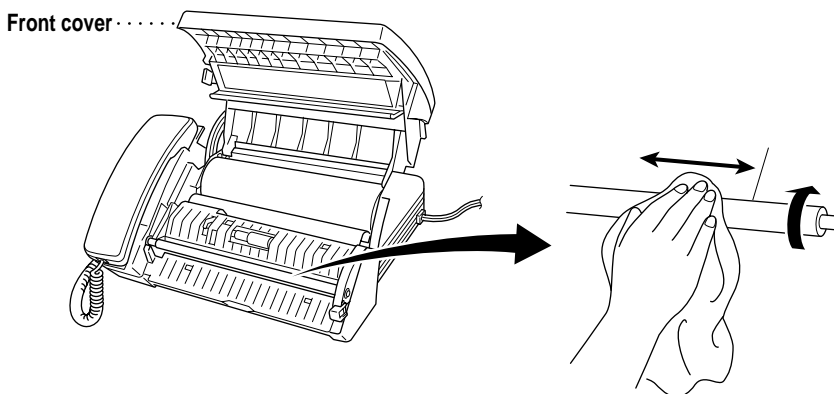

COMM. ERROR XX XX

A poor quality phone line resulted in a communications error. Try the call again.

CONNECTION FAIL

You have requested a polling call from another party, but the other fax machine is not in Poll Waiting mode.

COVER OPEN

The cover is not completely closed.

CUTTER JAM

The fax paper is jammed in the cutter.

- 1** Unplug the power cord.
- 2** Open the cover.
- 3** Pull the blue release lever on the print head unit and raise it.
- 4** Gently turn the paper roll toward the front of the machine to roll out the jammed paper.

Recording paper

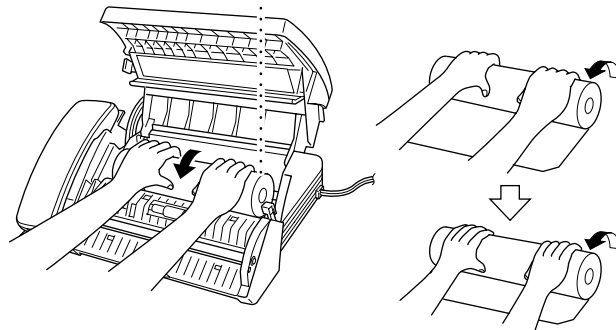

- 5** Use scissors to cut off the wrinkled portion of the paper.
- 6** Plug in the power cord.
- 7** Load the fax paper again, and push the blue release lever down. Close the cover.

DISCONNECTED

The other party has disconnected during a call or fax. Try calling the other party.

DOCUMENT JAM

The documents were not inserted or fed properly, or were too long or too short.

- 1 Open the cover.
- 2 Pull the documents toward the front of the fax machine, in the same direction they were feeding.
- 3 Close the cover.

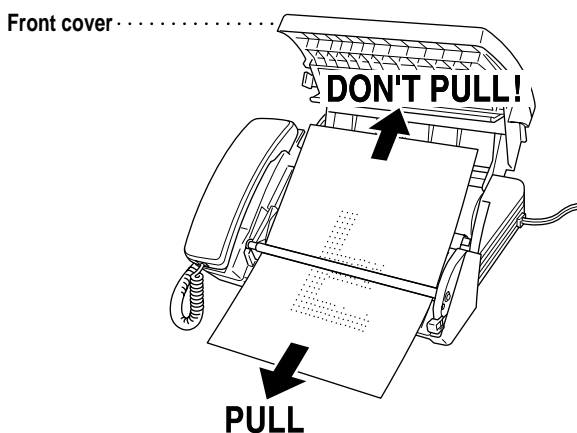
**MACHINE ERROR XX**

and

PRESS STOP KEY

Contact Brother Customer Service at;

USA: *1-800-284-4329 (voice)*

From within the Canada: *1-800-853-6660 (voice)*

From within the Montreal: *1-514-685-6464 (voice)*

NO RESPONSE/BUSY

The number you called does not answer or is busy. You may also have reached a number not connected to a fax. Check the number and call again.

NOT REGISTERED

You've tried accessing a One Touch or Speed Dial location with no number assigned to it. See pages 47 and 49 for information about storing One Touch and Speed Dial numbers.

PAPER ROLL EMPTY

The paper roll is empty; follow the instructions in Installation to replace the paper roll.

PRINTER FAULT

The recording head has overheated. Unplug the machine and wait 30 minutes for it to cool.

PRINTER JAM

The fax paper is jammed in the printer. Follow the instructions for CUTTER JAM, see page 89.

SCANNER ERROR

Try cleaning the white bar and the glass under the bar with isopropyl alcohol.

If you still get a scanner error, contact Brother Customer Service at:

USA: **1-800-284-4329.**

From within Canada: **1-800-853-6660.**

From within montreal: **1-514-685-6464.**

*See
Clean up
scanner
p. 88*

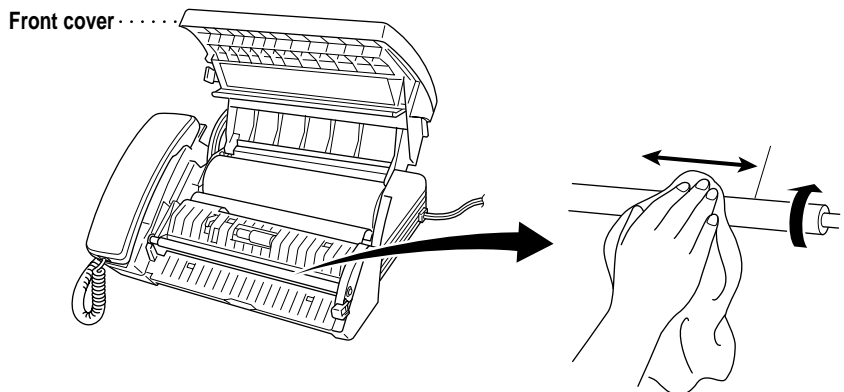

Recording Paper Jam

If something was placed in front of your fax machine, during printing the recording paper may become jammed. To roll out the jammed paper, follow the instructions for CUTTER JAM, see page 89.

If You Are Having Difficulty with Your Fax Machine

If you think there is a problem with your fax machine, make a copy first. If the copy looks good, the problem is probably not your fax machine. Check the difficulties below and follow the troubleshooting tips.

Printing or Receiving Faxes

Condensed Print and Horizontal Streaks; Top and Bottom of Sentences Cut Off

If your copy looks good, you probably had a bad connection, with static or interference on the phone line.

Enabling/Disabling Anti-Curl Check Sheet (ACS)

Although the factory setting of Anti-Curl Check Sheet feature is OFF, you can check the status of your fax machine's Anti-Curl (ACS) feature by printing an Anti-Curl Check Sheet.

Press One Touch key **[01]** and **[05]** at the same time to print an ACS Check Sheet.

Press One Touch key **[01]** and **[05]** at the same time to discontinue printing ACS Check Sheet.

Vertical Black Lines When Receiving

The sender's scanner may be dirty. Ask the sender to make a copy to see if the problem is with the sending machine. Try receiving from another fax machine. If the problem continues, call Brother Customer Service at 1-800-284-4329 (USA) or 1-800-853-6660 (**from within Canada**) or 1-514-685-6464 (**from within Montreal**).

Phone Line or Connections

Fax Machine Does Not Answer When Called

Make sure the fax machine is in the correct receiving mode for your setup (either FAX, FAX/TEL or MSG CTR). Check for dial tone. If possible, call your fax machine to hear it answer. If there is still no answer, check the telephone line cord connection. Connect a standard telephone handset to the fax machine telephone jack. If there is no ringing when you call your fax machine, call your Telephone Company to check the line.

No Dial Tone on the Handset

Press **[Speaker Phone]**—**OR**—Lift the handset. If you hear no dial tone, check telephone line cord connections at the fax machine and wall jack. Check that the handset is connected to the fax machine's handset jack. Test the wall jack with another single line telephone. If no dial tone on the wall outlet, call your Telephone Company.

Sending Faxes

Poor Transmitting Quality

Try changing your resolution to FINE or SUPERFINE (see "Resolution" p. 40). Try cleaning the white pressure bar of the scanner and the glass under the bar (see p. 91).

Dialing Does Not Work

Check for a dial tone.

Change TONE/PULSE setting (see "Setting Dialing Mode (Tone/Pulse)" p. 23).

Check all line cord connections, and make sure the curled handset cord is not in the **EXT** jack.

Check power cord connection.

Send a manual fax by pressing **[Speaker Phone]**—**OR**—Lifting the handset, and dialing the number. Wait to hear fax receiving tones before pressing **[Start]**.

Vertical Black Lines When Sending

Use your fax machine to make a copy. If the copy shows the same problem, the scanner area is dirty. Lift the front cover and check the document path. Clean the scanner's white pressure bar and the glass under the bar using isopropyl alcohol and a lint-free cloth (see p. 91).

Handling Incoming Calls

Double Ring in FAX/TEL Mode

The fax machine knows the incoming call is not a fax so it is signaling you to answer the telephone call. Pick up the fax machine handset or answer from an extension phone and press your fax machine's Telephone Answer Code (default setting is #51).

*See
For FAX/TEL
Mode Only
p. 35*

Transferring a Call to the Fax Machine

If you have answered the fax machine handset, press **[Start]**, and hang up immediately.

If you answered at an extension phone, press your three-digit Fax Receive Code (the factory setting is ✳51). When your fax machine answers, hang up.

*See
Easy Receive
p. 34*

Fax Machine “Hears” Voice as CNG Tone

If your fax machine is set to Easy Receive ON, and it answers voice calls by trying to receive a fax, try turning Easy Receive to OFF.

Transmission Verification Report Prints “Result: NG”

There is probably temporary noise or static on the phone line. Try sending the fax again. If the problem continues, call the Telephone Company to check your phone line.

Custom Features on a Single Line

If you have Call Waiting, Caller ID, Ring Master, Voice Mail, an answering machine, alarm system or any other custom feature on a single phone line with your fax machine, it may create a problem with sending or receiving fax data and telephone calls.

For Customer Service

USA:	<i>1-800-284-4329</i> (voice)
	<i>1-908-575-8790</i> (fax)
From within Canada:	<i>1-800-853-6660</i> (voice)
	<i>1-514-685-4898</i> (fax)
From within Montreal:	<i>1-514-685-6464</i> (voice)

Multi-Function Link[®] (option)

You can purchase the optional Multi-Function Link[®] package (also called “Missing Link”). Multi-Function Link[®] turns your fax machine into a multi-function center, by enabling you to use your fax machine as a printer and a scanner and to use it to fax messages from Windows[®] applications in your computer. The Multi-Function Link[®] option is for Windows[®] 3.1x and Windows[®] 95/98.

Multi-Function Link[®] is available at most Brother retailers. If you cannot find it, you can order Multi-Function Link[®] directly from Brother. The item number is PCI-1.

Installation instructions will be included with PCI-1. **However, it is important that you hook up your fax machine to your computer before you install the software.**

Specifications

Type	Desktop facsimile transceiver
Compatibility	ITU-T Group 3
Coding system	Modified Huffman (MH)
Modem speed	14400/12000/9600/7200/4800/2400; Automatic Fallback
Document input width	5.8 inches to 8.5 inches (148 mm to 216 mm)
Scanning/Printing width	8.2 inches (208 mm)
Paper roll size: width	8.5 inches (216 mm)
length	164 feet (50 m) with standard thermal paper 98 feet (30 m) with Therma PLUS paper
diameter	Limited to 2.76 inches (70 mm)
Printer type	Line Thermal
Gray scale	64 levels (Dithered)
Display	LCD, 16 characters
Polling types	Standard, Sequential
Contrast control	Automatic/Super Light/Super Dark (manual setting)
Resolution	<ul style="list-style-type: none"> • Horizontal 203 dot/inch (8 dot/mm) • Vertical Standard—98 line/inch (3.85 line/mm) Fine, Photo—196 line/inch (7.7 line/mm) Superfine, Photo (copy)—392 line/inch (15.4 line/mm)
Memory capacity	512 KB (up to 20 pages*)
One Touch dial	10
Speed-Dial	50 stations
Automatic redial	3 times at 5 minute intervals
Speaker type	Full Duplex, Digital
Auto answer	0, 1, 2, 3 or 4 rings

* “Pages” refers to the “Brother Standard Chart No. 1” (a typical business letter, Standard resolution).

Communication source	Public switched telephone network
Operating environment	41 - 95° F (5 - 35°C)
Power source	120V AC 50/60Hz (USA, Canadian Version Only)
Power consumption	Standby: under 5 watts — Peak: under 110 watts
Dimensions	11.8 x 9.4 x 5.4 inches (299 x 240 x 137 mm)
Weight	6.4 lb (2.9 kg)

Specifications are subject to change for improvement without prior notice.

Glossary

ADF (Automatic Document Feed) Refers to the number of pages that can be placed in the document feeder and fed one at a time automatically.

All Dial List A listing of names and numbers stored in One Touch and Speed Dial memory, in numerical order.

automatic fax transmission Sending a fax without picking up the handset or pressing **Speaker Phone**.

Backup Print Sets your fax machine to print a copy of faxes that are received and stored in memory.

beeper The sound the keys make when they are pressed, an error occurs or a document has been received or transmitted.

broadcasting The ability to send the same fax message to more than one location.

Caller ID A service purchased from the Telephone Company that lets you see the number (or name) of the party calling you. Your fax machine stores the latest callers so you can print a Log, view caller information, register selected callers as auto dial numbers and return calls.

Cancel Job Cancels a programmed job, like Delayed Fax or Polling.

CNG tones The special tones (beeps) sent by fax machines during automatic transmission to tell the receiving machine that they are a from fax machine.

communication error (or Comm. Error) An error during fax sending or receiving, usually caused by line noise or static.

Contrast Setting to compensate for dark or light documents, by lightening dark documents or darkening light documents.

Delayed Fax Sends your fax at a later time that day.

Distinctive Ring A service purchased from the Telephone Company that provides another phone number on an existing phone line. The Brother fax machine uses the new number to simulate a dedicated fax line.

ECM (Error Correction Mode) Detects errors during fax transmission and resends the page(s) of the document that had an error.

F/T Ring Time The length of time the fax machine rings (when the answer mode setting is FAX/TEL) to notify you to pick up a voice call that it answered.

Fax Forwarding Sends a fax received in memory to another preprogrammed fax number.

fax tones The signals sent by sending and receiving fax machines while communicating information.

Fine Mode Resolution is 196 x 203 dpi. It is used for small print and graphs.

- gray scale** The shades of gray available for copying and faxing photographs.
- group number** A combination of One Touch and/or Speed Dial numbers that are stored on a One Touch key for Broadcasting.
- ICM (incoming message)** A recorded voice message received into digital Message Center.
- Interrupt** Temporarily puts a waiting job on hold while you perform another operation.
- LCD (liquid crystal display)** The display screen on the fax machine that shows interactive messages during On-Screen Programming and defaults to the date and time when the machine is idle.
- manual fax** When you press **Speaker Phone**—OR—lift the handset so you can hear the receiving fax machine answer before you press **Start** to begin transmission.
- Message Center** You can set up your fax machine to receive voice and/or fax messages into its memory so you can retrieve them remotely.
- Memory Status List** Shows how much memory is being used, how much is left, and the type of messages in memory.
- memory usage** Instructs the fax machine how to allocate the memory.
- Multi-Function Link® Ready** fax machine models that have a PCI/F Port to connect a computer, using the optional hardware/software package called “Missing Link.”
- Next Fax Reservation** Accepts the next document in the document feeder for transmission while the fax machine is still receiving.
- OGM (Out-Going Message)** The message callers hear when you call your Message Center or external answering machine.
- One Touch** Keys on the fax machine control panel where you can store numbers for easy dialing. You must use a separate key for each number.
- Out of Paper Reception** Receives faxes into the fax machine’s memory when the machine is out of paper.
- Overseas Mode** Makes temporary changes to the fax tones to accommodate noise and static on overseas phone lines.
- Paging** Feature enables your fax unit to call your pager when a fax and/or a voice message is received into its memory.
- Pause** Allows you to place a 3.5 second delay in the dialing sequence stored on One Touch and Speed Dial numbers.
- Photo Mode** A resolution setting that uses varying shades of gray for the best representation of photographs.
- polling** The process of a fax machine calling another fax machine to retrieve waiting fax messages.
- Pulse (Rotary)** A form of dialing on a telephone line.

- Quick Scan** Enables the fax machine to scan a document into memory before faxing it.
- remote access** The ability to access your Message Center remotely from a fax machine using touch tone.
- remote activation** allows you to transfer a fax call, answered at an extension phone, to the fax machine.
- remote retrieval access code** The four-digit code that allows you to call and access your Message Center from a remote location.
- resolution** The number of vertical and horizontal lines per inch. See: Standard, Super Fine and Photo.
- scanning** The process of sending an electronic image of an original paper document into your computer.
- speed dial** A preprogrammed number for easy dialing. You must press the Speed dial key and then two digit code to start the dialing process.
- Standard resolution** 98 x 203 dpi. It is used for regular size text and quickest transmission.
- Station ID** The stored information that appears on the top of faxed pages. It includes the sender's name and fax number.
- super fine resolution** 392 x 203 dpi. Best for very small print and line art.
- TAD (External Telephone Answering Device)** You can connect an external answering machine on the same line as your fax machine.
- Tel-Index** A key on the control panel that displays an electronic, alphabetical listing of stored One Touch, Speed Dial and Group numbers.
- Toll Saver** A Message Center setting that allows the fax machine to answer after two ring when a message(s) was received and after four rings when there are no messages. The caller can hang up (after two rings) without paying for the call if there are no messages to retrieve.
- Tone** A form of dialing on the telephone line used for Touch Tone telephones.
- transmission** The process of sending documents over the phone lines from your fax machine to the receiving fax machine.
- User Option List** A printed report that shows the current settings of your fax machine.
- Xmit Report (Transmission Report)** A listing of the last fax you sent, showing, date, time, and number of pages. The receiving party's fax number and the result of the transmission is printed on the report for your records.

Index

A

- Accessories and Supplies ii
- ALL DIAL Lists 79
- Alternating Displays 18
- Answer Mode 31
- Answering Machine (TAD) 14
- Area Code (Setting) 26
- Assembly 7
- Automatic Document Feeder (ADF) 40
- Automatic Transmission 41

B

- Backup printing 61
- Beeper Volume 27
- Broadcasting 43
- Broadcasting (Set Up Groups) 51
- Brother Bulletin Board i
- Brother Numbers i

C

- Caller ID 73
- Caller ID (Printing) 73
- Caller ID (Registering) 76
- Caller ID (Returning a Call) 75
- Caller ID (Viewing) 74
- Canceling Job 37, 45
- CLEAN UP SCANNER 88
- CNG tones 2
- Connect (External Telephone) 16
- Connect (Hand Set) 9
- Connect (Power Cord) 10
- Connect (TAD) 14
- Connect (telephone line) 10
- Contrast 40
- Copy 77
- Corrections 25

- Customer Service i
- CUTTER JAM 89

D

- Date and Time 23
- Delayed Fax 43
- Dialing Mode 23
- Distinctive Ring 71
- Document 39
- DOCUMENT JAM 90

E

- Easy Receive 34
- ECM (Error Correction Mode) 3
- Entering Text 25
- Error Messages 88

F

- Fax Forwarding 64
- Fax Forwarding (Changing) 69
- Fax Message (Printing) 61
- FAX ONLY Mode 31
- Fax Receive Code 35
- Fax Redial 41
- Fax Tones and Handshake 2
- Fax-Back System 87
- FAX/TEL (F/T) Mode 31
- FAX/TEL (F/T) OGM (Recording) 34
- FAX/TEL (F/T) Ring Time 33
- FCC Notices 81
- Fine (Resolution) 40
- Flexible Memory Settings 57
- Function Mode 17

G

- Gray scale 97

H

Handset Volume	27
Help	1
Help List	1
Hold	4, 54

I

ICM Recording Monitor	63
Important Information	81
Incoming Messages	62
Inserting Spaces	25
Installation	5
Interrupting	46

L

Load the recording paper	7
--------------------------------	---

M

Manual Dialing	53
Manual Mode	31
Manual Transmission	41
Memory Status List (Retrieving)	68
MEMORY STATUS Lists	79
Memory Storage	29
Message Center	57
Message Center (Set up)	58
Message Indicator	60
Message Storage	57
Message Storage (Setting)	58
MSG CTR Mode	31
Multi-Function Link® (option)	95
Multi-Function Link® Mode	38
Multi-Line Connections	13
Multiple Copies	77
Multiple Resolution Transmission	44

N

Next-Fax Reservation	44
----------------------------	----

O

On-Screen Programming	17
One Touch (Changing)	50
One Touch Dial (Storing Numbers)	47
One Touch Dialing	54
Outgoing Message (Listening)	59
Outgoing Message (Recording)	16, 59
Outgoing Message (Erasing)	59
Overseas Mode	42

P

Packing List	6
Paging	64
Paper (Loading)	7
Paper (Size)	9
Pause	54
PBX	13
Photo (Resolution)	40
Polling (Receive)	36
Polling Transmit (Setting Up)	45
Print a Report	80
PRINTER JAM	91

Q

Quick Scan	42
------------------	----

R

Recording (Conversation)	64
Recording (Memo)	63
Recording Paper	9
Remote Access Code (Changing)	66
Remote Access Code (Using)	66
Remote Codes (Changing)	35
Remote Commands	67
Remote Retrieval	66
Repeating Letters	25
Resolution	40
Ring Delay	33

Ring Volume	29
Roll Over Phone Lines	11

S

Sequential Polling Receive	37
Sort	77
Speaker Phone (answering)	55
Speaker Volume	28
Special Characters	25
Specifications	97
Speed Dial (Changing)	50
Speed Dial (Storing Numbers)	49
Speed Dialing	54
Stack	77
Standard (Resolution)	40
Station ID	24
Super Fine (Resolution)	40

T

TAD (Telephone Answering Device)	14
TEL. INDEX Lists	79
Telephone Answer Code	35
Telephone Index	55
Toll Saver	63
Tone/Pulse	23, 55
Trans. Verify Key	80
Transmission Verification Report	79
Troubleshooting	87
Two-Line Phone System	11

U

USER SETTINGS List	79
--------------------------	----

V

Voice Message (Erasing)	61
Voice Message and Memos (Playing)	60
Volume Amplify	28

X

XMIT REPORT	80
-------------------	----

Remote Retrieval Access Card

If you plan to retrieve voice or fax messages while away from your fax machine, carrying the Remote Retrieval Access Card printed below will serve as a convenient reminder of the retrieval procedures. Simply cut out the card and fold it to fit in your wallet or organizer. Keeping it handy will help you derive the full benefit of your fax machine's forwarding, paging and remote retrieval features.

<p>Retrieve all faxes press [2], then enter the number of remote fax machine, and then [#][#]. After the beep, hang up and wait. Erase all fax messages press [3].</p> <p>Check Receiving Status Press [9][7]. <i>then for Fax message</i>, press [1]. <i>Voice message</i>, press [2]. 1 long beep — Received message 3 short beeps — No messages</p> <p>Change Answer Mode Press [9][8]. <i>then for Message Center</i>, press [1]. <i>Fax/Telephone (F/T)</i>, press [2]. <i>Fax Only</i>, press [3].</p>	<p>Exit Remote Operation Press [9][0].</p>	<p>MESSAGE CENTER REMOTE RETRIEVAL ACCESS CARD</p> <p>Using Remote Access Code</p> <ol style="list-style-type: none"> 1 Dial your fax number from a fax machine using touch tone. 2 When your fax machine answers and beeps, immediately enter your Remote Retrieval Access Code (159*). 3 Your fax machine signals the kinds of messages received: <ul style="list-style-type: none"> 1 long beep — Fax message(s) 2 long beeps — Voice message(s) 3 long beeps — Fax and Voice No beeps — No messages 4 After 2 short beeps, enter a command. 5 Press [9][0] to reset the machine when you finish. 6 Hang up.
<p>1</p>	<p>6</p>	<p>5</p>

Changing Remote Retrieval Access Code

- 1 Press **[Function]**, **[8]**, **[7]**.
- 2 Enter a three-digit number from 000 to 999. The * cannot be changed.
- 3 Press **[Set]**.
- 4 Press **[Stop]** to exit.

Remote Commands

Listen to Voice Messages

- Press **[9]** **[1]**.
then to Repeat a message press **[1]**.
 Skip to next message press **[2]**.
 Stop playing the message press **[9]**.

Record a Memo

- Press **[9]** **[2]**.
 Wait for the beep, then speak.
then to Stop recording — Press **[9]**.

Erase All Messages

Press **[9]** **[3]**. If you hear three beeps, all messages have not yet been played, and the system will not erase.

Play/Record Outgoing Message

Press **[9]** **[4]**.
then to Play Message Center OGM, press **[1]** **[1]**.

Play F/T OGM press **[1]** **[2]**.
 Record new Message Center OGM, press **[2]** **[1]**, then speak

after beep. Press **[9]** to stop.

Record new F/T OGM press

[2] **[2]**, then speak after beep.
 Press **[9]** to stop.

Change Paging/Fax Forwarding Setting

Press **[9]** **[5]**.
then to Turn feature off press **[1]**.
 Enter Fax Forwarding Number press **[2]**.

Enter Paging Number press [3].

Program Fax Forward Number

press **[4]**. Enter the new number of the remote fax machine where you want your fax messages forwarded and then press **[#]** **[#]**. After two short beeps, press **[9]** **[6]** **[1]**. To retrieve a Memory Status List, enter the number of the remote fax machine, and press **[#]** **[#]**.

Retrieve a Fax

Press **[9]** **[6]**.

then to Print a Memory Status List

press **[1]**, enter the number of remote fax machine, and then **[#]** **[#]**. After the beep, hang up and wait.

2

3



Brother International Corporation
100 Somerset Corporate Boulevard
P.O. Box 6911
Bridgewater, NJ 08807-0911 USA

Brother International Corporation (Canada) Ltd.
1 rue Hôtel de Ville,
Dollard-des-Ormeaux, QC, CANADA H9B 3H6

Visit us on the World Wide Web
<http://www.brother.com>

These machines are made for use in the USA or CANADA only. We can not recommend using them overseas because it may violate the Telecommunications Regulations of that country and the power requirements of your fax machine may not be compatible with the power available in foreign countries. **Using USA or CANADA models overseas is at your own risk and will void your warranty.**

UF0839001
Printed in Malaysia

Free Manuals Download Website

<http://myh66.com>

<http://usermanuals.us>

<http://www.somanuals.com>

<http://www.4manuals.cc>

<http://www.manual-lib.com>

<http://www.404manual.com>

<http://www.luxmanual.com>

<http://aubethermostatmanual.com>

Golf course search by state

<http://golfingnear.com>

Email search by domain

<http://emailbydomain.com>

Auto manuals search

<http://auto.somanuals.com>

TV manuals search

<http://tv.somanuals.com>