

W  
D  
I  
D  
G  
S  
R  
E  
W  
S  
D

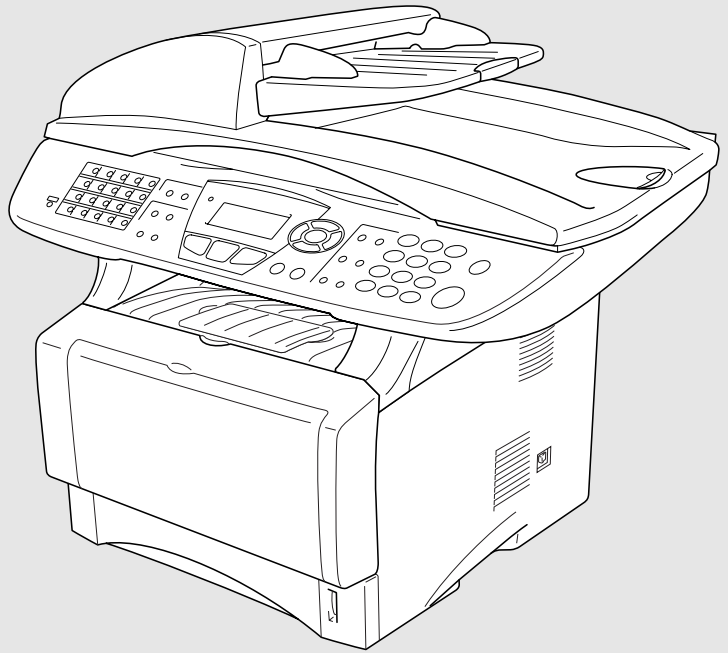

# MFC-8420 MFC-8820D MFC-8820DN

---

**brother.**

## If you need to call Customer Service

Please complete the following information for future reference:

**Model Number:** MFC-8420, MFC-8820D and MFC-8820DN  
(Circle your model number)

**Serial Number:\*** \_\_\_\_\_

**Date of Purchase:** \_\_\_\_\_

**Place of Purchase:** \_\_\_\_\_

\* The serial number is on the back of the unit. Retain this User's Guide with your sales receipt as a permanent record of your purchase, in the event of theft, fire or warranty service.

Register your product on-line at

[www.registermybrother.com](http://www.registermybrother.com)

By registering your product with Brother International Corporation, you will be recorded as the original owner of the product. Your registration with Brother:

- may serve as confirmation of the purchase date of your product should you lose your receipt;
- may support an insurance claim by you in the event of product loss covered by insurance; and,
- will help us notify you of enhancements to your product and special offers.

The most convenient and efficient way to register your new product is on-line at [www.registermybrother.com](http://www.registermybrother.com)

# Brother numbers

## IMPORTANT

For technical help, you must call the country where you bought the MFC. Calls must be made **from within** that country.

## Register your product

By registering your product with Brother International Corporation, you will be recorded as the original owner of the product. Your registration with Brother:

- may serve as confirmation of the purchase date of your product should you lose your receipt;
- may support an insurance claim by you in the event of product loss covered by insurance; and,
- will help us notify you of enhancements to your product and special offers.

Please complete and fax the Brother Warranty Registration And Test Sheet or, for your convenience and most efficient way to register your new product, register on-line at

[www.registermybrother.com](http://www.registermybrother.com)

## Frequently asked questions (FAQs)

The Brother Solutions Center is our one-stop resource for all your Fax Machine/Multi-Function Center needs. You can download the latest software and utilities, read FAQs and troubleshooting tips, and go to the “Solutions” section to learn how to get the most from your Brother product.

<http://solutions.brother.com>



You can check here for Brother driver updates.

## For Customer Service

- In USA:** 1-800-284-4329 (voice)  
1-901-379-1215 (fax)  
1-800-284-3238 (TTY service for the hearing-impaired)
- In Canada:** 1-877-BROTHER (voice)  
(514) 685-4898 (fax)  
(514) 685-6464 (voice) **In Montreal**

### Service Center Locator (USA only)

For the location of a Brother authorized service center, call 1-800-284-4357.

### Service Center Locations (Canada only)

For the location of a Brother authorized service center, call 1-877-BROTHER.

## Brother fax back system (USA only)

Brother has installed an easy-to-use fax back system, so you can get instant answers to common technical questions and product information for all Brother products. This system is available 24 hours a day, 7 days a week. You can use and an Index of fax back subjects.

**In USA only:** 1-800-521-2846

The Brother fax back system number has been preprogramming on One-Touch Key **01**.

## Ordering accessories and supplies

For best quality results use only genuine Brother accessories, which are available at most Brother retailers. If you cannot find the accessory you need and you have a Visa, MasterCard, Discover, or American Express credit card, you can order accessories directly from Brother. (In the USA, you can visit us online for a complete selection of the Brother accessories and supplies that are available for purchase.)

**In USA:** 1-888-879-3232 (voice)  
1-800-947-1445 (fax)

<http://www.brothermall.com>

**In Canada:** 1-877-BROTHER (voice)

Description	Item
Toner Cartridge	TN-530 (Standard, prints up to 3,300 pages) TN-560 (High yield, prints up to 6,500 pages)
Drum Unit	DR-500
Telephone Line Cord	LG3077001
IEEE-1284 Bi-directional Cable	F2A046-10
Power Protector for A/C Power, Phone Line Surges and Voltage Spikes (2 outlets)	QPD120
Power Protector for A/C Power, Phone Line Surges and Voltage Spikes (8 outlets)	FX120
Paper Tray #2 (Option)	LT-5000
Network (LAN) Board (Option)	NC-9100h
Brother Print/Fax Server (10/100 Base-TX Ethernet Network)	
User's Guide	LE8881001 (English for USA and Canada) LE8931001 (French For Canada)
Quick Setup Guide	LE8883001 (English for USA and Canada) LE8936001 (French For Canada)



## **Notice - Disclaimer of Warranties (USA and Canada)**

BROTHER'S LICENSOR(S), AND THEIR DIRECTORS, OFFICERS, EMPLOYEES OR AGENTS (COLLECTIVELY BROTHER'S LICENSOR) MAKE NO WARRANTIES, EXPRESS OR IMPLIED, INCLUDING WITHOUT LIMITATION THE IMPLIED WARRANTIES OF MERCHANTABILITY AND FITNESS FOR A PARTICULAR PURPOSE, REGARDING THE SOFTWARE. BROTHER'S LICENSOR(S) DOES NOT WARRANT, GUARANTEE OR MAKE ANY REPRESENTATIONS REGARDING THE USE OR THE RESULTS OF THE USE OF THE SOFTWARE IN TERMS OF ITS CORRECTNESS, ACCURACY, RELIABILITY, CURRENTNESS OR OTHERWISE. THE ENTIRE RISK AS TO THE RESULTS AND PERFORMANCE OF THE SOFTWARE IS ASSUMED BY YOU. THE EXCLUSION OF IMPLIED WARRANTIES IS NOT PERMITTED BY SOME STATES IN THE USA AND SOME PROVINCES IN CANADA. THE ABOVE EXCLUSION MAY NOT APPLY TO YOU.

IN NO EVENT WILL BROTHER'S LICENSOR(S) BE LIABLE TO YOU FOR ANY CONSEQUENTIAL, INCIDENTAL OR INDIRECT DAMAGES (INCLUDING DAMAGES FOR LOSS OF BUSINESS PROFITS, BUSINESS INTERRUPTION, LOSS OF BUSINESS INFORMATION, AND THE LIKE) ARISING OUT OF THE USE OR INABILITY TO USE THE SOFTWARE EVEN IF BROTHER'S LICENSOR HAS BEEN ADVISED OF THE POSSIBILITY OF SUCH DAMAGES. BECAUSE SOME STATES IN THE USA AND SOME PROVINCES IN CANADA DO NOT ALLOW THE EXCLUSION OR LIMITATION OF LIABILITY FOR CONSEQUENTIAL OR INCIDENTAL DAMAGES, THE ABOVE LIMITATIONS MAY NOT APPLY TO YOU. IN ANY EVENT BROTHER'S LICENSOR'S LIABILITY TO YOU FOR ACTUAL DAMAGES FROM ANY CAUSE WHATSOEVER, AND REGARDLESS OF THE FORM OF THE ACTION (WHETHER IN CONTRACT, TORT (INCLUDING NEGLIGENCE), PRODUCT LIABILITY OR OTHERWISE), WILL BE LIMITED TO \$50.

### **Compilation and Publication Notice**

Under the supervision of Brother Industries Ltd., this manual has been compiled and published, covering the latest product descriptions and specifications.

The contents of this manual and the specifications of this product are subject to change without notice.

Brother reserves the right to make changes without notice in the specifications and materials contained herein and shall not be responsible for any damages (including consequential) caused by reliance on the materials presented, including but not limited to typographical and other errors relating to the publication.

# Brother® One Year Limited Warranty and Replacement Service (USA only)

## Who is covered:

- This limited warranty (“warranty”) is given only to the original end-use/retail purchaser (referred to in this warranty as “Original Purchase”) of the accompanying product, consumables and accessories (collectively referred to in this warranty as “this Product”).
- If you purchased a product from someone other than an authorized Brother reseller in the United States or if the product was used (including but not limited to floor models or refurbished product), prior to your purchase you are not the Original Purchaser and the product that you purchased is not covered by this warranty.

## What is covered:

- This Product includes a Machine and Consumable and Accessory Items. Consumable and Accessory Items include but are not limited to print heads, toner, drums, ink cartridges, print cartridges, refill ribbons, therma PLUS paper and thermal paper.
- Except as otherwise provided herein, Brother warrants that the Machine and the accompanying Consumable and Accessory Items will be free from defects in materials and workmanship, when used under normal conditions.
- This warranty applies only to products purchased and used in the United States. For products purchased in, but used outside, the United States, this warranty covers only warranty service within the United States (and does not include shipping outside the United States).

## What is the length of the Warranty Periods:

- Machines: one year from the original purchase date.
- Accompanying Consumable and Accessory Items: 90 days from the original purchase date or the rated life of consumable, whichever comes first.

## What is NOT covered:

This warranty does not cover:

- (1) Physical damage to this Product;
- (2) Damage caused by improper installation, improper or abnormal use, misuse, neglect or accident (including but not limited to transporting this Product without the proper preparation and/or packaging);
- (3) Damage caused by another device or software used with this Product (including

but not limited to damage resulting from use of non Brother® brand parts and Consumable and Accessory Items);

- (4) Consumable and Accessory Items that expired in accordance with a rated life; and,
- (5) Problems arising from other than defects in materials or workmanship.

This limited warranty is VOID if this Product has been altered or modified in any way (including but not limited to attempted warranty repair without authorization from Brother and/or alteration/removal of the serial number).

## What to do if you think your Product is eligible for warranty service:

Report your issue to either our Customer Service Hotline at 1-800-284-4329 or a Brother Authorized Service Center **within the applicable warranty period.** Supply Brother or the Brother Authorized Service Center with a copy of your dated bill of sale showing that this Product was purchased within the U.S. For the name of local Brother Authorized Service Center(s), call 1-800-521-2846.

## What Brother will ask you to do:

After contacting Brother or a Brother Authorized Service Center, you may be required to deliver (by hand if you prefer) or send the Product properly packaged, freight prepaid, to the Authorized Service Center together with a photocopy of your bill of sale. **You are responsible for the cost of shipping, packing product, and insurance (if you desire). You are also responsible for loss or damage to this Product in shipping.**

## What Brother will do:

If the problem reported concerning your Machine and/or accompanying Consumable and Accessory Items is covered by this warranty and if you first reported the problem to Brother or an Authorized Service Center within the applicable warranty period, Brother or its Authorized Service Center will repair or replace the Machine and/or accompanying Consumable and Accessory Items at no charge to you for parts or labor. The decision as to whether to repair or replace the Machine and/or accompanying Consumable and Accessory Items is made by Brother in its sole discretion. Brother reserves the right to supply a refurbished or remanufactured replacement Machine and/or accompanying Consumable and Accessory Items and use refurbished parts

## Brother® One Year Limited Warranty and Replacement Service (USA only)

provided such replacement products conform to the manufacturer's specifications for new product/parts. The repaired or replacement Machine and/or accompanying Consumable and Accessory Items will be returned to you freight prepaid or made available for you to pick up at a conveniently located Authorized Service Center.

If the Machine and/or accompanying Consumable and Accessory Items are not covered by this warranty (either stage), you will be charged for shipping the Machine and/or accompanying Consumable and Accessory Items back to you.

**The foregoing are your sole (i.e., only) and exclusive remedies under this warranty.**

**What happens when Brother elects to replace your Machine:**

When a replacement Machine is authorized by Brother, and you have delivered the Machine to an Authorized Service Center, the Authorized Service Center will provide you with a replacement Machine after receiving one from Brother. If you are dealing directly with Brother, Brother will send to you a replacement Machine with the understanding that you will, after receipt of the replacement Machine, supply the required proof of purchase information, together with the Machine that Brother agreed to replace. You are then expected to pack the Machine that Brother agreed to replace in the package from the replacement Machine and return it to Brother using the pre-paid freight bill supplied by Brother in accordance with the instructions provided by Brother. Since you will be in possession of two machines, Brother will require that you provide a valid major credit card number. Brother will issue a hold against the credit card account number that you provide until Brother receives your original Product and determines that your original Product is entitled to warranty coverage. Your credit card will be charged up to the cost of a new Product only if: (i) you do not return your original Product to Brother within five (5) business days; (ii) the problems with your original Product are not covered by the limited warranty; (iii) the proper packaging instructions are not followed and has caused damage to the product; or (iv) the warranty period on your original Product has expired or has not been sufficiently validated with a copy of the proof of purchase (bill of sale). The replacement Machine you receive (even if refurbished or remanufactured) will be

covered by the balance of the limited warranty period remaining on the original Product, plus an additional thirty (30) days. You will keep the replacement Machine that is sent to you and your original Machine shall become the property of Brother. **Retain your original Accessory Items and a copy of the return freight bill, signed by the courier.**

**Limitations:**

Brother is not responsible for damage to or loss of any equipment, media, programs or data related to the use of this Product. Except for that repair or replacement as described above, Brother shall not be liable for any direct, indirect, incidental or consequential damages or specific relief. Because some states do not allow the exclusion or limitation of consequential or incidental damages, the above limitation may not apply to you.

THIS WARRANTY IS GIVEN IN LIEU OF ALL OTHER WARRANTIES, WRITTEN OR ORAL, WHETHER EXPRESSED BY AFFIRMATION, PROMISE, DESCRIPTION, DRAWING, MODEL OR SAMPLE. ANY AND ALL WARRANTIES OTHER THAN THIS ONE, WHETHER EXPRESS OR IMPLIED, INCLUDING IMPLIED WARRANTIES OF MERCHANTABILITY AND FITNESS FOR A PARTICULAR PURPOSE, ARE HEREBY DISCLAIMED.

- This Limited Warranty is the only warranty that Brother is giving for this Product. It is the *final expression and the exclusive and only statement* of Brother's obligations to you. It replaces all other agreements and understandings that you may have with Brother or its representatives.
- This warranty gives you certain rights and you may also have other rights that may vary from state to state.
- This Limited Warranty (and Brother's obligation to you) may not be changed in any way unless you and Brother sign the same piece of paper in which we (1) refer to this Product and your bill of sale date, (2) describe the change to this warranty and (3) agree to make that change.

**Important:** *We recommend that you keep all original packing materials, in the event that you ship this product.*

## **BROTHER MULTIFUNCTION CENTER/FACSIMILE MACHINE LIMITED WARRANTY (Canada only)**

Pursuant to this limited warranty of 1 year from the date of purchase for labour and parts, Brother International Corporation (Canada) Ltd. ("Brother"), or its Authorized Service Centers, will repair this MFC/Facsimile machine free of charge if defective in material or workmanship. This Limited Warranty does not include cleaning, consumables (including, without limitation, print cartridges, print head, toner and drum) or damage caused by accident, neglect, misuse or improper installation or operation, any damage caused from service, maintenance, modifications, or tampering by anyone other than a Brother Authorized Service Representative, or from the use of supplies or consumable items that are non-Brother products. Operation of the MFC/Facsimile machine in excess of the specifications or with the Serial Number or Rating Label removed shall be deemed abuse and all repairs thereafter shall be the sole liability of the end-user/purchaser. In order to obtain warranty service, the MFC/Facsimile machine must be delivered or shipped freight prepaid by the end user/purchaser to a "Brother" Authorized Service Center, together with your Proof of Purchase in the form of a Sales Receipt.

For laser products: Failure to remove the Toner Cartridge (and Toner Drum Unit on applicable models) during shipping will cause severe damage to the MFC/Facsimile and will VOID the Warranty. (Refer to your Operation Manual for proper packaging.)

For ink-jet products: Do not remove the ink cartridges during shipping. Damage to your print head resulting from packing without the ink cartridges will VOID your warranty. (Refer to your Operation Manual for proper packaging.)

**BROTHER DISCLAIMS ALL OTHER WARRANTIES EXPRESSED OR IMPLIED INCLUDING, WITHOUT LIMITATION, ANY IMPLIED WARRANTIES OF MERCHANTABILITY OR FITNESS FOR A PARTICULAR PURPOSE, EXCEPT TO THE EXTENT THAT ANY WARRANTIES IMPLIED BY LAW CANNOT BE VALIDLY WAIVED.**

No oral or written information, advice or representation provided by Brother, its Authorized Service Centers, Distributors, Dealers, Agents or employees, shall create another warranty or modify this warranty. This warranty states Brother's entire liability and your exclusive remedy against Brother for any failure of the MFC/Facsimile machine to operate properly.

Neither Brother nor anyone else involved in the development, production, or delivery of this MFC/Facsimile machine shall be liable for any indirect, incidental, special, consequential, exemplary, or punitive damages, including lost profits, arising from the use of or inability to use the product, even if advised by the end user/purchaser of the possibility of such damages. Since some Provinces do not allow the above limitation of liability, such limitation may not apply to you.

This Limited Warranty gives you specific legal rights and you may also have other rights which vary from Providence to Providence.

**Warranty Service is available at Brother Authorized Service Centers throughout Canada. For Technical Support or for the name and location of your nearest Authorized Service Center call 1-877-BROTHER. Within Montreal, please call (514) 685-6464.**

**Internet support: [support@brother.ca](mailto:support@brother.ca) or [brows e](http://www.brother.com)**

**Brother's Web Site: [www.brother.com](http://www.brother.com)**

Brother International Corporation (Canada) Ltd.

1 Rue Hôtel de Ville

Dollard-Des-Omeaux, QC H9B 3H6







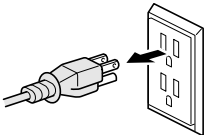

At your side.  
The Brother logo consists of the word "brother" in a bold, lowercase, sans-serif font. A registered trademark symbol (®) is located to the right of the word.

# Safety precautions

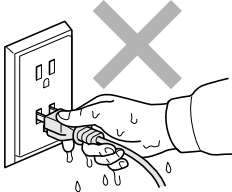
## To use the MFC safely

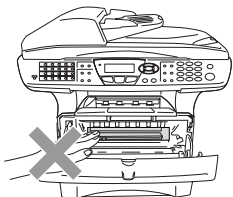
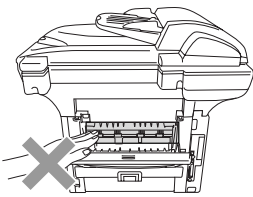
Save these instructions for later reference.

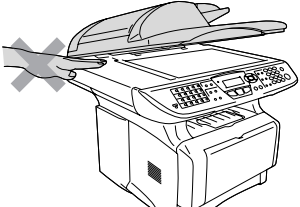
### WARNING

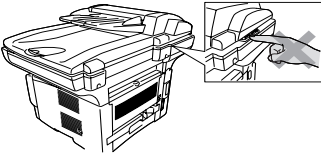
	<p>There are high voltage electrodes inside the MFC. Before you clean the MFC or clear a paper jam, make sure you have unplugged the power cord from the power outlet.</p> 		<p>Do not handle the plug with wet hands. Doing this might cause an electrical shock.</p> 
	<p>After you use the MFC, some internal parts are extremely HOT! To prevent injuries, be careful not to put your fingers in the area shown in the illustration.</p>  		
	<p>To prevent injuries, be careful not to put your hands on the edge of the MFC under the document cover.</p> 		<p>To prevent injuries, be careful not to put your fingers in the area shown in the illustration.</p> 

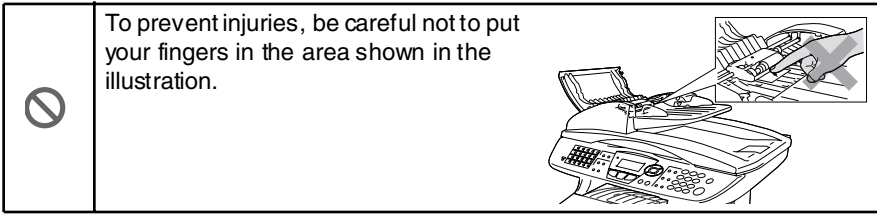

 **WARNING**

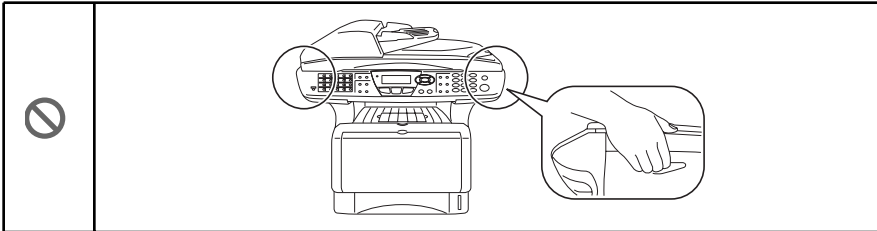

- When you move the MFC, grasp the side handholds that are under the scanner. Do NOT carry the MFC by holding it at the bottom.
- Use caution when installing or modifying telephone lines. Never touch telephone wires or terminals that are not insulated unless the telephone line has been disconnected at the wall jack. Never install telephone wiring during a lightning storm. Never install a telephone jack in a wet location unless the jack is specifically designed for a wet location.
- Install equipment with a power cord near a socket/outlet that is easily accessible.
- To reduce the risk of shock or fire, use only a No. 26 AWG or larger telecommunication line cord.
- Do not use a telephone in the vicinity of gas leak to report leak.
- Do not use this product near appliances that use water, in a wet basement or near a swimming pool.
- Avoid using a telephone other than a cordless type during an electrical storm. There may be a remote risk of electric shock from lightning.

 **Caution**

- Lightning and power surges can damage this product! We recommend that you use a quality surge protection device on the AC power line and on the telephone line, or unplug the lines during a lightning storm.

# Choosing a location

Place your MFC on a flat, stable surface that is free of vibration and shocks, such as a desk. Put the MFC near a telephone jack and a standard, grounded power outlet. Choose a location where the temperature remains between 50°F and 95.5°F (10°-32.5°C).

## ! Caution

- Avoid placing your MFC in a high-traffic area.
- Do not place near heaters, air conditioners, water, chemicals, or refrigerators.
- Do not expose the MFC to direct sunlight, excessive heat, moisture, or dust.
- Do not connect your MFC to electrical outlets controlled by wall switches or automatic timers.
- Disruption of power can wipe out information in the MFC's memory.
- Do not connect your MFC to electrical outlets on the same circuit as large appliances or other Equipment that might disrupt the power supply.
- Avoid interference sources, such as speakers or the base units of cordless phones.



# Quick Reference Guide







## Sending faxes

### Automatic Transmission

- 1 If it is not illuminated in green, press  (**Fax**).
- 2 Place the original face up in the ADF, or face down on the scanner glass.
- 3 Enter the fax number using One-Touch, Speed-Dial, Search or the dial pad.
- 4 Press **Start**.
- 5 If you are using the scanner glass, press **2** or **Start**.

### Real Time Transmission

You can send faxes in real time.

- 1 If it is not illuminated in green, press  (**Fax**).
- 2 Place the original face up in the ADF, or face down on the scanner glass.
- 3 Press **Menu, 2, 2, 5**.
- 4 Press  or  to select **On**, and then press **Set**.  
—OR—  
For the next transmission only, press  or  to select **Next Fax Only**, and then press **Set**.
- 5 For the next fax only, press  or  to select **Next Fax: On**, and then press **Set**.



- 6 Press **1** if you want to choose more settings and the LCD will return to the Setup send menu.

—OR—

- Press **2** to fax.
- 7 Enter the fax number.
- 8 Press **Start**.

## Receiving faxes

### Select Receive Mode

- 1 Press **Menu, 0, 1**.
- 2 Press  or  to select **Fax Only**, **Manual**, **Fax/Tel and External TAD** and then press **Set**.

## Storing numbers

### Storing One-Touch Dial numbers

- 1 Press **Menu, 2, 3, 1**.
- 2 Press the One-Touch key where you want to store the number.
- 3 Enter a number (up to 20 digits), and then press **Set**.
- 4 Enter a name (or leave it blank), and then press **Set**.
- 5 Press **Stop/Exit**.



## Storing Speed-Dial numbers



- 1 Press **Menu**, **2**, **3**, **2**.
- 2 Enter a three-digit Speed-Dial number, and then press **Set**.
- 3 Enter a number (up to 20 digits), and then press **Set**.
- 4 Enter a name (or leave it blank), and then press **Set**.
- 5 Press **Stop/Exit**.

## Dialing operations

### One-Touch Dialing / Speed-Dialing

- 1 If it is not illuminated in green, press  (**Fax**).
- 2 Place the original face up in the ADF, or face down on the scanner glass.
- 3 Press the One-Touch key of the number you want to call —OR—  
Press **Search/Speed Dial**, press #, and then press the three-digit Speed-Dial number.
- 4 Press **Start**.

### Using Search



- 1 If it is not illuminated in green, press  (**Fax**).
- 2 Press **Search/Speed Dial**, and then enter the first letter of the name you're looking for.
- 3 Press  or  to search the memory.
- 4 Press **Start**.

## Making copies

### Single copy

- 1 Press  (**Copy**) to illuminate it in green.
- 2 Place the original face up in the ADF, or face down on the scanner glass.
- 3 Press **Start**.

### Sorting multiple copies (Using the ADF)

- 1 Press  (**Copy**) to illuminate it in green.
- 2 Place the original face up in the ADF.
- 3 Use the dial pad to enter the number of copies you want (up to 99).
- 4 Press **Sort**.  
Sort  icon appears on the LCD.
- 5 Press **Start**.

Brother fax back system:

**In USA:** 1-800-521-2846

Brother Global Web Site:

<http://www.brother.com>

Frequently Asked Questions (FAQs) and Product Support

<http://solutions.brother.com>

Brother Accessories & Supplies:

**In USA:** 1-888-879-3232 (voice)

1-800-947-1445 (fax)

<http://www.brothermall.com>

**In Canada:** 1-877-BROTHER (voice)

# Table of contents

## 1

<b>Introduction .....</b>	<b>1-1</b>
Using this Guide .....	1-1
Finding information.....	1-1
Symbols used in this Guide.....	1-1
Fax Test Sheet and Product Registration (USA only)	1-2
On-Line Registration (USA and Canada) .....	1-2
MFC part names and operations .....	1-3
Control panel overview .....	1-6
Status LED indications .....	1-11
About fax machines .....	1-13
Custom features .....	1-13
Do you have Voice Mail on the phone line?.....	1-13
Why should there be problems?.....	1-13
How can you avoid possible problems? .....	1-13
Fax tones and handshake .....	1-14
ECM (Error Correction Mode).....	1-15
Connecting the MFC.....	1-15
Connecting an external telephone.....	1-15
Connecting an external telephone answering device (TAD).....	1-16
Sequence .....	1-16
Connections .....	1-18
Recording outgoing message (OGM) on an external TAD .....	1-18
Special line considerations .....	1-19
Roll-over phone lines.....	1-19
Two-line phone system .....	1-19
Converting telephone wall outlets .....	1-20
Installing MFC, external two-line tad and two-line telephone.....	1-21
Multi-line connections (PBX) .....	1-22
If you are installing the MFC to work with a PBX.	1-22
Custom features on your phone line.....	1-22

## 2

<b>Paper .....</b>	<b>2-1</b>
About paper .....	2-1
Type and size of paper .....	2-1
Recommended paper .....	2-1
Choosing acceptable paper .....	2-2
Paper capacity of the paper trays.....	2-3
Paper specifications for each paper tray.....	2-4

How to load paper.....	2-5
To load paper or other media in the paper tray .....	2-5
To load paper or other media in the manual feed tray (For MFC-8420) .....	2-7
To load paper or other media in the multi-purpose tray (MP tray) (For MFC-8820D and MFC-8820DN) .....	2-8
To use Automatic Duplexing for fax, copy and print operations (For MFC-8820D and MFC-8820DN).....	2-10

### 3

<b>On-screen programming .....</b>	<b>3-1</b>
User-friendly programming .....	3-1
Menu table.....	3-1
Memory Storage .....	3-1
Navigation keys .....	3-2

### 4

<b>Getting started .....</b>	<b>4-1</b>
Initial Setup.....	4-1
Setting the Date and Time.....	4-1
Setting the Station ID.....	4-2
Entering text .....	4-3
Inserting spaces .....	4-3
Making corrections .....	4-3
Repeating letters .....	4-3
Special characters and symbols .....	4-4
Setting Tone and Pulse dialing mode (For Canada only).....	4-4
General Setup.....	4-5
Setting the Mode Timer .....	4-5
Setting the Paper Type.....	4-5
Setting the Paper Size.....	4-6
Setting the Ring Volume .....	4-8
Setting the Beeper Volume.....	4-8
Setting the Speaker Volume.....	4-9
Turning on Automatic Daylight Savings Time.....	4-9
Toner Save .....	4-9
Sleep Time.....	4-10
Turning off the Scanner Lamp .....	4-10
Setting the Tray Use for Copy mode .....	4-11
Setting the Tray Use for Fax mode.....	4-12
Setting the LCD Contrast.....	4-12

<b>Setup Receive .....</b>	<b>5-1</b>
Basic receiving operations .....	5-1
Choosing the Receive Mode .....	5-1
To select or change your Receive Mode .....	5-2
Setting the Ring Delay .....	5-2
Setting the F/T Ring Time (Fax/Tel mode only) .....	5-3
Easy Receive .....	5-4
Printing a reduced incoming fax (Auto Reduction) .....	5-5
Printing a fax from the memory .....	5-5
Setting the Print Density .....	5-6
Advanced receiving operations .....	5-7
Operation from extension telephones .....	5-7
For FAX/TEL mode only .....	5-7
Using a cordless external handset .....	5-8
Changing the remote codes .....	5-8
Polling .....	5-9
Setting up Polling Receive .....	5-9
Setting up Sequential Polling Receive .....	5-10
Setting Duplex printing for Fax mode (For MFC-8820D and MFC-8820DN) .....	5-10
Telephone services .....	5-11
Distinctive Ring .....	5-11
What does your telephone company's 'Distinctive Ring' do? .....	5-11
What does Brother's 'Distinctive Ring' do? .....	5-11
Do you have Voice Mail? .....	5-12
Before you choose the ring pattern to register .....	5-12
Registering the Distinctive Ring pattern .....	5-13
Turning off the Distinctive Ring .....	5-13
Caller ID .....	5-14
Viewing Caller ID List .....	5-15
Clearing a Caller ID stored in the memory .....	5-15
Printing Caller ID List .....	5-15

<b>Setup Send .....</b>	<b>6-1</b>
How to Fax .....	6-1
Enter Fax mode .....	6-1
Faxing from the automatic document feeder (ADF) .....	6-1
Faxing from the ADF .....	6-2
Faxing from the scanner glass .....	6-3
Faxing legal size originals from the scanner glass .....	6-4
Out of Memory message .....	6-4
Manual transmission .....	6-4

Automatic transmission.....	6-5
This is the easiest way to send a fax.....	6-5
Sending a fax at the end of a conversation .....	6-5
Basic sending operations.....	6-6
Sending faxes using multiple settings.....	6-6
Contrast .....	6-6
Fax Resolution.....	6-7
Manual and automatic fax Redial .....	6-8
Dual Access .....	6-9
Real Time Transmission .....	6-10
Checking job status .....	6-11
Canceling a job while scanning the original.....	6-11
Canceling a scheduled job.....	6-11
Advanced sending operations .....	6-12
Composing the electronic Cover Page .....	6-12
Composing your own comments .....	6-13
Cover page for the next fax only.....	6-14
Send a cover page for all faxes.....	6-15
Using a printed cover page.....	6-15
Broadcasting.....	6-16
Overseas Mode .....	6-18
Delayed Fax.....	6-19
Delayed Batch Transmission.....	6-20
Setting up Polled Transmission .....	6-21
Memory Security.....	6-22
Setting up the password .....	6-22
Turning Memory Security on .....	6-23
Turning Memory Security off.....	6-23

## 7

<b>Auto Dial numbers and dialing options .....</b>	<b>7-1</b>
Storing numbers for easy dialing .....	7-1
Storing One-Touch Dial numbers.....	7-1
Storing Speed-Dial numbers.....	7-2
Changing One-Touch and Speed-Dial numbers.....	7-3
Setting up Groups for Broadcasting.....	7-4
Dialing options.....	7-5
Search .....	7-5
One-Touch Dialing.....	7-5
Speed-Dialing.....	7-6
Manual dialing.....	7-6
Using an external telephone.....	7-6
Access codes and credit card numbers.....	7-7
Pause .....	7-8
Tone or Pulse (Canada only).....	7-8

<b>Remote Fax Options .....</b>	<b>8-1</b>
Fax Forwarding/Paging .....	8-1
Programming a Fax Forwarding number.....	8-1
Programming your pager number.....	8-2
Setting Fax Storage .....	8-3
Setting your Remote Access Code .....	8-4
Remote Retrieval .....	8-5
Using your Remote Access Code .....	8-5
Remote commands .....	8-6
Retrieving fax messages .....	8-7
Changing your Fax Forwarding number .....	8-7

<b>Printing reports .....</b>	<b>9-1</b>
MFC settings and activity .....	9-1
Customizing the Transmission Verification Report.....	9-1
Setting the Fax Activity Report Interval .....	9-2
Printing reports .....	9-3
To print a report.....	9-3

<b>Making copies .....</b>	<b>10-1</b>
Using the MFC as a copier .....	10-1
Enter Copy mode.....	10-1
Temporary copy settings.....	10-2
Making a single copy from the ADF.....	10-3
Making multiple copies from the ADF.....	10-3
Single or multiple copies using the scanner glass....	10-4
Out of Memory message .....	10-5
Using the copy keys (Temporary settings) .....	10-6
Enlarge/Reduce .....	10-7
Quality (type of original).....	10-8
Sorting copies using the ADF .....	10-9
Contrast.....	10-9
Tray Select .....	10-10
Duplex/N in 1 .....	10-11
Duplex/N in 1 copy .....	10-12
N in 1 copy .....	10-12
Poster.....	10-13
Duplex (1 in 1)	
(For MFC-8820D and MFC-8820DN).....	10-13
Duplex (2 in 1) and Duplex (4 in 1)	
(For MFC-8820D and MFC-8820DN).....	10-15
Changing the default copy settings .....	10-16
Quality .....	10-16
Contrast.....	10-16

<b>Using the MFC as a printer .....</b>	<b>11-1</b>
Using the Brother MFC-8420, MFC-8820D or MFC-8820DN printer driver.....	11-1
How to print your document.....	11-2
Simultaneous printing and faxing.....	11-3
Two-sided printing (Duplex Printing).....	11-3
Automatic Duplex Printing (For MFC-8820D and MFC-8820DN) .....	11-3
Manual Duplex Printing .....	11-4
Face-down output tray.....	11-4
Printing on plain paper.....	11-5
The manual feed tray (For MFC-8420).....	11-5
The MP tray (For MFC-8820D and MFC-8820DN) .....	11-6
Printing on thicker paper and card stock .....	11-7
The manual feed tray (For MFC-8420).....	11-7
The multi-purpose tray (MP tray) (For MFC-8820D and MFC-8820DN) .....	11-9
Printing on envelopes.....	11-11
Printer operation keys.....	11-16
Job Cancel.....	11-16
Secure key.....	11-16
Setting the Emulation Selection.....	11-17
Printing the Internal Font List.....	11-18
Printing the Print Configuration List.....	11-18
Restoring factory default settings.....	11-18

<b>Printer driver settings .....</b>	<b>12-1</b>
Printer driver settings.....	12-1
How to access the printer driver settings.....	12-1
Features in the Brother Native Driver.....	12-2
Basic tab.....	12-2
Paper Size.....	12-3
Multiple Page.....	12-3
Orientation.....	12-3
Copies .....	12-4
Media Type.....	12-4
Advanced tab.....	12-5
Print Quality.....	12-5
Duplex Printing .....	12-7
Watermark.....	12-8
Page Setting.....	12-10
Device Options .....	12-11
Secure Print.....	12-11

Accessories tab .....	12-15
Support tab .....	12-16
Features in the PS printer driver	
(For Windows®) .....	12-17
Ports tab .....	12-17
Device Settings tab .....	12-18
Layout tab .....	12-19
Paper / Quality tab .....	12-20
Advanced Options .....	12-21

## 13

<b>How to scan using Windows® .....</b>	<b>13-1</b>
Scanning a document .....	13-1
TWAIN compliant.....	13-1
How to access the Scanner .....	13-2
Scanning a document into the PC .....	13-3
Scanning a whole page .....	13-3
PreScanning to crop a portion you want to scan..	13-4
Settings in the Scanner window .....	13-6
Image Type .....	13-6
Resolution .....	13-6
Scan Type .....	13-7
Brightness .....	13-7
Contrast.....	13-7
Document Size.....	13-8
Scanning a document (For Windows® XP only) .....	13-10
WIA compliant .....	13-10
How to access the scanner .....	13-10
Scanning a document into the PC .....	13-11
Scanning a document using the ADF.....	13-11
PreScanning to crop a portion you want to scan using the scanner glass.....	13-13
Brother Scanner Utility .....	13-15
Using the scan key (For USB or Parallel interface cable users).....	13-16
Scan to E-mail .....	13-17
Scan to Image .....	13-17
Scan to OCR .....	13-18
Scan to File.....	13-18
Using ScanSoft® PaperPort® and TextBridge® OCR....	13-19
Viewing items .....	13-20
Organizing your items in folders .....	13-21
Quick links to other applications .....	13-21
ScanSoft® TextBridge® OCR lets you convert image text into text you can edit .....	13-22



You can Import items from other applications .....	13-22
You can Export items in other formats.....	13-23
Exporting an image file.....	13-23
How to Uninstall PaperPort® and ScanSoft® TextBridge® .....	13-24

# 14

## Using the Brother Control Center for Windows® 95/98/98SE/Me/2000 Professional and

<b>Windows NT® WS 4.0 .....</b>	<b>14-1</b>
Brother MFL-Pro Control Center.....	14-1
AutoLoad the Brother Control Center.....	14-2
How to turn off AutoLoad.....	14-2
Brother Control Center features.....	14-3
Auto Configuration .....	14-3
Scan key operations .....	14-4
Copy operations.....	14-4
PC-Fax operation.....	14-4
Scanner settings for Scan, Copy and PC-Fax buttons.....	14-5
Global settings.....	14-5
Setting up the scanner configurations .....	14-6
Perform an operation from the Control Center screen .....	14-7
Scan to File.....	14-8
To access Scan to File Configurations screen .....	14-8
Scanner settings.....	14-8
Destination folder.....	14-9
Scan to E-mail .....	14-10
To access Scan to E-mail Configurations screen...	14-10
Scanner settings.....	14-10
E-mail application .....	14-11
Send to Options.....	14-11
Scan to OCR (Word Processor) .....	14-12
To access Scan to OCR Configurations screen .....	14-12
Scanner settings.....	14-12
Word Processor.....	14-13
Scan to Image.....	14-14
To access Scan to Image Configurations screen ...	14-14
Scanner Settings .....	14-14
Target Application.....	14-14
Copy .....	14-15
To access the Copy Configurations screen.....	14-15
Scanner settings.....	14-15
Number of copies.....	14-15

Send a fax .....	14-16
To access the Send a fax Configurations screen ...	14-16
Scanner settings .....	14-16
PC-FAX Settings .....	14-17

# 15

## Using the Windows®-Based Brother SmartUI

<b>Control Center .....</b>	<b>15-1</b>
Brother SmartUI Control Center .....	15-1
AutoLoad the Brother Control Center .....	15-2
How to turn off Auto Load.....	15-2
Brother Control Center features .....	15-3
Auto Configuration .....	15-4
Hardware Section: Changing the Scan to button configuration.....	15-5
Scan to E-mail .....	15-6
Scan to File.....	15-7
Scan to Image .....	15-8
Scan to OCR .....	15-10
Software Section .....	15-12
Scan .....	15-13
Copy .....	15-13
Fax.....	15-14
Custom .....	15-14
Scan to File .....	15-15
Scan to E-mail .....	15-17
File attachments .....	15-19
Scanner settings.....	15-20
Scan to OCR (Word Processing program) .....	15-21
Scan to Graphics application (example: Microsoft Paint).....	15-23
Copy .....	15-25
Fax setting (PC-Fax using the Brother Fax Driver) .....	15-27
FAX settings .....	15-28
Custom: User-defined buttons.....	15-30
Customizing a user-defined button .....	15-30
1. Select the Scan Action .....	15-30
2. Select Configuration for the Scan Type.....	15-31
3. Select Scan Settings. ....	15-35

<b>Using MFC Remote Setup .....</b>	<b>16-1</b>
MFC Remote Setup.....	16-1

<b>Using Brother PC-FAX software .....</b>	<b>17-1</b>
PC-FAX sending .....	17-1
Setting up user information.....	17-2
Sending setup.....	17-3
Outside line access.....	17-4
Include header.....	17-4
Address Book file.....	17-4
User interface .....	17-5
Simple style .....	17-5
Facsimile style .....	17-5
Speed-Dial setup .....	17-6
The Address Book .....	17-7
Setting up a Member in the Address Book.....	17-8
Setting up a Group for Broadcasting .....	17-9
Editing Member information.....	17-10
Deleting a Member or Group .....	17-10
Exporting the Address Book.....	17-10
Importing to the Address Book.....	17-12
Setting up a Cover Page.....	17-13
You can enter information in each field .....	17-14
Sending a file as a PC-FAX using the	
Facsimile style .....	17-15
Redial .....	17-16
Sending a file as a PC-FAX using the Simple style	17-16
Setting up PC-FAX receiving	
(Windows® 95/98/98SE/Me/2000 Professional and	
Windows NT® WS 4.0 only).....	17-18
Running PC-FAX Receiving .....	17-18
Setting up your PC.....	17-18
Viewing new PC-FAX messages .....	17-19
Receiving a fax into the PC	
(Windows® XP only).....	17-20
How to receive a fax automatically .....	17-20
How to view the received faxes .....	17-25

<b>Using your MFC with a Macintosh® .....</b>	<b>18-1</b>
Setting up your USB-equipped Apple® Macintosh® .....	18-1
Using the Brother printer driver with your Apple® Macintosh®	
(Mac OS 8.6-9.2) .....	18-2
Using the Brother Printer Driver with Your Apple® Macintosh®	
(Mac OS X) .....	18-5

Choosing page setup options .....	18-5
Specific settings .....	18-6
Using the PS driver with your Apple® Macintosh® .....	18-8
For Mac OS 8.6 to 9.2 users .....	18-8
For Mac OS X users .....	18-12
Sending a fax from your Macintosh® application .....	18-15
For Mac OS 8.6-9.2 users .....	18-15
For Mac OS X users .....	18-17
Drag a vCard from the Mac® OS X Address Book application .....	18-19
Using the Brother TWAIN scanner driver with your Macintosh® .....	18-21
Accessing the scanner .....	18-21
Scanning an image into your Macintosh® .....	18-22
Scanning a whole page .....	18-22
PreScanning an image .....	18-23
Settings in the Scanner window .....	18-24
Image .....	18-24
Scanning Area.....	18-26
Business Card Size.....	18-26
Adjusting the Image.....	18-27
Using Presto!® PageManager® .....	18-28
Highlights.....	18-28
System requirements.....	18-29
Technical Support.....	18-29
MFC Remote Setup (Mac OS X) .....	18-30

## 19

<b>Network Scanning (Windows® 98/98SE/Me/2000 Professional and XP only) .....</b>	<b>19-1</b>
Registering your PC with the MFC .....	19-1
Using the Scan key .....	19-4
Scan to E-mail (PC).....	19-4
Scan to E-mail (E-mail server).....	19-5
Scan to Image .....	19-6
Scan to OCR .....	19-7
Scan to File.....	19-8

## 20

<b>Brother Network PC-FAX software .....</b>	<b>20-1</b>
Enable Network PC-FAX .....	20-1
Sending setup .....	20-1
Extra options in Address Book .....	20-3
Installing Network PC-FAX .....	20-4
Windows® 95/98/98SE and Me users .....	20-4

Using the Brother Network PC-FAX software.....	20-5
Quick Tips:.....	20-5
Sending a Network PC-FAX from your Macintosh®	
application .....	20-6
For Mac OS 8.6-9.2 users .....	20-6
For Mac OS X users.....	20-6

## 21

<b>Important information .....</b>	<b>21-1</b>
Standard telephone and FCC Notices	
These notices are in effect on models sold and used	
only in the United States.....	21-1
Federal Communications Commission (FCC) Declaration	
of Conformity (USA only).....	21-3
Important .....	21-4
Important – about the interface cable.....	21-4
Industry Canada Compliance Statement	
(Canada only).....	21-4
International ENERGY STAR® Compliance	
Statement .....	21-4
Laser safety.....	21-4
FDA regulations.....	21-5
Important safety instructions.....	21-6
Trademarks.....	21-8

## 22

<b>Troubleshooting and routine maintenance .....</b>	<b>22-1</b>
Troubleshooting .....	22-1
Error messages.....	22-1
Original jams .....	22-4
Original is jammed in the top of the ADF unit.....	22-4
Original is jammed inside the ADF unit. ....	22-5
Paper jams.....	22-6
Paper is jammed in the duplex tray (For MFC-8820D	
and MFC-8820DN) .....	22-11
If you are having difficulty with your MFC.....	22-13
Improving the print quality.....	22-18
Packing and shipping the MFC.....	22-22
Routine maintenance.....	22-25
Cleaning the scanner.....	22-25
Cleaning the printer .....	22-26
Cleaning the drum unit.....	22-27
Replacing the toner cartridge.....	22-28

How to replace the toner cartridge .....	22-29
Replacing the drum unit.....	22-34
Checking the drum life.....	22-37
Page Counter .....	22-37

## 23

<b>Optional accessories .....</b>	<b>23-1</b>
Memory board .....	23-1
Installing the optional memory board .....	23-2
Network (LAN) board .....	23-4
Before starting installation .....	23-5
Step 1: Hardware installation.....	23-5
Step 2: Connecting the NC-9100h to an Unshielded Twisted Pair 10BASE-T or 100BASE-TX Ethernet Network.....	23-8
LED .....	23-8
TEST SWITCH.....	23-9
Paper Tray #2.....	23-9

## G

<b>Glossary .....</b>	<b>G-1</b>
-----------------------	------------

## S

<b>Specifications .....</b>	<b>S-1</b>
Product description .....	S-1
General .....	S-1
Print media .....	S-2
Copy .....	S-2
Fax.....	S-3
Scanner .....	S-4
Printer .....	S-5
Interfaces.....	S-5
Computer requirements.....	S-6
Consumable items.....	S-7
Network (LAN) board (NC-9100h) .....	S-8

<b>Index .....</b>	<b>I-1</b>
--------------------	------------

<b>Remote Retrieval Access card .....</b>	<b>R-1</b>
---	------------

# 1

# Introduction

## Using this Guide

Thank you for buying a Brother Multi-Function Center (MFC). Your MFC-8420, MFC-8820D or MFC-8820DN is simple to use, with LCD screen instructions to guide you through programming it. You can make the most of your MFC by taking a few minutes to read this Guide.

### Finding information

All the chapter headings and subheadings are listed in the Table of Contents. You will be able to find information about a specific feature or operation by checking the Index at the back of this Guide.

### Symbols used in this Guide

Throughout this Guide you'll see special symbols alerting you to important warnings, notes and actions. To make things clearer and to help you press the correct keys, we used special fonts and added some of the messages that will appear in the LCD.

**Bold** Bold typeface identifies specific keys on the MFC control panel.

*Italics* Italicized typeface emphasizes an important point or refers you to a related topic.

Courier Courier New typeface identifies the messages on the LCD of the MFC.

 Warnings inform you what to do to avoid possible personal injury.

 Cautions specify procedures you must follow or avoid to prevent possible damage to the machine.

 Notes tell you how you should respond to a situation that may arise or give tips about how the current operation works with other features.

 Improper Setup alerts you to devices and operations that are not compatible with the MFC.

## **Fax Test Sheet and Product Registration (USA only)**

---

After setting your Station ID, please fill in the Test Sheet included with your MFC and fax it to Brother's Automated Fax Response System as your first transmission. This will check that your MFC is working properly.

To get a response, you must have set up your Station ID.  
(See *Setting the Station ID* on page 4-2.)

**In USA Only:** 1-877-268-9575

When your Test Sheet is received, a Confirmation Sheet and Product Registration form will be sent back to your MFC. Please fill in the form and return it to complete your registration.

## **On-Line Registration (USA and Canada)**

---

- 1** Insert the MFL-Pro Suite CD-ROM into your CD-ROM drive.
- 2** Click **Online Registration** to register your product.



# MFC part names and operations

## ■ Front view

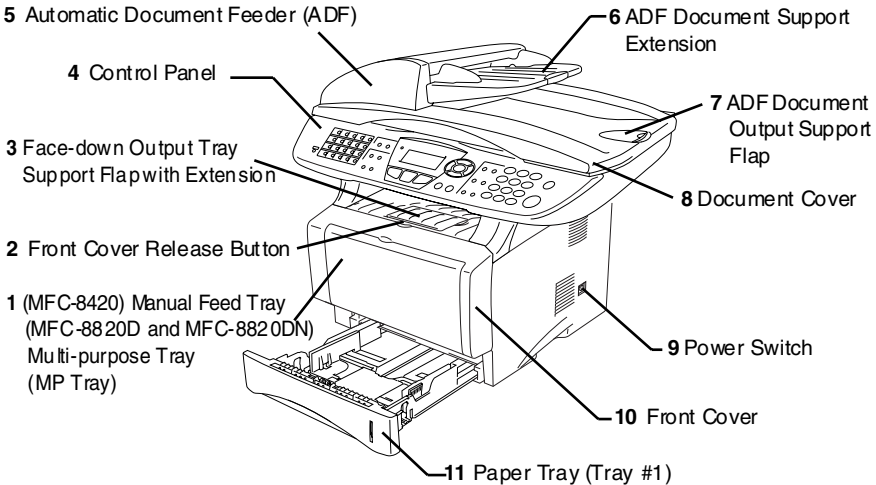

Nb.	Name	Description
1	(MFC-8420) Manual Feed Tray (MFC-8820D and MFC-8820DN) Multi-purpose Tray (MP Tray)	Load paper here.
2	Front Cover Release Button	Press it to open the front cover.
3	Face-down Output Tray Support Flap with Extension (Support Flap)	Unfold it to prevent the printed paper from sliding off the MFC.
4	Control Panel	Use the keys and display to control the MFC.
5	Automatic Document Feeder (ADF)	Use the ADF unit for multiple page originals.
6	ADF Document Support Extension	Place the original here to use the ADF unit.
7	ADF Document Output Support Flap	Unfold to prevent the scanned pages from sliding off the MFC.
8	Document Cover	Open to place the original on the scanner glass.
9	Power Switch	Switch it on or off.
10	Front Cover	Open to install a toner cartridge or drum unit.
11	Paper Tray (Tray #1)	Load paper here.

## ■ Back view

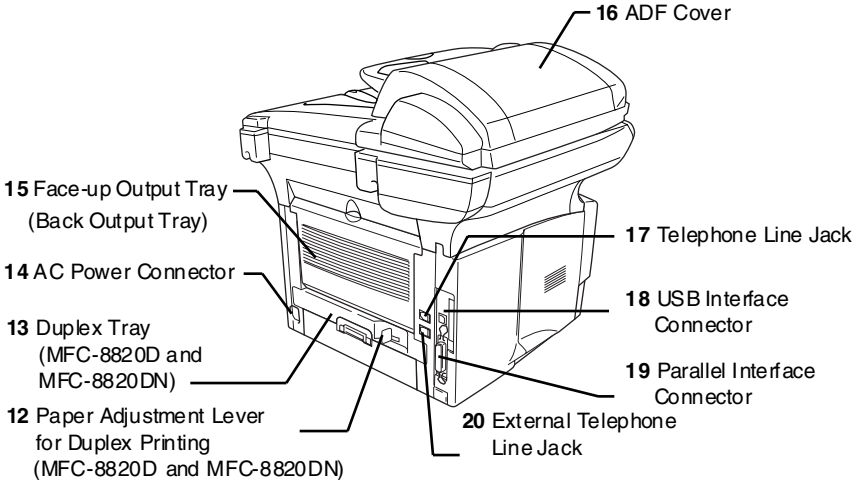

No	Name	Description
12	Paper Adjustment Lever for Duplex Printing (MFC-8820D and MFC-8820DN)	Use to match your paper size for duplex printing.
13	Duplex Tray (MFC-8820D and MFC-8820DN)	Slide out to remove paper jammed inside the MFC.
14	AC Power Connector	Connect the AC Power Connector here.
15	Face-up Output Tray (Back Output Tray)	Open it when thicker paper is placed in the MP tray or Manual feed tray.
16	ADF Cover	Open to remove paper jammed inside the ADF unit.
17	Telephone Line Jack	Plug the line cord supplied with the MFC into here.
18	USB Interface Connector	Connect the USB Cable here.
19	Parallel Interface Connector	Connect the Parallel Cable here.
20	External Telephone Line Jack	Plug in the modular plug on the external telephone line here.

■ Inside view (Document cover open)

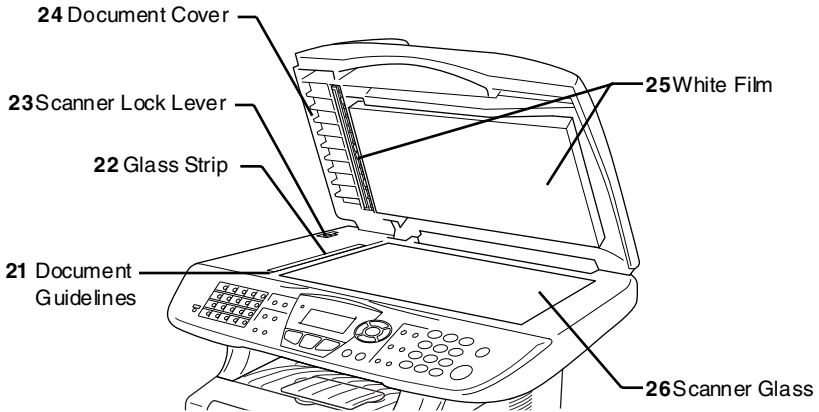

No.	Name	Description
21	Document Guidelines	Use to center the original on the scanner glass.
22	Glass Strip	This is used to scan the original when using the ADF.
23	Scanner Lock Lever	Use to lock/unlock the scanner when relocating the MFC.
24	Document Cover	Open to place the original on the scanner glass.
25	White Film	Clean it for good quality copying and scanning.
26	Scanner Glass	Place the original to be scanned here.

# Control panel overview

MFC-8420, MFC-8820D and MFC-8820DN have similar control panel keys.

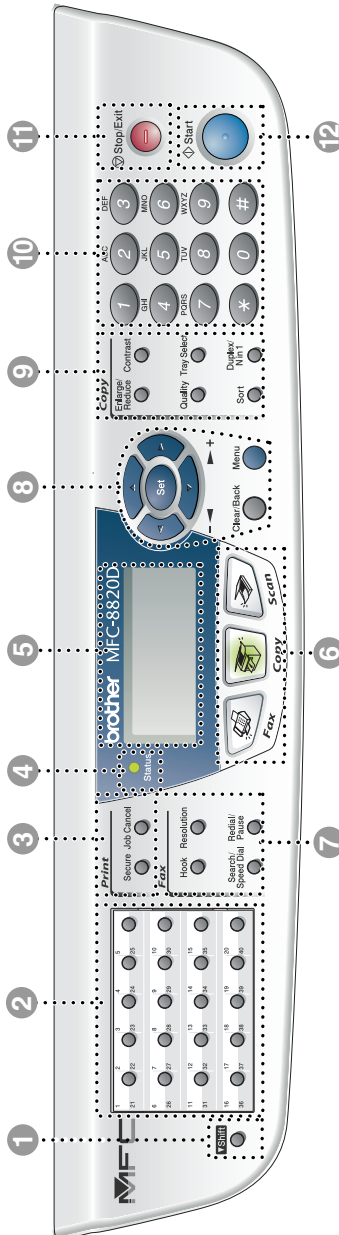

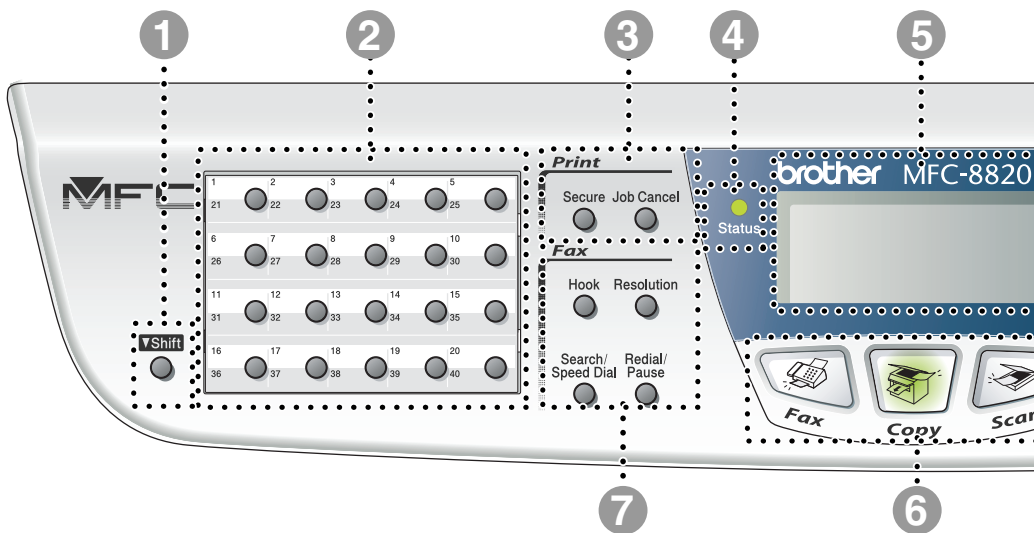

**1 Shift**

To access memory locations 21 through 40 in the One-Touch keys hold down the Shift key.

**2 One-Touch keys**

These 20 keys give you instant access to 40 previously stored dial numbers.

**3 Print keys:**

**Secure**

Lets you print out data saved in memory by entering your four-digit password.

**Job cancel**

Clears data from the printer memory.

**4  Status LED**

**(Light-Emitting Diode)**

The LED will flash and change color depending on the MFC status.

**5 5-Line Liquid Crystal Display (LCD)**

Displays messages on the screen to help you to set up and use your MFC.

## 6 Mode keys:



### **Fax**

Lets you access Fax mode.



### **Copy**

Lets you access Copy mode.



### **Scan**

Lets you access Scan mode.

## 7 Fax and telephone keys:

### **Hook**

Press before dialing if you want to make sure a fax machine will answer, and then press **Start**.

### **Resolution**

Sets the resolution when you send a fax.

### **Search/Speed Dial**

Lets you look up numbers that are stored in the dialing memory. It also lets you dial stored numbers by pressing **#** and a three-digit number.

### **Redial/Pause**

Redials the last number you called. It also inserts a pause in auto dial numbers.

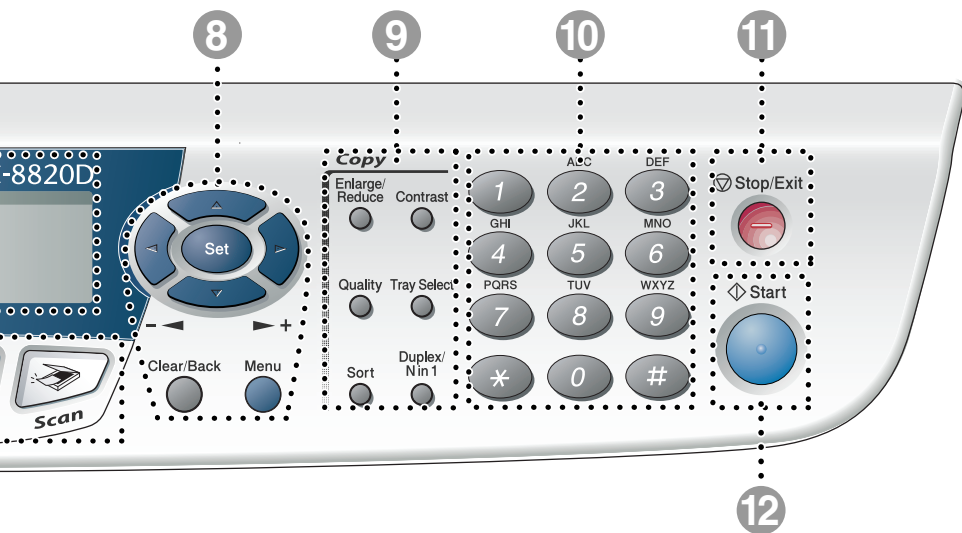

## 8 Navigation keys:

### Menu

Lets you access the Menu to program.

### Set

Lets you store your settings in the MFC.

### Clear/Back

Deletes entered data or lets you exit the menu by pressing repeatedly.



or

Press to scroll forward or backward to a menu selection.

When using the speaker or ring, you can press these keys to adjust the volume in fax mode.



Press to scroll through the menus and options.

Also, you can use these keys to do a numerical search for the names of stored numbers in fax mode.

**9 Copy keys**  
**(Temporary settings):**

**Enlarge/Reduce**

Lets you reduce or enlarge copies depending upon the ratio you select.

**Contrast**

Lets you make a copy that is lighter or darker than the original.

**Quality**

Lets you select the copy quality for your type of original.

**Tray Select**

You can select which tray you would like to use for the next copy.

**Sort**

Lets you sort multiple copies using the ADF.

**N in 1** (For MFC-8420)

N in 1 lets you copy 2 or 4 pages onto one page.

**Duplex/N in 1** (For MFC-8820D and MFC-8820DN)

You can choose Duplex to copy on both sides of the paper or N in 1 to copy 2 or 4 pages onto one page.

**10 Dial Pad**

Use these keys to dial telephone and fax numbers and as a keyboard for entering information into the MFC.

The # key lets you temporarily switch the dialing mode during a telephone call from Pulse to Tone.

**11  Stop/Exit**

Stops a fax, copy and scan operation or exits from the menu.

**12  Start**

Lets you start sending faxes, making copies or scanning.















# Status LED indications



The **Status** LED (Light Emitting Diode) will flash and change color depending on the MFC status.



The LED indications shown in the table below are used in the illustrations in this chapter.

LED				LED status
				LED is off.
	 Green	 Yellow	 Red	LED is on.
	 Green	 Yellow	 Red	LED is blinking.

LED	MFC status	Description
	Sleep Mode	The power switch is off or the MFC is in Sleep mode.
 Green	Warming Up	The MFC is warming up for printing.
 Green	Ready	The MFC is ready to print.
 Yellow	Receiving Data	The MFC is either receiving data from the computer, processing data in memory or printing data.
 Yellow	Data Remaining in Memory	Print data remains in the MFC memory.

LED	MFC status	Description
 Red	Service error	Follow the steps below. 1. Turn off the power switch. 2. Wait a few seconds, and then turn it back on and try to print again.  If you cannot clear the error and see the same service call indication after turning the MFC back on, please call Brother Customer Service at: 1-800-284-4329 (in USA), 1-877-BROTHER (in Canada) or (514) 685-6464 (in Montreal).
 Red	Cover open	The cover is open. Close the cover. (See <i>Error messages</i> on page 22-1.)
	Toner empty	Replace the toner cartridge with a new one. (See <i>Replacing the toner cartridge</i> on page 22-28.)
	Paper error	Put paper in the tray or clear the paper jam. Check the LCD message. (See <i>Troubleshooting</i> on page 22-1.)
	Scan lock	Check that the scanner lock lever is released. (See <i>Scanner Lock Lever</i> on page 1-5.)
	Others	Check the LCD message. (See <i>Troubleshooting</i> on page 22-1.)
	Out of memory	Memory is full. (See <i>Error messages</i> on page 22-1.)



When the power switch is off or the MFC is in Sleep mode, the LED is off.

# About fax machines

## Custom features

---

### **Do you have Voice Mail on the phone line?**

If you have Voice Mail on the phone line where you will install your new MFC, *there is a strong possibility that Voice Mail and the MFC may conflict with each other while receiving incoming calls.*

### **Why should there be problems?**

Since both the MFC and Voice Mail will pick up the call, after the number of rings you have set, each of them has the ability to keep the other from receiving calls.

For example, if your Voice Mail is set to answer after two rings and your MFC is set to answer after four, your Voice Mail will stop your MFC from receiving faxes.

If you set Voice Mail and the Brother MFC to answer after the same number of rings, there is no way of knowing which one will answer first. It is important to remember that neither Voice Mail nor the MFC can pass the call back to the other after the call has been answered.

### **How can you avoid possible problems?**

A very good way to avoid problems like the one mentioned, *is to get a second phone number on your present phone line.*

Many people with Voice Mail choose an alternative service, which is called "Distinctive Ring", and they are very satisfied with it. (See *Distinctive Ring* on page 5-11.)

Another way to avoid possible problems is to replace your Voice Mail with an answering machine. Your Brother MFC is designed to work with an answering machine or TAD (telephone answering device).

(See *Connecting an external telephone answering device (TAD)* on page 1-16.)

## Fax tones and handshake

---

When someone is sending a fax, the MFC sends fax calling tones (CNG tones). These are quiet, intermittent beeps every 4-seconds. You'll hear them after you dial and press **Start** and they will continue for about 60 seconds after dialing. During that time, the sending machine must begin the "handshake", or connection, with the receiving machine.

Each time you use automatic procedures to send a fax, you are sending CNG tones over the phone line. You'll soon learn to listen for these quiet beeps each time you answer a phone on your fax line, so you will know if you are receiving a fax message.

The receiving fax responds with fax receiving tones, which are loud, chirping sounds. A receiving fax chirps for about 40 seconds over the phone line, and the LCD shows *Receiving*.

If your MFC is set to the *Fax Only* mode, it will answer every call automatically with fax receiving tones. If the other person hangs up, your MFC will continue to send the "chirps" for about 40 seconds, and the LCD continues to show *Receiving*. To cancel receiving, press **Stop/Exit**.

The fax 'handshake' is the time in which the sending machine's CNG tones and the receiving machines "chirps" overlap. This must be for at least 2 to 4 seconds, so both machines can understand how each is sending and receiving the fax. The handshake cannot begin until the call is answered, and the CNG tones only last for about 60 seconds after the number is dialed. So it is important for the receiving machine to answer the call in as few rings as possible.



When you have an external Telephone Answering Device (TAD) on your fax line, your TAD will decide the number of rings before the call is answered.

Pay special attention to the directions for connecting a TAD in this chapter. (See *Connecting an external telephone answering device (TAD)* on page 1-16.)

## ECM (Error Correction Mode)

---

The Error Correction Mode (ECM) is a way for the MFC to check a fax transmission while it is in progress. If the MFC detects errors during fax transmission, it resends the pages of the fax that had an error. ECM transmissions are only possible between fax machines that both have this feature. If they do, you may send and receive fax messages that are continuously being checked by the MFC.

Your MFC must have enough memory for this feature to work.

## Connecting the MFC

### Connecting an external telephone

---

Although your MFC does not have a handset, you can connect a separate telephone (or telephone answering device) directly to your MFC as shown in the diagram below.

Connect the modular plug on the telephone's line cord to the jack labeled EXT. in the back of the MFC.

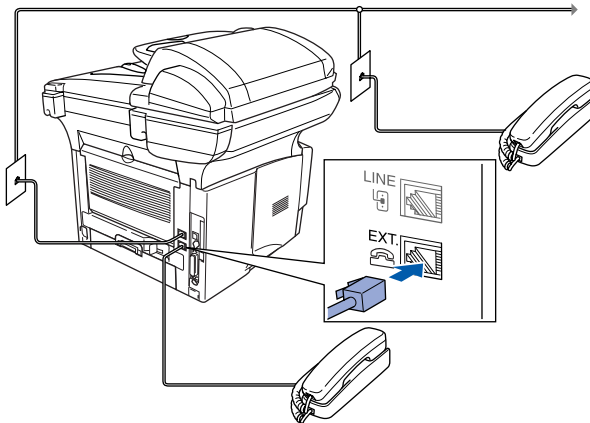

Whenever this phone (or TAD) is in use, the LCD shows Telephone.

# Connecting an external telephone answering device (TAD)

---

## Sequence

You may choose to connect an answering device. However, when you have an **external** TAD on the same telephone line as the MFC, the TAD answers all calls and the MFC “listens” for fax calling (CNG) tones. If it hears them, the MFC takes over the call and receives the fax. If it doesn’t hear CNG tones, the MFC lets the TAD continue playing your outgoing message so your caller can leave you a voice message.

The TAD must answer within four rings (the recommended setting is two rings). The MFC cannot hear CNG tones until the TAD has answered the call, and with four rings there are only 8 to 10 seconds of CNG tones left for the fax “handshake”. Make sure you carefully follow the instructions in this guide for recording your outgoing message. We do not recommend using the toll saver feature on your external answering machine if it exceeds five rings.



If you do not receive all your faxes, reduce the Ring Delay setting on your external TAD.



*If You Subscribe to your Telephone Company’s Distinctive Ring Service:*

You may connect an external TAD to a separate wall jack only if you subscribe to your telephone company’s Distinctive Ring service, have registered the distinctive ring pattern on your MFC, and use that number as a fax number. The recommended setting is four rings on the external TAD when you have the telephone company’s Distinctive Ring Service.



*If You Do Not Subscribe to Distinctive Ring Service:*

You must plug your TAD into the EXT. jack of your MFC. If your TAD is plugged into a wall jack, both your MFC and the TAD will try to control the phone line. (See illustration on the next page.)

⊘ **Do not connect a TAD elsewhere on the same phone line**  
(unless you have the Distinctive Ring service).

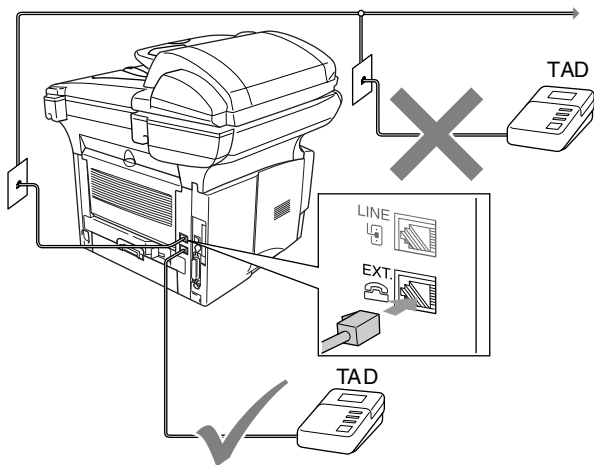

## Connections

The external TAD must be plugged into the back of the MFC, into the jack labeled EXT. Your MFC cannot work properly if you plug the TAD into a wall jack (unless you are using Distinctive Ring).

- 1** Plug the telephone line cord from the wall jack into the back of the MFC, in the jack labeled LINE.
- 2** Plug the telephone line cord from your external TAD into the back of the MFC, in the jack labeled EXT. (Make sure this cord is connected to the TAD at the TAD's telephone *line* jack, and not its telephone jack.)
- 3** Set your external TAD to four rings or less. (The MFC's Ring Delay setting does not apply.)
- 4** Record the outgoing message on your external TAD.
- 5** Set the TAD to answer calls.
- 6** Set the Receive Mode to `External TAD`.  
(See *Choosing the Receive Mode* on page 5-1.)

## Recording outgoing message (OGM) on an external TAD

Timing is important in recording this message. The message sets up the ways to handle both manual and automatic fax reception.

- 1** Record 5 seconds of silence at the beginning of your message. (This allows your MFC time to listen for the fax CNG tones of automatic transmissions before they stop.)
- 2** Limit your speaking to 20 seconds.
- 3** End your 20-second message by giving your Fax Receive Code for people sending manual faxes. For example:  
*"After the beep, leave a message or send a fax by pressing \* 51 and Start."*



We recommend beginning your OGM with an initial 5-second silence because the MFC cannot hear fax tones over a resonant or loud voice. You may try omitting this pause, but if your MFC has trouble receiving, then you must rerecord the OGM to include it.



## Special line considerations

---

### Roll-over phone lines

A roll-over phone system is a group of two or more separate telephone lines that pass incoming calls to each other if they are busy. The calls are usually passed down or “rolled over” to the next available phone line in a preset order.

Your MFC can work in a roll-over system as long as it is the last number in the sequence, so the call cannot roll away. Do not put the MFC on any of the other numbers; when the other lines are busy and a second fax call is received, the fax call would be transferred to a line that does not have a fax machine. **Your MFC will work best on a dedicated line.**

### Two-line phone system

A two-line phone system is nothing more than two separate phone numbers on the same wall outlet. The two phone numbers can be on separate jacks (RJ11) or combined into one jack (RJ14). Your MFC must be plugged into an RJ11 jack. RJ11 and RJ14 jacks may be equal in size and appearance and both may contain four wires (black, red, green, yellow). To test the type of jack, plug in a two-line phone and see if it can access both lines. If it can, you must separate the line for your MFC. (See *Easy Receive* on page 5-4.)

## Converting telephone wall outlets

There are three ways to convert to an RJ11 jack. The first two ways may require assistance from the telephone company. You can change the wall outlets from one RJ14 jack to two RJ11 jacks. Or, you can have an RJ11 wall outlet installed and slave or jump one of the phone numbers to it.

The third way is the easiest: Buy a triplex adapter. You can plug a triplex adapter into an RJ14 outlet. It separates the wires into two separate RJ11 jacks (Line 1, Line 2) and a third RJ14 jack (Lines 1 and 2). If your MFC is on Line 1, plug the MFC into L1 of the triplex adapter. If your MFC is on Line 2, plug it into L2 of the triplex adapter.

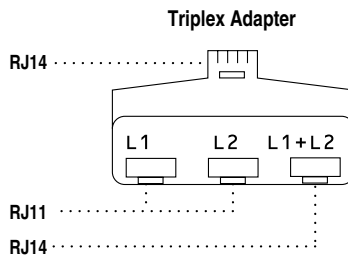

## Installing MFC, external two-line tad and two-line telephone

When you are installing an external two-line telephone answering device (TAD) and a two-line telephone, your MFC must be isolated on one line at both the wall jack and at the TAD. The most common connection is to put the MFC on Line 2, which is explained in the following steps. The back of the two-line TAD must have two telephone jacks: one labeled L1 or L1/L2, and the other labeled L2. You will need at least three telephone line cords, the one that came with your MFC and two for your external two-line TAD. You will need a fourth line cord if you add a two-line telephone.

- 1** Place the two-line TAD and the two-line telephone next to your MFC.
- 2** Plug one end of the telephone line cord for your MFC into the L2 jack of the triplex adapter. Plug the other end into the LINE jack on the back of the MFC.
- 3** Plug one end of the first telephone line cord for your TAD into the L1 jack of the triplex adapter. Plug the other end into the L1 or L1/L2 jack of the two-line TAD.
- 4** Plug one end of the second telephone line cord for your TAD into the L2 jack of the two-line TAD. Plug the other end into the EXT. jack on the left side of the MFC.

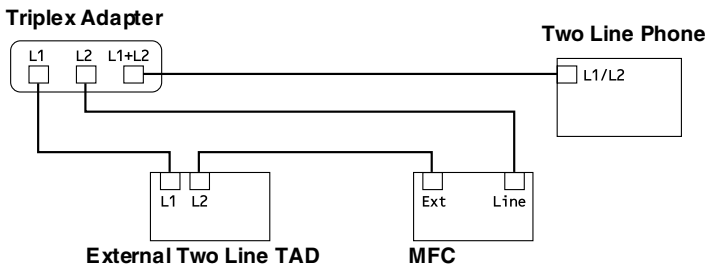

You can keep two-line telephones on other wall outlets as always. There are two ways to add a two-line telephone to the MFC's wall outlet. You can plug the telephone line cord from the two-line telephone into the L1 +L2 jack of the triplex adapter. Or, you can plug the two-line telephone into the TEL jack of the two-line TAD.

## Multi-line connections (PBX)

---

Most offices use a central telephone system. While it is often relatively simple to connect the MFC to a key system or a PBX (Private Branch Exchange), we suggest that you contact the company that installed your telephone system and ask them to connect the MFC for you. It is advisable to have a separate line for the MFC. You can then leave the Receive Mode set to FAX Only to receive faxes any time of the day or night.

If the MFC is to be connected to a multi-line system, ask your installer to connect the unit to the last line on the system. This prevents the unit from being activated each time a telephone call is received.

- ⊘ As with all fax units, this MFC must be connected to a two wire system. If your line has more than two wires, proper connection of the MFC cannot be made.

### If you are installing the MFC to work with a PBX

- 1** It is not guaranteed that the unit will operate correctly under all circumstances with a PBX. Any cases of difficulty should be reported first to the company that handles your PBX.
- 2** If all incoming calls will be answered by a switchboard operator, it is recommended that the Receive Mode be set to *Manual*. All incoming calls should initially be regarded as telephone calls.

## Custom features on your phone line

---

If you have Voice Mail, Call Waiting, Call Waiting/Caller ID, Caller ID, RingMaster, an answering service, an alarm system or other custom feature on one phone line it may create a problem with the operation of your MFC. (See *Custom features* on page 1-13 and *Custom features on a single line* on page 22-14.)

# 2 Paper

## About paper

### Type and size of paper

---

The MFC loads paper from the installed paper tray, manual feed tray, multi-purpose tray or optional lower tray.

Tray Type	Model name
Paper tray (Tray #1)	MFC-8420, MFC-8820D and MFC-8820DN
Manual feed tray	MFC-8420
Multi-purpose tray (MP tray)	MFC-8820D and MFC-8820DN
Optional lower tray (Tray #2)	Option for MFC-8420, MFC-8820D and MFC-8820DN

### Recommended paper

---

Plain Paper: Xerox 4200DP 20 lb  
Hammermill Laser Paper 24 lb

Transparency: 3M CG 3300

Labels: Avery laser label # 5160

- Before you buy a large amount of paper, please test some to make sure that the paper is suitable.
- Use paper that is made for plain-paper copying.
- Use paper that is 75 to 90 g/m<sup>2</sup> (20 to 24 lb).
- Use neutral paper. Do not use acidic or alkaline paper.
- Use long-grain paper.
- Use paper with a moisture content of approximately 5%.

### **Caution**

Do not use ink jet paper. It may cause a paper jam and damage your MFC.



The output quality depends on the paper type and paper brand. Visit us at <http://solutions.brother.com> and check the latest recommendations for paper that can be used with the MFC-8420, MFC-8820D and MFC-8820DN.

## Choosing acceptable paper

We recommend that you test paper (especially special sizes and types of paper) on the MFC before purchasing large quantities.

- Avoid feeding label sheets that are partly used or your MFC will be damaged.
- Avoid using coated paper, such as vinyl coated paper.
- Avoid using preprinted or highly textured paper, or paper with an embossed letterhead.

For optimum printing, use a recommended type of paper, especially for plain paper and transparencies. For more information on paper specifications, call your nearest authorized sales representative or the place where you purchased your MFC.

- Use label or transparencies that are designed for use in *laser* printers.
- For the best print quality, we recommend using long-grained paper.
- If you are using special paper and the paper has problems feeding from the paper tray, try again using the manual feed tray or multi-purpose tray.
- You can use recycled paper in this MFC.

## Paper capacity of the paper trays

	Paper size	Number of sheets
<b>Multi-purpose tray (MP tray) (MFC-8820D and MFC-8820DN)</b>	Width: 69.8 to 220 mm (2.75 to 8.66 in.) Height: 116 to 406.4 mm (4.57 to 16.0 in.)	50 sheets (80 g/m <sup>2</sup> or 20 lb)
<b>Manual feed tray (MFC-8420)</b>	Width: 69.8 to 220 mm (2.75 to 8.66 in.) Height: 116 to 406.4 mm (4.57 to 16.0 in.)	Single sheet
<b>Paper tray (Tray #1)</b>	A4, Letter, Legal, B5 (ISO), B5 (JIS), Executive, A5, A6, B6 (ISO)	250 sheets (80 g/m <sup>2</sup> or 20 lb)
<b>Optional lower tray (Tray #2)</b>	A4, Letter, Legal, B5 (ISO), B5 (JIS), Executive, A5, B6 (ISO)	250 sheets (80 g/m <sup>2</sup> or 20 lb)
<b>Duplex printing (MFC-8820D and MFC-8820DN)</b>	A4, Letter, Legal	—

## Paper specifications for each paper tray

Model		MFC-8420	MFC-8820D and MFC-8820DN
<b>Paper types</b>	Multi-purpose tray	N/A	Plain paper, Bond paper, Recycled paper, Envelope <sup>*1</sup> , Labels <sup>*2</sup> , and Transparency <sup>*2</sup>
	Manual feed tray	Plain paper, Bond paper, Recycled paper, Envelope, Labels, and Transparency	N/A
	Paper tray	Plain paper, Recycled paper, and Transparency <sup>*2</sup>	
	Optional Lower tray	Plain paper, Recycled paper, and Transparency <sup>*2</sup>	
<b>Paper weights</b>	Multi-purpose tray	N/A	60 to 161 g/m <sup>2</sup> (16 to 43 lb)
	Manual feed tray	60 to 161 g/m <sup>2</sup> (16 to 43 lb)	N/A
	Paper tray	60 to 105 g/m <sup>2</sup> (16 to 28 lb)	
	Optional Lower tray	60 to 105 g/m <sup>2</sup> (16 to 28 lb)	
<b>Paper sizes</b>	Multi-purpose tray	N/A	Width: 69.8 to 220 mm (2.75 to 8.66 in.) Height: 116 to 406.4 mm (4.57 to 16.0 in.)
	Manual feed tray	Width: 69.8 to 220 mm (2.75 to 8.66 in.) Height: 116 to 406.4 mm (4.57 to 16.0 in.)	N/A
	Paper tray	A4, Letter, Legal, B5 (ISO), B5 (JIS), Executive, A5, A6, B6 (ISO)	
	Optional Lower Tray	A4, Letter, Legal, B5 (ISO), B5 (JIS), Executive, A5, B6 (ISO)	

\*1 Up to 3 envelopes

\*2 Up to 10 sheets



When printing transparencies, remove each one from the face-down output tray after it exits the MFC.



# How to load paper

## To load paper or other media in the paper tray

- 1 Pull the paper tray completely out of the MFC.

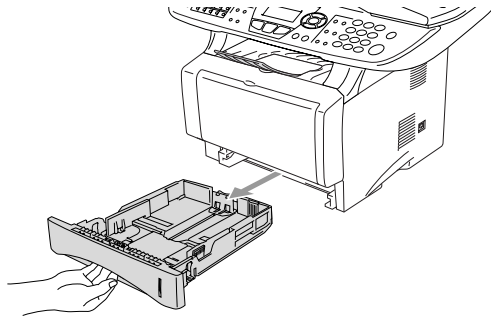

- 2 While pressing the paper guide release lever, slide the adjusters to fit the paper size.

Check that the guides are firmly in the slots.

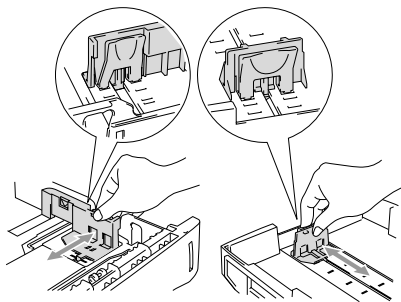

-  For Legal size paper, press the universal guide release button and pull out the back of the paper tray.

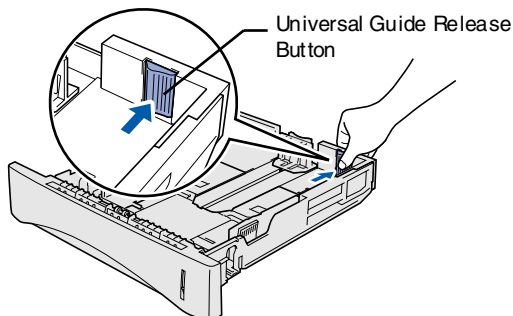

**3** Fan the stack of paper well to avoid paper jams and misfeeds.

**4** Put paper in the paper tray.

Check that the paper is flat in the tray, below the maximum paper mark, and that the paper guide is flush against the paper stack.

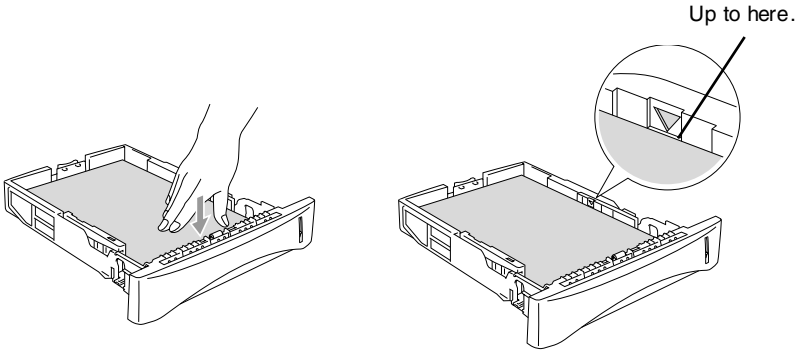

**5** Put the paper tray firmly back in the MFC and unfold the support flap before you use the MFC.

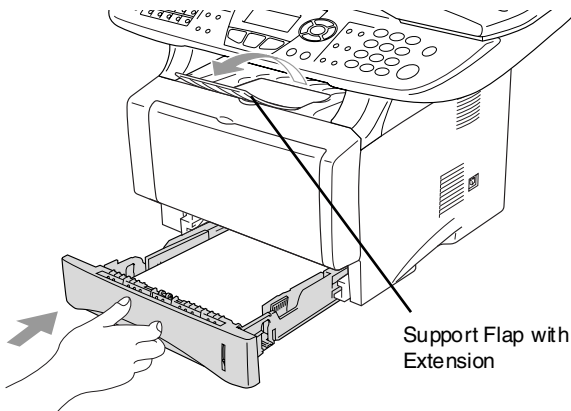

When you put paper in the paper tray, please remember the following:

- The side to be printed on must be face down.
- Put the leading edge (top of the paper) in first and push it gently into the tray.
- To copy or receive faxes on Legal size paper, unfold the support flap extension, too.

## To load paper or other media in the manual feed tray (For MFC-8420)

 When printing envelopes and labels you should only use the manual feed tray.

- 1** Open the manual feed tray. Slide the paper guides to fit the paper size.

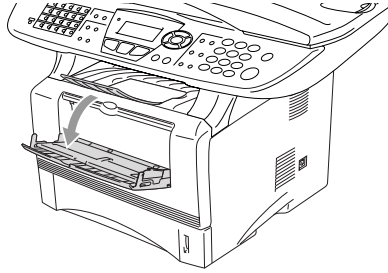

- 2** Using both hands put paper in the manual feed tray until the front edge of the paper touches the paper feed roller. Hold the paper in this position until the MFC automatically feeds the paper in for a short distance, and then let go of the paper.

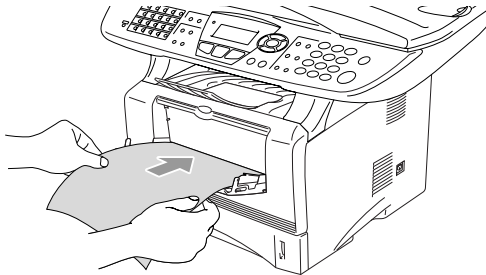

 When you put paper in the manual feed tray, please remember the following:

- The side to be printed on must be face up.
- Put the leading edge (top of the paper) in first and push it gently into the tray.
- Make sure that the paper is straight and in the proper position on the manual feed tray. If it is not, the paper may not be fed properly, resulting in a skewed printout or a paper jam.
- Do not put more than one sheet of paper or envelope in the manual feed tray at any one time, or it may cause a jam.

## To load paper or other media in the multi-purpose tray (MP tray) (For MFC-8820D and MFC-8820DN)

 When printing envelopes and labels you should only use the multi-purpose tray.

**1** Open the MP tray and lower it gently.

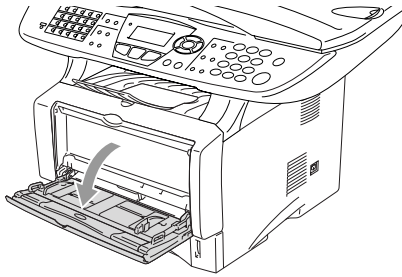

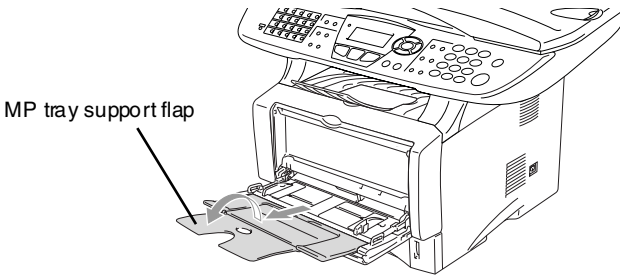

**2** Pull out and unfold the MP tray support flap.

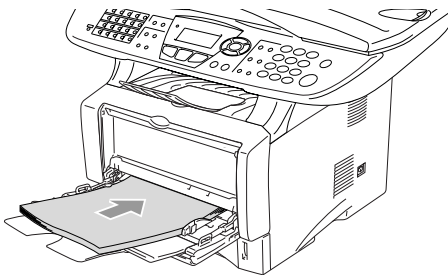

**3** When loading paper in the MP tray, make sure it touches the back of the tray.



 Make sure that the paper is straight and in the proper position on the MP tray. If it is not, the paper may not be fed properly, resulting in a skewed printout or a paper jam.

 You can place up to 3 envelopes or up to 50 sheets of 80 g/m<sup>2</sup> or 20 lb paper in the MP tray.

**4** While pressing the paper-guide release lever, slide the paper guide to fit the paper size.

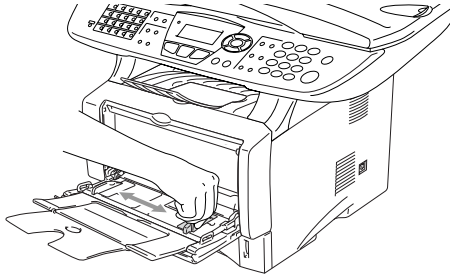

 When you put paper in the MP tray, please remember the following:

- The side to be printed on must be face up.
- During printing, the inside tray rises to feed paper into the MFC.
- Put the leading edge (top of the paper) in first and push it gently into the tray.

## To use Automatic Duplexing for fax, copy and print operations (For MFC-8820D and MFC-8820DN)

---

If you want to print on both sides of the paper using the Duplex feature for fax, copy or print, you will need to set the Paper Adjustment Lever to the size of paper you are using.

This feature is available for A4, Letter or Legal size paper. (See *Setting Duplex printing for Fax mode (For MFC-8820D and MFC-8820DN)* on page 5-10, *Duplex/N in 1* on page 10-11 and *Two-sided printing (Duplex Printing)* on page 11-3.)

- 1** Load paper in the Paper Tray or Multi-purpose Tray.
- 2** Set the Paper Adjustment Lever for Duplex Printing, in the back of the MFC, to match your paper size.

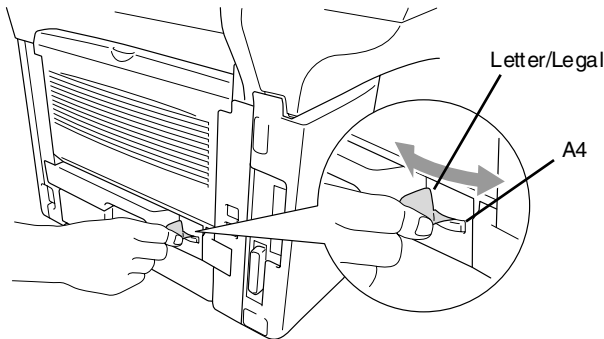

- 3** Your MFC is now ready to print two-sided pages.

# 3

## On-screen programming

### User-friendly programming

Your MFC is designed to be easy to use with LCD on-screen programming using the navigation keys. User-friendly programming helps you take full advantage of all the menu selections your MFC has to offer.

Since your programming is done on the LCD, we have created step-by-step on-screen instructions to help you program your MFC. All you need to do is follow the instructions as they guide you through the menu selections and programming options.

### Menu table

---

You can probably program your MFC without the User's Guide. But to help you understand the menu selections and options that are found in the MFC programs, use the Menu table on page 3-4.



You can program your MFC by pressing **Menu** followed by the menu numbers.

For example to set `Fax Resolution` to `Fine`:

Press **Menu**, **2**, **2**, **2** and  or  to select `Fine`.

Press **Set**.

### Memory Storage

---

If there is a power failure, you will not lose your menu settings because they are stored permanently. Temporary settings (such as Contrast, Overseas Mode, and so on) will be lost. You may also have to reset the date and time.

# Navigation keys

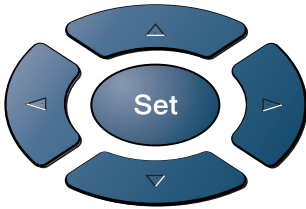

Clear/Back



Menu



Menu



\* Access the menu



\* Go to the next menu level

\* Accept an option

Clear/Back



\* Exit the menu by pressing repeatedly

\* Go back to the previous menu level



\* Scroll through the current menu level



\* Go back to the previous menu level



\* Go forward to the next menu level

Stop/Exit



\* Exit the menu

You can access the menu mode by pressing **Menu**.

When you enter the menu, the LCD scrolls.

Press **1** for General Setup menu

—OR—

Press **2** for Fax menu

—OR—

Press **3** for Copy menu

—OR—

Press **4** for Printer menu

—OR—

Press **5** for Print Reports menu

—OR—

Press **6** for LAN menu

(Only for MFC-8820DN or if the optional LAN board (NC-9100h) is installed.)



—OR—

Press **0** for Initial Setup menu

—OR—

1.General Setup
2.Fax
3.Copy
4.Printer
Select ▲▼ & Set



4.Printer
5.Print Reports
6.LAN
0.Initial Setup
Select ▲▼ & Set

You can scroll more quickly through each menu level by pressing the arrow for the direction you want:  or .



Then set an option by pressing **Set** when that option appears on the LCD.

The LCD will then show the next menu level.

Press  or  to scroll to your next menu selection.

Press **Set**.

When you finish setting an option, the LCD shows *Accepted*.



Use  to scroll backward if you passed your choices or want to save keystrokes.

The current setting is always the option with “\*”.

To access the menu, press  **Menu**.

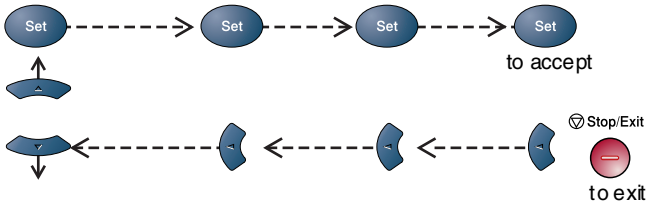

Main Menu	Submenu	Menu Selections	Options	Descriptions	Page
1.General Setup	1.Mode Timer	—	0 Sec 30 Secs 1 Min <b>2 Mins *</b> 5 Mins Off	Sets how long the MFC will stay in Copy or Scan mode before returning to Fax mode.	4-5
	2.Paper Type	1.MP Tray (MFC-8820D and MFC-8820DN)	Thin <b>Plain *</b> Thick Thicker Transparency	Sets the type of paper in the Multi-purpose tray.	4-5
		2.Tray #1 (This menu only appears if you have the optional tray #2)	Thin <b>Plain *</b> Thick Thicker Transparency	Sets the type of paper in paper tray#1.	4-5
		3.Tray #2 (option)	Thin <b>Plain *</b> Thick Thicker Transparency	Sets the type of paper in paper tray#2.	4-5
	3.Paper Size	1.Tray #1 (This menu only appears if you have the optional tray #2)	A4 <b>Letter *</b> Legal Executive A5 A6 B5 B6	Sets the size of paper in paper tray#1.	4-6
		2.Tray #2 (option)	A4 <b>Letter *</b> Legal Executive A5 B5 B6	Sets the size of paper in paper tray#2.	4-6

 The default settings are shown in Bold with \*.

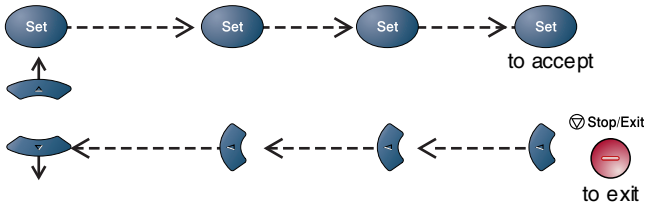

Main Menu	Submenu	Menu Selections	Options	Descriptions	Page
1. General Setup (Continued)	4. Volume	1. Ring	High <b>Med *</b> Low Off	Adjusts the ring volume.	4-8
		2. Beeper	High <b>Med *</b> Low Off	Adjusts the volume level of the beeper.	4-8
		3. Speaker	High <b>Med *</b> Low Off	Adjusts the speaker volume.	4-9
	5. Auto Daylight	—	On <b>Off *</b>	Changes for Daylight Savings Time automatically.	4-9
	6. Ecology	1. Toner Save	On <b>Off *</b>	Increases the life of the toner cartridge.	4-9
		2. Sleep Time	—	Conserves power.	4-10
	7. Tray <b>Use: Copy</b> (For MFC-8420, this menu doesn't appear.) (If you have the optional tray #2, see page 3-15)	—	Tray#1 Only MP Only <b>Auto *</b>	Selects the tray that will be used for Copy mode.	4-11
	8. Tray <b>Use: Fax</b> (This setting only appears if you have the optional tray #2, see page 3-15.)	—	—	Selects the tray that will be used for Fax mode.	4-12
	7. LCD <b>Contrast</b> (MFC-8420)	—	- □ □ □ □ + - □ □ □ □ + - □ □ □ □ + * - □ □ □ □ + - ■ □ □ □ +	Adjusts the contrast of the LCD.	4-12
	8. LCD <b>Contrast</b> (MFC-8820D/8820DN)				
9. LCD <b>Contrast</b> (With optional tray #2)					



The default settings are shown in Bold with \*.

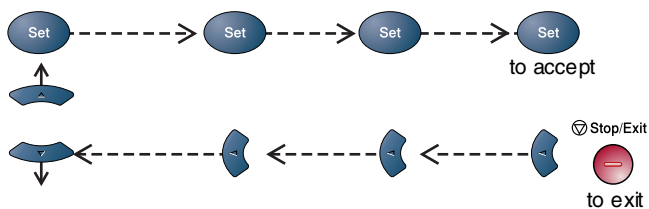

Main Menu	Submenu	Menu Selections	Options	Descriptions	Page
2.Fax	1.Setup Receive (In Fax mode only)	1.Ring Delay	<b>04 *</b> 03 02 01 00	Sets the number of rings before the MFC answers in FAX or FAX/TEL mode.	5-2
		2.F/T Ring Time	70 40 30 <b>20 *</b>	Sets the pseudo/double-ring time in FAX/TEL mode.	5-3
		3.Easy Receive	<b>On *</b> Off	Receives fax messages without pressing the Start key.	5-4
		4.Remote Code	<b>On *</b> (* 51, #51) Off	You can answer all calls at an extension or external phone and use codes to turn the MFC on or off. You can personalize these codes.	5-8
		5.Auto Reduction	<b>On *</b> Off	Reduces the size of incoming faxes.	5-5
		6.Print Density	- □□□□ ■ + - □□□□ □ + - □□□□ □ + * - □□□□ □ + - ■□□□ □ +	Makes printouts darker or lighter.	5-6
		7.Polling RX	<b>On</b> Off *	Sets up your MFC to poll another fax machine.	5-9
		8.Duplex (MFC-8820D and MFC-8820DN)	<b>On</b> Off *	Prints received faxes on both sides of the paper.	5-10
	2.Setup Send (In Fax mode only)	1.Contrast	<b>Auto *</b> Light Dark	Changes the lightness or darkness of faxes you send.	6-6
		2.Fax Resolution	<b>Standard *</b> Fine S. Fine Photo	Sets the default resolution for outgoing faxes.	6-7

 The default settings are shown in Bold with \*.

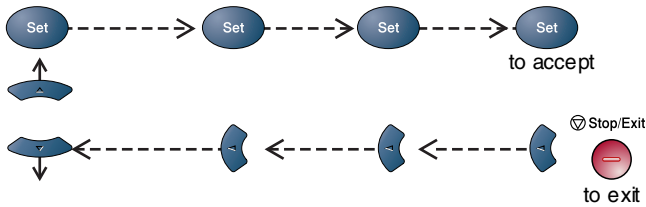

Main Menu	Submenu	Menu Selections	Options	Descriptions	Page
2.Fax (Continued)	2.Setup Send (Continued) (In Fax mode only)	3 Delayed Fax	—	Set the time of day in 24 hour format that the delayed faxes will be sent.	6-19
		4 Batch TX	On Off *	Combines delayed faxes to the same fax number at the same time of day into one transmission.	6-20
		5 Real Time TX	Off * On Next Fax Only	You can send a fax without using the memory.	6-10
		6 Polled TX	On Off *	Sets up the original on your MFC to be retrieved by another fax machine.	6-21
		7 Coverpg Setup	Next Fax Only On Off * Print Sample	Automatically sends a Cover Page you have programmed.	6-12
		8 Coverpage Msg	—	You can set up your own comments for fax Cover Page.	6-13
		9 Overseas Mode	On Off *	Adjusts for overseas transmissions, which can sometimes cause problems.	6-18
		0 Glass Fax Size	A4/Letter * Legal	Adjusts the scan area of the scanner glass to the size of the original.	6-4
	3.Set Auto Dial	1 One-Touch Dial	—	Stores One-Touch Dial numbers, so you can dial by pressing one key (and Start).	7-1
		2 Speed-Dial	—	Stores Speed-Dial numbers, so you can dial by pressing only a few keys (and Start).	7-2



The default settings are shown in Bold with \*.

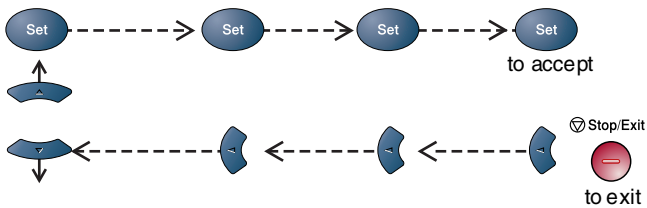

Main Menu	Sub menu	Menu Selections	Options	Descriptions	Page
2.Fax (Continued)	3.Set Auto Dial (continued)	3.Setup Groups	—	Sets up a Group number for Broadcasting.	7-4
	4.Setup Reports	1.Transmission	On On+Image <b>Off *</b> Off+Image	Initial setup for Transmission Verification Report and Fax Activity Report.	9-1
		2.Act. Interval	Every 7 Days Every 2 Days Every 24 Hours Every 12 Hours Every 6 Hours <b>Every 50 Faxes *</b> Off		9-2
	5.Remote Fax Opt	1.Fax Fwd/Paging	<b>Off *</b> Fax Forward Paging	Sets the MFC to forward fax messages or to call your pager.	8-1
		2.Fax Storage	On <b>Off *</b>	Stores incoming faxes in the memory so you can retrieve them while you are away from your MFC.	8-3
		3.Remote Access	-- *	You must set your own code for Remote Retrieval.	8-4
		4.Print Fax	—	Prints incoming faxes stored in the memory.	5-5
	6.Remaining Jobs	—	—	Checks which jobs are in the memory or cancels a delayed fax or polling job.	6-11

 The default settings are shown in Bold with \*.

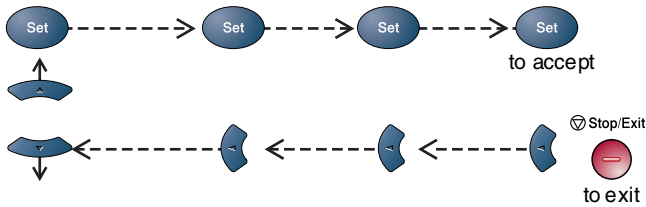

Main Menu	Submenu	Menu Selections	Options	Descriptions	Page
<b>2.Fax</b> (Continued)	0.Miscellaneous	<b>1.Mem Security</b>	—	Prohibits most functions except receiving faxes into memory.	6-23
		<b>2.Drum Life</b>	—	You can check the percentage of drum life that remains available.	22-37
		<b>3.Page Counter</b>	Total Copy Print List/Fax	Let you check number of total pages the MFC has printed so far.	22-37
		<b>4.Distinctive</b>	<b>Off *</b> Set (On)	Uses the Telephone Company's Distinctive Ring subscriber service to register the ring pattern with the MFC.	5-13
		<b>5.Caller ID</b>	Display # Print Report	View or print a list of the last 30 Caller IDs stored in the memory.	5-15
<b>3.Copy</b>	<b>1.Quality</b>		Text Photo <b>Auto *</b>	Selects the Copy resolution for your type of original.	10-16
	<b>2.Contrast</b>	—	- □□□■ + - □□□■ + - □□□■ +* - □□□□ + - ■□□□ +	Adjusts the contrast for copies.	10-16
<b>4.Printer</b>	<b>1.Emulation</b>	—	<b>Auto *</b> HP LaserJet BR-Script 3	Selects the Emulation mode.	11-17



The default settings are shown in Bold with \*.

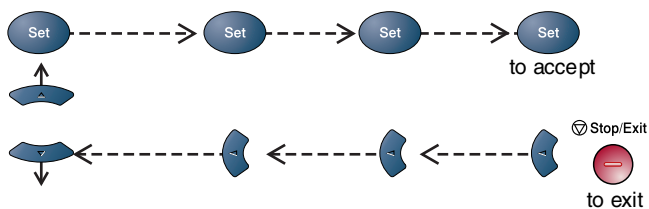

Main Menu	Submenu	Menu Selections	Options	Descriptions	Page
4.Printer (Continued)	2.Print Options	1.Internal Font	—	Prints a list of the MFC's internal fonts or current printer settings.	11-18
		2.Configuration	—		11-18
	3.Reset Printer	—	—	Returns the MFC to the original factory default settings.	11-18
5.Print Reports	1.Help List	—	—	You can print these lists and reports.	9-3
	2.Auto Dial	—	—		
	3.Fax Activity	—	—		
	4.Transmission	—	—		
	5.User Settings	—	—		
0.Initial Setup	1.Receive Mode	—	<b>Fax Only *</b> Fax/Tel External TAD Manual	You can choose the receive mode that best suits your needs.	5-2
	2.Date/ Time	—	—	Puts the date and time on the LCD and in headings of faxes you send.	4-1
	3.Station ID	—	Fax Tel Name	Program your name, fax and telephone number to appear on each page you fax.	4-2 4-3
	4.Tone/ Pulse (Canada Only)	—	<b>Tone *</b> Pulse	Selects the dialing mode.	4-4
	0.Local Language (Canada Only)	—	<b>English *</b> French	Allows you to change the LCD Language for your country.	See Quick Setup Guide

 The default settings are shown in Bold with \*.



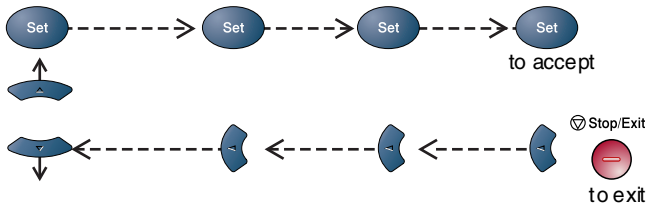

 If your machine is MFC-8820DN or you installed optional LAN board (NC-9100h), the LCD shows the following LAN menu.

Main Menu	Submenu	Menu Selections	Options	Descriptions	Page
<b>6.LAN</b> (MFC-8820DN or option)	<b>1.Setup TCP/IP</b>	<b>1.BOOT Method</b>	<b>Auto *</b> Static RARP BOOTP DHCP	You can choose the BOOT method that best suits your needs.	See <b>Network User's Guide</b> on the CD-ROM.
		<b>2 IP Address</b>	[000-255] . [000-255] . [000-255] . [000-255]	Enter the IP address.	
		<b>3.Subnet Mask</b>	[000-255] . [000-255] . [000-255] . [000-255]	Enter the Subnet mask.	
		<b>4 Gateway</b>	[000-255] . [000-255] . [000-255] . [000-255]	Enter the Gateway address.	
		<b>5 Host Name</b>	BRN_XX XXXX	Enter the Host name.	
		<b>6.WINS Config</b>	<b>Auto *</b> Static	You can choose the WINS configuration mode.	
		<b>7 WINS Server</b>	Primary Secondary	Specifies the IP address of the primary or secondary server.	
		<b>8 DNS Server</b>	Primary Secondary	Specifies the IP address of the primary or secondary server.	
		<b>9 API PA</b>	<b>On *</b> Off	Automatically allocates the IP address from the link-local address range.	



The default settings are shown in Bold with \*.

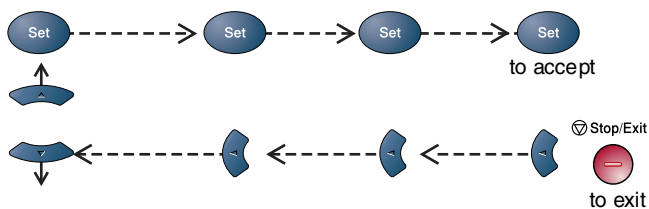

Main Menu	Sub menu	Menu Selections	Options	Descriptions	Page
6.LAN (MFC-8820DN or option)	2.Setup Internet	<b>1.Mail Address</b>	(60 characters)	Enter the mail address.	See Network User's Guide on the CDROM.
		<b>2.SMTP Server</b>	[000-255]. [000-255]. [000-255]. [000-255]	Enter the SMTP server address.	
		<b>3.POP3 Server</b>	[000-255]. [000-255]. [000-255]. [000-255]	Enter the POP3 server address.	
		<b>4.Ma ilbox Name</b>	(up to 20 characters)	Enter the mail box name.	
		<b>5Mailbox Pwd</b>	Password: ** ****	Enter the password to login to the POP3 server.	

 The default settings are shown in Bold with \*.

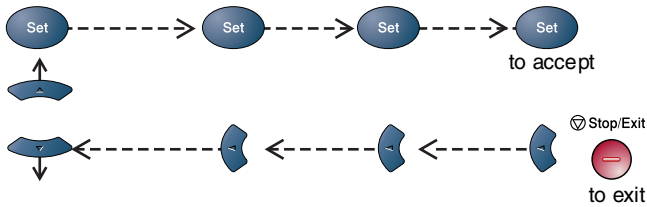

Main Menu	Submenu	Menu Selections	Options	Descriptions	Page
6.LAN (option) (Continued)	3.Setup Mail RX	1 Auto Polling	On * Off	Automatically checks the POP3 server for new messages.	See Network User's Guide on the CD-ROM.
		2 Poll Frequency	10Min	Sets the interval for checking for new messages on the POP3 server.	
		3 Header	All Subject+From +To None *	Selects the contents of the mail header to be printed.	
		4 Del Error Mail	On * Off	Deletes error mails automatically.	
		5.Notification	On MDN Off *	Sends notification messages.	
	4.Setup Mail TX	1 Sender Subject	-	Displays the subject that is attached to the Internet Fax data.	
		2 Size Limit	On Off *	Limits the size of E-mail documents.	
		3 Notification	On Off *	Sends notification messages.	
	5.Setup Relay	1 Rly Broadcast	On Off *	Relays a document to another fax machine.	
		2 Relay Domain	RelayXX:	Registers the Domain name.	
		3 Relay Report	On Off *	Prints the Relay Broadcast Report.	



The default settings are shown in Bold with \*.

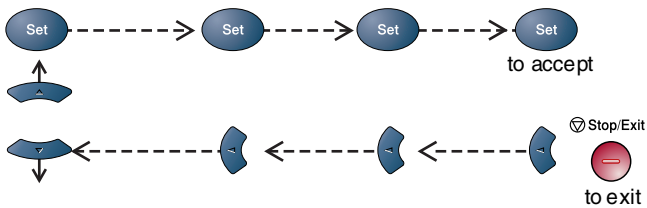

Main Menu	Submenu	Menu Selections	Options	Descriptions	Page
6.LAN (option) (Continued)	6.Setup Misc.	1.Netware	<b>On *</b> Off	Select <b>on</b> to use the MFC on a Netware network.	See Network User's Guide on the CDROM.
		2.Net Frame	<b>Auto *</b> 8023 ENET 8022 SNAP	Lets you specify the frame type.	
		3.AppleTalk	<b>On *</b> Off	Select <b>on</b> to use the MFC on a Macintosh network.	
		4.DLC/LLC	<b>On *</b> Off	Select <b>on</b> to use the MFC on a DLC/LLC network.	
		5.Net BIOS /IP	<b>On *</b> Off	Select <b>on</b> to use the MFC on a Net BIOS/IP network.	
		6.Ethernet	<b>Auto *</b> 100B-FD 100B-HD 10B-FD 10B-HD	Selects Ethernet link mode.	
		7.Time Zone	GMT-XX:XX	Sets the time zone for your country.	
	7.Scan to Email	—	<b>PDF *</b> JPEG	Selects the file type.	



The default settings are shown in Bold with \*.



If you have the optional paper tray, the LCD displays these options. (**Menu, 1, 7/Menu, 1, 8**)

(For MFC-8420 with the optional paper tray #2)

Main Menu	Submenu	Menu Selections	Options	Descriptions	Page
1.General Setup	7.Tray Use:Copy	—	Tray#1 Only Tray#2 Only <b>Auto *</b>	Select the tray that will be used for copying.	4-11
	8.Tray Use:Fax	—	Tray#1 Only Tray#2 Only <b>Auto *</b>	Select the tray that will be used for faxing.	4-12

(For MFC-8820D and MFC-8820DN with the optional paper tray #2)

Main Menu	Submenu	Menu Selections	Options	Descriptions	Page
1.General Setup	7.Tray Use:Copy	—	Tray#1 Only Tray#2 Only MP Only <b>Auto *</b>	Select the tray that will be used for copying.	4-11
	8.Tray Use:Fax	—	Tray#1 Only Tray#2 Only <b>Auto *</b>	Select the tray that will be used for faxing.	4-12



The default settings are shown in Bold with \*.

# 4 Getting started

## Initial Setup

### Setting the Date and Time

---

Your MFC displays the date and time and if you set up the Station ID it prints on every fax you send. If there is a power failure, you may have to reset the date and time. All other settings will not be affected.

- 1** Press **Menu, 0, 2**.
- 2** Enter the last two digits of the year.  
Press **Set**.
- 3** Enter two digits for the month.  
Press **Set**.  
(For example, enter 09 for September, or 10 for October.)
- 4** Enter two digits for the day.  
Press **Set**.  
(For example, enter 06 for 6th.)
- 5** Enter the time in 24-Hour format.  
Press **Set**.  
(For example, enter 15:25 for 3:25 P.M.)
- 6** Press **Stop/Exit**. The LCD now shows the date and time whenever the MFC is in Standby mode.

02.Date/Time
Year: 20XX
Enter & Set Key

# Setting the Station ID

---

You should store your name or company name and fax number and telephone number to be printed on all fax pages that you send.

**1** Press **Menu, 0, 3**.

**2** Enter your fax number (up to 20 digits).

Press **Set**.

**3** Enter your telephone number (up to 20 digits).

Press **Set**.

(If your telephone number and fax number are the same, enter the same number again).

03.Station ID
Fax:
Enter & Set Key



The telephone number you enter is only used for Cover Page features. (See *Composing the electronic Cover Page* on page 6-12)



You can not enter a hyphen.

**4** Use the dial pad to enter your name (up to 20 characters).

Press **Set**.

(See *Entering text* on page 4-3.)

**5** Press **Stop/Exit**.

The LCD will show the date and time.



If the Station ID has already been programmed, the LCD will ask you to press **1** to make a change or **2** to exit without changing.

## Entering text

When you are setting certain functions, such as the Station ID, you may need to type text into the MFC. Most number keys have three or four letters printed above them. The keys for **0**, **#** and **\*** do not have printed letters because they are used for special characters.

By pressing the appropriate number key repeatedly, you can access the character you want.

Press Key	one time	two times	three times	four times
2	A	B	C	2
3	D	E	F	3
4	G	H	I	4
5	J	K	L	5
6	M	N	O	6
7	P	Q	R	S
8	T	U	V	8
9	W	X	Y	Z

## Inserting spaces

To enter a space, press  once between numbers and twice between characters.

## Making corrections

If you entered a letter incorrectly and want to change it, press  to move the cursor under the incorrect character. Then press **Clear/Back**. The letter above the cursor will be deleted. Re-enter the correct character.

## Repeating letters

If you need to enter a character that is on the same key as the previous character, press  to move the cursor to the right before you press the key again.



## Special characters and symbols

Press **\***, **#** or **0**, and then press  or  to move the cursor under the special character or symbol you want. Then press **Set** to select it.



Press **\*** for (space) ! " # \$ % & ' ( ) \* + , - . / €  
Press **#** for ; < = > ? @ [ ] ^ \_  
Press **0** for É À È Ê Î Ç Ë Ö 0

### NOTICE (For USA)

The Telephone Consumer Protection Act of 1991 makes it unlawful for any person to use a computer or electronic device to send any message via a telephone fax machine unless such messages clearly contain, in a margin at the top or bottom of each transmitted page, or on the first page of the transmission, the date and time it is sent and an identification of the business or other entity or other individual sending the message and the telephone number of the sending machines or such business, other entity or individual.

In order to program this information into your MFC, complete the steps described on page 4-2.

## Setting Tone and Pulse dialing mode (For Canada only)

- 1 Press **Menu, 0, 4**.
- 2 Press  or  to select Pulse (or Tone). Press **Set**.
- 3 Press **Stop/Exit**.

04.Tone/Pulse

▲ Tone  
▼ Pulse



Select ▲▼ & Set

# General Setup

## Setting the Mode Timer

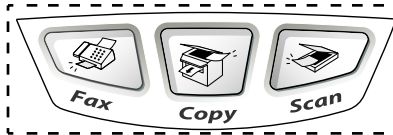
The MFC has three temporary mode keys on the control panel: Fax, Copy and Scan. You can change the number of seconds or minutes the MFC takes after the last Copy or Scan operation before it returns to Fax mode. If you select Off, the MFC stays in the mode you used last.



- 1 Press **Menu**, **1**, **1**.
- 2 Press  or  to select 0 Sec, 30 Secs, 1 Min, 2 Mins, 5 Mins or Off.
- 3 Press **Set**.

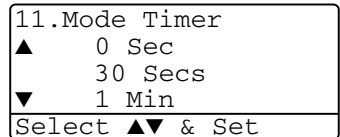



## Setting the Paper Type

To get the best print quality, set the MFC for the type of paper you are using.

For MFC-8420

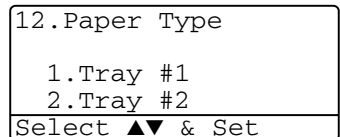
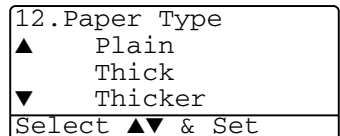
- 1 Press **Menu**, **1**, **2**.  
—OR—  
If you have the optional paper tray, press **Menu**, **1**, **2**, **1** to set the paper type for Tray #1 or **Menu**, **1**, **2**, **2** to set the paper type for Tray #2.



- 2 Press  or  to select Thin, Plain, Thick, Thicker or Transparency.
- 3 Press **Set**.
- 4 Press **Stop/Exit**.

## For MFC-8820D and MFC-8820DN



**1** Press **Menu, 1, 2, 1** to set the paper type for MP Tray.

—OR—

Press **Menu, 1, 2, 2** to set the paper type for Tray #1.

—OR—

If you have the optional paper tray, press **Menu, 1, 2, 3** to set the paper type for Tray #2.

**2** Press  or  to select Thin, Plain, Thick, Thicker or Transparency.

**3** Press **Set**.

**4** Press **Stop/Exit**.



You can select Transparency for Tray #1 and Tray #2 only when A4, Letter or Legal is selected in **Menu, 1, 3**.



12.Paper Type
1.MP Tray
2.Tray #1
3.Tray #2
Select ▲▼ & Set

12.Paper Type
1.MP Tray
▲ Plain
▼ Thick
Select ▲▼ & Set

## Setting the Paper Size

You can use eight sizes of paper for printing copies: A4, letter, legal, executive, A5, A6, B5 and B6 and three sizes of paper for printing faxes: A4, letter and legal. When you change the size of paper in the MFC, you will need to change the setting for Paper Size at the same time so your MFC can fit an incoming fax or reduced copy on the page.

**1** Press **Menu, 1, 3**.

**2** Press  or  to select A4, Letter, Legal, Executive, A5, A6, B5 or B6.

Press **Set**.

**3** Press **Stop/Exit**.

13.Paper Size
▲ A4
Letter
▼ Legal
Select ▲▼ & Set



*With optional paper tray (LT-5000)*

**1** Press **Menu, 1, 3, 1** to set the paper size for Tray #1.

—OR—

Press **Menu, 1, 3, 2** to set the paper size for Tray #2

13.Paper Size
1.Tray #1
2.Tray #2
Select ▲▼ & Set

**2** Press  or  to select A4, Letter, Legal, Executive, A5, A6, B5 and B6.

Press **Set**.

**3** Press **Stop/Exit**.





- If you are using the optional paper tray, paper size A6 is not available.
- If you select Transparency in **Menu, 1, 2**, you can only select A4, Letter or Legal.

## Setting the Ring Volume



---

You can adjust the ring volume when your MFC is idle (not being used). You can turn the ring **Off** or you can select the ring volume level.

- 1 Press **Menu, 1, 4, 1.**
- 2 Press  or  to select (Low, Med, High or Off). Press **Set.**
- 3 Press **Stop/Exit.**

14.Volume
1.Ring
▲ Med
▼ High
Select ▲▼ & Set



—OR—

In Fax mode, press  or  to adjust the volume level. Every time you press these keys, the MFC will ring so you can hear the active setting as the LCD shows it. The volume changes with each key press. The new setting will stay until you change it again.

## Setting the Beeper Volume

---

You can change the beeper volume. The default (factory) setting is **Med**. When the beeper is on, the MFC beeps every time you press a key or make a mistake and after a fax is sent or received.



- 1 Press **Menu, 1, 4, 2.**
- 2 Press  or  to select your option. (Low, Med, High or Off) Press **Set.**
- 3 Press **Stop/Exit.**

14.Volume
2.Beeper
▲ Med
▼ High
Select ▲▼ & Set

## Setting the Speaker Volume

---

You can adjust the MFC's one-way speaker volume.



- 1 Press **Menu, 1, 4, 3.**
- 2 Press  or  to select (Low, Med, High or Off).  
Press **Set**.

14. Volume
3. Speaker
▲ Med
▼ High
Select ▲▼ & Set

- 3 Press **Stop/Exit.**

—OR—



In Fax mode, you can adjust the speaker volume by pressing **Hook**, and then selecting a speaker volume level.

Press  or  to adjust the volume level. The LCD shows the setting you are choosing. Each key press changes the volume to the next setting. The new setting will remain until you change it again.

## Turning on Automatic Daylight Savings Time

---

You can set the MFC to change automatically for Daylight Savings Time. It will reset itself forward one hour in the Spring and backward one hour in the Fall. Make sure you have set the correct day and time in the *Date/Time* setting.



- 1 Press **Menu, 1, 5.**
- 2 Press  or  to select On (or Off).  
Press **Set**.
- 3 Press **Stop/Exit.**

15. Auto Daylight
▲ On
▼ Off
Select ▲▼ & Set

## Toner Save

---

You can conserve toner using this feature. When you set Toner Save to On, print appears somewhat lighter. The default setting is Off.

- 1 Press **Menu, 1, 6, 1.**
- 2 Press  or  to select On (or Off).
- 3 Press **Set**.
- 4 Press **Stop/Exit.**

16. Ecology
1. Toner Save
▲ On
▼ Off
Select ▲▼ & Set

## Sleep Time

---

Setting the Sleep Time reduces power consumption by turning off the fuser inside the MFC, while it is idle. You can choose how long the MFC is idle (from 00 to 99 minutes) before it goes into sleep mode. The timer is automatically reset when the MFC receives a Fax or PC data, or makes a copy. The factory setting is 05 minutes. While the MFC is in sleep mode, you will see **Sleep** on the LCD. If you try to print or copy in sleep mode, there will be a short delay while the fuser warms up to working temperature.

**1** Press **Menu, 1, 6, 2**.

**2** Use the dial pad to enter the length of time the MFC is idle before it goes into sleep mode (00 to 99).

**3** Press **Set**.

**4** Press **Stop/Exit**.





■ If you want to turn sleep mode off, press **Secure** and **Job Cancel** simultaneously in Step 2.

■ If the MFC is in Sleep Mode when you change the Sleep Time, the new setting will take effect the next time the MFC copies, prints or is restarted.

## Turning off the Scanner Lamp

---

The scanner lamp stays on for 16 hours before automatically switching off to preserve the life of the lamp. You can turn off the scanner lamp manually if you wish by pressing the  and  keys simultaneously. The scanner lamp will remain turned off until the next time you use the scanning feature.

Turning off the scanner lamp will also reduce the power consumption.



Please note that turning the lamp off regularly will reduce the lamp's life. Some people prefer to turn the lamp off as they leave the office, or late at night at home. This is not necessary for normal day to day use.



## Setting the Tray Use for Copy mode



If your MFC is a MFC-8420 without the optional tray #2, you can skip this setting.

### MFC-8420



The default setting of **Auto** allows\*<sup>1</sup> your MFC to choose the optional Tray #2 when paper is out in Tray #1 or\*<sup>2</sup> when the size of the original will fit best on the paper in Tray #2.

- 1 Press **Menu, 1, 7**.
- 2 Press  or  to select **Tray#1 Only**, **Tray#2 Only**, or **Auto**.
- 3 Press **Set**.
- 4 Press **Stop/Exit**.

17.Tray Use: Copy
▲ Tray#1 Only
Tray#2 Only
▼ Auto
Select ▲▼ & Set



### MFC-8820D and MFC-8820DN

The default setting of **Auto** allows\*<sup>1</sup> your MFC to choose the optional Tray #2 or the MP tray when paper is out in Tray #1 or\*<sup>2</sup> when the size of the original will fit best on the paper in Tray #2.

- 1 Press **Menu, 1, 7**.
- 2 Press  or  to select **Tray#1 Only**, **MP Only**, or **Auto**.

17.Tray Use: Copy
▲ Tray#1 Only
MP Only
▼ Auto
Select ▲▼ & Set

—OR—

If you have the optional paper tray, press  or  to select **Tray#1 Only**, **Tray#2 Only**, **MP Only** or **Auto**.

17.Tray Use: Copy
▲ Tray#1 Only
Tray#2 Only
▼ MP Only
Select ▲▼ & Set

- 3 Press **Set**.
- 4 Press **Stop/Exit**.



\*1 Copies will automatically be printed from Tray #2 only if the Paper Size setting for Tray #2 is the same as Tray #1.



\*2 When using the ADF, copies will automatically be printed from Tray #2 if the Paper Size setting for Tray #2 is different than Tray #1 and this paper size is more suitable for the scanned original.



## Setting the Tray Use for Fax mode

---

If your MFC doesn't have the optional tray #2, you can skip this setting. The default setting of **Auto** allows your MFC to choose the optional Tray #2 if Tray #1 is out of paper or if incoming faxes will fit best on the paper in Tray #2.

- 1 Press **Menu, 1, 8**.
- 2 Press  or  to select **Tray#1 Only**, **Tray#2 Only**, or **Auto**.
- 3 Press **Set**.
- 4 Press **Stop/Exit**.



18.Tray Use: Fax
▲ Tray#1 Only
Tray#2 Only
▼ Auto
Select ▲▼ & Set

 If **Auto Reduction** is turned on, incoming faxes will be printed from the tray that is set for **Auto Reduction**. (See *Printing a reduced incoming fax (Auto Reduction)* on page 5-5.)

## Setting the LCD Contrast

---

You can change the contrast to help the LCD look lighter or darker.

- 1 (MFC-8420)  
Press **Menu, 1, 7**.  
(MFC-8820D/8820DN)  
Press **Menu, 1, 8**.  
—OR—  
If you have the optional tray #2, press **Menu, 1, 9**.
- 2 Press  to increase the contrast.  
—OR—  
Press  to decrease the contrast.  
Press **Set**.
- 3 Press **Stop/Exit**.

19.LCD Contrast
-□□■□□+
Select ◀▶ & Set

# 5 Setup Receive

## Basic receiving operations

### Choosing the Receive Mode

There are four different Receive Modes for your MFC. You can choose the mode that best suits your needs.



LCD	How it works	When to use it
Fax Only (automatic receive)	The MFC automatically answers every call as a fax.	For dedicated fax lines.
Fax/Tel* (fax and telephone)  (with an external or extension telephone)	The MFC controls the line and automatically answers every call. If the call is a fax it will receive the fax. If the call is not a fax it will ring (pseudo/double ring) for you to pick up the call.	Use this mode if you expect to receive lots of fax messages and few telephone calls. You cannot have an answering machine on the same line, even if it is on a separate wall jack/phone socket on the same line. You cannot use the telephone company's Voice Mail in this mode.
External TAD (with an external answering machine)	The external answering machine (TAD) automatically answers every call. Voice messages are stored on the external TAD. Fax messages are printed.	Use this mode if you have an external answering machine on your phone line. The TAD setting works only with an external answering machine. Ring Delay and F/T Ring Time do not work in this setting.
Manual (manual receive)  (with an external or extension telephone or with Distinctive Ring)	You control the phone line and must answer every call yourself.	Use this mode when you are using a computer modem on the same line or if you don't receive many fax messages or with Distinctive Ring. If you hear fax tones, wait until the MFC takes over the call, then hang up. (See <i>Easy Receive</i> on page 5-4.)

\* In Fax/Tel mode you must set the Ring Delay and F/T Ring Time. If you have extension phones on the line, keep the Ring Delay set to four rings.



The MP tray is not available with Fax Receive.

## To select or change your Receive Mode

- 1 Press **Menu, 0, 1.**
- 2 Press  or  to select Fax Only, Fax/Tel, External TAD or Manual.  
Press **Set.**
- 3 Press **Stop/Exit.**

01.Receive Mode
▲ Fax Only
Fax/Tel
▼ External TAD
Select ▲▼ & Set





If you are changing the Receive Mode while in another operation, the LCD will return to that operation.

03/01/2003 18:15
Duplex Receive
External TAD
Dial & Start

Fax Only  
Fax/Tel  
External TAD  
Manual

## Setting the Ring Delay

The Ring Delay sets the number of times the MFC rings before it answers in Fax Only or Fax/Tel mode. If you have extension phones on the same line as the MFC or subscribe to the telephone company's Distinctive Ring service, keep the Ring Delay setting of 4. (See *Easy Receive* on page 5-4 and *Operation from extension telephones* on page 5-7.)

- 1 If it is not illuminated in green, press  (**Fax**).
- 2 Press **Menu, 2, 1, 1.**
- 3 Press  or  to select how many times the line rings before the MFC answers (00-04).  
Press **Set.**  
(If you select 00, the line won't ring at all.)
- 4 Press **Stop/Exit.**

21.Setup Receive
1.Ring Delay
▲ 03
▼ 04
Select ▲▼ & Set



## Setting the F/T Ring Time (Fax/Tel mode only)

If you set the Receive Mode to Fax/Tel, you'll need to decide how long the MFC will signal you with its special pseudo/double-ring when you have a *voice* call. (If it's a fax call, the MFC prints the fax.)

This pseudo/double-ring happens after the initial ringing from the phone company. Only the MFC rings (for 20, 30, 40 or 70 seconds) and no other phones on the same line will ring with the special pseudo/double-ring. However, you can still answer the call on any extension phone (in a separate wall jack/phone socket) on the same line as the MFC. (See *Operation from extension telephones* on page 5-7.)

**1** If it is not illuminated in green, press  (**Fax**).

**2** Press **Menu, 2, 1, 2**.

**3** Press  or  to select how long the MFC will ring to alert you that you have a voice call.

Press **Set**.

**4** Press **Stop/Exit**.

21.Setup Receive
2.F/T Ring Time
▲ 20
▼ 30
Select ▲▼ & Set

 Even if the caller hangs up during the pseudo/double-ringing, the MFC will continue to ring for the set time.



# Easy Receive

When you use this feature, you don't have to press **Start** or the Fax Receive Code \*51 when you answer a fax call. Selecting **On** allows the MFC to receive fax calls automatically, even if you lift the handset of an extension or external phone. When you see **Receiving** on the LCD or when you hear 'chirps' through the handset of an extension phone connected to another wall jack/phone socket, just replace the handset and your MFC will do the rest. Selecting **Off** means you'll have to activate the MFC yourself by lifting the handset of an external or extension phone, and then press **Start** on the MFC—**OR**—by pressing \*51 if you are not at your MFC. (See *Operation from extension telephones* on page 5-7.)



If this feature is set to **On**, but your MFC doesn't connect a fax call when you lift a extension or external phone handset, press the Fax Receive Code \*51.

If you send faxes from a computer on the same phone line and the MFC intercepts them, set Easy Receive to **Off**.

- 1 If it is not illuminated in green, press  (**Fax**).
- 2 Press **Menu, 2, 1, 3**.
- 3 Use  or  to select **On** (or **Off**). Press **Set**.
- 4 Press **Stop/Exit**.

21.Setup Receive
3.Easy Receive
▲ On
▼ Off
Select ▲▼ & Set



## Printing a reduced incoming fax (Auto Reduction)

---



If you choose **On**, the MFC automatically reduces an incoming fax to fit on one page of letter, legal or A4 size paper, regardless of the paper size of the original. The MFC calculates the reduction ratio by using the page size of the original and your Paper Size setting (**Menu, 1, 3**).

**1** If it is not illuminated in green, press  (**Fax**).

**2** Press **Menu, 2, 1, 5**.

**3** If you have the optional paper tray #2, press  or  to select Tray #1 or Tray #2.  
Press **Set**.

21.Setup Receive
5.Auto Reduction
▲ On
▼ Off
Select ▲▼ & Set

**4** Use  or  to select **On** (or **Off**).  
Press **Set**.

**5** Press **Stop/Exit**.

 If you receive faxes that are split onto two pages, turn on this setting.

## Printing a fax from the memory

---

If you set Fax Storage to **ON** for Remote Retrieval, you can still print a fax from the memory when you are at your MFC. (See *Setting Fax Storage* on page 8-3.)

**1** Press **Menu, 2, 5, 4**.

**2** Press **Start**.



**3** After printing has finished, press **Stop/Exit**.

25.Remote Fax Opt
4.Print Fax
Press Start

# Setting the Print Density

---

You can adjust print density, making your printed pages darker or lighter.

- 1** If it is not illuminated in green, press  **(Fax)**.
- 2** Press **Menu, 2, 1, 6**.
- 3** Press  to make the print darker.  
—OR—  
Press  to make the print lighter.  
Press **Set**.
- 4** Press **Stop/Exit**.

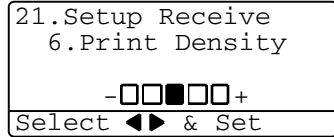

# Advanced receiving operations

## Operation from extension telephones

---

If you answer a fax call on an extension telephone, or an external telephone in the EXT. jack, you can make your MFC take the call by using the Fax Receive Code. When you press the Fax Receive Code \* 51, the MFC starts to receive a fax.

(See *Easy Receive* on page 5-4.)

If the MFC answers a voice call and pseudo/double-rings for you to take over, use the Telephone Answer Code #51 to take the call at an extension phone. (See *Setting the F/T Ring Time (Fax/Tel mode only)* on page 5-3.)

If you answer a call and no one is on the line, you should assume that you're receiving a manual fax.

- At an extension phone (on a separate telephone wall jack/phone socket), press \* 51, wait for fax-receiving tones (chirps), and then hang up.
- At an external phone (connected to the MFC's EXT jack), press \* 51 and wait for the phone to be disconnected before you hang up (the LCD shows *Receiving*).

Your caller will have to press **Start** to send the fax.

## For FAX/TEL mode only

---

When the MFC is in FAX/TEL mode, it will use the F/T Ring Time (pseudo/double-ringing) to alert you to pick up a voice call.

Lift the external telephone's handset, and then press **Hook** to answer.

If you're at an extension phone, you'll need to lift the handset during the F/T Ring Time and then press #51 between the double rings. If no one is on the line, or if someone wants to send you a fax, send the call back to the MFC by pressing \* 51.



## Using a cordless external handset

---

If your cordless telephone is connected to the EXT. jack of the MFC and you typically carry the cordless handset elsewhere, it is easier to answer calls during the Ring Delay. If you let the MFC answer first, you will have to go to the MFC so you can press **Hook** to transfer the call to the cordless handset.



## Changing the remote codes

---

Remote Codes might not work with some telephone systems. The preset Fax Receive Code is \*51. The preset Telephone Answer Code is #51.



If you are always disconnected when accessing your external TAD remotely, try changing the Fax Receive Code and Telephone Answer Code to another three-digit code (such as ### and 999).

- 1 If it is not illuminated in green, press  (**Fax**).
- 2 Press **Menu, 2, 1, 4**.
- 3 Press  or  to select On (or Off).  
Press **Set**.
- 4 If you want to, enter a new Fax Receive Code.  
Press **Set**.
- 5 If you want to, enter a new Telephone Answer Code.  
Press **Set**.
- 6 Press **Stop/Exit**.

21.Setup Receive
4.Remote Code
▲ On
▼ Off
Select ▲▼ & Set

# Polling

Polling is the process of retrieving faxes from another fax machine. You can use your MFC to 'poll' other machines, or you can have someone poll your MFC.

Everyone who is involved in Polling needs to set up their fax machines for Polling. When someone polls your MFC to receive a fax, they pay for the call. If you poll someone's fax machine to receive a fax, you pay for the call.



Some fax machines do not respond to the Polling feature.

## Setting up Polling Receive

Polling Receive is when you call another fax machine to receive a fax from it.

**1** If it is not illuminated in green, press  (**Fax**).

**2** Press **Menu, 2, 1, 7**.

**3** Press  or  to select On (or Off).

Press **Set**.

**4** Enter the fax number you are polling.

**5** Press **Start**.

The LCD shows *Dialing*.



21.Setup Receive
7.Polling RX
▲ On
▼ Off
Select ▲▼ & Set

## Setting up Sequential Polling Receive

Your MFC can ask for faxes from several fax units in a single operation (Sequential Polling Receive). Afterwards, a Sequential Polling Report will be printed.

**1** If it is not illuminated in green, press  **(Fax)**.

**2** Press **Menu, 2, 1, 7**.

**3** Press  or  to select On (or Off).

Press **Set**.

**4** Enter the fax machines you want to poll using One-Touch, Speed-Dial, a Group or the dial pad. You must press **Set** between each fax number.

**5** Press **Start**. Your MFC will poll each number or Group number in turn to receive a fax.

21.Setup Receive
7.Polling RX
▲ On
▼ Off
Select ▲▼ & Set

## Setting Duplex printing for Fax mode (For MFC-8820D and MFC-8820DN)

If you set Duplex to On for fax receive, the MFC prints received faxes on both sides of the paper.

You can use three sizes of paper for this function - letter, legal and A4.

**1** If it is not illuminated in green, press  **(Fax)**.

**2** Press **Menu, 2, 1, 8**.

**3** Press  or  to select On (or Off).

Press **Set**.

**4** Press **Stop/Exit**.

 While the Duplex printing for fax is working, auto reduction is also On temporarily.

21.Setup Receive
8.Duplex
▲ On
▼ Off
Select ▲▼ & Set

# Telephone services

Your MFC supports the Distinctive Ring telephone service that some telephone companies offer.



If you have Voice Mail, RingMaster, an answering service, an alarm system or other custom features on your telephone line, it may affect the way your MFC works. (See *Custom features* on page 1-13 and *Custom features on a single line* on page 22-14.) If you have Voice Mail on your phone line, please read the following carefully.

## Distinctive Ring

---

Brother uses the term 'Distinctive Ring' but different telephone companies have other names for this service such as SmartRing, RingMaster, Teen-Ring, Indent-a-Call or Indent-a-Ring.

### What does your telephone company's 'Distinctive Ring' do?

Your telephone company's Distinctive Ring service allows you to have more than one number on the same phone line. **If you need more than one phone number, it is cheaper than paying for an extra line.** Each phone number has its own distinctive ring pattern, so you will know which phone number is ringing. This is one way you can have a separate phone number for your MFC.



Please call your telephone company for availability and rates.

### What does Brother's 'Distinctive Ring' do?

The Brother MFC has a Distinctive Ring feature that allows you to use your MFC to take full advantage of the telephone company's Distinctive Ring service. The new phone number on your line can just receive faxes.



You must pay for your telephone company's Distinctive Ring service before you program the MFC to work with it.

## Do you have Voice Mail?

If you have Voice Mail on the phone line that you will install your new MFC on, *there is a strong possibility that Voice Mail and the MFC will conflict with each other while receiving incoming calls.* **However, the Distinctive Ring feature allows you to use more than one number on your line, so both Voice Mail and the MFC can work together without any problems.** If each one has a separate phone number, neither will interfere with the other's operations.





If you decide to get the Distinctive Ring service from the telephone company, you will need to follow the directions below to 'register' the new Distinctive Ring pattern they give you. This is so your MFC can recognize its incoming calls.



You can change or cancel the Distinctive Ring pattern at any time. You can switch it off temporarily, and turn it back on later. When you get a new fax number, make sure you reset this feature.

## Before you choose the ring pattern to register

You can only register one Distinctive Ring pattern with the MFC. Some ring patterns cannot be registered. The ring patterns below are supported by your Brother MFC. Register the one your telephone company gives you.

Ring Pattern	Rings	
1	long-long	
2	short-long-short	
3	short-short-long	
4	very long (normal pattern)	



If the ring pattern you received is not on this chart, **please call your telephone company and ask for one that is shown.**

- The MFC will only answer calls to its registered number.
- The first two rings are silent on the MFC. This is because the fax must «listen» to the ring pattern (to compare it to the pattern that was 'registered'). (Other telephones on the same line will ring.)
- If you program the MFC properly, it will recognize the registered ring pattern of the 'fax number' within 2 ring patterns and then answer with a fax tone. When the 'voice number' is called, the MFC will not answer.

## Registering the Distinctive Ring pattern



---

### Very important!

After you have set the Distinctive Ring feature to ON, the receive mode is set to **Manual** automatically. Unless you have a TAD or Voice Mail set up on the Distinctive Ring number, **Manual** mode means you must answer all the calls yourself. You can not change the receive mode to the other mode while the Distinctive Ring is set to on.

**1** Press **Menu, 2, 0, 4**.

**2** Press  or  to select **Set**.  
Press **Set**.

**3** Press  or  to select the stored ring pattern you want to use.  
Press **Set**.

(You will hear each pattern as you scroll through the four patterns. Make sure you choose the pattern that the telephone company gave you.)

**4** Press **Stop/Exit**.  
Distinctive Ring is now set to on.

20.Miscellaneous
4.Distinctive
▲ Off
▼ Set
Select ▲▼ & Set

### Turning off the Distinctive Ring

**1** Press **Menu, 2, 0, 4**.

**2** Press  or  to select **Off**.  
Press **Set**.

**3** Press **Stop/Exit**.

20.Miscellaneous
4.Distinctive
▲ On
▼ Off
Select ▲▼ & Set

 If you turn off Distinctive Ring, the MFC will stay in **Manual** receive mode. You will need to set the **Receive Mode** again. (See *To select or change your Receive Mode* on page 5-2.)

# Caller ID



The Caller ID feature lets you use the Caller ID subscriber service offered by many local telephone companies. This service provides you, by means of the LCD, the name or telephone number of your caller as the line rings.

After a few rings, the LCD shows the telephone number of your caller (or name, if available). Once you pick up the handset, the Caller ID information disappears from the LCD, but the call information remains stored in the Caller ID memory.

- You will see the first 16 characters of the number (or name).
- **Out of Area** display means call originated outside your Caller ID service area.
- **Private Call** display means the caller has intentionally blocked transmission of information.

If both the name and number are received, the LCD shows only the name. You can print a list of Caller ID information received by your MFC. (See *Printing Caller ID List* on page 5-15.)

Caller ID service varies with different carriers. Call your local telephone company to determine the kind of service available in your area.

## Viewing Caller ID List

---

Caller ID memory stores information for up to thirty calls. When the thirty-first call comes in, information about the first call is erased. You can scroll through Caller ID information to review those calls made to your MFC.



**1** Press **Menu, 2, 0, 5**.

**2** Press  or  to select

Display #.

Press **Set**.

If the name was not received, it will not be displayed.

**3** Press  or  to scroll through the Caller ID memory to select the Caller ID you want to view, and then press **Set**. The LCD shows the caller's name and number and the date and time of the call.

**4** Press  or  to return to the Caller ID listing.

—OR—

Press **Stop/Exit**.

20.Miscellaneous
4.Caller ID
▲ Display#
▼ Print Report
Select ▲▼ & Set

## Clearing a Caller ID stored in the memory

---

For effective use of the memory, we recommend that you clear the Caller IDs stored in memory by pressing **Clear/Back** when the LCD shows each caller ID number or name.

## Printing Caller ID List

---

**1** Press **Menu, 2, 0, 5**.

**2** Press  or  to select

Print Report.

Press **Set**.

**3** Press **Start**.

**4** After printing has finished, press **Stop/Exit**.

20.Miscellaneous
5.Caller ID
▲ Display#
▼ Print Report
Select ▲▼ & Set





# 6 Setup Send

## How to Fax

You can send faxes from the ADF (Automatic Document Feeder) or from the scanner glass.

### Enter Fax mode

---

Before sending faxes, make sure  **(Fax)** is illuminated in green. If not, press  **(Fax)** to enter Fax mode. The default setting is Fax.

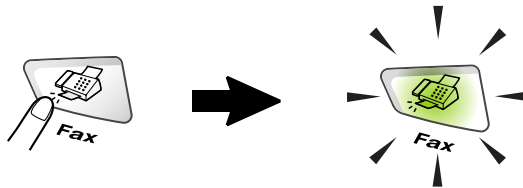

### Faxing from the automatic document feeder (ADF)

---

The ADF can hold up to 50 pages and feeds each sheet individually. Use standard (20 lb or 75 g/m<sup>2</sup>) paper and always fan the pages before putting them in the ADF.

- ⊘ DO NOT use paper that is curled, wrinkled, folded, ripped, stapled, paper clipped, pasted or taped.  
DO NOT use cardboard, newspaper or fabric. (To fax this kind of original, see *Faxing from the scanner glass* on page 6-3.)
- Make sure originals written with ink are completely dry.
- The originals to be faxed must be from 5.8 to 8.5 inches wide and 5.8 to 14 inches long.

## Faxing from the ADF

**1** If it is not illuminated in

green, press



(**Fax**). Pull out the ADF Document Support Extension.

**2** Unfold the ADF Document Output Support Flap.

**3** Fan the pages well and stagger them at an angle. Make sure you put the originals **face up, top edge first** in the ADF until you feel them touch the feed roller.

**4** Adjust the paper guides to fit the width of your originals.

**The originals are Face Up in the ADF**

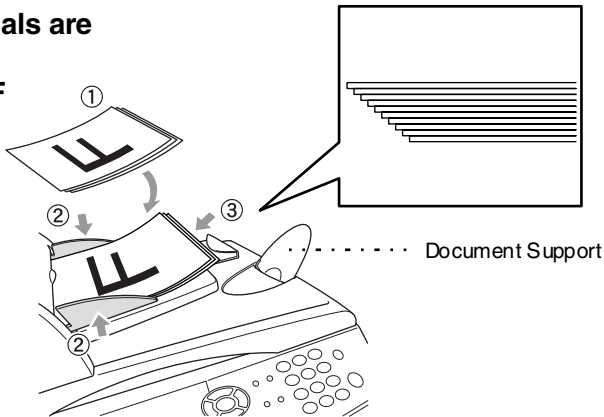

**5** Dial the fax number. Press **Start**. The MFC starts scanning the first page.



# Faxing from the scanner glass

You can use the scanner glass to fax pages of a book or one page at a time. The originals can be up to letter, A4 or legal size (8.5 inches to 14 inches). To cancel, press **Stop/Exit**.

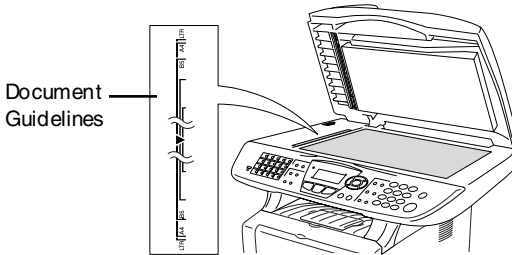
- 1** If it is not illuminated in green, press  (**Fax**). Lift the document cover.



The originals are  
Face Down on the  
Scanner Glass

- 2** Using the document guidelines on the left, center the original face down on the scanner glass.
- 3** Close the document cover.
-  If the original is a book or is thick, do not slam the cover or press on it.
- 4** Dial the fax number.  
Press **Start**.  
The MFC starts scanning the first page.
- 5** To send a single page, press **2** (or press **Start** again). The MFC starts sending the original.
- OR—  
To send more than one page, press **1** and go to Step 6.
- 6** Place the next page on the scanner glass.  
Press **Set**.  
The MFC starts scanning. (Repeat Steps 5 and 6 for each additional page.)
-  ■ If the memory is full and you are faxing a single page, it will be sent in real time.
- If you need to cancel before the fax is sent, press **Stop/Exit**.



Flatbed Fax: Next Page? ▼ 1.Yes ▲ 2.No (Send) Select ▲▼ & Set
---

Flatbed Fax: Set Next Page Then Press Set
---

## Faxing legal size originals from the scanner glass

---

When originals are legal size, you need to set the Glass Fax Size to **Legal**. If you do not, the bottom portion of the faxes will be missing.

- 1 If it is not illuminated in green, press  (**Fax**).
- 2 Press **Menu, 2, 2, 0**.
- 3 Press  or  to select **Legal**.  
Press **Set**.
- 4 Press **Stop/Exit**.

### Out of Memory message

If you get an **Out of Memory** message while scanning the first page of a fax, press **Stop/Exit** to cancel the scan. If you get an **Out of Memory** message while scanning a subsequent page, you will have the option to press **Start** to send the pages scanned so far, or to press **Stop/Exit** to cancel the operation.

## Manual transmission

---

Manual transmission lets you hear the dialing, ringing and fax-receiving tones while sending a fax.

- 1 If it is not illuminated in green, press  (**Fax**). Place the original face up in the ADF, or face down on the scanner glass.
- 2 Pick up the handset of the external phone and listen for a dial tone.  
—OR—  
Press **Hook** and listen for a dial tone.
- 3 On the external phone, dial the fax number you want to call. If you pressed **Hook**, dial using the MFC dial pad.
- 4 When you hear the fax tone, press **Start**.  
If you are using the ADF, go to Step 6.  
If you are using the scanner glass, go to Step 5.
- 5 Press **1** to send a fax.
- 6 If you picked up the handset of the external phone, replace it.

Send or Receive?

▲ 1.Send  
▼ 2.Receive

Select ▲▼ & Set

## Automatic transmission

---

### This is the easiest way to send a fax.

- ⊘ You must not pick up the handset of the external phone or press **Hook** to listen for a dial tone.
- 1** If it is not illuminated in green, press  (**Fax**). Place the original face up in the ADF, or face down on the scanner glass.
- 2** Enter the fax number using the dial pad, One-Touch, Speed-Dial or Search.  
(See *One-Touch Dialing* on page 7-5 and *Speed-Dialing* on page 7-6.)
- 3** Press **Start**.
- 4** If you are using the scanner glass, press **2** or **Start**.

### Sending a fax at the end of a conversation

---

At the end of a conversation you can send a fax to the other party before you both hang up.

- 1** Ask the other party to wait for fax tones (beeps) and then to press **Start** before hanging up.
- 2** If it is not illuminated in green, press  (**Fax**). Place the original face up in the ADF, or face down on the scanner glass. Press **Start**.  
The LCD shows:
- 3** Press **1** to send the fax.
- 4** Replace the external handset.

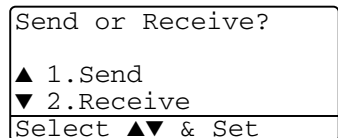

# Basic sending operations

## Sending faxes using multiple settings

---

When you send a fax you can choose any combination of these settings: cover page, contrast, resolution, overseas mode, delayed fax timer, polling transmission or real time transmission. After each setting is accepted, the LCD will ask if you want to enter more settings:

Press **1** to select more settings. The LCD will return to the Setup Send menu.

—OR—

Press **2** if you have finished choosing settings and go to the next step.

22.Setup Send
Other Settings?
▲ 1.Yes
▼ 2.No
Select ▲▼ & Set

## Contrast

---



If your original is very light or very dark, you may want to set the contrast.

Use **Light** to make the fax darker.

Use **Dark** to make the fax lighter.

**1** If it is not illuminated in green, press  (**Fax**). Place the original face up in the ADF, or face down on the scanner glass.

**2** Press **Menu, 2, 2, 1**.

**3** Press  or  to select Auto, Light or Dark.  
Press **Set**.

22.Setup Send
1.Contrast
▲ Auto
▼ Light
Select ▲▼ & Set

**4** Press **1** if you want to choose more settings and the LCD will return to the Setup Send menu.

—OR—

Press **2** if you have finished choosing settings for this page, and then go to Step 5.

**5** Enter a fax number.

**6** Press **Start** to send the fax from the ADF.

The MFC starts scanning the first page.

If you are using the scanner glass, go to Step 7.

**7** To send a single page, press **2** (or press **Start** again).

The MFC starts sending the original.

—OR—

To send more than one page, press **1** and go to Step 8.

**8** Place the next page on the scanner glass.

Press **Set**.

The MFC starts scanning and returns to Step 7. (Repeat Step 7 and 8 for each additional page).

## Fax Resolution

When you have an original in the ADF or on the scanner glass you can use the **Resolution** key to change the setting temporarily (for this fax only). If it is not illuminated in green, press  (**Fax**).



Press **Resolution** repeatedly until the LCD shows the setting you want.

—OR—

You can change the default setting.

**1** If it is not illuminated in green, press  (**Fax**).

**2** Press **Menu, 2, 2, 2**.

**3** Press  or  to select the resolution you want.

Press **Set**.

**4** Press **Stop/Exit**.

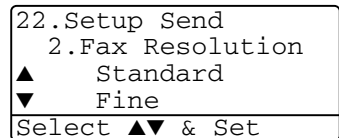

**Standard:** Suitable for most typed originals.

**Fine:** Good for small print and transmits a little slower than Standard resolution.

**S.Fine:** Good for small print or artwork and transmits slower than Fine resolution.

**Photo:** Use when the original has varying shades of gray. This has the slowest transmission time.

## Manual and automatic fax Redial

---

If you are sending a fax manually and the line is busy, press **Redial/Pause**, and then press **Start** to try again. If you want to make a second call to the last number dialed, you can save time by pressing **Redial/Pause** and **Start**.

**Redial/Pause** only works if you dialed from the control panel.

*If you are sending a fax automatically* and the line is busy, the MFC will automatically redial one time after five minutes.



## Dual Access

You can dial a number, and begin scanning the fax into memory—even when the MFC is receiving, sending or printing a fax from memory. The LCD shows the new job number.

 If you get a **Out Of Memory** message while scanning the first page of a fax, press **Stop/Exit** to cancel scanning. If you get a **Out Of Memory** message while scanning a subsequent page, you can press **Start** to send the pages scanned so far, or press **Stop/Exit** to cancel the operation.

- 1** If it is not illuminated in green, press  (**Fax**). Place the original face up in the ADF, or face down on the scanner glass.
- 2** Enter the fax number.
- 3** Press **Start** to send the fax.

The MFC starts scanning the first page and the LCD shows the job number (#XXX) of the fax. You can repeat Steps 1 to 3 for the next fax.

—OR—

If you are using the scanner glass, go to Step 5.

- 4** To send a single page, press **2** (or press **Start** again).

The MFC starts sending the original.

—OR—

To send more than one page, press **1** and go to Step 5.

- 5** Place the next page on the scanner glass. Press **Set**.

The MFC starts scanning, and then returns to Step 4. (Repeat Steps 4 and 5 for each additional page). To send the next fax, go to Step 1.

Flatbed Fax: Next Page? ▲ 1.Yes ▼ 2.No (Send) Select ▲▼ & Set
---

Flatbed Fax: Set Next Page Then Press Set
---

# Real Time Transmission

When you are sending a fax, the MFC will scan the originals into the memory before sending. Then, as soon as the phone line is free, the MFC will start dialing and sending.



If the memory becomes full, the MFC will send the original in real time (even if Real Time TX is set to Off).

Sometimes, you may want to send an important original immediately, without waiting for memory transmission. You can set Real Time TX to On for all originals or for the next fax only.

If you want to fax multiple pages, use ADF.

**1** If it is not illuminated in green, press  (**Fax**). Place the original face up in the ADF, or face down on the scanner glass.

**2** Press **Menu**, **2**, **2**, **5**.

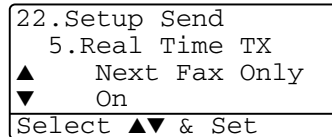

**3** To change the default setting, press  or  to select On (or Off).





Press **Set**.

Go to Step 5.

—OR—

For the next fax transmission only, press  or  to select Next Fax Only.

Press **Set**.

**4** Press  or  to select Next Fax: On (or Next Fax: Off).

Press **Set**.

**5** Press **1** if you want to choose more settings and the LCD will return to the Setup Send menu.

—OR—

Press **2** if you have finished choosing settings for this page, and then go to Step 6.

**6** Enter the fax number.

**7** Press **Start** to send the fax.





In Real Time Transmission using the scanner glass, the auto redial function doesn't work.

## Checking job status

---

Check which jobs are still waiting in the memory to be sent. (If there are no jobs, the LCD shows No Jobs Waiting.)

- 1 Press **Menu**, **2**, **6**.
- 2 If you have more than one job waiting, press  or  to scroll through the list.
- 3 Press **Stop/Exit**.

26.Remaining Jobs
▲ #001 12:34 BROTHER
#002 15:00 BIC
▼ #003 17:30 ABCDEFG
Select ▲▼ & Set

## Canceling a job while scanning the original



---

You can cancel a job while you are scanning it into memory by pressing **Stop/Exit**

## Canceling a scheduled job

---

You can cancel a fax job that is stored and waiting in memory. (See *Checking job status* on page 6-11.)

- 1 Press **Menu**, **2**, **6**.  
Any jobs that are waiting will appear on the LCD.
- 2 If you have more than two jobs waiting, press  or  to select the job you want to cancel.

Press **Set**.

—OR—

If you only have one job waiting, go to Step 3.

- 3 Press **1** to cancel.  
—OR—  
Press **2** to exit without canceling.  
To cancel another job go to Step 2.
- 4 Press **Stop/Exit**.

26.Remaining Jobs
▲ #001 12:34 BROTHER
#002 15:00 BIC
▼ #003 17:30 ABCDEFG
Select ▲▼ & Set

# Advanced sending operations

## Composing the electronic Cover Page

---

The Cover Page is created at the receiving machine. Your Cover Page includes the name stored in the One-Touch or Speed-Dial memory. If you're dialing manually, the name is left blank.

The Cover Page shows your Station ID and the number of pages you're sending. (See *Setting the Station ID* on page 4-2.) If you have Cover Page set to ON (**Menu, 2, 2, 7**), the number of pages is left blank.

You can select a comment to include on your Cover Page.

1. Comment Off
2. Please Call
3. Urgent
4. Confidential

Instead of using one of the preset comments, you can enter two personal messages of your own, up to 27 characters long. Use the chart on page 4-3 for help entering characters.

(See *Composing your own comments* on page 6-13.)

5. (User Defined)
6. (User Defined)



Most of the **Setup Send** settings are temporary to allow you to make changes for each fax you send. However, when you set up your Cover Page and Cover Page Comments, you are changing the default settings so they will be available while faxing.

## Composing your own comments

You can set up two comments of your own.

**1** If it is not illuminated in green, press  (**Fax**).

**2** Press **Menu, 2, 2, 8**.

**3** Press  or  to choose 5 or 6 for your own comment.

Press **Set**.

**4** Use the dial pad to enter your customized comment.

Press **Set**.

(See *Entering text* on page 4-3.)

**5** Press **1** if you want to choose more settings and the LCD will return to the *Setup Send* menu

—OR—





Press **2** to exit.

22.Setup Send
8.Coverpage Msg
▲ 5.
▼ 6.
Select ▲▼ & Set

## Cover page for the next fax only

This feature does not work without the Station ID. So make sure it has been set. (See *Setting the Station ID* on page 4-2.) If you only want to send a Cover Page with a particular fax, this Cover Page will include the number of pages in your original.

- 1 If it is not illuminated in green, press  (**Fax**). Place the original face up in the ADF, or face down on the scanner glass.
- 2 Press **Menu, 2, 2, 7**.
- 3 When LCD shows **Next Fax Only**.  
Press **Set**.

22.Setup Send
7.Coverpg Setup
▲ Next Fax Only
▼ On
Select ▲▼ & Set
- 4 Press  or  to select **Next Fax:On** (or **Next Fax:Off**).  
Press **Set**.
- 5 Press  or  to select one of the standard or your own comments.  
Press **Set**.
- 6 Enter two digits to show the number of pages you are sending.  
Press **Set**.  
(For example, press **0, 2** for 2 pages or enter **0 0** to leave the number of pages blank. If you make a mistake, press  to back up and re-enter the number of pages.)
- 7 Press **1** if you want to choose more settings and the LCD will return to the **Setup Send** menu  
—OR—  
Press **2** if you have finished choosing settings.
- 8 Enter the fax number you're calling.
- 9 Press **Start**.



## Send a cover page for all faxes

This feature does not work without the Station ID. Please be sure it has been set before continuing. (See *Setting the Station ID* on page 4-2.)

You can set the MFC to send a cover page whenever you send a fax. The number of pages in your fax is not included when you use this setting.

**1** If it is not illuminated in green, press  (**Fax**).

**2** Press **Menu, 2, 2, 7**.

**3** Press  or  to select **On**.  
Press **Set**.

**4** If you selected **On**, Press  or  to select one of the standard or your own comments.

Press **Set**.

**5** Press **1** if you want to choose more settings and the LCD will return to the **Setup Send** menu

—OR—

Press **2** to exit if you have finished choosing settings.



22.Setup Send
7.Coverpg Setup
▲ Next Fax Only
▼ On
Select ▲▼ & Set

## Using a printed cover page

If you prefer to use a printed cover page that you can write on, you can print the sample page and attach it to your fax.

**1** If it is not illuminated in green, press  (**Fax**).

**2** Press **Menu, 2, 2, 7**.

**3** Press  or  to select **Print Sample**.  
Press **Set**.

**4** Press **Start**. Your MFC prints a copy of your cover page.

**5** Press **Stop/Exit**.

22.Setup Send
7.Coverpg Setup
▲ On
▼ Print Sample
Select ▲▼ & Set

## Broadcasting

---

Broadcasting is when the same fax message is automatically sent to more than one fax number. Using the **Set** key, you can include Groups, One-Touch, Speed-Dial numbers and up to 50 manually dialed numbers. If you did not use up any of the numbers for Groups, access codes or credit card numbers, you can 'broadcast' faxes to as many as 390 different numbers. However, the available memory will vary depending on the types of jobs in the memory and the number of locations used for broadcasting. If you broadcast to the maximum numbers available, you will not be able to use Dual Access and Delayed fax.

To include One-Touch or Speed-Dial numbers and manually dialed numbers in the same broadcast, you must press **Set** between each of the numbers. Use **Search/Speed Dial** to help you choose the numbers easily.

(See *Setting up Groups for Broadcasting* on page 7-4.)

After the broadcast is finished, a Broadcast Report will be printed to let you know the results.

- Enter the long dialing sequence numbers as you would normally, but remember that each One-Touch and Speed-Dial number counts as one number, so the number of locations you can store becomes limited.
- If the memory is full, press **Stop/Exit** to stop the job or if more than one page has been scanned, press **Start** to send the portion that is in the memory.

- 1 If it is not illuminated in green, press  **(Fax)**. Place the original face up in the ADF, or face down on the scanner glass.
- 2 Enter a number using One-Touch, Speed-Dial, a Group number, Search or manual dialing using the dial pad.  
(Example: Group number)
- 3 When the LCD displays the fax number of the other party, press **Set**.  
You will be asked to press the next number.



- 4** Enter the next number.  
(Example: Speed-Dial number)
- 5** When the LCD displays the fax number of the other party, press **Set**.
- 6** Enter another fax number.  
(Example: Manual dialing using the dial pad.)
- 7** Press **Start**.  
If you are using the scanner glass, go to Step 8.
- 8** To send a single page,  
press **2** (or press **Start** again).  
The MFC starts sending the fax.  
—**OR**—  
To send more than one page, press **1** and go to Step 9.
- 9** Place the next page on the scanner glass.  
Press **Set**.  
The MFC starts scanning and returns to Step 8. (Repeat Step 8 and 9 for each additional page).



## Overseas Mode

---

If you are having difficulty sending a fax overseas due to possible interference on the phone line, we recommend that you turn on the Overseas Mode. After you send a fax using this feature, the feature will turn itself off.

**1** If it is not illuminated in green, press  (**Fax**). Place the original face up in the ADF, or face down on the scanner glass.

**2** Press **Menu**, **2**, **2**, **9**.

**3** Press  or  to select On (or Off).  
Press **Set**.

22.Setup Send
9.Overseas Mode
▲ On
▼ Off
Select ▲▼ & Set

**4** Press **1** if you want to choose more settings and the LCD will return to the Setup Send menu.

—OR—

Press **2** if you have finished choosing settings, and then go to Step 5

**5** Enter the fax number you're calling.

**6** Press **Start**.

If you are using the scanner glass, go to Step 7.

**7** To send a single page, press **2** (or press **Start** again).

The MFC starts sending the fax.

—OR—

To send more than one page, press **1** and go to Step 8.

**8** Place the next page on the scanner glass.

Press **Set**.

The MFC starts scanning and returns to Step 7. (Repeat Steps 7 and 8 for each additional page).

## Delayed Fax

During the day you can store up to 50 faxes in the memory to be sent within 24 hours. These faxes will be sent at the time of day you enter in Step 3. Press **Set** to accept it, or enter another time for the faxes to be sent.

**1** If it is not illuminated in green, press  (**Fax**). Place the original face up in the ADF, or face down on the scanner glass.

**2** Press **Menu**, **2**, **2**, **3**.

**3** Enter the time you want the fax to be sent (in 24-hour format).

Press **Set**.

(For example, enter 19:45 for 7:45 PM.)

22.Setup Send
3.Delayed Fax
Set Time=00:00
Enter & Set Key

**4** Press **1** if you want to choose more settings and the LCD will return to the Setup Send menu.

—OR—

Press **2** if you have finished choosing settings, and then go to Step 5.

**5** Enter the fax number.

**6** Press **Start**.

If you are using the scanner glass, go to Step 7.

**7** To send a single page, press **2** (or press **Start** again).

The MFC starts scanning the fax.

—OR—

To send more than one page, press **1** and go to Step 8.

**8** Place the next page on the scanner glass.

Press **Set**.

The MFC starts scanning and returns to Step 7. (Repeat Step 7 and 8 for each additional page).





*The number of pages you can scan into the memory depends on the amount of data that is printed on each page.*

# Delayed Batch Transmission

---



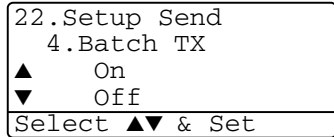

Before sending the delayed faxes, your MFC will help you economize by sorting all the faxes in the memory by destination and scheduled time. All delayed faxes that are scheduled to be sent at the same time to the same fax number will be sent as one fax to save transmission time.

- 1 If it is not illuminated in green, press  **(Fax)**.
- 2 Press **Menu, 2, 2, 4**.
- 3 Press  or  to select On (or Off).  
Press **Set**.
- 4 Press **Stop/Exit**.



## Setting up Polled Transmission

Polled Transmission is when you set up your MFC to wait with a paper original so another fax machine can call and retrieve it.

- 1** If it is not illuminated in green, press  (**Fax**). Place the original that is going to be retrieved face up in the ADF, or face down on the scanner glass.
  - 2** Press **Menu, 2, 2, 6**.
  - 3** Press  or  to choose **On** (or **Off**).  
Press **Set**.
- ```
22.Setup Send
  6.Polled TX
▲      On
▼      Off
Select ▲▼ & Set
```
- 4** Press **1** if you want to choose more settings and the LCD will return to the **Setup Send** menu.  
—OR—  
Press **2** if you have finished choosing settings, and go to step 5.
  - 5** Press **Start**. The MFC starts scanning the document.
  - 6** If you place the original in the ADF, wait for the fax to be polled.  
—OR—  
If you are using the scanner glass, go to Step 7.
  - 7** To send a single page, press **2** (or press **Start** again), wait for the fax to be polled.  
—OR—  
To send more than one page, press **1** and go to Step 8.
  - 8** Place the next page on the scanner glass.  
Press **Set**.  
The MFC starts scanning and returns to Step 7. (Repeat Step 7 and 8 for each additional page).
-  The document will be stored and can be retrieved from any other fax machine until you delete the fax in memory by using the **Cancelling a Job** function. (See *Cancelling a scheduled job* on page 6-11.)

# Memory Security

Memory Security lets you prevent unauthorized access to the MFC. The MFC will not send faxes or print received faxes without the password you program. You will not be able to continue to schedule Delayed Faxes or Polling jobs. However, any pre-scheduled Delayed Faxes will be sent when you turn Memory Security **On**, so they won't be lost.

If Fax Storage is **On** *before* you turn Memory Security **On**, then Fax Forwarding and Remote Retrieval will continue to work.

While Memory Security is **On** the following operations are available:

- Receiving faxes into memory (limited by memory capacity)
- Fax Forwarding (If Fax Storage was already **On**)
- Remote Retrieval



To print the faxes in memory, turn Memory Security **Off**.

## Setting up the password



If you forget the Memory Security password, please call Brother Customer Service. (See *For Customer Service* on page i.)



- 1** Press **Menu**, **2**, **0**, **1**.
- 2** Enter a 4-digit number for the password.  
Press **Set**.

|                  |
|------------------|
| 20.Miscellaneous |
| 1.Mem Security   |
|                  |
| New Passwd=xxxx  |
| Enter & Set Key  |

If you are entering the password for the first time, the LCD shows *Verify*.

- 3** Re-enter the password.  
Press **Set**.

## Turning Memory Security on

- 1 Press **Menu**, **2**, **0**, **1**.
- 2 Press  or  to select **Set Security**.

|                  |
|------------------|
| 20.Miscellaneous |
| 1.Mem Security   |
| ▲ Set Security   |
| ▼ Set Password   |
| Select ▲▼ & Set  |

- 2 Press **Set**.
- 3 Enter the registered 4-digit password.
- Press **Set**.

The MFC goes offline and the LCD shows *Secure Mode*.



If there is a power failure, the data in the memory will remain for up to 4 days.

## Turning Memory Security off

---

- 1 Press **Menu**.  
Enter the registered 4-digit password and press **Set**.
- 2 Memory Security is automatically turned off and the LCD shows the *Date and Time*.



If you enter the wrong Password, the LCD shows *Wrong Password* and stays offline. The MFC will stay in *Secure Mode* until the registered password is entered.

# 7

## Auto Dial numbers and dialing options

### Storing numbers for easy dialing

You can set up your MFC to do three types of easy dialing: One-Touch, Speed-Dial and Groups for Broadcasting faxes.

 If you lose electrical power, the auto dial numbers that are in the memory will not be lost.

### Storing One-Touch Dial numbers

Your MFC has 20 One-Touch keys where you can store 40 fax or phone numbers for automatic dialing. To access numbers 21 to 40, hold down **Shift** as you press the One-Touch key. When you press a One-Touch key the LCD shows the name, if you stored it, or the number. (See *One-Touch Dialing* on page 7-5.)

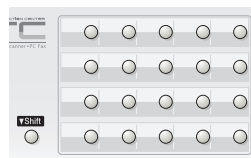

*One-Touch keys are the 20 keys (numbers 01–40) located on the left side of the control panel.*



 (For USA only) The Brother fax back system number has been preprogrammed on One-Touch key 1.

- 1 Press **Menu**, **2**, **3**, **1**.
- 2 Press the One-Touch key where you want to store a number.

If you have not installed the optional LAN board (NC-9100h), go to Step 4.

—OR—

If you are using the MFC-8820DN or have installed the optional LAN board (NC-9100h), the MFC will ask you if the One-Touch key is for a fax/telephone number or an e-mail address. Go to Step 3.

- 3 Press  or  to select Fax/Tel.  
Press **Set**.

```
23.Set Auto Dial
  1.One-Touch Dial
One-Touch:
Select One-Touch
```

```
23.Set Auto Dial
 *007
▲ Fax/Tel
▼ E-Address
Select ▲▼ & Set
```



- 4 Enter a number (up to 20 digits).  
Press **Set**.
  - If you want to enter a pause in the dialing sequence (for example, to access an outside line), press **Redial/Pause** as you are entering the digits. Each key press of **Redial/Pause** enters a 3.5 second pause when the number is dialed, and a dash appears on the screen.
- 5 Use the dial pad to enter the name (up to 15 characters).  
Press **Set**.  
(You can use the chart on page 4-3 to help you enter letters.)  
—OR—  
Press **Set** to store the number without a name.
- 6 Go to Step 2 to store another One-Touch number  
—OR—  
Press **Stop/Exit**.  
When you dial an auto dial number, the LCD shows the name and number you've stored, or, if you haven't stored a name, only the number you've stored.

## Storing Speed-Dial numbers

You can store Speed-Dial numbers, so that when you dial you will only have to press a few keys (**Search/Speed Dial**, **#**, the three-digit number, and **Start**). The MFC can store 300 Speed-Dial numbers.



- 1 Press **Menu**, **2**, **3**, **2**.
- 2 Use the dial pad to enter a three-digit Speed-Dial number (001-300).  
(For example, press **005**.)  
Press **Set**.

|                                  |
|----------------------------------|
| 23.Set Auto Dial<br>2.Speed-Dial |
| Speed-Dial? #                    |
| Enter & Set Key                  |

If you have not installed the optional LAN board (NC-9100h), go to Step 4.

—OR—

If you are using the MFC-8820DN or have installed the optional LAN board (NC-9100h), the MFC will ask you if the Speed-Dial is for a fax/telephone number or an e-mail address. Go to Step 3.

- 3 Press  or  to select Fax/Tel.  
Press **Set**.

|                          |
|--------------------------|
| 23.Set Auto Dial<br>#100 |
| ▲ Fax/Tel                |
| ▼ E-Address              |
| Select ▲▼ & Set          |

- 4 Enter the phone or fax number (up to 20 digits).  
Press **Set**.
- 5 Use the dial pad to enter the name (up to 15 characters).  
Press **Set**.  
(You can use the chart on page 4-3 to help you enter letters.)  
—OR—  
Press **Set** to store the number without a name.
- 6 Go to Step 2 to store another Speed-Dial number.  
—OR—  
Press **Stop/Exit**.





## Changing One-Touch and Speed-Dial numbers

---

If you try to store a One-Touch or Speed-Dial number where a number has already been stored, the LCD will show the name that has been stored there (or number) and will ask you to do one of the following:

- 1 Press **1** to change the stored number.  
—OR—  
Press **2** to exit without making a change.

|                  |
|------------------|
| 23.Set Auto Dial |
| *005:MIKE        |
| ▲ 1.Change       |
| ▼ 2.Exit         |
| Select ▲▼ & Set  |

- 2 Enter a new number.  
Press **Set**.
  - To erase the whole number or whole name, press **Clear/Black** repeatedly until all digits or letters are deleted.  
To erase one digit or letter, use  or  to position the cursor under it, and then press **Clear/Black**.
  - If you want to insert characters, use  or  to position the cursor where you want to insert them, and then type.
- 3 Follow the directions beginning at Step 4 in Storing One-Touch Dial numbers and Storing Speed-Dial numbers. (See *Storing One-Touch Dial numbers* on page 7-1 and *Storing Speed-Dial numbers* on page 7-2.)

# Setting up Groups for Broadcasting

Groups, which can be stored on a One-Touch key or a Speed-Dial location, allow you to send the same fax message to many fax numbers by pressing only a One-Touch key and **Start** or **Search/Speed Dial**, #, the three-digit location and **Start**.

First, you'll need to store each fax number as a One-Touch or Speed-Dial number. Then, you can combine them into a Group, *Each Group uses up a One-Touch key or a Speed-Dial location*. Finally, you can have up to six small Groups, or you can assign up to 339 numbers to one large Group.

(See *Storing Speed-Dial numbers* on page 7-2 and *Changing One-Touch and Speed-Dial numbers* on page 7-3.)

**1** Press **Menu**, **2**, **3**, **3**.

**2** Decide where you wish to store the Group

—**AND**—

Press a One-Touch key

—**OR**—

Press **Search/Speed Dial** and enter the three-digit location, and then press **Set**.

(For example, press One-Touch key 2 for Group 1.)

**3** Use the dial pad to enter the Group number.

Press **Set**.

(For example, press **1** for Group 1.)

**4** To include One-Touch or Speed-Dial numbers in the Group, enter them as if you were dialing.

For example, for One-Touch key **05**, press One-Touch key **05**. For Speed-Dial location 009, press **Search/Speed Dial**, then press **009** on the dial pad. The LCD shows \* 005, #009.

**5** Press **Set** to accept the numbers for this Group.

**6** Use the dial pad and the chart on page 4-3 to enter a name for the Group.

Press **Set**.

(For example, NEW CLIENTS)

```
23.Set Auto Dial
  3.Setup Groups
```

```
Group Dial:
Press Speed-Dial...
```

```
23.Set Auto Dial
  *002
```

```
Group#:0
Enter No. & Set
```

## 7 Press **Stop/Exit**.

 You can print a list of all One-Touch and Speed-Dial numbers. (See *Printing reports* on page 9-3.) Group numbers will be marked in the column of 'Group'.

## Dialing options









 When you dial using an auto dial number, the LCD shows the name you've stored, or if you haven't stored a name, the fax number you've stored.

## Search

---

You can search for names you have stored in the One-Touch and Speed-Dial memory.

(See *Storing One-Touch Dial numbers* on page 7-1 and see *Storing Speed-Dial numbers* on page 7-2.)

- 1 If it is not illuminated in green, press  (**Fax**). Place the original face up in the ADF, or face down on the scanner glass.
- 2 Press **Search/Speed Dial**.
- 3 Press  or .  
To search alphabetically through the names that are stored, enter the first letter of the name you're looking for and press  or .  
—OR—  
Press  or .  
To search for numbers numerically, press  or .
- 4 When the LCD shows the name you want to call, Press **Start**.

## One-Touch Dialing

---

- 1 If it is not illuminated in green, press  (**Fax**). Place the original face up in the ADF, or face down on the scanner glass.
- 2 Press the One-Touch key of the location you want to call.
- 3 Press **Start**.

## Speed-Dialing

---

- 1** If it is not illuminated in green, press  (**Fax**). Place the original face up in the ADF, or face down on the scanner glass.
- 2** Press **Search/Speed Dial**, #, and then the three-digit Speed-Dial number. (See *Storing Speed-Dial numbers* on page 7-2.)
- 3** Press **Start**.



If you try to use a One-Touch or Speed-Dial location with no number stored in it, you hear a warning sound, and LCD shows **Not Registered**. The LCD returns to normal after 2 seconds.

## Manual dialing

---

Manual dialing means pressing all of the digits of the phone number.

## Using an external telephone

---

The easiest way to use your external telephone is to pick up the handset and dial the number on the external telephone as you normally would.

- 1** Pick up the handset of the external telephone.
- 2** Dial the number on the external telephone.
- 3** To hang up, replace the handset.

## Access codes and credit card numbers

---

Sometimes you may want to choose from several long distance carriers when you make a call. Rates may vary depending on the time and destination. To take advantage of low rates, you can store the access codes or long-distance carriers and credit card numbers as One-Touch and Speed-Dial numbers. You can store these long dialing sequences by dividing them and setting them up on separate keys in any combination. You can even include manual dialing using the dial pad.

The combined number will be dialed in the order that you entered it as soon as you press **Start**.

(See *Storing One-Touch Dial numbers* on page 7-1.)

For example, you can store '555' on One-Touch key **03** and '7000' on One-Touch key **02**. If you press One-Touch key **03**, One-Touch key **02**, and **Start**, you will dial '555-7000'.

To temporarily change a number, you can substitute part of the number with manual dialing using the dial pad.

For example, to change the number to 555-7001 you could press One-Touch key **03** and then press **7001** using the dialing pad.



If you must wait for another dial tone or signal at any point in the dialing sequence, store a pause there in the number by pressing **Redial/Pause**. Each key press adds a 3.5-second delay.

## Pause

---

Press **Redial/Pause** to insert a 3.5-second pause between numbers. If you are dialing overseas, you can press **Redial/Pause** as many times as needed to increase the length of the pause.

## Tone or Pulse (Canada only)

---

If you have a Pulse dialing service, but need to send Tone signals (for example, for telephone banking), follow the instructions below. If you have Touch Tone service, you will not need this feature to send tone signals.

- 1** Lift the handset of an external phone.
- 2** Press **#** on the control panel of your MFC. Any digits dialed after this will send tone signals.
- 3** When you hang up, the MFC will return to the Pulse dialing service.

# 8

# Remote Fax Options



## Fax Forwarding/Paging



*You cannot use Paging and Fax Forwarding at the same time. After you have selected the Paging or Fax Forwarding feature, Fax Storage is set to On automatically.*

## Programming a Fax Forwarding number

When Fax Forwarding is set to **On**, your MFC stores the received fax in the memory. Then it dials the fax number you've programmed and forwards the fax message.

- 1** Press **Menu**, **2**, **5**, **1**.
- 2** Press  or  to select **Fax Forward**. Press **Set**.

|                   |
|-------------------|
| 25.Remote Fax Opt |
| 1.Fax Fwd/Paging  |
| ▲ Off             |
| ▼ Fax Forward     |
| Select ▲▼ & Set   |

The LCD will ask you to enter the fax number to which faxes will be forwarded.



- 3** Enter the forwarding number (up to 20 digits). Press **Set**.
- 4** Press **Stop/Exit**.



## Programming your pager number

When Paging is selected, your MFC dials the pager number you've programmed, and then dials your Personal Identification Number (PIN). This activates your pager so you will know that you have a fax message in the memory.

**1** Press **Menu, 2, 5, 1.**

**2** Press  or  to select Paging.  
Press **Set.**

|                   |
|-------------------|
| 25.Remote Fax Opt |
| 1.Fax Fwd/Paging  |
| ▲ Off             |
| ▼ Fax Forward     |
| Select ▲▼ & Set   |

**3** Enter your pager phone number followed by ## (up to 20 digits).  
Press **Set.**

Do not include the area code if it is the same as that of your MFC.  
For example, press **1 8 0 0 5 5 5 1 2 1 2 # #.**

**4** If your pager needs a PIN, enter the PIN, press #, press **Redial/Pause,**  
enter your fax number followed by # #.  
Press **Set.**

(For example, press **1 2 3 4 5 # Redial/Pause 1 8 0 0 5 5 5 1 2 1 2 # #)**

—OR—

If you do not need a PIN, press **Redial/Pause,** enter your fax number followed by # #.

Press **Set.**

(For example, press **Redial/Pause 1 8 0 0 5 5 5 1 2 1 2 # #)**

**5** Press **Stop/Exit.**



You cannot change a Paging number or PIN remotely.

# Setting Fax Storage

If you set Fax Storage to ON, you will be able to retrieve fax messages from another location using Fax Forwarding, Paging, or Remote Retrieval operations. If there is paper in your MFC, a back-up copy of each fax will be printed. The LCD will show when you have a fax stored in memory.

**1** Press **Menu, 2, 5, 2**.

The LCD will ask you to choose a fax setting.

**2** Press  or  to select On (or Off).

Press **Set**.

**3** Press **Stop/Exit**.

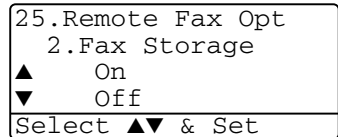

 If there are faxes in the memory when you turn Fax Storage OFF, the LCD will ask if you want to erase the faxes in the memory.

If you press **1**, all fax data is erased and Fax Storage is turned off.

If you press **2**, faxes are not erased and Fax Storage stays on.

(See *Printing a fax from the memory* on page 5-5.)

-  ■ After you have selected Paging or Fax Forwarding feature, Fax Storage is set to **On** automatically. If you bring Paging or Fax Forwarding feature back to **Off**, Fax Storage stays on.
- If there is a power failure, the data in the memory will remain for up to 4 days.

# Setting your Remote Access Code

The remote access code lets you access the Remote Retrieval features when you are away from your MFC. Before you use the remote access and retrieval features, you have to set up your own code. The default code is inactive code (--- \*).

- 1 Press **Menu**, **2**, **5**, **3**.
- 2 Enter a three-digit code using numbers **0-9**, **\*** or **#**. Press **Set**. (The preset '**\***' cannot be changed.)

|                                                                                 |
|---------------------------------------------------------------------------------|
| 25.Remote Fax Opt<br>3.Remote Access<br><br>Access Code:---*<br>Enter & Set key |
|---------------------------------------------------------------------------------|



Do not use the same digits that appear in your Fax Receive Code( \* **51**) or Telephone Answer Code (**#51**). (See *Operation from extension telephones* on page 5-7.)

- 3 Press **Stop/Exit**.



■ You can change your code at any time by entering a new one. If you want to make your code inactive, press **Clear/Back** in Step 2 to restore the inactive setting (--- \*).

# Remote Retrieval

You can call your MFC from any telephone or fax machine using touch tone, then use the Remote Access Code and remote commands to retrieve fax messages. Be sure to cut out the Remote Retrieval Access Card on the last page and keep it with you at all times.

## Using your Remote Access Code

---

- 1** Dial your fax number from a telephone or another fax machine using touch tone.
- 2** When your MFC answers, immediately enter your Remote Access Code (3 digits followed by \* ).
- 3** The MFC signals if it has received fax messages:  
**1 long beep — Fax messages**  
**No beeps — No fax messages**
- 4** The MFC gives two short beeps, which tells you to enter a command. The MFC will hang up if you wait longer than 30 seconds to enter a command. The MFC will beep three times, if you enter an invalid command.
- 5** Press **90** to reset the MFC when you've finished.
- 6** Hang up.



If your MFC is set to *Manual* mode and you want to use the remote retrieval features, you can access your MFC by waiting about 2 minutes after it starts ringing, and then entering the Remote Access Code within 30 seconds.

## Remote commands

Follow the commands below to access features when you are away from the MFC. When you call the MFC and enter your Remote Access Code (3 digits followed by \*), the system will give two short beeps and you must enter a remote command.

| Remote commands                                        | Operation details                                                                                                                                                                                                                                                                                                                                                                                                   |
|--------------------------------------------------------|---------------------------------------------------------------------------------------------------------------------------------------------------------------------------------------------------------------------------------------------------------------------------------------------------------------------------------------------------------------------------------------------------------------------|
| <b>95 Change the Fax Forwarding or Paging settings</b> |                                                                                                                                                                                                                                                                                                                                                                                                                     |
| 1 OFF                                                  | If you hear one long beep, the change has been accepted. If you hear three short beeps, you cannot change it because the conditions have not been met (for example, registering a fax forwarding or paging number). You can register your Fax Forwarding number by entering 4. (See <i>Changing your Fax Forwarding number</i> on page 8-7). Once you have registered the number, Fax Forwarding will be set to On. |
| 2 Fax Forwarding                                       |                                                                                                                                                                                                                                                                                                                                                                                                                     |
| 3 Paging                                               |                                                                                                                                                                                                                                                                                                                                                                                                                     |
| 4 Fax Forwarding number                                |                                                                                                                                                                                                                                                                                                                                                                                                                     |
| 6 Fax Storage ON                                       | You can turn Fax Storage to On (or Off after you have retrieved or erased all your messages).                                                                                                                                                                                                                                                                                                                       |
| 7 Fax Storage OFF                                      |                                                                                                                                                                                                                                                                                                                                                                                                                     |
| <b>96 Retrieve a fax</b>                               |                                                                                                                                                                                                                                                                                                                                                                                                                     |
| 2 Retrieve all faxes                                   | Enter the number of a remote fax machine to receive stored fax messages. (See <i>Retrieving fax messages</i> on page 8-7.)                                                                                                                                                                                                                                                                                          |
| 3 Erase faxes from the memory                          | If you hear one long beep, you can erase fax messages from the memory.                                                                                                                                                                                                                                                                                                                                              |
| <b>97 Check the receiving status</b>                   |                                                                                                                                                                                                                                                                                                                                                                                                                     |
| 1 Fax                                                  | You can check whether your MFC has received any faxes. If it has, you will hear one long beep. If it hasn't, you will hear three short beeps.                                                                                                                                                                                                                                                                       |
| <b>98 Change the Receive Mode</b>                      |                                                                                                                                                                                                                                                                                                                                                                                                                     |
| 1 External TAD                                         | If you hear one long beep, you can change the Receive Mode.                                                                                                                                                                                                                                                                                                                                                         |
| 2 Fax/Tel                                              |                                                                                                                                                                                                                                                                                                                                                                                                                     |
| 3 Fax Only                                             |                                                                                                                                                                                                                                                                                                                                                                                                                     |
| <b>90 Exit</b>                                         | After a long beep, you can exit Remote Retrieval.                                                                                                                                                                                                                                                                                                                                                                   |

## Retrieving fax messages

---

- 1 Dial your fax number.
  - 2 When your MFC answers, immediately enter your Remote Access Code (3 digits followed by \* ). If you hear one long beep, you have messages.
  - 3 As soon as you hear two short beeps, use the dial pad to press **962**.
  - 4 Wait for the long beep, and then use the dial pad to enter the number of the remote fax machine where you want your fax messages sent to followed by ## (up to 20 digits).
-  You cannot use \* and # as dial numbers. However, press # if you want to store a pause.
- 5 Hang up after you hear your MFC beep. Your MFC will call the other machine, which will then print your fax messages.

## Changing your Fax Forwarding number

---

You can change the default setting of your fax forwarding number from another telephone or fax machine using Touch Tone.

- 1 Dial your fax number.
  - 2 When your MFC answers, immediately enter your Remote Access Code (3 digits followed by \* ). If you hear one long beep, you have messages.
  - 3 When you hear two short beeps, use the dial pad to press **954**.
  - 4 Wait for the long beep, and then use the dial pad to enter the new number of the remote fax machine where you want your fax messages forwarded followed by ## (up to 20 digits).
-  You cannot use \* and # as dial numbers. However, press # if you want to store a pause.
- 5 Hang up after you hear your MFC beep.

# 9 Printing reports

## MFC settings and activity

You need to set up the Transmission Verification Report and Activity Report Interval in the menu table.

Press **Menu, 2, 4, 1.**

—OR—

Press **Menu, 2, 4, 2.**

|                  |
|------------------|
| 24.Setup Reports |
| 1.Transmission   |
| 2.Act.Interval   |
| Select ▲▼ & Set  |

## Customizing the Transmission Verification Report

---



You can use the Transmission Report as proof that you sent a fax. This report lists the time and date of transmission and whether the transmission was successful (OK). If you select **On** or **On+Image**, the report will print for every fax you send.

If you send a lot of faxes to the same place, you may need more than the job numbers to know which faxes you must send again. Selecting **On+Image** or **Off+Image** will print a section of the fax's first page on the report to help you remember.



When the feature is **Off**, the Report will only print if there is a transmission error. (NG).

**1** Press **Menu, 2, 4, 1.**

**2** Press  or  to select **Off**, **Off+Image**, **ON** or **On+Image**.

Press **Set**.

**3** Press **Stop/Exit.**

|                  |
|------------------|
| 24.Setup Reports |
| 1.Transmission   |
| ▲ Off            |
| ▼ Off+Image      |
| Select ▲▼ & Set  |

# Setting the Fax Activity Report Interval

You can set the MFC to print activity reports at specific intervals (every 50 faxes, 6, 12 or 24 hours, 2 or 7 days). If you set the interval to *Off*, you can print the report by following the Steps on the next page. The default setting is *Every 50 Faxes*.

**1** Press **Menu**, **2**, **4**, **2**.

**2** Press  or  to choose an interval. Press **Set**.

(If you choose 7 days, the LCD will ask you to choose a day on which to begin the 7-day countdown.)

**3** Enter the time to begin printing in 24-hour format. Press **Set**.

(For example: enter 19:45 for 7:45 PM.)

**4** Press **Stop/Exit**.

|                  |
|------------------|
| 24.Setup Reports |
| 2.Act.Interval   |
| ▲ Every 50 Faxes |
| ▼ Every 6 hours  |
| Select ▲▼ & Set  |



If you select 6, 12, 24 hours, 2 or 7 days, the MFC will print the report at the selected time and then erase all jobs from its memory. If the MFC's memory becomes full with 200 jobs before the time you selected has passed, the MFC will print the Activity Report early and then erase all jobs from memory. If you want an extra report before it is due to print, you can print it without erasing the jobs from memory.



If you select *Every 50 Faxes*, the MFC will print the Activity Report when the MFC has stored 50 jobs.



# Printing reports



---

Five reports are available:

- |                 |                                                                                                           |
|-----------------|-----------------------------------------------------------------------------------------------------------|
| 1.Help List     | Prints the Help List so you can see at-a-glance how to quickly program your MFC.                          |
| 2.Auto Dial     | Lists names and numbers stored in the One-Touch and Speed-Dial memory, in numerical order.                |
| 3.Fax Activity  | Lists information about the last incoming and outgoing faxes.<br>(TX means Transmit.) (RX means Receive.) |
| 4.Transmission  | Prints a Transmission Verification Report for your last transmission.                                     |
| 5.User Settings | Lists your settings.                                                                                      |

## To print a report

**1** Press **Menu**, **5**.

**2** Press  or  to select the report you want.  
Press **Set**.

**—OR—**

Enter the number of the report you want to print.  
For example, press **1** to print the Help List.

**3** Press **Start**.



# 10 Making copies

## Using the MFC as a copier

You can use your MFC as a copier, making up to 99 copies at a time.

### Enter Copy mode

---

Before making copies, make sure that  (**Copy**) is illuminated in green. If it is not, press  (**Copy**) to enter **Copy** mode. The default setting is Fax. You can change the number of seconds or minutes that the MFC stays in Copy mode after a copy operation. (See *Setting the Mode Timer* on page 4-5.)

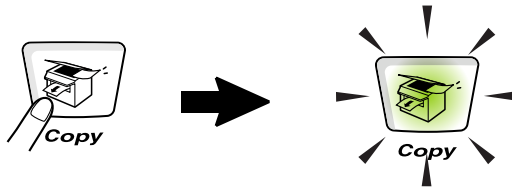

The printable area of your MFC begins at approximately 0.14 in. (3.64 mm) from both sides and 0.12 in. (3 mm) from the top or bottom of the paper.

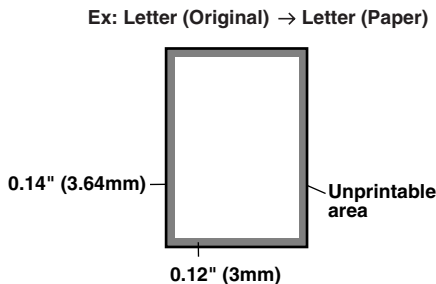

## Temporary copy settings

You can improve your copies by using the Temporary Copy Keys: **Enlarge/Reduce**, **Contrast**, **Quality**, **Tray Select**, **Sort** and **N in 1** (For MFC-8420) or **Duplex/N in 1** (For MFC-8820D and MFC-8820DN). These settings are *temporary*, and the MFC returns to Fax mode 1 minute after it finishes copying. If you want to use these temporary settings again, place the next original in the ADF or on the scanner glass within that time. However, if you have set the Mode Timer for Copy and Scan modes to 0 to 30 seconds, the MFC returns to the default settings after the number of seconds that has been set for Mode Timer. (See *Setting the Mode Timer* on page 4-5 and see *Using the copy keys (Temporary settings)* on page 10-6.)

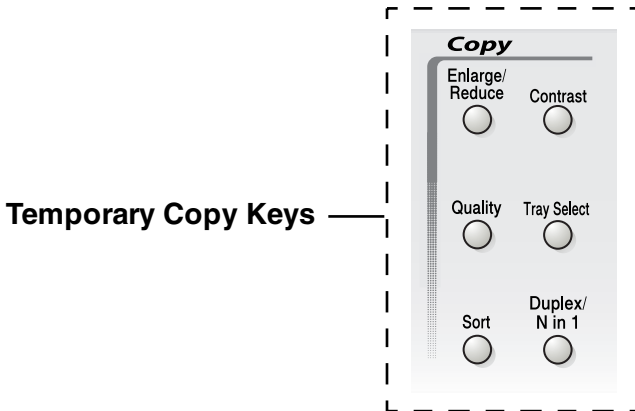

While the MFC is copying, incoming faxes will be received into the memory instead of being printed.

## Making a single copy from the ADF

---

**1** Press  (**Copy**) to illuminate it in green. Place the original face up in the ADF.

**2** Press **Start**.

Do **NOT** pull on the original while copying is in progress.



To stop copying and eject the original, press **Stop/Exit**.

## Making multiple copies from the ADF

---

**1** Press  (**Copy**) to illuminate it in green. Insert the original face up in the ADF.

**2** Use the dial pad to enter the number of copies you want (up to 99).

**3** Press **Start**.



To sort the copies, press the **Sort** key.

## Single or multiple copies using the scanner glass

You can make multiple copies using the scanner glass. Multiple copies will be stacked (all copies of page 1, then all copies of page 2, and so on). Use the Temporary Copy keys to choose more settings. (See *Using the copy keys (Temporary settings)* on page 10-6.)

- 1 Press  (**Copy**) to illuminate it in green. Lift the Document Cover.

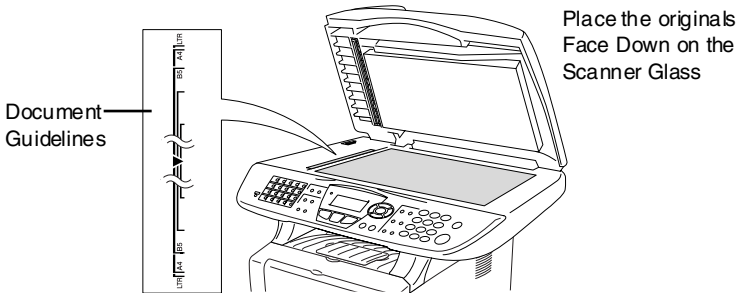

- 2 Using the document guidelines on the left, center the original face down on the scanner glass and close the document cover.
- 3 Using the dial pad, enter the number of copies you want (up to 99).  
For example, press **3 8** for 38 copies.
- 4 Press **Start**.  
The MFC will start scanning the original.

 If you want to sort multiple copies, use the ADF.  
(See *Making a single copy from the ADF* on page 10-3.)

## Out of Memory message

---

If the memory becomes full while you are making copies, the LCD message will guide you through the next step.

|                   |
|-------------------|
| Out of Memory     |
| Copy: Press Start |
| Quit: Press Stop  |
|                   |

If the `Out Of Memory` message appears, press **Stop/Exit** to cancel or **Start** to copy scanned pages. You will need to clear some jobs from the memory before you can continue.



To gain extra memory, you can turn off Fax Storage. (See *Setting Fax Storage* on page 8-3.)

—OR—

Print the faxes that are in the memory. (See *Printing a fax from the memory* on page 5-5.)

When you get an `Out Of Memory` message, you may be able to make copies if you first print incoming faxes in the memory to restore the memory to 100%.



Then if this error message appears more than once you may wish to consider increasing the memory size. For more information on how to increase the memory size, See *Memory board* on page 23-1.

# Using the copy keys (Temporary settings)

When you want to change the settings only for the next copy, use the Temporary Copy Keys.

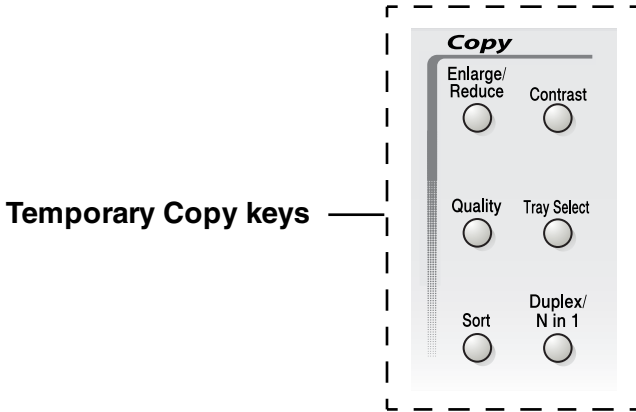

You can use different combinations. The large LCD shows your current Copy mode settings.

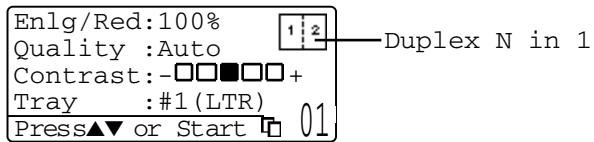

Example of Copy mode LCD

# Enlarge/Reduce



You can select the following enlargement or reduction ratios.

**Auto** sets the MFC to calculate the reduction ratio that fits the size of your paper.

**Custom** allows you to enter a ratio from 25% to 400%.



| Press <b>Enlarge/Reduce</b>                                                       |                    |
|-----------------------------------------------------------------------------------|--------------------|
|  | 100%               |
|                                                                                   | 104% (EXE → LTR)   |
|                                                                                   | 141% (A5 → A4)     |
|                                                                                   | 200%               |
|                                                                                   | Auto               |
|                                                                                   | Custom (25 - 400%) |
|                                                                                   | 50%                |
|                                                                                   | 70% (A4 → A5)      |
|                                                                                   | 78% (LGL → LTR)    |
|                                                                                   | 83% (LGL → A4)     |
|                                                                                   | 85% (LTR → EXE)    |
|                                                                                   | 91% (Full Page)    |
|                                                                                   | 94% (A4 → LTR)     |
|                                                                                   | 97% (LTR → A4)     |

 **Auto** appears only when you place the original in the ADF.

- 1 Press  (**Copy**) to illuminate it in green. Place the original face up in the ADF, or face down on the scanner glass.
- 2 Use the dial pad to enter the number of copies you want (up to 99).
- 3 Press **Enlarge/Reduce**.
- 4 Press **Enlarge/Reduce** or .

|                  |    |
|------------------|----|
| Enlg/Red:100%    |    |
| Quality :Auto    |    |
| Contrast:-□□■□□+ |    |
| Tray :#1 (LTR)   | 01 |



**5** Press  or  to select the enlargement or reduction ratio you want.

Press **Set**.

—OR—

You can select **Custom** and press **Set**.

Use the dial pad to enter an enlargement or reduction ratio from 25% to 400%.

Press **Set**.

(For example, press **5 3** to enter 53%.)

**6** Press **Start**.

—OR—

Press other temporary copy keys for more settings.



■ Special Copy Options (2in1, 4in1 or Poster) are not available with **Enlarge/Reduce**.

■ **Auto** is not available with the scanner glass.

## Quality (type of original)



---

You can select the Quality for your type of original. The default setting is **Auto**, which is used for originals that contain both text and photographs. **Text** is used for originals containing only text. **Photo** is used for copying photographs.

**1** Press  (**Copy**) to illuminate it in green. Place the original face up in the ADF, or face down on the scanner glass.

**2** Use the dial pad to enter the number of copies you want (up to 99).

**3** Press **Quality**.

**4** Press  or  to choose the type of original (**Auto**, **Text** or **Photo**).

Press **Set**.

**5** Press **Start**.

—OR—

Press other Temporary Copy keys for more settings.



## Sorting copies using the ADF

If you want to sort multiple copies, use the ADF. Pages will be printed in the order 123, 123, 123, and so on.

- 1 Press  (**Copy**) to illuminate it in green. Place the original face up in the ADF.
- 2 Use the dial pad to enter the number of copies you want (up to 99).
- 3 Press **Sort**.
- 4 Press **Start**.  
—OR—  
Press other Temporary Copy keys for more settings.

## Contrast

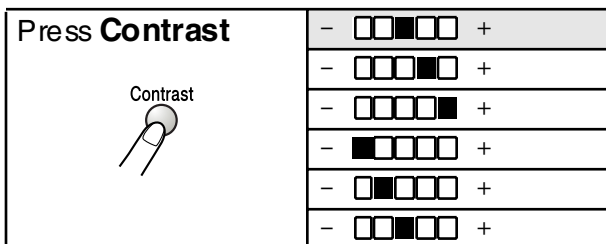

You can adjust copy contrast to make copies darker or lighter.

- 1 Press  (**Copy**) to illuminate it in green. Place the original face up in the ADF, or face down on the scanner glass.
- 2 Use the dial pad to enter the number of copies you want (up to 99).
- 3 Press **Contrast**.
- 4 Press  to make a copy lighter  
—OR—  
Press  to make a copy darker.  
Press **Set**.
- 5 Press **Start**.  
—OR—  
Press other Temporary Copy keys for more settings.



# Tray Select

You can change the tray use only for the next copy.

- 1 Press  (**Copy**) to illuminate it in green. Place the original face up in the ADF, or face down on the scanner glass.
- 2 Use the dial pad to enter the number of copies you want (up to 99).
- 3 Press **Tray Select**.
- 4 Press  or  to select the tray usage. Press **Set**.
- 5 Press **Start**.  
—OR—  
Press other Temporary Copy keys for more settings.

(For MFC-8420 with the optional paper tray #2)

|                                                                                                                   |            |
|-------------------------------------------------------------------------------------------------------------------|------------|
| Press <b>Tray Select</b><br><br> | Auto       |
|                                                                                                                   | #1 (XXX) * |
|                                                                                                                   | #2 (XXX) * |

(For MFC-8820D and MFC-8820DN with the optional paper tray #2)





































|                                                                                                                     |            |
|---------------------------------------------------------------------------------------------------------------------|------------|
| Press <b>Tray Select</b><br><br> | Auto       |
|                                                                                                                     | #1 (XXX) * |
|                                                                                                                     | #2 (XXX) * |
|                                                                                                                     | MP Tray    |

\* XXX is the paper size you set in **Menu, 1. 3**.

 For MFC-8420 the LCD displays the tray use selections only if the optional paper tray is installed.

# Duplex/N in 1

'Duplex' prints on both sides of the paper.

| Temporary key                                                                                                                                                                                                           | Level 1                                  | Level 2    | Option                                                                                                                                                                    | original → Finished Layout                                                                                                                                                |                                                                                                                                                                       |
|-------------------------------------------------------------------------------------------------------------------------------------------------------------------------------------------------------------------------|------------------------------------------|------------|---------------------------------------------------------------------------------------------------------------------------------------------------------------------------|---------------------------------------------------------------------------------------------------------------------------------------------------------------------------|-----------------------------------------------------------------------------------------------------------------------------------------------------------------------|
| Press<br><b>Duplex/N in 1</b><br>(MFC-8820D/<br>8820DN)<br><b>N in 1</b><br>(MFC-8420)<br><br><b>Duplex/<br/>           N in 1</b><br> | N in 1                                   | —          | 2 in 1 (P)                                                                                                                                                                |  →      |                                                                                                                                                                       |
|                                                                                                                                                                                                                         |                                          | —          | 2 in 1 (L)                                                                                                                                                                |  →      |                                                                                                                                                                       |
|                                                                                                                                                                                                                         |                                          | —          | 4 in 1 (P)                                                                                                                                                                |  →      |                                                                                                                                                                       |
|                                                                                                                                                                                                                         |                                          | —          | 4 in 1 (L)                                                                                                                                                                |  →      |                                                                                                                                                                       |
|                                                                                                                                                                                                                         | Duplex(1 in 1)<br>(MFC-8820D/<br>8820DN) | Portrait1  | —                                                                                                                                                                         |  →      |                                                                                                                                                                       |
|                                                                                                                                                                                                                         |                                          |            | Portrait2                                                                                                                                                                 | Single Sided                                                                                                                                                              |  →  |
|                                                                                                                                                                                                                         |                                          | Portrait2  | Double Sided                                                                                                                                                              |  →      |                                                                                                                                                                       |
|                                                                                                                                                                                                                         |                                          |            | —                                                                                                                                                                         | Landscape1                                                                                                                                                                | Single Sided                                                                                                                                                          |
|                                                                                                                                                                                                                         |                                          | Landscape1 | Double Sided                                                                                                                                                              |  →      |                                                                                                                                                                       |
|                                                                                                                                                                                                                         |                                          |            | —                                                                                                                                                                         | Landscape2                                                                                                                                                                |  →  |
|                                                                                                                                                                                                                         | Duplex(2 in 1)<br>(MFC-8820D/<br>8820DN) | —          | Portrait1                                                                                                                                                                 |  →      |                                                                                                                                                                       |
|                                                                                                                                                                                                                         |                                          |            | Portrait2                                                                                                                                                                 |  →      |                                                                                                                                                                       |
|                                                                                                                                                                                                                         |                                          |            | Landscape1                                                                                                                                                                |  →      |                                                                                                                                                                       |
|                                                                                                                                                                                                                         |                                          |            | Landscape2                                                                                                                                                                |  →    |                                                                                                                                                                       |
|                                                                                                                                                                                                                         | Duplex(4 in 1)<br>(MFC-8820D/<br>8820DN) | —          | Portrait1                                                                                                                                                                 |  →  |                                                                                                                                                                       |
|                                                                                                                                                                                                                         |                                          |            | Portrait2                                                                                                                                                                 |  →  |                                                                                                                                                                       |
| Landscape1                                                                                                                                                                                                              |                                          |            |  →  |                                                                                                                                                                           |                                                                                                                                                                       |
| Landscape2                                                                                                                                                                                                              |                                          |            |  →  |                                                                                                                                                                           |                                                                                                                                                                       |
| Poster                                                                                                                                                                                                                  | —                                        | —          |  →  |                                                                                                                                                                           |                                                                                                                                                                       |
| Off                                                                                                                                                                                                                     | —                                        | —          | —                                                                                                                                                                         |                                                                                                                                                                           |                                                                                                                                                                       |

# Duplex/N in 1 copy

## N in 1 copy



You can save paper by copying either two or four pages onto one page. Please make sure paper size is set to A4, Letter or Legal.

**1** Press  (**Copy**) to illuminate it in green. Place the original face up in the ADF, or face down on the scanner glass.

**2** Use the dial pad to enter the number of copies you want (up to 99).

**3** Press **Duplex/N in 1**.

Press **Set** to select N in 1.

**4** Press  or  to select 2 in 1 (P), 2 in 1 (L), 4 in 1 (P) or 4 in 1 (L).

Press **Set**.



**5** If you are ready to copy, go to Step 7.

—OR—

Press  or  to select Quality, Contrast or Tray.

Press **Set**.

|                                                                                                                                                      |
|------------------------------------------------------------------------------------------------------------------------------------------------------|
| Enlg/Red:100%                                                                                                                                        |
| Quality :Auto                                                                                                                                        |
| Contrast:- <input type="checkbox"/> <input type="checkbox"/> <input checked="" type="checkbox"/> <input type="checkbox"/> <input type="checkbox"/> + |
| Tray :#1(LTR)                                                                                                                                        |
| Press▲▼ or Start 01                                                                                                                                  |

**6** Press  or  to select a new setting.

Press **Set**.

**7** Press **Start**.

If you are using the ADF, the MFC scans the originals and prints the copies.

—OR—

If you are using the scanner glass, the MFC scans the page. Place the next original on the scanner glass.

|                 |
|-----------------|
| Flatbed Copy:   |
| Next Page?      |
| ▲ 1.Yes         |
| ▼ 2.No          |
| Select ▲▼ & Set |

**8** Select **1** and press **Set**, or press **1**, to copy next page.

**9** Repeat Step **7** and **8** for each page of the layout.

**10** After all the pages of the original have been scanned, select **2** and press **Set**, or press **2**, to print the copies.

 (P) means Portrait and (L) means Landscape.

 You can also combine the N in 1 and Duplex operations. (See *Duplex (2 in 1) and Duplex (4 in 1)* (For MFC-8820D and MFC-8820DN) on page 10-15.)

 For 2 in 1 (P), 2 in 1 (L), 4 in 1 (P) or 4 in 1 (L), you can not use the Enlarge/Reduce setting.

## Poster

You can make a poster size copy of a photograph. You must use the scanner glass.

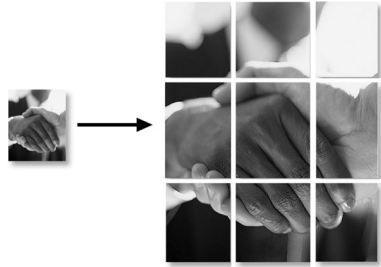

**1** Place the original face down on the scanner glass.

**2** Press **Duplex/N in 1** and  or  to select **Poster**. Press **Set**.

**3** Press **Start**.

The MFC starts scanning the original and prints the pages for the poster.

 For Poster copies, you cannot make more than one copy or use the Enlarge/Reduce setting.



## Duplex (1 in 1) (For MFC-8820D and MFC-8820DN)

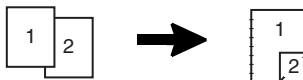



Make a double-sided copy from a single-sided original



**1** Press  (**Copy**) to illuminate it in green. Place the original face up in the ADF, or face down the scanner glass.





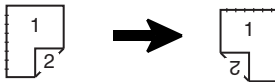

**2** Use the dial pad to enter the number of copies you want (up to 99).

**3** Press **Duplex/N in 1** and  or  to select **Duplex (1 in 1)**. Press **Set**.





- 4 Press  or  to select Portrait1, Portrait2, Landscape1 or Landscape2.
- 5 Press  or  to select Single Sided for the original (If you are using the scanner glass or changed the number of copies at Step 2, this option will not appear).  
Press **Set**.
- 6 Press **Start** to scan the original.  
If you placed the original in the ADF, the MFC starts printing.  
—OR—  
If you placed the original on the scanner glass, go to Step 7.
- 7 Select **1** and press **Set** or press **1** to copy next page.
- 8 After all the pages of the original have been scanned, select **2** and press **Set**, or press **2**.

**Make a double-sided copy from a double-sided original  
(Not available for multiple copies)**



- 1 Press  (**Copy**) to illuminate it in green. Place the original face up in the ADF.
- 2 Press **Duplex/N in 1** and  or  to select Duplex(1 in 1).  
Press **Set**.
- 3 Press  or  to select Portrait2 or Landscape1.  
Press **Set**.
- 4 Press  or  to select Double Sided for the original.
- 5 Press **Set**.
- 6 Make sure that you have put the original in the ADF as shown on the LCD and press **Start**.
- 7 After all the pages of the original have been scanned on one side, turn the other side of the original face up in the ADF.  
Press **Start**.

## Duplex (2 in 1) and Duplex (4 in 1) (For MFC-8820D and MFC-8820DN)

- 1** Press  (**Copy**) to illuminate it in green. Place the original face up in the ADF, or face down on the scanner glass.
- 2** Use the dial pad to enter the number of copies you want (up to 99).
- 3** Press **Duplex/N in 1** and  or  to select Duplex(2 in 1) or Duplex(4 in 1).  
Press **Set**.
- 4** Press  or  to select Portrait1, Portrait2, Landscape1 or Landscape2.  
Press **Set**.
- 5** Press **Start** to scan the original.  
If you placed the original in the ADF, the MFC starts printing.  
—OR—  
If you placed the original on the scanner glass, go to Step 6.
- 6** Place the next original on the scanner glass.  
Select **1** and press **Set** or press **1** to copy next page.
- 7** After all the pages of the original have been scanned, select **2** and press **Set** or press **2**.





# Changing the default copy settings

You can adjust the copy settings that are shown in the chart. These settings will stay until you change them again.

| Submenu    | Menu Selections | Options                                                  | Factory Settings |
|------------|-----------------|----------------------------------------------------------|------------------|
| 1.Quality  | —               | Text                                                     | Auto             |
|            |                 | Photo                                                    |                  |
|            |                 | Auto                                                     |                  |
| 2.Contrast | —               | - □□□■ +<br>- □□□□ +<br>- □□■□ +<br>- □■□□ +<br>- ■□□□ + | - □□□□ +         |



## Quality

- 1 Press **Menu, 3, 1.**
- 2 Press  or  to select Text, Photo or Auto. Press **Set.**
- 3 Press **Stop/Exit.**



## Contrast

You can change the contrast to help an image look lighter or darker.

- 1 Press **Menu, 3, 2.**
- 2 Press  to make lighter.  
—OR—  
Press  to make darker. Press **Set.**
- 3 Press **Stop/Exit.**

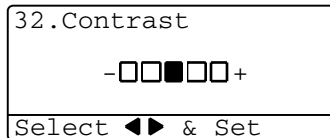

# 11 Using the MFC as a printer

## Using the Brother MFC-8420, MFC-8820D or MFC-8820DN printer driver

A Printer Driver is software that translates data from the format used by a computer into the format required by a particular printer, using a printer command language or page description language.

The printer drivers are on the CD-ROM we have supplied. Install the drivers first by following the Quick Setup Guide. Also, the latest printer driver can be downloaded from the Brother Solutions Center at:

<http://solutions.brother.com>

### Windows® Printing

The dedicated printer driver and TrueType™ compatible fonts for Microsoft® Windows® 95/98/98SE/Me/2000 Professional/XP and Windows NT® workstation 4.0 are available on the CD-ROM supplied with your MFC. You can install them easily into your Windows® system using our installer program. The driver supports our unique compression mode to enhance printing speed in Windows® applications, and allows you to set various printer settings, including economy printing mode and custom paper size.

### Popular Printer Emulation Support

The MFC supports HP LaserJet (PCL level 6) and BR-Script 3 (PostScript® 3™) printer emulation mode. If you use DOS application software, you can use HP LaserJet (PCL level 6) and BR-Script 3 (PostScript® 3™) emulation mode for printer operations.

# How to print your document

When the MFC receives data from your computer, it begins printing by picking up paper from the paper tray. The paper tray can feed many types of paper and envelopes.

- 1** From your computer select the Print command.  
If your computer is also connected to any other printers, select **Brother MFC-8420** or **MFC-8820D (USB) Printer** as your printer driver from the Print or Print Settings menu in your software application, and then click on OK to begin printing.
- 2** Your computer sends a print command and data to the MFC.
- 3** The LED blinks in yellow and the MFC starts to print.



You can select the paper size, and orientation in your application software.

If your application software does not support your custom paper size, select the next largest paper size.

Then adjust the print area by changing the right and left margins in your application software.

# Simultaneous printing and faxing

Your MFC can print from your computer while sending or receiving a fax, and scanning the original into the computer. Fax sending will not be stopped during PC printing.

## Two-sided printing (Duplex Printing)

---

The supplied printer driver supports duplex printing. (For more information, see *Duplex Printing* on page 12-7.)

### Automatic Duplex Printing (For MFC-8820D and MFC-8820DN)

In this mode, the MFC prints on both sides of the A4, Letter or Legal paper automatically.

- 1 Open the Properties dialog box in the printer driver.
  - 2 Select Duplex Printing mode in the Advanced tab, make sure that **'Use Duplex Unit'** has been selected, and then click the **OK** button. (See *Duplex Printing* on page 12-7.) The printer will print on both sides of the paper automatically.
-  ■ When you select **Use Duplex Unit**, HQ1200 is not available.
  - If you also want to use Duplex Printing for fax and copy operations, see *To use Automatic Duplexing for fax, copy and print operations (For MFC-8820D and MFC-8820DN)* on page 2-10.

## Manual Duplex Printing

The MFC prints all the even-numbered pages on one side of the paper first. Then, the Windows® driver instructs you (with a pop-up message) to reinsert the paper. Before reinserting the paper, straighten it well, or you may get a paper jam. Very thin or very thick paper is not recommended.

We recommend 75 to 90 g/m<sup>2</sup> (20 to 24 lb) paper.

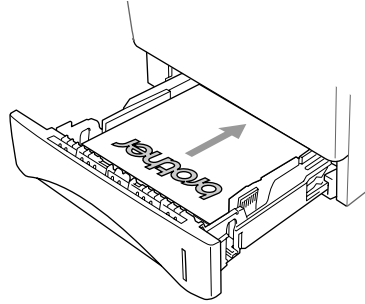

## Face-down output tray

---

The MFC ejects paper with printed surfaces *face down* into the output tray in the front of the MFC. Unfold the support flap to support the printed pages.



When printing transparencies, remove each one from the support flap after it exits the MFC.

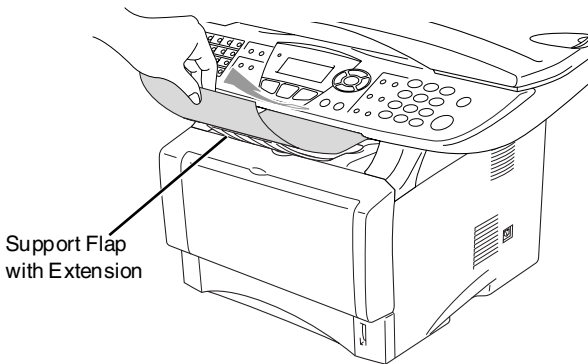

# Printing on plain paper

## The manual feed tray (For MFC-8420)

 The MFC automatically turns on the Manual Feed mode when you put paper in the manual feed tray.

- 1** Select the **Paper Size**, **Media Type**, **Paper Source**, and other settings in the printer driver.

**Media Type:** Plain Paper

**Paper Source:** Manual

- 2** Send the print data to the MFC.
- 3** Open the manual feed tray. Slide the paper guides to fit the paper size.
- 4** Using both hands put paper in the manual feed tray until the front edge of the paper touches the paper feed roller and the MFC grips the paper.

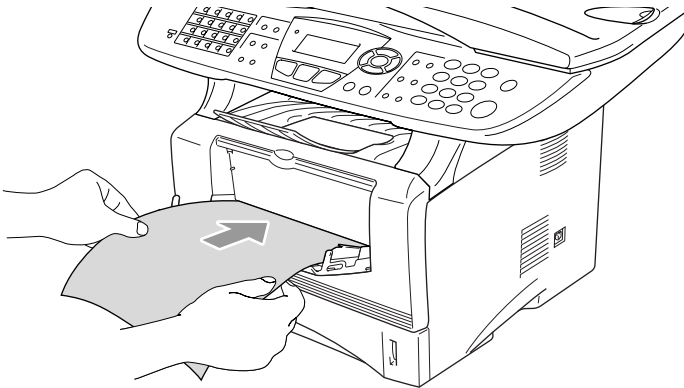

 ■ Make sure that the paper is straight and in the proper position on the manual feed tray. If it is not, the paper may not be fed properly, resulting in a skewed printout or a paper jam.

■ Do not put more than one piece of paper in the manual feed tray at any one time, or it may cause a jam.

- 5** After the printed page comes out of the MFC, put in the next sheet of paper as in Step 4 above. Repeat for each page that you want to print.

## The MP tray (For MFC-8820D and MFC-8820DN)

 The MFC automatically turns on the MP Tray mode when you put paper in the multi-purpose tray.

**1** Select the **Paper Size, Media Type, Paper Source**, and other settings in the printer driver.

**Media Type:** Plain Paper

**Paper Source:** MP Tray

**2** Open the MP tray and lower it gently.

**3** Pull out the MP tray support flap.

**4** When loading paper in the MP tray, make sure it touches the back of the tray.

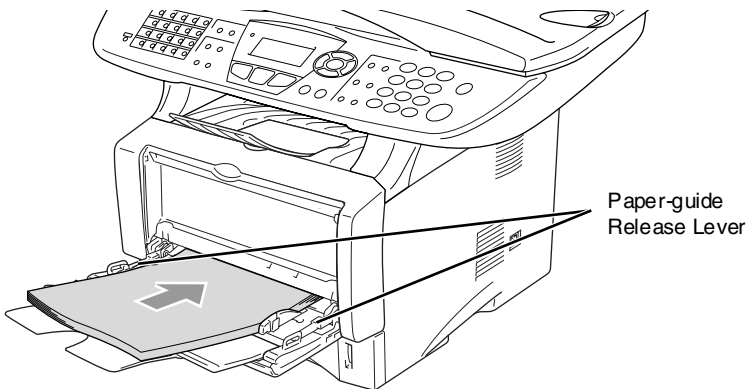

 Make sure that the paper is straight and in the proper position on the MP tray. If it is not, the paper may not be fed properly, resulting in a skewed printout or a paper jam.

**5** While pressing the paper-guide release lever, slide the paper guide to fit the paper size.

 When you put paper in the MP tray, please remember the following:

- The side to be printed on must be face up.
- During printing, the inside tray rises to feed paper into the MFC.
- Put the leading edge (top of the paper) in first and push it gently into the tray.

**6** Send the print data to the MFC.

# Printing on thicker paper and card stock

When the back output tray is pulled down, the MFC has a straight paper path from the manual feed tray or the MP tray through to the back of the MFC. Use this paper feed and output method when you want to print on thicker paper or card stock.

## The manual feed tray (For MFC-8420)

- 1 Select the **Paper Size**, **Media Type**, **Paper Source**, and other settings in the printer driver.

**Media Type:** Thick paper or Thicker paper

**Paper Source:** Manual

- 2 Open the back output tray.

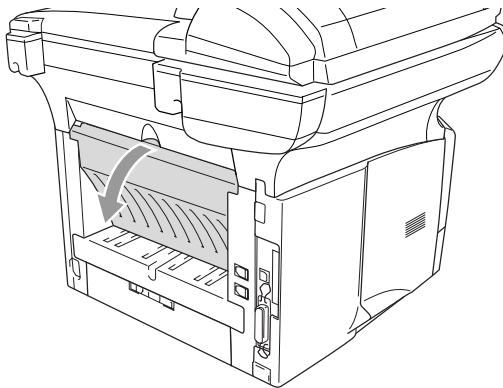

- 3 Open the manual feed tray. Slide the paper guides to fit the paper size.
- 4 Using both hands put the paper in the manual feed tray until the front edge of the paper touches the paper feed roller and the MFC grips the paper.



- Make sure that the paper is straight and in the proper position in the manual feed tray. If it is not, the paper may not be fed properly, resulting in a skewed printout or a paper jam.
- Do not put more than one piece of paper in the manual feed tray at any one time, or it may cause a jam.

- 5 Send the print data to the MFC.



- 6 After the printed page comes out of the MFC, put in the next sheet of paper as in Step 4 above. Repeat for each page that you want to print.
- 7 When you have finished the print job, close the back output tray.

**!** **Caution**

Remove each sheet immediately after printing. Stacking the sheets may cause a paper jam or the paper to curl.

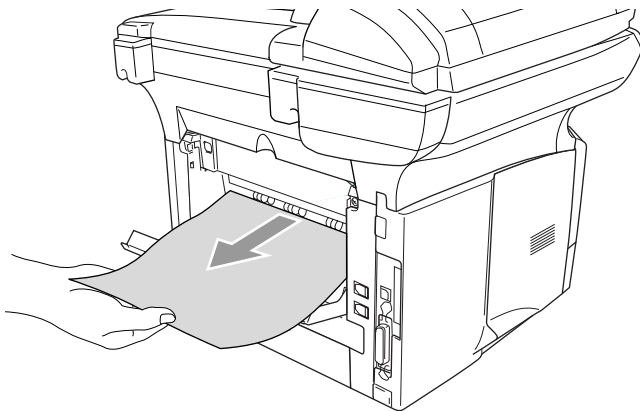

## The multi-purpose tray (MP tray) (For MFC-8820D and MFC-8820DN)



- 1 Select the **Paper Size**, **Media Type**, **Paper Source**, and other settings in the printer driver.

**Media Type:** Thick paper or Thicker paper

**Paper Source:** MP Tray

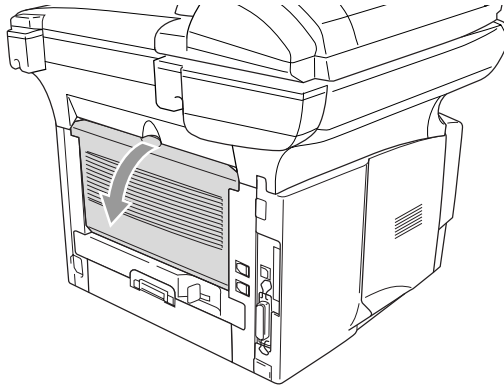
- 2 Open the back output tray, and then pull out the face-up output tray support if necessary.



- 3 Open the MP tray and lower it gently.
- 4 Pull out the MP tray support flap.
- 5 When putting paper in the MP tray, make sure it touches the back of the tray.
  -  Make sure that the paper is straight and in the proper position in the MP tray. If it is not, the paper may not be fed properly, resulting in a skewed printout or a paper jam.
- 6 While pressing the paper-guide release lever, slide the paper guide to fit the paper size.
  -  When you put paper in the MP tray, please remember the following:
    - During printing, the inside tray rises to feed paper into the MFC.
    - The side to be printed on must be face up.
    - Put the leading edge (top of the paper) in first and push it gently into the tray.

**7** Send the print data to the MFC.

**8** When you have finished the print job, close the back output tray.

**!** **Caution**

Remove each sheet immediately after printing. Stacking the sheets may cause a paper jam or the paper to curl.

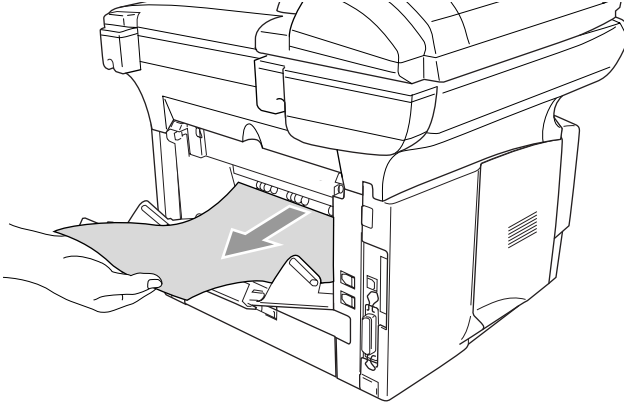

## Printing on envelopes

---

To print on envelopes use manual feed tray or multi-purpose tray.



- The MFC automatically turns on the Manual Feed mode when you put paper in the manual feed tray.
- All sides should be properly folded without any wrinkles or creases.

**1** Select the **Paper Size**, **Media Type**, **Paper Source**, and other settings in the printer driver.

**Media Type:** Envelope, Env.thin or Env.thick

*For MFC-8420:*

**2** Open the back output tray.

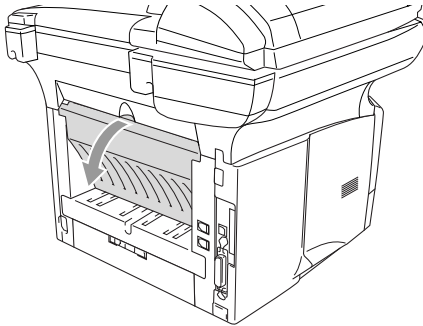

**3** Open the manual feed tray. Slide the paper guides to fit the envelope size.



If envelopes are creased after they have been printed:

At the back of the MFC, open the back output tray and push down the blue tabs at the left and right hand sides (as shown in the figure on the next page). When you have finished printing your envelopes, close the back output tray to reset the two blue tabs back to their original position.

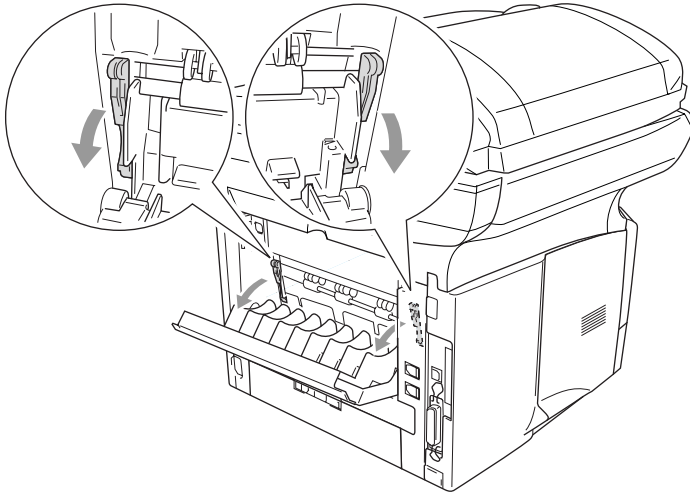

- 4** Using both hands put the envelope in the manual feed tray until the front edge of the envelope touches the paper feed roller. Hold the envelope in this position until the MFC automatically feeds it in for a short distance, and then let go of the envelope.

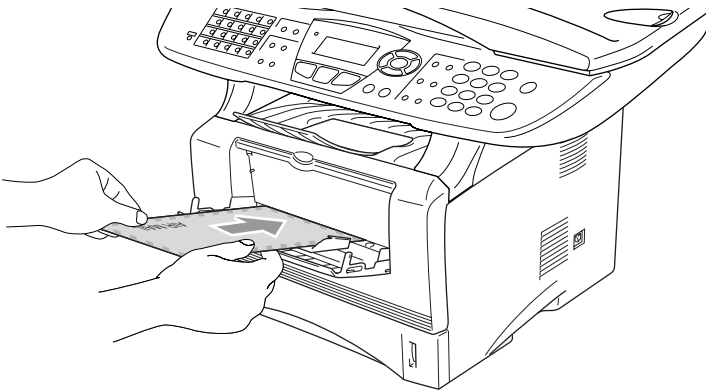

- Make sure the envelope is straight as you insert it in the manual feed tray. If it is not, the envelope may not be fed properly, resulting in a skewed printout or a jam.
- Do not put more than one envelope in the manual feed tray at any one time, or it may cause a jam.
- Put the envelope in the manual feed tray, making sure that the side to be printed on is face up in the tray.

- 5** After the printed envelope comes out of the MFC, the MFC will wait until you put in the next envelope. Repeat Step 4 for each envelope you want to print.
- 6** Send the print data to the MFC.
- 7** After you finish the print job, close the back output tray.

*For MFC-8820D and MFC-8820DN:*

- 2** Open the back output tray, and then unfold the face-up output tray support if necessary.

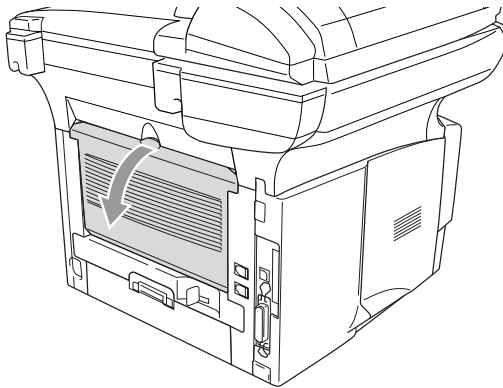

- 3** Open the MP tray and lower it gently.
- 4** Pull out the MP tray support flap.

 If envelopes are creased after they have been printed:

At the back of the MFC, open the back output tray and push down the blue tabs at the left and right hand sides (as shown in the figure on the next page). When you have finished printing your envelopes, close the back output tray to reset the two blue tabs back to their original position.

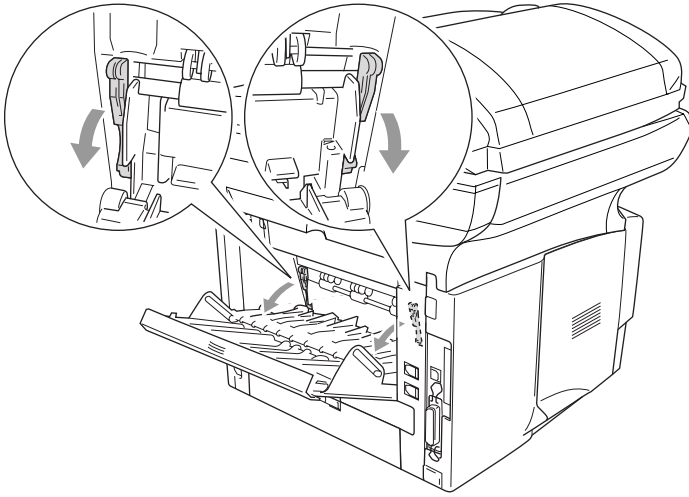

- 5** Put the envelopes in the MP tray so that they touch the back of the tray. Do not put more than 3 envelopes in the MP tray at any one time, or it may cause a jam.

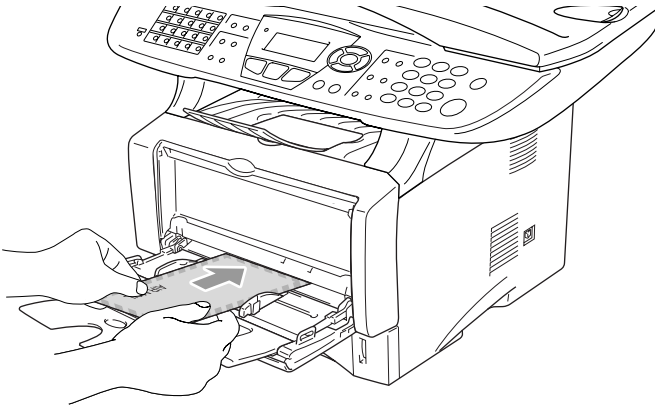

Make sure that the envelopes are neatly stacked and in the proper position in the MP tray. If they are not, the envelopes may not be fed properly, resulting in a skewed printout or a jam.

**6** Press and slide the paper-width guide to fit the envelope size.



When you put envelopes in the MP tray, please remember the following;

- During printing, the inside tray rises to feed envelopes into the MFC.
- The side to be printed on must be face up.
- Put the leading edge (top of the envelope) in first and push it gently into the tray.

**7** Send the print data to the MFC.

**8** After you finish the print job, close the back output tray.



# Printer operation keys

## Job Cancel

You can clear data from the memory.

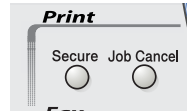

## Secure key

Secured data is password protected. Only those people that know the password will be able to print the data. The MFC will not print secure data until the password is entered. After the document is printed, the data will be cleared from the memory. To use this function, you need to set your password in the printer driver dialog box. (See *Device Options* on page 12-11.)





The Secure Key function is not available when using the Brother BR-Script driver.



**1** Press **Secure**.

—OR—

The LCD displays **No Data!** if there is no secured data in the memory.

**2** Press  or  to select the user name.

Press **Set**. The LCD displays job selections.

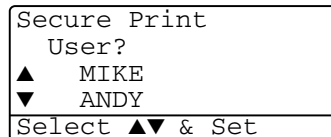

**3** Press  or  to select the job.

Press **Set**. The LCD prompts you to enter your four-digit password.





4 Enter your password using the control panel.

Press **Set**.

5 Press  or  to select Print.

Press **Set**. The MFC prints the data.

—OR—

If you want to delete the secured data press  or  to select Delete.

Press **Stop/Exit**.



- If you turn the power switch Off, the secured data saved in memory will be cleared.
- After you print the secured data it will be cleared from memory.

|                       |
|-----------------------|
| Secure Print<br>Test1 |
| Password:XXXX         |
| Enter & Set Key       |

## Setting the Emulation Selection

This MFC has an Automatic Emulation Selection function. When the MFC receives information from the PC, it automatically chooses the emulation mode. This function has been set at the factory to AUTO. You can change the default emulation mode manually by using the control panel.

1 Press **Menu, 4, 1**.

2 Press  or  to select Auto, HP Laser Jet or BR-Script3.

Press **Set**.

3 Press **Stop/Exit**.

|                 |
|-----------------|
| 41.Emulation    |
| ▲ Auto          |
| HP LaserJet     |
| ▼ BS-Script 3   |
| Select ▲▼ & Set |



Try this function with your application software or network server. If the function does not work properly, either select the required emulation mode manually using the MFC panel buttons or use the emulation selection commands in your software.

## Printing the Internal Font List

---

You can print a list of the MFC's internal (or resident) fonts to see how each font looks before you select it.

- 1 Press **Menu, 4, 2, 1**.
- 2 Press **Start**. The MFC prints the list.
- 3 Press **Stop/Exit**.

|                                     |
|-------------------------------------|
| 42.Print Options<br>1.Internal Font |
| Press Start                         |

## Printing the Print Configuration List

---

You can print a list of current printer settings.

- 1 Press **Menu, 4, 2, 2**.
- 2 Press **Start**. The MFC prints the settings.
- 3 Press **Stop/Exit**.

|                                     |
|-------------------------------------|
| 42.Print Options<br>2.Configuration |
| Press Start                         |

## Restoring factory default settings

---

You can return the MFC to the original factory settings. Fonts and macros in the temporary settings are cleared.

- 1 Press **Menu, 4, 3**.
  - 2 Press **1** to restore the factory settings
- OR—

|                  |
|------------------|
| 43.Reset Printer |
| ▲ 1.Reset        |
| ▼ 2.Exit         |
| Select ▲▼ & Set  |

Press **2** to exit without making a change.

- 3 Press **Stop/Exit**.



Only the printer settings will be returned to the original factory settings.

# 12 Printer driver settings

(Windows® Only)

## Printer driver settings

You can change the following printer settings when you print from your computer:

- **Media Type**
- **Multiple Page**
- **Duplex**
- **Watermark**\*1\*2
- **Scaling**\*2
- **Print Date & Time**\*1\*2
- **Quick Print Setup**\*1\*2
- **Secure Print**\*1

\*1 These settings are not available with the BR-script driver.

\*2 These settings are not available with the Universal printer driver.

## How to access the printer driver settings

- 1 Select **Print** from the **File** menu in your application software.
- 2 Select **Brother MFC-8420** or **MFC-8820D (USB) Printer** as your printer and click **Preferences** for Windows® 2000/XP (**Properties** for Windows® 95/98/98SE and Me, **Document Default** for Windows NT® 4.0). The **Printing Preferences** dialog box will appear.



The way you access the printer driver settings depends on your operating system and software applications.



The screens shown in this section are from Windows® XP. The screens on your Computer may vary depending on your Windows Operating System.



Some descriptions in this chapter are based on the MFC-8820D. These descriptions also apply to the MFC-8420 and MFC-8820DN.

# Features in the Brother Native Driver

The Brother Native driver is a printer driver developed exclusively by Brother, this driver includes more features than the Microsoft® Windows® Universal printer driver.

## Basic tab

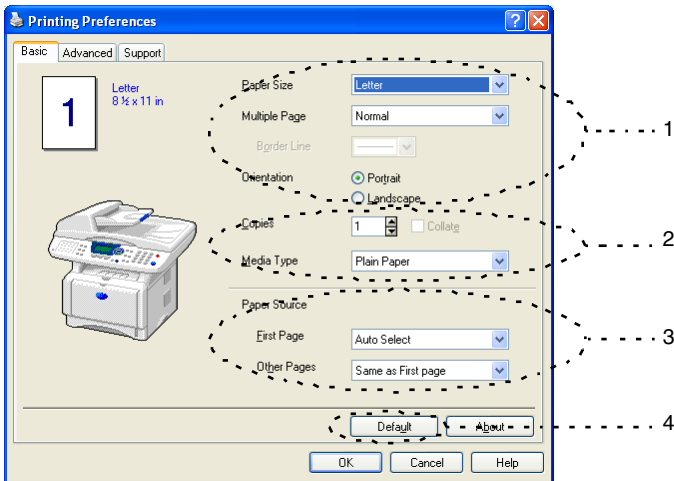

- 1 Select the **Paper Size**, **Multiple Page**, **Border Line** (if any) and **Orientation**.
- 2 Select number of **Copies** and **Media Type**.
- 3 Select **Paper Source** (**First Page** and **Other Pages**).
- 4 **Auto Select** allows the printer driver to select a suitable tray for **Paper Size** automatically. You can set the paper size for each tray in the *Accessories* tab. (See *Accessories* tab on page 12-15.)
- 5 To return to the default settings, click the **Default** button.

## Paper Size

From the drop-down box select the Paper Size you are using.

## Multiple Page

The Multiple Page selection can reduce the image size of a page allowing multiple pages to be printed on one sheet of paper or enlarging the image size for printing one page on multiple sheets of paper.

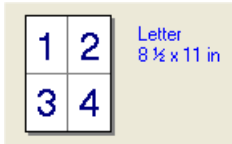

Ex. 4 in 1



Ex. 1 in 2 x 2 pages

## Border Line

When printing multiple pages on one sheet with the Multiple Page feature you can select to have a solid border, dash border or no border around each page on the sheet.

## Orientation

Orientation selects the position of how your document will be printed (**Portrait** or **Landscape**).

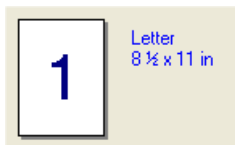

Portrait



Landscape

## Copies

The copies selection sets the number of copies that will be printed.

### Collate

With the **Collate** check box selected, one complete copy of your document will be printed and then repeated for the number of copies you selected. If the **Collate** check box is not selected, then each page will be printed for all the copies selected before the next page of the document is printed.

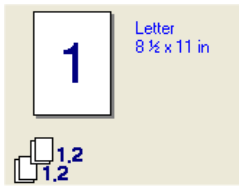

Collate box checked

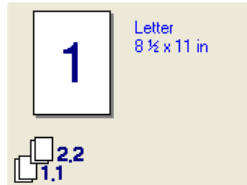

Collate box not checked

## Media Type

You can use the following types of media in your MFC. For the best print quality, select the type of media that you wish to use.

### Plain Paper

### Thin Paper

### Thick Paper

### Thicker Paper

### Bond Paper

### Transparencies

### Envelopes

### Env. Thick

### Env. Thin



- When using ordinary plain paper (19 to 25 lb), select **Plain Paper**. When using heavier weight paper, envelopes or rough paper select **Thick Paper** or **Thicker Paper**. For bond paper, select **Bond Paper** for OHP transparencies, select **Transparencies**.

- When you use envelopes, select **Envelopes**. If the toner is not fixed to the envelope correctly when **Envelopes** has been selected, select **Env. Thick**. If the envelope is crumpled when **Envelopes** has been selected, select **Env. Thin**.

# Advanced tab

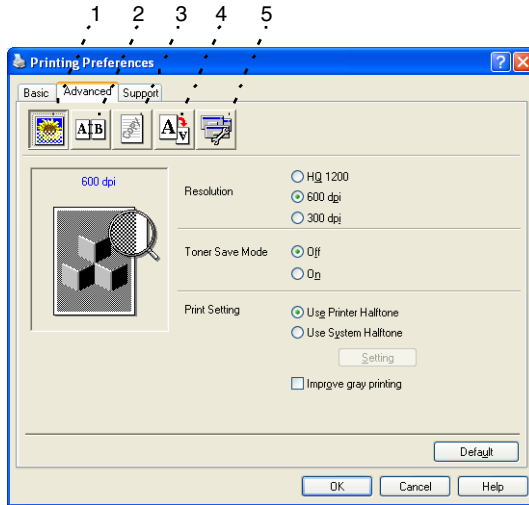

To return to the default settings, click the **Default** button.

Change the tab settings by selecting one of the following icons:

**1 Print Quality**

**2 Duplex**

**3 Watermark**

**4 Page Setting**

**5 Device Options**

## Print Quality

### Resolution

You can change the resolution as follows:

- HQ 1200
- 600 dpi
- 300 dpi



When you select **Use Duplex Unit**, HQ1200 is not available.



## Toner Save

You can save running costs by turning on the Toner Save Mode, which reduces the print density.

## Print Setting

*For Windows® 95/98/98SE/Me*

Print Setting is used for optimizing your print quality for the type of original being printed (Photos, Graphics or Scanned Images). When you choose **Auto (Recommended)**, the printer automatically prints with the most suitable print settings.

With the Print Setting set to Manual, you can change the Brightness, Contrast and Graphics Quality options manually.

*For Windows® 2000/XP/NT® WS 4.0*

- Check **Use Printer Halftone** to print using Halftone.
- Check **Use System Halftone** to print using Halftone of the system. To change the setting, press **Setting**.
- If the halftone cannot be printed correctly, check **Improve gray printing**.

## Duplex Printing

Choosing the Duplex Printing icon displays the Duplex features available.

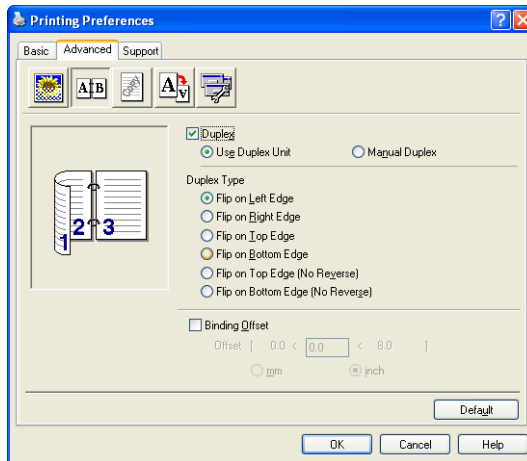

### Use Duplex Unit (For MFC-8820D and MFC-8820DN)

Check the Duplex box and then select **Use Duplex Unit**. In this mode the MFC prints on both sides of the paper automatically.

### Manual Duplex

Check the Duplex box and then select **Manual Duplex**. In this mode, the MFC prints all the even numbered pages first. Then the printer driver stops and shows the instructions required to re-install the paper. When you click OK the odd numbered pages are printed.

### Duplex Type

You can select **Duplex Type**. There are six types of duplex directions available for each orientation.

**Flip on Left Edge** 

**Flip on Right Edge** 

**Flip on Top Edge** 

**Flip on Bottom Edge** 

**Flip on Top Edge (No Reverse)** 

**Flip on Bottom Edge (No Reverse)** 

## Binding Offset

Check the Binding Offset option, you can specify the offset value of the binding side in inches or millimeters (0 - 8 inches) [0 - 203.2 mm].

## Watermark

You can place a logo or text into your document as a Watermark. You can select one of the preset Watermarks, or you can use a bitmap file or text file that you have created.

Check **Use Watermark**, and then select the watermark you want to use.

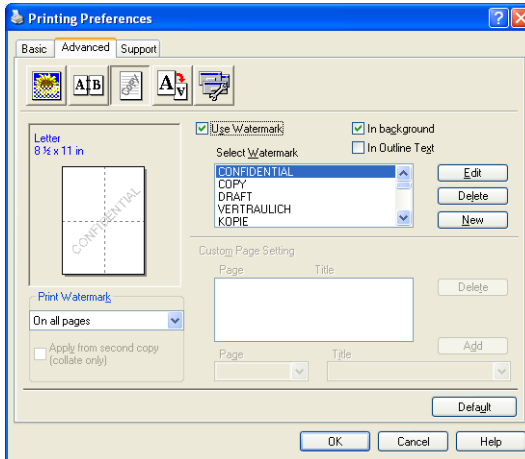

## In background

Check **In background** to print the watermark image in the background of your document. If this feature is not checked then the Watermark will be printed on top of your document.

## In Outline Text

**(Window® 2000 Professional/XP/NT® WS 4.0 Only)**

Check **In Outline Text** if you only want to print an outline of the watermark.

## Print Watermark

The **Print Watermark** feature offers the following print choices:

- **On all pages**
- **On first page only**
- **From second page**
- **Custom**
- **Apply from second copy (collate only)** (For Windows® 2000/XP/Windows NT® 4.0)

## Watermark Setting

You can change the Watermark's size and position on the page by selecting the Watermark, and clicking the **Edit** button. If you want to add a new Watermark, click the **New** button, and then select **Text** or **Bitmap** in the **Watermark Style**.

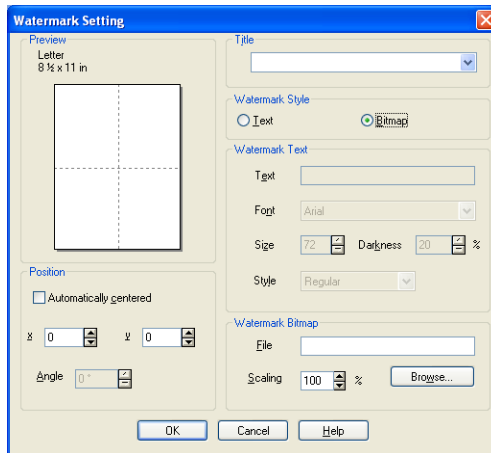

- **Title**

You can select the **CONFIDENTIAL**, **COPY** or **DRAFT** as the standard title or enter a title you like in the field.

- **Watermark Text**

Enter your Watermark text into the **Text** Box, and then select the **Font**, **Size**, **Darkness** and **Style**.

- **Watermark Bitmap**

Enter the file name and location of your bitmap image in the **File** box, or **Browse** for the file location. You can also set the scaling size of the image.

## ■ Position

This setting offers you the control for where the Watermark is to be positioned on the page.

## Page Setting

You can change the print size of your document with the Scaling feature.

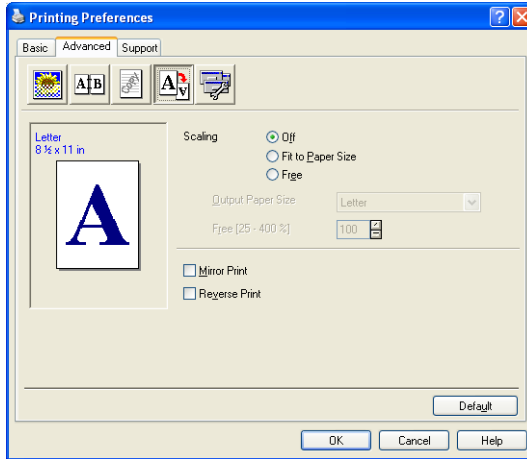

- Check **Off** if you want to print the document as it appears on your screen.
- Check **Fit to Paper Size**, if your document has an unusual size, or if you have only the standard size paper.
- Check the **Free** box if you want to manually reduce or enlarge the output.
- You can also use the **Mirror Print** or **Reverse Print** feature for your page setting.

## Device Options

Lets you set the following Printer Functions:

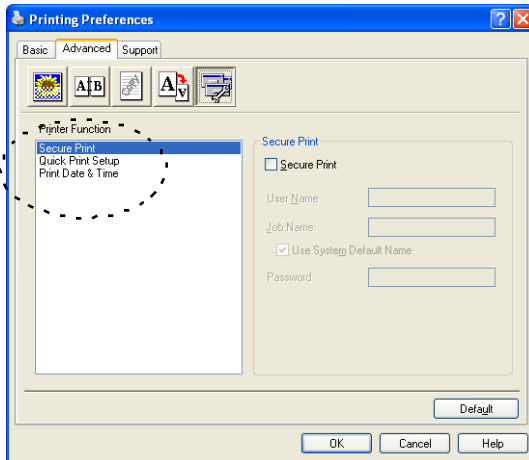

## Secure Print

Secure documents are documents that are password protected when they are sent to the MFC. Only the people who know the password will be able to print them. Since the documents are secured at the MFC, you must use the control panel of the MFC (with the password) to print them.

*To send a secured document:*

- 1** Select **Secure Print** from **Printer Function** and check **Secure Print**.
- 2** Enter your password, user name and job name and click OK.
- 3** You must print the secured documents from the control panel of the MFC. (See *Secure key* on page 11-16.)

*To delete a secured document:*

You need to use the control panel of the MFC to delete a secured document. (See *Secure key* on page 11-16.)



You can store up to 8 MB of secured data in the MFC's memory.

## Quick Print Setup

The Quick Print Setup feature allows you to quickly select driver settings. To view setting, simply click your mouse button on the task tray  icon. This feature can be set to ON or OFF from the Device Options section.

 The factory setting is OFF.

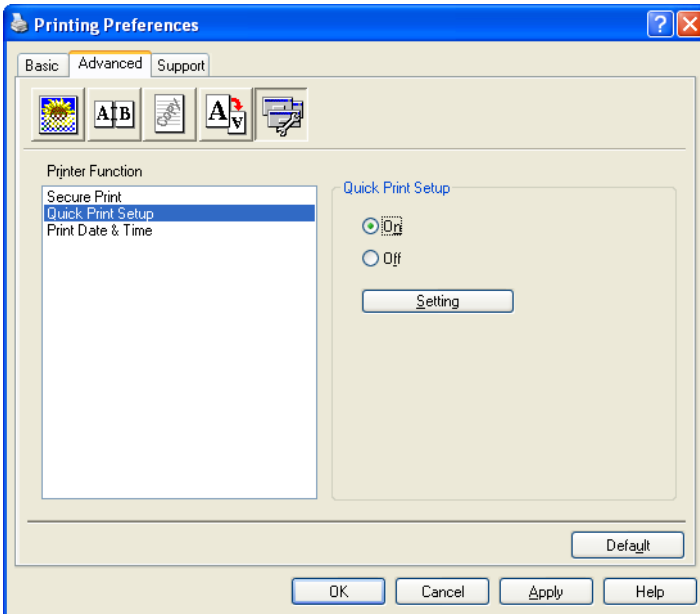

## Administrator (For Windows® 95/98/98SE/Me Users Only)

The administrator selection permits the Copy, Scaling and Watermark features to be locked and password protected.

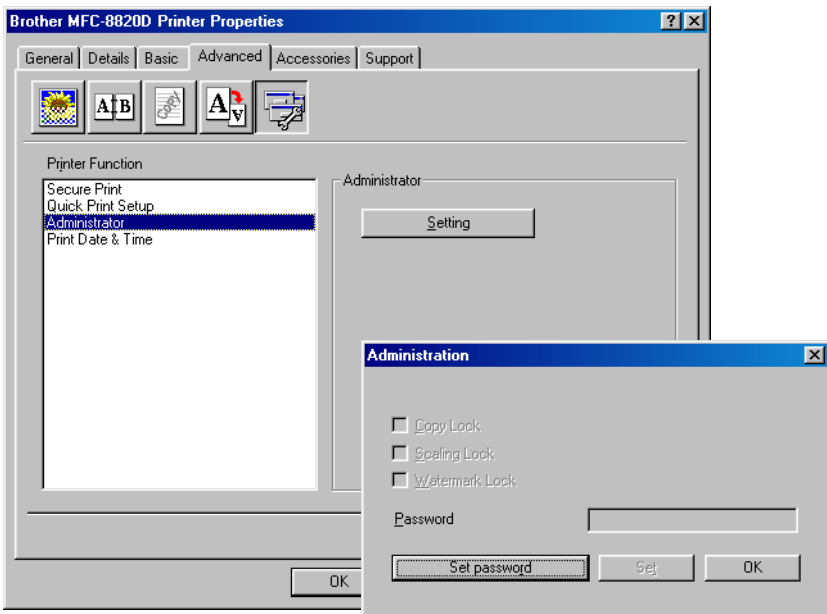

 Record your password and keep it in a safe place for future reference. If you forget your password these settings can not be accessed.



## Print Date & Time

When enabled the **Print Date and Time** feature will automatically print the date and time from your computers system clock on your document.

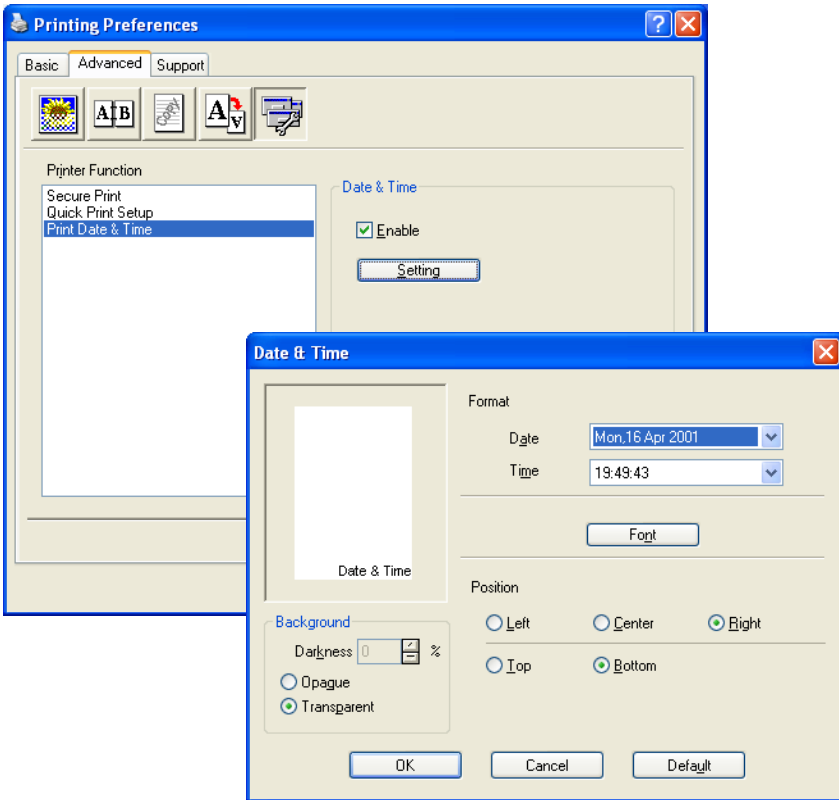

Click the **Setting** button to change the **Date** and **Time** Format. You can change the Font by clicking the **Font** button or the **Position**. To include a background with the **Date** and **Time** select **Opaque**. When **Opaque** is selected you can set the **Darkness** of the **Date** and **Time** background by changing the percentage.



The Date and Time indicated in the selection box represents the format that will be printed. The actual Date and Time printed on your document is automatically retrieved from the settings of your computer.

## Accessories tab

The **Accessories** Tab includes the settings for configuring the printer driver for the size of paper loaded in each paper source. This tab also installs any additional options into the driver settings.

### Paper Source Setting

To configure the paper size for each paper source, highlight the source in the **Paper Source Setting** list. Select the **Paper Size** from the pull-down box and click **Update**. When **Auto Select** (default paper source) is set in the **Basic** tab of the printer driver (see *Basic tab* on page 12-2), the printer driver will automatically use the **Paper Source Setting** to select a tray that matches the **Paper Size** setting in the printer driver.

### Default Source

The **Default Source** allows you to choose the paper source that will be used when the paper size of the document being sent does not match the Paper Source settings.

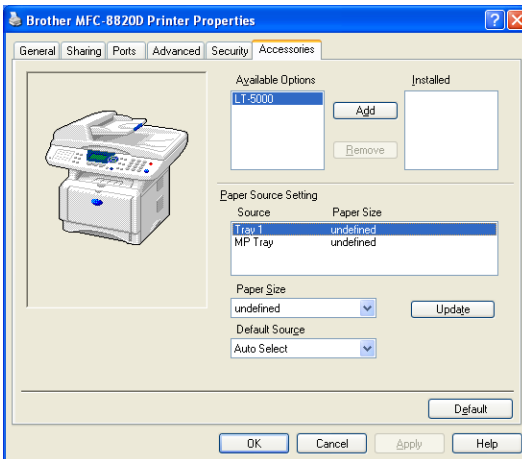

### Available Options

In order to access the optional 2nd paper tray the option must be installed in the driver. Highlight the model number from the **Available Options** list and click **Add**. The optional tray will then be listed in the **Installed** box, **Paper Source Setting** list and the screen illustration will display the 2nd tray.

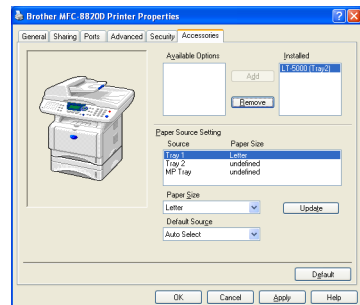

## Support tab

The **Support** Tab provides driver version and setting information. In addition there are links to the **Brother Solutions Center** and the Driver Update Web sites.

Click the **Support** tab to display the following screen:



## Brother Solutions Center

The **Brother Solutions Center** is a Web site offering information about your Brother product including FAQs (Frequently Asked Questions), User Guides, Driver Updates and Tips for using your MFC.

## Web Update

**Web Update** checks the Brother web site for updated drivers, and automatically downloads and updates the printer driver on your computer.

## Check Setting

The **Check Setting** selection displays a list of your current driver settings.

# Features in the PS printer driver (For Windows®)

The Windows® 95/98/98SE/Me/2000 Professional/XP and Windows NT® 4.0 utilizes BR-Script 3(PostScript® 3™ language emulation) driver.

You can download the latest driver by accessing the Brother Solutions Center at <http://solutions.brother.com>

## To install the PS driver

If you have already installed the printer driver following the instruction in the Quick Setup Guide, insert the CD-ROM into the CD-ROM drive on your PC and click **Install Software**. Choose **MFL-Pro Suite** and follow the on-screen instructions. When the **Select Components** screen appears, check **PS Printer Driver**, and then continue following the on-screen instructions.

If you have not previously installed the driver and software, insert the CD-ROM into the CD-ROM drive on your PC and click **Install Software**. Choose **MFL-Pro Suite** and follow the on-screen instructions. When the **Setup Type** screen appears, select **Custom** and check the **PS Printer Driver**. Then continue following on-screen instructions.



The screens in this section are from Windows® XP.

The screens on your PC will vary depending on your Operating System.

## Ports tab

Select the port where your printer is connected or the path to the network printer you are using.

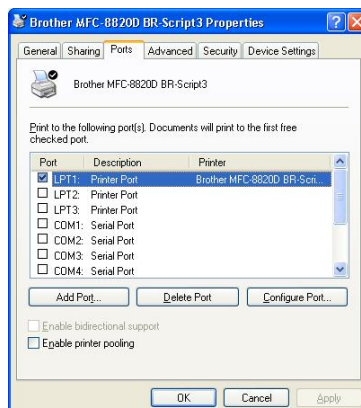

# Device Settings tab

Select the options you installed.

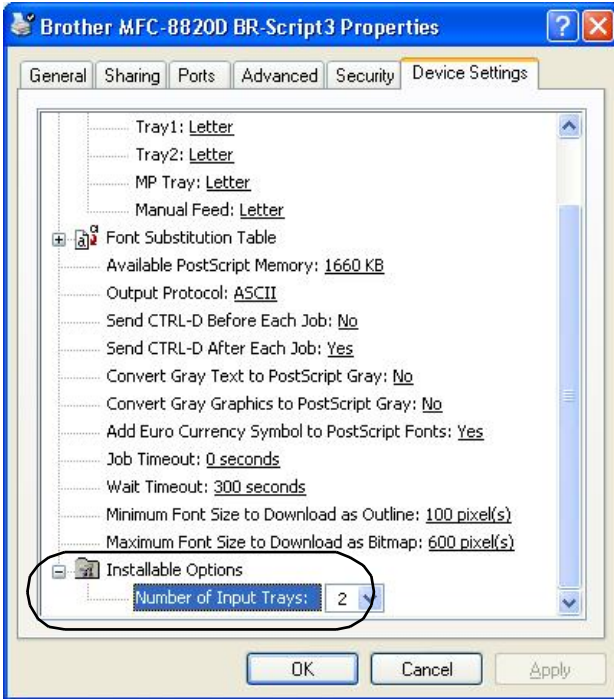

## Layout tab

 If you are using Windows NT® 4.0, Windows® 2000 or XP, you can access the **Layout** tab by clicking **Printing Preferences...** in the **General** tab of the **Brother MFC-8820D BR-Script3 Properties** screen.

You can change the Layout setting by selecting the setting in the **Orientation**, **Page Order** and **Page Per Sheet**.

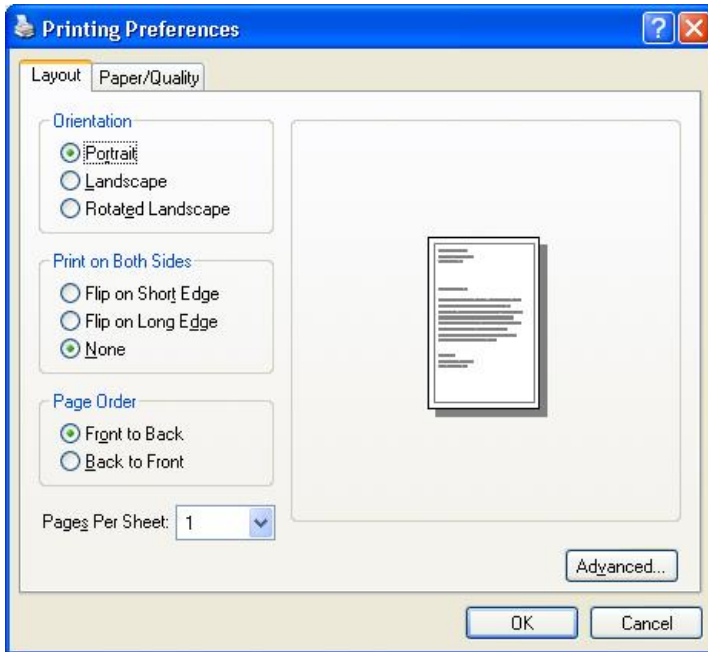

### **Booklet (For MFC-8820D and MFC-8820DN) (For Windows® 2000/XP)**

You can print a booklet by selecting **Booklet** from **Pages Per Sheet** list.

## Paper / Quality tab



If you are using Windows NT® 4.0, Windows® 2000 or XP, you can access the **Paper/Quality** tab by clicking **Printing Preferences...** in the **General** tab of the **Brother MFC-8820D BR-Script3 Properties** screen.

Select the **Paper Source**.

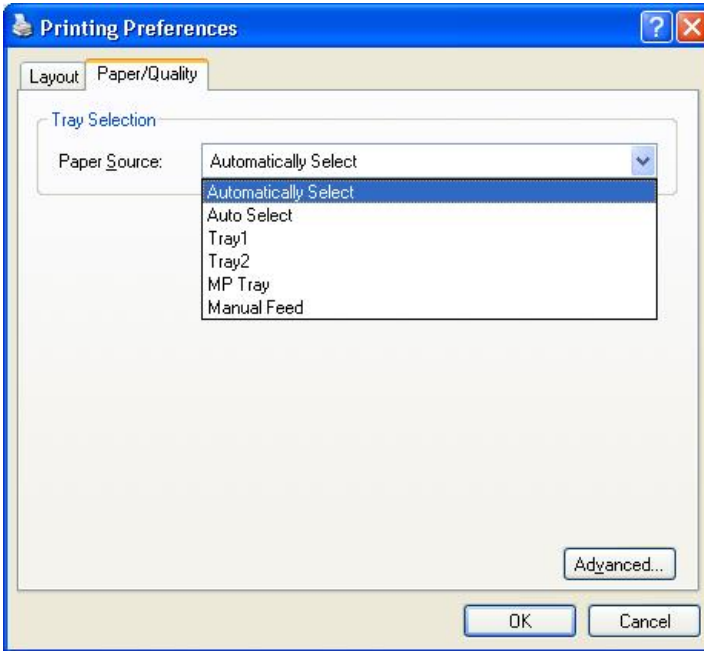

# Advanced Options

 If you are using Windows NT® 4.0, Windows® 2000 or XP, you can access the **Brother MFC-8820D BR-Script3 Advanced Options** tab by clicking **Advanced...** button in the **Layout** tab or the **Paper/Quality** tab.

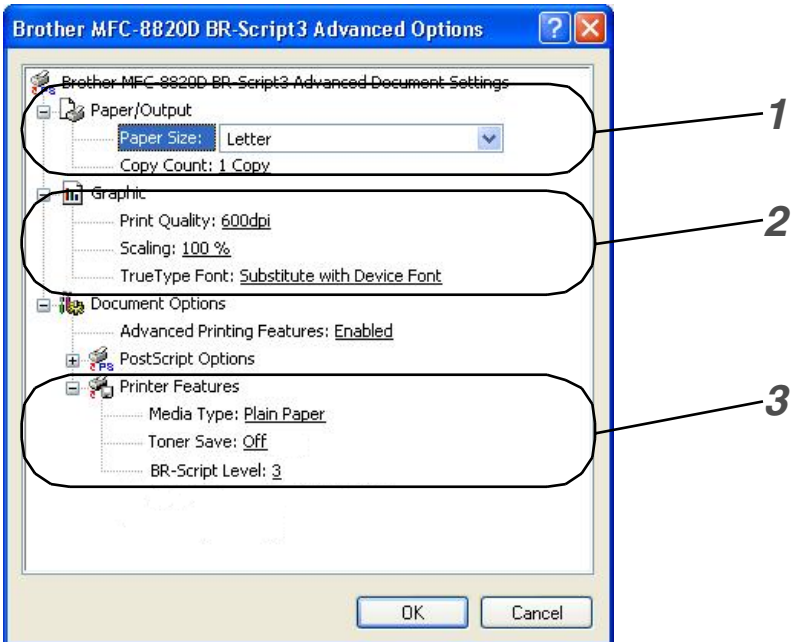

- 1** Select the **Paper Size** and **Copy Count**.
- 2** Set the **Print Quality**, **Scaling** and **TrueType Font** setting.
- 3** You can change settings by selecting the setting in the Printer Features list:
  - Media Type
  - Toner Save
  - BR-Script Level



# 13 How to scan using Windows®



The scanning operations and drivers will be different depending on your operating system.

## **For Windows® 95/98/98SE/Me/2000 Professional and Windows NT® Workstation 4.0**

The MFC uses a TWAIN Compliant driver for scanning documents from your applications. (See *Scanning a document, TWAIN compliant* on page 13-1.)

## **For Windows® XP**

The MFC uses Windows® Imaging Acquisition (WIA) for scanning documents. (See *Scanning a document (For Windows® XP only)* on page 13-10.)



## **For ScanSoft®, PaperPort® and TextBridge® OCR**

Go to *Using ScanSoft® PaperPort® and TextBridge® OCR* on page 13-19.

## Scanning a document

### TWAIN compliant

---

The Brother MFL-Pro Suite software includes a TWAIN compliant scanner driver. TWAIN drivers meet the standard universal protocol for communicating between scanners and software applications. This means that not only can you scan images directly into the PaperPort® viewer that Brother included with your MFC, but you can also scan images directly into hundreds of other software applications that support TWAIN scanning. These applications include popular programs like Adobe® Photoshop®, Adobe® PageMaker®, CorelDraw® and many more.

# How to access the Scanner

**1** Open the software application (ScanSoft® PaperPort®) to scan a document.

 The instructions for scanning in this Guide are for when you use ScanSoft® PaperPort® 8.0SE.

**2** Select **Scan** from the **File** drop-down menu or select the **Scan** button. The **Scan** pane appears in the left panel.

**3** Select **Brother MFC-8820D**, **Brother MFC-8820D USB** or **Brother MFC-8820D LAN** from the **Scanner** drop-down list box.

**4** Click **Scan**.

 If the MFC is connected via:

Parallel - use 'Brother MFC-8520D'

USB - use 'Brother MFC-8820 USB'

LAN - use 'Brother MFC-8820D LAN'

The **Brother MFC-8820D**, **Brother MFC-8820D USB** or **Brother MFC-8820D LAN Scanner Setup** dialog box will appear:

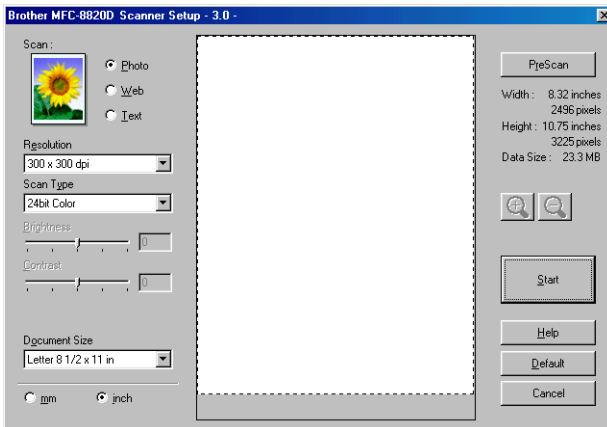

## Scanning a document into the PC

---

You can scan a whole page

—OR—

Scan a portion of the page after pre-scanning the document.

### Scanning a whole page

- 1 Place the original face up in the ADF (automatic document feeder), or face down on the scanner glass.
- 2 Adjust the following settings, if required, in the Scanner window:
  - Image Type
  - Resolution
  - Scan Type
  - Brightness
  - Contrast
  - Document Size



After you select a document size, you can adjust the scanning area further by clicking the left mouse button and dragging it. This is required when you want to crop an image when scanning.

See *Settings in the Scanner window* on page 13-6.

- 3 Click the **Start** button in the scanner window. When scanning is completed, click **Cancel** to return to the PaperPort® window.

## PreScanning to crop a portion you want to scan

The **Pre-Scan** button is used to preview an image for cropping any unwanted areas from the image. When you are satisfied with the preview, click the **Start** button in the scanner window to scan the image.

- 1 Place the original face up in the ADF, or face down on the scanner glass.

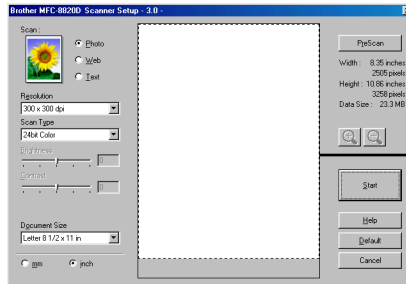



- 2 Select the settings for **Image Type**, **Resolution**, **Scan Type**, **Brightness** and **Contrast**, as needed.
- 3 In the **Brother MFC-8820D**, **Brother MFC-8820D USB** or **Brother MFC-8820D LAN Scanner Setup** dialog box, click the **Pre Scan** button.

The entire original will be scanned into the PC and will appear in the Scanning Area.



- 4 Select the portion you want to scan by clicking the left mouse button and dragging it.



You can enlarge the portion you selected by pressing  to check it. If you want to select the different portion, use  to undo the image.

- 5** Place the original face up in the ADF again, if you used the ADF in Step 1.
- 6** Click **Start**.  
This time only the selected area of the original will appear in the PaperPort® window (or your software application window).
- 7** In the PaperPort® window, use the options available to refine the image.

# Settings in the Scanner window

---

## Image Type

Select the image type of output from **Photo**, **Web** or **Text**.

**Resolution** and **Scan Type** will be altered for each default setting.

The default settings are:

| Image Type   |                                                      | Resolution    | Scan Type     |
|--------------|------------------------------------------------------|---------------|---------------|
| <b>Photo</b> | Select for scanning photo images.                    | 300 x 300 dpi | 24-bit color  |
| <b>Web</b>   | Select for attaching the scanned image to web pages. | 100 x 100 dpi | 24-bit color  |
| <b>Text</b>  | Select for scanning text documents.                  | 200 x 200 dpi | Black & White |

## Resolution

You can change the scanning resolution from the **Resolution** drop down list. Higher resolutions take more memory and transfer time, but can achieve a finer scanned image. The following table shows the resolution you can choose and the available colors.

| Resolution      | Black & White / Gray (Error Diffusion) | 256 color | True Gray / 24 bit color / 24 bit color (Fast) |
|-----------------|----------------------------------------|-----------|------------------------------------------------|
| 100 × 100 dpi   | Yes                                    | Yes       | Yes                                            |
| 150 × 150 dpi   | Yes                                    | Yes       | Yes                                            |
| 200 × 200 dpi   | Yes                                    | Yes       | Yes                                            |
| 300 × 300 dpi   | Yes                                    | Yes       | Yes                                            |
| 400 × 400 dpi   | Yes                                    | Yes       | Yes                                            |
| 600 × 600 dpi   | Yes                                    | Yes       | Yes                                            |
| 1200 × 1200 dpi | Yes                                    | No        | Yes                                            |
| 2400 × 2400 dpi | Yes                                    | No        | Yes                                            |
| 4800 × 4800 dpi | Yes                                    | No        | Yes                                            |
| 9600 × 9600 dpi | Yes                                    | No        | Yes                                            |

## Scan Type

**Black & White:** Set the Scan Type to **Black & White** for text or line art.

**Gray Scale:** Set the Scan Type to Gray or True Gray for photographic images.

**Colors:** Set either:

**256 Color**, which scans up to 256 colors, or **24-bit color** which scans up to 16.8 million colors.

Although using **24-bit color** creates an image with the most accurate colors, the image file will be approximately three times larger than a file created with **256 Color**.

## Brightness

Adjust this settings (-50 to 50) to obtain the best image. The default value is 0, representing an 'average'.

You can set the level by dragging the slide bar to the right or left to lighten or darken the image. You can also type a value in the box for the setting.

If the scanned image is too light, set a lower brightness value and scan the document again. If the image is too dark, set a higher brightness value and scan the document again.

## Contrast

This setting is adjustable only when you have selected one of the gray scale settings. It is not available when **Black & White** and **Color** settings are selected as the **Scan Type**.

You can increase or decrease the contrast level by moving the slide bar to the left or right. An increase emphasizes dark and light areas of the Image, while a decrease reveals more detail in gray areas. You can also type a value in the box for the setting.

## Document Size

Set the Size to one of the following:

- Letter (8 1/2 × 11 in.)
- A4 (210 × 297 mm)
- Legal (8 1/2 × 14 in.)
- A5 (148 × 210 mm)
- B5 (182 × 257 mm)
- Executive (7 1/4 × 10 1/2 in.)
- Business Card (90 × 60 mm)
- Photo 3.5 × 5 in. (9 × 13cm)
- Photo 5 × 7 in. (13 × 18cm)
- APS C 4 × 6 in. (10 × 15cm)
- Custom (User adjustable from 0.35 × 0.35 in. to 8.5 × 14 in. or 8.9 × 8.9 mm to 215.9 × 355.6 mm)

To scan photographs or business cards, select the document size, and then place the document face down at the center of scanner glass.

When scanning photographs or other images for use in a word processor or other graphics application. You should try different settings for the contrast and resolution modes to see which best suits your needs.

If you selected **Custom** as the size, The **Custom Document Size** dialog box will appear.

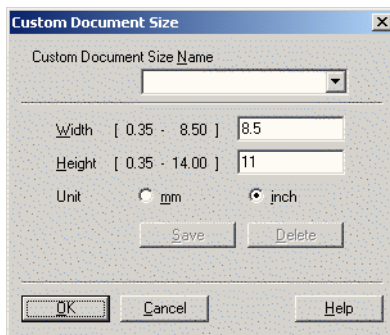

Type the **Name**, **Width** and **Height** for the document.

You can choose “mm” or “inch” as the unit for Width and Height.





You can see the actual paper size you selected on the screen.

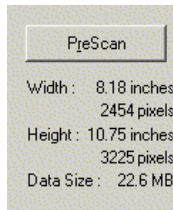

- **Width:** shows the width of scanning area
- **Height:** shows the height of scanning area
- **Data Size:** shows the approximate data size calculated in a Bitmap format. The size will be different for other file formats such as JPEG.

# Scanning a document (For Windows® XP only)

## WIA compliant

Windows® XP uses Windows Image Acquisition (WIA) for scanning images from the MFC. You can scan images directly into the PaperPort® viewer that Brother included with your MFC or you can scan images directly into any other software application that supports WIA or TWAIN scanning.

## How to access the scanner

- 1 Open your software application to scan a document.  
 The instructions for scanning in this Guide are for when you use ScanSoft® PaperPort® 8.0. The steps for scanning from another application may vary.
- 2 Select **Scan** from the **File** drop-down menu or select the Scan button.  
The **Scan** pane appears in the left panel.
- 3 Select the scanner you are using from the **Scanner** drop-down list box.
- 4 Click **Scan**.  
The Scan dialog box will appear:

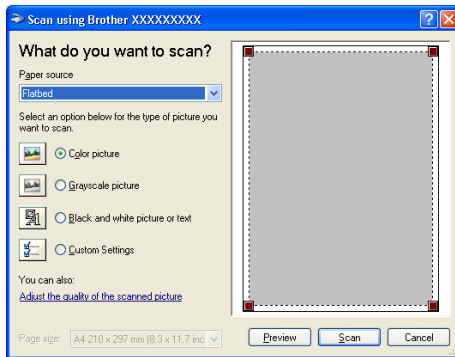

# Scanning a document into the PC

If you want to scan a whole page, use the ADF (automatic document feeder).

—OR—

If you want to scan a portion of the page after pre-scanning the document, use the scanner glass (Flatbed).

## Scanning a document using the ADF

- 1 Place the original face up in the ADF (automatic document feeder).

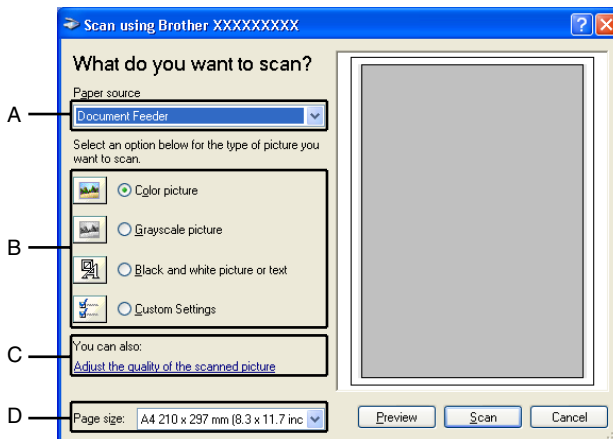

- 2 Select the **Document Feeder** from the **Paper source** drop-down list box (A).
- 3 Select the picture type (B).
- 4 Select the **Paper size** from the drop-down list box (D).
- 5 If you require advanced settings, click **Adjust the quality of the scanned picture** (C). You can select **Brightness**, **Contrast**, **Resolution** and **Picture Type** from the **Advanced Properties**. Click the **OK** button after you choose your settings.

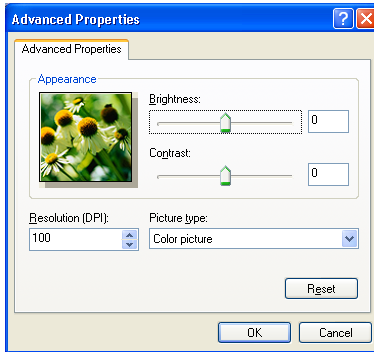

- The scanner resolution you can select is up to 1200 × 1200 dpi.
  - For resolutions greater than 1200 dpi, use the Brother Scanner Utility. (See *Brother Scanner Utility* on page 13-15.)
- 6** To start scanning your document, click the **Scan** button in the Scan dialog box.

## PreScanning to crop a portion you want to scan using the scanner glass

The **Preview** button is used to preview an image for cropping any unwanted portions from the image. When you are satisfied with the preview, click the Scan button from the scanner window to scan the image.

- 1 Place the original face down on the scanner glass.
- 2 Make sure you selected Flatbed in the Paper source pull-down box (A).

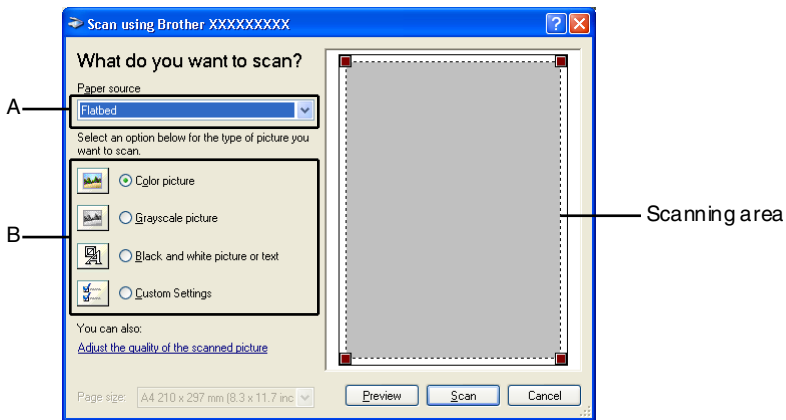

- 3 Select the picture type (B).

- In the Scan dialog box, click the **Preview** button. The entire original will be scanned into the PC and will appear in the scanning area.
- Select the portion you want to scan by clicking the left mouse button and dragging it over the area.

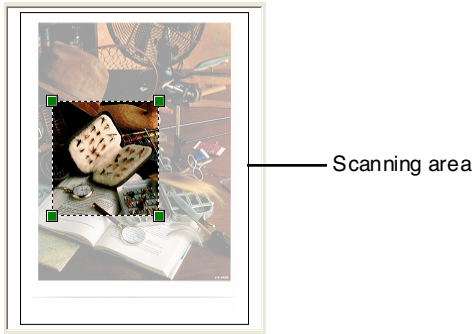

- If you require advanced settings, click **Picture Type** from the **Adjust the quality of the scanned picture (C)**. You can select **Brightness, Contrast, Resolution** and **Advanced Properties**. Click the **OK** button after you choose your settings.

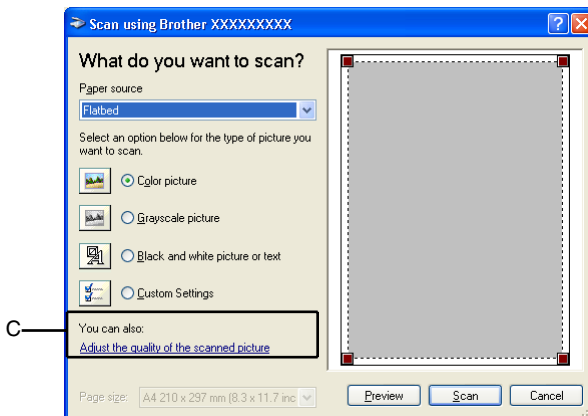

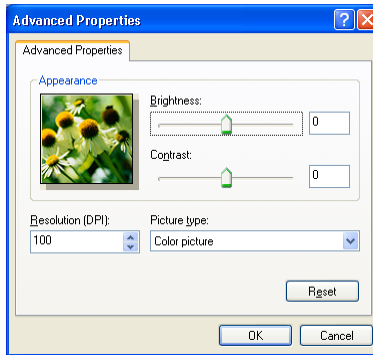

- 7 To start scanning your document, click the **Scan** button in the Scan dialog box.  
This time only the selected area of the original will appear in the PaperPort® window (or your software application window).

## Brother Scanner Utility

The Brother Scanner Utility is used for configuring the scanner driver for resolutions greater than 1200dpi and for changing the paper size. If you want to set Legal size as the default size, change the setting using this utility. You must restart your PC for the new settings to take effect.

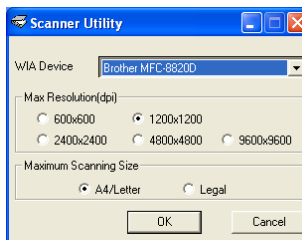

### To run the utility:

You can run the utility by selecting the **Scanner Utility** located in the **Start/All Programs/Brother/Brother MFL-Pro Suite** menu.



 Scanning at resolutions greater than 1200dpi may cause problems with some scanning applications.



# Using the scan key (For USB or Parallel interface cable users)

You can use  (**Scan**) on the control panel to scan originals into your word processing, graphics or E-mail applications or your computer folder. The advantage of using  (**Scan**) is that you avoid the mouse clicks required to scan from your computer.



## For Scan to E-mail, Scan to Image, Scan to OCR and Scan to File

Before you can use  (**Scan**) on the control panel, you must have connected the MFC to your Windows® based computer and loaded the appropriate Brother Drivers for your version of Windows®.

When you are ready to use  (**Scan**), make sure the Brother Control Center application is running on your computer. For details about how to configure the Brother Control Center buttons to launch the application of your choice using  (**Scan**), go to the appropriate chapter:

- For Windows® 95/98/98SE/Me/2000 Professional and Windows NT® WS 4.0, see *Using the Brother Control Center for Windows® 95/98/98SE/Me/2000 Professional and Windows NT® WS 4.0* on page 14-1.
- For Windows® XP, see *Using the Windows®-Based Brother SmartUI Control Center* on page 15-1.
- If your MFC is connected with both a USB and a Parallel cable, you need to select USB or Parallel as the destination in each step.



## Scan to E-mail

---

You can either scan a black and white or color original into your E-mail application as a file attachment. You can change the  (**Scan**) configuration. (See *Scan to E-mail* on page 14-10 to 14-11.) (For Windows® XP: See *Hardware Section: Changing the Scan to button configuration* on page 15-5 to 15-11.)

**1** Place the original face up in the ADF, or face down on the scanner glass.

**2** Press  (**Scan**).

**3** Press  or  to select Scan to E-Mail.

Press **Set**.

The MFC will scan the original, create a file attachment, and launch your E-mail application, displaying the new message waiting to be addressed.

|                  |
|------------------|
| ▲ Scan to E-mail |
| Scan to Image    |
| Scan to OCR      |
| ▼ Scan to File   |
| Select ▲▼ & Set  |

## Scan to Image

---

You can scan a color picture into your graphics application for viewing and editing. You can change the  (**Scan**) configuration. (See *Scan to Image* on page 14-14.) (For Windows® XP: See *Hardware Section: Changing the Scan to button configuration* on page 15-5 to 15-11.)

**1** Place the original face up in the ADF, or face down on the scanner glass.

**2** Press  (**Scan**).

**3** Press  or  to select Scan to Image.

Press **Set**.



The MFC will start the scanning process.

|                  |
|------------------|
| ▲ Scan to E-mail |
| Scan to Image    |
| Scan to OCR      |
| ▼ Scan to File   |
| Select ▲▼ & Set  |

## Scan to OCR

---

If your original is text, you can have it converted by ScanSoft® TextBridge® to an editable text file and then have the result displayed in your word processing application for viewing and editing. You can change the  (**Scan**) configuration. (See *Scan to OCR (Word Processor)* on page 14-12 to 14-13.) (For Windows® XP: See *Hardware Section: Changing the Scan to button configuration* on page 15-5 to 15-11.)



- 1 Place the original face up in the ADF, or face down on the scanner glass.
- 2 Press  (**Scan**).
- 3 Press  or  to select Scan to OCR.  
Press **Set**.  
The MFC will start the scanning process.

|                  |
|------------------|
| ▲ Scan to E-mail |
| Scan to Image    |
| Scan to OCR      |
| ▼ Scan to File   |
| Select ▲▼ & Set  |

## Scan to File

---

You can scan a black and white or a color original into your computer and save it as a file in the folder you choose. The file type and specific folder are based on the settings you have chosen in the Scan to File screen of the Brother MFL-Pro Control Center. (See *Scan to File* on page 14-8 to 14-9.) (For Windows® XP: See *Hardware Section: Changing the Scan to button configuration* on page 15-5 to 15-11.)

- 1 Place the original face up in the ADF, or face down on the scanner glass.
- 2 Press  (**Scan**).
- 3 Press  or  to select Scan to File.  
Press **Set**.
- 4 The MFC will start the scanning process.

|                  |
|------------------|
| ▲ Scan to E-mail |
| Scan to Image    |
| Scan to OCR      |
| ▼ Scan to File   |
| Select ▲▼ & Set  |

# Using ScanSoft® PaperPort® and TextBridge® OCR

ScanSoft® PaperPort® for Brother is a document management application. You will use PaperPort® to view scanned documents. PaperPort® has a sophisticated, yet easy-to-use, filing system that will help you organize your graphics and text documents. It allows you to combine or “stack” documents of different formats for printing, faxing or filing.

ScanSoft® PaperPort® can be accessed through the ScanSoft® PaperPort® program group.

See *Documentation for ScanSoft® PaperPort® on the CD-ROM.*

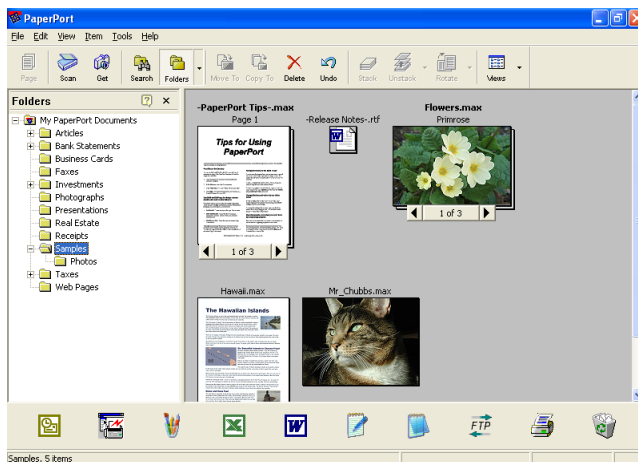

The complete ScanSoft® PaperPort® Users Guide, including ScanSoft® TextBridge® OCR, is in the documentation on the CD-ROM.

This chapter is only an introduction to the basic operations.

When you install MFL-Pro Suite, ScanSoft® PaperPort® for Brother and ScanSoft® TextBridge® OCR are installed with it automatically.

 If you are using Windows® XP, Windows NT® 4.0 or Windows® 2000 Professional, we recommend that you are logged on with administrator rights.

# Viewing items

ScanSoft® PaperPort® provides several ways to view items:

**Desktop View** displays a thumbnail (a small graphic that represents each item in a Desktop or folder).

Items in the selected folder appear on the PaperPort® Desktop. You can see PaperPort® items (MAX files) and non-PaperPort® items (files created using other applications).

Non-PaperPort® items include an icon that indicates the application that was used to create the item; a non-PaperPort® item is represented by a small rectangular thumbnail and not an actual image.

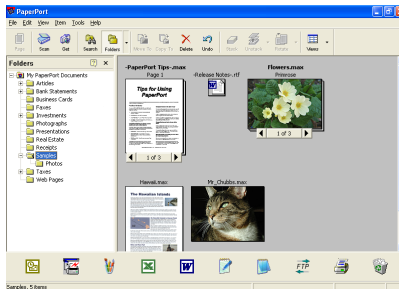

Desktop View displays items as thumbnails

**Page View** displays a close-up of a single page and you can open a PaperPort® item by double-clicking on it.

As long as you have the appropriate application on your computer to display it, you can also double-click a non-PaperPort® item to open it.

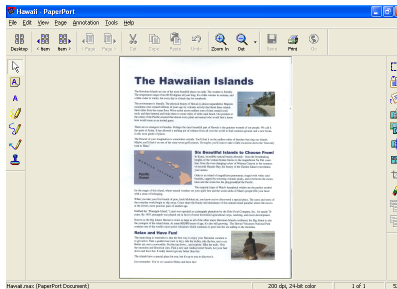

Page View displays each item as a full page

## Organizing your items in folders

---

PaperPort® has an easy-to-use filing system for organizing your items. The filing system consists of folders and items that you select to view in Desktop View. An item can be a PaperPort® item or a non-PaperPort® item:

- Folders are arranged in a “tree” structure in the Folder View. You use this section to select folders and view their items in Desktop View.
- You can simply drag and drop an item onto a folder. When the folder is highlighted, release the mouse button and the item is stored in that folder.
- Folders can be “nested”—that is, stored in other folders.
- When you double-click a folder, its items (both PaperPort® MAX files and non paperport® files) appear on the Desktop.
- **You can also use Windows® Explorer to manage the folders and items shown in Desktop View.**

## Quick links to other applications

---

ScanSoft® PaperPort® automatically recognizes many other applications on your computer and creates a “working link” to them. The Send To Bar at the bottom of the Desktop view shows icons of those linked applications.

To use a link, drag an item onto one of the icons to start the application represented by the icon. A typical use of the Send To Bar is to select an item and then fax it.

This sample Send To Bar shows several applications with links to PaperPort®.



If PaperPort® does not automatically recognize one of the applications on your computer, you can manually create a link using the **Add to Send To Bar...** command.

(See PaperPort® in the Documentation section on the CD-ROM for more information about creating new links.)

# ScanSoft® TextBridge® OCR lets you convert image text into text you can edit

---

Software by:



ScanSoft® TextBridge® OCR is installed automatically with PaperPort® when you install MFL-Pro Suite on your computer.

ScanSoft® PaperPort® can quickly convert the text on a ScanSoft® PaperPort® item (which is really just a picture of the text) into text that you can edit with a word processing application.

PaperPort® uses the optical character recognition application ScanSoft® TextBridge®, which comes with PaperPort®

—OR—

PaperPort® can use your preferred OCR application if it is already on your computer. You can convert the entire item, or by using the **Copy Text** command, you can select only a portion of the text to convert.

Dragging an item onto a word-processing link icon starts PaperPort®'s built-in OCR application, or you can use your own OCR application.



## You can Import items from other applications

---

In addition to scanning items, you can bring items into PaperPort® in a variety of ways and convert them to PaperPort® (MAX) files in several different ways:

- Print to the Desktop View from another application, such as Microsoft® Excel.
- Import files saved in other file formats, such as Windows® Bitmap (BMP) or Tag Image File Format (TIFF).

## You can Export items in other formats

---

You can export or save PaperPort® items in several popular file formats, such as BMP, JPEG, TIFF, or self-viewing.

For example, to create a file for an Internet Web site, export it as a JPEG file. Web pages often use JPEG files for displaying images.

### Exporting an image file

- 1** Select the **Save As** command from the **File** pull-down menu in the PaperPort® window. The **Save 'XXXXX' as** dialog box will be displayed.
- 2** Select the drive and directory where you want to store the file.
- 3** Enter the new file name and choose the file type or select a name from the **File Name** text box. (You can scroll through the **Directories** and **File Name** listing for prompting.)
- 4** Select the **OK** button to save your file, or **Cancel** to return to the PaperPort® without saving it.

# How to Uninstall PaperPort® and ScanSoft® TextBridge®

---

*For Windows® 95/98/98SE, and Windows NT® Workstation 4.0 and Windows® Me:*

Select **Start, Settings, Control Panel, Add/Remove Programs** and the **Install/Uninstall** tab.

Select **Brother Extensions for Paperport** and click the **Add/Remove** button.

Select **PaperPort® 8.0 SE** from the list and click the **Add/Remove** button.

*For Windows® 2000 Professional:*

Select **Start, Settings, Control Panel** and **Add/Remove Programs**.

Select **Brother Extensions for Paperport** and click the **Change/Remove** button.

Select **PaperPort® 8.0 SE** from the list and click the **Change** button.

*For Windows® XP:*

Select **Start, Control Panel, Add or Remove Programs** and the **Change or Remove Programs** icon.

Select **PaperPort® 8.0 SE** from the list and click the **Change** button.



# 14 Using the Brother Control Center for Windows® 95/98/98SE/Me/2000 Professional and Windows NT® WS 4.0

 If you are using Windows® 2000 Professional or Windows NT® 4.0, we recommend that you are logged on with administrator rights.

## Brother MFL-Pro Control Center

---

The Brother Control Center is a software utility that pops up on the PC screen whenever paper is put in the ADF of the MFC. This allows you to quickly and with very few mouse clicks, to access the most frequently used scanning applications. Using the Control Center stops the need to manually startup any specific applications.

The Brother Control Center provides three operations (Scan, Copy and PC-Fax):

- Scan directly to a file, E-mail, word processor or graphic application of your choice
- Copy
- PC Faxing using the Brother PC-FAX software

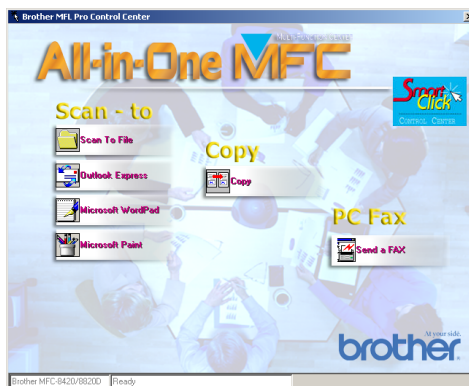



# AutoLoad the Brother Control Center

---

The Control Center is loaded every time Windows® is started.

When the Control Center is loaded, the **Control Center**  icon will appear on the task bar.



If you don't want the Control Center to load automatically, you can turn off AutoLoad.

 If the **Control Center**  icon does not appear on your task bar, you will have to launch the software.

Double-click the **Control Center**  icon on the desktop or from the **Start** menu, select **Programs, ScanSoft PaperPort 8.0**, and then click **Brother SmartUI POPUP**.

## How to turn off AutoLoad

---

- 1 Left-click the Control Center  icon and click **Show**.
- 2 When the Control Center window appears, left click the Smart Click  Control Center button.

A dialog box will appear:

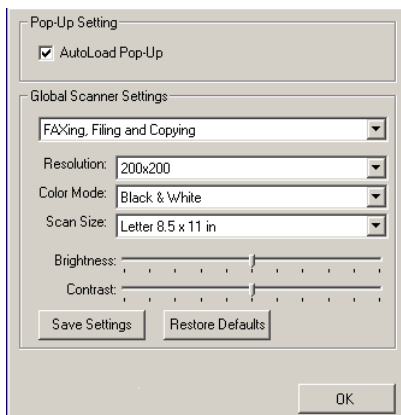

- 3 Uncheck the 'AutoLoad' Pop-Up check box.

# Brother Control Center features

## Auto Configuration

---

During installation the Control Center will check your system to set up the default applications for E-mail, word processing and the graphics viewer/editor.

For example, if you are using Outlook as your default E-mail application, the Control Center will create a link and a scanning application button for Outlook.

You can change a default application. Right-click the appropriate Control Center button to display *Configurations* and then click it. Select a different application.

For example, you can change a scan button from MS Word Pad



to MS Word



by changing the application that is listed for the Word Processor.

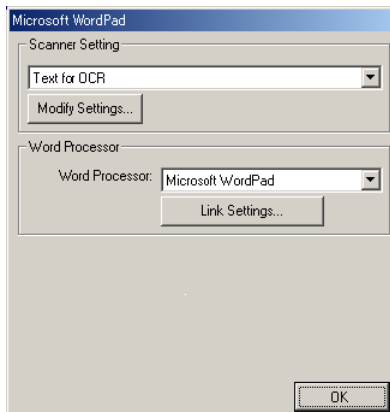

## Scan key operations

---

*Scan to File*—Lets you scan directly to a file on your computer. You can change the file type and directory for the document you are scanning.

*Scan to E-mail*—Lets you scan a picture or text document directly into an E-mail application as a standard attachment. You can choose the file type and resolution for the attachment.

*Scan to OCR (Word Processor)*—Lets you scan a text document, run ScanSoft TextBridge OCR, and insert the text original (not a graphic image) into a word processing file. You can choose the word processing application, such as Word Pad, MS Word, and so on.

*Scan to Image*—Lets you scan an image directly into any graphic viewer/editor application. You can choose the graphics application, such as Microsoft Paint.

## Copy operations

---

*Copy*—Lets you use the PC and any Windows® printer driver for enhanced copy operations.

You can scan the page on the Brother MFC and print the copies using any of the features of the Brother MFC printer driver.

—OR—

You can send the copy output to any standard Windows® printer driver that is on your PC.

## PC-Fax operation

---

*Send a Fax*—Lets you scan a picture or text original and send the image as a fax from the PC using the Brother PC-FAX software.

## Scanner settings for Scan, Copy and PC-Fax buttons

---

When the Pop-Up screen appears, you can access the Scanner Settings window.

Click the Smart Click  icon at the top right of the Brother Control Center screen

—OR—

Click the **Modify Settings** button on any of the Configuration screens.

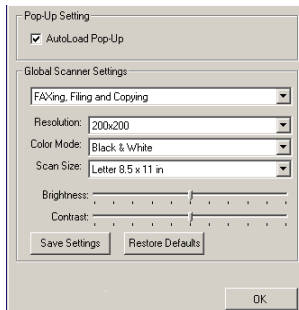

## Global settings

---

*AutoLoad Pop-Up*—Select this checkbox if you want Brother MFL Control Center to load when you turn on your computer.

## Setting up the scanner configurations

---

The Pop-Up application stores eight different scanning modes. Each time you scan an original, you can choose the most appropriate scanning mode from the following:

- Faxing, Filing and Copying*
- Text for OCR*
- Photos*
- Photos (High Quality)*
- Photos (Quick Scan)*
- Custom*
- Draft Copy*
- Fine Copy*

Each mode has its own set of stored settings. You can keep the factory default settings or change them at any time:

*Resolution*—From the pull-down list, select the scanning resolution you most often use.

*Color Mode*—From the pull-down list, select the color settings you most often use.

*Scan Size*—From the pull-down list, select the scan size you most often use.

*Brightness*—Slide the adjuster from 0% to 100%

*Contrast*—Slide the adjuster from 0% to 100%

Click **OK** to save your changes. If you make a mistake or want the original default setting, just click the **Restore Defaults** button when the scanning mode is displayed.

## Perform an operation from the Control Center screen

---

If you see this screen it means you left-clicked a button in the Control Center window without first placing an original in the ADF.

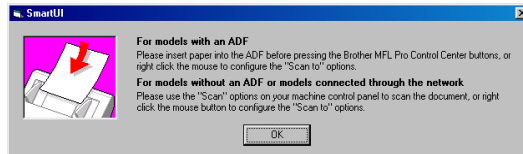

Place the original in the MFC's ADF, and then click **OK** to go to the Control Center screen.



If you want to scan the original from the scanner glass, please use  (**Scan**) on the control panel of the MFC.

# Scan to File

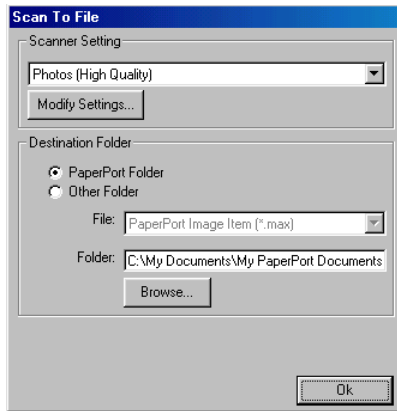

## To access Scan to File Configurations screen

---

- 1 Place the original face up in the ADF. The Brother Control Center screen will pop up.
- 2 Right-click Scan to File and click on *Configuration*. Click the **Modify Settings** button to view the configuration screen of the **Control Center**.
- 3 To save your settings, click **OK**  
—OR—  
To go back to the factory default settings, click the **Restore Defaults** button.

## Scanner settings

---

From the pull-down list, select the scanning mode that is appropriate for the type of file: **Faxing, Filing and Copying; Text for OCR; Photos; Photos (High Quality); Photos (Quick Scan); Custom; Draft Copy or Fine Copy.**

To change any of the settings for the mode, click **Modify Settings**.



## Destination folder

---

*PaperPort Folder*—Select this checkbox to scan the original in to your PaperPort folder.

*Other Folder*—Select this checkbox, to scan the original as another file type or to store it in another directory/folder.

*File*—If you selected Other folder from the pull-down list, select the type of file:

- PaperPort Image Item (\*.max)
- PaperPort Self-Viewing (\*.exe)
- PaperPort Browser-Viewable (\*.htm)
- PaperPort 5.0 Image Item (\*.max)
- PaperPort 4.0 Image Item (\*.max)
- PaperPort 3.0 Image Item (\*.max)
- Windows Bitmap (\*.bmp)
- PC Paintbrush (\*.pcx)
- PCX Multi-page (\*.dcx)
- JPEG (\*.jpg)
- TIFF-Uncompressed (\*.tif)
- TIFF-Group 4 (\*.tif)
- TIFF-Class F (\*.tif)
- TIFF Multi-page - Uncompressed (\*.tif)
- TIFF Multi-page - Group 4 (\*.tif)
- TIFF Multi-page - Class F (\*.tif)
- Portable Network Graphics (\*.png)
- FlashPix (\*.fpx)

To Search your system for the directory and folder you want, click the **Browse** button. Click **OK** to save your settings.

# Scan to E-mail

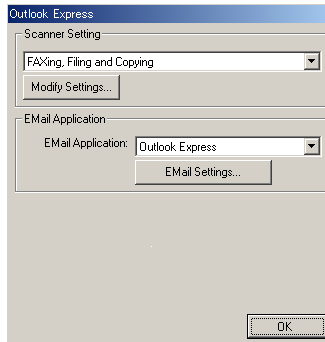

## To access Scan to E-mail Configurations screen

---

- 1 Place the original face up in the ADF. The Brother Control Center screen will pop up.
- 2 Right-click the E-mail application button and click on *Configuration*. Click the **Modify Settings** button to view the configuration screen of the **Control Center**.
- 3 To save your settings, click **OK**  
—OR—  
To go back to the factory default settings, click the **Restore Defaults** button.

## Scanner settings

---

From the pull-down list, select the scanning mode that is appropriate for the type of file: **Faxing, Filing and Copying; Text for OCR; Photos; Photos (High Quality); Photos (Quick Scan); Custom; Draft Copy** or **Fine Copy**.

To change any of the settings for this mode, click **Modify Settings**.

## E-mail application

---

**E-mail Application**—From the pull-down list, select your E-mail application.

**E-mail Settings**—Click the **E-Mail Settings** button to set up links. The **Send To Options** window will appear:

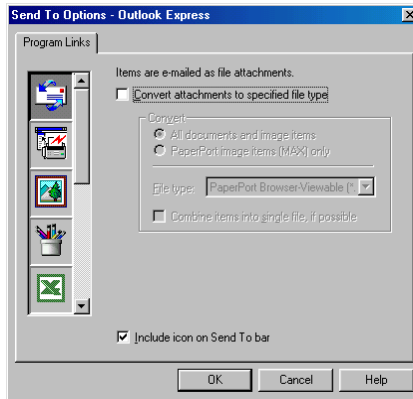

## Send to Options

---

**Convert attachments to specified file type**—Converts items to the type in the **File Type** box. Clear this check box to keep files in their source format; for example, to keep Word documents in the .doc format and JPEG images in the .jpg format.

**All documents and image items**—Converts all items regardless of the program in which the item was created; for example, converts all Word (doc) files and JPEG (.jpg) files to the file type.

**PaperPort image items (max) only**—Converts only PaperPort image items (.max) files. PaperPort does not convert other file types, such as JPEG images and Word documents.

**File type**—Identifies the format in which to convert items; for example, JPEG or TIFF.

**Combine items into single file, if possible**—Combines all selected items into a single file that contains multiple pages. This option is available only when the file type supports multiple pages, such as multi-page TIFF.

# Scan to OCR (Word Processor)

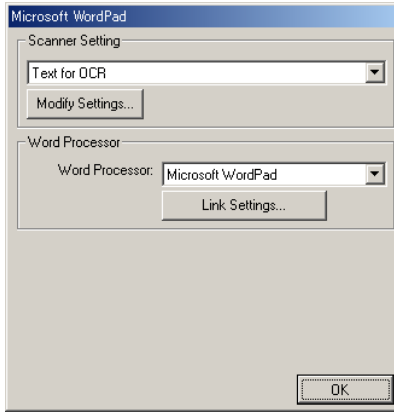

## To access Scan to OCR Configurations screen

---

- 1 Place the original face up in the ADF. The Brother Control Center screen will pop up.
- 2 Right-click the word processor application button and click on *Configuration*. Click the **Modify Settings** button to view the configuration screen of the **Control Center**.

To save your settings, click **OK**

—OR—

To go back to the factory default settings, click the **Restore Defaults** button.

## Scanner settings

---

From the pull-down list, select the scanning mode that is appropriate for the type of file: **Faxing, Filing and Copying; Text for OCR; Photos; Photos (High Quality); Photos (Quick Scan); Custom; Draft Copy or Fine Copy.**

To change any of the settings for this mode, click **Modify Settings**.

# Word Processor

**Word Processor**—From the pull-down list, select the word processor you want to use.

Click the **Link Settings** button to display the screen to set up the document format you want to use and identify the OCR program:

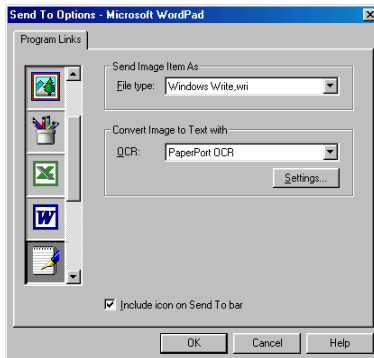

**File Type**—From the pull-down list, select the file type you want to use for your word processor or text documents.

**OCR**—Identify the OCR program to use to convert scanned document images to editable documents. This option is available only when you have an OCR program other than the one provided with PaperPort. (PaperPort 8.0 uses the same OCR engine that is in ScanSoft's TextBridge Pro Millennium product.)

Click the **Settings** button to choose how the OCR application will read the pages that you scan into your word processor application.

The **OCR Settings** window will appear:

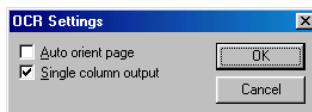

Select your setting and click **OK**.

- **Auto orient page**—Click this checkbox to automatically rotate pages so that the text is upright.
- **Single column output**—Click this checkbox if you want to remove columns from multi-column documents so that converted text appears in a one-column format.

# Scan to Image

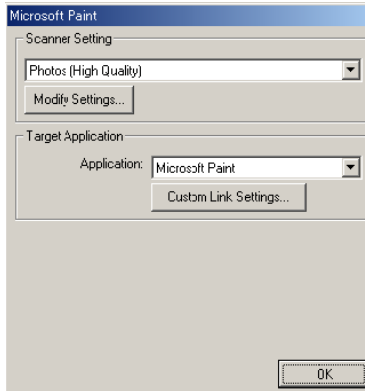

## To access Scan to Image Configurations screen

---

- 1 Place the original face up in the ADF. The Brother Control Center screen will pop up.
- 2 Right-click the graphic application button and click on *Configuration*. Click the **Modify Settings** button to view the configuration screen of the **Control Center**.

To save your settings, click **OK**

—OR—

To go back to the factory default settings, click the **Restore Defaults** button.

## Scanner Settings

---

From the pull-down list, select the scanning mode that is appropriate for the type of file: **Faxing, Filing and Copying; Text for OCR; Photos; Photos (High Quality); Photos (Quick Scan); Custom; Draft Copy** or **Fine Copy**.

To change any of the settings for this mode, click **Modify Settings**.

## Target Application

---

*Application*—From the pull-down list, select the application you want to add to this Pop-Up screen.

Click the **Custom Link Settings** button to set up links for your user-defined application.

# Copy

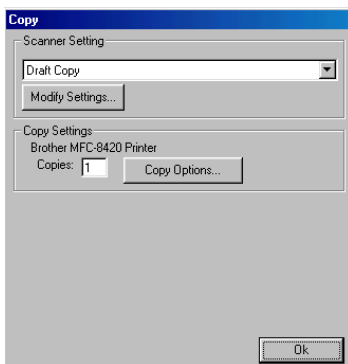

## To access the Copy Configurations screen

---

- 1 Place the original face up in the ADF. The Brother Control Center screen will pop up.
- 2 Right-click the Copy and click on *Configuration*. Click the **Modify Settings** button to view the configuration screen of the **Control Center**.

To save your settings, click **OK**

—OR—

To go back to the factory default settings, click the **Restore Defaults** button.

## Scanner settings

---

From the pull-down list, select the scanning mode that is appropriate for the type of file: **Draft Copy** or **Fine Copy**.

To change any of the settings for this mode, click **Modify Settings**.

## Number of copies

---

*Copies*—Enter the number of copies you want to print.

To change the copy options, click the **Copy Options** button.

Click **OK** to save your Copy settings.

# Send a fax

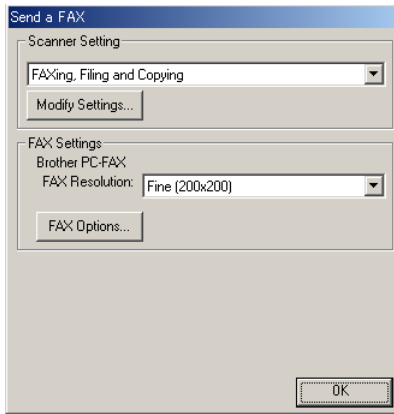

## To access the Send a fax Configurations screen

---

- 1 Place the original face up in the ADF. The Brother Control Center screen will pop up.
- 2 Right-click the Send a fax and click on *Configuration*. Click the **Modify Settings** button to view the configuration screen of the **Control Center**.

To save your settings, click **OK**

—OR—

To go back to the factory default settings, click the **Restore Defaults** button.

## Scanner settings

---

From the pull-down list, select the scanning mode that is appropriate for the type of file: **Faxing, Filing and Copying**; **Text for OCR**; **Photos**; **Photos (High Quality)**; **Photos (Quick Scan)**; **Custom**; **Draft Copy** or **Fine Copy**.

To change any of the settings for this mode, click **Modify Settings**.



# PC-FAX Settings

## Brother PC-Fax

### FAX Resolution—Fine (200 × 200)

- 1 To change the fax options, click the **FAX Options** button. The Brother PC-FAX Properties screen appears:

*For Windows® 95/98/98SE/Me and Windows NT® WS 4.0*

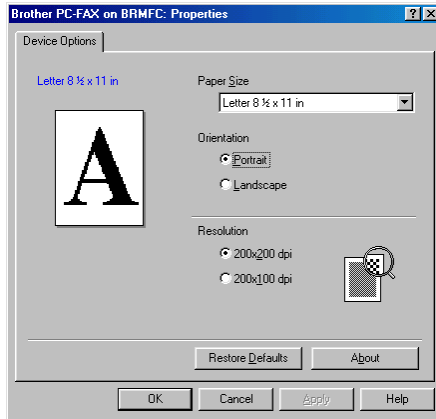

*For Windows® 2000 Professional*

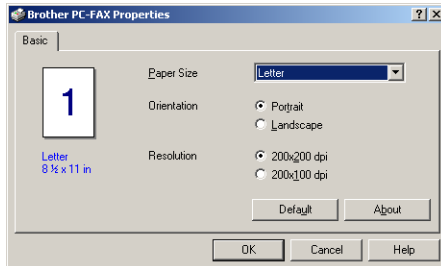

- 2 Select the Paper Size and Orientation (Portrait or Landscape) and click **OK**.

 To go back to the factory default settings, click the **Restore Defaults** or **Default** button.

# 15 Using the Windows®-Based Brother SmartUI Control Center

(For Windows® XP)

## Brother SmartUI Control Center

The Brother Control Center is a software utility that allows you to quite easily, with very few mouse clicks, access the most frequently used scanning applications. Using the Control Center eliminates the need to manually launch the specific applications and allows you to scan a document directly to a folder on your computer. The Brother Control Center provides four categories of operations:

- 1 Scan directly to a file, E-mail, word processor or graphics application of your choice.
- 2 Enhanced copy functions, such as Four/Two or One-on-One Copying.
- 3 PC Faxing using the Brother PC-Fax software.
- 4 Custom buttons allow you to configure a button to meet your own application requirements.

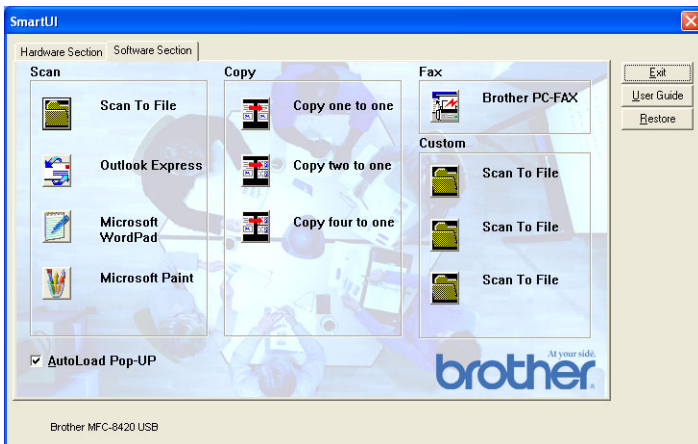

In the Task Tray right-click on the Control Center  icon and select **Show** to have access to the Brother SmartUI Control Center window.

# AutoLoad the Brother Control Center

The Control Center is initially configured to automatically load each time Windows® is started. When the Control Center is loaded the Control Center  icon will appear in the task bar. If you don't want the Control Center to load automatically, you can turn AutoLoad off.

## How to turn off Auto Load

- 1 Right-click the Control Center  icon in the Task Tray and select **Show**.
- 2 The main SmartUI Control Center window appears. Please look at the bottom of the window for a check box labeled “AutoLoad Pop-up”.

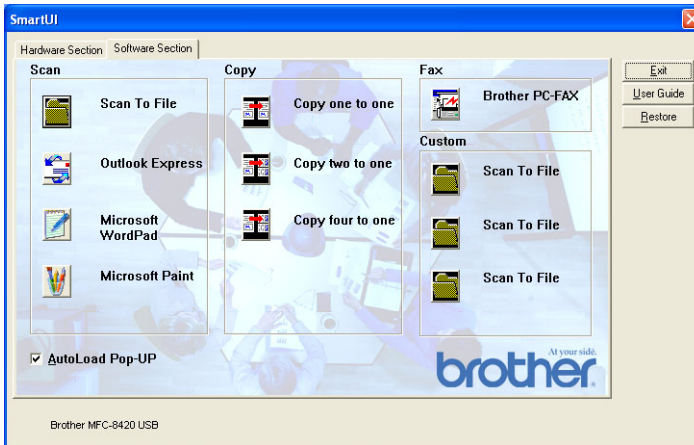

- 3 Uncheck the AutoLoad Pop-Up option to prevent the SmartUI from automatically loading every time Windows is started.

# Brother Control Center features

The SmartUI control center gives you the ability to configure the hardware **Scan** key on your MFC such as “Scan to File”. The “Scan to File” feature allows you to scan a document directly to your hard disk and choose the file format and destination folder without having to run any other applications. Select which section you want by clicking on the appropriate tab.

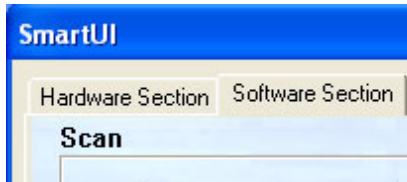

# Auto Configuration

---

During the installation process the Control Center checks your system to determine the default applications for E-mail, word processing and graphics viewer/editor.

**For example**, if you are using Outlook as your default E-mail application, the Control Center automatically will create a link and a scanning application button for Outlook.

You can change the default application by right-clicking on any of the scan buttons in the Control Center and then clicking *Configuration*. Select the Configuration tab and from the Application pull down menu select a different application. For example, you can change the E-mail scan button from Outlook Express to Outlook by changing the application that is listed.

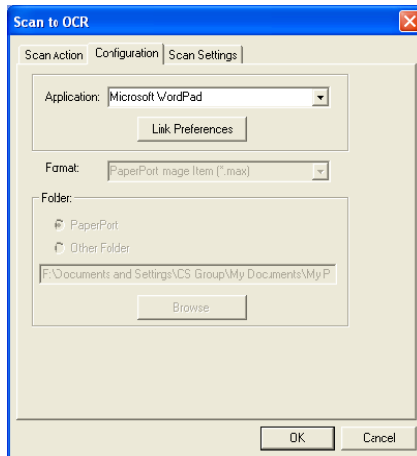

# Hardware Section: Changing the Scan to button configuration

When the SmartUI Control Center is displayed, you can access the Hardware Section window to reconfigure the  (**Scan**) button on your MFC. Click the Hardware Section tab at the top left of the SmartUI Control Center screen. (See *Using the scan key (For USB or Parallel interface cable users)* on page 13-16.)

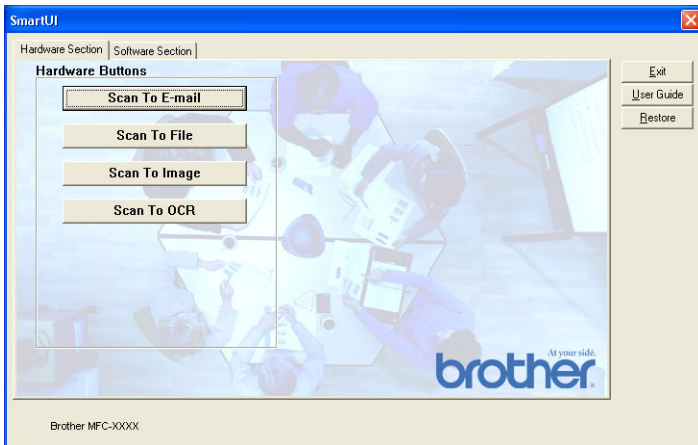

# Scan to E-mail

---

To configure the Scan to E-mail feature left-click on the **Scan to E-mail** button and the following screen will appear. You have the ability to change the configuration that includes the destination E-mail application, attachment file and the scanner settings.

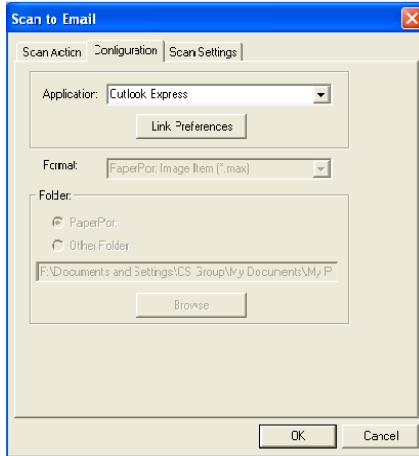

To change the destination E-mail application you use the Application pull down list to select the compatible E-mail application, which is installed on your system.

If you wish to change the attachment file type click on the **Link Preferences** button to display a list of file types.

# Scan to File

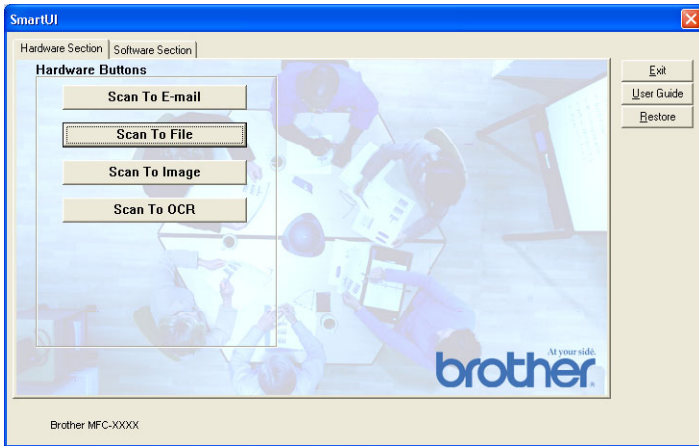

To configure the Scan to File feature, left click on the Scan to File button and the following screen will appear.

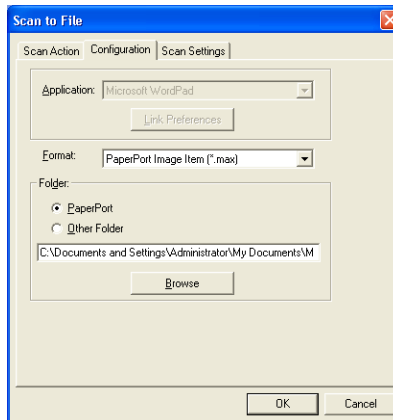

Select the file type for the saved image by selecting from the Format pull down list. You can save the file to the default PaperPort folder so the file appears in PaperPort or you can select another folder/directory by clicking the Browse button.



# Scan to Image

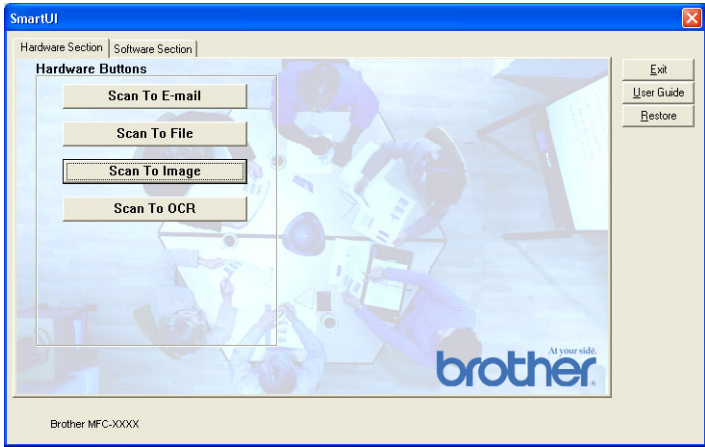

To configure the Scan to Image feature left-click on the **Scan to Image** button and the following screen will appear. You have the ability to change the configuration, which includes the destination image format or document application.

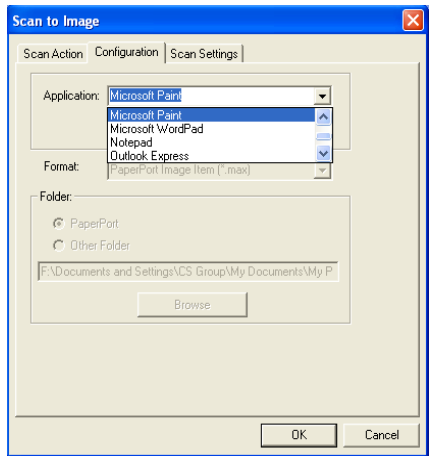

To change the default setting of the scan, click on the **Scan Settings** tab.

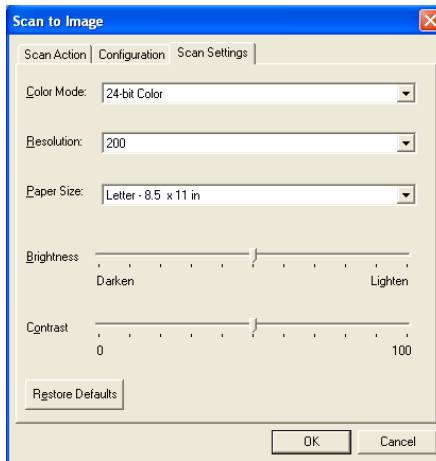

You can set the Color Mode to Black & White, 8-bit Gray or 24-bit Color.

The resolution can be changed from 100 to 1200 dpi. You can define the size of the paper you're using, and you can adjust the brightness and contrast of the image before scanning.

# Scan to OCR

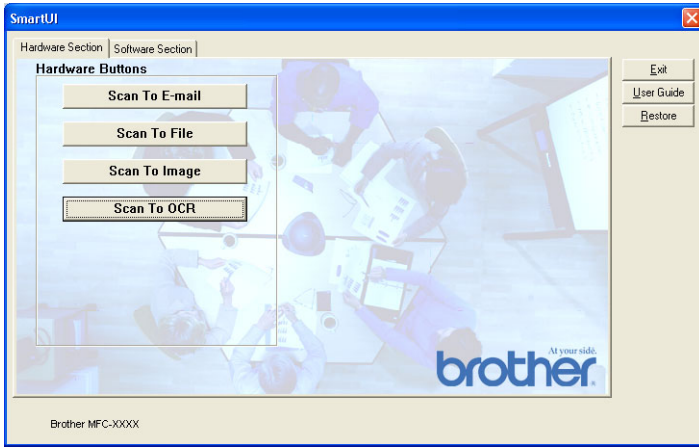

To configure the Scan to OCR feature left-click on the **Scan to OCR** button and the following screen will appear. You have the ability to change the configuration, which includes the destination applications.

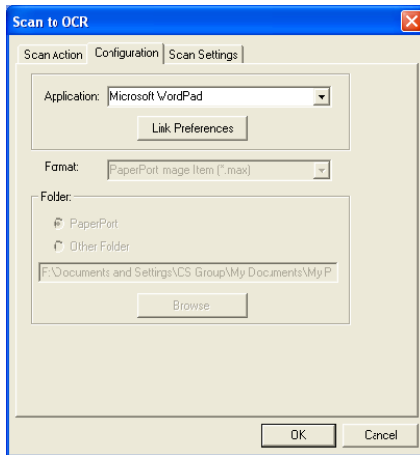

You have the option to send your scan as a different file type. You can select the application from the File Type window according to your needs.

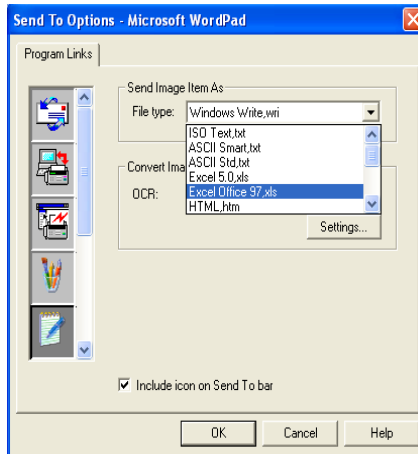

You have the option to choose your OCR setting from **Single column output** to **Auto orient page**.

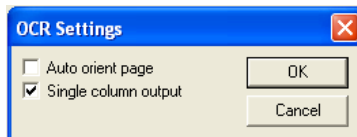

# Software Section

The Software Section contains four groups of scan to buttons. Each section has a number of different buttons which are predefined for the most frequently used applications. The **Scan** section contains four buttons for Scan to File, Scan to E-mail, Scan to Word Processor and Scan to Image applications. The **Copy** section contains four buttons for N to 1 copying. The **Fax** section button is for sending faxes using the Brother PC-FAX application and the **Custom** section contains three buttons with which you can assign your own function.



## Scan

---

\*1 *Scan to File* —enables you to scan directly to a disk file. You can change the file type and destination directory, as needed.

\*2 *Scan to E-mail (Default: Outlook Express)* —enables you to scan a page or document directly into an E-mail application as a standard attachment. You have the option of selecting the file type and resolution for the attachment.

\*3 *Scan to Word Processor (Default: MS WordPad)*—enables you to scan a page or document, automatically run ScanSoft TextBridge OCR and insert the text (not graphic image) into a word processing program. You have the option of selecting the destination word processing program, such as WordPad, MS Word, Word Perfect or whichever word processing program is installed on your computer.

\*4 *Scan to Graphic Application (Default: MS Paint)* —enables you to scan a page directly into any graphic viewer/editor application. You can select the destination application, such as MS Paint, Corel PhotoPaint, Adobe PhotoShop, or any kind of image editor application you already have installed on your computer.

## Copy

---

*Copy (Copy one to one)*—allows you to use the PC and any Windows® printer driver for enhanced copy operations. You can scan the page on the MFC and print the copies using any of the features of the MFC printer driver—**OR**—you can direct the copy output to any standard Windows® printer driver installed on the PC including network printers.

*Four/Two to One Copy*—enables you to use the Four/Two on One-page features of the Brother printer driver to copy four/two original pages onto a single output page.

## Fax

---

*Send a Fax* (Brother PC-FAX)—enables you to scan a page or document and automatically send the image as a fax from the PC using the Brother PC-FAX software.

## Custom

---

*Scan to File*—These buttons have been pre-programmed for the Scan to File feature. You can change the configuration of each of these buttons to meet your specific requirements by right-clicking on a button and following the configuration menus.

# Scan to File

The Scan to File button allows you to scan an image and save it in a specific file type to any directory on your hard disk. This allows you to easily archive your paper documents. To configure the file type and save to directory right-click on the Scan to File button and click Configuration.

The Scan Action tab is set to File and should not be changed.

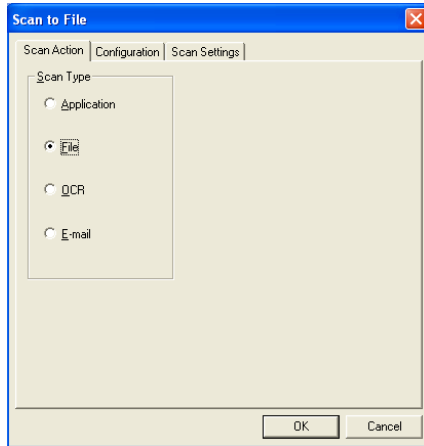



To change the configuration click on the Configuration tab.

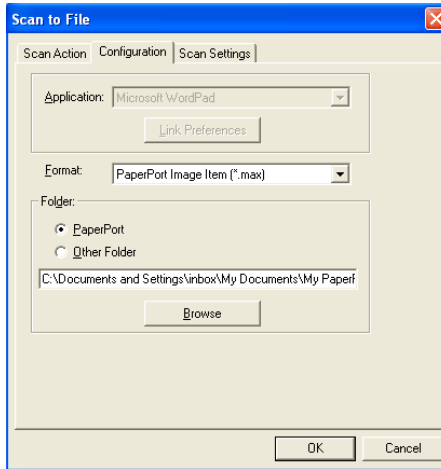

Select the file type for the saved image by selecting from the Format pull down list. You can save the file to the default PaperPort folder so the file appears in PaperPort, or you can select another folder/directory by clicking the Browse button.

You can change the default setting by selecting the Other Folder button and then clicking Browse and selecting the folder in which you wish to save your files.

# Scan to E-mail

The Scan to E-mail is automatically configured to your default E-mail application. To change the default E-mail application or attachment file type, right-click on the E-mail button and select “Configuration”. The Scan Action tab is set to E-mail and should not be changed.

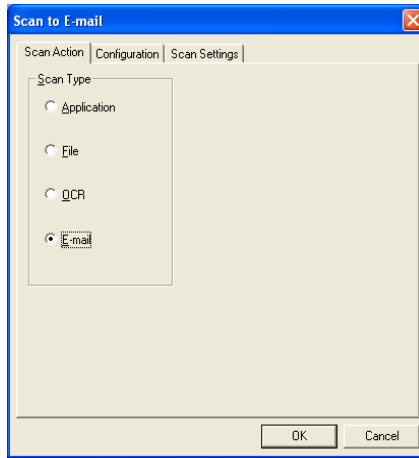

To change the E-mail application click on the Configuration tab. From the Application pull down list, select your preferred E-mail application.

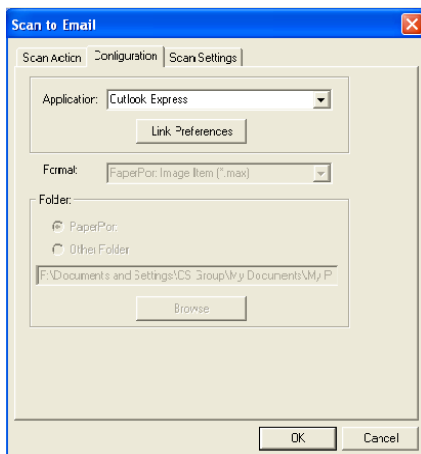

To change the file type of the attachment click the **Link Preferences** button to set up links. Check the **Convert attachment to specified file type** box and then select the appropriate file type from the pull down list.

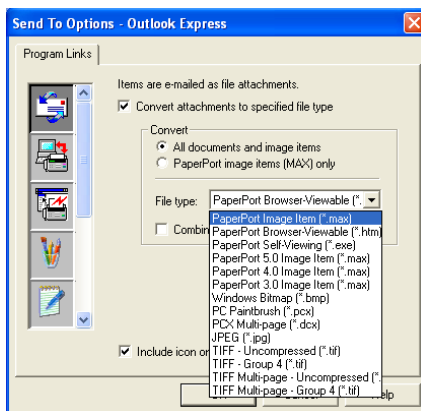

## File attachments

---

Items are mailed as file attachments using the file type you have selected.

*Convert attachments to specified file type*—Click this check box if you want to change the file type of attachments.

*All documents and image items*—Click this check box if you want to convert all scanned images to the same file type.

*PaperPort image items (MAX) only*—Click this check box if you want to convert only attachments that are PaperPort MAX files.

*Combine items into single file, if possible*—Click this check box if you want to combine all the attachments into one file. With this box unchecked each scanned page will be saved in its own individual file.

*File Type*—Select from the pull-down list the type of file you want the scanned images to be saved in.

- PaperPort Image Item (\*.max)
- PaperPort Browser-Viewable (\*.htm)
- PaperPort Self Viewing (\*.exe)
- PaperPort 5.0 Image Item (\*.max)
- PaperPort 4.0 Image Item (\*.max)
- PaperPort 3.0 Image Item (\*.max)
- Windows Bitmap (\*.bmp)
- PC Paintbrush (\*.pcx)
- PCX Multi-page (\*.dcm)
- JPEG (\*.jpg)
- TIFF-Uncompressed (\*.tif)
- TIFF Group 4 (\*.tif)
- Multi-Page -Uncompressed (\*.tif)
- Multi-Page - Group 4 (\*.tif)

# Scanner settings

---

You have the ability to change the scanner settings used to create the file attachments. Click on the Scan Settings tab and select the appropriate settings.

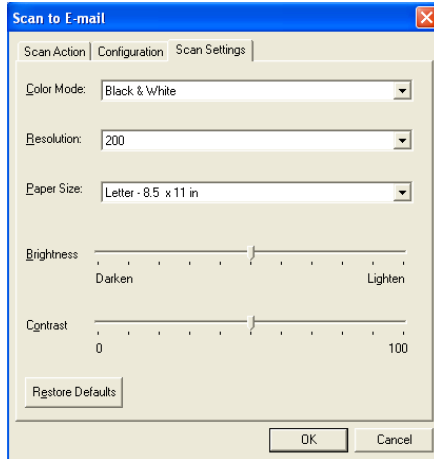

# Scan to OCR (Word Processing program)

Scan to OCR converts the graphic page image data to text which can be edited by any word processor program. You can change the default word processor program (example: Word Pad instead of Word) and file type. You can also choose another OCR software package besides the TextBridge OCR which is built into PaperPort. To configure Scan to OCR right-click on the WordPad button and select Configuration. The Scan Action tab is set to OCR and should not be changed.

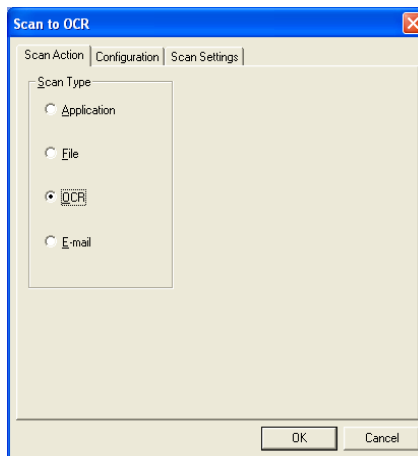

To change the word processing application click on the Configuration Tab. You can select the destination word processing application from the Application pull down list.

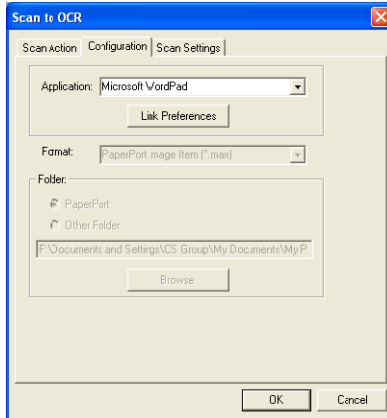

To change the program link preferences click the Link Preferences button.

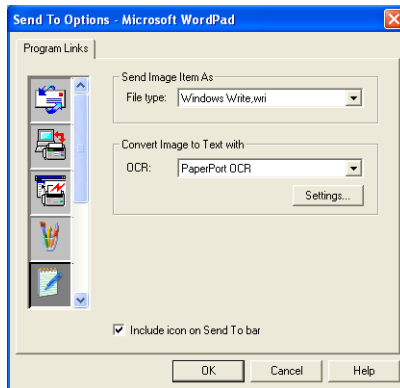

*File Type*—From the pull-down list, select the file format you want to use for documents.

*OCR*—Select the OCR application from the OCR pull down list.

# Scan to Graphics application (example: Microsoft Paint)

The Scan to Graphics Application allows you to scan an image so you can edit the image. To change the default graphics application right-click on the button and select Configuration.

The Scan Action tab is set to Application and should not be changed.

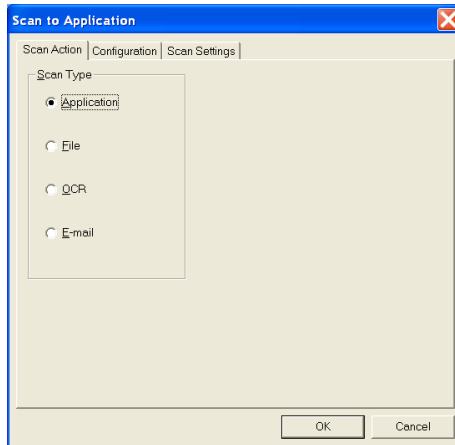

To change the configuration of the destination application click on the Configuration Tab.

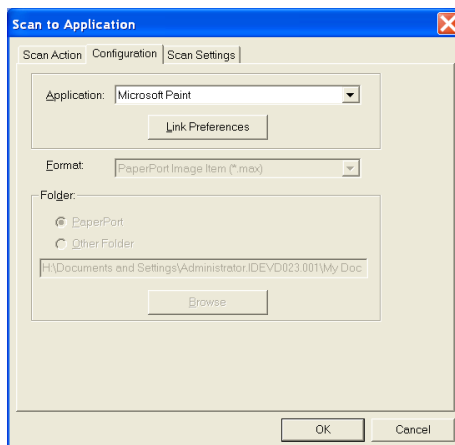



To change the destination application select the appropriate application from the Application pull down list.

To change the other configuration options click the Link Preferences button.

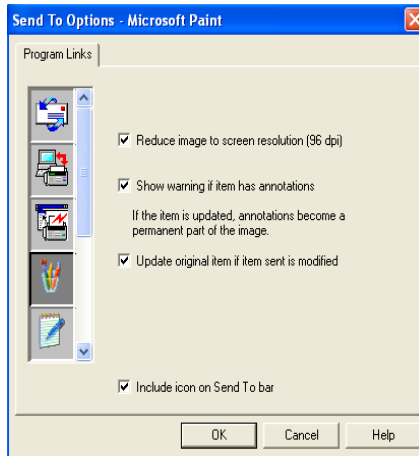

This option enables you to reduce image to screen resolution (96dpi), show a warning if the item has annotations, update the original item if sent item is modified, if needed.

# Copy

The copy buttons can be customized to allow you to take advantage of the features built into the Brother printer drivers to do advanced copy functions such as n-in-1 printing.

The Copy buttons are automatically linked to the default Windows printer driver. You can set any printer as the default printer including non-Brother printers. Before you can use the Copy buttons you must first configure the printer driver by right-clicking on a Copy button and selecting Configuration.

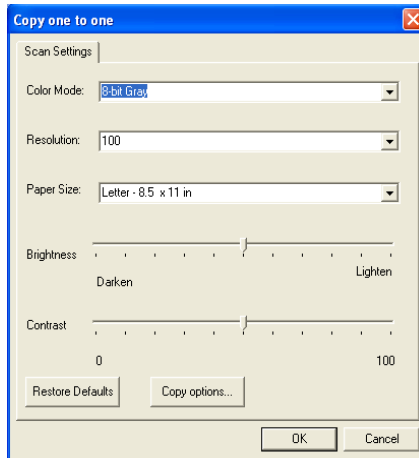

In the Scan Settings window you can select the color mode, resolution, paper size, brightness and contrast settings to be used. To finish the Copy button configuration you must set the printer driver. Click the Copy options button to display the printer driver settings.



The copy options screen will vary depending upon which Brother model you purchased.

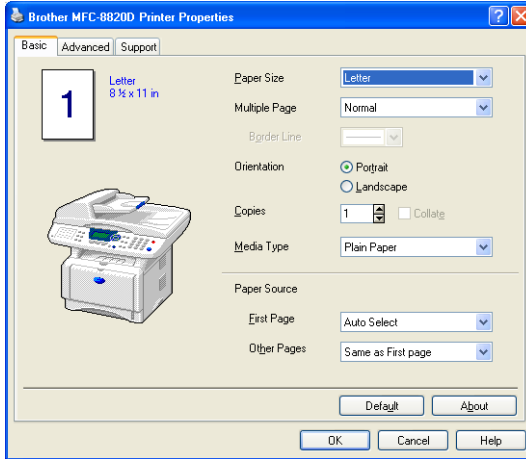

Select the number of Pages Per Sheet from the Scaling selections. As an example to configure the section Copy button to copy two pages to one you must select 2 in 1 .



You must configure each of the copy buttons before they can be used.

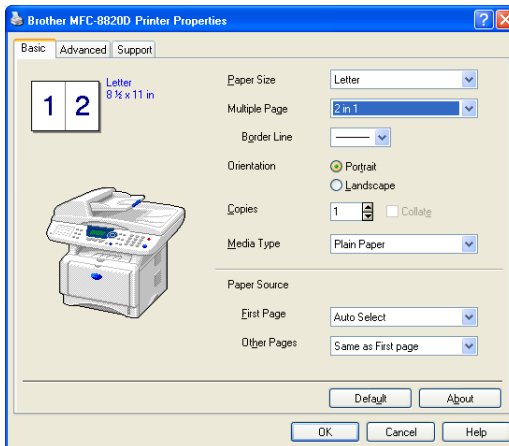

# Fax setting (PC-Fax using the Brother Fax Driver)

The MFC includes a PC-Fax driver, which allows any Windows Application to send a Fax as simply as printing a document. The Brother SmartUI automatically configures the Fax button to use the Brother PC-FAX driver no user configuration is required.

The Scan Action tab is set to Application and should not be changed.

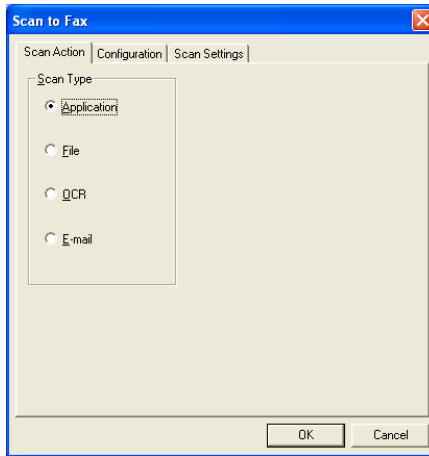

To change the PC-FAX settings click the Link Preferences button found in the configuration tab.

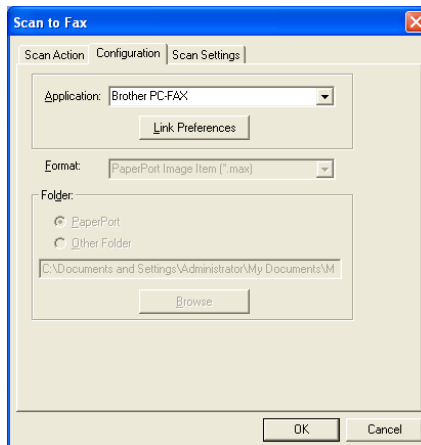

# FAX settings

## Brother PC-FAX

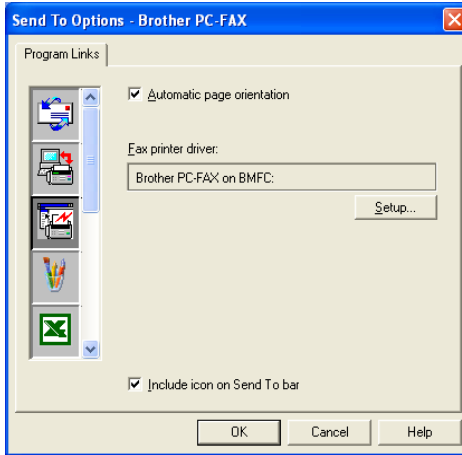

To change the driver settings, click on the Setup button. Select the *Paper Size*, *Paper Source*. If you need more customized setup, click on the Options button.

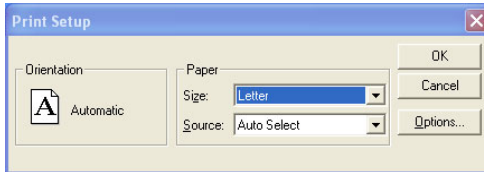

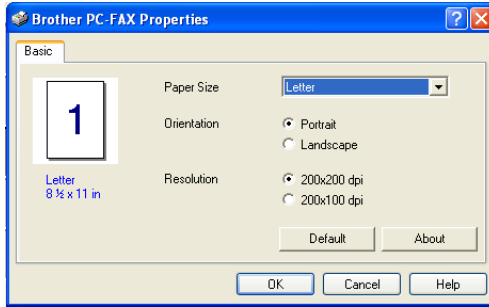

Select the *Paper Size*, *Orientation* (Portrait or Landscape) and *Resolution* (200x200 dpi or 200x100 dpi), and click **OK**.

To return to the factory default settings, click the **Default** button.

# Custom: User-defined buttons

There are up to three Custom buttons on the Brother SmartUI Control Center. (NOTE: The number of Custom buttons depends on which Brother model you purchased.) You can set your own preferences and configuration to fit your required application.

To configure a Custom Button right click on the button and then click Configuration. The configuration window will appear. You have four function choices Application, File, OCR and Email.

**Application:** This setting will link the Control Panel button to any button which appears on the PaperPort Send to Bar. Please see the PaperPort help file for more information regarding PaperPort compatible applications.

**File:** This setting allows you to save a scanned image to any directory on local or network hard disk. You can also select the file format to be used.

**OCR:** Scanned documents will be converted to editable text files. If you have a third party OCR software package installed on your PC you can select it. The default OCR software is TextBridge which is built into PaperPort 8.0. You can also select the destination word processor and file format for the editable text.

**E-mail:** Scanned images will be attached to an email message. You can choose which E-mail package to use if you have more than one installed on your system. You can also select the file type for the attachment and create a quick send list of E-mail addresses chosen from your default E-mail address book.

## Customizing a user-defined button

---

To configure a Custom button right-click on the button and then click Configuration. Please follow the following guide lines for Custom Button configuration.

### 1. Select the Scan Action

Select the type of scan by clicking the appropriate button.

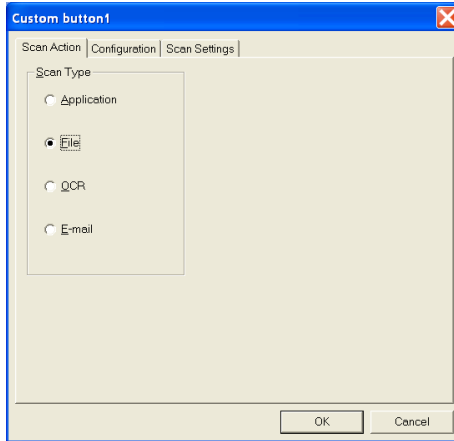

## 2. Select Configuration for the Scan Type.

To configure the scan operation click on the Configuration Tab. Depending upon which Scan Type button you selected you will see a different Configuration Tab list of settings.

### Application:

Select the destination application program from the pull down list.

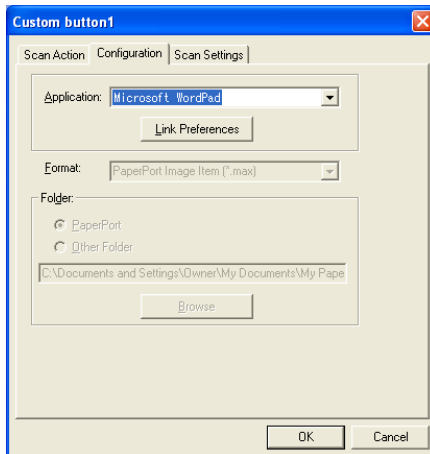

Click on Link Preferences to set the Send to options. You can select the application from the scroll menu on the left.



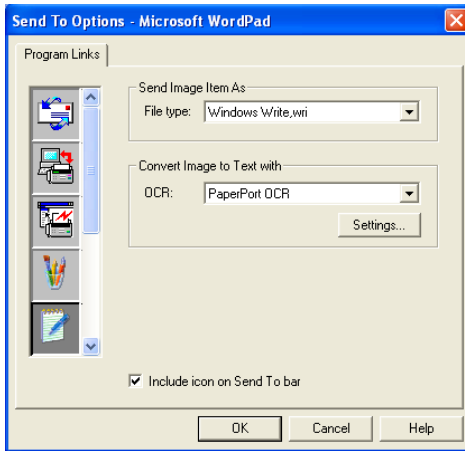

**File:**

Select the file format from the Format pull down list. You can either send the file to the default PaperPort directory or select your own destination directory by selecting Other Folder. Use the Browse button to select the destination directory.

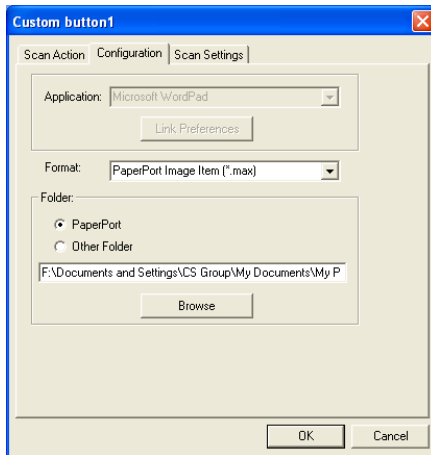

## OCR:

Select the destination word processing application program from the pull down list.

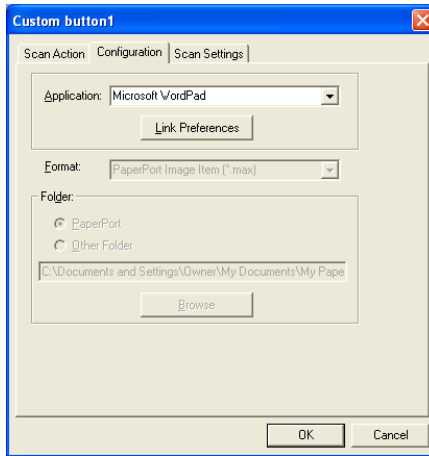

Click on Link Preferences and select the destination Application from the scroll menu on the left. Select the File Type from the File Type pull down list. You can also choose another OCR application from the OCR pull down list if another is installed on your system. Scansoft® TextBridge® is installed as part of the PaperPort 8.0 application.

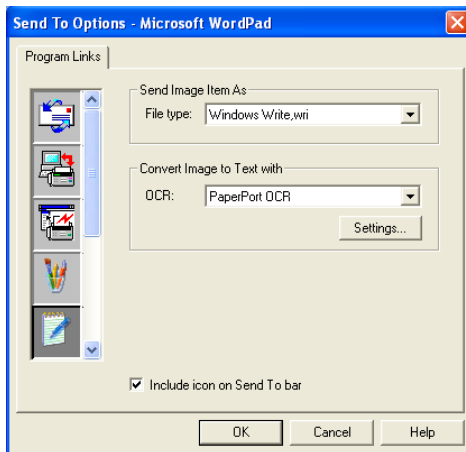

## E-mail:

Select the destination E-mail application program from the pull down list.

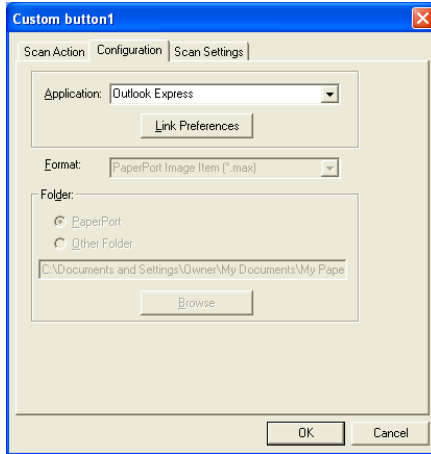

Click on the **Link Preferences** button to configure the Send To E-mail options. You can select the File type and Quick Send E-mail address list.

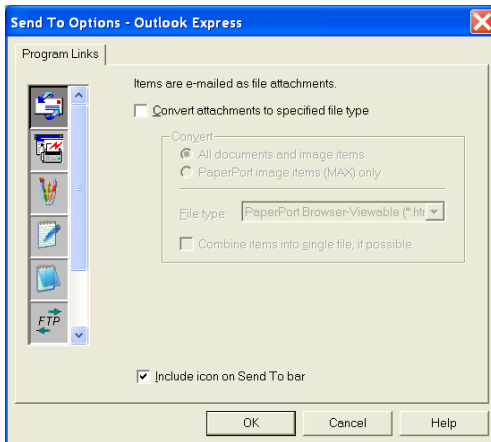

### 3. Select Scan Settings.

You can select the scanner settings from each of the Scan Type options for the Custom buttons. You have the option to select Color Mode, Resolution, Paper Size and Brightness and Contrast settings.

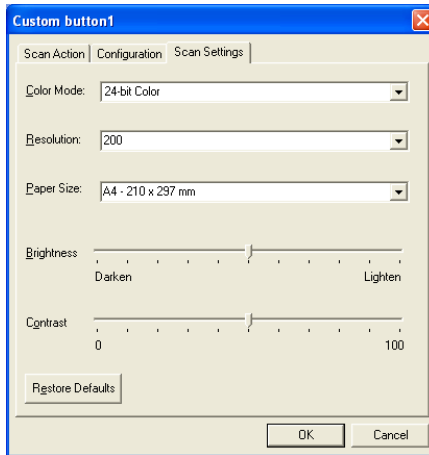

# 16 Using MFC Remote Setup

(For Windows®)

## MFC Remote Setup

The MFC Remote Setup application lets you set up your MFC by using the ease and speed of programming on your PC. When you access this application, the settings on your MFC will be downloaded to your PC and displayed on your computer screen. If you change the settings, you can upload them directly to the MFC.



You can't use the MFC Remote Setup application if your MFC is only connected to a Network with the optional Network LAN board (NC-9100h). (See Web Based Management in the NC-9100h User's Guide.)

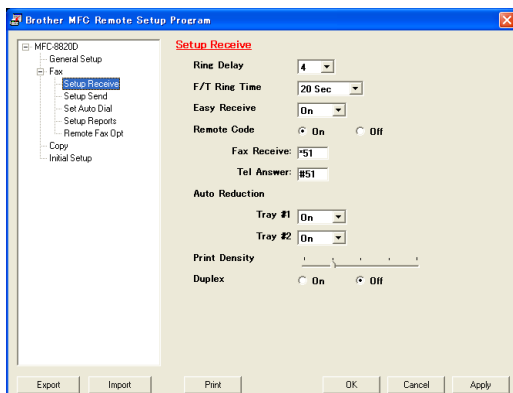

### OK button

When you click **OK**, the process of uploading the data to the MFC begins. The MFC Remote Setup program is closed if an error message is displayed, enter the correct data again and then click **OK**.

### Cancel button

The **Cancel** button clears your changes and exits the MFC Remote Setup application without uploading any data to the MFC.

### Apply button

The **Apply** button uploads the data to the MFC, but stays in the Remote Setup application so you can make more changes.

## Print button

The **Print** button prints the selected items on the MFC. You cannot print the MFC Remote Setup changes until you click the **Apply** button to upload the new data to the MFC. Then you can click the **Print** button to get an up-to-date printout.

## Export button

Click the **Export** button to save your current settings to a file.

## Import button

Click the **Import** button to read the settings from your saved file into the MFC Remote Setup screen.



You can use the **Export** and **Import** buttons to save and use several sets of settings for your MFC.

# 17 Using Brother PC-FAX software

(For Windows®)

## PC-FAX sending

The Brother PC-FAX feature lets you send a file from your PC.

You can create a file in any application on your PC, and then send it as a PC-FAX. You can even attach a cover page note.

All you have to do is set up the receiving parties as Members or Groups in your PC-FAX Address Book. Then you can use the Address Book Search feature to quickly find them to address your fax.



- PC-FAX is available in Black & White only.
- If you are using Windows® XP, Windows NT® 4.0 or Windows® 2000 Professional, you need to log on with administrator rights.

# Setting up user information



You can access the User Information from the FAX Sending dialog box by clicking .

(See *Sending a file as a PC-FAX using the Facsimile style* on page 17-15.)

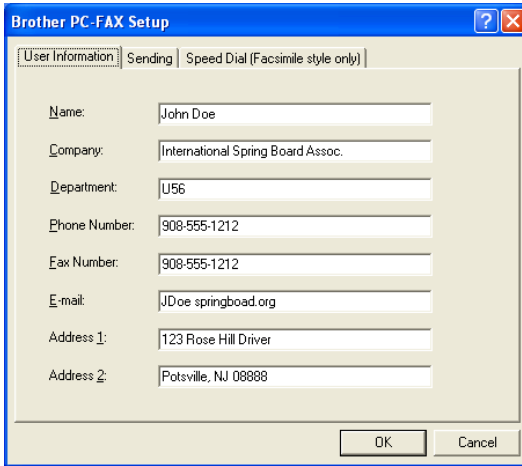

The screenshot shows the 'Brother PC-FAX Setup' dialog box with the 'User Information' tab selected. The fields are filled with the following information:

|               |                                   |
|---------------|-----------------------------------|
| Name:         | John Doe                          |
| Company:      | International Spring Board Assoc. |
| Department:   | U56                               |
| Phone Number: | 908-555-1212                      |
| Fax Number:   | 908-555-1212                      |
| E-mail:       | JDoe@springboard.org              |
| Address 1:    | 123 Rose Hill Drive               |
| Address 2:    | Potsville, NJ 08888               |

Buttons: OK, Cancel

- 1 From the **Start** menu, select **Programs**, **Brother**, **Brother MFL-Pro Suite**, and then select **PC-FAX Setup**. The **Brother PC-FAX Setup** dialog box will appear.
- 2 You must enter this information to create the Fax Header and Cover Page.
- 3 Click **OK** to save the **User Information**.



## Sending setup

From the **Brother PC-FAX Setup** dialog box, click the **Sending** tab to display the screen below.

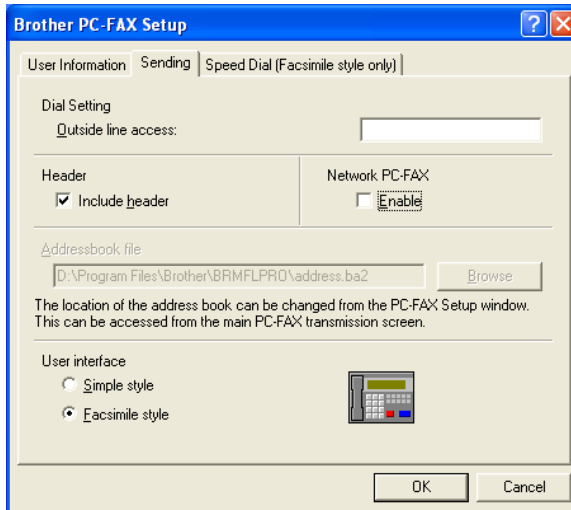

The include header option sends an additional page of information along with fax or E-mail data which contains user and subject information.

The user has the choice of two user interfaces: Simple style or Facsimile style. To change the user interface select the interface setting you want: Simple style or Facsimile style.

## Outside line access

---

If you need to enter a number to access an outside line, enter it here. This is sometimes required by a local PBX telephone system (for example, if you must dial 9, to get an outside line in your office).

## Include header

---

To add header information to the top of the fax pages you send, check the Include header box.

## Address Book file

---

You can select more than one database file to use with the Address Book. To select you must enter the path and file name of the database file.

—OR—

Use the **Browse** button to find the database to select.

## User interface

---

In the **Sending** tab, select user interface.

You can choose the **Simple Style** or the **Facsimile Style**.

### Simple style

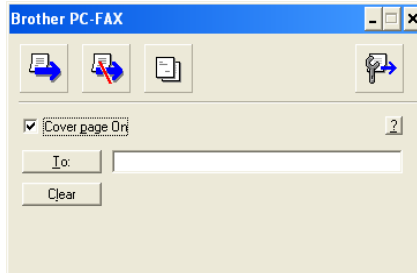

### Facsimile style



# Speed-Dial setup

From the **Brother PC-FAX Setup** dialog box, click the **Speed Dial** tab. (To use this feature you must select the **Facsimile Style** user interface.)

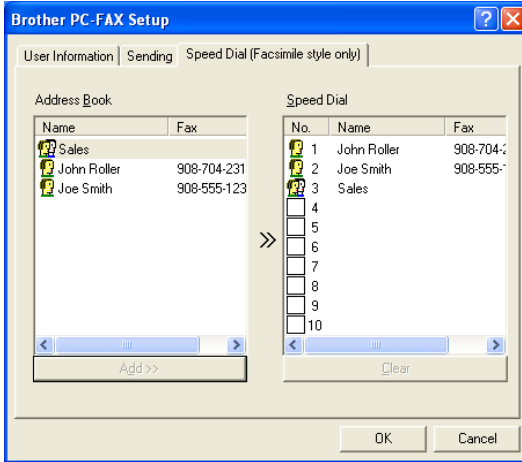

You can register a Member or Group on each of the ten Speed-Dial buttons.

## To register an address in a Speed-Dial button:

- 1 Click the Speed-Dial button you want to program.
- 2 Click the Member or Group you want to store on the Speed-Dial button.
- 3 Click **Add >>** to save it.

## To clear a Speed-Dial button:

- 1 Click the Speed-Dial button you want to clear.
- 2 Click **Clear** to erase it.

# The Address Book

---

From the **Start** menu, select **Programs**, **Brother**, **Brother MFL-Pro Suite**, and then click **PC-FAX Address Book**.

The **Brother Address Book** dialog box will appear:

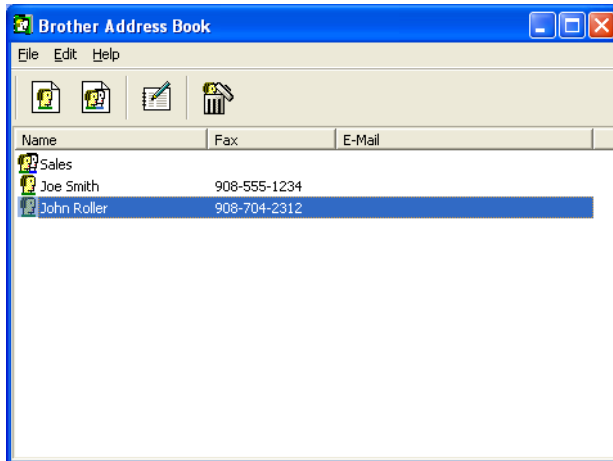

# Setting up a Member in the Address Book

In the **Brother Address Book** dialog box you can add, edit and delete stored information of Members and Groups.

- 1 In the Address Book dialog box, click the  icon to add a Member.

The **Brother Address Book Member Setup** dialog box will appear:

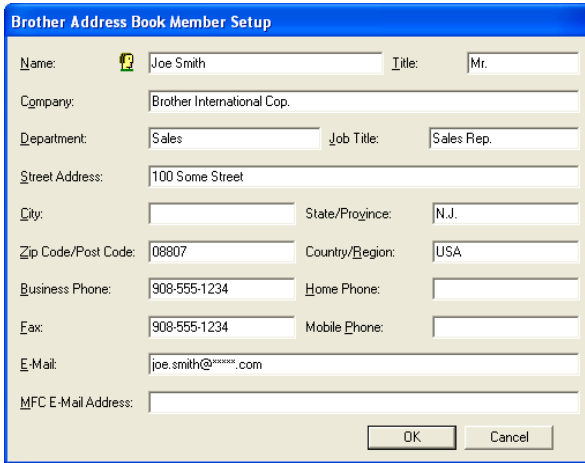

**Brother Address Book Member Setup**

|                     |                                                                                             |                 |            |
|---------------------|---------------------------------------------------------------------------------------------|-----------------|------------|
| Name:               |  Joe Smith | Title:          | Mr.        |
| Company:            | Brother International Cop.                                                                  |                 |            |
| Department:         | Sales                                                                                       | Job Title:      | Sales Rep. |
| Street Address:     | 100 Some Street                                                                             |                 |            |
| City:               |                                                                                             | State/Province: | N.J.       |
| Zip Code/Post Code: | 08807                                                                                       | Country/Region: | USA        |
| Business Phone:     | 908-555-1234                                                                                | Home Phone:     |            |
| Fax:                | 908-555-1234                                                                                | Mobile Phone:   |            |
| E-Mail:             | joe.smith@*****.com                                                                         |                 |            |
| MFC E-Mail Address: |                                                                                             |                 |            |

OK Cancel

- 2 In the Member Setup dialog box, type the Member's information. **Name** is a required field. Click **OK** to save the information.

## Setting up a Group for Broadcasting

---

If you often send the same PC-FAX to several Members, you can combine them in a Group.

- 1 In the **Brother Address Book** dialog box, click the  icon to create a Group.

The Group Setup dialog box appears:

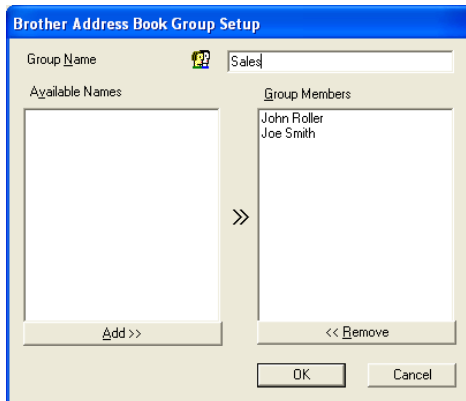

- 2 Type the name of the new Group in the **Group Name** field.
- 3 In the **Available Names** box, select each Member to be included in the Group, and then click **Add >>**. Members you add to the Group will be added to the **Group Members** box.
- 4 After all the members you want have been added, click **OK**.

## Editing Member information

---

- 1 Select the Member or Group you want to edit.
- 2 Click the edit  icon.
- 3 Change the Member or Group information.
- 4 Click **OK** to save your changes.

## Deleting a Member or Group

---

- 1 Select the Member or Group you want to delete.
- 2 Click the delete  icon.
- 3 When the **Confirm Item Delete** dialog box appears, click **OK**.

## Exporting the Address Book

---

You can export the whole Address Book to an ASCII text file (\*.csv). Or if you wish, you can select and create a Vcard that will be attached to that Member's outgoing E-mail. (A Vcard is an electronic business card that contains the sender's contact information.)

### To export the whole current Address book:

-  If you are creating a Vcard, you must first select the member.  
If you select Vcard in Step 1, **Save as type:** will be **Vcard (\*.vcf)**.

- 1 From the Address Book select **File**, point to **Export**, and then click **Text**.

—OR—

Click **Vcard** and go to Step 5.

- 2 From the **Available Items** column, select the data fields you wish to Export and then click **Add >>**.

-  Select the items in the order you want them listed.

- 3 If you are exporting to an ASCII file, select the **Divide Character** - **Tab** or **Comma**. This selects between a **Tab** or **Comma** to separate the data fields.



#### 4 Select **OK** to save the data.

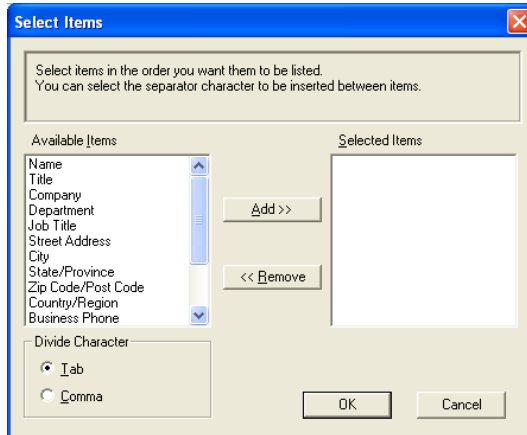

#### 5 Type the name of the file, and then select **Save**.

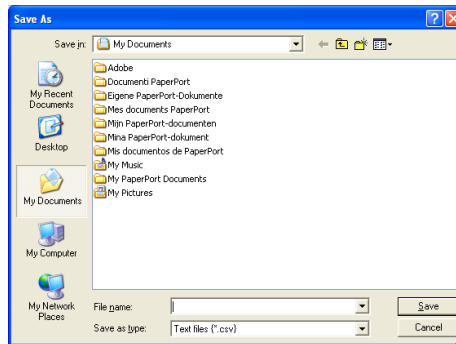



# Importing to the Address Book

You can import ASCII text files (\*.csv) or Vcards (electronic business cards) into your Address Book.

## To import an ASCII text file:

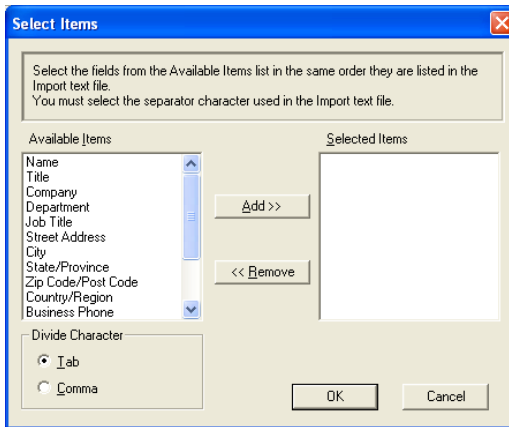
- 1 From the Address Book select **File**, point to **Import**, and then click **Text**.  
—OR—  
Click **Vcard** and go to Step 5.



- 2 From the **Available Items** column select the data fields you want to Import, and click **Add >>**.
-  From the Available Items list select the fields in the same order they are listed in the Import text file.
- 3 Select the **Divide Character - Tab** or **Comma** based on the file format you are importing.
- 4 To import the data click **OK**.

## 5 Type the name of the file, and then select **Open**.

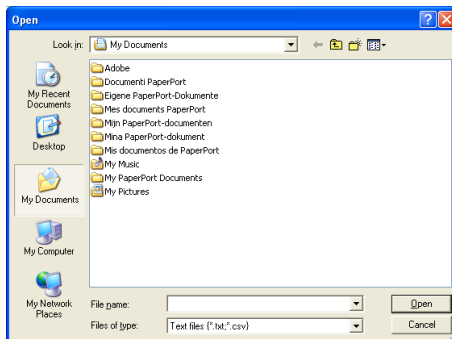

 If you selected a text file in Step 1, the **Files of type:** will be **Text file (\*.csv)**.

## Setting up a Cover Page

From the PC-FAX dialog box click  to access the PC-Fax Cover page setup screen. (See *Sending a file as a PC-FAX using the Facsimile style* on page 17-15.)

The **Brother PC-FAX Cover Page Setup** dialog box will appear:

**Brother PC-FAX Cover Page Setup**

Cover page On

To

Name : Taro Nagoya

Department : Sales

Company : Brother International Corp

Comment

From

Name : John Doe

TEL : 908-555-1212

FAX : 908-555-1212

E-Mail : JDoe.springboard.org



Department : U56

Company : International Spring Board Ass

Address1 : 123 Rose Hill Driver

Address2 : Potsville, NJ 08888

Form

Type 1   Type 2 

Import BMP file

File name \_\_\_\_\_ Cvrpage

Alignment  Left  Center  Right  W/ allpaper

Count cover page

## You can enter information in each field

---



If you are sending a fax to more than one recipient, the recipient information will not be printed on the Cover Page.

**To**

**From**

**Comment**

Type the comment you want to add to the cover page.

**Select Cover Page Form**

Select the cover page format you want to use.

**Import BMP file**

You can insert a bitmap file, such as your company logo, in the cover page.

Use the browse button to select the BMP file, and then select the alignment style.

**Count Cover Page**

When the Count Cover Page box is checked, the Cover Page will be included in the page numbering. When this box is not checked, the Cover Page will not be included.

# Sending a file as a PC-FAX using the Facsimile style

- 1 Create a file in Word, Excel, Paint, Draw or any other application on your PC.
- 2 From the **File** menu, select **Print**.  
The **Print** dialog box will appear:

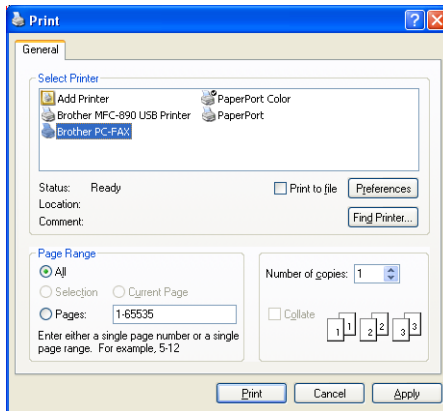

- 3 Select **Brother PC-FAX** as your printer, and then click **OK**.  
The Fax Sending dialog box will appear.



- 4** Enter the fax number using any of the following methods:
- Using the dial pad enter the number.
  - Click any of the 10 **Speed-Dial** buttons.
  - Click the **Address Book** button, and then select a Member or Group from the Address Book.

 If you make a mistake you can click **Clear** to delete all the entries.

- 5** To include a Cover Page, click  **Cover Page On**, and then click the Cover Page  icon to enter or edit the Cover Page information.

- 6** Click **Start** to send the fax.

 If you want to cancel the fax, click **Stop**.

## Redial

If you want to redial a number, click **Redial** to scroll through the last five fax numbers, and then click **Start**.

## Sending a file as a PC-FAX using the Simple style

---

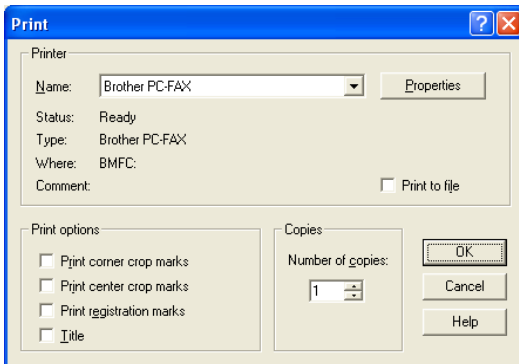

- 1** Create a file in Word, Excel, Paint, Draw or any other application on your PC.
- 2** From the **File** menu, select **Print**.  
The **Print** dialog box will appear:



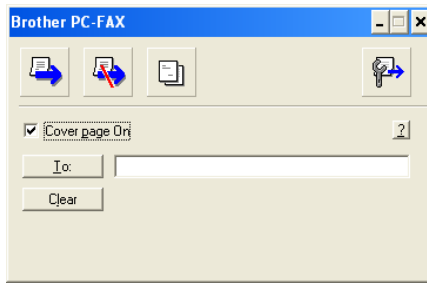

- 3** Select **Brother PC-FAX** as your printer, and then click **OK**. The FAX Sending dialog box will appear:



- 4** In the **To:** field, type the fax number of the recipient. You can also use the Address Book to select destination fax numbers by clicking the **To:** button. If you made a mistake entering a number, click the **Clear** button to delete all the entries.
- 5** To send a Cover Page and note, click the **Cover Page On** check box.

 You can also click the  icon to create or edit a cover page.

- 6** When you are ready to send your fax, click the Send  icon.
- 7** If you wish to cancel the fax, click the Cancel  icon.

# Setting up PC-FAX receiving (Windows® 95/98/98SE/Me/2000 Professional and Windows NT® WS 4.0 only)

## Running PC-FAX Receiving

---

From the **Start** menu, select **Programs, Brother, Brother MFL- Pro Suite** and then select '**PC-FAX Receiving**'.

The PC-FAX  icon will appear on your PC Task bar for this Windows® session.

## Setting up your PC

---

- 1 Right-click the PC-FAX  icon on your PC Task Bar, and then click **PC-Fax RX Setup**.
- 2 The PC-Fax RX Setup dialog box will appear:

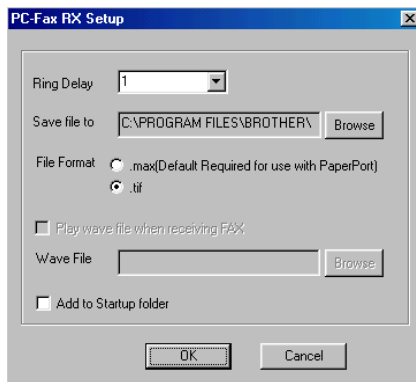

- 3 In **Ring Delay**, select the number of rings before you want your PC to answer Incoming calls.
- 4 In **Save file to**, use the Browse button if you want to change the path where PC-FAX files will be saved.s
- 5 In **File Format**, select **.tif** or **.max** for the format the received document will be saved in. The default format is **.tif**.
- 6 If you want to, you can check the **Play wave file when receiving FAX** check box, and then enter the path.
- 7 To load PC FAX receiving automatically when you start up Windows®, select the **Add to Startup folder** check box.



## Viewing new PC-FAX messages

---

Each time you start to receive a PC-FAX, the icon will flash  blue and red. Once the fax has been received the icon will remain red. The red icon will change to green once the received fax has been received.

- 1** Run PaperPort.
- 2** Open the Fax Received folder.
- 3** Double-click any of the new faxes to open and view them.

 The title of your unread PC message will be the date and time until you assign a file name.

For example "Fax 2-20-2002 16:40:21.tif"

# Receiving a fax into the PC (Windows® XP only)

## How to receive a fax automatically

Before you can start receiving faxes, please install the appropriate Windows XP driver (Windows XP In-box driver or Brother Windows XP driver). After the driver is installed, refer to the following information to configure your Windows XP PC for Fax receiving.

- 1 To activate Faxing receiving, click **Set up faxing** in the **Printer Tasks** menu.

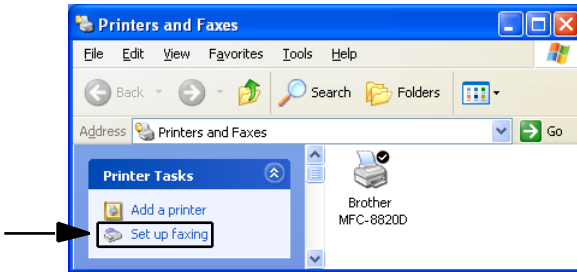

- 2 The FAX services will be installed on your PC.

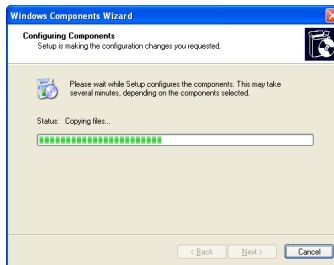

- 3 A **Fax** icon will then appear in the **Printers and Faxes** folder. If the **Fax** icon does not appear, click **Install a local fax printer** in the **Printer tasks** menu.

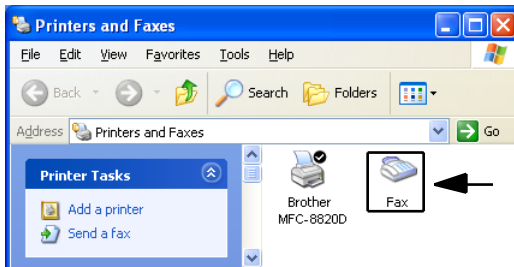

#### 4 Select the **Start, All Programs, Accessories, Communications, Fax, Fax Console.**

 If you have not configured your fax connection, the following screen will be displayed.

Enter your details, ensuring you specify the outside line access number if necessary and click **OK**.

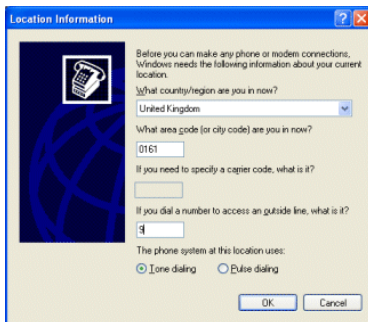

Select the **My location** radio button if it is not selected and then click **OK**.

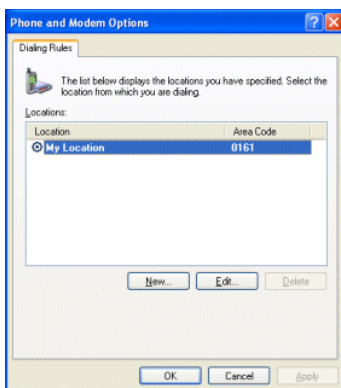

**5** The **Fax Configuration Wizard** starts. Click **Next**.

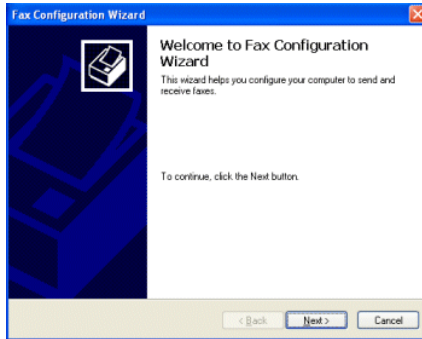

**6** Enter the sender information, and then click **Next**.

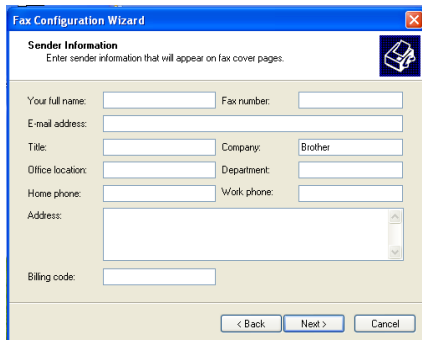

**7** Select **Brother MFC-8420** or **MFC-8820D** in the **Please select the fax device** pull-down list. Click to select the **Enable Receive** check box. Specify the number of rings before your MFC will attempt to answer the fax. Click **Next**.

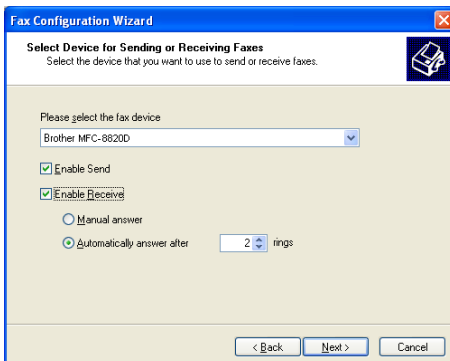

- 8 Enter the **Transmitting Subscriber Identification (TSID)**, and then click **Next**.

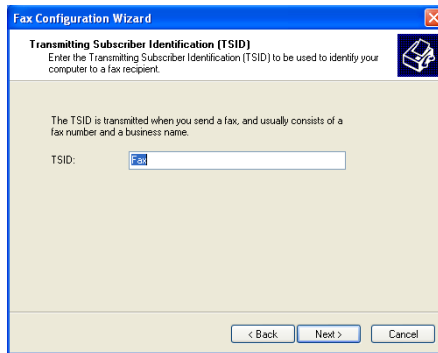

- 9 Enter the **Called Subscriber Identification (CSID)**, and then click **Next**.

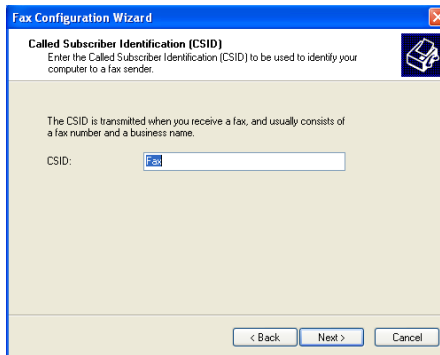

- 10 Select if you print a received fax or save it in a folder, and then click **Next**.

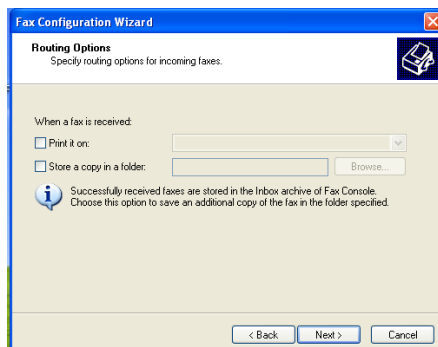

## 11 Click **Finish**.



When PC-FAX Receiving is active, you cannot run the Remote Setup utility. To use Remote Setup, check off **Enable Receive** in Step 7.

For information on how to use PC-FAX Sending and Receiving, please refer to Help in the **Fax Console**.

The PC-FAX installation is now complete.

## How to view the received faxes

---

Faxes that are received into the PC will appear in the Fax Console. Click **Start**, point to **All Programs, Accessories, Communications, Fax**, and then click **Fax Console** to open the **Fax Console**. In the left pane, expand the Fax folder (if it is not already expanded).

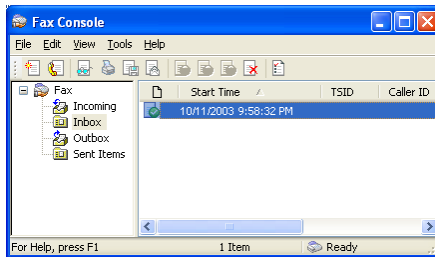

The Fax folder contains the following folders:

- The Incoming folder contains faxes that are currently being received.
- The Inbox folder contains faxes that have been received.
- The Outbox folder contains faxes that are scheduled to be sent.
- The Sent Items folder contains faxes that have been successfully sent.

# 18 Using your MFC with a Macintosh®

## Setting up your USB-equipped Apple® Macintosh®



- Before you can connect the MFC to your Macintosh®, you must buy a USB cable that is not longer than 6 feet (1.8 metres).

**Do not connect the MFC to a USB port on a key board or a non-powered USB hub.**

- Some descriptions in this chapter are based on the MFC-8820D. These descriptions also apply to the MFC-8420 and MFC-8820DN.

The features supported by the MFC will depend on the operating system you are using. The chart below shows which features are supported.

| Feature          | Mac OS® |     | Mac OS® X |                     |
|------------------|---------|-----|-----------|---------------------|
|                  | 8.6     | 9.X | 10.1      | 10.2.1 or greater*1 |
| Printing         | Yes     | Yes | Yes       | Yes                 |
| Scanning (TWAIN) | Yes     | Yes | No        | Yes                 |
| PC-FAX sending   | Yes     | Yes | Yes       | Yes                 |
| Remote Setup     | No      | No  | Yes       | Yes                 |

\*1 For Mac OS® X 10.2 users, please upgrade to Mac OS® X 10.2.1 or greater. (For the latest information for Mac OS® X, please visit at: <http://solutions.brother.com>)



# Using the Brother printer driver with your Apple® Macintosh® (Mac OS® 8.6-9.2)

To select a Printer:

- 1 Open the **Chooser** from the Apple menu.

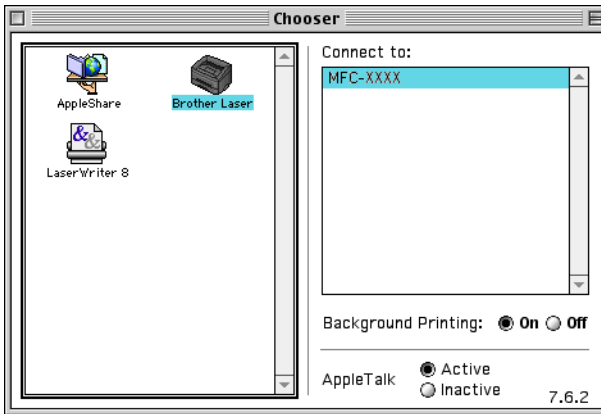

- 2 Click the **Brother Laser** icon. On the right side of the **Chooser** window, click the printer you want to print to. Close the **Chooser**.

## To print a document:

- 1 From the application software such as Presto!® PageManager®, click **File** menu and select **Page Setup**. You can change the settings for **Paper Size**, **Orientation**, and **Scaling**, and then click **OK**.

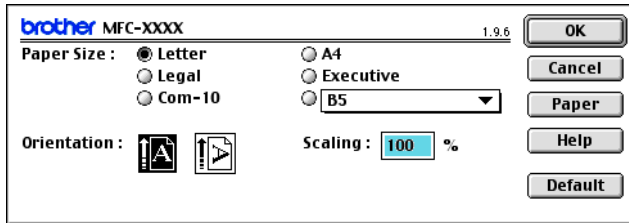

- 2 From application software such as Presto!® PageManager®, click **File** menu and select **Print**. Click **Print** to start printing.

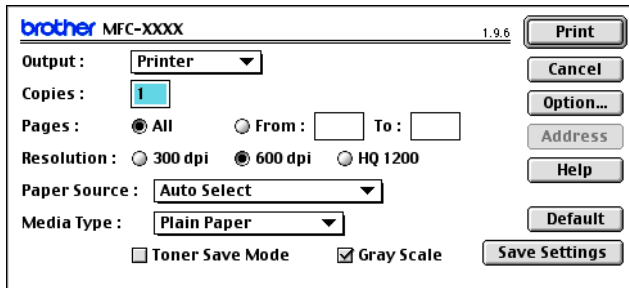

 If you want to change **Copies**, **Pages**, **Resolution**, **Paper Source** and **Media Type**, select your settings before clicking **Print**.

Device Options allows you to select **Duplex**.

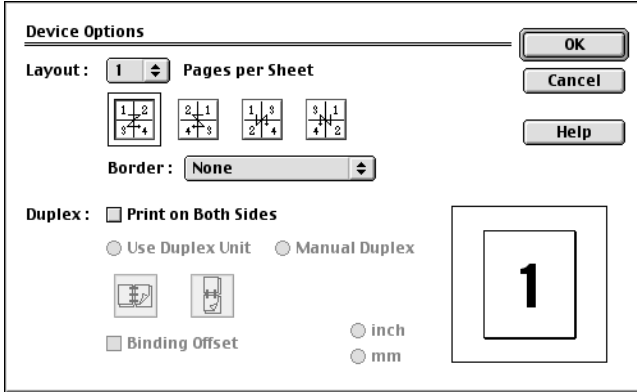

Automatic Duplex is only available with the MFC-8820D and MFC-8820DN.

# Using the Brother Printer Driver with Your Apple® Macintosh® (Mac OS® X)

## Choosing page setup options

- 1 From application software such as Presto!® PageManager®, click the **File** menu and select **Page Setup**. Make sure *MFC-8420*, *MFC-8820D* or *MFC-8820DN* is selected in the **Format for** pop-up menu. You can change the settings for **Paper Size**, **Orientation** and **Scaling**, then click **OK**.

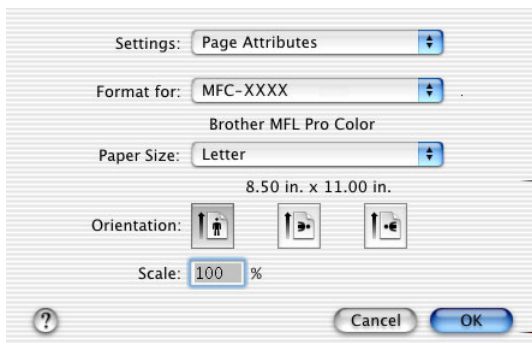

- 2 From application software such as Presto!® PageManager®, click **File** menu and select **Print**. Click **Print** to start printing.

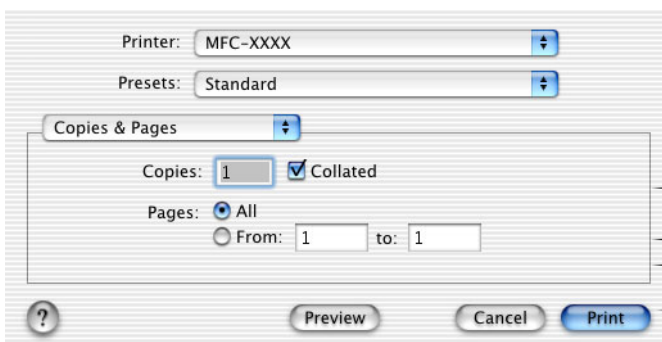

## Specific settings

Set the **Media Type**, **Resolution**, **Toner Save**, and other settings. Press **Copies & Pages** to select settings you want to change.

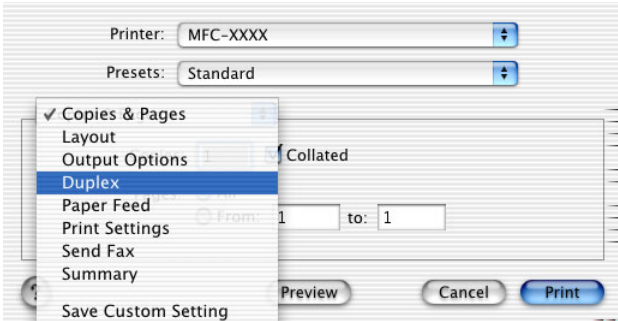

## Duplex

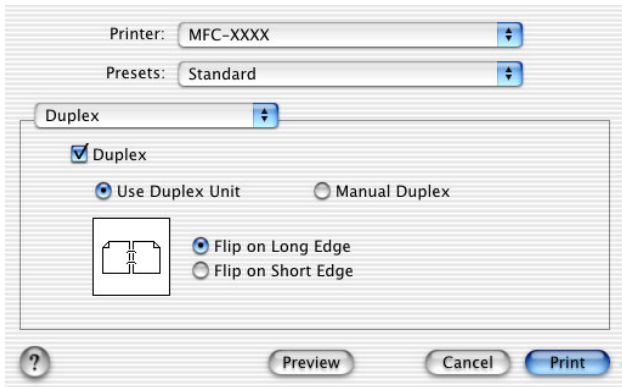

Automatic Duplex is only available with the MFC-8820D and MFC-8820DN.

## Printer settings

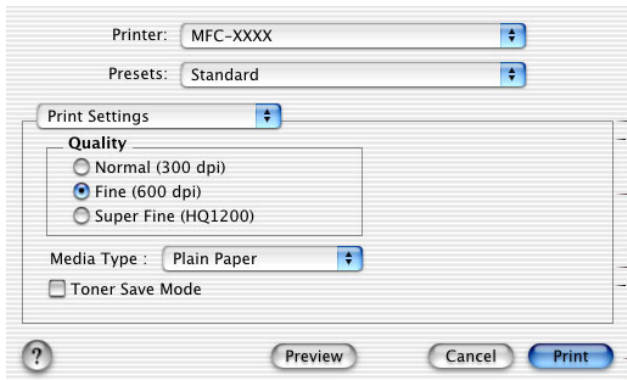

# Using the PS driver with your Apple® Macintosh®



To use the PS driver on a Network, see the NC-9100h Network User's Guide on CD-ROM.



To use the PS driver with a USB cable, you need to set the Emulation to BR-Script3 (**Menu, 4,1**) before connecting the USB cable. (See *Setting the Emulation Selection* on page 11-17.)



The PS driver does not support the following functions:

- HQ 1200
- Secure Print
- PC-Fax Sending

## For Mac OS® 8.6 to 9.2 users

---

### 1 For Mac OS® 8.6 to 9.04 Users:

Open the **Apple Extras** folder. Open the **Apple LaserWriter Software** folder.

### For Mac OS® 9.1 to 9.2 Users:

Open the **Applications** (Mac OS® 9) folder. Open the **Utilities** folder\*.

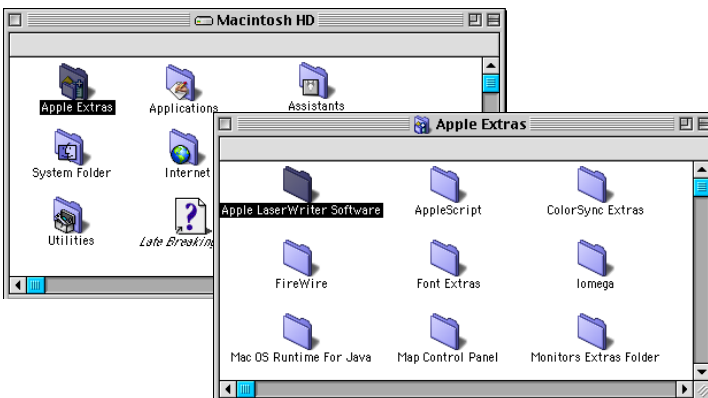

\* The screens are based on Mac® OS 9.04.

2 Open the **Desktop Printer Utility** icon.

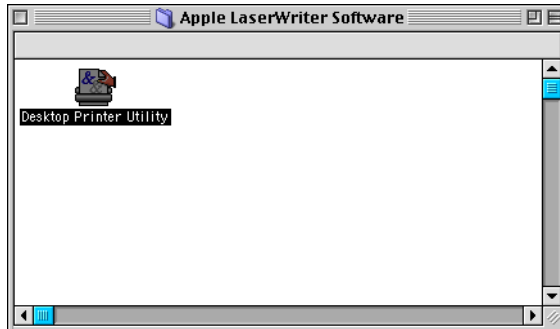

3 Select **Printer (USB)**, and then click **OK**.

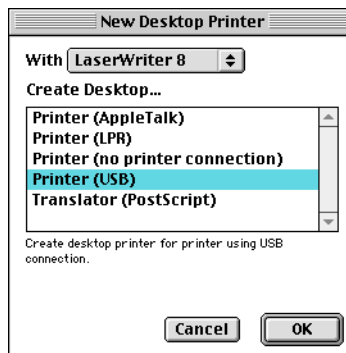



- 4 Click **Change...** in the PostScript™ Printer Description (PPD) file.  
Select **Brother MFC-8820D**, and then click **Select**.

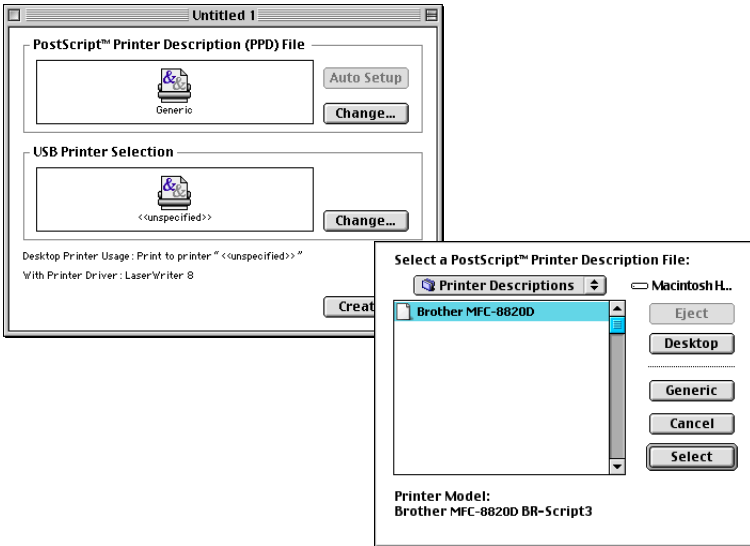

- 5 Click **Change...** in the USB Printer Selection.  
Select **Brother MFC-8820D**, and then click **OK**.

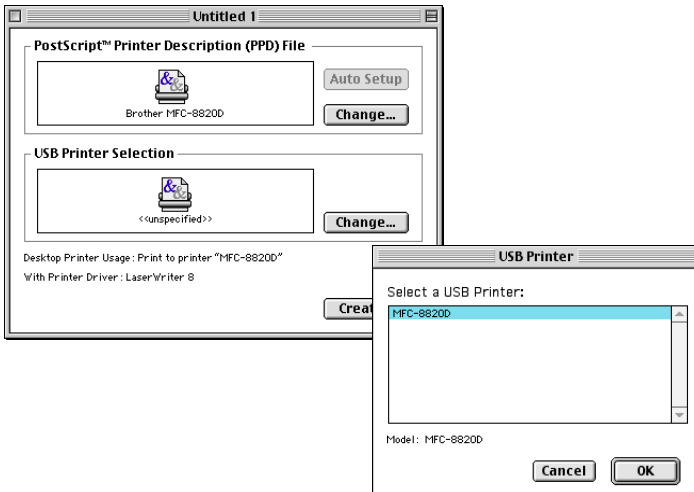

## 6 Click **Create...**

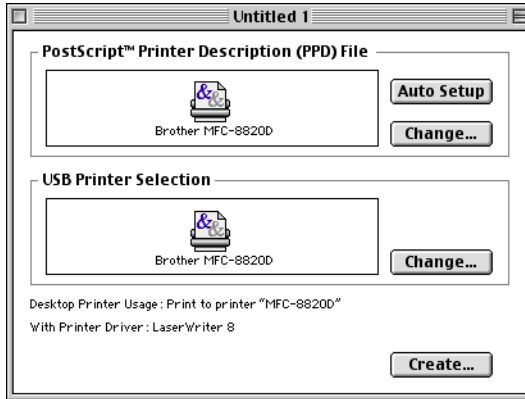

## 7 Enter your MFC name (MFC-8820D), and then click **Save**.

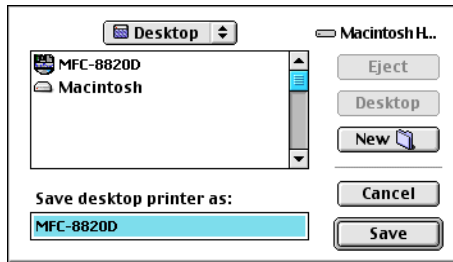

## 8 Select **Quit** from the **File** menu.

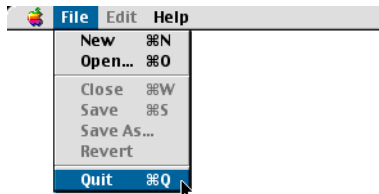
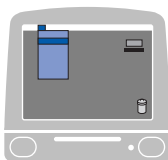

## 9 Click the **MFC-8820D** icon on the Desktop.

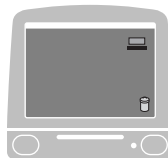

## 10 Select **Set Default Printer** from the **Printing** menu.

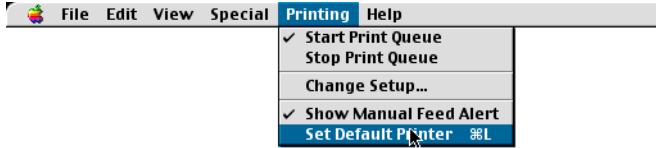

## For Mac OS® X users

---

You need to install the PS driver using the following instructions.



- If you use a USB cable and your Macintosh® is “Mac OS® X”, only one printer driver for an MFC can be registered in Print Center.
- If a Brother Native Driver (MFC-XXX) is already listed in Printer list, you will need to delete it and then install the PS driver.
- To use the PS driver with a USB cable, you need to set the Emulation to BR-Script3 (**Menu, 4,1**) before connecting the USB cable. (See *Setting the Emulation Selection* on page 11-17.)

## 1 Select **Applications** from the **Go** menu.

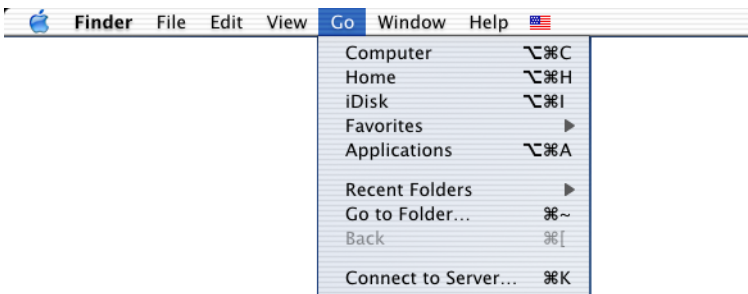

2 Open the **Utilities** folder.



3 Open the **Print Center** icon.



4 Click **Add Printer...**

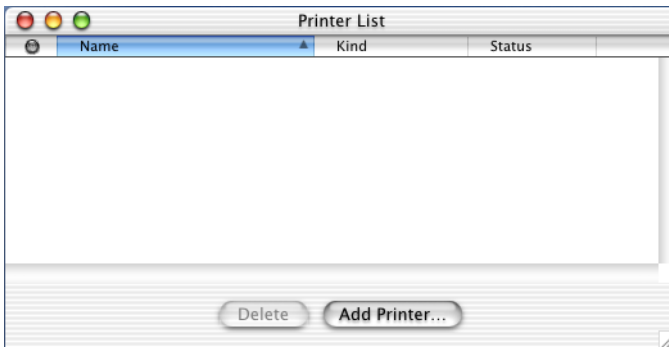

**5** Select **USB**.

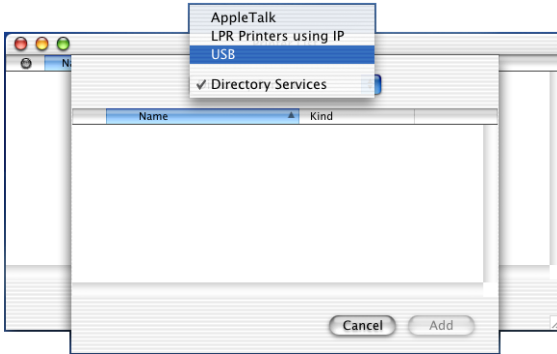

**6** Select **MFC-8820D**, and then click **Add**.

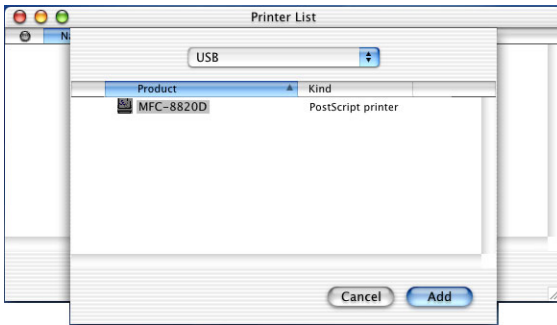

**7** Select **Quit Print Center** from the **Print Center** menu.

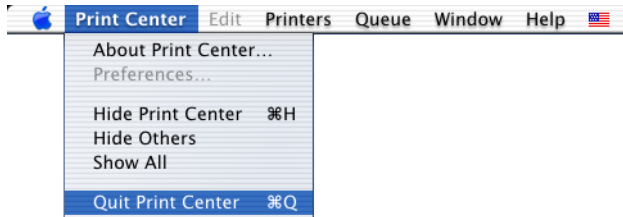
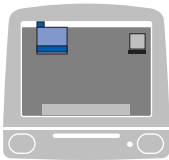

# Sending a fax from your Macintosh® application

## For Mac OS® 8.6-9.2 users

You can send a fax directly from a Macintosh® application by doing the following:

- 1 Create a document in a Macintosh application.
- 2 To send a fax, select **Print** from the **File** menu.  
The Printer dialog box will appear:

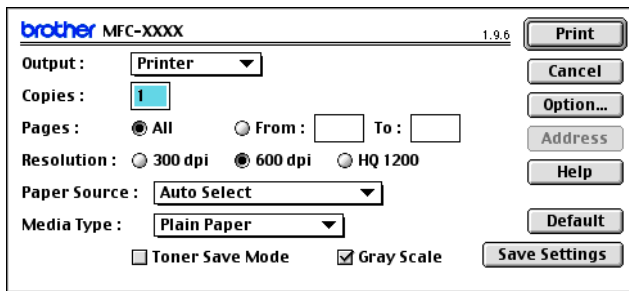

When *Printer* is selected, the top button shows **Print** and the **Address** button is grayed.

- 3 From the **Output** pull-down menu, select *Facsimile*.

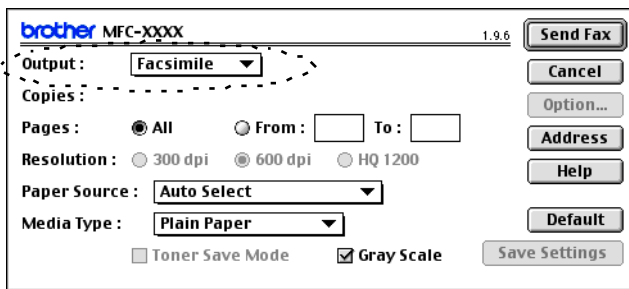

When *Facsimile* is selected, the top button changes to **Send Fax** and the **Address** button will be available.

- 4 Click **Send Fax**.  
The **Send Fax** dialog box appears:

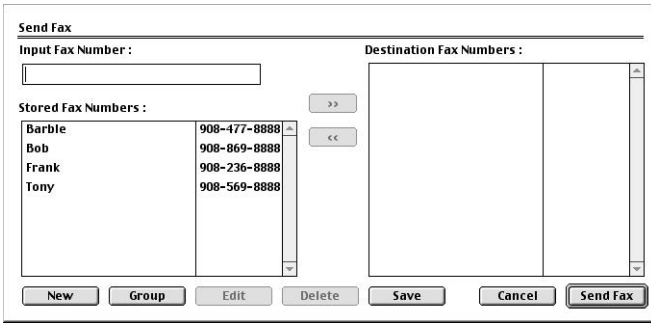

The **Send Fax** dialog box has two list boxes. The left box shows all the previously **Stored Fax Numbers** and the right box shows the **Destination Fax Numbers** as you select them.

- 5 To address the fax, type a fax number in the **Input Fax Number** box.

- 6 When you are finished addressing your fax, click **Send Fax**.

 To select and only send certain pages of the document, click **OK** to go to the Print dialog box.

 If you click **Send Fax** without addressing your fax, the following error message will appear:

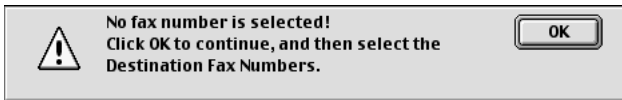

Click **OK** to go to the **Send Fax** dialog box.

## For Mac OS® X users

You can send a fax directly from a Macintosh® application by doing the following:

- 1 Create a document in a Macintosh application.
- 2 To send a fax, select **Print** from the **File** menu.

The Printer dialog box will appear:

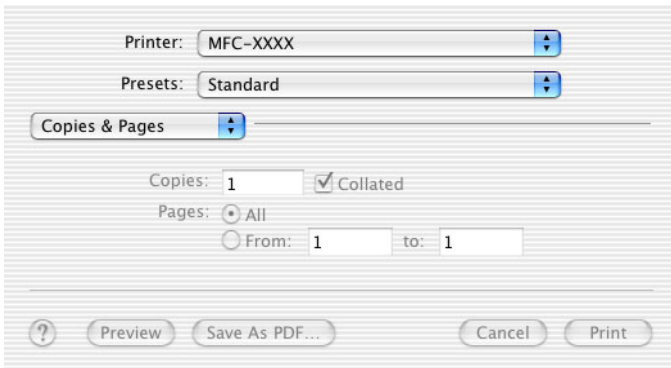

- 3 Select **Send Fax** from pull-down menu.

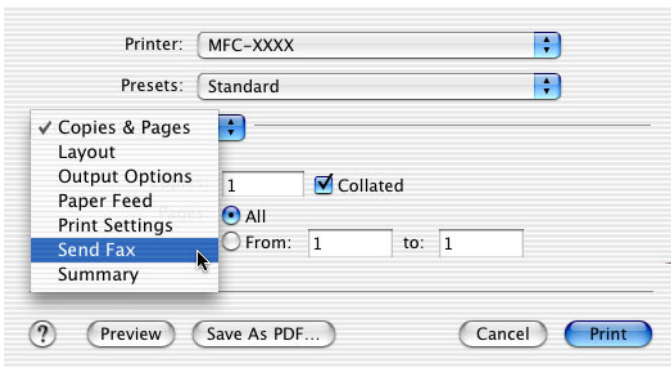



#### 4 Select **Facsimile** from the **Output** pull-down menu.

Printer: MFC-XXXX  
Presets: Standard  
Send Fax  
Output: Printer  
Input Fax Number:  
Stored Fax Numbers: work fax Address Book  
Destination Fax Numbers:  
Name FAX#  
Delete  
Preview Save As PDF... Cancel Print

Printer: MFC-XXXX  
Presets: Standard  
Send Fax  
Output: Facimile  
Input Fax Number:  
Stored Fax Numbers: work fax Address Book  
Destination Fax Numbers:  
Name FAX#  
Delete  
Preview Save As PDF... Cancel Print

#### 5 To address the fax, type a fax number in the **Input Fax Numbers** box, and the click **Print**.



If you want to send a fax to more than one number, click **Add** after entering the first fax number. The destination fax numbers will be listed in the dialog box.

Printer: MFC-XXXX  
Presets: Standard  
Send Fax  
Output: Facimile  
Input Fax Number:  
Stored Fax Numbers: work fax Address Book  
Destination Fax Numbers:  

| Name | FAX#         |
|------|--------------|
| Bob  | 999-888-0000 |

  
Delete  
Preview Save As PDF... Cancel Print

## Drag a vCard from the Mac OS® X Address Book application

- 1 Click **Address Book** button.
- 2 Drag a vCard from the Mac OS® X **Address Book** application to the **Destination Fax Numbers** field.

When you are finished addressing your fax, click **Print**.

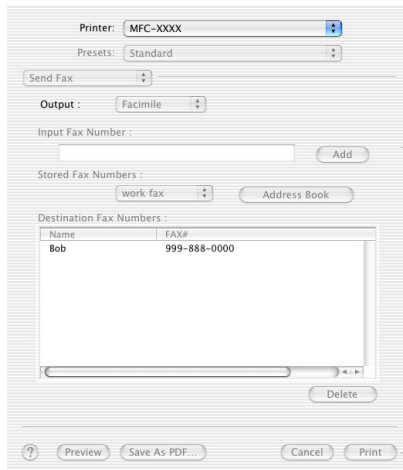
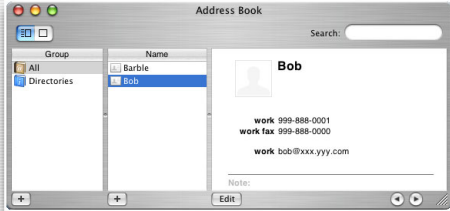
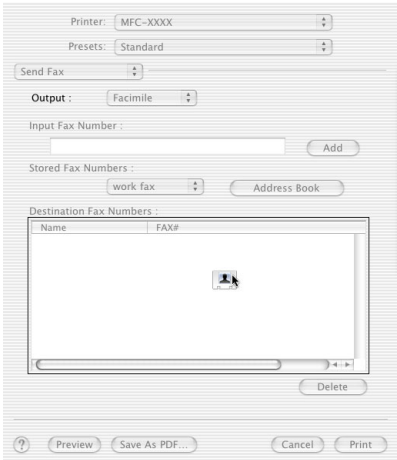

The vCard used must contain a **work fax** or **home fax** number.



When you choose **work fax** or **home fax** from the **Stored Fax Numbers** pull-down list, only the fax number stored in the Mac OS® X Address Book for the selected category will be used. If the fax number is stored in only one of the Mac OS® X Address Book categories, the number will be retrieved no matter which category you have selected (work or home).

# Using the Brother TWAIN scanner driver with your Macintosh®

The Brother MFC software includes a TWAIN Scanner driver for Macintosh®. You can use this Macintosh® TWAIN Scanner driver with any applications that support the TWAIN specifications.

 Mac OS® X Scanning is supported in Mac OS® X 10.2.1 or greater.

## Accessing the scanner

Run your Macintosh® TWAIN-compliant application software. The first time you use the Brother TWAIN driver (MFL Pro/P2500), set it as the default by choosing **Select Source** (or the other menu name to select the device). Afterwards, for each document you scan choose **Acquire Image** or **Scan**. The scanner setup dialog box will appear.

 The screen shown in this section are from Mac OS® 9. The screen on your Macintosh® may vary depending on your Operating System.

 The method of selecting the source or choosing to scan may vary depending on the application software you are using.

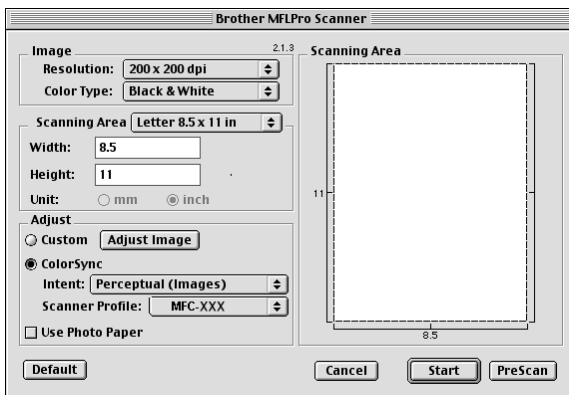

(OS 8.6–9.2)

# Scanning an image into your Macintosh®

---

You can scan a whole page

—OR—

scan a portion after prescanning the document.

## Scanning a whole page

- 1** Place the original face up in the ADF, or face down on the scanner glass.
- 2** Adjust the following settings, if needed, in the Scanner Setup dialog box:
  - Resolution**
  - Color Type**
  - Scanning Area**
  - Brightness**
  - Contrast**
- 3** Click **Start**.  
When scanning has finished, the image will appear in your graphics application.

## PreScanning an image

---

Pre Scanning allows you to scan an image quickly at a low resolution. A thumbnail version will appear in the **Scanning Area**. This is only a preview of the image, so you can see how it will look. The **PreScan** button will allow you to crop unwanted areas from the images. When you are satisfied with the preview, click **Start** to scan the image.

- 1** Insert the original face up in the ADF, or face down on the scanner glass.
- 2** Click **PreScan**.  
The whole image will be scanned into your Macintosh® and will appear in the **Scanning Area** of the Scanner dialog box:
- 3** To scan a portion of the prescanned image, click and drag the mouse to crop it.

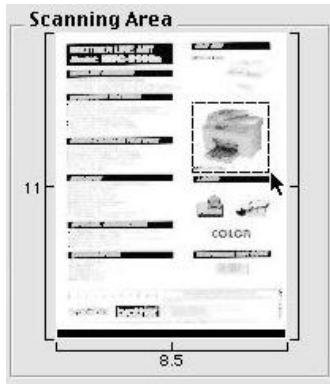

- 4** Insert original in the ADF, if you are using ADF.
- 5** Make your adjustments to the settings for **Resolution**, **Color Type** (Gray Scale), **Brightness**, **Contrast**, and **Size** in the Scanner Setup dialog box.
- 6** Click **Start**.  
This time only the cropped area of the original will appear in the Scanning Area.
- 7** In your editing software, you can refine the image.

# Settings in the Scanner window

---

## Image

### Resolution

From the **Resolution** pop-up menu choose the scanning resolution. Higher resolutions use more memory and transfer time, but produce a finer scanned image.

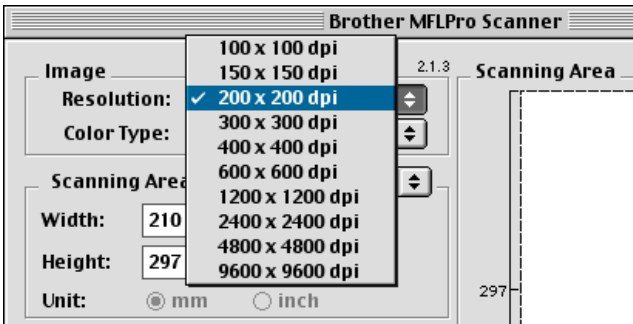

## Color Type

**Black & White**—Set the image Type to *Black and White* for text or line art. For photographic images, set the image type to Gray (Error diffusion) or True Gray.

**Gray (Error Diffusion)**—is used for documents with photographic images or graphics. (Error Diffusion is a method for creating simulated gray images by placing black dots instead of the true gray dots in a specific matrix instead of true gray dots.)

**True Gray**—is used for documents with photographic images or graphics. This mode is more exact because it uses up to 256 shades of gray. It requires the most memory and takes the longest transfer time.

**Colors**—Choose either 8-bit Color, which scans up to 8-bit Color or 24-bit Color which scans up to 16.8 million colors. Although using 24-bit Color creates an image with the most accurate colors, the image file will be about three times larger than a file created with 8-bit Color.

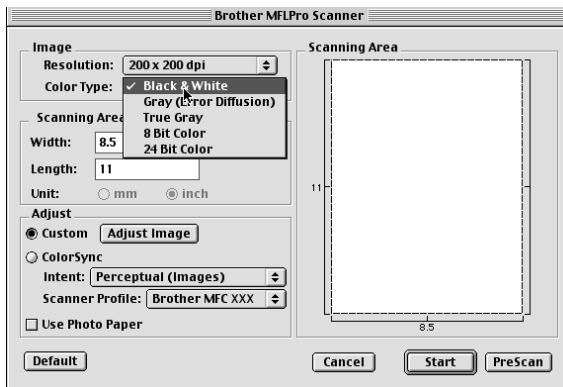



## Scanning Area

Set the **Size** to one of the following:

- *Letter (8.5 × 11 inches)*
- *A4 (210 × 297 mm)*
- *Legal (8 1/2 × 14 in.)*
- *A5 (148 × 210 mm)*
- *B5 (182 × 257 mm)*
- *Executive (7.25 × 10.5 inches)*
- *Business Card (90 × 60 mm)*
- *Custom (user adjustable it from 0.35 × 0.35 in. to 8.5 × 11.69 in. or 8.9 × 8.9 mm to 216 × 356 mm)*

After you choose a custom size, you can adjust the scanning area. Click and hold the mouse button as you drag the mouse to crop the image.

**Width:** Enter the width of the custom size.

**Height:** Enter the height of the custom size.

## Business Card Size

To scan business cards, select the Business Card size (90 × 60 mm) and place the business card at the center of scanner glass.

When you are scanning photographs or other images to use in a word processor or other graphics application, it is a good idea to try different settings for the Contrast, Mode and Resolution to determine which settings look the best.

## Adjusting the Image

### Brightness

Adjust the **Brightness** setting to get the best image. The Brother TWAIN Scanner driver offers 100 Brightness levels (-50 to 50). The default value is 0, representing an 'average' setting.

You can set the **Brightness** level by dragging the slide bar to the right to lighten the image or to the left to darken the image. You can also type a value in the box to set the level. Click **OK**.

If the scanned image is too light, set a lower Brightness level and scan the image again.

If the image is too dark, set a higher Brightness level and scan the image again.

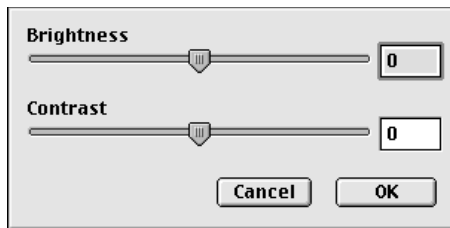

### Contrast

You can only adjust the **Contrast** level when you have selected one of the Gray Scale settings, it is not available when you have selected Black & White as the selected **Color Type**.

Increasing the **Contrast** level (by dragging the slide bar to the right) emphasizes dark and light areas of the image, while reducing the **Contrast** level (by dragging the slide bar to the left) reveals more detail in the gray areas. Instead of using the slide bar, you can type a value in the box to set the Contrast. Click **OK**.

# Using Presto!® PageManager®

Presto!® PageManager® is application software for managing the documents in your computer. Since it is compatible with most image editors and word processing programs, Presto!® PageManager® gives you unmatched control over your computer files. You can easily manage your documents and edit your E-mail files, and read documents with the OCR software built into Presto!® PageManager®.

If you use the MFC as a scanner, we recommend that you install Presto!® PageManager®. To install Presto!® PageManager®, see Quick Setup Guide on pages 42 to 49.



The complete NewSoft Presto!® PageManager® 4.0 User's Guide can be found on the Macintosh CD-ROM supplied with your MFC.

## Highlights

---

- **OCR:** Scan an image, recognize the text, and edit it with a word processor.
- **Scan Buttons:** In one step scan documents and open them with a designated program.
- **Image Editing:** Enhance, crop and rotate images, or open them with an image-editing program of your choice.
- **Annotation:** Add removable notes, stamps, and drawings to images.
- **Treeview Window:** View and arrange your folder hierarchy for easy access.
- **Thumbnail Window:** View files as thumbnails for easy identification.

## System requirements

---

- PowerPC processor
- System 8.6, 9X, 10.1, or greater
- CD-ROM drive
- Hard disk drive with at least 120 MB of free disk space

### Recommended:

- 256 color or higher video adapter.
- Eudora Mail, or Outlook Express electronic mail software

## Technical Support

---

### For USA

Newssoft America Inc.

Postal Address: 4113 Clipper Court Fremont, CA 94538, USA

Telephone: 510-4458600

FAX: 510-4458601

E-mail Address: [contactus@newssoftinc.com](mailto:contactus@newssoftinc.com)

URL: <http://www.newssoftinc.com/>

### For Canada

E-mail Address: [contactus@newssoftinc.com](mailto:contactus@newssoftinc.com)

# MFC Remote Setup (Mac OS® X)

The MFC Remote Setup application allows you to quickly set up your MFC by taking advantage of the ease and speed of programming on your Macintosh®. When you access this application, the settings on your MFC will be downloaded automatically to your Macintosh® and displayed on your computer screen. If you change the settings, you can upload them directly to the MFC.



The 'MFC Remote Setup' application icon is in Macintosh HD/Library/Printers/Brother/Utility.

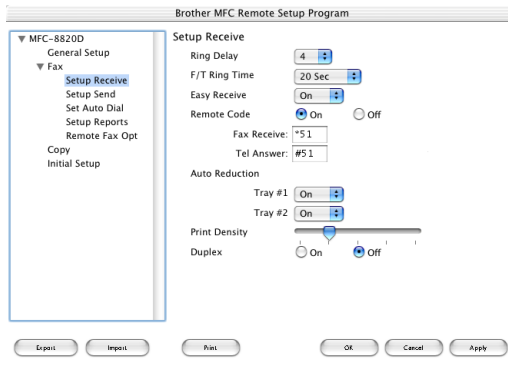

## OK

This starts the process of uploading the data to the MFC and exiting the remote setup program. If an error message is displayed enter the correct data again. Click **OK**.

## Cancel

This exits the remote setup application without uploading the data to the MFC.

## Apply

This uploads the data to the MFC, but does not exit the remote setup application.

## Print

This command prints the selected items on the MFC. You can not print the data until it is uploaded to the MFC. Click **Apply** to upload the new data to the MFC and click **Print**.

**Export**

This command saves the current configuration settings to a file.

**Import**

This command reads the settings from a file.

# 19 Network Scanning (Windows® 98/98SE/Me/2000 Professional and XP only)

To use the MFC as a Network Scanner, the NC-9100h Network board should be installed into the MFC (MFC-8820DN standard) and configured with TCP/IP and mail server settings if you use Scan to E-mail (E-mail server). You can set or change NC-9100h settings from the control panel or with the BRAdmin Professional utility or Web Management. (Please see the NC-9100h User's Guide on the CD-ROM.)

## Registering your PC with the MFC

---

If you need to change the MFC that was registered to your PC during the installation of MFL-Pro (see Quick Setup Guide on page 38), follow the steps below.

### **1** *For Windows® 98/Me/2000*

From the **Start** menu, select **Control panel**, **Scanners and Cameras**, and then right-click Scanner Device icon and select **Properties** to view the Network Scanner Properties dialog box.

### *For Windows® XP*

From the **Start** menu, select **Control panel**, **Printers and Other Hardware**, **Scanner and Cameras** (or **Control panel**, **Scanners and Cameras**).

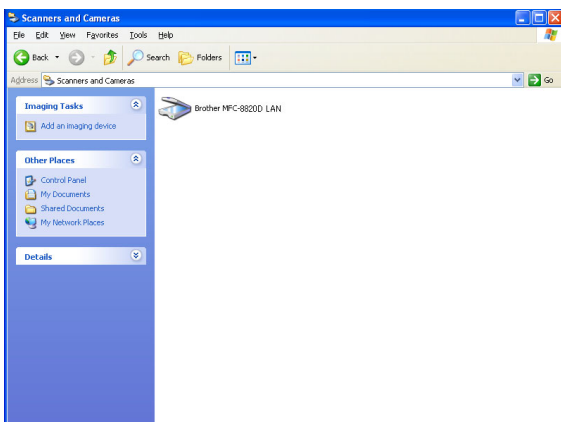

Right-click Scanner Device icon and select properties to view the Network Scanner Properties dialog box.

- 2 Click the **Network Setting** tab in the dialog box and select a method to specify the MFC as a Network scanner for your PC.

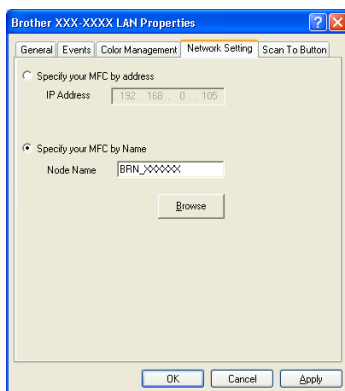

### **Specify your MFC by address**

Enter the actual IP address of the MFC in the IP Address field.

Click **Apply** and then **OK**.

### **Specify your MFC by Name**

Enter the MFC Node name in the Node Name field.

Click **Apply** and then **OK**.



## Search from a list of available device

Click Browse and select the appropriate device you want to use.

Click **OK**.

Click **Apply** and then **OK**.

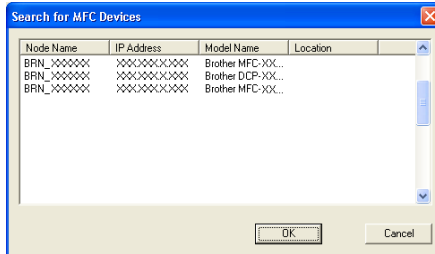

- 3 Click the **Scan To Button** tab in the dialog box and enter your PC Name in the Display Name field. The MFC's LCD displays the Name you enter. Default setting is your PC Name. You can enter a name if you like.

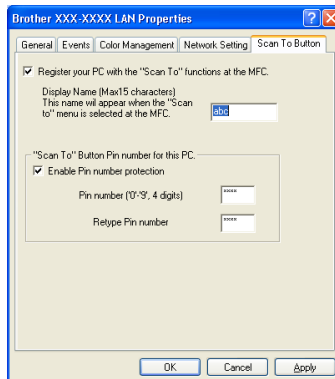

- 4 You can avoid receiving unwanted documents by setting a 4-digit PIN Number. Enter your PIN Number in the PIN Number and Retype PIN Number field. To send data to a PC protected by a PIN Number, the LCD prompts to enter the PIN Number before the document can be scanned and sent to the MFC. (See *Using the Scan key* on page 19-4 to 19-8.)

# Using the Scan key

## Scan to E-mail (PC)

---



When you select Scan to E-mail (PC) your original will be scanned and sent directly to the PC you designated on your network. The Brother SmartUI will activate the default E-mail application on the designated PC for addressing to the recipient. You can scan a black and white or color original and it will be sent with the E-mail from the PC as an attachment.

 For Network Scanning the Brother Control Center (SmartUI) selections are used only for configuring the **Scan** button. You will not be able to initiate a Network scan from the Brother Control Center (SmartUI).

You can change the  (**Scan**) configuration. For Windows® 98/98SE/Me/2000: (See *Scan to E-mail* on page 14-10 to 14-11.) (For Windows® XP: See *Hardware Section: Changing the Scan to button configuration* on page 15-5 to 15-9.)

**1** Place the original face up in the ADF, or face down on the scanner glass.

**2** Press  (**Scan**).

**3** Press  or  to select Scan to E-mail.



Press **Set**.

**4** Press  or  to select PC.

Press **Set**.

—OR—

If there isn't other selection, go to Step 5.

**5** Press  or  to select the destination PC you want to use for E-mailing your original.

Press **Set**.

If the LCD prompts you to enter a PIN Number, enter the 4-digit PIN Number for the destination PC on the control panel.

Press **Set**.

The MFC will start the scanning process.

|                  |
|------------------|
| ▲ Scan to E-mail |
| Scan to Image    |
| Scan to OCR      |
| ▼ Scan to File   |
| Select ▲▼ & Set  |



## Scan to E-mail (E-mail server)

When you select Scan to E-mail (E-mail server) you can scan a black and white or color original and send it directly to an E-mail address from the MFC. Your original is sent as an E-mail attachment in a TIFF format for Black and White or you can choose PDF or JPEG for color.

 Scan to E-mail (E-mail Server) requires SMTP/POP3 mail server support. (See NC-9100h User's Guide on the CD-ROM)

**1** Place the original face up in the ADF, or face down on the scanner glass.

**2** Press  (**Scan**).

**3** Press  or  to select Scan to E-mail.

Press **Set**.



**4** Press  or  to select E-mail Server.

Press **Set**.

—OR—

|                 |                |
|-----------------|----------------|
| ▲               | Scan to E-mail |
|                 | Scan to Image  |
|                 | Scan to OCR    |
| ▼               | Scan to File   |
| Select ▲▼ & Set |                |

If there isn't other selection, go to Step 5.

**5** Press  or  to select Change Quality.

Press **Set**.

**6** Press  or  to select Color 150 dpi, Color 300 dpi, Color 600 dpi, B/W 200 dpi or B/W 200×100 dpi.

Press **Set**.

If you select B/W 200 dpi or B/W 200×100 dpi in Step 6, go to Step 8.

—OR—

If you select Color 150 dpi, Color 300 dpi or Color 600 dpi in Step 6, go to Step 7.

**7** Press  or  to select PDF or JPEG.

Press **Set**.

**8** The LCD prompts you to enter an address. Enter the destination E-mail address from the dial pad or use the One-Touch key or Speed-Dial key.

**9** Press **Start**.

The MFC will start the scanning process.

# Scan to Image



When you select Scan to Image your original will be scanned and sent directly to the PC you designated on your network. The Brother SmartUI will activate the default graphics application on the designated PC. You can change the Scan configuration. (For Windows® 98/Me/2000: See *Scan to Image* on page 14-14.) (For Windows® XP: See *Hardware Section: Changing the Scan to button configuration* on page 15-5 to 15-10.)





For Network Scanning the Brother Control Center (SmartUI) selections are used only for configuring the **Scan** button. You will not be able to initiate a network scan from the Brother Control Center (SmartUI).

**1** Place the original face up in the ADF, or face down on the scanner glass.

**2** Press  (**Scan**).

**3** Press  or  to select Scan to Image.  
Press **Set**.

|                  |
|------------------|
| ▲ Scan to E-mail |
| Scan to Image    |
| Scan to OCR      |
| ▼ Scan to File   |
| Select ▲▼ & Set  |

**4** Press  or  to select a destination you want to send.  
Press **Set**.

If the LCD prompts you to enter a PIN Number, enter the 4-digit PIN Number for the destination PC on the control panel.

Press **Set**.

The MFC will start the scanning process.

## Scan to OCR

When you select Scan to OCR your original will be scanned and sent directly to the PC you designated on your network. The Brother SmartUI will activate ScanSoft® TextBridge® and convert your original into text for viewing and editing from a word processing application on the designated PC. You can change the Scan configuration.

(For Windows® 98/Me/2000: See *Scan to OCR (Word Processor)* on page 14-12 to 14-13.) (For Windows® XP: See *Hardware Section: Changing the Scan to button configuration* on page 15-5 to 15-11.)





For Network Scanning the Brother Control Center (SmartUI) selections are used only for configuring the **Scan** button. You will not be able to initiate a network scan from the Brother Control Center (SmartUI).

**1** Place the original face up in the ADF, or face down on the scanner glass.

**2** Press  (**Scan**).

**3** Press  or  to select Scan to OCR.

Press **Set**.

**4** Press  or  to select a destination you want to send.

Press **Set**.

If the LCD prompts you to enter a PIN Number, enter the 4-digit PIN Number for the destination PC on the control panel.

Press **Set**.

The MFC will start the scanning process.

|                  |
|------------------|
| ▲ Scan to E-mail |
| Scan to Image    |
| Scan to OCR      |
| ▼ Scan to File   |
| Select ▲▼ & Set  |

# Scan to File

When you select Scan to File you can scan a black and white or color original and send it directly to a PC you designate on your network. The file will be saved in the folder and file format that you have configured in the Brother SmartUI on the designated PC. You can change the Scan configuration.



(For Windows® 98/Me/2000: See *Scan to File* on page 14-8 to 14-9.)  
(For Windows® XP: See *Hardware Section: Changing the Scan to button configuration* on page 15-5 to 15-11.)





For Network Scanning the Brother Control Center (SmartUI) selections are used only for configuring the **Scan** button. You will not be able to initiate a network scan from the Brother Control Center (SmartUI).

**1** Place the original face up in the ADF, or face down on the scanner glass.

**2** Press  (**Scan**).

**3** Press  or  to select Scan to File.  
Press **Set**.

|                  |
|------------------|
| ▲ Scan to E-mail |
| Scan to Image    |
| Scan to OCR      |
| ▼ Scan to File   |
| Select ▲▼ & Set  |

**4** Press  or  to select a destination you want to send.  
Press **Set**.

If the LCD prompts you to enter a PIN Number, enter the 4-digit PIN Number for the destination PC on the control panel.

Press **Set**.

The MFC will start the scanning process.



Max. 25 clients can be connected to one MFC on a Network. For example, if 30 clients try to connect at a time, 5 clients will not be shown on the LCD.

# 20 Brother Network PC-FAX software

To use the MFC as a Network PC-FAX, the NC-9100h Network board should be installed into the MFC (MFC-8820DN standard) and configured with TCP/IP and mail server settings if you use Scan to E-mail (E-mail server). (See *Using Brother PC-FAX software* on page 17-1.)

## Enable Network PC-FAX

---

To use the MFC for Network PC-FAX, see *Using Brother PC-FAX software* on page 17-1.



The items described below are specific items relating to the Network version of PC-FAX software that is installed from the "Optional network applications" on the CD-ROM supplied with your MFC.

Brother Network PC-FAX can be configured through PC-FAX Setup, Sending tab.

### Sending setup

In order to use the full functionality of Network PC-FAX it is strongly recommended that you enable the Network PC-FAX Setup option on the Sending tab Brother PC-FAX Setup.

- 1 Access the Sending Tab from the PC-FAX dialog box by clicking .

—OR—

From the **Start** menu, select **All programs, Brother, Brother MFL-Pro Suite**, and then select **PC-FAX Setup**.

## 2 Check **Enable** box.

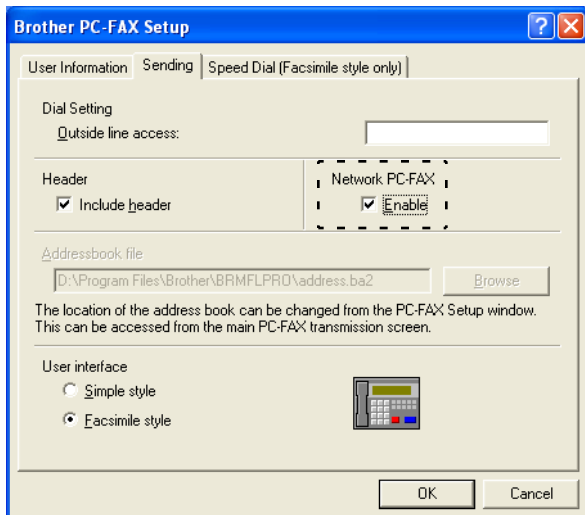

This software can be used in a network environment and with a locally connected machine. It is important that when used in a network environment the Network PC Fax is set to enable.



## Extra options in Address Book

When the Enable Network PC-FAX option is selected, three additional options appear in the address book contact window.

- 1 In the Address Book dialog box, click the  icon to add a member.

The **Brother Address Book Member Setup** dialog box will appear:

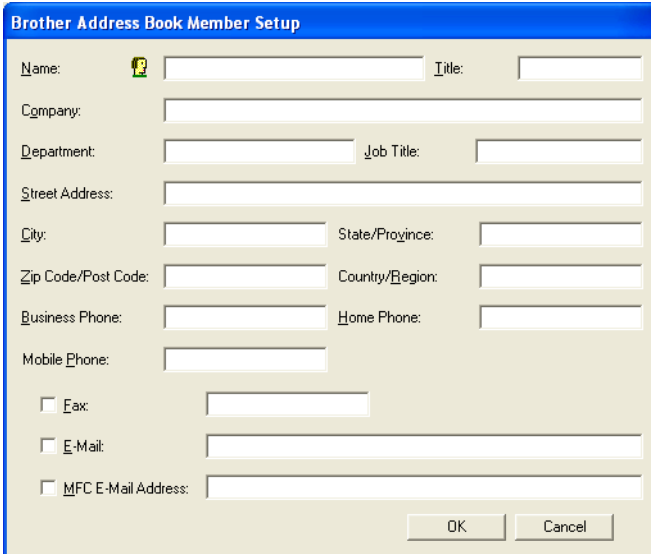

**Brother Address Book Member Setup**

Name:   Title:

Company:

Department:  Job Title:

Street Address:

City:  State/Province:

Zip Code/Post Code:  Country/Region:

Business Phone:  Home Phone:

Mobile Phone:

Fax:

E-Mail:

MFC E-Mail Address:

OK Cancel

- 2 In the **Brother Address Book Member Setup** dialog box, type the member's information.

**Name** is required field. You can also enter an E-mail contact address and MFC address for the address book member.

- 3 To send to this contact it is necessary to specify which is the preferred method of sending a document to this contact by checking the **Fax**, **E-mail** or **MFC E-mail Address** box next to the contact.

- 4 Click the **OK** button to save the member's information.



If you wish to send a document to this contact by more than one method you must create a second contact and select a different option, Fax, E-Mail or MFC Address.

# Installing Network PC-FAX

Insert the CD-ROM supplied with your Brother MFC, the installer screen will automatically start. From the installer screen select your model and language (if these options are present), then select Network Applications for (optional NC-9100h Print / Fax Server), then select Brother PC-FAX and follow the screen prompts. When prompted reboot your PC.

## Windows® 95/98/98SE and Me users

It is now necessary to install the Brother Network Print Software from the CD-ROM so you need to reinsert the CD-ROM. Select Network Applications for (optional NC-9100h Print / Fax Server), then select Network Print Software. Follow the screen prompts, you will be prompted for the IP address of the NC-9100h. If in any doubt contact your Network Administrator.

## To check select **Start, Settings and Printers**

Highlight the Brother PC-FAX driver from the list and right click the mouse button and select **Properties** then select the **Ports** tab.

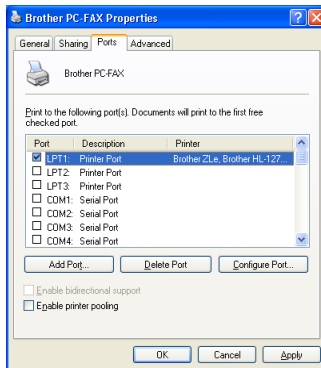

Select the “Print to Following Port” as illustrated above, if Brother LPR Port is listed for your MFC you can just specify for Brother Network Fax to use this previously installed port. If you have multiple Brother LPR ports please ensure that you select the correct port address. If in any doubt please contact your Network Administrator.



If the installer screen does not appear automatically select **Start, Run** and type `X:/setup.exe`

(X:/ should be the drive letter of your CD ROM drive on your PC).

# Using the Brother Network PC-FAX software

The Brother Network PC-FAX feature allows you to use your PC to send any application or document file as a standard fax. You can create a file in any application on your PC, and then send it as a Network PC-FAX. You can even attach a cover page note. All you have to do is set up the receiving parties as Members or Groups in your PC-FAX Address Book or simply enter the destination address or fax number into the User Interface. You can use the Address Book Search feature to quickly find members to send your fax.



Please check Brother Solutions Center for the latest updates available for Brother Network PC-FAX. Visit <http://solutions.brother.com/>

## Quick Tips:

Please see *Enable Network PC-FAX* on page 20-1 before using Brother Network PC-FAX.

- 1 Ensure that Network PC-FAX is set to “Enable” in the Sending tab of Setup. (See *Enable Network PC-FAX* on page 20-1.)

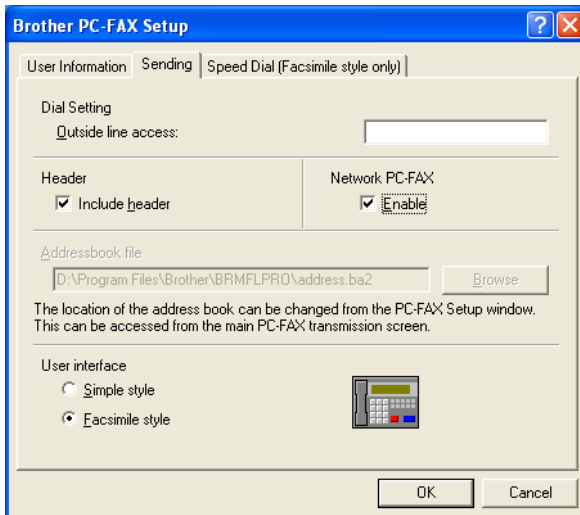

- 2** To send an E-mail from Brother Network PC-FAX you can either enter the E-mail address in the To: field or in the display for Facsimile Style using the PC keyboard or select the member from the Address Book. The member must have E-mail selected as the chosen destination for that member.
- 3** To send an Internet Fax from Brother Network PC-FAX you can either enter the Internet Fax address in the To: field or in the display for Facsimile style using the PC keyboard or select the member from the Address Book. The member must have MFC Mail Address selected as the chosen destination for that member.
- 4** To send a Network Fax simply select a member from the address book or enter the fax number into the User Interface with the PC keyboard. The member must have Fax selected as the chosen destination for that member.



Sending a Network PC-Fax to an E-mail address or sending an Internet Fax requires SMTP/POP3 mail server support.

## **Sending a Network PC-FAX from your Macintosh® application**

---

You can send a fax directly from your Macintosh® application using the following steps:

### **For Mac OS 8.6-9.2 users**

- 1** Follow the steps on pages 46 and 47 in the Quick Setup Guide.
- 2** Follow the steps on pages 18-15 and 18-16.

### **For Mac OS X users**

- 1** Follow the steps on pages 48 and 49 in the Quick Setup Guide.
- 2** Follow the steps on pages 18-17 to 18-20.

# 21 Important information

## Standard telephone and FCC Notices

**These notices are in effect on models sold and used only in the United States.**

---

**When programming emergency numbers or making test calls to emergency numbers:**

- Remain on the line and briefly explain to the dispatcher the reason for the call before hanging up.
- Perform these activities in the off-peak hours, such as early morning or late evening.

This equipment complies with Part 68 of the FCC rules and the requirements adopted by the ACTA. On the backside of this equipment is a label that contains, among other information, a product identifier in the format US: AAAEQ##TXXXX. If requested, this number must be provided to the telephone company.

You may safely connect this equipment to the telephone line by means of a standard modular jack, USOC RJ11C.

A plug and jack used to connect this equipment to the premises wiring and telephone network must comply with the applicable FCC Part 68 rules and requirements adopted by the ACTA. A compliant telephone cord and modular plug is provided with this product. It is designed to be connected to a compatible modular jack that is also compliant. See installation instructions for details.

The REN is used to determine the number of devices that may be connected to a telephone line. Excessive RENs on a telephone line may result in the devices not ringing in response to an incoming call. In most but not all areas, the sum of RENs should not exceed five (5.0). To be certain of the number of devices that may be connected to a line, as determined by the total RENs, contact the local telephone company. For products approved after July 23, 2001, the REN for this product is part of the product identifier that has the format US:AAAEQ##TXXXX. The digits represented by ## are the REN without a decimal point (e.g., 06 is a REN of 0.6). For earlier products, the REN is separately shown on the label.

If this equipment causes harm to the telephone network, the telephone company will notify you in advance that temporary discontinuance of service may be required. But if advance notice isn't practical, the telephone company will notify the customer as soon as possible. Also, you will be advised of your right to file a complaint with the FCC if you believe it is necessary.

The telephone company may make changes in its facilities, equipment, operations or procedures that could affect the operation of the equipment. If this happens the telephone company will provide advance notice in order for you to make necessary modifications to maintain uninterrupted service.

If trouble is experienced with this equipment, for repair or warranty information, please contact Brother Customer Service. (See *Brother numbers* on page i.) If the equipment is causing harm to the telephone network, the telephone company may request that you disconnect the equipment until the problem is resolved.

Connection to party line service is subject to state tariffs. Contact the state public utility commission, public service commission or corporation commission for information.

If your home has specially wired alarm equipment connected to the telephone line, ensure the installation of this equipment does not disable your alarm equipment. If you have questions about what will disable alarm equipment, call your telephone company or a qualified installer.

If you are not able to solve a problem with your MFC, call Brother Customer Service. (See *Brother numbers* on page i.)

### **WARNING**

For protection against the risk of electrical shock, always disconnect all cables from the wall outlet before servicing, modifying or installing the equipment.

This equipment may not be used on coin service lines provided by the telephone company or connected to party lines.

Brother cannot accept any financial or other responsibilities that may be the result of your use of this information, including direct, special or consequential damages. There are no warranties extended or granted by this document.

## **WARNING**

This MFC has been certified to comply with FCC standards, which are applied to the USA only. A grounded plug should be plugged into a grounded AC outlet after checking the rating of the local power supply for the MFC to operate properly and safely.

## **Federal Communications Commission (FCC) Declaration of Conformity (USA only)**

---

Responsible Party: Brother International Corporation  
100 Somerset Corporate Boulevard  
Bridgewater, NJ 08807-0911 USA  
TEL: (908) 704-1700

declares, that the products

Product Name: MFC-8420, MFC-8820D and MFC-8820DN

comply with Part 15 of the FCC Rules. Operation is subject to the following two conditions: (1) This device may not cause harmful interference, and (2) this device must accept any interference received, including interference that may cause undesired operation.

This equipment has been tested and found to comply with the limits for a Class B digital device, pursuant to Part 15 of the FCC Rules. These limits are designed to provide reasonable protection against harmful interference in a residential installation. This equipment generates, uses, and can radiate radio frequency energy and, if not installed and used in accordance with the instructions, may cause harmful interference to radio communications. However, there is no guarantee that interference will not occur in a particular installation. If this equipment does cause harmful interference to radio or television reception, which can be determined by turning the equipment off and on, the user is encouraged to try to correct the interference by one or more of the following measures:

- Reorient or relocate the receiving antenna.
- Increase the separation between the equipment and receiver.
- Connect the equipment into an outlet on a circuit different from that to which the receiver is connected.
- Call the dealer or an experienced radio/TV technician for help.

## **Important**

Changes or modifications not expressly approved by Brother Industries, Ltd. could void the user's authority to operate the equipment.

### **Important – about the interface cable**

A shielded interface cable should be used to ensure compliance with the limits for a Class B digital device.

## **Industry Canada Compliance Statement (Canada only)**

---

This Class B digital apparatus complies with Canadian ICES-003.

Cet appareil numérique de la classe B est conforme à la norme NMB-003 du Canada.

## **International ENERGY STAR® Compliance Statement**

---

The purpose of the International ENERGY STAR® Program is to promote the development and popularization of energy-efficient office equipment.

As an ENERGY STAR® Partner, Brother Industries, Ltd. has determined that this product meets the ENERGY STAR® guidelines for energy efficiency.



## **Laser safety**

---

This equipment is certified as a Class I laser product under the U.S. Department of Health and Human Services (DHHS) Radiation Performance Standard according to the Radiation Control for Health and Safety Act of 1968. This means that the equipment does not produce hazardous laser radiation.



Since radiation emitted inside the equipment is completely confined within protective housings and external covers, the laser beam cannot escape from the MFC during any phase of user operation.

## FDA regulations

---

U.S. Food and Drug Administration (FDA) has implemented regulations for laser products manufactured on and after August 2, 1976. Compliance is mandatory for products marketed in the United States. The following label on the back of the MFC indicates compliance with the FDA regulations and must be attached to laser products marketed in the United States.

**Manufactured:**

BROTHER CORP. (ASIA) LTD.

BROTHER BUJI NAN LING FACTORY

Gold Garden Industry, Nan Ling Village, Buji, Rong Gang,  
Shenzhen, China.

This product complies with FDA radiation performance standards,  
21 CFR Subchapter J.

 **WARNING**

Use of controls, adjustments or performance of procedures other than those specified in this manual may result in hazardous invisible radiation exposure.

 **WARNING**

Changes or modifications not expressly approved by Brother Industries, Ltd. may void the user's authority to operate the equipment.

Internal laser radiation

Max. Radiation Power      5 mW

Wave Length                760 - 810 nm

Laser Class                 Class IIIb (Accordance with 21 CFR  
Part 1040.10)

# Important safety instructions

- 1** Read all of these instructions.
- 2** Save them for later reference.
- 3** Follow all warnings and instructions marked on the product.
- 4** Switch off before cleaning. Do not use liquid or aerosol cleaners. Use a damp cloth for cleaning.
- 5** Do not use this product near water.
- 6** Do not place this product on an unstable cart, stand, or table. The product may fall, causing serious damage to the product.
- 7** Slots and openings in the cabinet and the back or bottom are provided for ventilation; to ensure reliable operation of the product and to protect it from overheating, these openings must not be blocked or covered. The openings should never be blocked by placing the product on a bed, sofa, rug, or other similar surface. This product should never be placed near or over a radiator or heater. This product should never be placed in a built-in installation unless proper ventilation is provided.
- 8** This product should be operated from the type of power source indicated on the label. If you are not sure of the type of power available, call your dealer or local power company.  
Use only the power cord supplied with this MFC.
- 9** This product is equipped with a 3-wire grounded plug, a plug having a third (grounded) pin. This plug will only fit into a grounded power outlet. This is a safety feature. If you are unable to insert the plug into the outlet, call your electrician to replace your obsolete outlet. Do not defeat the purpose of the grounded plug.
- 10** Do not allow anything to rest on the power cord. Do not place this product where people can walk on the cord.
- 11** If an extension cord is used with this product, make sure that the total ampere ratings on the products plugged into the extension cord do not exceed the extension cord ampere rating. Also, make sure that the total of all products plugged into the wall outlet does not exceed 15 amperes (USA only).
- 12** Do not place anything in front of the MFC that will block received faxes. Do not place anything in the path of received faxes.

- 13** Wait until pages have exited the MFC before picking them up.
- 14** Never push objects of any kind into this product through cabinet slots, since they may touch dangerous voltage points or short out parts resulting in the risk of fire or electric shock. Never spill liquid of any kind on the product. Do not attempt to service this product yourself because opening or removing covers may expose you to dangerous voltage points and other risks and may void your warranty. Refer all servicing to a Brother Authorized Service Center. For the location of your nearest Brother Authorized Service Center, please call **In USA:** 1-800-284-4357 or **In Canada:** 1-877-BROTHER. (See *Brother numbers* on page i.)
- 15** Unplug this product from the wall outlet and refer servicing to Authorized Service Personnel under the following conditions:
- When the power cord is damaged or frayed.
  - If liquid has been spilled into the product.
  - If the product has been exposed to rain or water.
  - If the product does not operate normally when the operating instructions are followed. Adjust only those controls that are covered by the operating instructions. Improper adjustment of other controls may result in damage and will often require extensive work by a qualified technician to restore the product to normal operation.
  - If the product has been dropped or the cabinet has been damaged.
  - If the product exhibits a distinct change in performance, indicating a need for service.
- 16** To protect your product against power surges, we recommend the use of a power protection device (Surge Protector).
- 17** To reduce the risk of fire, electric shock and injury to persons, note the following:
- Do not use this product near appliances that use water, a swimming pool or in a wet basement.
  - Do not use the MFC's telephone during an electrical storm (there is the remote possibility of an electrical shock) or to report a gas leak in the vicinity of the leak.
  - Use only the power cord indicated in this manual.

# Trademarks

The Brother logo is a registered trademark of Brother Industries, Ltd.

Brother is a registered trademark of Brother Industries, Ltd.

Multi-Function Link is a registered trademark of Brother International Corporation.

© Copyright 2003 Brother Industries, Ltd. All rights reserved.

Windows, Microsoft and Windows NT are registered trademarks of Microsoft in the U.S. and other countries.

Macintosh, QuickDraw, iMac and iBook are trademarks or registered trademarks of Apple Computer, Inc.

Postscript and Postscript Level 3 are registered trademarks or trademarks of Adobe Systems Incorporated.

PaperPort and TextBridge are registered trademarks of ScanSoft, Inc.

Presto! PageManager is a registered trademark of NewSoft Technology Corporation.

Each company whose software title is mentioned in this manual has a Software License Agreement specific to its proprietary programs.

**All other brand and product names mentioned in this User's Guide are registered trademarks of their respective companies.**

# 22 Troubleshooting and routine maintenance

## Troubleshooting

### IMPORTANT

For technical help, you must call the country where you bought the MFC. Calls must be made **from within** that country.

### Error messages

As with any sophisticated office product, errors may occur. If this happens, your MFC identifies the problem and displays an error message. The most common error messages are shown below.

You can correct most problems by yourself. If you need additional help, call the Brother fax back system (USA only).

**In USA only:** 1-800-521-2846

| ERROR MESSAGES                                  |                                                                                                                       |                                                                                                                                         |
|-------------------------------------------------|-----------------------------------------------------------------------------------------------------------------------|-----------------------------------------------------------------------------------------------------------------------------------------|
| ERROR MESSAGE                                   | CAUSE                                                                                                                 | ACTION                                                                                                                                  |
| Change Drum Soon                                | The drum unit is near the end of its life.                                                                            | Use the drum unit until you have a print quality problem; then replace the drum unit with a new one.                                    |
|                                                 | The drum counter was not reset                                                                                        | 1. Open the front cover, and then press <b>Clear/Back</b> .<br>2. Press 1 to reset.                                                     |
| Check Original                                  | The originals were not inserted or fed properly, or original scanned from ADF was longer than about 36 inches (90cm). | See <i>Original jams</i> on page 22-4.                                                                                                  |
| Check Paper<br>Check Paper #1<br>Check Paper #2 | The MFC is out of paper or paper is not properly loaded in the paper tray.                                            | Refill the paper in the paper tray or MP tray.<br>—OR—<br>Remove the paper and load it again.                                           |
| Check Paper MP                                  | Paper in the MP tray runs out.                                                                                        | Reload paper. (See <i>To load paper or other media in the multi-purpose tray (MP tray)</i> (For MFC-8820D and MFC-8820DN) on page 2-8.) |
| Check Paper Size                                | When you see this error, the paper in the paper tray does not match the paper size you set in <b>Menu, 1, 3</b> .     | Load the appropriate size paper or change the default setting. (See <i>Setting the Mode Timer</i> on page 4-5.)                         |

| ERROR MESSAGES                   |                                                                                                                                                                                                                                                                                     |                                                                                                                                                                                 |
|----------------------------------|-------------------------------------------------------------------------------------------------------------------------------------------------------------------------------------------------------------------------------------------------------------------------------------|---------------------------------------------------------------------------------------------------------------------------------------------------------------------------------|
| ERROR MESSAGE                    | CAUSE                                                                                                                                                                                                                                                                               | ACTION                                                                                                                                                                          |
| Check Scan Lock                  | The scanner lock is locked.                                                                                                                                                                                                                                                         | Release the scanner lock lever, and then press <b>Stop/Exit</b> .                                                                                                               |
| Comm. Error                      | Poor phone line quality caused communication error.                                                                                                                                                                                                                                 | Try the call again. If problem continues, call Telephone Company to check your phone line.                                                                                      |
| Connection Fail                  | You tried to poll a fax machine that is not in Polled Waiting mode.                                                                                                                                                                                                                 | Verify the other party's polling setup.                                                                                                                                         |
| Cooling Down<br>Wait For A While | The temperature of the drum unit or toner cartridge is too hot. The MFC will pause its current print job and go in to cooling down mode. During the cooling down mode, you will hear the cooling fan running while the display on the MFC shows Cooling Down, and Wait For A While. | You must wait 20 minutes for it to cool.                                                                                                                                        |
| Cover Open<br>PLS Close Cover    | The front cover was not completely closed.                                                                                                                                                                                                                                          | Close the front cover for the drum unit.                                                                                                                                        |
| Disconnected                     | The other party or other party's fax machine terminated the call.                                                                                                                                                                                                                   | Try to transmit or receive again.                                                                                                                                               |
| DX Lever Error                   | The paper adjustment lever for duplex printing is not correctly set for the paper size.                                                                                                                                                                                             | Set the duplex lever to the correct position. (See <i>To use Automatic Duplexing for fax, copy and print operations (For MFC-8820D and MFC-8820DN)</i> on page 2-10.)           |
| Face Up Open                     | The face-up output tray is open.                                                                                                                                                                                                                                                    | Please close the face-up output tray.                                                                                                                                           |
| Fuser Open                       | The fuser cover is open.                                                                                                                                                                                                                                                            | Please close the jam clear cover. (See <i>Paper jams</i> on page 22-6.)                                                                                                         |
| Machine Error<br>XX              | MFC has a mechanical problem.                                                                                                                                                                                                                                                       | Call Brother Customer Service and tell them the Machine Error number.<br><b>In USA: 1-800-284-4329</b><br><b>In Canada: 1-877-BROTHER</b><br><b>In Montreal: (514) 685-6464</b> |

| ERROR MESSAGES   |                                                                              |                                                                                                                                                                                                                                                                                                                                                                                                                                                                                                                                                                                                                                                                                                                                                                                                                                |
|------------------|------------------------------------------------------------------------------|--------------------------------------------------------------------------------------------------------------------------------------------------------------------------------------------------------------------------------------------------------------------------------------------------------------------------------------------------------------------------------------------------------------------------------------------------------------------------------------------------------------------------------------------------------------------------------------------------------------------------------------------------------------------------------------------------------------------------------------------------------------------------------------------------------------------------------|
| ERROR MESSAGE    | CAUSE                                                                        | ACTION                                                                                                                                                                                                                                                                                                                                                                                                                                                                                                                                                                                                                                                                                                                                                                                                                         |
| Out Of Memory    | You can't store data in the memory.                                          | <p>(Fax sending in process)<br/>Press <b>Stop</b> and wait until the other operations in progress finish and then try again.<br/>—OR—<br/>Clear the data in the memory. (See <i>Out of Memory message</i> on page 10-5.)</p> <p>(Copy operation in process)<br/>Press <b>Stop</b> and wait until the other operations in process finish and then try again.<br/>—OR—<br/>Clear the data in the memory. (See <i>Out of Memory message</i> on page 10-5.)<br/>—OR—<br/>Add an optional memory. (See <i>Memory board</i> on page 23-1.)</p> <p>(Printing operation in process)<br/>Reduce print resolution. (See <i>Print Quality</i> on page 12-5.)<br/>—OR—<br/>Clear the data in the memory. (See <i>Out of Memory message</i> on page 10-5.)<br/>—OR—<br/>Add an optional memory. (See <i>Memory board</i> on page 23-1.)</p> |
| No Response/Busy | The number you dialed does not answer or is busy.                            | Verify the number and try again.                                                                                                                                                                                                                                                                                                                                                                                                                                                                                                                                                                                                                                                                                                                                                                                               |
| Not Registered   | You tried to access a One-Touch or Speed-Dial number that is not programmed. | Set up the One-Touch or Speed-Dial number. (See <i>Storing One-Touch Dial numbers</i> on page 7-1 and <i>Storing Speed-Dial numbers</i> on page 7-2.)                                                                                                                                                                                                                                                                                                                                                                                                                                                                                                                                                                                                                                                                          |
| Pls Open Cover   | A page, piece of paper or paper clip, etc. may be jammed inside the MFC.     | <p>Open the front cover. If you see any jammed paper or other item, gently pull it out, then close the front cover. If the error message remains, open and close the front cover again.</p> <p>If the MFC cannot reset itself and return to the date and time prompt, it will display <i>Machine Error XX</i>. Please call Brother Customer Service and tell them the Machine Error number:</p> <p><b>In USA: 1-800-284-4329</b><br/><b>In Canada: 1-877-BROTHER</b><br/><b>In Montreal: (514) 685-6464</b></p>                                                                                                                                                                                                                                                                                                                |
| No DX Tray       | You tried to make duplex printing with duplex cover open.                    | Install the duplex tray correctly. (See <i>Paper is jammed in the duplex tray</i> (For MFC-8820D and MFC-8820DN) on page 22-11.)                                                                                                                                                                                                                                                                                                                                                                                                                                                                                                                                                                                                                                                                                               |

| ERROR MESSAGES |                                                                                                                                                    |                                                                                                                                                 |
|----------------|----------------------------------------------------------------------------------------------------------------------------------------------------|-------------------------------------------------------------------------------------------------------------------------------------------------|
| ERROR MESSAGE  | CAUSE                                                                                                                                              | ACTION                                                                                                                                          |
| Paper Jam      | The paper is jammed in the MFC.                                                                                                                    | See <i>Paper jams</i> on page 22-6 or <i>Paper is jammed in the duplex tray</i> (For MFC-8820D and MFC-8820DN) on page 22-11.                   |
| Toner Empty    | Toner cartridge is not installed.<br>—OR—<br>Toner is used up and printing is not possible.                                                        | Reinstall the toner cartridge.<br>—OR—<br>Replace the toner cartridge with a new one. (See <i>Replacing the toner cartridge</i> on page 22-28.) |
| Toner Low      | If the LCD shows <i>Toner Low</i> , you can still print.<br>But the toner is depleted and the MFC is telling you that the toner will soon run out. | Order a new toner cartridge now.                                                                                                                |

## Original jams

Based upon where the original is jammed, follow the appropriate set of instructions to remove it.

### Original is jammed in the top of the ADF unit.

- 1** Take out any paper from the ADF that is not jammed.
- 2** Lift the ADF cover.
- 3** Pull the jammed original out to the right.
- 4** Close the ADF cover.
- 5** Press **Stop/Exit**.

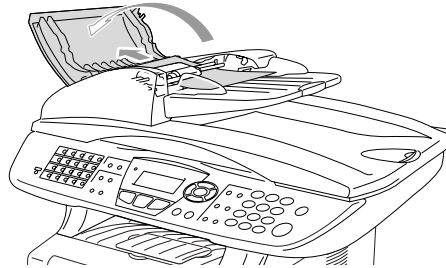



## Original is jammed inside the ADF unit.

- 1** Take out any paper from the ADF that is not jammed.
- 2** Lift the document cover.
- 3** Pull the jammed original out to the right.
- 4** Close the document cover.
- 5** Press **Stop/Exit**.

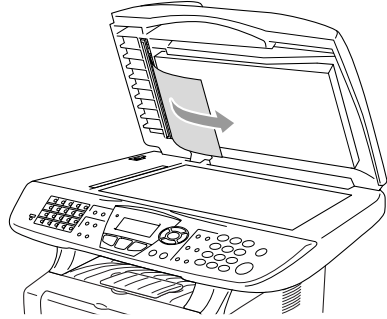

—OR—

- 1** Take the ADF support out of the ADF unit.
- 2** Pull the jammed original out to the right.
- 3** Press **Stop/Exit**.

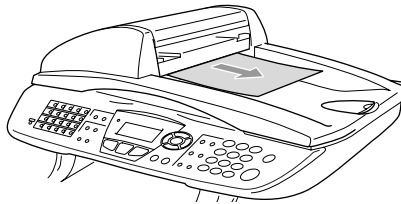

# Paper jams

---

To clear paper jams, please follow the steps in this section.

## WARNING

After you have just used the MFC, some parts inside the MFC are extremely hot. When you open the front cover or back output tray of the MFC, never touch the shaded parts shown in the following diagram.

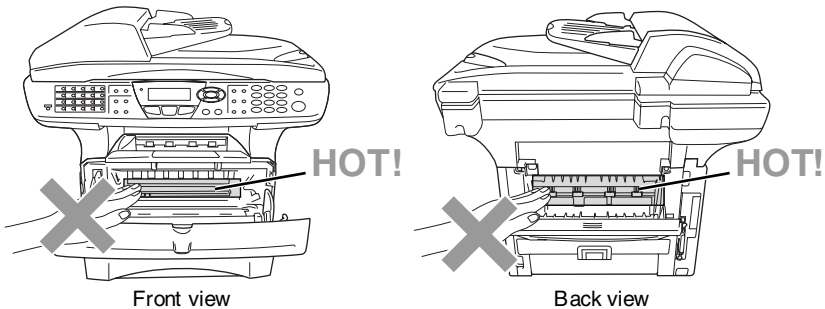

Clear the jammed paper as follows.

If the jammed paper is removed completely by using the information in the following steps, you can install the paper tray first, and then close the front cover and the MFC will resume printing automatically.



- If a paper jam occurs when using the optional lower tray unit, check for correct installation of the upper paper tray.
- Always remove all paper from the paper tray and straighten the stack when you add new paper. This helps prevent multiple sheets of paper from feeding through the MFC at one time and reduces paper jams.

- 1** Pull the paper tray completely out of the MFC.
- 2** Pull the jammed paper up and out of the MFC.

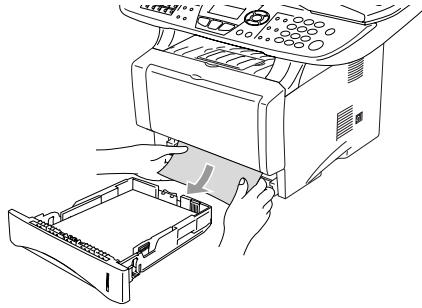

- 3** Press the cover release button and then open the front cover.
- 4** Pull out the drum unit assembly. Pull the jammed paper up and out of the MFC. If you cannot remove the drum unit assembly easily at this time, do not use extra force. Instead, pull the edge of the jammed paper from the paper tray.

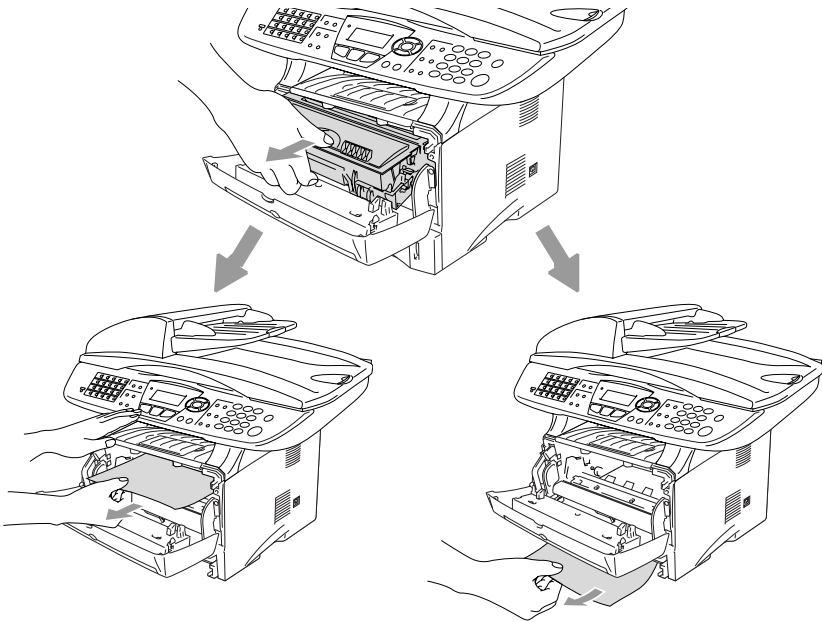

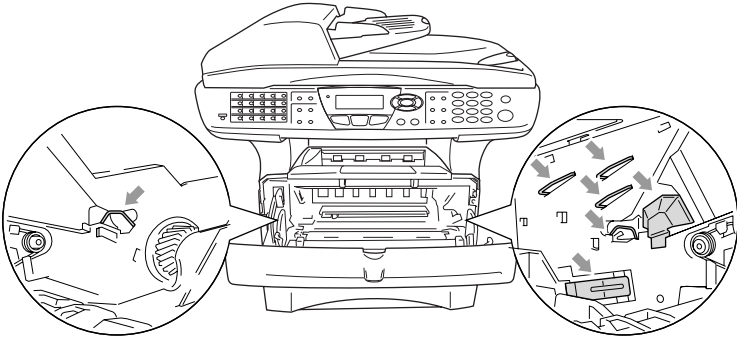

**⚠ WARNING**

To prevent damage to the MFC caused by static electricity, do not touch the electrodes shown in the following diagram.

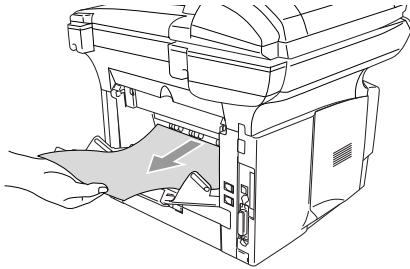

- 5** Open the back output tray. Pull the jammed paper out of the fuser unit. If the paper jam can be cleared, go to Step 7.



 If you have to pull the paper toward the back of the MFC, the fuser may get dirty with toner powder and it may scatter on the next printouts. Print a few copies of the test page until the scattering of toner stops.

**⚠ WARNING**

After you have just used the MFC, some internal parts of the MFC are extremely **HOT!** Wait for the MFC to cool down before you touch the internal parts of the MFC.

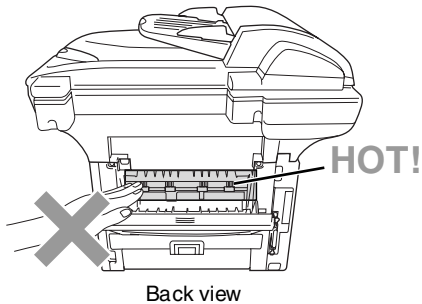

- 6** Open the jam clear cover (fuser cover). Pull the jammed paper out of the fuser unit.

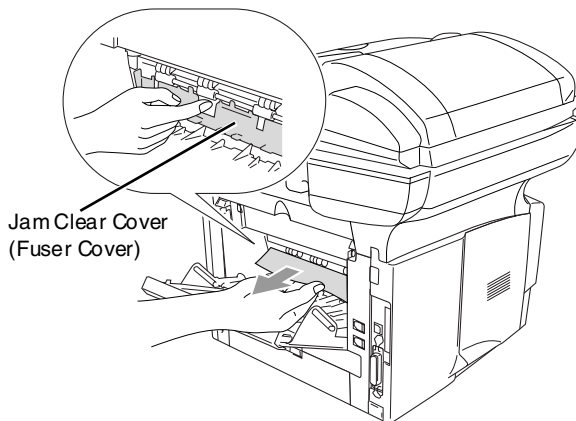

- 7** Close the jam clear cover. Close the back output tray.

- 8** Push the lock lever down and take the toner cartridge out of the drum unit assembly. Take out the jammed paper if there is any inside the drum unit.

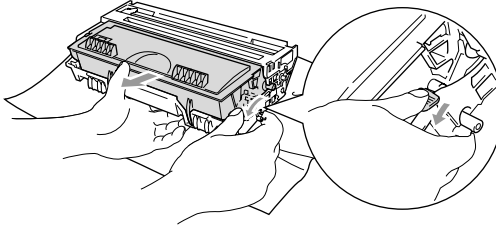

- 9** Put the drum unit assembly back in the MFC.  
**10** Put the paper tray in the MFC.  
**11** Close the front cover.

## Paper is jammed in the duplex tray (For MFC-8820D and MFC-8820DN)

- 1** Pull the duplex tray and paper tray out of the MFC.

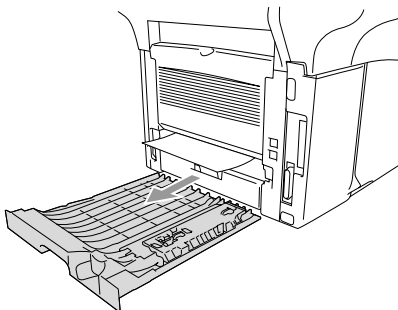

- 2** Pull the jammed paper out of the MFC.

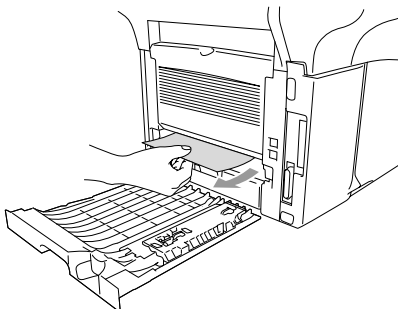

- 3** Put the duplex tray and paper tray back into the MFC.

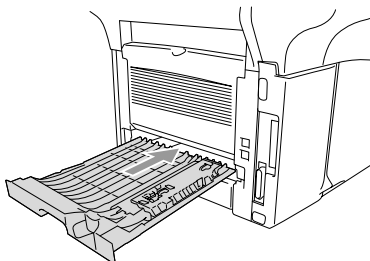



- The **Jam Duplex** message appears if you remove a sheet of paper from the Face Down Output Tray after only one side has printed.
- If the Paper Adjustment Lever for Duplex Printing is not set correctly for the paper size, paper jams may occur and the printing will be out of position on the page. (See *To use Automatic Duplexing for fax, copy and print operations (For MFC-8820D and MFC-8820DN)* on page 2-10.)



# If you are having difficulty with your MFC

If you think there is a problem with the way your faxes look, *make a copy first*. If the copy looks good, the problem is probably not your MFC. Check the chart below and follow the troubleshooting tips.

| DIFFICULTY                                                                             | SUGGESTIONS                                                                                                                                                                                                                                                                                                                                                                                                                                                                                                                                                                 |
|----------------------------------------------------------------------------------------|-----------------------------------------------------------------------------------------------------------------------------------------------------------------------------------------------------------------------------------------------------------------------------------------------------------------------------------------------------------------------------------------------------------------------------------------------------------------------------------------------------------------------------------------------------------------------------|
| <b>Printing or Receiving Faxes</b>                                                     |                                                                                                                                                                                                                                                                                                                                                                                                                                                                                                                                                                             |
| Condensed print and horizontal streaks or the top and bottom of sentences are cut off. | If your copy looks good, you probably had a bad connection, with static or interference on the telephone line. If the copy looks bad, clean the scanner area. If there is still problem, call Brother Customer Service at 1-800-284-4329 (in USA), 1-877-BROTHER (in Canada) or (514) 685-6464 (in Montreal).                                                                                                                                                                                                                                                               |
| Poor quality print.                                                                    | See <i>Improving the print quality</i> on page 22-18.                                                                                                                                                                                                                                                                                                                                                                                                                                                                                                                       |
| Vertical black lines when receiving.                                                   | Sometimes you may see vertical streaks/black lines on the faxes you receive. Your MFC's primary corona wire for printing may be dirty, or the sending party's fax scanner may be dirty. Clean your primary corona wire (See <i>Cleaning the drum unit</i> on page 22-27), or ask the sender to make a copy to see if the problem is with the sending machine. Try receiving from another fax machine. If the problem continues, call Brother Customer Service at 1-800-284-4329 (in USA), 1-877-BROTHER (in Canada) or (514) 685-6464 (in Montreal).                        |
| Horizontal streaks; lines are missing.                                                 | You may get a fax with horizontal streaks or with missing lines. Usually this is caused by a poor telephone connection. Ask the other party to send the fax again.                                                                                                                                                                                                                                                                                                                                                                                                          |
| Received faxes appear as split or blank pages.                                         | If the received data is divided and printed on two pages or if you get an additional blank page, your Paper Size setting may not be correct for the paper you are using (See <i>Type and size of paper</i> on page 2-1). Make sure that auto reduction function setting is turned on. (See <i>Printing a reduced incoming fax (Auto Reduction)</i> on page 5-5)                                                                                                                                                                                                             |
| <b>Phone Line or Connections</b>                                                       |                                                                                                                                                                                                                                                                                                                                                                                                                                                                                                                                                                             |
| Dialing does not work                                                                  | Check for a dial tone. Change Tone/ Pulse setting. (See <i>Setting Tone and Pulse dialing mode (For Canada only)</i> on page 4-4.) Check all line cord connections. Check power cord connection. Send a manual fax by pressing <b>Hook</b> or by lifting the external handset and dialing the number. Wait to hear fax receiving tones before pressing <b>Start</b> .                                                                                                                                                                                                       |
| The MFC does not answer when called.                                                   | Make sure the MFC is in the correct receiving mode for your setup. (See <i>Basic sending operations</i> on page 6-6.) Check for a dial tone. If possible, call your MFC to hear it answer. If there is still no answer, check the telephone line cord connection. If there is no ringing when you call your MFC, ask your telephone company to check the line.                                                                                                                                                                                                              |
| <b>Sending Faxes</b>                                                                   |                                                                                                                                                                                                                                                                                                                                                                                                                                                                                                                                                                             |
| Poor sending quality.                                                                  | Try changing your resolution to <b>Fine</b> or <b>S.Fine</b> . Make a copy to check your MFC's scanner operation. If copy quality is not good, clean the scanner. (See <i>Cleaning the scanner</i> on page 22-25.)                                                                                                                                                                                                                                                                                                                                                          |
| Transmission Verification Report says 'RESULT:NG' or 'RESULT:ERROR'.                   | There is probably temporary noise or static on the line. Try sending the fax again. If you send a PC FAX message and get 'RESULT:NG' or, on the Transmission Verification Report, your MFC may be out of memory. To gain extra memory, you can turn off Fax Storage (See <i>Setting Fax Storage</i> on page 8-3), print fax messages in memory (See <i>Polling</i> on page 5-9) or cancel a Delayed Fax or Polling Job (See <i>Canceling a job while scanning the original</i> on page 6-11). If the problem continues, ask the telephone company to check your phone line. |

| DIFFICULTY                                                                   | SUGGESTIONS                                                                                                                                                                                                                                                                                                                                                                                                                                                                                                                                                                                                                                                                                                                                                                                                                                                                                                          |
|------------------------------------------------------------------------------|----------------------------------------------------------------------------------------------------------------------------------------------------------------------------------------------------------------------------------------------------------------------------------------------------------------------------------------------------------------------------------------------------------------------------------------------------------------------------------------------------------------------------------------------------------------------------------------------------------------------------------------------------------------------------------------------------------------------------------------------------------------------------------------------------------------------------------------------------------------------------------------------------------------------|
| Vertical black lines when sending.                                           | If the copy you made shows the same problem, your scanner is dirty. (See <i>Cleaning the scanner</i> on page 22-25.)                                                                                                                                                                                                                                                                                                                                                                                                                                                                                                                                                                                                                                                                                                                                                                                                 |
| <b>Handling Incoming Calls</b>                                               |                                                                                                                                                                                                                                                                                                                                                                                                                                                                                                                                                                                                                                                                                                                                                                                                                                                                                                                      |
| MFC 'Hears' Voice as CNG Tone.                                               | If your MFC is set to Easy Receive ON, it is more sensitive to sounds. Your MFC may mistakenly interpret certain voices or music on the line as a calling fax machine and respond with fax receiving tones. Deactivate the fax by pressing <b>Stop/Exit</b> . Try avoiding this problem by turning Easy Receive to OFF. (See <i>Easy Receive</i> on page 5-4.)                                                                                                                                                                                                                                                                                                                                                                                                                                                                                                                                                       |
| Sending a Fax Call to the MFC.                                               | If you answered at the MFC, press <b>Start</b> and hang up immediately. If you answered on an external or extension phone, press your Fax Receive Code (default setting is ( * 51). When your MFC answers, hang up.                                                                                                                                                                                                                                                                                                                                                                                                                                                                                                                                                                                                                                                                                                  |
| Custom features on a single line.                                            | If you have Call Waiting, Call Waiting/Caller ID, Caller ID, RingMaster, Voice Mail, an answering machine, an alarm system or other custom feature on a single phone line with your MFC, it may create a problem sending or receiving fax data.<br><b>For Example:</b> Your Brother MFC handles the Caller ID subscriber services. However, if you subscribe to Call Waiting or some other custom service and its signal comes through the line while your MFC is sending or receiving a fax, the signal can temporarily interrupt or disrupt the fax data. Brother's ECM feature should help overcome this problem. This condition is related to the telephone system industry and is common to all devices that send and receive information on a single, shared line with custom features. If avoiding a slight interruption is crucial to your business, a separate line with no custom features is recommended. |
| <b>Menu Setting Difficulties</b>                                             |                                                                                                                                                                                                                                                                                                                                                                                                                                                                                                                                                                                                                                                                                                                                                                                                                                                                                                                      |
| The MFC beeps when you try to access the Setup Receive and Setup Send menus. | Make sure that MFC is in Fax mode. If the Fax  key is not illuminated, press it to turn on Fax mode. Setup Receive setting ( <b>Menu, 2, 1</b> ) and Setup Send setting ( <b>Menu, 2, 2</b> ) are available only when the MFC is in Fax mode.                                                                                                                                                                                                                                                                                                                                                                                                                                                                                                                                                                                       |
| <b>Copy Quality Difficulties</b>                                             |                                                                                                                                                                                                                                                                                                                                                                                                                                                                                                                                                                                                                                                                                                                                                                                                                                                                                                                      |
| Vertical streaks appear in copies.                                           | Sometimes you may see vertical streaks on your copies. Either the scanner or the primary corona wire for printing is dirty. Clean them both. (See <i>Cleaning the scanner</i> on page 22-25 and <i>Cleaning the drum unit</i> on page 22-27.)                                                                                                                                                                                                                                                                                                                                                                                                                                                                                                                                                                                                                                                                        |





| DIFFICULTY                                                                                              | SUGGESTIONS                                                                                                                                                                                                                                                                                                                                                                                                                                                                                                         |
|---------------------------------------------------------------------------------------------------------|---------------------------------------------------------------------------------------------------------------------------------------------------------------------------------------------------------------------------------------------------------------------------------------------------------------------------------------------------------------------------------------------------------------------------------------------------------------------------------------------------------------------|
| <b>Printer Difficulties</b>                                                                             |                                                                                                                                                                                                                                                                                                                                                                                                                                                                                                                     |
| The MFC does not print.                                                                                 | Check the following: <ul style="list-style-type: none"> <li>• The MFC is plugged in and the power switch turned On. (See the Quick Setup Guide on page 7.)</li> <li>• The toner cartridge and drum unit are installed properly. (See <i>Replacing the drum unit</i> on page 22-34.)</li> <li>• The interface cable is securely connected between the MFC and computer. (See the Quick Setup Guide.)</li> <li>• Check to see if LCD is showing an error message. (See <i>Error messages</i> on page 22-1)</li> </ul> |
| The MFC prints unexpectedly or it prints garbage.                                                       | Reset the MFC or turn it off and then on again. Check the primary settings in your application software to make sure it is set up to work with your MFC.                                                                                                                                                                                                                                                                                                                                                            |
| The MFC prints first couple of pages correctly, then some pages have text missing.                      | Your computer is not recognizing the printer's input buffer full signal. Please make sure to connect the MFC cable correctly.                                                                                                                                                                                                                                                                                                                                                                                       |
| The MFC cannot print full pages of a document. Out Of Memory message occurs.                            | Reduce the printing resolution. Reduce the complexity of your document and try again. Reduce the graphic quality or the number of font sizes within your application software.                                                                                                                                                                                                                                                                                                                                      |
| My headers or footers appear when I view my document on the screen but do not appear when I print them. | Most laser printers have a restricted area that will not accept print. Usually these are the first two lines and last two lines, leaves 62 printable lines. Adjust the top and bottom margins in your document to allow for this.                                                                                                                                                                                                                                                                                   |
| <b>Scanning Difficulties</b>                                                                            |                                                                                                                                                                                                                                                                                                                                                                                                                                                                                                                     |
| TWAIN errors appear while scanning.                                                                     | Make sure the Brother TWAIN driver is selected as the primary source. In PaperPort®, click Scan in the File menu and select the Brother TWAIN driver.                                                                                                                                                                                                                                                                                                                                                               |



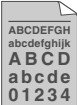
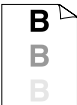

| DIFFICULTY                                                                                       | SUGGESTIONS                                                                                                                                                                                                                                                                                                                                                                                                                                                                                                                                                                                                                                                                                                                                                                                                                                                                                                                    |
|--------------------------------------------------------------------------------------------------|--------------------------------------------------------------------------------------------------------------------------------------------------------------------------------------------------------------------------------------------------------------------------------------------------------------------------------------------------------------------------------------------------------------------------------------------------------------------------------------------------------------------------------------------------------------------------------------------------------------------------------------------------------------------------------------------------------------------------------------------------------------------------------------------------------------------------------------------------------------------------------------------------------------------------------|
| <b>Software Difficulties</b>                                                                     |                                                                                                                                                                                                                                                                                                                                                                                                                                                                                                                                                                                                                                                                                                                                                                                                                                                                                                                                |
| Cannot perform '2 in 1 or 4 in 1' printing.                                                      | Check that the paper size setting in the application and in the printer driver are the same.                                                                                                                                                                                                                                                                                                                                                                                                                                                                                                                                                                                                                                                                                                                                                                                                                                   |
| Cannot print when using Adobe Illustrator.                                                       | Try to reduce the print resolution.                                                                                                                                                                                                                                                                                                                                                                                                                                                                                                                                                                                                                                                                                                                                                                                                                                                                                            |
| When using ATM fonts, some characters are missing or some characters are printed in their place. | If you are using Windows® 95/98/98SE/Me, select 'Printer Settings' from the 'Start' menu. Select the properties of the 'Brother MFC-8420 or MFC-8820D (USB) Printer'. Click 'Spool Setting' on the 'Details' tab. Select 'RAW' from 'Spool Data Format.'                                                                                                                                                                                                                                                                                                                                                                                                                                                                                                                                                                                                                                                                       |
| "Unable to write to LPT1" or "LPT1 already in use" Error Message appears.                        | 1. Make sure the MFC is on (plugged into the AC power outlet and turned the power switch on) and that it is connected directly to the computer using the bundled IEEE-1284 bi-directional parallel cable. The cable must not go through another peripheral device (such as a Zip Drive, External CD-ROM Drive, or Switch box).<br>2. Make sure the MFC is not displaying an error message on the LCD Display.<br>3. Make sure no other device drivers, which also communicate through the parallel port, are running automatically when you boot up the computer (such as, drivers for Zip Drives, External CD-ROM Drive, etc.) Suggested areas to check: ( <i>Load=, Run=commandlines in the win.ini file or the Setup Group</i> )<br>4. Check with your computer manufacturer to confirm that the computer's parallel port settings in the BIOS are set to support a bi-directional machine; i.e. (Parallel Port Mode – ECP) |
| "MFC is Busy" Error Message appears.                                                             |                                                                                                                                                                                                                                                                                                                                                                                                                                                                                                                                                                                                                                                                                                                                                                                                                                                                                                                                |
| 'MFC Connect Failure'                                                                            | If the MFC is not connected to your PC and you have loaded the Brother software, the PC will show 'MFC Connect Failure' each time you restart Windows®. You can ignore this message or you can turn it off as follows. Double-click "tool\WamOFF.REG" from the supplied CD-ROM. The Scan key on the MFC's control panel will not work unless you restart your PC with the MFC connected. To turn it back on, Double-click "tool\WamON.REG" from the supplied CD-ROM.                                                                                                                                                                                                                                                                                                                                                                                                                                                           |
| <b>Paper Handling Difficulties</b>                                                               |                                                                                                                                                                                                                                                                                                                                                                                                                                                                                                                                                                                                                                                                                                                                                                                                                                                                                                                                |
| The MFC does not load paper. The LCD shows Check Paper or Paper Jam.                             | Check to see if the Check Paper or Paper Jam message appears on the LCD. If it is empty, load a new stack of paper into the paper tray. If there is paper in the paper tray, make sure it is straight. If the paper is curled, you should straighten it. Sometimes it is helpful to remove the paper, turn the stack over and put it back into the paper tray. Reduce the amount of paper in the paper tray, and then try again. Check that the manual feed mode or MP tray or MP mode is not selected in the printer driver.                                                                                                                                                                                                                                                                                                                                                                                                  |
| The MFC does not feed paper from the manual feed tray.                                           | Reinsert the paper firmly, load one sheet at a time. Make sure that manual feed mode or MP mode is selected in the printer driver.                                                                                                                                                                                                                                                                                                                                                                                                                                                                                                                                                                                                                                                                                                                                                                                             |
| How can I load envelopes?                                                                        | You can load envelopes from the manual feed or MP tray. Your application software must be set up to print the envelope size you are using. This is usually done in the Page Setup or Document Setup menu of your software. Refer to your software application manual.                                                                                                                                                                                                                                                                                                                                                                                                                                                                                                                                                                                                                                                          |
| What paper can I use?                                                                            | You can use plain paper, envelopes, transparencies and labels that are made for laser machines. (For information on paper you can use, see <i>Printer operation keys</i> on page 11-16.)                                                                                                                                                                                                                                                                                                                                                                                                                                                                                                                                                                                                                                                                                                                                       |
| How can I clear paper jams?                                                                      | See <i>Paper jams</i> on page 22-6.                                                                                                                                                                                                                                                                                                                                                                                                                                                                                                                                                                                                                                                                                                                                                                                                                                                                                            |





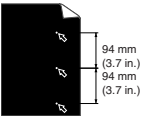
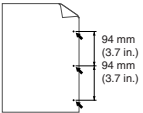
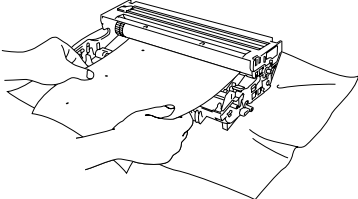

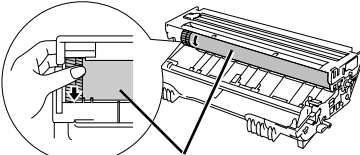
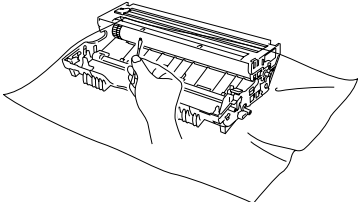
| DIFFICULTY                        | SUGGESTIONS                                                                                                                                                                                                                                                                                                                                                                                                       |
|-----------------------------------|-------------------------------------------------------------------------------------------------------------------------------------------------------------------------------------------------------------------------------------------------------------------------------------------------------------------------------------------------------------------------------------------------------------------|
| <b>Print Quality Difficulties</b> |                                                                                                                                                                                                                                                                                                                                                                                                                   |
| Printed pages are curled.         | Thin or thick paper below the standard can cause this problem. Make sure you select the Paper Type that suits the media type you use. (See <i>Setting the Paper Type</i> on page 4-5 and <i>Media Type</i> on page 12-4.)                                                                                                                                                                                         |
| Printed pages are smeared.        | The Paper Type setting may be incorrect for the type of print media you are using— <b>OR</b> —The print media may be too thick or have a rough surface. (See <i>Setting the Paper Type</i> on page 4-5 and <i>Media Type</i> on page 12-4.)                                                                                                                                                                       |
| Printouts are too light           | Set Toner Save mode to off in the Advance tab in the printer driver. (See <i>Toner Save</i> on page 12-6.)                                                                                                                                                                                                                                                                                                        |
| <b>Network Difficulties</b>       |                                                                                                                                                                                                                                                                                                                                                                                                                   |
| I cannot print over the Network   | Make sure that your MFC is powered on and is On Line and in Ready mode. Press the Test switch. Then the current settings of the NC-9100h are printed. Verify that the cabling and Network connections are good. If possible, try connecting the MFC to a different port on your hub using a different cable. Check to see if there is any LED activity. The NC-9100h has a two color LED for diagnosing problems. |

# Improving the print quality

This section provides information on the following topics:

| Examples of poor print quality                                                                                  | Recommendation                                                                                                                                                                                                                                                                                                                                                                                                                                                                                                                                                                                                                                                                     |
|-----------------------------------------------------------------------------------------------------------------|------------------------------------------------------------------------------------------------------------------------------------------------------------------------------------------------------------------------------------------------------------------------------------------------------------------------------------------------------------------------------------------------------------------------------------------------------------------------------------------------------------------------------------------------------------------------------------------------------------------------------------------------------------------------------------|
|  <p><b>Faint</b></p>           | <p>Check the printer's environment. Conditions such as humidity, high temperatures, and so on may cause this print fault. (See <i>Choosing a location</i> on page ix.)</p> <p>If the whole page is too light, <b>Toner Save</b> mode may be on. Turn off <b>Toner Save</b> mode in the printer Properties tab of the driver.</p> <p>—OR—</p> <p>If your MFC is not connected to a computer, turn off Toner Save mode in the MFC itself. (See <i>Toner Save</i> on page 4-9.)</p> <p>Try installing a new toner cartridge. (See <i>Replacing the toner cartridge</i> on page 22-28.)</p> <p>Try installing a new drum unit. (See <i>Replacing the drum unit</i> on page 22-34.)</p> |
|  <p><b>Gray background</b></p> | <p>Make sure that you use paper that meets the recommended specifications. (See <i>About paper</i> on page 2-1.)</p> <p>Check the printer's environment - high temperatures and high humidity can increase the amount of background shading. (See <i>Choosing a location</i> on page ix.)</p> <p>Use a new toner cartridge. (See <i>Replacing the toner cartridge</i> on page 22-28.)</p> <p>Use a new drum unit. (See <i>Replacing the drum unit</i> on page 22-34.)</p>                                                                                                                                                                                                          |
|  <p><b>Ghost</b></p>           | <p>Make sure you use paper that meets our specifications. Rough-surfaced paper or thick print media may cause this problem.</p> <p>Make sure that you choose the appropriate media type in the printer driver. (See <i>About paper</i> on page 2-1.)</p> <p>Try using a new drum unit. (See <i>Replacing the drum unit</i> on page 22-34.)</p>                                                                                                                                                                                                                                                                                                                                     |
|  <p><b>Toner specks</b></p>   | <p>Make sure that you use paper that meets our specifications. Rough-surfaced paper may cause the problem. (See <i>About paper</i> on page 2-1.)</p> <p>The drum unit may be damaged. Put in a new drum unit. (See <i>Replacing the drum unit</i> on page 22-34.)</p>                                                                                                                                                                                                                                                                                                                                                                                                              |
|  <p><b>Hollow print</b></p>  | <p>Make sure that you use paper that meets our specifications. (See <i>About paper</i> on page 2-1.)</p> <p>Choose <b>Thick paper</b> mode in the printer driver, or use thinner paper than you are currently using.</p> <p>Check the printer's environment because conditions such as high humidity can cause hollow print. (See <i>Choosing a location</i> on page ix.)</p>                                                                                                                                                                                                                                                                                                      |
|  <p><b>All black</b></p>     | <p>You may clear the problem by cleaning the primary corona wire inside the drum unit by sliding the blue tab. Make sure you return the blue tab to the home position (▲). (See <i>Cleaning the drum unit</i> on page 22-27.)</p> <p>The drum unit may be damaged. Put in a new drum unit. (See <i>Replacing the drum unit</i> on page 22-34.)</p>                                                                                                                                                                                                                                                                                                                                 |

| Examples of poor print quality                                                                                                                                                                                                                                                                               | Recommendation                                                                                                                                                                                                                                                                                                                                                                                                                                                                                                                                                                                                                                                                                                                                                                                                                                                                                                                                                                                                                                                                                                                                                                                                                                                                                                                                                                                                                                                                        |
|--------------------------------------------------------------------------------------------------------------------------------------------------------------------------------------------------------------------------------------------------------------------------------------------------------------|---------------------------------------------------------------------------------------------------------------------------------------------------------------------------------------------------------------------------------------------------------------------------------------------------------------------------------------------------------------------------------------------------------------------------------------------------------------------------------------------------------------------------------------------------------------------------------------------------------------------------------------------------------------------------------------------------------------------------------------------------------------------------------------------------------------------------------------------------------------------------------------------------------------------------------------------------------------------------------------------------------------------------------------------------------------------------------------------------------------------------------------------------------------------------------------------------------------------------------------------------------------------------------------------------------------------------------------------------------------------------------------------------------------------------------------------------------------------------------------|
|  <p><b>White Spots on black text and graphics at 94 mm (3.7 in.) intervals</b></p>  <p><b>Black Spots at 94 mm (3.7 in.) intervals</b></p> | <p>If the problem is not solved after printing a few pages, the drum unit may have glue from label stock on the OPC drum surface.</p> <p>Clean the drum unit as follows:</p> <ol style="list-style-type: none"> <li>1 Position the print sample in front of the drum unit, and find the exact position of the poor print.</li> </ol>  <ol style="list-style-type: none"> <li>2 Turn the drum unit gear by hand while looking at the surface of the OPC drum.</li> </ol> <p> Do not touch the photosensitive drum with your fingers.</p>  <p>Photosensitive drum</p> <ol style="list-style-type: none"> <li>3 When you have located the mark on the drum that matches the print sample, wipe the surface of the OPC drum with a cotton swab until the dust or paper powder on the surface comes off.</li> </ol>  <p> Do not try to clean the surface of the photosensitive drum with a sharp object, such as a ball-point pen, and so on.</p> <p>The drum unit may be damaged. Put in a new drum unit. (See <i>Replacing the drum unit</i> on page 22-34.)</p> |

| Examples of poor print quality                                                                                                                                               | Recommendation                                                                                                                                                                                                                                                                                                                                                                                                                                                                                                                                                                                                                        |
|------------------------------------------------------------------------------------------------------------------------------------------------------------------------------|---------------------------------------------------------------------------------------------------------------------------------------------------------------------------------------------------------------------------------------------------------------------------------------------------------------------------------------------------------------------------------------------------------------------------------------------------------------------------------------------------------------------------------------------------------------------------------------------------------------------------------------|
|  <p><b>Black toner marks across the page</b></p>                                            | <p>The drum unit may be damaged. Put in a <b>new drum unit</b>. (See <i>Replacing the drum unit</i> on page 22-34.)</p> <p>Make sure that you use paper that meets our specifications. (See <i>About paper</i> on page 2-1.)</p> <p>If you use label sheets for laser printers, the glue from the sheets may sometimes stick to the OPC drum surface. Clean the drum unit. (See <i>Cleaning the drum unit</i> on page 22-27.)</p> <p>Do not use paper that has clips or staples because they will scratch the surface of the drum.</p> <p>If the unpacked drum unit is in direct sunlight or room light, the unit may be damaged.</p> |
|  <p><b>White lines across the page</b></p>                                                  | <p>Make sure that you use paper that meets our specifications. A rough surfaced paper or thick print media can cause the problem.</p> <p>Make sure that you select the appropriate media type in the printer driver.</p> <p>The problem may disappear by itself. Try printing multiple pages to clear this problem, especially if the printer has not been used for a long time.</p> <p>The drum unit may be damaged. Put in a <b>new drum unit</b>. (See <i>Replacing the drum unit</i> on page 22-34.)</p>                                                                                                                          |
|  <p><b>Lines across the page</b></p>                                                        | <p>Clean the inside of the printer and the primary corona wire in the drum unit. (See <i>Cleaning the drum unit</i> on page 22-27.)</p> <p>The drum unit may be damaged. Put in a <b>new drum unit</b>. (See <i>Replacing the drum unit</i> on page 22-34.)</p>                                                                                                                                                                                                                                                                                                                                                                       |
|  <p><b>Black lines down the page</b><br/>Printed pages have toner stains down the page.</p> | <p>Clean the primary corona wire of the drum unit.</p> <p>Make sure the primary corona wire cleaner is at the home position (▲).</p> <p>The drum unit may be damaged. Install a <b>new drum unit</b>. (See <i>Replacing the drum unit</i> on page 22-34.)</p> <p>The toner cartridge may be damaged. Put in a <b>new toner cartridge</b>. (See <i>Replacing the toner cartridge</i> on page 22-28.) Make sure that a torn piece of paper is not inside the printer covering the scanner window.</p> <p>The fixing unit may be smudged. Call Customer Service.</p>                                                                     |
|  <p><b>White lines down the page</b></p>                                                   | <p>You may clear the problem by wiping the scanner window with a soft cloth. (See <i>Cleaning the printer</i> on page 22-26.)</p> <p>The toner cartridge may be damaged. Put in a <b>new toner cartridge</b>. (See <i>Replacing the toner cartridge</i> on page 22-28.)</p>                                                                                                                                                                                                                                                                                                                                                           |
|  <p><b>Page skewed</b></p>                                                                | <p>Make sure the paper or other print media is loaded properly in the paper tray and that the guides are not too tight or too loose against the paper stack.</p> <p>Set the paper guides correctly.</p> <p>If you are using the manual feed tray (or the multi-purpose tray). (See <i>How to load paper</i> on page 2-5.)</p> <p>The paper tray may be too full.</p> <p>Check the paper type and quality. (See <i>About paper</i> on page 2-1.)</p>                                                                                                                                                                                   |
|  <p><b>Curly or wave</b></p>                                                              | <p>Check the paper type and quality. High temperatures and high humidity will cause paper to curl.</p> <p>If you don't use the printer very often, the paper may have been in the paper tray too long. Turn over the stack of paper in the paper tray. Also, try fanning the paper stack and then rotating the paper 180° in the paper tray.</p> <p>Try printing using the straight-through output path. (See <i>How to load paper</i> on page 2-5.)</p>                                                                                                                                                                              |



| Examples of poor print quality                                                                                      | Recommendation                                                                                                                                                                                                                                                                                                                     |
|---------------------------------------------------------------------------------------------------------------------|------------------------------------------------------------------------------------------------------------------------------------------------------------------------------------------------------------------------------------------------------------------------------------------------------------------------------------|
|  <p><b>Wrinkles or creases</b></p> | <p>Make sure that paper is loaded properly.<br/> Check the paper type and quality. (See <i>About paper</i> on page 2-1.)<br/> Try printing using the straight-through output path. (See <i>How to load paper</i> on page 2-5.)<br/> Turn over the stack of paper in the tray or try rotating the paper 180° in the input tray.</p> |



The drum unit is a consumable item and it is necessary to replace it periodically.

# Packing and shipping the MFC

Whenever you transport the MFC, use the packing materials that came with your machine. If you do not pack the MFC correctly, you may void your warranty.

- 1** Turn the MFC power switch off.
- 2** Unplug the MFC from the telephone wall jack.
- 3** Unplug the MFC from the AC outlet.

## Lock the Scanner Lock

- 4** Push the Scanner Lock Lever down to lock the scanner. This lever is located on the left of the scanner glass.

Scanner Lock Lever

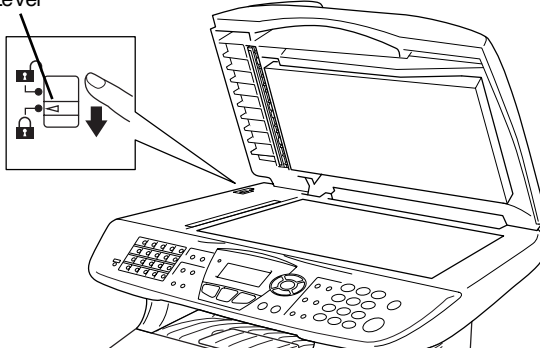

## ! Caution

Damage caused to your MFC by failure to lock the scanner before moving and shipping may void your warranty.

- 5** Open the front cover.

- 6** Remove the drum unit and toner cartridge assembly. Leave the toner cartridge installed in the drum unit.

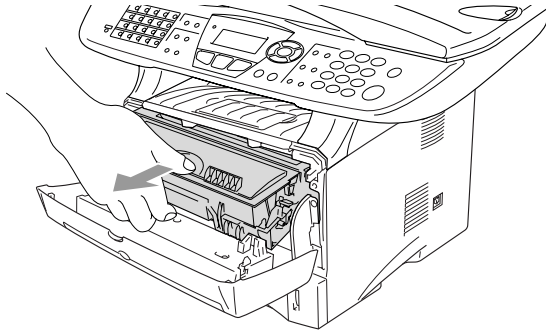

- 7** Place the drum unit and toner cartridge assembly into the plastic bag and seal the bag.

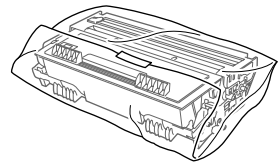

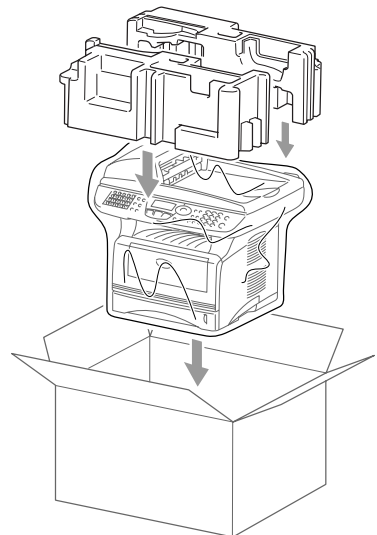
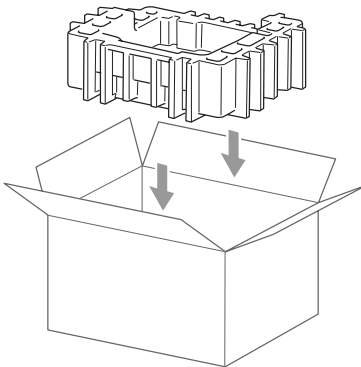

- 8** Close the front cover. Fold down the face-down output tray flap. Remove the telephone line cord.

- 9** Wrap the MFC in the plastic bag and place it in the original carton with the original packing material.

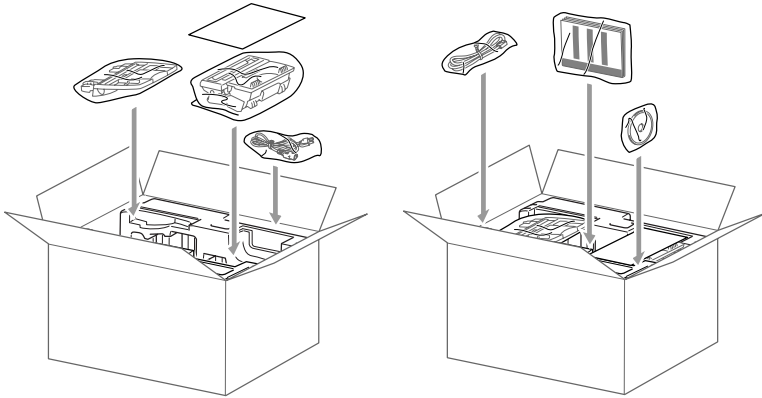

- 10** Pack the drum unit and toner cartridge assembly, telephone line cord, AC cord and printed materials in the original carton as shown below:



 If you are returning the MFC to Brother as part of the Exchange Service, pack *only* the MFC. Keep all separate parts to use with your 'Exchange' machine.

- 11** Close the carton and tape it shut.

# Routine maintenance

## Cleaning the scanner

Turn the MFC power switch off and lift the document cover. Clean the scanner glass and glass strip with dry cloth and the white film with isopropyl alcohol on a lint free cloth.

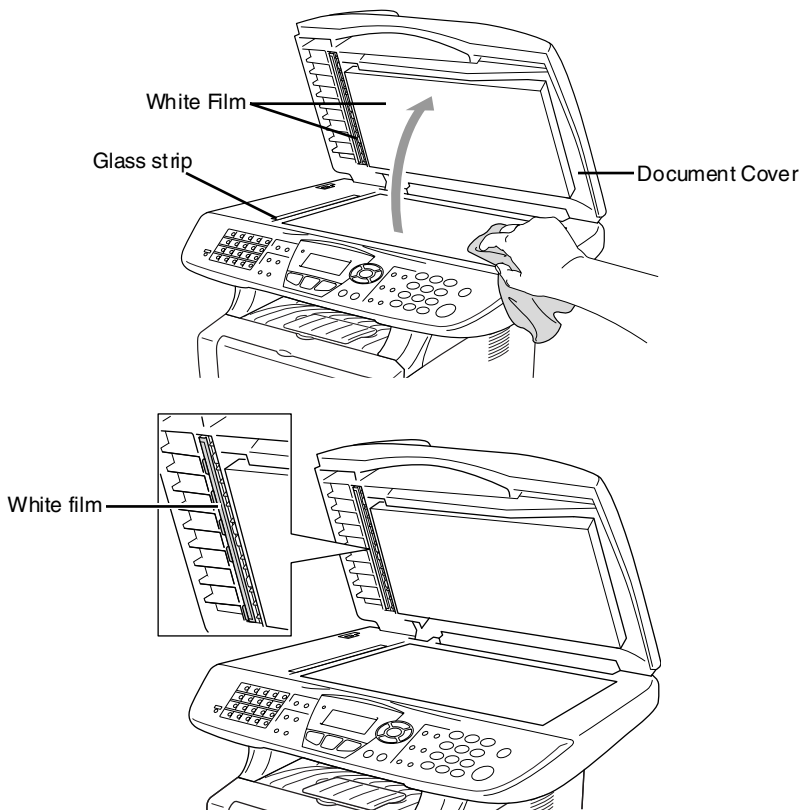

If the screen *still* displays a scanner error, call Brother Customer Service for assistance at 1-800-284-4329 (in USA), 1-877-BROTHER (in Canada), or (514) 685-6464 (in Montreal).

# Cleaning the printer

---

## ! Caution

- Do *not* use isopropyl alcohol to remove dirt from the control panel. It may crack the panel.
  - Do *not* use isopropyl alcohol to clean the laser scanner window.
  - Do *not* touch the scanner window with your finger.
  - The drum unit contains toner, so handle it carefully. If toner scatters and your hands or clothes get dirty, immediately wipe or wash it off with cold water.
- 1 Turn the MFC power switch off and open the front cover.
  - 2 Remove the drum unit and toner cartridge assembly.

## ! WARNING

Just after you have used the MFC, some internal parts of the machine are extremely **HOT!** When you open the front cover of the MFC, never touch the shaded parts shown in the diagram below.

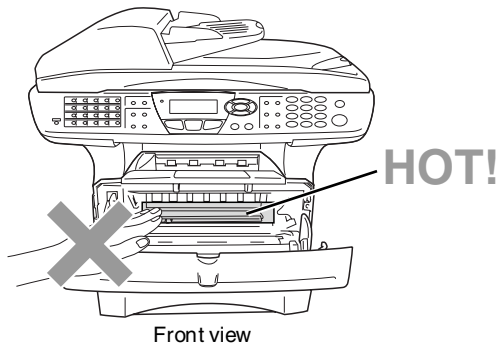

- 3 Gently clean the scanner window by wiping it with a clean soft dry cloth. Do *not* use isopropyl alcohol.

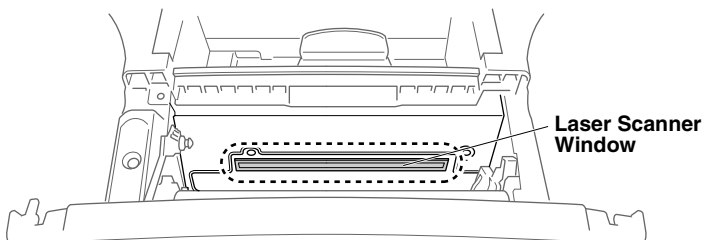

## Cleaning the drum unit

---

We recommend placing the drum unit and toner cartridge assembly on a cloth or large disposable paper to avoid spilling and scattering toner.

- 1** Clean the primary corona wire inside the drum unit by gently sliding the blue tab from right to left several times.
- 2** Return the blue tab and snap it into the Home position (▼).

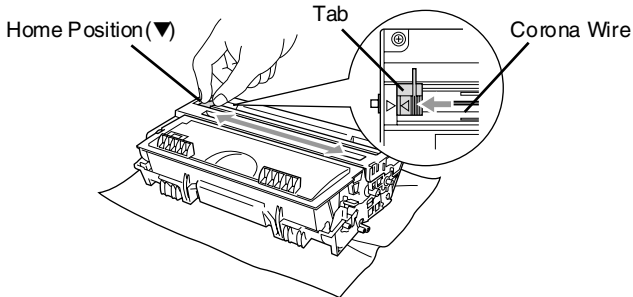

### ! Caution

If the blue tab is not at Home position (▼), printed pages may have vertical stripes.

- 3** Reinstall the drum unit and toner cartridge assembly into the MFC.  
(See *Replacing the drum unit* on page 22-34.)
- 4** Close the front cover.
- 5** Plug in the power cord *first*, then the telephone cord.

## Replacing the toner cartridge

---

The MFC can print *up to* 6,500 pages using a *high yield* toner cartridge. When the toner cartridge is running low, the LCD shows `Toner Low`. The MFC is supplied with a *standard* toner cartridge that must be replaced after approximately 3,300 pages. Actual page count will vary depending on your average type of original (i.e., standard letter, detailed graphics).



It is a good idea to keep a new toner cartridge ready for use when you see the `Toner Low` warning.

Discard the used toner cartridge according to local regulations, keeping it separate from domestic waste. Be sure to seal the toner cartridge tightly so toner powder does not spill out of the cartridge. If you have questions, call your local waste disposal office.

We recommend that you clean the MFC when you replace the toner cartridge.



# How to replace the toner cartridge

## WARNING

Just after you use the MFC, some internal parts of the machine will be extremely **HOT!** So, never touch the shaded parts shown in the illustration.

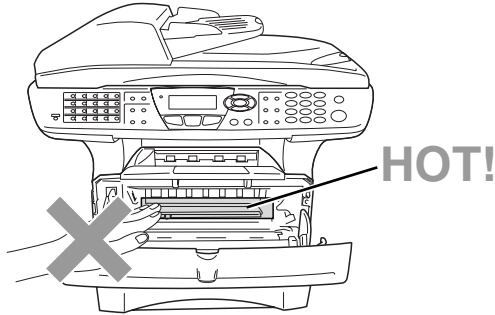

**1** Open the front cover and pull out the drum unit.

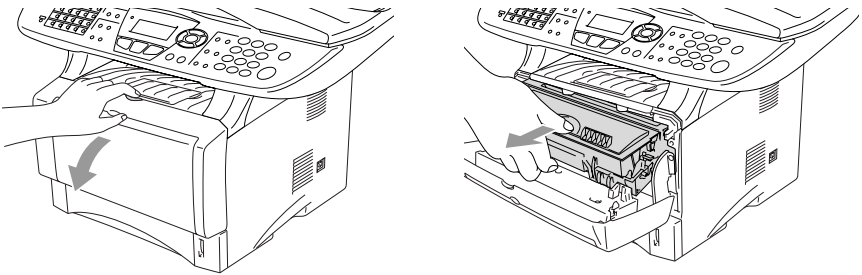

## Caution

- Place the drum unit on a drop cloth or large piece of disposable paper to avoid spilling and scattering the toner.
- To prevent damage to the MFC from static electricity, do not touch the electrodes shown below.

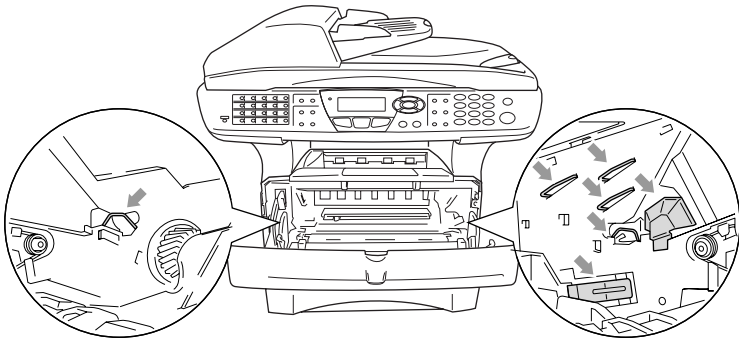

- 2** Hold down the lock lever on the right and pull the toner cartridge out of the drum unit.

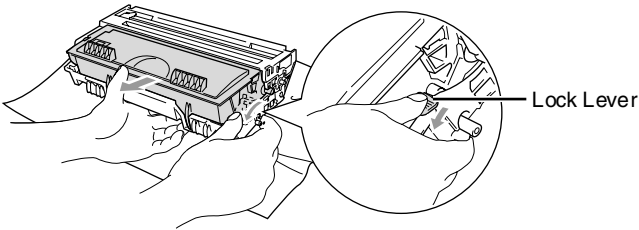

**!** **Caution**

Handle the toner cartridge carefully. If toner scatters on your hands or clothes, immediately wipe it off or wash it with cold water.

- 3 Unpack the new toner cartridge. Place the used toner cartridge into the aluminum bag and discard it according to local regulations.

**! Caution**

- Wait to unpack the toner cartridge until immediately before you install it in the MFC. If a toner cartridge is left unpacked for a long period of time, the toner life is shortened.
  - Brother strongly recommends that you do not refill the toner cartridge provided with your MFC. We also strongly recommend that you continue to use only Genuine Brother Brand replacement toner cartridges (**TN-530** or **TN-560**). Using or attempting to use potentially incompatible toner and/or toner cartridges in your MFC may cause damage to the machine itself and/or it may result in unsatisfactory print quality. Our warranty coverage does not apply to any problem that was caused by the use of unauthorized third party toner and toner cartridges. To protect your investment and guarantee your print quality please continue to replace consumed toner cartridges with only Genuine Brother Branded Supplies.
- 4 Gently rock the toner cartridge from side to side five or six times to distribute the toner evenly inside the cartridge.

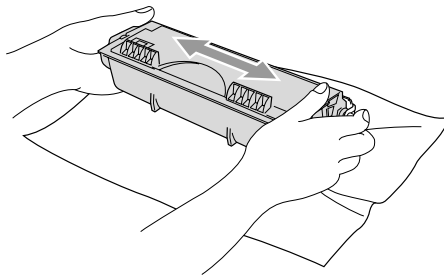

**5** Remove the protective cover.

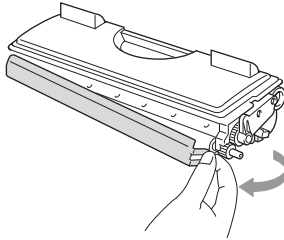

**6** Insert the new toner cartridge in the drum unit until it clicks into place. If you put it in properly, the lock lever will lift automatically.

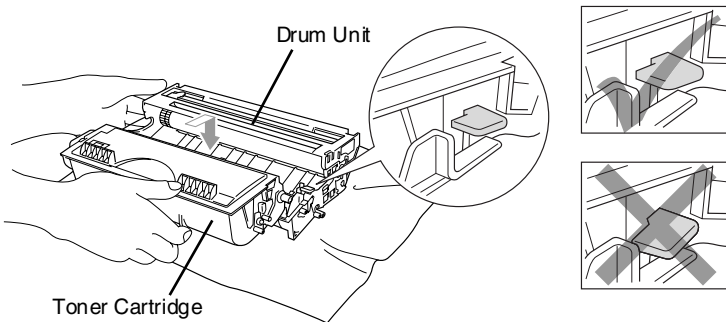

**7** Clean the primary corona wire inside the drum unit by gently sliding the blue tab from right to left several times. Return the blue tab to the Home position (▼) before reinstalling the drum unit and toner cartridge assembly.

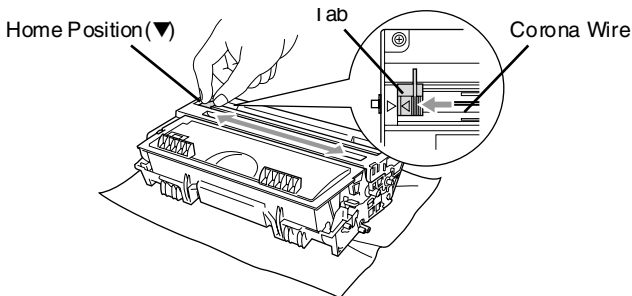

- 8** Reinstall the drum unit and toner cartridge assembly and close the front cover.

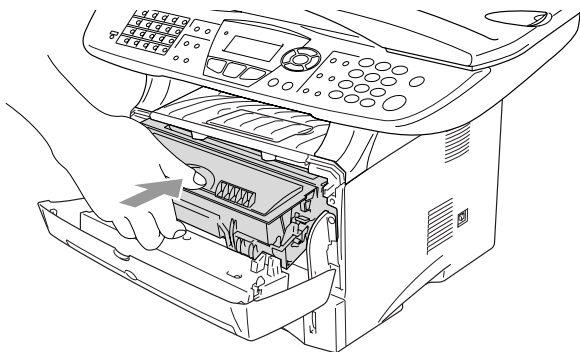

## Replacing the drum unit

---

The MFC uses a drum unit to create print images on paper. If the LCD shows *Change Drum Soon*, the drum unit is near the end of its life and it is time to purchase a new one.

Even if the LCD shows *Change Drum Soon*, you may be able to continue printing without having to replace the drum unit for a while. However, if there is a noticeable deterioration in the output print quality (even before *Change Drum Soon* appears), then the drum unit should be replaced. You should clean the MFC when you replace the drum unit. (See *Cleaning the drum unit* on page 22-27.)

### **Caution**

When removing the drum unit, handle it carefully because it contains toner. If toner scatters and your hands or clothes get dirty, immediately wipe or wash with cold water.



The drum unit is a consumable item, and it is necessary to replace it periodically. There are many factors that determine the actual drum life, such as temperature, humidity, type of paper and how much toner you use for the number of pages per print job. The estimated drum life is *up to 20,000* pages. The actual number of pages your drum will print may be significantly less than these estimates. Because we have no control over the many factors that determine the actual drum life, we cannot guarantee a minimum number of pages that will be printed by your drum.

### **WARNING**

Just after you have used the MFC, some internal parts of the MFC are extremely **HOT!** So please be careful.

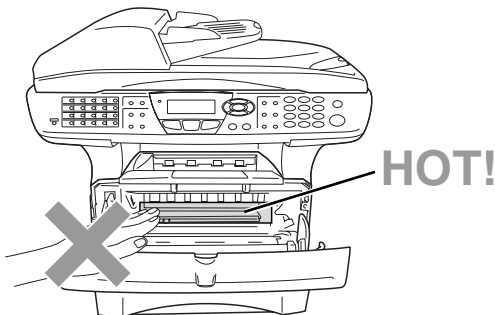

## Follow these steps to replace the drum unit:

- 1 Press the cover release button and then open the front cover.
- 2 Remove the old drum unit and toner cartridge assembly. Place it on a drop cloth or disposable paper to avoid scattering toner.

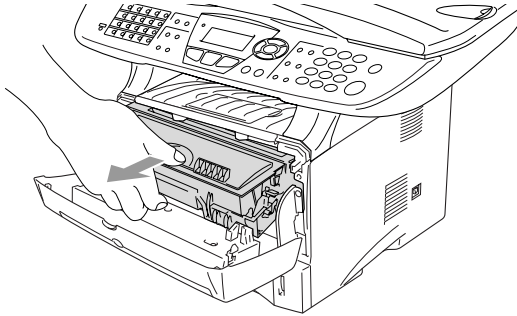

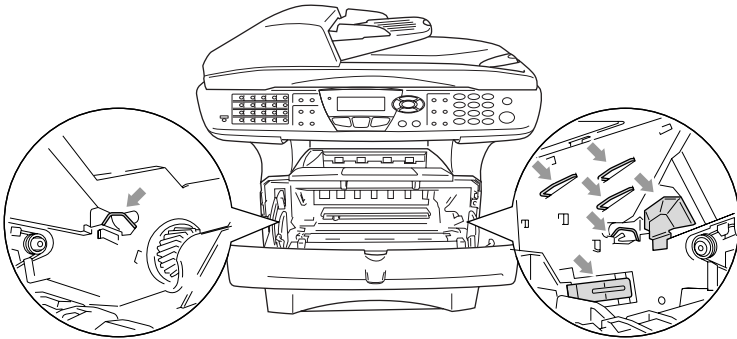

### ! Caution

To prevent damage to the printer from static electricity, do not touch the electrodes shown below.

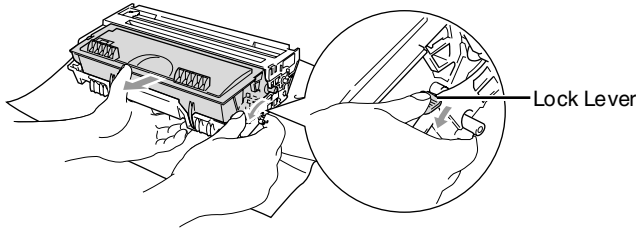

- 3** Hold down the lock lever on the right and pull the toner cartridge out of the drum unit. (See *Replacing the toner cartridge* on page 22-28.)



 Discard the used drum unit according to local regulations, keeping it separate from domestic waste. Be sure to seal the drum unit tightly so toner powder does not spill out of the unit. If you have questions, call your local waste disposal office.

- 4** Wait to unpack the new drum unit until immediately before installing it. Place the old drum unit into the plastic bag and discard it according to local regulations.

**5** Reinstall the toner cartridge into the new drum unit. (See *Replacing the toner cartridge* on page 22-28.)

**6** Reinstall the new drum unit, keeping the front cover *open*.

**7** Press **Clear/Back**.

**8** Press **1** and when the LCD shows *Accepted*, and close the front cover.



 **Caution**

If toner scatters and your hands or clothes get dirty, immediately wipe off or wash with cold water.



## Checking the drum life

---

You can see the percentage of the drum's life that remains available.

- 1** Press **Menu, 2, 0, 2.**
- 2** For five seconds, the LCD shows the available percentage of drum life.

|                                                       |
|-------------------------------------------------------|
| 20.Miscellaneous<br>2.Drum Life<br><br>Remaining:100% |
|-------------------------------------------------------|



Even if the remaining drum life is 0%, you may continue to use the drum unit until you have a print quality problem.

## Page Counter

---

You can see number of total pages, copy pages, print pages and List/Fax (total fax print + total list print) pages that your MFC has printed.

- 1** Press **Menu, 2, 0, 3.**
- 2** The LCD shows number of pages for **Total** and **Copy.**

Press  to see **Print** and **List/Fax.**

- 3** Press **Stop/Exit.**

|                                                                         |
|-------------------------------------------------------------------------|
| 20.Miscellaneous<br>3.Page Counter<br>▲ Total :123456<br>▼ Copy :120002 |
|-------------------------------------------------------------------------|

# 23 Optional accessories

## Memory board

The memory board is installed on the main controller board inside the MFC. When you add the optional memory board, it increases the performance for both copier and printer operations.

| Model Name                         | Optional Memory            |
|------------------------------------|----------------------------|
| MFC-8420 (32 MB Standard Memory)   | 32MB TECHWORKS 12457-0001  |
| MFC-8820D (32 MB Standard Memory)  | 64MB TECHWORKS 12458-0001  |
| MFC-8820DN (32 MB Standard Memory) | 128MB TECHWORKS 12459-0001 |

In general, the DIMM must have the following specifications:

|                  |                           |
|------------------|---------------------------|
| Type:            | 100 pin and 32 bit output |
| CAS Lantency:    | 2 or 3                    |
| Clock Frequency: | 100MHz or more            |
| Capacity:        | 32, 64, 128MB             |
| Height:          | 35mm (1.4 inches) or less |
| Parity:          | NONE                      |
| DRAM Type:       | SDRAM 4 Bank              |

Some DIMMs might not work with this MFC. For the latest information from Brother visit:

<http://solutions.brother.com>

# Installing the optional memory board

## WARNING

- DO NOT touch the surface of the main board within 15 minutes after turning off the power.
  - Before installing the optional memory board, make sure there are no faxes in the memory.
- 1 Disconnect the telephone line cord, turn the MFC power switch off, unplug the MFC power cord from the AC outlet, and then disconnect the interface cable.

## WARNING

Turn the MFC power switch off, before installing (or removing) the memory board.

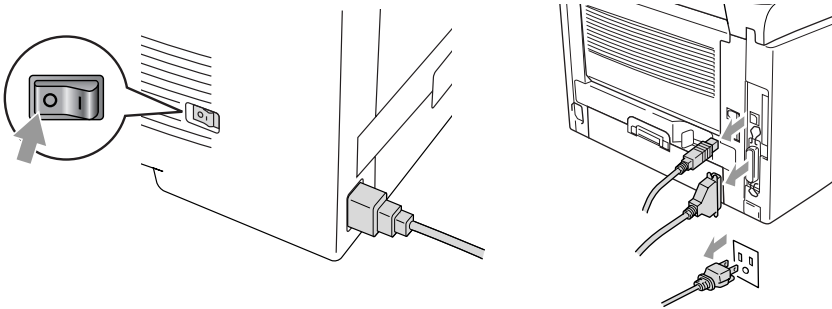

- 2 Remove the side cover. Loosen the two screws, and then remove the metal shield plate.

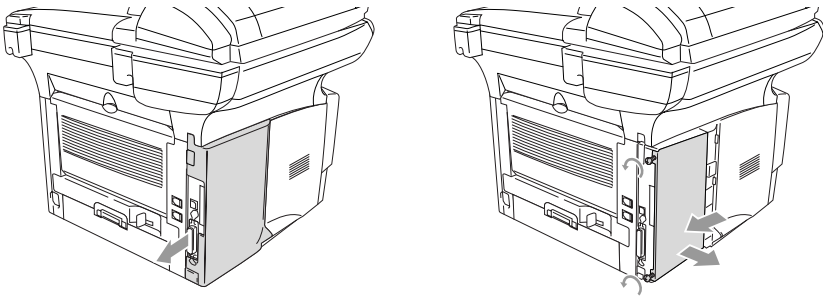

- 3 Unpack the DIMM and hold it by the edges.

## **⚠ WARNING**

DIMM boards can be damaged by even a small amount of static electricity. Do not touch the memory chips or the board surface. Wear an antistatic wrist strap when you install or remove the board. If you do not have an antistatic wrist strap, frequently touch the bare metal on the printer.

- 4** Hold the DIMM with your fingers on the side edges and your thumb on the back edge. Line up the notches on the DIMM with the DIMM slot. (Check that the locks on each side of the DIMM slot are open or facing outwards.)

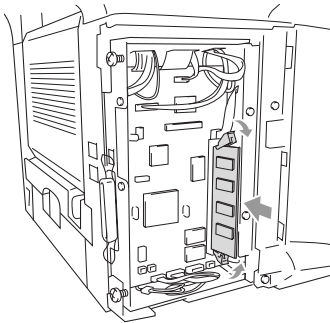

- 5** Press the DIMM straight into the slot (press firmly). Make sure the locks on each side of the DIMM click into place. (To remove a DIMM, you must release the locks.)
- 6** Put the metal plate back on and secure the metal plate with the two screws.
- 7** Put the side cover back on.
- 8** Reconnect the telephone line cord.
- 9** Reconnect any additional interface cables that you removed.
- 10** Reconnect the power cable and then turn on the MFC power switch.



- To check that you have installed the DIMM correctly, print the printer settings by using the selection in the driver and check the printout to make sure it shows the additional memory.
- You can check the current memory size in the user setting list. (See the *NC-9100h Network User's Guide* on the CD-ROM.)

**⚠ WARNING**

If the Status LED turns Red for a Service Error, please call Brother Customer Service at: 1-800-284-4329 (in USA), 1-877-BROTHER (in Canada) or (514) 685-6464 (in Montreal).

## Network (LAN) board

When you add the optional Network (LAN) Board (NC-9100h), you can connect your MFC into the network to use the Internet FAX, Network Scanner, Network Printer and Network Management operations.

**⚠ WARNING**

DO NOT touch the surface of the main board within 15 minutes after turning off the power.

For more details about how to configure the Network board, please see the NC-9100h Network User's Guide on the CD-ROM supplied with the MFC.

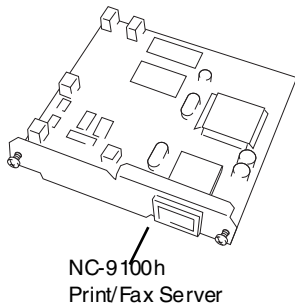

## Before starting installation

---

Be careful when handling the NC-9100h. There are many delicate electronic components that are susceptible to damage from static electricity. To avoid such damage, use the following precautions when handling the board.

- Leave the NC-9100h in its anti-static bag until you are ready to install it.
- Make sure that you are adequately grounded before touching the NC-9100h. Use an anti-static wrist strap and a grounding mat if possible. If you do not have an anti-static wrist strap, touch the bare metal surface on the back of the machine before handling the NC-9100h.
- Avoid moving around the work area in order to eliminate static charge build-up.
- If possible, do not work on a carpeted area.
- Do not flex the board and do not touch the components on the card.

### Tools Required:

Phillips Screwdriver 

## Step 1: Hardware installation

---

### WARNING

DO NOT touch the surface of the main boards within 15 minutes after turning off the power.

- 1 Disconnect the telephone line cord, turn the MFC power switch off, unplug the MFC power cord from the AC outlet, and then disconnect the interface cable.

**⚠ WARNING**

Turn the MFC power switch off, before installing (or removing) the NC-9100h board.

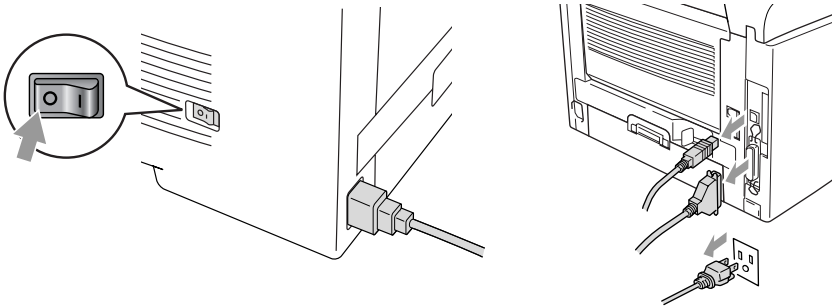

- 2** Remove the side cover. Loosen the two screws, and then remove the metal shield plate.

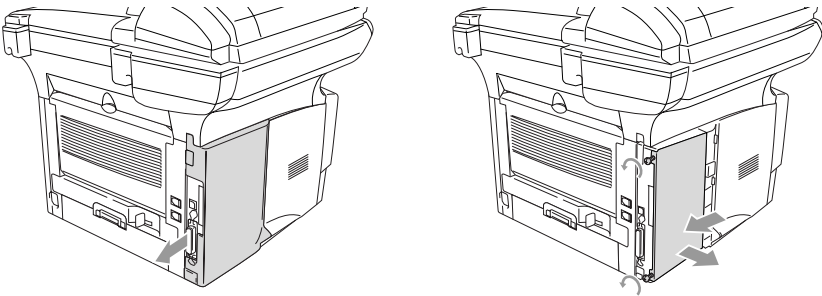

- 3** Loosen the two screws, and then remove the metal cover plate.

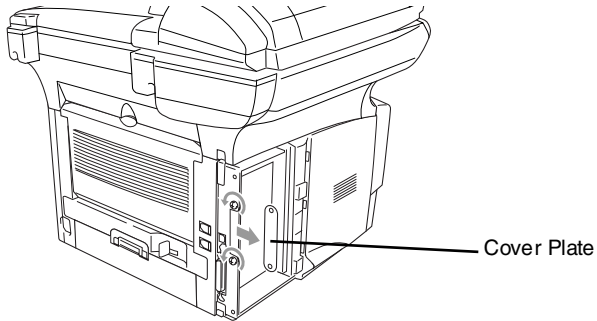

- 4 Plug the NC-9100h into connector P1 located on the main board as shown in the illustration (press firmly) and secure the NC-9100h with the two screws.

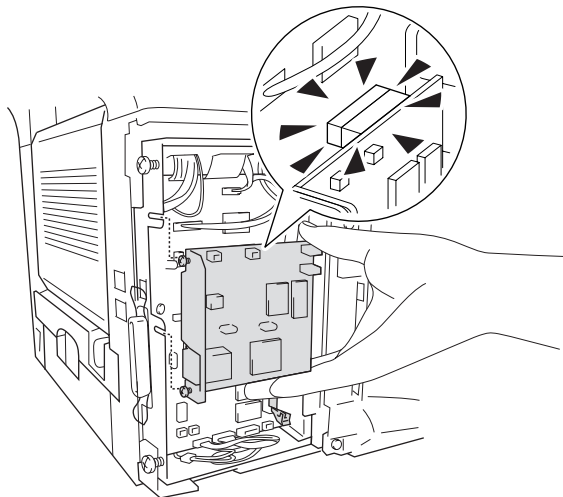

- 5 Put the metal shield plate back on and secure it with the two screws.
- 6 Put the side cover back on.
- 7 Reconnect the telephone line cord.
- 8 Reconnect any additional interface cables that you removed.
- 9 Reconnect the power cable and then turn on the MFC power switch.
- 10 Press the Test switch and print a network configuration page. (See *TEST SWITCH* on page 23-9.)



## Step 2: Connecting the NC-9100h to an Unshielded Twisted Pair 10BASE-T or 100BASE-TX Ethernet Network

---

To connect the NC-9100h to a 10BASE-T or 100BASE-TX Network, you must have an Unshielded Twist Pair Cable. One side of the cable must be connected to a free port on your Ethernet hub and the other side must be connected to the 10BASE-T or 100BASE-TX connector (an RJ45 Connector) of the NC-9100h.

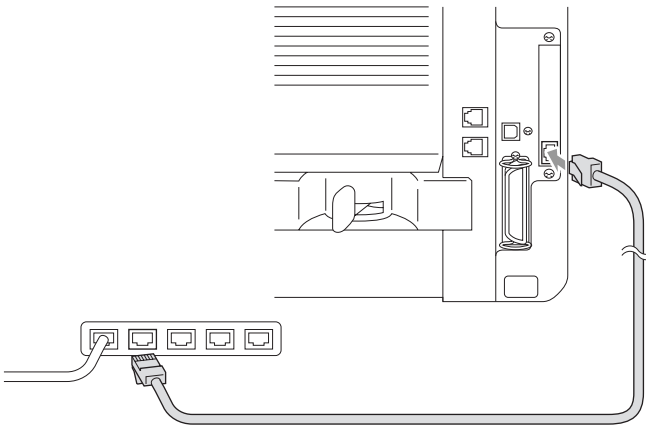

### Verifying successful hardware Installation:

Plug in the AC power cord. After initialization and warm-up (this may take several seconds), the machine will come to a Ready state.

### LED

#### No light:

If both of the two LEDs are off, then the print server is not connected to the network.

#### Link/Speed LED is orange: Fast Ethernet

This Link/Speed LED will be orange if the print server is connected to a 100BASETX Fast Ethernet network.

#### Link/Speed LED is green: 10 BASE T Ethernet

This Link/Speed LED will be green if the print server is connected to a 10 BASE T Ethernet.

## Active LED is yellow:

The Active LED will blink if the print server is receiving or transmitting data.



If there is a valid connection to the network, the LED will blink orange or green.

## TEST SWITCH

Short push: Prints the network configuration page.

Long push (more than 5 seconds): Reset the network configuration back to the factory default settings.

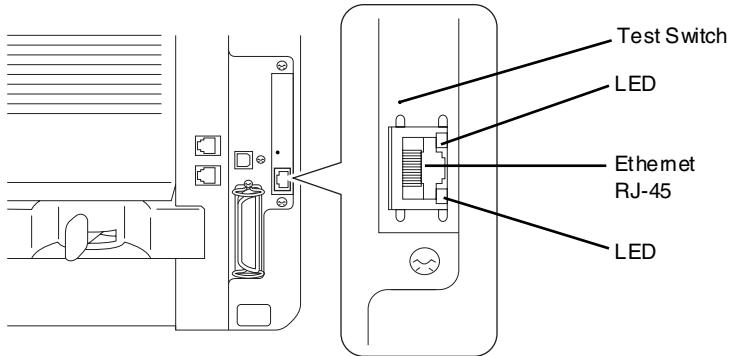

To set up the MFC on the Network, see the *NC-9100h Network User's Guide* on the CD-ROM.

## Paper Tray #2

You can purchase the Paper Tray #2 accessory (LT-5000) to use as a third paper source. Tray #2 holds up to 250 sheets of 20 lb (80 g/m<sup>2</sup>) paper.

|                  |                                                          |
|------------------|----------------------------------------------------------|
| Paper Tray #2    | Holds approx. 250 sheets of 20 lb (80 g/m <sup>2</sup> ) |
| Basis Weight     | 16 to 28 lb (60 to 105 g/m <sup>2</sup> )                |
| Moisture Content | 4% to 6% by weight                                       |
| We Recommend:    | Xerox 4200 DP 20 lb                                      |
| Cut sheet:       | Hammermill Laser Paper 24 lb                             |

# G Glossary

- ADF (Automatic Document Feeder)** The original can be placed in the ADF and scanned one page at a time automatically.
- Auto Dial List** A listing of names and numbers stored in One-Touch and Speed-Dial memory, in numerical order.
- Automatic fax transmission** Sending a fax without picking up the handset of an external phone (or pressing **Hook**).
- Automatic Redial** A feature that enables your MFC to redial the last fax number if the fax did not go through because the line was busy.
- Auto Reduction** Reduces the size of incoming faxes.
- Batch Transmission** As a cost savings feature, all delayed faxes to the same fax number will be sent as one transmission.
- Beeper** The sound the keys make when they are pressed, an error occurs, or a fax has been received or sent.
- Beeper volume** Volume setting for the beep when you press a key or make an error.
- Broadcasting** The ability to send the same fax message to more than one location.
- Caller ID** A subscriber service purchased from the Telephone Company that lets you see the number (or name) of the party calling you. Your MFC stores the latest callers so you can print a Log and view caller information.
- CNG tones** The special tones (beeps) sent by fax machines during automatic transmission to tell the receiving machine that they are from a fax machine.
- Communication error (or Comm. Error)** An error during fax sending or receiving, usually caused by line noise or static.

**Coding Method** Method of coding the information contained in the original. All fax machines must use a minimum standard of Modified Huffman (MH). Your MFC is capable of greater compression methods, Modified Read (MR), Modified Modified Read (MMR) and JBIG, if the receiving machine has the same capability.

**Compatibility Group** The ability of one fax unit to communicate with another. Compatibility is assured between ITU-T Groups.

**Contrast** Setting to compensate for dark or light originals, by making faxes or copies of dark originals lighter and light originals darker.

**Cover Page** Prints a page at the other party's fax machine that contains the sender and recipient's name and fax number, number of pages and comment. You can generate an electronic cover page at the other end with pre-programmed information from memory or you can print a sample cover page to fax with your original.

**Cover Page Message** The comment that is on the Cover Page. This is a programmable feature.

**Delayed Fax** Sends your fax at a later time that day.

**Distinctive Ring** A subscriber service purchased from the telephone company that provides another phone number on an existing phone line. The Brother MFC uses the new number to simulate a dedicated fax line.

**Drum Unit** A printing device for the MFC.

**Dual Access** Your MFC can scan outgoing faxes or scheduled jobs into memory at the same time it is sending a fax or receiving or printing an incoming fax.

**Easy Receive** Enables your MFC to respond to CNG tones if you interrupt a fax call by answering it.

**ECM (Error Correction Mode)** Detects errors during fax transmission and resends the pages of the fax that had an error.

- Extension phone** A telephone on the fax number that is plugged into a separate wall jack.
- External phone** A TAD (telephone answering device) or telephone that is plugged into the EXT jack of your MFC.
- F/T Ring Time** The length of time that the Brother MFC rings (when the Receive Mode setting is Fax/Tel) to notify you to pick up a voice call that it answered.
- Fax Activity Report** Lists information about the last 200 incoming and outgoing faxes. TX means Transmit. RX means Receive.
- Fax Forwarding** Sends a fax received into the memory to another preprogrammed fax number.
- Fax Receive Code** Press this code ( \* 51 ) when you answer a fax call from an extension or external phone to transfer the call to the MFC.
- Fax Storage** You can print stored faxes later, or retrieve them from another location using Fax Forwarding, Paging, or Remote Retrieval operations.
- Fax/Tel** You can receive faxes and telephone calls. Do not use this mode if you are using a telephone answering device (TAD).
- Fax tones** The signals sent by sending and receiving fax machines while communicating information.
- Fine resolution** Resolution is 203×196 dpi. It is used for small print and graphs.
- Gray scale** The shades of gray available for copying and faxing photographs.
- Group number** A combination of One-Touch, Speed-Dial numbers that are stored as a Speed-Dial number for Broadcasting.
- Help list** A printout of the complete Menu that you can use to program your MFC when you do not have the User's Guide with you.
- Interval** The preprogrammed time period between automatically printed Activity Reports. You can print Activity Reports on demand without interrupting this cycle.
- LCD (liquid crystal display)** The display screen on the MFC that shows interactive messages during On-Screen Programming and shows the date and time when the MFC is idle.

**Manual fax** When you lift the handset of your external telephone or press **Hook** so you can hear the receiving fax machine answer before you press **Start** to begin transmission.

**Menu mode** Programming mode for changing your MFC's settings.

**MFL-Pro Suite** Turns your MFC into a printer and a scanner and enables PC faxing using the MFC.

**OCR (optical character recognition)** The bundled ScanSoft® TextBridge® software application converts an image of text to text you can edit.

**One-Touch** Keys on the MFC control panel where you can store numbers for easy dialing. You can store a second number on each key if you press **Shift** and the One-Touch key together.

**Out of Paper Reception** Receives faxes into the MFC's memory when the machine is out of paper.

**Overseas Mode** Makes temporary changes to the fax tones to accommodate noise and static on overseas phone lines.

**Paging** This feature enables your MFC to call your pager when a fax is received into its memory.

**Pause** Allows you to place a 3.5 second delay in the dialing sequence stored on Speed-Dial numbers. Press **Pause** as many times as needed for longer pauses.

**Photo resolution** A resolution setting that uses varying shades of gray for the best representation of photographs.

**Polling** The process of a fax machine calling another fax machine to retrieve waiting fax messages.

**Pulse** A form of rotary dialing on a telephone line.

**Real Time Transmission** When memory is full, you can send faxes in real time.

**Remaining jobs** You can check which jobs are waiting in memory and cancel jobs individually.

**Remote Retrieval Access** The ability to access your MFC remotely from a touch tone phone.

- Remote Access Code** Your own four-digit code that allows you to call and access your MFC from a remote location.
- Resolution** The number of vertical and horizontal lines per inch. See: Standard, Fine, Super Fine and Photo.
- Ring Delay** The number of rings before the MFC answers in FAX mode.
- Ring Volume** Volume setting for the MFC's ring.
- Scanning** The process of sending an electronic image of a paper document into your computer.
- Search** An electronic, alphabetical listing of stored One-Touch, Speed-Dial and Group numbers.
- Speed-Dial** A preprogrammed number for easy dialing. You must press the **Search/Speed Dial** key and then #, and the three digit code to start the dialing process.
- Standard resolution** 203 x 97 dpi. It is used for regular size text and quickest transmission.
- Station ID** The stored information that appears on the top of faxed pages. It includes the sender's name and fax number.
- Super fine resolution** 203 x 391 dpi. Best for very small print and line art.
- TAD (telephone answering device)** You can connect an external TAD to the EXT. jack of the MFC.
- Telephone Answer Code (Fax/Tel mode)** When the MFC answers a voice call, it pseudo/double-rings. You can pick up at an extension phone by pressing this code (**#51**).
- Temporary Settings** You can select certain options for each fax transmission and copy without changing the default settings.
- Tone** A form of dialing on the telephone line used for Touch Tone telephones.
- Toner cartridge** An accessory that holds toner for the drum unit on Brother laser models.
- Toner Save** A process that causes less toner to be affixed to the page to extend the life of the toner assembly. This will make the receiving document significantly lighter.

**Transmission** The process of sending faxes over the phone lines from your MFC to the receiving fax machine.

**Transmission Verification Report** A listing for each transmission, that shows its date, time and number.

**True Type fonts** The fonts that are used in the Windows® operating systems. If you install the Brother True Type fonts, more types of fonts will be available for Windows® applications.

**User Settings** A printed report that shows the current settings of your MFC.



# S Specifications

## Product description

The MFC-8420, MFC-8820D and MFC-8820DN are **5 in 1** Multi-Function Centers: Printer, Copier, Color Scanner, Fax, and PC Fax (via your PC). The MFC-8820D includes Duplex Printing. The MFC-8820DN includes Duplex Printing and Network capability.

## General

|                                        |                                                                                                                                                                                                    |
|----------------------------------------|----------------------------------------------------------------------------------------------------------------------------------------------------------------------------------------------------|
| <b>Memory Capacity</b>                 | 32 MB                                                                                                                                                                                              |
| <b>Optional Memory</b>                 | 1 DIMM slot; Memory expandable up to 160 MB                                                                                                                                                        |
| <b>Automatic Document Feeder (ADF)</b> | Up to 50 pages<br>Temperature: 68°F - 86°F (20°C - 30°C)<br>Humidity: 50% - 70%<br>Paper: 75 g/m <sup>2</sup> or 20 lb Letter size                                                                 |
| <b>Paper Tray</b>                      | 250 Sheets (20 lb)                                                                                                                                                                                 |
| <b>Multi-Purpose Tray</b>              | 50 Sheets (20 lb) (MFC-8820D, MFC-8820DN only)                                                                                                                                                     |
| <b>Manual Feed Tray</b>                | Single sheet (20 lb) (MFC-8420 only)                                                                                                                                                               |
| <b>Printer Type</b>                    | Laser                                                                                                                                                                                              |
| <b>Print Method</b>                    | Electrophotography by semiconductor laser beam scanning                                                                                                                                            |
| <b>LCD (Liquid Crystal Display)</b>    | 22 characters × 5 lines                                                                                                                                                                            |
| <b>Warm-up</b>                         | Max. 18 seconds at 73.4°F (23°C)                                                                                                                                                                   |
| <b>Power Source</b>                    | 120V AC 50/60Hz (USA, Canadian Version Only)                                                                                                                                                       |
| <b>Power Consumption</b>               | Average Operating (Copying): 440 W or less (25°C)<br>Peak: 1090 W or less<br>Sleep: 14 W or less<br>16 W or less (When Network LAN board (NC-9100h) is installed.)<br>Standby: 75 W or less (25°C) |
| <b>Dimensions</b>                      | 21.28 x 17.76 x 18.76 (in.)<br>532 × 444 × 469 (mm)                                                                                                                                                |
| <b>Weight</b>                          | Without Drum/Toner Unit:<br>MFC-8420: 36.6 lb/16.6 kg<br>MFC-8820D/MFC-8820DN: 39.9 lb/18.1 kg                                                                                                     |
| <b>Noise</b>                           | Operating: 53 dB A or less<br>Standby: 30 dB A or less                                                                                                                                             |

# General (continued)

|                    |                                                                                          |
|--------------------|------------------------------------------------------------------------------------------|
| <b>Temperature</b> | Operating: 50 - 90.5°F (10 - 32.5°C)<br>Storage: 32 - 104°F (0 - 40°C)                   |
| <b>Humidity</b>    | Operating: 20 to 80% (without condensation)<br>Storage: 10 to 90% (without condensation) |

## Print media

### Paper Input

#### Paper Tray

- Paper type:  
Plain paper, recycled paper and transparencies, envelopes (Manual Feed/Multi-purpose Tray)
- Paper size:  
A4, Letter, Legal, B5 (ISO), B5 (JIS), Executive, A5, A6, B6 (ISO)  
Weight: 16 - 28 lb (60 - 105 g/m<sup>2</sup>) (Paper Tray)  
For more details, see *Paper specifications for each paper tray* on page 2-4.
- Maximum paper tray capacity: Approx. 250 sheets of 20 lb (80 g/m<sup>2</sup>) plain paper
- Maximum multi-purpose tray capacity: Approx. 50 sheets of 20 lb (80 g/m<sup>2</sup>) plain paper (MFC-8820D and MFC-8820DN only)

#### Manual Feed Tray/Multi-Purpose Tray

- Paper size:  
Width: 20 lb 2.75 - 8.66" (69.8- 220.0 mm)  
Height: 4.57 - 16.00" (116.0- 406.4 mm)  
Weight: 16 - 43 lb (60 - 161 g/m<sup>2</sup>)

### Paper Output

Up to 150 sheets of plain paper (Face down print delivery to the output paper support)

## Copy

|                         |                                       |
|-------------------------|---------------------------------------|
| <b>Color/Monochrome</b> | Monochrome                            |
| <b>Copy Speed</b>       | Up to 17 copies/minute (Letter paper) |
| <b>Multiple Copies</b>  | Stacks or Sorts up to 99 pages        |
| <b>Enlarge/Reduce</b>   | 25% to 400% (in increments of 1%)     |
| <b>Resolution</b>       | Max. 1200 x 600 dpi                   |

# Fax

|                               |                                                                                                                                                                                                                                                                                                  |
|-------------------------------|--------------------------------------------------------------------------------------------------------------------------------------------------------------------------------------------------------------------------------------------------------------------------------------------------|
| <b>Compatibility</b>          | ITU-T Group 3                                                                                                                                                                                                                                                                                    |
| <b>Coding System</b>          | MH/MR/MMR/JBIG                                                                                                                                                                                                                                                                                   |
| <b>Modem Speed</b>            | 33600-2400 bps<br>Automatic Fallback                                                                                                                                                                                                                                                             |
| <b>Original Size</b>          | ADF Width: 5.8" to 8.5" (148 mm to 216 mm)<br>ADF Height: 5.8" to 14.0" (148 mm to 356 mm)<br>Scanner Width: Max. 8.48" (212 mm)<br>Scanner Height: Max. 14.0" (356 mm)                                                                                                                          |
| <b>Scanning Width</b>         | 8.2 inches (208 mm)                                                                                                                                                                                                                                                                              |
| <b>Printing Width</b>         | 8.2 inches (208 mm)                                                                                                                                                                                                                                                                              |
| <b>Gray Scale</b>             | 64 levels                                                                                                                                                                                                                                                                                        |
| <b>Polling Types</b>          | Standard, Sequential                                                                                                                                                                                                                                                                             |
| <b>Contrast Control</b>       | Automatic/Light/Dark<br>(manual setting)                                                                                                                                                                                                                                                         |
| <b>Resolution</b>             | <ul style="list-style-type: none"><li>• Horizontal 203 dot/inch (8 dot/mm)</li><li>• Vertical<ul style="list-style-type: none"><li>• Standard 98 line/inch (3.85 line/mm)</li><li>• Fine, Photo 196 line/inch (7.7 line/mm)</li><li>• Superfine 392 line/inch (15.4 line/mm)</li></ul></li></ul> |
| <b>One-Touch Dial</b>         | 40 (20 × 2)                                                                                                                                                                                                                                                                                      |
| <b>Speed-Dial</b>             | 300 stations                                                                                                                                                                                                                                                                                     |
| <b>Automatic Redial</b>       | one time                                                                                                                                                                                                                                                                                         |
| <b>Auto Answer</b>            | 0, 1, 2, 3 or 4 rings                                                                                                                                                                                                                                                                            |
| <b>Communication Source</b>   | Public switched telephone network.                                                                                                                                                                                                                                                               |
| <b>Memory Transmission</b>    | Up to 600 <sup>*1</sup> /500 <sup>*2</sup> pages                                                                                                                                                                                                                                                 |
| <b>Out of Paper Reception</b> | Up to 600 <sup>*1</sup> /500 <sup>*2</sup> pages                                                                                                                                                                                                                                                 |

\*1 "Pages" refers to the "Brother Standard Chart No. 1" (a typical business letter, Standard resolution, JBIG code). Specifications and printed materials are subject to change without prior notice.

\*2 "Pages" refers to the "ITU-T Test Chart #1" (a typical business letter, Standard resolution, JBIG code). Specifications and printed materials are subject to change without prior notice.

# Scanner

**Color/Monochrome**

Color/Monochrome

**TWAIN Compliant**

Yes (Windows® 95/98/98SE/Me/2000 Professional and Windows NT® Workstation Version 4.0)

Mac OS 8.6-9.2/OS X 10.2.1 or greater

**WIA Compliant**

Yes (Windows® XP)

**Resolution**

Up to 9,600 × 9,600 dpi (interpolated)\*

Up to 600 × 2,400 dpi (optical)

\* Maximum 1200 x 1200 dpi scanning with Windows® XP (resolution up to 9600 x 9600 dpi can be selected by using the Brother scanner utility)

**Document Size**

ADF Width: 5.8" to 8.5" (148 mm to 216 mm)

ADF Height: 5.8" to 14.0" (148 mm to 356 mm)

Scanner Glass Width: Max. 8.5" (216 mm)

Scanner Glass Height: Max. 14.0" (356 mm)

**Scanning Width**

8.35 inches (212 mm)

**Gray Scale**

256 levels



Scanning directly to a networked PC is available with Windows® 98/98SE/Me/2000 Professional and XP.



OS X scanning is supported in OS X 10.2.1 or greater.

# Printer

|                        |                                                                                                                                                                                                                                                                            |
|------------------------|----------------------------------------------------------------------------------------------------------------------------------------------------------------------------------------------------------------------------------------------------------------------------|
| <b>Emulation</b>       | PCL6 (Brother Printing System for Windows® emulation mode of HP LaserJet) and BR-Script (PostScript®) Level 3                                                                                                                                                              |
| <b>Printer Driver</b>  | Windows® 95/98/98SE/Me/2000 Professional/XP and Windows NT® Workstation Version 4.0 driver supporting Brother Native Compression mode and bi-directional capability<br>Apple® Macintosh® QuickDraw® Driver and PostScript (PPD) for OS 8.6-9.2/OS X 10.1/10.2.1 or Greater |
| <b>Resolution</b>      | HQ1200 (Max. 2400 × 600 dots/inch)                                                                                                                                                                                                                                         |
| <b>Print Quality</b>   | Normal printing mode<br>Economy printing mode (saves toner usage)                                                                                                                                                                                                          |
| <b>Print Speed</b>     | Up to 17 pages/minute letter size (when loading paper from paper tray)                                                                                                                                                                                                     |
| <b>Duplex Printing</b> | Up to 8.5 pages/minute: (MFC-8820D and MFC-8820DN only)<br>(8.5 sides per minute, 4.25 sheets per minute)                                                                                                                                                                  |
| <b>First Print</b>     | Up to 12 seconds (using letter size paper in paper tray)                                                                                                                                                                                                                   |

# Interfaces

| <b>Interface</b> | <b>Recommended Cable</b>                                                                               |
|------------------|--------------------------------------------------------------------------------------------------------|
| <b>Parallel</b>  | A bi-directional shielded parallel cable that is IEEE 1284 compliant and not longer than 6 feet (2 m). |
| <b>USB</b>       | A Hi-Speed USB 2.0 cable that is not longer than 6 feet (2 m).                                         |



Please make sure that you use a Hi-Speed USB 2.0 certified cable if your computer uses a Hi-Speed USB 2.0 interface.



Even if your computer has a USB 1.1 interface you can connect the MFC.

# Computer requirements

| Minimum System Requirements                                                                                                                                               |                                                                                                        |                                           |             |                 |                           |                                    |
|---------------------------------------------------------------------------------------------------------------------------------------------------------------------------|--------------------------------------------------------------------------------------------------------|-------------------------------------------|-------------|-----------------|---------------------------|------------------------------------|
| Computer Platform & Operating System Version                                                                                                                              |                                                                                                        | Processor Minimum Speed                   | Minimum RAM | Recommended RAM | Available Hard Disk Space |                                    |
|                                                                                                                                                                           |                                                                                                        |                                           |             |                 | Driver                    | Application Software <sup>*1</sup> |
| Windows® Operating System                                                                                                                                                 | 95, 98, 98SE                                                                                           | Pentium 75MHz                             | 24 MB       | 32 MB           | 80 MB                     | 100 MB                             |
|                                                                                                                                                                           | Me                                                                                                     | Pentium 150MHz                            | 32 MB       | 64 MB           |                           |                                    |
|                                                                                                                                                                           | NT® Workstation 4.0                                                                                    | Pentium 75MHz                             |             |                 |                           |                                    |
|                                                                                                                                                                           | 2000 Professional                                                                                      | Pentium 133MHz                            | 64 MB       | 128 MB          |                           |                                    |
|                                                                                                                                                                           | XP                                                                                                     | Pentium 233MHz                            |             |                 | 180 MB                    |                                    |
| Apple® Macintosh® Operating System                                                                                                                                        | OS 8.6 - 9.2 (Printing, Scanning and PC-FAX Send Only)                                                 | All base models meet minimum Requirements | 32 MB       | 64 MB           | 50 MB                     | 200 MB                             |
|                                                                                                                                                                           | Mac OS X 10.1/10.2.1 or greater (Printing, Scanning <sup>*2</sup> , PC-FAX Send and Remote Setup Only) |                                           | 128 MB      | 160 MB          |                           |                                    |
| <b>NOTE:</b> USB is not supported under Windows® 95 or Windows NT® WS 4.0.<br>All registered trademarks referenced herein are the property of their respective companies. |                                                                                                        |                                           |             |                 |                           |                                    |
| For the latest drivers, go to the Brother Solutions Center at <a href="http://solutions.brother.com/">http://solutions.brother.com/</a>                                   |                                                                                                        |                                           |             |                 |                           |                                    |



- <sup>\*1</sup> Application software is different for Windows® and Macintosh®.
- <sup>\*2</sup> Scanning is supported in 10.2.1 or greater.

# Consumable items

## **Toner Cartridge Life Expectancy**

TN-530: Standard Toner Cartridge - Up to 3,300\* pages  
TN-560: High Yield Toner Cartridge - Up to 6,500\* pages

\*(when printing letter size or A4 paper at 5% print coverage)



Toner life expectancy will vary depending upon the type of average print job.

## **Drum Unit Life Expectancy**

Up to 20,000 pages/drum unit (DR-500)



There are many factors that determine the actual drum life, such as temperature, humidity, type of paper, toner you use and number of pages per print job.

# Network (LAN) board (NC-9100h)

**MFC-8420 (Option)**

**MFC-8820D (Option)**

**MFC-8820DN (Standard)**

When you add the optional Network (LAN) Board (NC-9100h), you can connect your MFC into the network to use the Internet FAX, Network Scanner, Network Printer and Network Management software operations for small workgroups.



SMTP/POP3 E-mail Services are required for Internet Fax.

Support for:

Windows® 95/98/Me/NT® 4.0/2000/XP

Novell NetWare 3.X, 4.X, 5.X

Mac OS 8.6 - 9.2, X 10.0-10.2.1 or Greater

Ethernet 10/100 BASE-TX Auto Negotiation

TCP/IP, IPX/SPX, AppleTalk, DLC/LLC

RARP, BOOTP, DHCP, APIPA, NetBIOS, WINS

LPR/LPD, Port9100, SMTP/POP3

SMB(NetBIOS/ IP), IPP, SSDP, Rendezvous, FTP

MIBII as well as Brother private MIB

TELNET, SNMP, HTTP, TFTP

Included Utilities:

BRAdmin Professional and Web Based Management



- Scanning directly to a networked PC is not supported in Windows® 95, NT® and Mac OS.
- BRAdmin Professional is not supported in Mac OS.



# Index

The items in the upper case represent LCD messages.

## A

- access codes, storing and dialing ..... 7-7
- accessories and supplies ..... ii
- ADF (Automatic Document Feeder) ..... 6-1
- ADF cover ..... 22-4
- automatic
  - fax receive ..... 5-1
  - fax redial ..... 6-8
  - transmission ..... 6-5

## B

- Broadcasting ..... 6-16
  - setting up Groups for ..... 7-4
- Brother
  - accessories and supplies ..... ii
  - Brother numbers ..... i
  - Customer Service ..... i
  - fax back system ..... ii
  - Frequently Asked Questions (FAQs) ..... i
  - product support ..... i
  - test sheet, sending ..... 1-2
  - Warranties ..... iii, iv, vi
- Brother Control Center
  - using and configuring ..... 14-1

## C

- Caller ID ..... 5-14, 5-15
- canceling
  - fax forwarding ..... 8-6
  - fax jobs in memory ..... 6-11
  - jobs awaiting redial ..... 6-11
  - paging ..... 8-6

- cleaning (routine maintenance)
  - drum unit ..... 22-27
  - printer ..... 22-26
  - scanner ..... 22-25
- CNG tones ..... 1-14
- Combine items into a single file
  - attachment ..... 14-11
- connecting
  - external TAD ..... 1-16
  - external telephone ..... 1-15
- control panel, overview ..... 1-7
- copy
  - contrast ..... 10-16
  - default settings, changing ..... 10-16
  - Duplex/N in 1 ..... 10-11
  - Enlarge/Reduce ..... 10-7
  - enter Copy mode ..... 10-1
  - keys ..... 10-6
  - multiple ..... 10-4
  - paper ..... 2-1
  - Quality (type of original) .. 10-8
  - scanner glass ..... 10-4
  - single ..... 10-3, 10-4
  - sort (ADF only) ..... 10-9
  - temporary settings 10-2, 10-6
  - Tray Select ..... 10-10
  - tray use ..... 4-11
  - using ADF ..... 10-3
- Cover page
  - composing ..... 6-12
- cover page
  - custom comments ..... 6-13
  - for all faxes ..... 6-15
  - for next fax only ..... 6-14
  - printed form ..... 6-15
- Credit Card Numbers ..... 7-7

custom telephone features 1-22

## D

Date and Time ..... 4-1

Delayed Batch Transmission  
..... 6-20

Delayed Fax ..... 6-19

dialing

  a pause ..... 7-8

  access codes and credit card  
  numbers ..... 7-7

  automatic fax redial ..... 6-8

  from an external phone .... 7-6

  Groups ..... 6-16

  Search ..... 7-5

  Speed Dial numbers ..... 7-6

Distinctive Ring ..... 5-1 1

drivers

  printer ..... 12-1

  TWAIN Compliant ..... 13-1

  Windows®  
  printer ..... 11-1

drum unit

  checking remaining life 22-37

  replacing ..... 22-34

Dual Access ..... 6-9

Duplex/N in 1 key ..... 10-1 1

  Duplex/1 in 1 ..... 10-13

  Duplex/2 in 1 ..... 10-15

  Duplex/4 in 1 ..... 10-15

## E

Easy Receive ..... 5-4

ECM (Error Correction Mode)  
..... 1-15

ecology

  Scanner Lamp ..... 4-10

  Sleep Time ..... 4-10

  Toner Save ..... 4-9

enter copy mode ..... 10-1

entering text ..... 4-3

envelopes ..... 2-3

error messages on LCD

  Check Paper ..... 22-1

  Comm. Error ..... 22-2

  Not Registered ..... 22-3

  Out of Memory ..... 22-3

  while scanning a document  
  ..... 10-5

extension telephone, using . 5-7

external telephone ..... 1-15

## F

fax codes

  Fax Receive Code ..... 5-7

  Remote Access Code ..... 8-4

  Telephone Answer Code . 5-7

Fax Forwarding ..... 8-1

  changing remotely ..... 8-6, 8-7

  programming a number .... 8-1

Fax Storage ..... 8-3

  printing from ..... 5-5

  turning on ..... 8-3

fax, stand-alone

  receiving ..... 5-1

  difficulty ..... 22-13

  duplex printing ..... 5-10

  forwarding ..... 8-1, 8-6

  polling ..... 1-21, 5-9

  reducing to fit on paper . 5-5

  retrieving from a remote site  
  ..... 8-7

  ring delay, setting ..... 5-2

  sending

    at end of conversation ... 6-5

    automatic transmission . 6-5

    canceling from memory  
    ..... 6-11

    contrast ..... 6-6

    delayed ..... 6-19

- from ADF ..... 6-1
- from memory (dual access) ..... 6-8
- from scanner glass ..... 6-3
- legal size from scanner glass ..... 6-4
- manual transmission ..... 6-4
- overseas ..... 6-18
- Real Time Transmission ..... 6-10
- resolution ..... 6-7
- Fax/Tel mode ..... 5-1
  - answering at extension
    - phones ..... 5-7
  - double-ringing (voice calls) ..... 5-3
  - Easy Receive ..... 5-4
  - FAX Receive Code ..... 5-8
  - receiving faxes ..... 5-7
  - Setting F/T Ring Time ..... 5-3
  - Setting Ring Delay ..... 5-2
  - Telephone Answer Code .. 5-7
- FCC notices ..... 21-1

**G**

- gray scale ..... S-3, S-4
- Groups for Broadcasting ..... 7-4

**H**

- HELP ..... 3-1
- Help List ..... 9-3

**J**

- jacks
  - convert to RJ11 jack ..... 1-19
  - EXT. jack
    - external telephone ..... 1-15
    - TAD (answering machine) ..... 1-16
  - triplex adapter ..... 1-19

- jams
  - original ..... 22-4
  - paper ..... 22-4

**L**

- LAN Configuration ... 3-11, 3-15
- LCD (Liquid Crystal Display) ..... 1-7, 3-1
- LCD Contrast ..... 4-12

**M**

- maintenance, routine ..... 22-25
- manual
  - receive ..... 5-1
  - transmission ..... 6-4
- manual feed tray ..... 11-5, 11-7
- Memory Security ..... 6-22, 6-23
- Memory Storage ..... 3-1
- Menu table ..... 3-1
- multi-line connections (PBX) ..... 1-22
- multi-purpose tray (MP tray) 2-1

**O**

- OCR, changing setting .... 15-11
- One Touch numbers
  - storing ..... 7-1
- OUT OF AREA ..... 5-14

**P**

- Page Counter ..... 22-37
- Paging ..... 8-1, 8-2
- programming your pager
  - number ..... 8-1
- Paper ..... 2-1, S-2
- capacity ..... 2-3
- jam ..... 22-4
- Size ..... 4-6
- size of original ..... 6-1

- PaperPort®
    - accessing ..... 13-2
    - exporting ..... 13-23
    - importing ..... 13-22
  - PC FAX (For Windows®) .. 17-1
    - receiving ..... 17-18
    - sending
      - address book ..... 17-7
      - cover page ..... 17-13
      - facsimile style ..... 17-15
      - group ..... 17-9
      - setting up ..... 17-13
      - simple style ..... 17-16
  - phone line
    - connections ..... 1-18
    - difficulties ..... 22-13
    - multi-line (PBX) ..... 1-22
    - roll-over lines ..... 1-19
    - two-line phone system ... 1-19
  - Polling
    - receiving ..... 5-9
    - sequential receiving ..... 5-10
  - power
    - failure ..... 3-1
  - print
    - area ..... 10-1
    - difficulty ..... 22-13
    - driver ..... 12-1
    - emulation
      - Windows®
        - ..... 11-1, 11-17, 12-17
      - Emulation Selection ..... 11-17
      - envelopes ..... 11-11
      - fax from memory ..... 5-5
      - improving the print quality
        - ..... 22-18
      - jams ..... 22-6, 22-11
      - manual feed tray ..... 11-5
      - multi-purpose tray ..... 11-6
      - on thick paper ..... 11-7
      - reports and lists ..... 11-18
      - resolution ..... S-5
      - Secure key ..... 11-16
      - specifications ..... S-5
      - two-sided (duplex printing)
        - ..... 11-3
      - print media ..... 2-1
      - printer driver ..... 12-17
      - PS printer driver ..... 12-17
- Q**
- Quality key (copying) ..... 10-6
- R**
- Receive mode
    - External TAD ..... 5-1
    - Fax Only ..... 5-1
    - Fax/Tel ..... 5-1
    - Manual ..... 5-1
  - Redial/Pause ..... 6-8
  - reducing
    - copies ..... 10-7
    - long faxes ..... 5-5
  - Remote Retrieval ..... 8-5
    - access code ..... 8-4, 8-5
    - changing settings ..... 8-4
    - commands ..... 8-6
    - getting your faxes ..... 8-7
  - Reports ..... 9-1
    - Transmission Verification . 9-1
  - resolution
    - fax (standard, Fine, superFine, Photo) ..... S-3
    - print ..... S-5
    - Scan ..... 13-6, S-4
    - setting for next fax ..... 6-7
  - Ring Delay, setting ..... 5-2

## S

- Safety Instructions .....vii, 21-6
- Scanner Lamp .....4-10
- Scanner Lock .....22-22
- Scanning into PC ..... 13-3
  - ScanSoft® PaperPort® .. 13-19
  - Scansoft® TextBridge® OCR  
..... 13-22
- Search, for stored numbers 7-5
- Setup
  - Date and Time .....4-1
  - Station ID (fax header) ..... 4-2
- shipping the machine ..... 22-22
- software
  - Brother Control Center ... 14-1
  - ScanSoft® Paper Port®  
..... 13-19
- Speed Dial ..... 1-7
  - dialing ..... 7-6
  - storing ..... 7-1

## T

- TAD (Telephone Answering  
Device), external  
..... 1-16, 1-21, 5-1
  - connecting ..... 1-15
  - Receive Mode .....5-1
- Temporary Copy Settings . 10-6
- text, entering ..... 4-3
  - Special Characters ..... 4-4
- To change the default setting of  
the scan, click on the Scan  
Settings tab ..... 15-9
- Tone signals on Pulse line .. 7-8
- toner cartridge
  - replacing ..... 22-28, 22-29
- tray use, setting
  - copy .....4-11
  - fax .....4-12
- troubleshooting .....22-1

- error messages on LCD .22-1
- if you are having difficulty
  - incoming calls .....22-14
  - paper handling .....22-16
  - phone line difficulties .22-13
  - printer difficulties .....22-15
  - printing or receiving faxes  
.....22-13
- two-line phone system ..... 1-19

## V

- Volume, setting .....4-8
  - beeper .....4-8
  - ring .....4-8
  - speaker .....4-9

## W

- Warranties ..... ii
  - Canada ..... vi
  - Notice-Disclaimer ..... iii
  - USA ..... iv
- World Wide Web .....i

# Remote Retrieval Access card

If you plan to receive fax messages while away from your MFC, carrying the Remote Retrieval Access Card printed below will serve as a convenient reminder of the retrieval procedures. Simply cut out the card and fold it to fit your wallet or organizer. Keeping it handy will help you derive the full benefit of your MFC's Forwarding, Paging and Remote Retrieval features.

**REMOTE RETRIEVAL ACCESS CARD**

---

**CHECK RECEIVING STATUS**  
Press **971**  
1 long beep — Fax messages  
3 short beeps — No messages

**CHANGE RECEIVE MODE**  
Press **98**  
then for External TAD, press 1.  
Fax/Tel, press 2.  
Fax Only, press 3.

**EXIT REMOTE OPERATION**  
Press **90**.

**Using Remote Access Code**

- 1 Dial your fax number from a telephone or fax machine using touch tone.
- 2 When your MFC answers, immediately enter your Remote Access Code (3 digits followed by \*).
- 3 Your MFC signals the kinds of messages it received:  
1 long beep — Fax messages  
No beeps — No messages.
- 4 After 2 short beeps, enter a command.
- 5 Press **90** to reset your MFC when you finish.
- 6 Hang up.

**REMOTE RETRIEVAL ACCESS CARD**

### Changing Remote Access Code

When you are at the machine:

- 1 Press **Menu 2, 5, 3.**
- 2 Enter a three-digit number from 000 to 999.  
The \* cannot be changed.
- 3 Press **Set.**
- 4 Press **Stop.**

### Remote Commands

#### CHANGE PAGING/FAX FORWARDING SETTING

- Press **95.**  
*then to*  
Turn feature **Off**, press **1.**  
Select Fax Forwarding, press **2.**  
Select Paging, press **3.**

Fold ←

**Program Fax Forwarding Number**, press **4.** Enter the new fax number where you want your fax messages forwarded followed by **##.**

- Turn Fax Storage **On**, press **6.**  
Turn Fax Storage **Off**, press **7.**

### RETRIEVE A FAX

- Press **96.**  
*then to*  
Retrieve all faxes, press **2.**  
then enter the number of remote fax machine followed by **##.**  
After the beep, hang up and wait.  
Erase all fax messages, press **3.**

← Fold

## **EQUIPMENT ATTACHMENT LIMITATIONS (Canada only)**

### **NOTICE**

This product meets the applicable Industry Canada technical specifications.

### **NOTICE**

The Ringer Equivalence Number is an indication of the maximum number of devices allowed to be connected to a telephone interface. The termination on an interface may consist of any combination of devices subject only to the requirement that the sum of the RENs of all the devices does not exceed five.





Brother International Corporation  
100 Somerset Corporate Boulevard  
P.O. Box 6911  
Bridgewater, NJ 08807-0911 USA

Brother International Corporation (Canada) Ltd.  
1 rue Hôtel de Ville,  
Dollard-des-Ormeaux, QC, CANADA H9B 3H6

**Visit us on the World Wide Web**  
**<http://www.brother.com>**

These machines are made for use in the USA and CANADA only. We cannot recommend using them overseas because it may violate the Telecommunications Regulations of that country and the power requirements of your multi-function center may not be compatible with the power available in foreign countries. **Using USA or CANADA models overseas is at your own risk and may void your warranty.**

## Free Manuals Download Website

<http://myh66.com>

<http://usermanuals.us>

<http://www.somanuals.com>

<http://www.4manuals.cc>

<http://www.manual-lib.com>

<http://www.404manual.com>

<http://www.luxmanual.com>

<http://aubethermostatmanual.com>

Golf course search by state

<http://golfingnear.com>

Email search by domain

<http://emailbydomain.com>

Auto manuals search

<http://auto.somanuals.com>

TV manuals search

<http://tv.somanuals.com>