

OWNER'S
MANUAL

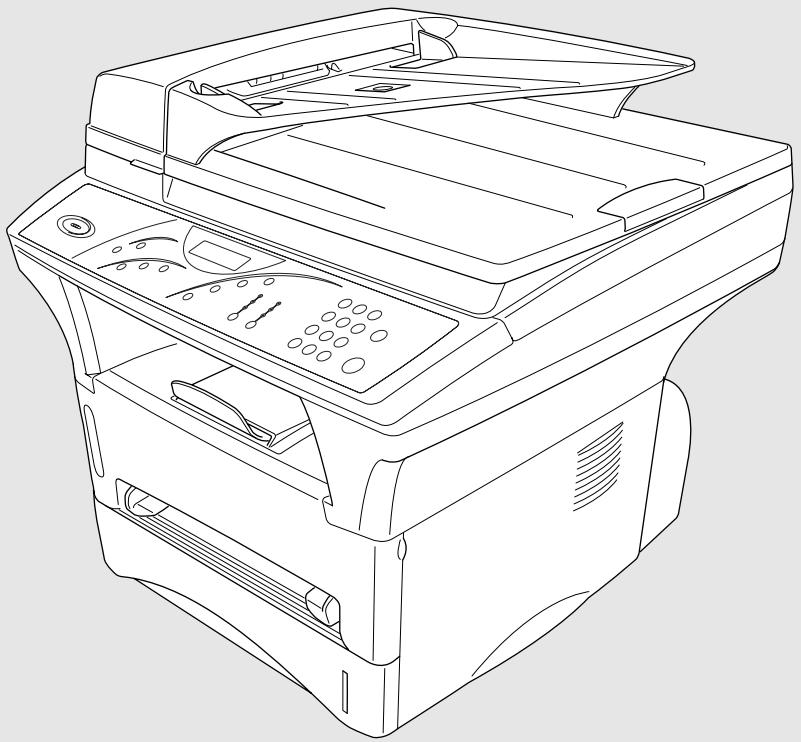

DCP-1400

.....

brother

Brother Numbers

IMPORTANT

For technical and operational assistance, you must call the country where you purchased the DCP. Calls must be made *from within* that country.

Brother fax-back system

Brother Customer Service has installed an easy-to-use fax-back system, so you can get instant answers to common technical questions and product information for all Brother products. This system is available 24 hours a day, 7 days a week. You can use the system to send faxes to any fax machine.

If you can't resolve a difficulty with your Brother DCP using this manual, call our fax-back system, and follow the voice prompts to receive faxed instructions about using the system and an index of fax-back subjects.

In USA: 1-800-521-2846

In Canada: 1-800-681-9838
1-514-685-5381 **In Montreal**

Frequently Asked Questions (FAQs)

The Brother Solutions Center is our one-step resource for all your Digital Copier/Printer needs. You can download the latest software and utilities, read FAQs and troubleshooting tips, and go to the 'Solutions' section to learn how to get the most from your Brother product.

<http://solutions.brother.com>



You can check here for Brother Printer Driver updates.

For Customer Service

In USA: 1-800-284-4329 (voice)
1-908-575-8790 (fax)
1-800-284-3238 (TTY service for the hearing-impaired)

In Canada: 1-800-853-6660 (voice)
1-514-685-4898 (fax)
1-514-685-6464 (voice) **In Montreal**

Dealers/Service Centers (USA Only)

For the name of a Brother authorized dealer or service center, call 1-800-284-4357.

Service Centers (Canada Only)

For service center address in Canada, call 1-800-853-6660.

Ordering Accessories and Supplies

IMPORTANT

For technical and operational assistance, you must call the country where you purchased the DCP. Calls must be made *from within* that country.

For best quality results use only genuine Brother accessories, available at most Brother retailers. If you cannot find the accessory you need and you have a Visa, MasterCard, Discover or American Express credit card, you can order accessories directly from Brother. (In the USA, you can visit us online for a complete selection of Brother accessories and supplies available for purchase.)

In USA: 1-888-879-3232 (voice)
1-800-947-1445 (fax)
<http://www.brothermall.com>

Description	Item
Toner	TN-430 (Able to print 3000 pages) TN-460 (Able to print 6000 pages)
Drum	DR-400
IEEE-1284 Bi-directional Cable	F2A046-10
Paper Cassette #2 (Option)	LT-400
Owner's Manual	LE7096001

Product Registration (For USA Only)

To Complete Your DCP-1400 Registration On-Line:

- 1 Insert the MFL Pro Suite CD-ROM into your CD-ROM drive.
- 2 Click **On-Line Registration** to register your product from the main menu.

Notice – Disclaimer of Warranties (For USA and Canada)

BROTHER'S LICENSOR(S), AND THEIR DIRECTORS, OFFICERS, EMPLOYEES OR AGENTS (COLLECTIVELY BROTHER'S LICENSOR) MAKE NO WARRANTIES, EXPRESS OR IMPLIED, INCLUDING WITHOUT LIMITATION THE IMPLIED WARRANTIES OF MERCHANTABILITY AND FITNESS FOR A PARTICULAR PURPOSE, REGARDING THE SOFTWARE. BROTHER'S LICENSOR(S) DOES NOT WARRANT, GUARANTEE OR MAKE ANY REPRESENTATIONS REGARDING THE USE OR THE RESULTS OF THE USE OF THE SOFTWARE IN TERMS OF ITS CORRECTNESS, ACCURACY, RELIABILITY, CURRENTNESS OR OTHERWISE. THE ENTIRE RISK AS TO THE RESULTS AND PERFORMANCE OF THE SOFTWARE IS ASSUMED BY YOU. THE EXCLUSION OF IMPLIED WARRANTIES IS NOT PERMITTED BY SOME STATES IN THE USA AND SOME PROVINCES IN CANADA. THE ABOVE EXCLUSION MAY NOT APPLY TO YOU.

IN NO EVENT WILL BROTHER'S LICENSOR(S) BE LIABLE TO YOU FOR ANY CONSEQUENTIAL, INCIDENTAL OR INDIRECT DAMAGES (INCLUDING DAMAGES FOR LOSS OF BUSINESS PROFITS, BUSINESS INTERRUPTION, LOSS OF BUSINESS INFORMATION, AND THE LIKE) ARISING OUT OF THE USE OR INABILITY TO USE THE SOFTWARE EVEN IF BROTHER'S LICENSOR HAS BEEN ADVISED OF THE POSSIBILITY OF SUCH DAMAGES. BECAUSE SOME STATES IN THE USA AND SOME PROVINCES IN CANADA DO NOT ALLOW THE EXCLUSION OR LIMITATION OF LIABILITY FOR CONSEQUENTIAL OR INCIDENTAL DAMAGES, THE ABOVE LIMITATIONS MAY NOT APPLY TO YOU. IN ANY EVENT BROTHER'S LICENSOR'S LIABILITY TO YOU FOR ACTUAL DAMAGES FROM ANY CAUSE WHATSOEVER, AND REGARDLESS OF THE FORM OF THE ACTION (WHETHER IN CONTRACT, TORT (INCLUDING NEGLIGENCE), PRODUCT LIABILITY OR OTHERWISE), WILL BE LIMITED TO \$50.

Compilation and Publication Notice

Under the supervision of Brother Industries Ltd., this manual has been compiled and published, covering the latest product descriptions and specifications.

The contents of this manual and the specifications of this product are subject to change without notice.

Brother reserves the right to make changes without notice in the specifications and materials contained herein and shall not be responsible for any damages (including consequential) caused by reliance on the materials presented, including but not limited to typographical and other errors relating to the publication.

BROTHER THREE YEAR LIMITED HARDWARE WARRANTY and EXCHANGE SERVICE FOR DCP-1400 (For USA Only)

This warranty gives you certain rights and you may also have other rights that may vary from state to state.

This warranty is given only to the first end-user purchaser of the accompanying product (referred to in this warranty as "this Product").

What is covered: Brother warrants to you for the Warranty Period that there are no defects in the materials, workmanship or Year 2000 compliance of this Product. The "Warranty Period" is 3 years from the date of purchase and provides for: repair or replacement, at your option, during the first two years; and repair only during the third year. The "Warranty Period" for consumable items, such as Toner, Drums, Print Heads, Ink Cartridges, etc. is 90 days from the date of purchase, or the rated life of the Consumable item, whichever is shorter.

What is NOT covered: This warranty is VOID — that is, this Product has no warranty — if: (1) you did not purchase this Product from an authorized Brother reseller within the United States, (2) this Product has been serviced, modified or tampered with by anyone other than an Authorized Service Representative of Brother, (3) the serial number has been modified, defaced or removed from this Product, (4) this Product has been abused or damaged, or, the recommended monthly volume has been exceeded, (5) non Brother®-brand or non Brother approved parts, supplies, power supplies or other accessories have been used with this Product, or (6) this Product has been transported without the proper preparation and packaging.

What to do if you think your Product is defective: Call our Customer Service Hotline at 1-800-284-4329, or if you suspect a defect in materials or workmanship in this Product, you can report it to a Brother Authorized Service Center. During the Warranty Period, supply Brother's representative with a copy of your dated bill of sale showing that this Product was purchased within the United States. For the name of your Brother Authorized Service Center, call 1-800-521-2846. After contacting the Brother Authorized Service Center, you may be required to deliver or send the Product properly packaged, freight prepaid, to the Authorized Service Center together with a photocopy of your bill of sale.

What Brother will do: Brother (or its Authorized Service Center) will evaluate your report of a possible defect to determine whether a defect exists, and if it does exist, Brother (or its Authorized Service Center) will repair or (at Brother's option) replace the Product with a product that performs the same functions and performs as well as the original Product. Brother reserves the right to supply refurbished or remanufactured replacement parts provided that the replacement parts conform to the manufacturer's specifications for new products. The repaired or replacement product will be returned to you at no cost.

Exchange Service: When an exchange is authorized, Brother will exchange your non-working product with a refurbished or remanufactured product that conforms to the manufacturer's specifications for new products. The refurbished or remanufactured Product you receive will be covered by the balance of the limited warranty period remaining on the original Product, plus an additional thirty (30) days. You will keep the replacement Product that is sent to you and must return (or be billed up to the cost of a new product) your original non-working product, which shall become the property of Brother. You must call Brother Customer Service and if the representative cannot correct the product's malfunction over the telephone and you elect the exchange service, you must provide information pertaining to this Product and you must also provide a valid major credit card number. Your credit card will be charged up to the cost of a new Product if: (i) you do not return your original Product to Brother within five (5) business days; (ii) the malfunctions of your original Product are not covered by the limited warranty; (iii) the proper packaging instructions are not followed and has caused damage to the product; or (iv) the warranty period on your original Product has expired or has not been sufficiently validated with a copy of the proof of purchase (bill of sale). The Brother Customer Service Representative will ship the exchange Product via next business day delivery courier service, with return instructions and prepaid return air bill. Follow the return instructions. You must return the original Product in the same shipping carton in which the exchanged Product was received and include a copy of proof of purchase (bill of sale). Retain your original accessory items and a copy of the return air bill, signed by the courier.

**BROTHER THREE YEAR LIMITED HARDWARE WARRANTY
and EXCHANGE SERVICE FOR DCP-1400
(For USA Only)**

Limitations: Repair or replacement as described above is your sole and exclusive (that is, your only) remedy if this Product is defective. Brother is not responsible for damage to or loss of any equipment, media, programs or data related to the use of this Product. Except for that repair or replacement, *Brother shall not be liable for any direct, indirect, incidental or consequential damages or specific relief. Because some states do not allow the exclusion or limitation of consequential or incidental damages, the above limitation may not apply to you.*

THIS WARRANTY IS GIVEN IN LIEU OF ALL OTHER WARRANTIES, WRITTEN OR ORAL, WHETHER EXPRESSED BY AFFIRMATION, PROMISE, DESCRIPTION, DRAWING, MODEL OR SAMPLE. ANY AND ALL WARRANTIES OTHER THAN THIS ONE, WHETHER EXPRESS OR IMPLIED, INCLUDING IMPLIED WARRANTIES OF MERCHANTABILITY AND FITNESS FOR A PARTICULAR PURPOSE, ARE HEREBY DISCLAIMED.

This Limited Warranty is the only warranty that Brother is giving for this Product. It is the *final expression and the exclusive and only statement* of Brother's obligations to you. It replaces all other agreements and understandings that you may have with Brother or its representatives. This Limited Warranty (and Brother's obligation to you) may not be changed in any way unless you and Brother sign the same piece of paper in which we (1) refer to this Product and your bill of sale date, (2) describe the change to this warranty and (3) agree to make that change.

Product Support: Toll-free customer service and technical support is available for hardware operational assistance at 1-800-284-4329. At any time, free technical support in the form of Frequently Asked Questions, troubleshooting tips and service center locator is available through our fax-back system at 1-800-521-2846 or Brother's Internet Web Site (www.brother.com). Now you can visit us on-line at (www.brothermall.com), your complete source for genuine Brother Accessories and Supplies.

**BROTHER INTERNATIONAL CORPORATION
100 SOMERSET CORPORATE BLVD.
BRIDGEWATER, NEW JERSEY 08807-0911**

Please record your model and serial number and your date and location of Purchase below for your records. Keep this information with your proof of purchase (bill of sale) in case your Product is lost, stolen or requires service.

Model # _____

Serial # _____

Date of purchase: _____

Store where purchased: _____

Location of store: _____

Important: We recommend that you keep all original packing materials, in the event that you ship this product.

BROTHER MULTIFUNCTION CENTER/FACSIMILE MACHINE LIMITED WARRANTY (For Canada Only)

Pursuant to this limited warranty of 1 year from the date of purchase for labour and parts, Brother International Corporation (Canada) Ltd. ("Brother"), or its Authorized Service Centers, will repair this DCP/Facsimile machine free of charge if defective in material or workmanship. This Limited Warranty does not include cleaning, consumables (including, without limitation, print cartridges, print head, toner and drum) or damage caused by accident, neglect, misuse or improper installation or operation, any damage caused from service, maintenance, modifications, or tampering by anyone other than a Brother Authorized Service Representative, or from the use of supplies or consumable items that are non-Brother products. Operation of the DCP/Facsimile machine in excess of the specifications or with the Serial Number or Rating Label removed shall be deemed abuse and all repairs thereafter shall be the sole liability of the end-user/purchaser. In order to obtain warranty service, the DCP/Facsimile machine must be delivered or shipped freight prepaid by the end user/purchaser to a "Brother" Authorized Service Center, together with your Proof of Purchase in the form of a Sales Receipt.

For laser products: Failure to remove the Toner Cartridge (and Toner Drum Unit on applicable models) during shipping will cause severe damage to the DCP/Facsimile and will VOID the Warranty. (Refer to your Operation Manual for proper packaging.)

For ink-jet products: Do not remove the ink cartridges during shipping. Damage to your print head resulting from packing without the ink cartridges will VOID your warranty. (Refer to your Operation Manual for proper packaging.)

BROTHER DISCLAIMS ALL OTHER WARRANTIES EXPRESSED OR IMPLIED INCLUDING, WITHOUT LIMITATION, ANY IMPLIED WARRANTIES OF MERCHANTABILITY OR FITNESS FOR A PARTICULAR PURPOSE, EXCEPT TO THE EXTENT THAT ANY WARRANTIES IMPLIED BY LAW CANNOT BE VALIDLY WAIVED.

No oral or written information, advice or representation provided by Brother, its Authorized Service Centers, Distributors, Dealers, Agents or employees, shall create another warranty or modify this warranty. This warranty states Brother's entire liability and your exclusive remedy against Brother for any failure of the DCP/Facsimile machine to operate properly.

Neither Brother nor anyone else involved in the development, production, or delivery of this DCP/Facsimile machine shall be liable for any indirect, incidental, special, consequential, exemplary, or punitive damages, including lost profits, arising from the use of or inability to use the product, even if advised by the end user/purchaser of the possibility of such damages. Since some Provinces do not allow the above limitation of liability, such limitation may not apply to you.

This Limited Warranty gives you specific legal rights and you may also have other rights which vary from Province to Province.

Warranty Service is available at Brother Authorized Service Centers throughout Canada. For Technical Support or for the name and location of your nearest Authorized Service Center call 1-877-BROTHER. Within Montreal, please call (514) 685-6464. Internet support: support@brother.ca or browse Brother's Web Site: www.brother.com

Brother International Corporation (Canada) Ltd.
1 Rue Hôtel de Ville
Dollard-Des-Ormeaux, QC H9B 3H6

At your side.
The Brother logo consists of the word "brother" in a bold, lowercase, sans-serif font. A registered trademark symbol (®) is located to the right of the word.

Table of Contents

1

Getting to Know Your Digital Copier/Printer	1-1
Using This Manual	1-1
Finding Information.....	1-1
Conventions Used in This Manual	1-1
DCP-1400 Control Panel Overview	1-2
Inserting Originals for Copying	1-4
Using the ADF (Automatic Document Feeder).....	1-4
Using the Scanner Glass	1-5

2

Assembly and Connections.....	2-1
Packing List.....	2-1
Choosing a Location.....	2-2
Important Safety Instructions	2-3
Release the Scanner Lock.....	2-3
Assembly.....	2-4
Installing the Drum Unit Assembly (with Toner Cartridge)	2-4
Paper.....	2-5
Acceptable Paper	2-5
Paper Capacity of Paper Cassette	2-5
Paper Specifications for the Cassette	2-5
Manual Feed Slot.....	2-6
Loading Paper in the Paper Cassette	2-6
Manual Feed Slot.....	2-7
Connecting the DCP.....	2-8

3

On-Screen Programming	3-1
User-Friendly Programming	3-1
Menu Mode	3-1
Menu Selection Table.....	3-2
Key Operations Table.....	3-4

4

Custom Settings.....	4-1
Initial Setup	4-1
Setting Paper Size	4-1
Setting the Beeper Volume.....	4-1
Turning on Cassette #2 (Option)	4-1

Setting Cassette Usage	4-2
Setting the Print Density	4-2
Toner Save.....	4-2
Sleep Mode	4-3

5

Making Copies.....	5-1
Basic Copy Operations.....	5-1
Making a Single Copy (Using the ADF).....	5-1
Making Multiple Copies (Using the ADF).....	5-1
Single or Multiple Copies (Using the Scanner Glass).....	5-2
Out of Memory Message	5-2
Temporary Copy Settings.....	5-3
Copying Using Multiple Settings	5-3
Using Enlarge/Reduce Key	5-4
Sorting Multiple Copies (Using the ADF)	5-5
Using the Options Key	5-5
Paper Size.....	5-6
Paper Type	5-6
Contrast.....	5-6
Copy Mode (Type of Original).....	5-7
Special Layouts (Using the ADF)	5-7
Special Layouts (Using the Scanner Glass).....	5-7
2 in 1	5-8
4 in 1	5-8
Poster.....	5-8
Changing Default Copy Settings.....	5-9
Copy Mode (Type of Original).....	5-9
Copy Contrast.....	5-10
Paper Type.....	5-10

6

For DOS Users.....	6-1
How to Use the Brother DCP with Your DOS Application	
Software	6-1
What Does the Remote Printer Console Do?	6-1
Remote Printer Console Main Program	6-1
Installing the Remote Printer Console.....	6-2
Using the Remote Printer Console Main Program	6-3
Remote Printer Console.....	6-4
Current Printer Status Information.....	6-4
Printer Setup Category	6-4
Print Setup Section.....	6-4

Page Setup Section.....	6-5
Font Configuration.....	6-5
Other Configuration	6-6
Console Configuration Category	6-6

7

Using the Brother DCP as a Printer	7-1
Special Printing Features.....	7-1
Windows® Printing.....	7-1
Popular Printer Emulation Support	7-1
Remote Printer Console Program for DOS	7-1
Bi-directional Parallel Interface	7-1
Printing From Your PC	7-2
Multi-purpose Paper Cassette.....	7-2
Two-Sided Printing (Manual Duplexing).....	7-2
Front Output Bin.....	7-3
Manual Feed Slot.....	7-3
Loading One Sheet of Paper	7-4
Loading More than One Sheet of Paper.....	7-4
Printing on Thicker Paper and Card Stock	7-5
Simultaneous Operation	7-6
Choosing Acceptable Paper	7-6
Printer Operation Key	7-7
Reset Key.....	7-7
Printing the Internal Font List	7-7
Printing the Print Configuration List.....	7-7
Restoring Factory Default Settings	7-7

8

Printer Driver Settings (For Windows® Only).....	8-1
Using the Brother DCP-1400 Printer Driver.....	8-1
Features in the Printer Driver	
(For Windows® 95/98/Me and Windows NT® 4.0 Users).....	8-1
Basic Tab.....	8-2
Paper Size	8-3
Multiple Page.....	8-3
Border Line.....	8-3
Orientation	8-3
Copies	8-3
Collate.....	8-4
Media Type.....	8-4
Advanced Tab	8-5
Print Quality (*1).....	8-5

Resolution	8-5
Toner Save	8-5
Print Setting	
(For Windows® 95/98/98SE/Me Users Only).....	8-6
Duplex Printing (*2).....	8-6
Manual Duplex.....	8-6
Binding Offset.....	8-6
Watermark (*3)	8-7
Print Watermark.....	8-7
In Background.....	8-7
Watermark Text	8-8
Watermark Bitmap.....	8-8
Position	8-8
Page Setting (*4)	8-9
Device Options (*5)	8-10
Quick Print Setup	8-11
Administrator	
(For Windows® 95/98/98SE/Me Users Only).....	8-11
Print Date & Time	8-12
Accessories Tab.....	8-13
Paper Source Setting.....	8-13
Default Source	8-13
Available Options	8-13
Support	8-14
Brother Solutions Center	8-14
Web Update	8-14
Check Setting.....	8-14
Features in the Printer Driver (For Windows® 2000)	8-15
General Tab	8-15
Printing Preferences	8-15
Layout Tab.....	8-16
*1 Orientation	8-16
*2 Pages Per Sheet	8-17
Paper/Quality Tab.....	8-17
*1 Paper Source	8-17
*2 Media	8-18
Advanced Options.....	8-18
*1 Paper /Output	8-18
*2 Graphic.....	8-19
*3 Document Options	8-19
Device Settings Tab.....	8-20
Installable Options	8-20

Using the Windows®-Based Brother MFL-Pro Control Center ...	9-1
Brother Control Center	9-1
AutoLoad the Brother Control Center	9-1
How to Turn Off AutoLoad	9-2
Using the Scan Keys	9-2
Using the Control Panel Keys	9-2
Scan Image	9-3
Scan/OCR	9-3
Scan to E-mail	9-3
Brother Control Center Features	9-4
Auto Configuration	9-4
Scanning Operations	9-4
Copy Operations	9-5
Scanner Settings for Scan and Copy	9-5
Global Settings	9-5
Setting Up the Scanner Configurations	9-6
To Access the Scanner Configuration Screen:	9-6
Perform an Operation from the Control Center Screen	9-6
Scan to File	9-7
Scanner Settings	9-7
Destination Folder	9-8
Scan to E-mail	9-8
Scanner Settings	9-9
E-mail Application	9-9
File Attachments	9-9
Conversion Options	9-10
Format	9-10
Show QuickSend Menu	9-10
QuickSend List	9-10
Scan to Word Processor	9-11
Scanner Settings	9-11
Word Processor	9-12
User-Defined Button	9-13
Scanner Settings	9-13
Target Application	9-13
Copy	9-14
Scanner Settings	9-14
Copy Settings	9-14

Using ScanSoft™ PaperPort® for Brother and ScanSoft™ TextBridge® (For Windows® Only)	10-1
Using ScanSoft™ PaperPort® and TextBridge®	10-1
Viewing Items in ScanSoft™ PaperPort® for Brother	10-2
Organizing Your Items in Folders	10-2
Links to Many Other Applications	10-3
Using ScanSoft™ TextBridge® OCR	
(Converting Image Text to Text You Can Edit)	10-3
Importing Items from Other Applications	10-3
Exporting Items in Other Formats	10-4
Exporting an Image File	10-4
Accessing the Scanner	10-4
Scanning an Image into Your PC	10-5
Settings in the Scanner Window	10-5
Image	10-5
Contrast	10-6
Custom	10-6
PreScanning an Image	10-7

Using Automatic E-Mail Printing	11-1
For Windows® 95, 98, 98SE, Me Only	11-1
Main Features	11-1
To Access the On-Line Documentation	11-1
To Install Automatic E-mail Printing	
(Optional Application):	11-1

Using the Brother DCP with a New Power Macintosh®	
G3, G4 or iMac™/iBook	12-1
Set up Your USB Equipped Apple® Macintosh® G3,G4, iMac™ or iBook with	
Mac OS 8.5/8.51/8.6/9.0/9.0.4/9.1	12-1
Using Brother Printer Driver with Your Apple® Macintosh® ..	12-1
Using Brother TWAIN Scanner Driver with Your Apple®	
Macintosh®	12-3
Accessing the Scanner	12-4
Scanning a Document into Your Macintosh G3, G4 or	
iMac	12-4
Settings in the Scanner Window	12-5
Image	12-5
Scanning Area	12-5
Business Card Size	12-6

Miscellaneous	12-6
Contrast	12-6
PreScanning an Image	12-7

13

Optional Accessories	13-1
Paper Cassette #2 (Option).....	13-1

14

Troubleshooting and Routine Maintenance	14-1
Troubleshooting	14-1
Error Messages	14-1
Original Jams and Paper Jams.....	14-3
Original is Jammed in the top of the ADF Unit	14-3
Original is Jammed inside the ADF Unit	14-3
Paper Jam.....	14-4
Paper is Jammed in the Paper Cassette	14-4
Paper is Jammed near the Drum Unit	14-5
Paper is Jammed in the Fuser Unit	14-5
If You Are Having Difficulty with Your DCP	14-6
Packing and Shipping the DCP	14-11
Lock the Scanner Lock	14-11
Routine Maintenance.....	14-14
Cleaning the Scanner.....	14-14
Cleaning the Printer	14-15
Cleaning the Drum Unit	14-16
Replacing the Toner Cartridge	14-16
How to Replace the Toner Cartridge.....	14-17
Replacing the Drum Unit.....	14-19

15

Important Information	15-1
Regulations and warnings	15-1
Laser Safety	15-1
FDA Regulations	15-1
Federal Communications Commission (FCC) Declaration of Conformity (For USA Only)	15-2
Important.....	15-3
Industry Canada Compliance Statement (For Canada Only)	15-3
Important – About the Interface Cable	15-3
Warranty	15-3
International ENERGY STAR® Compliance Statement...	15-3

Important Safety Instructions	15-4
Trademarks	15-6
Glossary.....	G-1
Specifications	S-1
Product Description.....	S-1
Paper.....	S-1
Paper Specifications for the Cassette.....	S-1
Manual Feed Slot.....	S-1
Scanner	S-1
Consumable Items	S-2
Electrical and Environment.....	S-2
Printer	S-3
TrueType Fonts on CD-ROM	S-3
Computer Requirements	S-4
Parallel Interface.....	S-5
USB (Universal Serial Bus) Interface	S-5
TrueType Fonts on CD-ROM	S-5
Resident Fonts	S-6
Symbol Sets/Character Sets	S-6
Index.....	I-1

1 Getting to Know Your Digital Copier/Printer

Using This Manual





Thank you for purchasing a Brother Digital Copier Printer (DCP). This DCP has been designed to be simple to use, with LCD screen prompts to guide you through programming your DCP. However, you can use your DCP to its fullest potential by taking a few minutes to read this manual.

Finding Information

All chapter headings and subheadings are listed in the Table of Contents. You will be able to find information about a specific feature or operation by checking the Index in the back of this manual.

Conventions Used in This Manual

Throughout this manual you'll see special symbols alerting you to important information, warnings, and actions to perform. For clarification, and to help you choose the correct key presses, we've added illustrations of some of the LCD messages.

boldface	Bold typeface identifies a specific key on the DCP control panel.
<i>italics</i>	Italics typeface emphasize an important point, or refer you to related topic.
bubble dot	Bubble Dot typeface identifies the messages on the LCD of the DCP.
	Warnings detail precautions you must take to avoid possible personal injury.
	Cautions specify procedures you must follow or avoid to prevent possible damage to the DCP.
	Notes tell you the proper response for a situation that may occur.
	FYI tips provide details about how the current operation interacts with other features.
	Improper Setup alerts you to devices and procedures that are not compatible with the DCP.

DCP-1400 Control Panel Overview

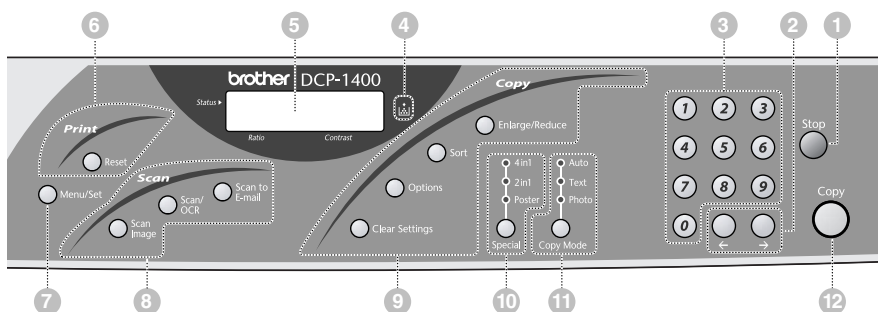

1 Stop

Press this key to cancel a copy operation. The original will be ejected.

2 ← (Left Arrow)

→ (Right Arrow)

Moves the LCD cursor through text and options.

3 Numeric Keys

Use the numeric keys to enter the number of multiple copies (99 maximum).

4 Toner Empty Icon

The Toner icon flashes on and off when toner is low, so you'll know to order another toner cartridge. You will be able to print until the indicator stays on.

5 LCD (Liquid Crystal Display)

LCD displays messages to help you set up and operate your DCP.

6 Print Key:

Reset

Clears data from the printer memory.

7 Menu/Set

Lets you access the Menu and Programming mode and stores your settings in the DCP.

8 Scan Keys:

Scan to E-mail

Press this key to start scanning an original into your E-mail application, setting it up automatically as an attachment.

Scan/OCR

Press this key to start scanning a text document. ScanSoft™ TextBridge® will convert it to editable text and display it in your word processor application for further editing.

Scan Image

Press this key to scan a color picture into your graphics application for viewing and editing.

9 **Copy Keys (Temporary Settings):**

Clear Settings

Resets your temporary copy settings back to the factory default settings. Use this key when you do not want to wait 45 seconds for the temporary settings to clear automatically.

Options

You can quickly and easily change your temporary settings for each copy.

Sort

Press this key to sort multiple copies.

Enlarge/Reduce

Lets you reduce or enlarge copies depending upon the ratio you select.

10 **Special (and Indicators)**

You can change the layout of copies on the print media. Press this key until the Special Indicator you want is lit.

4in1 — Save paper by copying four pages onto one page.

2in1 — Save paper or create a booklet by copying two pages onto one page.

Poster — This option copies a different portion of the original on each of nine sheets of print media. Tape the sheets together to get a copy that is nine times the size of the original.

11 **Copy Mode (and Indicators)**

Press to illuminate the LED that suits the type of original.

Auto — Select when the original contains both text and photographs.

Text — Select when the original contains only text.

Photo — Select when the original is a picture.

12 **Copy**

Press this key to start copying an original that is in the ADF or on the scanner glass.

Inserting Originals for Copying

You can copy from either the ADF (Automatic Document Feeder) or from the scanner glass.

Using the ADF (Automatic Document Feeder)

The automatic document feeder (ADF) can hold up to 50 pages, feeding each one individually through the machine. Use standard (20 lb/75g/m²) paper when using the ADF. Always fan the pages well and stagger them.

Temperature: 68°F – 86°F (20°C – 30°C)

Humidity: 50% – 70%

Paper: Xerox 4200 (20LB/LTR),
Xerox 4024 (24LB/LTR)

⊘ **DO NOT** use curled, wrinkled, folded, or ripped paper, or paper with staples, paper clips, paste or tape attached. **DO NOT** use cardboard, newspaper, or fabric. (To copy or scan this kind of document, see *Using the Scanner Glass*, page 1-5.)

■ Make sure originals written with ink are completely dry.

■ Originals must be from 5.8 to 8.5 inches wide, and from 5 to 14 inches long.

① Insert original **face up**, **top edge first**.

② Adjust the paper guides to fit the width of your pages.

③ Stagger multiple pages. Then place them in the ADF, until you feel the first page lightly touch the feed roller.

**Original
is Face Up
in the ADF**

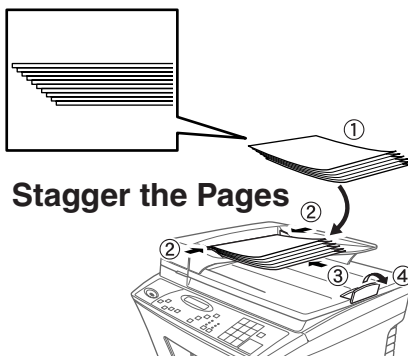
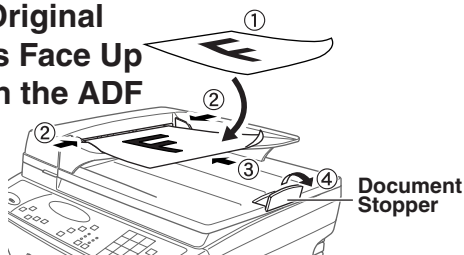

④ Pull up the document stopper.

Using the Scanner Glass

You can use the scanner glass to copy one page at a time, or pages of a book. Originals can be letter or A4 size. To use the scanner glass, the ADF must be empty. You can make multiple copies; however, if you want them sorted you must use the ADF.

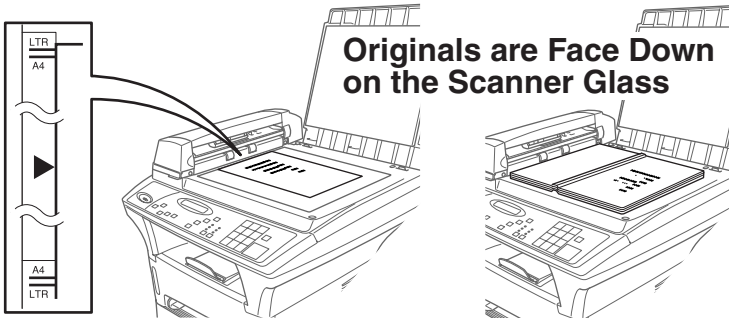

- 1 Lift the document cover.
- 2 Using the document guidelines on the left, center the original *face down* on the scanner glass.
- 3 Close the document cover.

STACK	COPIES:01
100%	■■■■□

! If the original is a book or is thick, do not slam the cover or press on it or you may damage the machine.

- 4 Press **Copy** to begin copying.
- 5 Repeat Steps 1 to 4 for each page of your original.

COPYING	P. 01
100%	■■■■□

Press **Stop** to cancel.

2

Assembly and Connections

Packing List

Make sure you have the following items:

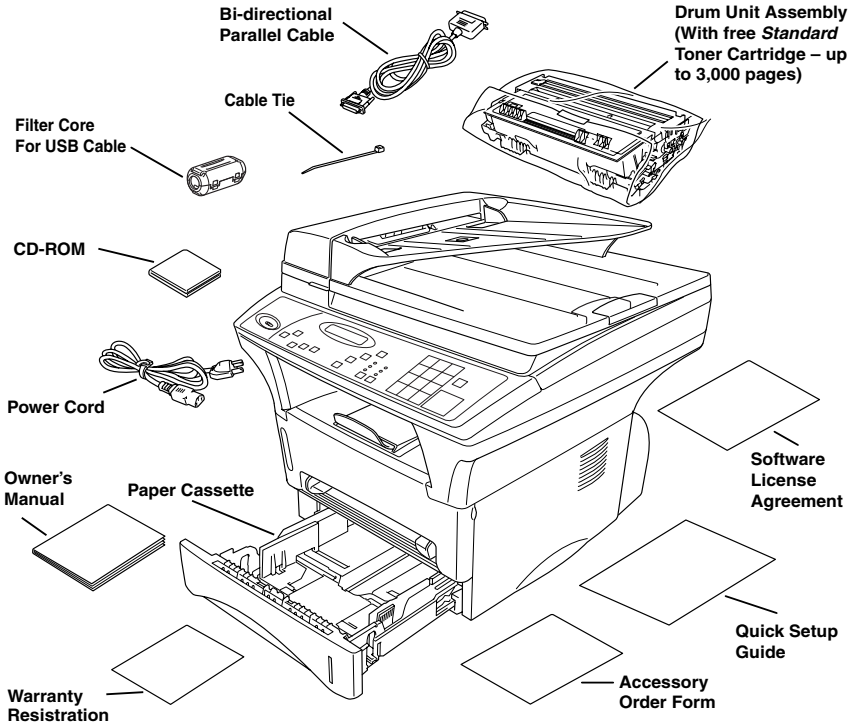

! Caution

Do NOT throw away the filter cores and cable ties by accident. You will need them to meet FCC Emission Requirements when you connect the DCP to your computer using a USB cable or a bi-directional IEEE-1284 compliant parallel cable.

Note If an item is missing, call Brother Customer Service at 1-800-284-4329 (**in USA**), 1-877-BROTHER (**in Canada**) or 1-514-685-6464 (**in Montreal**). See *Ordering Accessories and Supplies*, page ii for the correct item numbers.

! Whenever you transport the DCP, use the packing materials that came with your DCP. If you do not pack the DCP correctly, you may void your warranty.

Choosing a Location

Place your DCP on a flat stable surface, such as a desk. Select a place that is free of vibration and shocks. Place the DCP near a standard, grounded power outlet. Choose a location where the temperature remains between 50°F and 90.5°F (10°–32.5°C).

- ⊘ Avoid placing your DCP in a high-traffic area. Do not place near heaters, air conditioners, water, chemicals, or refrigerators. Do not expose the DCP to direct sunlight, excessive heat, moisture, or dust. Do not connect your DCP to electrical outlets controlled by wall switches or automatic timers. Disruption of power can wipe out information in the DCP's memory. Do not connect your DCP to electrical outlets on the same circuit as large appliances or other equipment that might disrupt the power supply. Avoid interference sources, such as speakers or the base units of cordless phones.

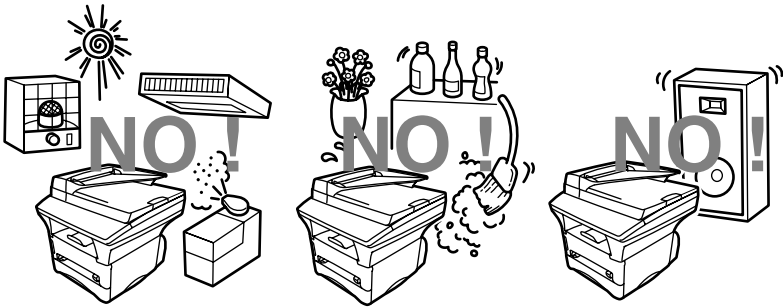

⚠ WARNING

- Lightning and power surges can damage this product! We recommend that you use a quality surge protection device on the AC power line or unplug the lines during a lightning storm.
- For PLUG CABLE EQUIPMENT, the socket-outlet should be installed near the equipment and should be easily accessible.

Important Safety Instructions

When using your telephone equipment, basic safety precautions should always be followed to reduce the risk of fire, electric shock and injury to persons, including the following:

- 1 Do not use this product near appliances that use water, in a wet basement or near a swimming pool.
- 2 Avoid using a telephone during an electrical storm. There may be a remote risk of electric shock from lightning.

Release the Scanner Lock

Push the blue Scanner Lock Lever up to unlock the scanner. This lever is located on the rear left underside of the scanner cover.

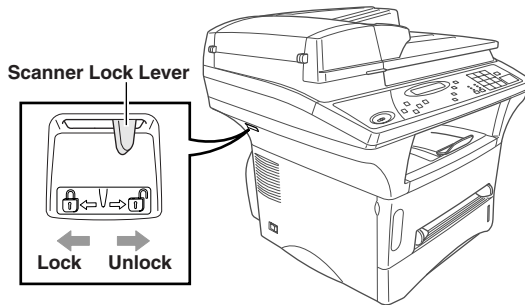

! Caution

If the message **CHECK SCAN LOCK** appears on the LCD, unlock the scanner immediately, and then press **Stop**.

Assembly

Installing the Drum Unit Assembly (with Toner Cartridge)

- 1 Unpack the drum unit assembly including the toner cartridge, and gently rock it from side to side five or six times to distribute the toner evenly inside the cartridge.

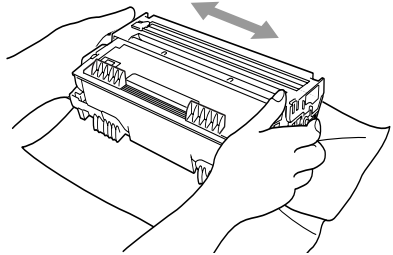

! To prevent damage to the drum, do not expose it to light for longer than a few minutes.

- 2 Open the front cover of the DCP.

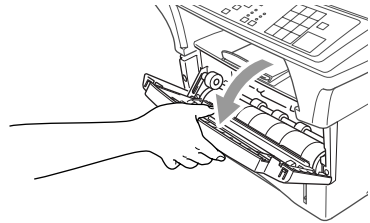

- 3 Insert the drum unit assembly into the DCP.

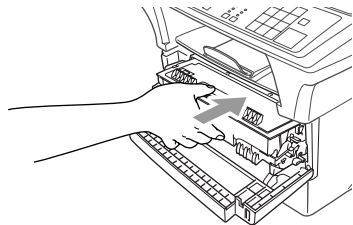

- 4 Close the front cover.

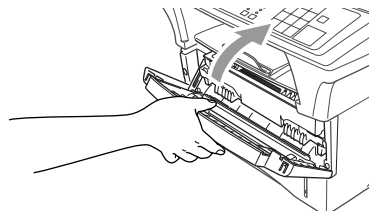

Paper

Acceptable Paper

Paper Type	Paper Size
Paper Cassette #1: cut sheet	Letter, Legal, A4, A5, ISO B5, Executive, A6, ISO B6
Manual Feed cut sheet Slot:	Letter, Legal, A4, A5, B5 (JIS/ISO), Executive, A6, B6 (JIS/ISO) 2.75–8.5 × 4.57–14 inches (70–216 × 116–356 mm)
envelopes	COM-10, Monarch, C5, DL
post cards	—
labels and transparencies	Letter, A4



We Recommend:

Cut sheet:	Xerox 4200DP 20 lb, Champion Paper One 20 lb, Hammermill Laser Paper 24 lb
Labels:	Avery <i>laser</i> label #5160
Transparencies:	3M CG3300 for <i>laser</i> printers or equivalent

Paper Capacity of Paper Cassette

Paper Cassette #1:	Max. paper height is 1.06 inches (27 mm) (use the guides) or approx. 250 sheets of 20 lb. (75 g/m ²) Letter/A4 paper, 10 transparencies.
Front Output Bin:	Approx. 150 sheets of 20 lb. (75 g/m ²) Letter/A4 paper

Paper Specifications for the Cassette

	Cut Sheet
Basis Weight:	16 to 28 lb. (60 to 105 g/m ²)
Caliper:	0.003 to 0.005 inches. (0.08 to 0.13 mm)
Moisture Content:	4% to 6% by weight

Manual Feed Slot

	Cut Sheet	Envelopes
Basis Weight:	16 to 43 lb. (60 to 161 g/m ²)	20 to 24 lb. (75 to 90 g/m ²)
Caliper:	0.003 to 0.008 inches. (0.08 to 0.2 mm)	0.003 to 0.005 inches. (0.084 to 0.14 mm)
Moisture Content:	4% to 6% by weight	4% to 6% by weight

Loading Paper in the Paper Cassette

- 1 Pull the paper cassette completely out of the DCP.

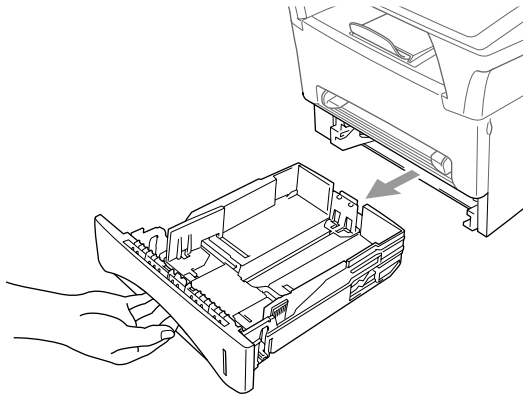

- 2 Slide the paper width and length adjusters to the position for the paper size you are using.

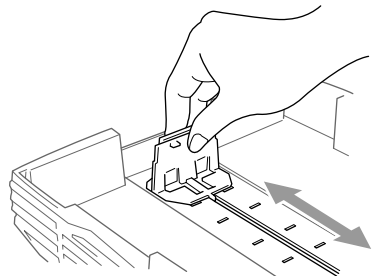
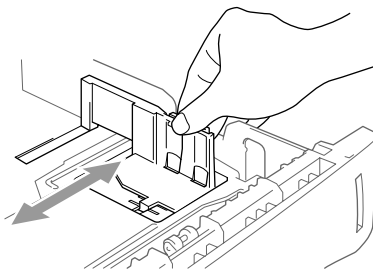

- 3 Fan the paper well. Load paper in the paper cassette. Press down on the paper to flatten it in all four corners, keeping the paper level below the guide. The cassette can hold up to 250 sheets of 20 lb (75g/m²) paper.

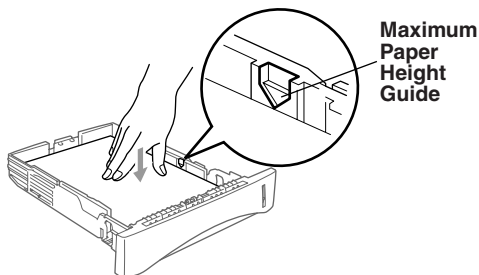

- 4 Slide the paper cassette into the DCP until it locks into place.

Manual Feed Slot

Use the manual feed slot to print or copy on envelopes, labels, transparencies, card stock or thicker paper:

The manual feed slot is above the paper cassette. Load paper or envelopes *one at a time*. You do not have to remove paper from the paper cassette.

You do not have to choose Manual Feed in the Setup dialog box of your printer driver. Insert the sheet of paper for Portrait (vertical) or Landscape (horizontal), with the side you wish to print on face up in the manual feed slot.

- 1 Align the paper at the center of the manual feed slot and insert the paper into the manual feed slot until the front edge of the paper touches the paper feed roller.
- 2 Adjust the paper guides to the width of the paper.

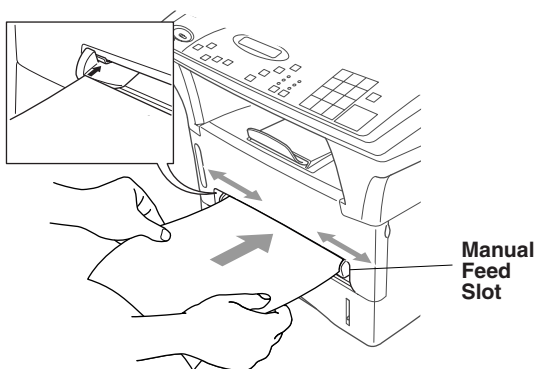

Connecting the DCP

1 Connect the power cord.

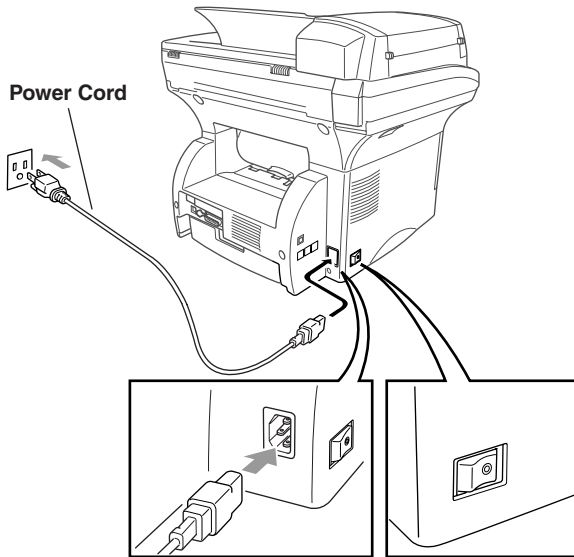

⚠ WARNING

- The DCP must be grounded using a 3-prong plug.
- Lightning and power surges can damage this product! We recommend that you use a quality surge protection device on the AC power line or unplug the lines during a lightning storm.
- Do not touch the rollers at the paper exit.

3 On-Screen Programming

User-Friendly Programming

We have designed your Multi-Function Center with on-screen programming. User-friendly programming helps you take full advantage of all the menu selections your DCP has to offer.

Since your programming is done on the LCD, we created step-by-step on-screen prompts to help you program your DCP. All you need to do is follow the prompts as they guide you through the menu selections and programming options.

Menu Mode

You can access the Menu mode by pressing **Menu/Set**. The LCD shows:

Then

Press **1** for General Setup—**OR**—

1. GENERAL SETUP



Press **2** for Copy Operations—**OR**—

2. COPY

Press **3** for Printer Operations—**OR**—

3. PRINTER

When you enter Menu mode, your DCP scrolls a list of Main menu options from which you can choose. These menu options appear one after the other on the LCD. Select a menu by pressing **Menu/Set** when that option appears on the LCD. The LCD will scroll the options within that next menu.

You can scroll more quickly through options by pressing . Use  to scroll backward if you passed your choice or to see options in the opposite order. When the LCD shows your selection, press **Menu/Set**.



When you finish a setting, the LCD shows **ACCEPTED**.

If you want to exit the Menu mode, press **Stop**.

Menu Selection Table

You can probably perform most of these programming settings without the Owner's Manual. To help you understand the menu selections, options and settings that are found in the DCP programs, use the Menu Selection Table below to change the *default* settings.

Main Menu	Menu Selections	Options	Descriptions	Page
1. GENERAL SETUP	1. PAPER SIZE	LETTER LEGAL A4	Selects size of paper for received faxes.	4-1
	2. BEEPER	OFF LOW HIGH	Adjusts beeper volume.	4-1
	3. CASSETTE #2	ON OFF	Turn CASSETTE #2 ON if you purchased the optional Cassette #2.	4-1
	4. PRINT DENSITY	- ■ ■ ■ □ □ +	Makes prints darker or lighter.	4-2
	5. TONER SAVE	ON OFF	Increases life of toner cartridge.	4-2
	6. SLEEP MODE	00-99 min. 05 min.	Conserves power	4-3
	0. LOCAL LANGUAGE (Canada Only)	ENGLISH FRENCH	Allows you to change the LCD Language to French.	See French Manual
2. COPY	1. COPY MODE	AUTO TEXT PHOTO	Selects the Copy resolution for your type of original.	5-9
	2. CONTRAST	- ■ ■ ■ □ □ +	Adjusts the contrast.	5-10
	3. PAPER TYPE	THIN PLAIN THICK THICKER	Identify the type of paper in the multi-purpose sheet feeder.	5-10



The factory setting (option) is shown in bold.

Main Menu	Menu Selections	Options	Descriptions	Page
3. PRINTER	1. PRINT OPTIONS	1. INTERNAL FONT	You can print resident fonts to check and confirm font types.	7-7
		2. CONFIGURATION	Printer settings and status are listed here.	7-7
	2. RESET PRINTER	—	You can restore the printer back to the factory default settings.	7-7





The factory setting (option) is shown in bold.

Paper Size		
Sub Menu	Options	Factory Setting
1. Cassette #1	LETTER/LEGAL/A4	LETTER
2. Cassette #2	LETTER/LEGAL/A4	LETTER
3. CASSETTE USAGE	CASSETTE#1 ONLY CASSETTE#2 ONLY AUTO	AUTO

Key Operations Table

You can use the keys on the control panel to conveniently choose *temporary* copy settings and access the scanning operations. The Key Operations Table below will help you understand the options they provide.

Press the temporary key repeatedly until you see the option you want, and then press **Menu/Set** to select it. For the **Options** key, press  or  to scroll through the next level of options, and then select the one you want by pressing **Menu/Set** again.

Temporary keys	Options		Descriptions	Page
Reset	—		Clear data from the printer memory.	7-7
Scan Image	—		Scan an image into your graphics application (such as a color picture) for viewing and editing.	9-3
Scan/OCR	—		Scan a text document so ScanSoft® will perform OCR in TextBridge® to convert it to editable text and display it in your word processing application.	9-3
Scan to E-mail	—		Scan a black & white or color original into your E-mail application as a file attachment.	9-3
Clear Settings	—		Reset your temporary copy settings back to the user default settings.	5-3
Options	OPT:PAPER SIZE	LETTER LEGAL A4 EXECUTIVE A5 B5 A6 B6	Select the size of paper.	5-6
	OPT:PAPER TYPE	THIN PLAIN THICK THICKER TRANSPARENCY	Identify the type of paper in the multi-purpose sheet feeder.	5-6
	OPT:CONTRAST	- ■ ■ ■ □ □ +	Adjust the contrast.	5-6
Sort	STACK SORT		Sort multiple copies.	5-5
Enlarge/Reduce	104% EXE>LTR, 150%, 200%, 400%, ZOOM, 25%, 50%, 78% LGL>LTR, 94% A4>LTR, AUTO, 100%		Enlarge or reduce the size of copies.	5-4
Special	4 IN 1, 2 IN 1, POSTER		Change the layout of copies on the print media.	5-7
Copy Mode	AUTO TEXT PHOTO		Select the Copy resolution for your type of original.	5-9



The factory setting (option) is shown in bold.

4 Custom Settings

Initial Setup

Setting Paper Size

You can use three sizes of paper for printing your copies: letter, legal and A4. When you change the size of paper you have loaded in the DCP, you will need to change the setting for the paper size.

After you connect the optional Cassette #2, you can select the paper size.

- 1 Press **Menu/Set, 1, 1.**

1. PAPER SIZE

- 2 If you have the Cassette #2, press or to select **CASSETTE #1** or **CASSETTE #2**, and then press **Menu/Set.**

2. CASSETTE #2

- 3 Press or to select **LETTER, LEGAL** or **A4** (for the cassette you selected in Step 2), and then press **Menu/Set.**
- 4 Press **Stop.**

Setting the Beeper Volume

You can set the beeper to **LOW, HIGH** or **OFF**. The default setting is **LOW**. When the beeper is set to **LOW** or **HIGH**, the DCP beeps every time you press a key or make an error.

- 1 Press **Menu, 1, 2.**

2. BEEPER

- 2 Press or to select your option.
- 3 When the LCD shows the option you want, press **Menu/Set.**
- 4 Press **Stop.**

Turning on Cassette #2 (Option)

When the optional **CASSETTE #2** is set to **ON**, you can set paper size and the cassette usage. (See *Setting Paper Size*, above.)

- 1 Press **Menu/Set, 1, 3.**

3. CASSETTE #2

- 2 Use or to select **ON** (or **OFF**), and then press **Menu/Set.**
- 3 Press **Stop.**

Setting Cassette Usage

The default setting of **AUTO** allows your DCP to choose the optional Cassette #2 if paper is out in Cassette #1 or if incoming faxes will fit best on the paper in Cassette #2. Choose **CASSETTE#1 ONLY**, **CASSETTE#2 ONLY** or **CASSETTE USAGE** if you want to keep special paper in the other cassette and control when it is used.

- 1 Press **Menu/Set, 1, 1, 3.** 3. CASSETTE USAGE
- 2 Press **←** or **→** to select **CASSETTE USAGE**, and then press **Menu/Set.**
- 3 Press **←** or **→** to select **AUTO, CASSETTE#1 ONLY** or **CASSETTE#2 ONLY**, and then press **Menu/Set.**
- 4 Press **Stop.**

Setting the Print Density

You can adjust print density, making your printed pages darker or lighter than the original.

- 1 Press **Menu/Set, 1, 4.** 4. PRINT DENSITY
- 2 Press **←** to make print lighter, or **→** to make print darker, and then press **Menu/Set.**
- 3 Press **Stop .**

Toner Save

You can conserve toner using this feature. When you set Toner Save to **ON** print appears somewhat lighter. The default setting is **OFF**.

- 1 Press **Menu/Set, 1, 5.** 5. TONER SAVE
- 2 Press **←** or **→** to select **ON** (or **OFF**) and then press **Menu/Set.**
- 3 Press **Stop.**

Sleep Mode

Setting the Sleep Mode reduces power consumption while the DCP is idle. You can choose how long the DCP is idle (from 00 to 99 minutes) before it drops into sleep mode. The timer automatically resets itself after the DCP receives PC data or makes a copy. The default setting is 5 minutes.

1 Press **Menu/Set, 1, 6.**

A rectangular LCD display showing the text "5. SLEEP MODE" in a monospaced font.

2 Use the numeric keys to enter the length of time the DCP is idle before it drops into sleep mode (00 to 99 minutes), and then press **Menu/Set.**

3 Press **Stop.**



If you make copies frequently, make the idle time long enough so you won't always be waiting for the DCP to warm up.

5 Making Copies

Basic Copy Operations

You can use your DCP as a copier, making up to 99 copies at a time. The DCP can stack the copies or collate (sort) them.

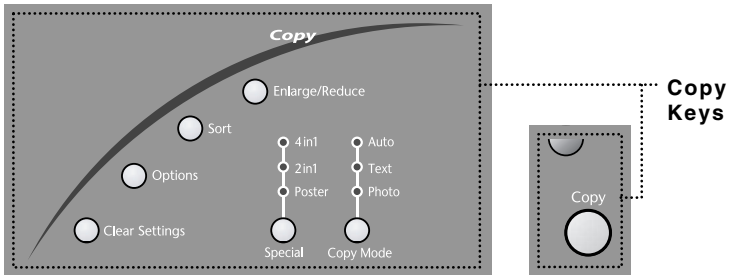

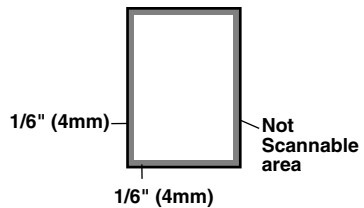

The scannable area of your DCP begins at approximately one-sixth inch (4mm) from the edge of the paper.

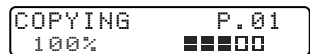

Making a Single Copy (Using the ADF)

- 1 Place the original face up in the ADF.
- 2 Press **Copy**.
Do **NOT** pull on the paper while copying is in progress.



-  To stop copying and eject the original, press **Stop**.
To release the original document, press **Stop**.

Making Multiple Copies (Using the ADF)

- 1 Insert the original *face up* in the ADF.
- 2 Use the numeric keys to enter the number of copies you want (up to 99).
- 3 Press **Copy**.

-  To sort the copies, use the **Sort** key.

Single or Multiple Copies (Using the Scanner Glass)

If you want to sort multiple copies, use the ADF. (See *Sorting Multiple Copies (Using the ADF)*, page 5-5.)

- 1 Lift the Document Cover.

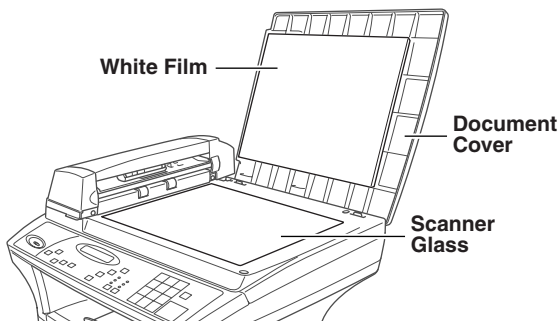

- 2 Using the document guide on the left, center the original *face down* on the scanner glass and close the Document cover.
- 3 Using the numeric keys, enter the number of copies you want (up to 99).
- 4 Press **Copy**.

Out of Memory Message

If the memory becomes full while you are making copies, the LCD shows a message:

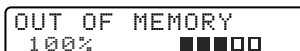

If the **OUT OF MEMORY** message appears while you are scanning the first page of your original, press **Stop** to cancel.

Temporary Copy Settings

You can improve your copies by using the Copy keys: **Enlarge/Reduce**, **Sort**, **Options**, **Clear Settings**, **Special** and **Copy Mode**. These settings are *temporary*, and the DCP returns to its default settings 45 seconds after it finishes copying. If you want to use these temporary settings again, place the next original in the ADF or on the scanner glass before the 45 seconds expire.

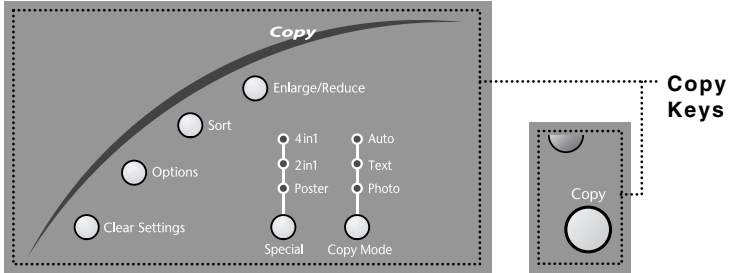

Copying Using Multiple Settings

You can try different combinations of settings for the best results.



To clear your settings and start over, press **Clear Settings**.



As you select multiple settings, the LCD displays them:

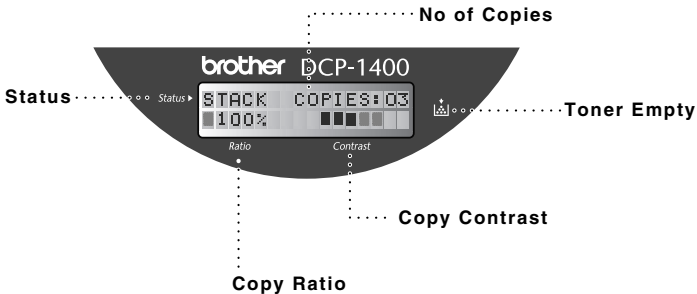

Using Enlarge/Reduce Key

AUTO sets the DCP to calculate the ratio that fits the size of your paper.

ZOOM allows you to enter a ratio from 25% to 400% in 1% increments.

Press Enlarge/Reduce and ← or →	25%
	50%
	78% LGL>LTR
	94% A4>LTR
	AUTO
	100%
	104% EXE>LTR
	150%
	200%
	400%
	ZOOM

- 1 Place the original face up in the ADF, or face down on the scanner glass.
- 2 Use the numeric keys to enter the number of copies you want (up to 99).
- 3 Press **Enlarge/Reduce**. (Enlargement or reduction ratios appear.)
- 4 Press ← or → to select **25%**, **50%**, **78%**, **94%**, **AUTO**, **100%**, **104%**, **150%**, **200%**, **400%**, or **ZOOM**, and then press **Menu/Set**. (Enlargement or reduction ratios appear.)

—OR—

For more choices select **ZOOM**, and the press **Menu/Set**. Use the numeric keys to enter any percentage between **25%** and **400%**.



Special Copy Options (2 in 1, 4 in 1 or Poster) are not available with **Enlarge/Reduce**.



Poster copies require using the scanner glass.

When selecting an enlargement or reduction ratio, you will need to know the size of the paper you registered in Menu 1-1.

Selecting a Fixed Ratio:

Original size is ...	Paper size is...	Recommended ratio is...
LETTER	LEGAL	100%
A4	LETTER	94%
LEGAL	LETTER	78%

Sorting Multiple Copies (Using the ADF)

- 1 Place the original face up in the ADF.
- 2 Use the numeric keys to enter the number of copies you want (up to 99).
- 3 Press **Sort**.
- 4 Press **Copy**.

Using the Options Key





Use the **Options** key to temporarily change the copy mode (resolution), contrast and special copy options. See the explanations below the table.

Press Options	Menu Selections	Options	Factory Setting
	OPT:PAPER SIZE	LETTER LEGAL A4 EXECUTIVE A5 B5 A6 B6	LETTER
	OPT:PAPER TYPE	THIN PLAIN THICK THICKER TRANSPARENCY	PLAIN
	OPT:CONTRAST	-□□□□□+	-■ ■ ■ □ □ +

Paper Size

Use **Paper Size** to temporarily identify the size of the paper in the multi-purpose sheet feeder.

You can select **LETTER, LEGAL, A4, EXECUTIVE, A5, B5, A6** and **B6** size paper.

- 1 Press **Options** and  or  to select **OPT:PAPER SIZE** and then press **Menu/Set**.
- 2 Press  or  to select your size of paper, and then press **Menu/Set**.



A6 size original requires using the scanner glass.







You can not select A6 size paper in Cassette #2.







Paper Type

You can use the following types of paper for copying. For the best print quality, select the type of media that you are using.

THIN (16lb - 18.4lb)	- For thin paper or transparency
PLAIN (18.7lb - 25.3lb)	- For ordinary plain paper
THICK (25.6lb - 32lb)	- For heavy weight paper or rough paper
THICKER (32.3lb - 43lb)	- For heavier weight paper, rough paper or bond paper.
TRANSPARENCY	- For Transparency (OHP)

- 1 Press **Options** and  or  to select **OPT:PAPER TYPE**, and then press **Menu/Set**.
- 2 Press  or  to select your type of paper, and then press **Menu/Set**.

Contrast

- 1 Press **Options** and  or  to select **3.CONTRAST**, and then press **Menu/Set**.
- 2 Press  or  to select the level of contrast, and then press **Menu/Set**.
- 3 Press **Copy—OR—**Press  or  for additional settings.

Copy Mode (Type of Original)

You can select the Copy Mode for your type of original. The default setting is **AUTO**, which is used for originals that contain both text and photographs.

TEXT is used for originals containing only text. **PHOTO** is used for copying photographs.

- 1 Place the original face up in the ADF, or face down on the scanner glass.
- 2 Use the numeric keys to enter the number of copies you want (up to 99).
- 3 Press **Copy Mode** continuously to choose the type of original (**AUTO**, **TEXT** or **PHOTO**).
- 4 Press **Copy**.

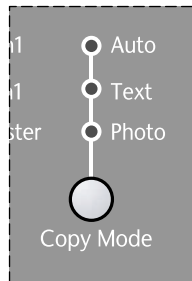

Special Layouts (Using the ADF)

You can save paper by copying either two or four pages onto one page.

- 1 Place the originals face up in the ADF.
- 2 Use the numeric keys to enter the number of copies you want (up to 99).
- 3 Press **Special** continuously to choose the type of original (**2 IN 1** or **4 IN 1**).
- 4 Press **Copy**.

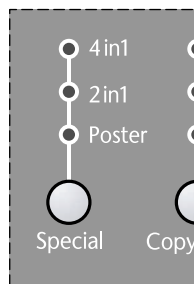

Special Layouts (Using the Scanner Glass)

You can save paper by copying either two or four pages onto one page, or you can create poster size copy.

- 1 Place the original face down on the scanner glass.
- 2 Use the numeric keys to enter the number of copies you want.
- 3 Press **Special** continuously to choose the type of original (**2 IN 1**, **4 IN 1** or **POSTER**).
- 4 Press **Copy**.



If you selected **2 IN 1** or **4 IN 1** in step 4, place the next original on the scanner glass, and then press **Menu/Set**. After all originals have been scanned, press **Copy**.

2 in 1



4 in 1

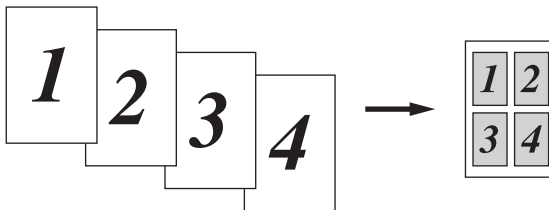

Special Layouts (2 in 1, 4 in 1 or Poster) are not available with **Enlarge/Reduce**.

Poster

You can create a poster size copy of a photograph.

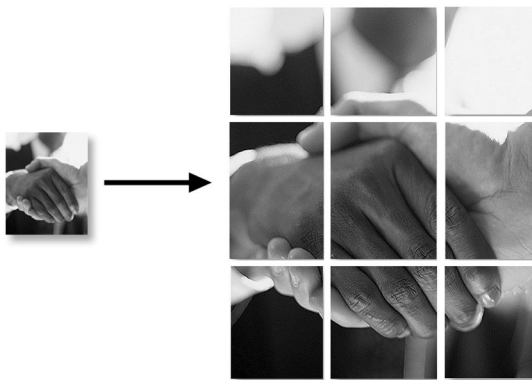

Poster is not available for multiple copies.



Poster copies require using the scanner glass.

Changing Default Copy Settings

Press **Menu/Set, 2** to change default settings for Copy mode. These settings will remain until you change them again by pressing **Menu/Set**. Adjust the Copy Mode and Contrast settings.

By pressing a number, you can adjust copy settings as shown in the following chart. Press \leftarrow or \rightarrow to scroll through the options for each setting. Press **Menu/Set** to save your selection. Press **Stop—OR—Press** \rightarrow to select the next setting you want to change.

Press **Menu/Set**, and **2**.

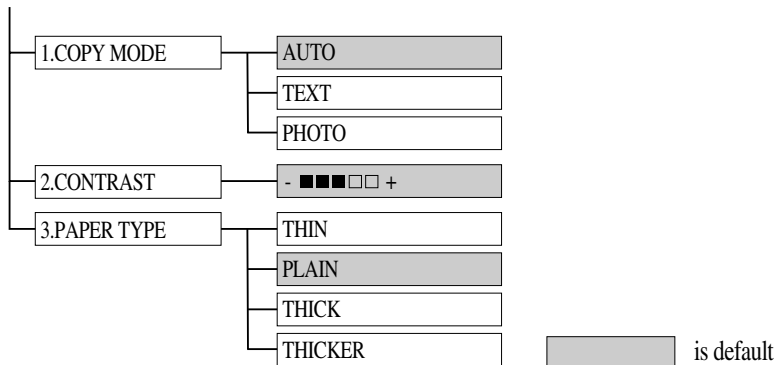

Copy Mode (Type of Original)

You can select the Copy Mode for your type of original. The default setting is **AUTO**, which is used for originals that contain both text and photographs. **TEXT** is used for originals containing only text. **PHOTO** is used for copying photographs.

- 1 Press **Menu/Set, 2, 1**.
- 2 Press \leftarrow or \rightarrow to choose the type of original (**AUTO**, **TEXT** or **PHOTO**), and then press **Menu/Set**.
- 3 Press **Stop**.



1.COPY MODE

Copy Contrast

You can adjust copy contrast to make copies darker or lighter.

- 1 Press **Menu/Set, 2, 2.**

2. CONTRAST

- 2 Press  to make a copy lighter—**OR**—
Press  to make a copy darker, and then press **Menu/Set.**
- 3 Press **Stop.**



Paper Type

You can use the following types of paper for copying. For the best print quality, select the type of media that you are most often.

- THIN** (16lb - 18.4lb) - For thin paper
- PLAIN** (18.7lb - 25.3lb) - For ordinary plain paper
- THICK** (25.6lb - 32lb) - For heavy weight paper or rough paper
- THICKER** (32.3lb - 43lb) - For heavier weight paper, rough paper or bond paper.

- 1 Press **Menu/Set, 2, 3.**

3. PAPER TYPE

- 2 Press  or  to select your type of paper, and then press **Menu/Set.**
- 3 Press **Stop.**

After you connect the optional Cassette #2, you can select the paper size for each cassette. (See page 4-1.)

6 For DOS Users

How to Use the Brother DCP with Your DOS Application Software

Before working with your application software that runs on DOS, check that the Brother DCP's name appears in the printer selection of your application software. If the DCP is not listed, you must install the printer driver that corresponds to HP LaserJet IIP's emulations.

The following table shows combinations of printer drivers and emulation mode. To get the most out of this DCP, you should install an HP printer driver in your application software.

Printer driver supported in your application software	Emulation mode to be selected with the remote printer console program
HP LaserJet IIP™	HP LaserJet IIP emulation mode
HP LaserJet II™	Auto emulation selection

- The best or recommended printer driver is indicated in bold.
- Be sure to choose the proper printer driver in your application software.
- Be sure the printing resolution is set to 300 dpi in your DOS application software.

What Does the Remote Printer Console Do?

The Remote Printer Console (RPC) is a utility program that can run in the DOS environment and comprises the following program:

Remote Printer Console Main Program

This program allows you to change various printer settings such as emulation, print quality, fonts and page setup from your computer screen. Since most DOS applications have a Printer Settings menu that overrides the settings made by the RPC, you may not have to use this utility program. This utility program is useful for application software that does not control the printer's settings and features.

Installing the Remote Printer Console

Before you install the program, make sure you have the following hardware and software to install the program:

DOS	Version 3.3 or later
Monitor	EGA/VGA or compatible
Option	Mouse; the mouse driver must be installed. (You can also operate the program with the keyboard.)

Follow these steps to install the remote printer console program:

- 1 Make sure your Brother DCP is connected to your computer and is set to Online.
- 2 Start your computer and go to the DOS prompt. If you are in Windows®, exit and return to the DOS prompt.
- 3 Insert the Brother CD-ROM into your CD-ROM drive.
- 4 At the DOS prompt (C:\>) type *x*: (Substitute the drive letter of your CD-ROM drive for “*x*”), and then press Enter.

```
C:\>x:
```

- 5 Type CD DOS, and then press Enter.

```
x:\>CD DOS
```

- 6 Type RPCSETUP, and then press Enter.

```
x:\DOS>RPCSETUP
```

- 7 Follow the instructions in the installer.

Using the Remote Printer Console Main Program

Type **C:\RPCX>RPCX**, and then press the Enter key to start the Remote Printer Console main program.

The Main Screen will appear on your computer screen as shown below.

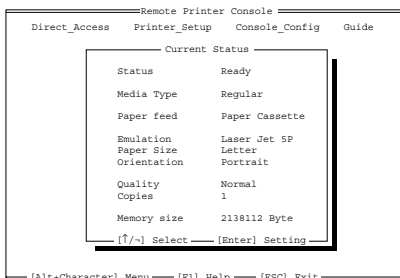

If bi-directional communication is enabled between your computer and DCP when it starts, the RPC gets the current settings information from your DCP. Otherwise, RPC shows its default settings. If you want to change settings, move the cursor to the item you want and select it using the **Enter** and **Cursor** keys. Then, press the **Enter** key to make the selected settings valid.

There are four sub menus. (See table below.) Select the sub menu you want by clicking on it with the mouse, using the cursor keys and the **Enter** key, or by pressing the hot key commands for that sub menu.

Menu	Press the keys	Functions
Direct Access	Alt + D	You can directly control the Brother DCP, with Print Form.
Printer Setup	Alt + P	You can enter the setting mode to change other printer settings, such as, margin settings, continue mode, font and sleep mode.
Console Config	Alt + C	You can change the environment settings for the RPC program: color, etc.
Guide	Alt + G	You can go to the Guide mode.
Help	F1	You can get Online Help: If you press F1, you can get information on a highlighted item.

Remote Printer Console

Current Printer Status Information

Item	Default	What This Item Does
Media Type	Regular	Selects the media type "Regular," "Thin Paper," "Thick Paper," "Thicker Paper," "Bond Paper" or "Transparency."
Paper Feed	Paper Cassette	Selects the paper feed mode, either "Paper Cassette" or "Manual."
Emulation*1	Laser Jet IIP	Selects "Laser Jet IIP."
Paper Size*1	Letter	Selects the paper size, either "Letter," "Legal," "A4," "Executive," "Monarch," "COM10," "DL," "C5," "B5," "A5," "A6," or "JIS B5."
Orientation*1	Portrait	Selects the paper direction, either "Portrait" or "Landscape."
Quality*1	Normal	Selects the print quality, either "Normal" or "Economy."
Copies*1	1	Sets the number of print copies from 1 to 999 pages.

*1 The items can be set in the current printer status information dialog box.

Printer Setup Category

Print Setup Section

Item	Default	What This Item Does
Copies	1	Sets the number of print copies from 1 to 999 pages.
Quality	Normal	Selects the print quality to either "Normal" and "Economy."
Emulation	Laser Jet IIP	Selects "Laser Jet IIP"

Page Setup Section

Item	Default	What This Item Does
Left Margin	*2	Sets the Left Margin value (0-145) columns.
Right Margin	*2	Sets the Right Margin value (10-155) columns.
Top Margin	0.5"	Sets the Top Margin 0", 0.33", 0.5", 1", 1.5" or 2".
Bottom Margin	0.5"	Sets the Bottom Margin 0", 0.33", 0.5", 1", 1.5" or 2".
Line / Page	*2	Sets the lines/pages (5-128).
Xoffset	0	Sets the Xoffset (vertical) value from 0 to 500 dots.
Yoffset	0	Sets the Yoffset (horizontal) value from 0 to 500 dots.

*1 These values (except Yoffset and Xoffset) are overridden by settings within your application software.

*2 These values depend on the paper size settings.

Font Configuration

Item	Default	What This Item Does
Font Source	Internal	"Internal"
Font name	Brougham10	Selects a font from any of the printer's internal fonts (Brougham 10, 12 and Letter Gothic 16.66).
Pitch	10	Selects the font size of the selected font. If you selected the Brougham or Letter Gothic font, Pitch is shown in the selection box.
Symbol Set	PC8	Selects the symbol set.

Other Configuration

Item	Default	What This Item Does
Auto LF	Off	Selects Auto LF “On or Off”
Auto CR	Off	Selects Auto CR “On or Off”
Auto Wrap	Off	Selects Auto Wrap “On or Off”
Auto Skip	On	Selects Auto Skip “On or Off”

Console Configuration Category

File	Function
Environment	Sets the Buzzer on/off, Color for Remote Print Console

For more information on RPC, see the Help Information in the program.

Special Printing Features

Windows® Printing

The dedicated printer driver and TrueType™ compatible fonts for Microsoft® Windows® 95/98/98SE/Me and NT® 4.0/2000 Professional are available on the CD-ROM supplied with your DCP. You can install them easily into your Windows® system using our installer program. The driver supports our unique compression mode to enhance printing speed in Windows® applications, and allows you to set various printer settings, including economy printing mode and custom paper size.

Popular Printer Emulation Support

The DCP supports HP LaserJet IIP printer emulation mode. If you use DOS application software, you can use HP LaserJet IIP emulation mode for printer operations. (Use the Remote Printer Console program to set the printer emulation.)

Remote Printer Console Program for DOS

The MFL Pro Suite CD-ROM supplied with your DCP includes the utility program Remote Printer Console (RPC). When you operate your computer in the Disk Operating System (DOS) environment, RPC lets you easily change the Brother DCP's default settings (such as fonts, page setup, emulations, etc.).

RPC also provides a status monitor Terminate-and-Stay Resident (TSR) program. It runs in the background and monitors the printer status as it reports the current status or errors on your PC screen.

Bi-directional Parallel Interface

The Brother DCP's parallel interface enables it to send memory and printer setup information to the computer.

Printing From Your PC

Multi-purpose Paper Cassette

The DCP's multi-purpose paper cassette can be adjusted to feed many sizes of paper: letter, legal, A4, A5, B5, A6, B6 and executive plain paper. When the DCP receives print data from your computer, it loads paper from the paper cassette. Insert the sheet of paper with the side you wish to print on face down in the paper cassette.

- Select the print command from your PC.

Your PC sends a print command and data to the DCP. The DCP displays the date and time and **RECEIVING DATA**. If there are more pages, the DCP begins to print the next page automatically. When printing is finished, it returns to online status.



You may select the proper paper source, paper size, and page orientation in your application software.

If your application software does not support your custom paper size, select the next larger paper size. Then adjust the print area by changing the right and left margins in your application software. (See *Acceptable Paper*, page 2-5.)



Use the manual feed slot for envelopes, labels, transparencies, card stock or thicker paper.

Two-Sided Printing (Manual Duplexing)

The supplied printer drivers for Windows® 95/98/Me and Windows NT® Workstation Version 4.0 enable manual duplex printing. (For more information, see the Help screen for the printer driver.)

The DCP prints all the even-numbered pages on one side of the paper first.

Then, the Windows® driver instructs you (with a pop-up message) to reinsert the paper.

Before reinserting the paper, straighten it well, or you may get a paper jam. Very thin or very thick paper is not recommended.

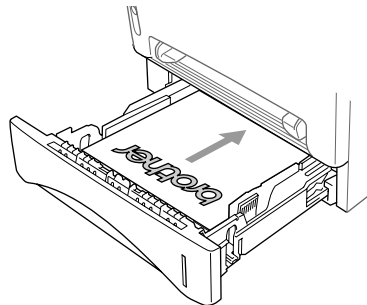

! Caution

When you use manual duplexing, it is possible that a paper jam may occur or the print quality might not be satisfactory. (See *Paper is Jammed in the Paper Cassette*, page 14-4.)

Front Output Bin

The DCP ejects paper with printed surfaces *face down* into the output bin in the front of the DCP. Unfold the output bin extension to support the printed pages.



To prevent the possibility of transparencies smudging as they stack in the output bin, remove each transparency after it exits.

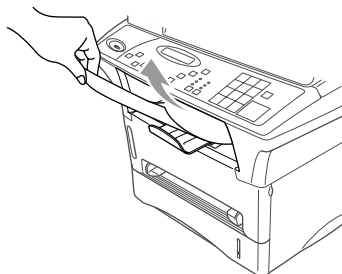

Manual Feed Slot

Your DCP has a manual feed slot above the paper cassette. You can load envelopes and special print media *one at a time* into this slot. You do not have to remove paper from the paper cassette.

(For information about *Acceptable Paper*, see page 2-5.) Insert the sheet of paper with the side you wish to print on face up in the manual feed slot.

Use the manual feed slot to print or copy on envelopes, labels, card stock or thicker paper.

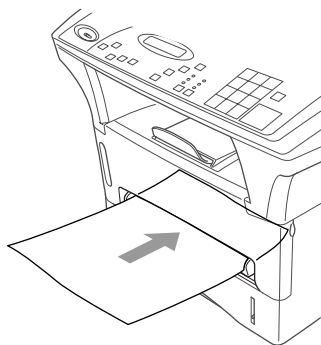

Loading One Sheet of Paper

You do not have to choose Manual Feed in the Setup dialog box of your printer driver. Insert the sheet of paper for Portrait (vertical) or Landscape (horizontal), with the side you wish to print on face up in the manual feed slot.

- 1 Align the paper at the center of the manual feed slot and insert it all the way.
- 2 Adjust the paper guides to the width of the paper.

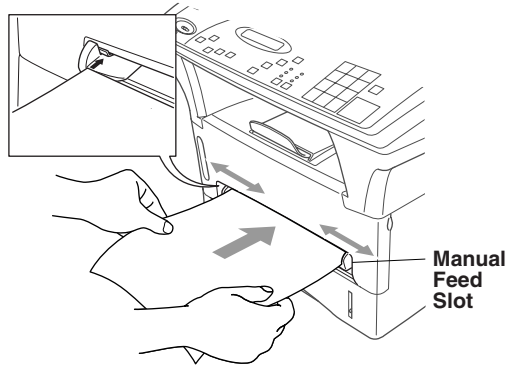

Loading More than One Sheet of Paper

- 1 Open the Setup dialog box of the Windows® printer driver and select Manual Feed in the Paper Source section. Follow Steps 1 and 2 above to load the first page. The DCP starts printing automatically.
 - 2 After the first page is printed, the LCD displays:
Insert the next sheet of paper to resume printing.
 - 3 Repeat Steps 1 and 2 until you have finished printing.
 - To stop or clear the manual feed, turn the DCP offline by pressing the **Reset** key,—OR—Stop it with a PC command.
-  If you do not select Manual Feed, and insert a page in the manual feed slot, the DCP will load the first page from the manual feed slot and subsequent pages from the paper cassette.

MANUAL FEED
INSERT PAPER

Printing on Thicker Paper and Card Stock

When the rear cover is lifted up, the DCP has a straight paper path from the manual feed slot to the rear of the printer. Use this paper feed and output method when you want to print on envelope, thicker paper or card stock.

- 1 Select manual feed mode in the printer driver.
- 2 Send the print data as usual.
- 3 Lift up the rear cover at the rear of the DCP.

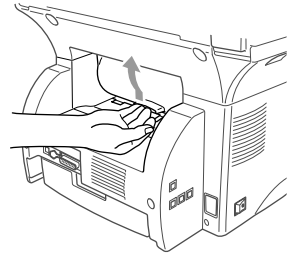

- 4 Adjust the manual feed paper guides to the width of the paper you are using.
- 5 Insert a single sheet of paper into the manual feed slot until the front edge touches the paper feed rollers. Let go of the paper as the DCP pulls it into position.
- 6 After the DCP ejects the printed page, return to Step 5 to insert the next sheet of paper. The DCP will wait until you insert the next sheet of paper. Repeat Steps 5 and 6 for each page to be printed.
- 7 When you have finished printing, close the rear cover of the DCP.



To prevent the possibility of transparencies smudging as they stack in the output bin, remove each transparency after it exits.

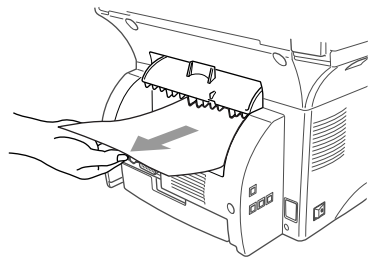

Simultaneous Operation

Your DCP can print data from your computer while scanning information into the computer. However, when the DCP is copying on paper, it pauses the PC printing operation, and resumes when copying is complete. (See *Acceptable Paper*, page 2-5.)

Choosing Acceptable Paper

We recommend that you test paper (especially special sizes and types of paper) on the DCP before purchasing large quantities.

- Avoid feeding labels with carrier sheets exposed, or your DCP will be damaged.
- Avoid using coated paper, such as vinyl coated paper.
- Avoid using preprinted or highly textured paper.

For optimum printing, use a recommend type of paper, especially plain paper and transparencies. For more information on paper specifications, consult your nearest authorized sales representative or the place where you purchased your DCP.

- Use label or transparencies that are designed for use in *laser* printers.
- For the best print quality, we recommend using long-grained paper.
- If you are using special paper, and the paper has problems feeding from the paper cassette, try again using the manual feed slot.
- You can use recycled paper in this DCP.

Printer Operation Key

Reset Key

You can clear data from the memory.

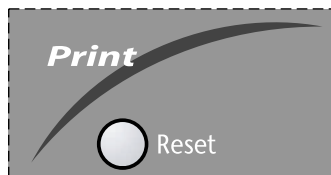

Printing the Internal Font List

You can print a list of the DCP's internal (or resident) fonts to see how each font looks before you select it.

- 1 Press **Menu/Set**, **3**, **1**, **1**.
- 2 Press **Copy**. The DCP prints the list.
- 3 Press **Stop**.

1. INTERNAL FONT

Printing the Print Configuration List

You can print a list of current printer settings.

- 1 Press **Menu/Set**, **3**, **1**, **2**.
- 2 Press **Copy**. The DCP prints the settings.
- 3 Press **Stop**.

2. CONFIGURATION

Restoring Factory Default Settings

You can return the DCP to original factory settings. Permanent fonts are restored, macros in the temporary settings are cleared. You can change user settings using the Remote Printer Console program. (See page 6-1.)

- 1 Press **Menu/Set**, **3**, **2**.
- 2 Press **1** to restore the factory settings
—OR—Press **2** to exit without making a change.
- 3 Press **Stop**.

2. RESET PRINTER

8

Printer Driver Settings (For Windows® Only)

Using the Brother DCP-1400 Printer Driver

A Printer Driver is software that translates data from the format used by a computer into the format required by a particular printer, using a printer command language or page description language.

The printer drivers are on the supplied CD-ROM. The latest printer driver can be downloaded from the Brother Solutions Center at

<http://solutions.brother.com>

Features in the Printer Driver (For Windows® 95/98/Me and Windows NT® 4.0 Users)



If you have Windows® 2000 Professional, please go to page 8-15.



The screens shown in this section are from Windows® 98. The screens on your PC may vary depending on your Windows® Operating System.

For more detailed information, please see the on-line Help in the printer driver.

You can also change settings by clicking the illustration on the left side of the tab screen.

Basic Tab

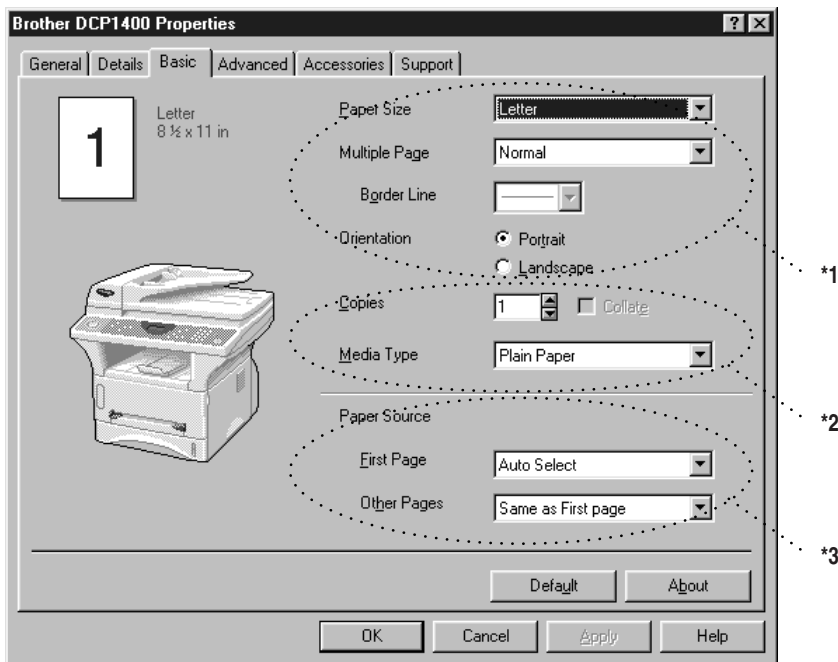

- *1 Select the Paper size, Multiple Page and Orientation.
- *2 Select number of Copies and Media Type.
- *3 Select Paper Source, First Page and Other Pages.

Paper Size

From the drop-down box select the Paper Size you are using.

Multiple Page

The Multiple Page selection can reduce the image size of a page allowing multiple pages to be printed on one sheet of paper or enlarging the image size for printing on page on multiple sheets of paper.

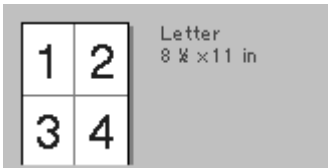

Ex. 4 in 1



Ex. 1 in 2 x 2 pages

Border Line

When printing multiple pages on one sheet with the Multiple Page feature you can select to have a solid border, dash border or no border around each page on the sheet.

Orientation

Orientation selects the position of how your document will be printed (Portrait or Landscape).

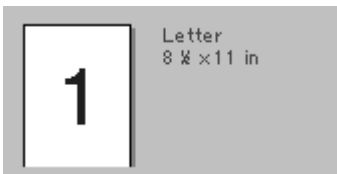

Portrait

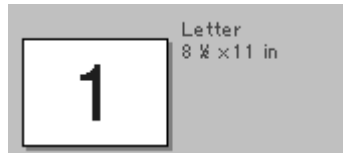

Landscape

Copies

The copies selection sets the number of copies that will be printed.

Collate

The collate selection is active if more than one copy is selected. With the collate check box selected, one complete copy of your document will be printed and then repeated for the number of copies you selected. If the collate check box is not selected then each page will be printed for all the copies selected before the next page in the document is printed.

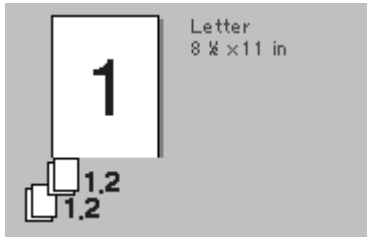

Collate box checked

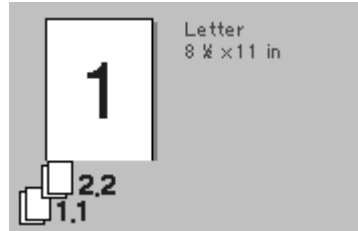

Collate box not checked

Media Type

You can use the following types of media in your printer. For the best print quality, select the type of media that you wish to use.

- **Plain Paper**
- **Thin Paper**
- **Thick Paper**
- **Thicker Paper**
- **Bond Paper**
- **Transparencies**

When using ordinary plain paper, select **Plain Paper**. When using heavier weight paper, envelopes or rough paper select **Thick Paper** or **Thicker Paper**. For bond paper, select **Bond Paper** and for OHP transparencies, select **Transparencies**.

Advanced Tab

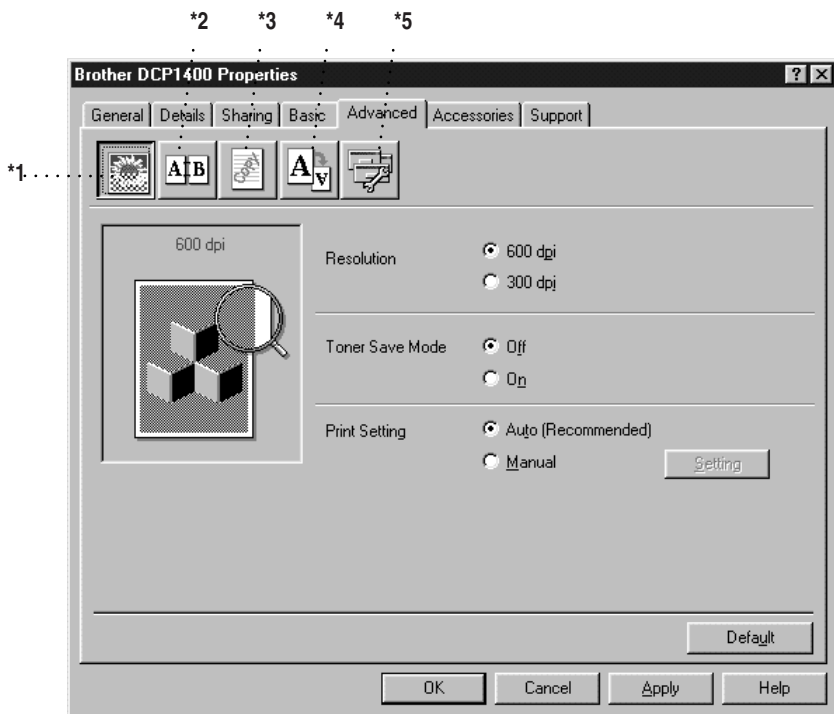

Change the tab settings by selecting one of the following icons:

- *1 Print Quality
- *2 Duplex Printing
- *3 Watermark
- *4 Page Setting
- *5 Device Option

Print Quality (*1)

Resolution

You can change the resolution as follows:

- 300 dpi
- 600 dpi

Toner Save

You can save running costs by turning on the Toner Save Mode, which reduces the print density.

Print Setting (For Windows® 95/98/98SE/Me Users Only)

Print Setting is used for optimizing your print quality for the type of document being printed (Photos, Graphics or Scanned Images). When you choose **Auto (Recommended)**, the printer automatically prints with the most suitable print settings.

With the Print Setting set to Manual, you can change the Brightness, Contrast and Graphics Quality options manually.

Duplex Printing (*2)

Choosing the Duplex Printing icon displays the Manual Duplex features available.

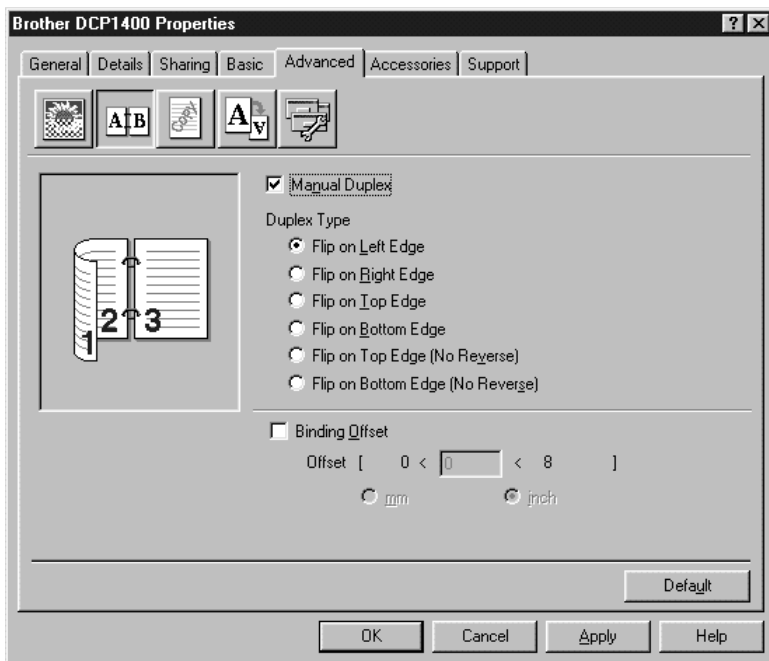

Manual Duplex

Check the Manual Duplex box and there are six types of duplex directions available for each orientation. In this mode, the DCP prints all the even numbered pages first. Then the printer driver stops and shows the instructions required to re-install the paper. When you click OK the odd numbered pages are printed.

Binding Offset

Check the Binding Offset option, you can specify the offset value of the binding side in inches or millimeters (0 - 8 inches) [0 - 203.2 mm].

Watermark (*3)

You can place a logo or text into your document as a Watermark by using a bitmap file as your source file or select one of the preset Watermarks.

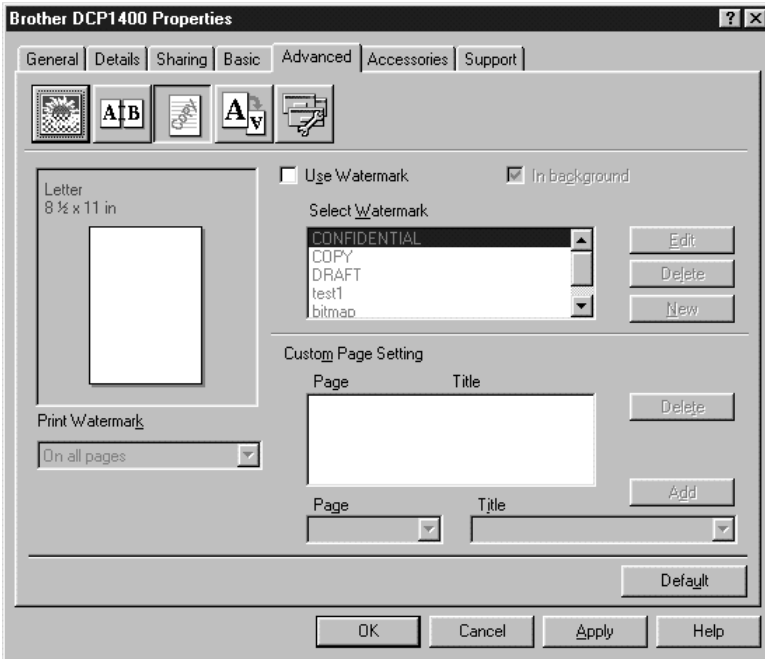

Print Watermark

The Print Watermark feature offers printing choices of:

- On all pages
- On first page only
- From second page
- Custom

In Background

With the In background feature checked the Watermark will print behind your document on the page. If this feature is not checked then the Watermark will print on top of your document.

You can change the size and the position of the Watermark on the page by selecting the Watermark and clicking the **Edit** button. If you want to add a new Watermark, click the **New** button and select Text or Bitmap from the Watermark Style.

Watermark Text

Enter your Watermark text into the Text Box and select the Font, Size, Darkness and Style.

Watermark Bitmap

Enter the file name and location of your bitmap image in the File box or Browse for the file location. You can also set the scaling size of the image.

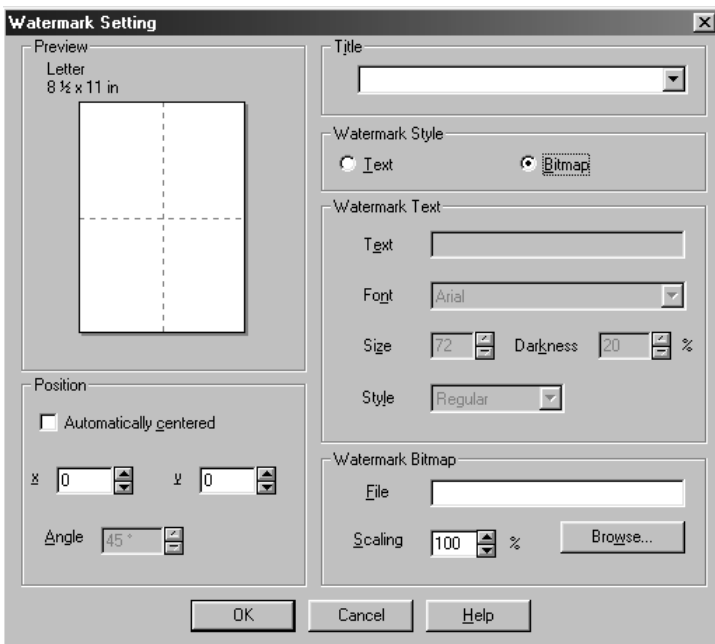

Position

The position settings offer controls on where the Watermark can be positioned on the page.

Page Setting (*4)

You can change the print size of your document with the Scaling feature.

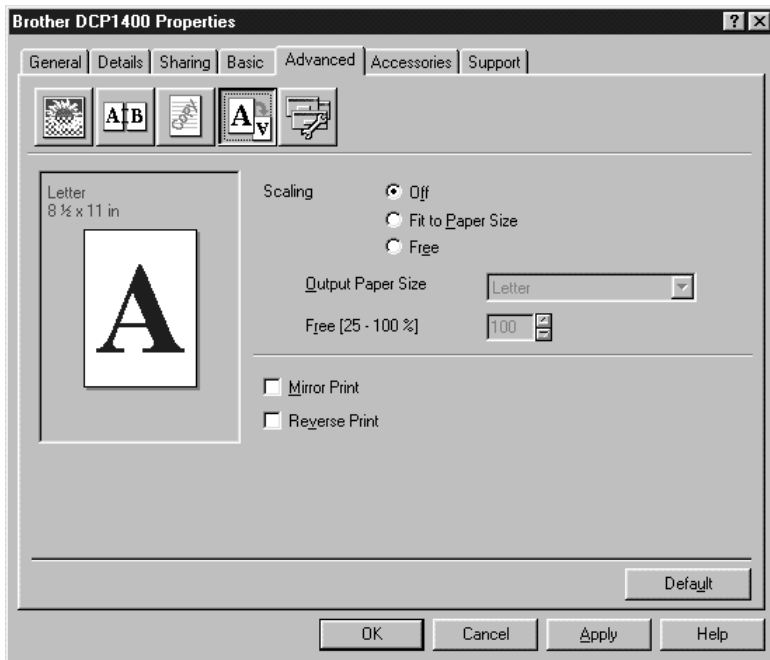

- 1 Check **Off** if you want to print the document as it appears on your screen.
- 2 Check **Fit to Paper Size**, if your document has an unusual size, or if you have only the standard size paper.
- 3 Check the **Free** box if you want to reduce or enlarge the output.

You can use the Mirror or Reverse Print feature for your page setting.

Device Options (*5)

Set one of the following Printer Functions:

- Quick Print Setup
- Administrator (For Windows® 95/98/98SE/Me Users Only)
- Print Date & Time

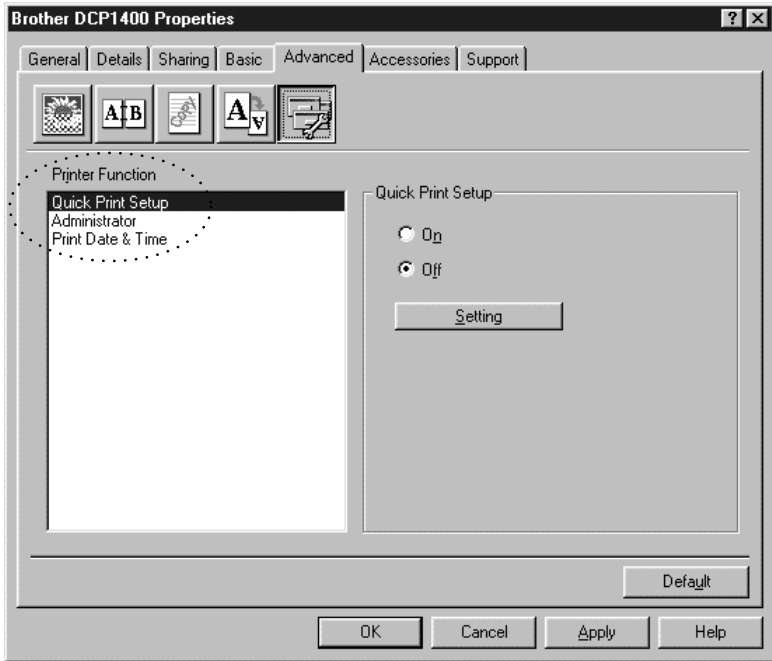

Quick Print Setup

The Quick Print Setup feature allows you to quickly select driver settings. To view setting, simply click your mouse button on the task tray  icon. This feature can be set to ON or OFF from the Device Options section.

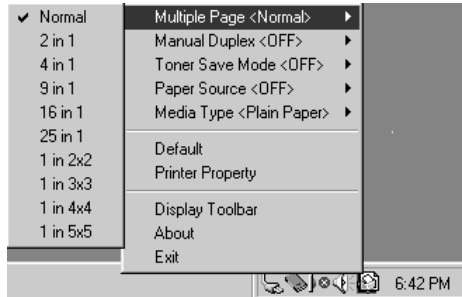

Administrator (For Windows® 95/98/98SE/Me Users Only)

The administrator selection permits the Copy, Scaling and Watermark features to be locked and password protected.

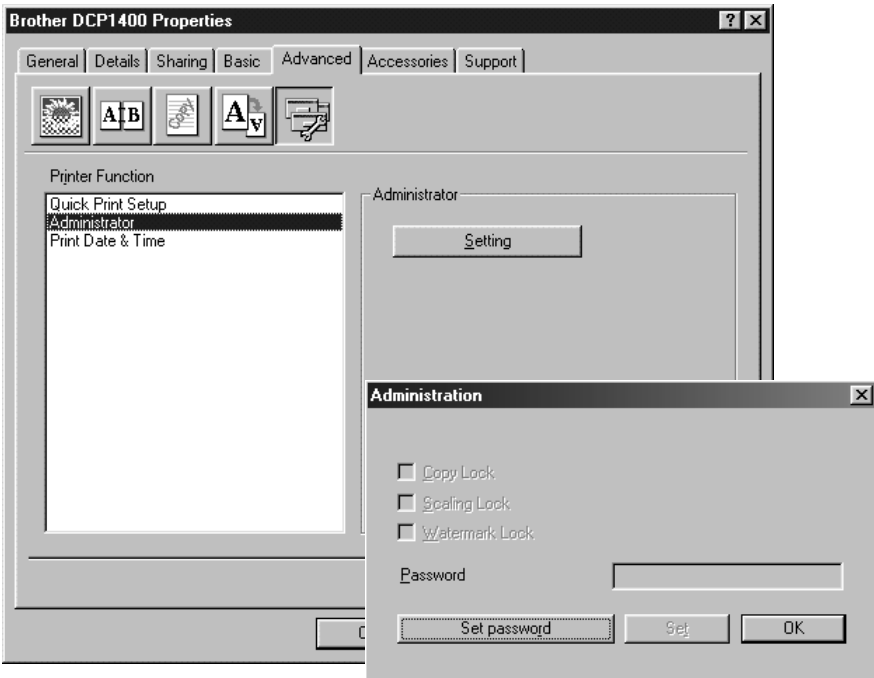

Note Record your password and keep it in a safe place for future reference. If you forget your password these settings can not be accessed.

Print Date & Time

When enabled the Print Date and Time feature automatically will print the date and time from your computers system clock on your document.

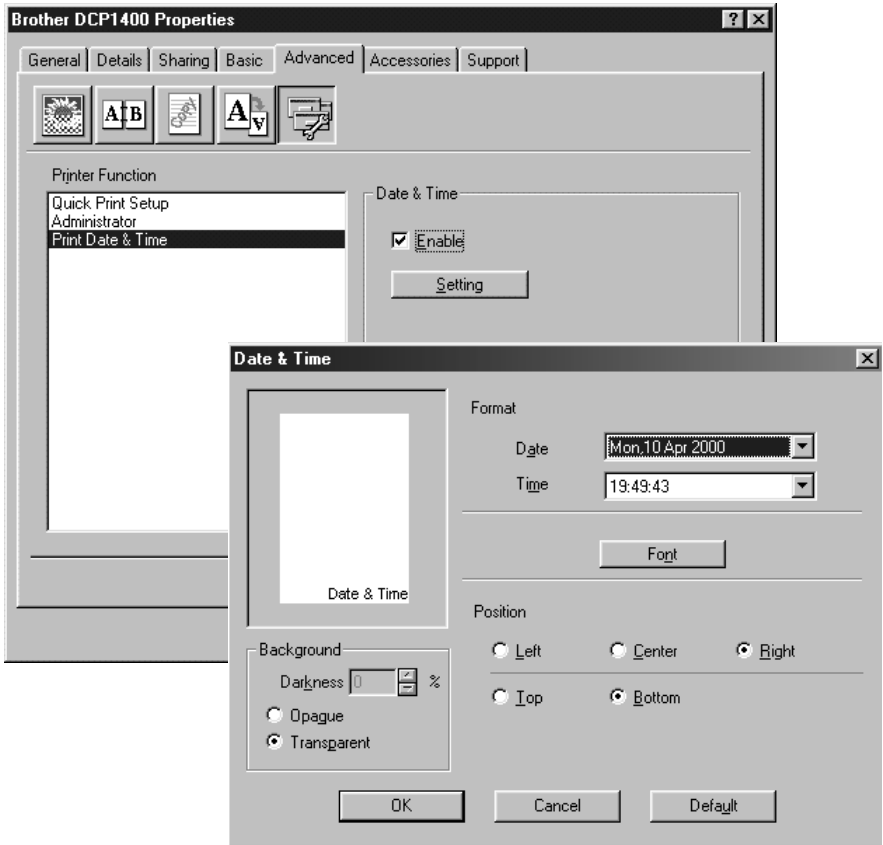

Click the **Setting** button to change the Date and Time Format, Position and Font. To include a background with the Date and Time select Opaque. When Opaque is selected you can set the Darkness of the Date and Time background by changing the percentage.



The Date and Time indicated in the selection box represents the format that will be printed. The actual Date and Time printed on your document is automatically retrieved from your computer settings.

Accessories Tab

The Accessories Tab includes the settings for configuring the printer driver for the size of paper loaded in each paper source. This tab also installs any additional options into the driver settings.

Paper Source Setting

To configure the paper size for each paper source, highlight the source from the **Paper Source Setting** list. Select the **Paper Size** from the pull-down box and click **Update**. (The Paper Source Setting is used when selecting **Auto Select** in the Basic Tab.)

Default Source

The Default Source allows you to choose the paper source that will be used when the paper size of the document being sent does not match the Paper Source settings.

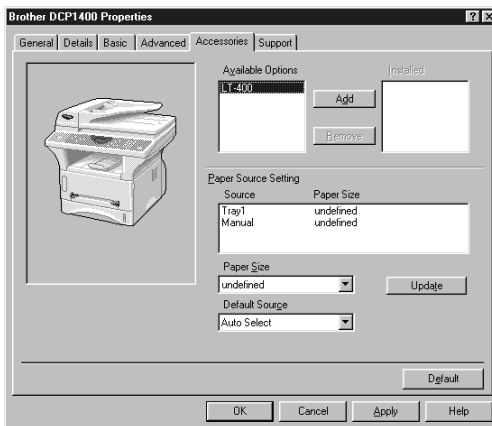

Available Options

In order to access the optional 2nd paper tray the option must be installed in the driver. Highlight the model number from the **Available Options** list and click **Add**. The optional tray will then be listed in the Installed box, Paper Source Setting list and the screen illustration will display the 2nd tray.

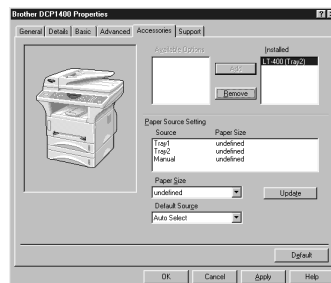

Support

The Support Tab provides driver version information and setting information. In addition there are links to the Brother Solution Center and Driver Update Web sites.

Brother Solutions Center

The Brother Solutions Center is a Web site offering information about your Brother product including FAQ's, User Guides, Driver updates and Tips for using your machine.

Web Update

Web Update checks the brother web site for updated drivers and automatically downloads and updates the driver on your computer.

Check Setting

The Check Setting selection displays a list of your current drivers settings.

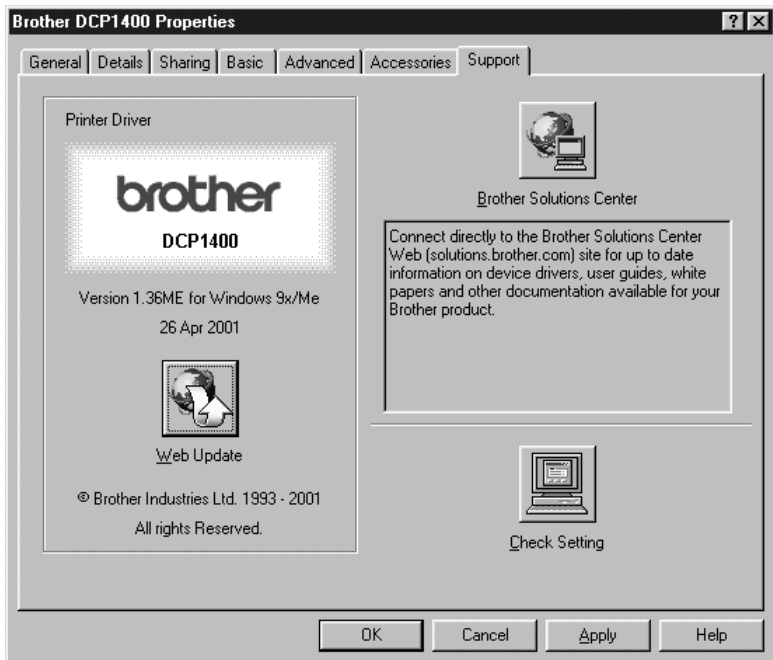

Features in the Printer Driver (For Windows® 2000)

The Windows® 2000 Professional printer driver utilizes Microsoft's uni-driver architecture. The following section describes the driver features and selections available for Windows® 2000.

General Tab

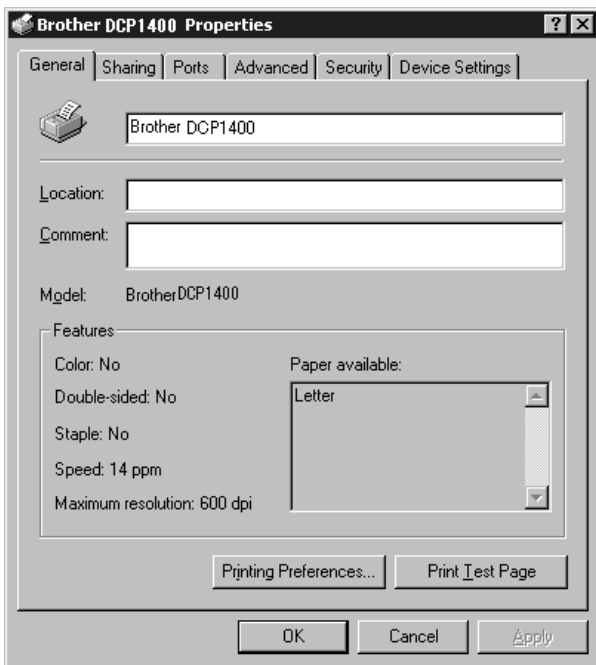

Printing Preferences

In the General tab, click the **Printing Preferences...** button to access the Layout tab.

Layout Tab

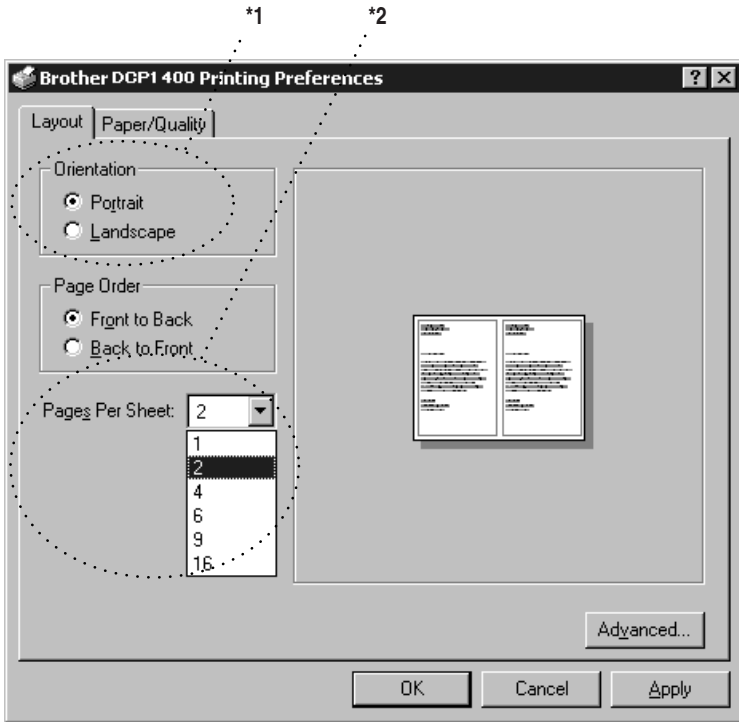

*1 Orientation

Select the Orientation, which is how your document will be positioned on the paper (Portrait or Landscape).



Portrait

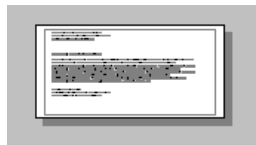

Landscape

*2 Pages Per Sheet

You can select 1, 2, 4, 6, 9 or 16 pages to be printed on one sheet of paper. The image of each page will be reduced as needed to fit the paper.

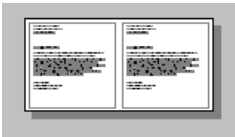

2 in 1

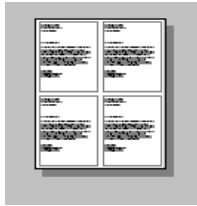

4 in 1

Paper/Quality Tab



*1 Paper Source

Possible paper sources are: Automatically Select, Auto, Upper Paper Tray, Lower Paper Tray (optional cassette #2) and Manual Feed Slot.

When “Automatically Select” is chosen, the DCP automatically will choose the cassette with the appropriate size of paper.

Note The paper size for each paper source must be set in the Device Settings tab for the Automatically Select feature to work properly.

The “Auto” option is for machines that can automatically detect the size of paper that is loaded in the paper source; Auto is not active for your DCP.

*2 Media

For the best print quality, select the type of media you are using:

- Regular
- Thick Paper
- Thicker Paper
- Transparency

When using ordinary plain paper, select Regular. When using heavier weight paper, envelopes, or rough paper, select Thick Paper or Thicker Paper. For OHP transparencies, select Transparency.

Advanced Options

Click the **Advanced...** button in the Paper/Quality tab to access the screen below:

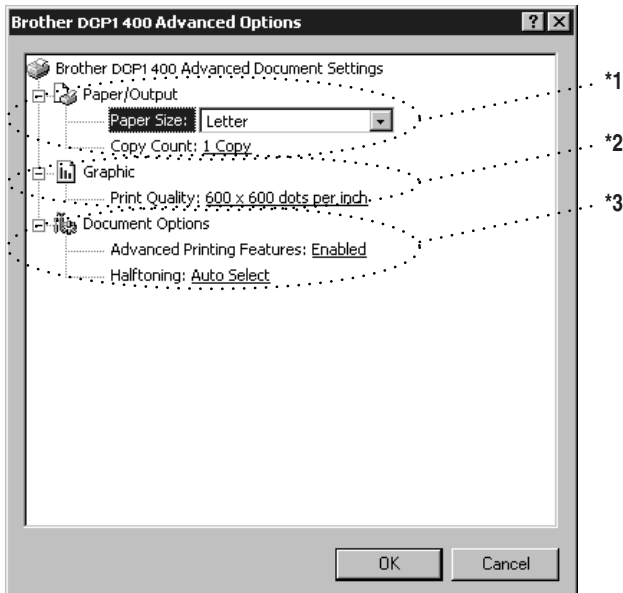

*1 Paper /Output

Paper Size – Select the paper size of the document you are printing. This size should be the same as the paper size that is set in your application software.

Copy Count – Type the number of copies you want.

***2 Graphic**

Print Quality – You can change the resolution as follows:

- 600 × 600 dots per inch
- 300 × 300 dots per inch

***3 Document Options**

Advanced Printing Features – You can Enable or Disable Advanced Printing Features from this selection. If you disable it, Page Order, Pages Per Sheet, Copy and Collate will be disabled.

Halftoning – This selection is for changing the dither pattern to achieve the best print results when printing graphics. The choices are as follows:

- Auto Select
- Super Cell
- Dither 6 × 6
- Dither 8 × 8

Device Settings Tab

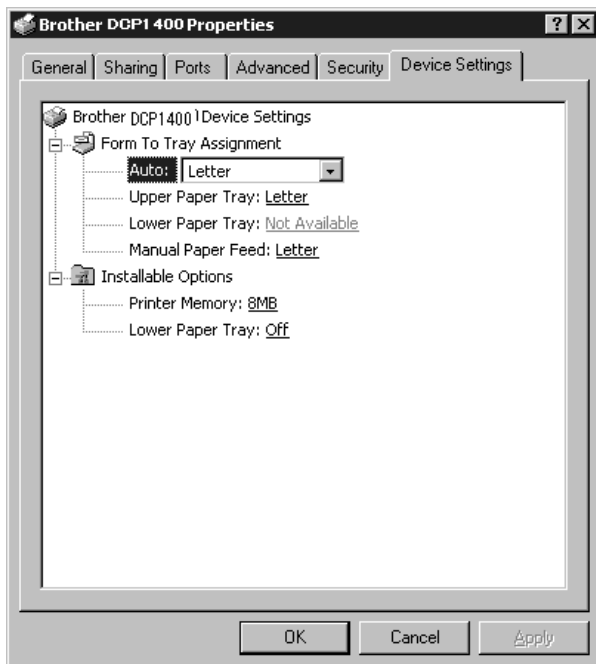

Form To Tray Assignment – This selection assigns the paper size to each paper source. For auto paper selection (Automatically Select) to work properly, the paper size set for each source must match the actual size of paper loaded.

The available options are:

- A4
- A5
- B5 (JIS)
- Executive
- Legal
- Letter

Installable Options

Lower Tray – If an optional lower tray is installed, this selection must be set to ON to enable access to the lower tray.

9

Using the Windows®-Based Brother MFL-Pro Control Center

Brother Control Center

The Brother Control Center is a software utility that pops up on the PC screen whenever paper is placed in the automatic document feeder (ADF). This allows you to quite easily, with very few mouse clicks, access the most frequently used scanning applications. Using the Control Center eliminates the need to manually launch the specific applications.

The Brother Control Center provides two categories of operations:

- Scanning directly to a file, E-mail, word processor or graphic application of choice
- Copying

DCP-1400:





AutoLoad the Brother Control Center

The Control Center is initially configured to automatically load each time Windows® is started. When the Control Center is loaded, the Control Center icon will appear in the task bar. If you don't want the Control Center to load automatically, you can turn off AutoLoad.

If the Control Center  icon does not appear in your task bar, you will have to install this software.

From the **Start** menu select **Programs, Paper Port**, and then double-click **Brother SmartUI PopUp**.

How to Turn Off AutoLoad

- 1 Left-click the Control Center  icon, and then click **Show**.
- 2 When the Control Center icon appears, left-click the Smart Click  Control Center button. A dialogue box with a check box labeled “AutoLoad Pop-up” will appear:

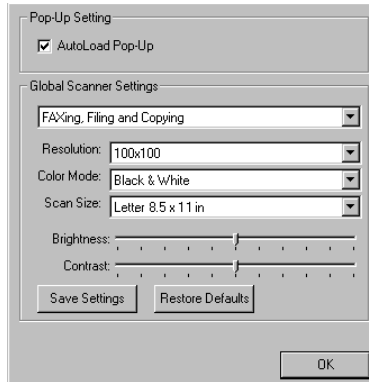

- 3 Uncheck the AutoLoad Pop-Up option.

Using the Scan Keys

You can use the Scan keys on the control panel to scan originals into your word processing, graphics or E-mail applications. The advantage of using the Scan keys is that you avoid the mouse clicks required to scan from your PC.

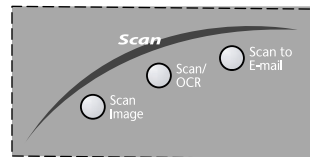

Using the Control Panel Keys

-  If you have connected a Macintosh, the control panel keys will not work with your computer.

Before you can use the Scan keys on the control panel, you must have connected the DCP to your Windows®-based PC and loaded the appropriate Brother Drivers for your version of Windows®. When you are ready to use the Scan keys, make sure the Brother Control Center application is running on your PC. (For details about how to configure the Brother Control Center buttons to launch the application of your choice using the Scan keys, see *Brother Control Center Features*, Page 9-4 to 9-6.)

Scan Image

You can scan a picture into your graphics application for viewing and editing.

- 1 Place your original face up in the ADF, or face down on the scanner glass.
- 2 Press **Scan Image**.

The DCP will scan the original and send a color image to your graphics application.

Scan/OCR

If your original is text, you can have it automatically converted by ScanSoft™ TextBridge® to an editable text file and then displayed in your word processing application for further editing.

- 1 Place your original face up in the ADF, or face down on the scanner glass.
- 2 Press **Scan/OCR**.
- 3 The DCP will scan the original perform OCR in ScanSoft™ TextBridge® and then display the result in your word processing application for viewing and editing.

Scan to E-mail

You can scan an original into your E-mail application as a file attachment. Although the Brother Control Center can be configured to send only black and white or color file attachments at one time, you can easily change this setting. (For details see *Scan to E-mail*, page 9-8 to 9-10.)

- 1 Place the original face up in the ADF, or face down on the scanner glass.
- 2 Press **Scan to E-mail**.
- 3 The DCP will scan the original, create a file attachment, and launch your E-mail application, displaying the new message waiting to be addressed.

Brother Control Center Features

Auto Configuration

During the installation process the Control Center checks your system to determine the default applications for E-mail, word processing and graphics viewer/editor. For example, if you are using Outlook as your default E-mail application, the Control Center automatically will create a link and a scanning application button for Outlook.

You can change a default application by right-clicking any of the scan buttons in the Control Center and selecting a different application. For example,

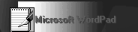
you can change a scan button from MS Word  to MS Word Pad  by changing the application that is listed for the Word Processor.



Scanning Operations

Scan to File—allows you to scan directly to a disk file with two mouse clicks. You can change the file type, destination directory and file name, as needed.

Scan to E-mail—enables you, with just two mouse clicks, to scan a picture or text document directly into an E-mail application as a standard attachment. You have the option of selecting the file type and resolution for the attachment.

Scan to Word Processor—enables you to scan a text document, run ScanSoft TextBridge OCR and insert the text original (not graphic image) into a word processing file with just two mouse clicks. You have the option of selecting the destination word processing program, such as Word Pad, MS Word, Word Perfect, etc.

Scan to Graphic Application—allows you to scan an image directly into any graphic viewer/editor application. You can select the destination application, such as MS Paint or Corel PhotoPaint.

Copy Operations

Copy—allows you to use the PC and any Windows® printer driver for enhanced copy functions. You can scan the page on the Brother DCP and print the copies using any of the features of the Brother DCP printer driver—**OR**—you can direct the copy output to any standard Windows® printer driver installed on the PC.

Scanner Settings for Scan and Copy

When the Pop-Up screen is displayed, you can access the Scanner Settings window.

Click the Smart Click  icon at the top right of the Brother Control Center screen—**OR**—Click the **Modify Settings...** button on any of the Configuration screens.

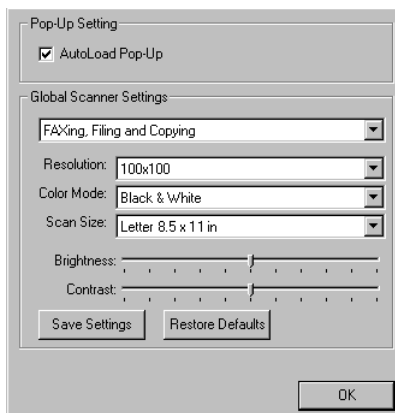

Global Settings

AutoLoad Pop-Up—Click this checkbox if you want Brother MFL Control Center to load when you boot your computer.

Setting Up the Scanner Configurations

The Pop-Up application stores eight different scanning modes. Each time you scan an original, you will choose the most appropriate scanning mode from the following:

Faxing, Filing and Copying

Text for OCR

Photos

Photos (High Quality)

Photos (Quick Scan)

Custom

Draft Copy

Fine Copy

Each mode has its own set of stored settings. You can keep the factory default settings or change them at any time:

Resolution—Select the scanning resolution you most frequently use.

Color Mode—From the pull-down list, select

Scan Size—From the pull-down list, select

Brightness—Slide the adjuster from 0% to 100%

Contrast—Slide the adjuster from 0% to 100%

Click **OK** to save your changes. If you make a mistake or later decide to return to the original default setting, just click the **Restore Defaults** button when the scanning mode is displayed.

To Access the Scanner Configuration Screen:

- 1 Place the original in the ADF.
- 2 Right-click the appropriate Control Center button to display *Configurations...*, then click it. The configuration screen for that **Control Center** button will appear.
- 3 To save your settings, press the **OK** button—**OR**—To return to the factory default settings, press the **Restore Defaults** button.

Perform an Operation from the Control Center Screen

If you see this screen it means you left-clicked a button in the Control Center window without first placing an original in the ADF.

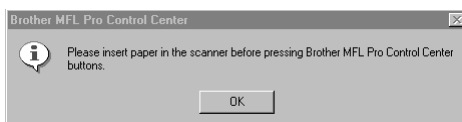

Place the original in the Brother machine's ADF, and then click **OK** to return to the Control Center screen.



If you want to scan the document from the scanner glass, please use Scan keys on the control panel.

Scan to File

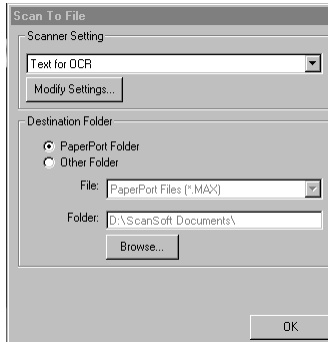

Scanner Settings

From the pull-down list, select the scanning mode that is appropriate for the type of file: Faxing, Filing and Copying; Text for OCR; Photos; Photos (High Quality); Photos (Quick Scan); Custom; Draft Copy or Fine Copy.

To change any of the settings for that mode, click the **Modify Settings...** button.

Destination Folder

PaperPort Folder—Select this checkbox to scan the original into your PaperPort folder.

Other Folder—Select this checkbox, to scan the original as another file type and/or into another directory/folder.

File—If you selected Other Folder, from the pull-down list select the type of file:

- PaperPort Files (*.MAX)*
- Self Viewing Files (*.EXE)*
- PaperPort 5.0 Files (*.MAX)*
- PaperPort 4.0 Files (*.MAX)*
- PaperPort 3.0 Files (*.MAX)*
- Windows Bitmap (*.BMP)*
- PC Paintbrush (*.PCX)*
- Multi-page PCX (*.DCX)*
- JPEG Image Files (*.JPG)*
- TIFF-Uncompressed (*.TIF)*
- TIFF Group 4 (*.TIF)*
- TIFF Class F (*.TIF)*
- Multi-Page TIFF-Uncompressed (*.TIF)*
- Multi-Page TIFF Group 4 (*.TIF)*
- Multi-Page TIFF Class F (*.TIF)*
- PDF Files (*.PDF)*
- Portable Network Graphics (*.PNG)*
- FlashPix (*.FPX)*
- HFX Fax Files (*.HFX)*

To Search your system for the directory and folder you want, click the **Browse...** button. Click **OK** to save your settings.

Scan to E-mail

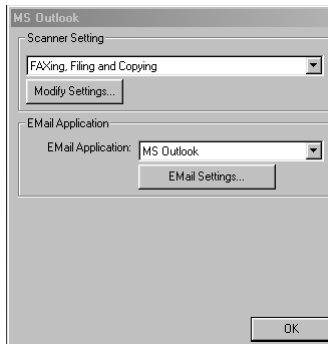

Scanner Settings

From the pull-down list, select the scanning mode that is appropriate for the type of file: Faxing, Filing and Copying; Text for OCR; Photos; Photos (High Quality); Photos (Quick Scan); Custom; Draft Copy or Fine Copy.

To change any of the settings for that mode, click the **Modify Settings...** button.

E-mail Application

E-mail Package—From the pull-down list, select your E-mail application.

E-mail Settings—Click the **EMail Settings...** button to set up links.

The Links Preferences window will appear:

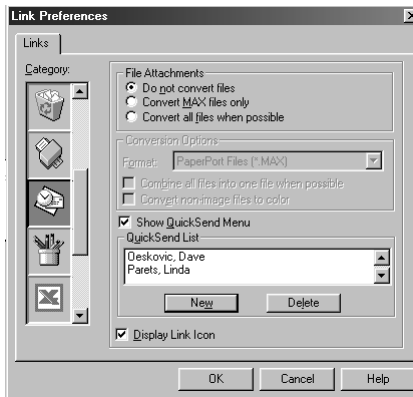

File Attachments

Do not convert files—Click this checkbox if you do not want to change the file type of attachments. The Conversion Options will not be available (grayed).

Convert MAX files only—Click this checkbox if you want to convert only attachments that are PaperPort files.

Convert all files when possible—Click this checkbox if you want to change the file type of all attachments.

Conversion Options

Format

Combine all files into one file when possible—Click this checkbox to combine all files of the same type into one file.

(For Brother Color Models Only)

Convert non-image files to color—Click this checkbox to convert all files that have been processed through OCR to color.

Show QuickSend Menu

Click this checkbox if you want the Select QuickSend Recipient window to be displayed when you choose Scan to E-mail. This feature works only with MAPI type E-mail applications, such as Microsoft Exchange, Microsoft Outlook and Eudora.

QuickSend List

You can create a list of Email names and addresses for quick selection.

To add a name(s) to your QuickSend list, click the **New** button. Your Email phone book listing will be displayed, so you can select stored names or create new ones:

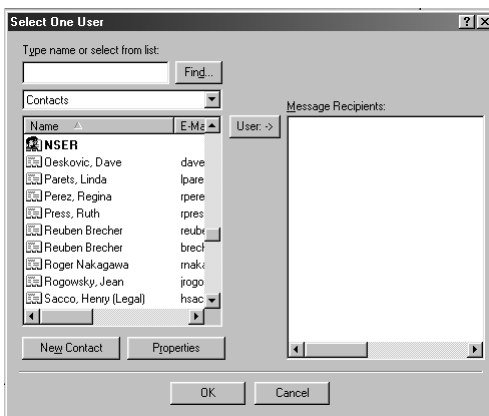

Highlight the name(s) you want to add to your list, and then click the **User** button. Click **OK** to return to the Link Preference window.

To remove a name from the QuickSend list, in the Link Preference window highlight the name and click the **Delete** button.

Scan to Word Processor



Scanner Settings

From the pull-down list, select the scanning mode that is appropriate for the type of file: Faxing, Filing and Copying; Text for OCR; Photos; Photos (High Quality); Photos (Quick Scan); Custom; Draft Copy or Fine Copy.

To change any of the settings for that mode, click the **Modify Settings...** button.

Word Processor

Word Processor—From the pull-down list, select the word processor you want to use.

Click the **Link Settings...** button to display a screen to set up a link to the version of OCR and document format that you want to use:

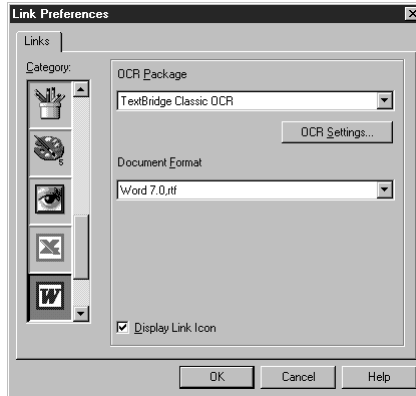

OCR Package—From the pull-down list, select *TextBridge Classic OCR* if you want to use the OCR package that was installed with the Brother software.

Click the **OCR Settings...** button to choose how the OCR application will read the pages you scan into your word processor application.

The Preferences window will appear:

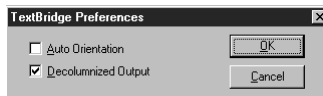

Select your setting and click **OK**.

Auto Orientation—Check this checkbox if you want your word processor application to read the page as it is set up.

Decolumnized Output—Check this checkbox if you want your word processor application to read across the entire page from left to right.

Document Format—From the pull-down list, select the file format you want to use for your word processor or text documents.

User-Defined Button



Scanner Settings

From the pull-down list, select the scanning mode that is appropriate for the type of file: Faxing, Filing and Copying; Text for OCR; Photos; Photos (High Quality); Photos (Quick Scan); Custom; Draft Copy or Fine Copy.

To change any of the settings for that mode, click the **Modify Settings...** button.

Target Application

Application—From the pull-down list, select the application you want to add to this Pop-Up screen.

Click the **Custom Link Settings...** button to set up links for your user-defined application.

Copy

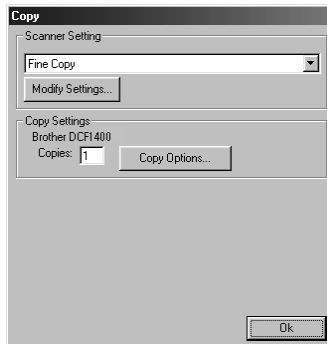

Scanner Settings

From the pull-down list, select the scanning mode that is appropriate for the type of file: Faxing, Filing and Copying; Text for OCR; Photos; Photos (High Quality); Photos (Quick Scan); Custom; Draft Copy or Fine Copy.

To change any of the settings for that mode, click the **Modify Settings...** button.

Copy Settings

Brother DCP-1400

Copies—Enter the number of copies you want to print.

To change the copy options, click the **Copy Options...** button.

Click the **OK** button to save your Copy settings.

10 Using ScanSoft™ PaperPort® for Brother and ScanSoft™ TextBridge® (For Windows® Only)

Using ScanSoft™ PaperPort® and TextBridge®

ScanSoft™ PaperPort® for Brother is a document management application. You will use PaperPort® to view incoming faxes and scanned documents. PaperPort® has a sophisticated, yet easy-to-use, filing system that will help you organize your documents. It allows you to combine or “stack” documents of different formats for printing, faxing or filing. PaperPort® can be accessed through the PaperPort® program group. See *On-Line Documentation for Multi-Function Link® Pro* on the CD-ROM.

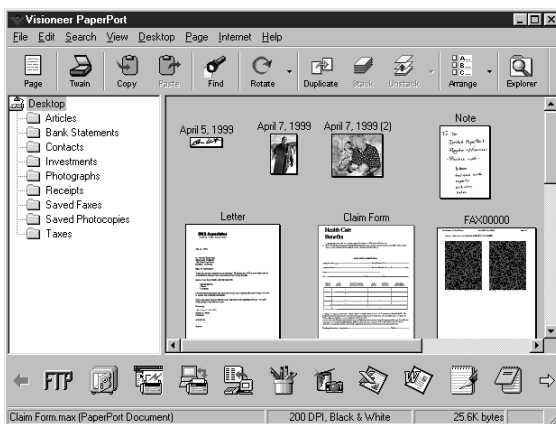

The complete ScanSoft™ PaperPort® Owner's Manual, including ScanSoft™ TextBridge® OCR, is in the On-Line Documentation on the CD-ROM. This chapter is only an introduction to the basic operations.

When you install Multi-Function Link® Pro, ScanSoft™ PaperPort® for Brother and ScanSoft™ TextBridge® OCR are installed with it automatically.



To Uninstall PaperPort® and ScanSoft™ TextBridge

For Windows® 95/98/98SE, and Windows NT® Workstation 4.0, Windows® ME and Windows® 2000 Professional:

Select Start, Settings, Control Panel, Add/Remove Programs and the Install/Uninstall tab. Select PaperPort® from the list and click the Add/Remove button.

Viewing Items in ScanSoft™ PaperPort® for Brother

PaperPort® provides several ways to view items: **Desktop View** displays a **thumbnail**, a small graphic that represents each item in a Desktop or folder. Items in the selected folder appear on the PaperPort® Desktop. You can see PaperPort® items (MAX files) and non-PaperPort® items (files created using other applications).

Non-PaperPort® items include an icon that indicates the application that was used to create the item; a non-PaperPort® item is represented by a small rectangular thumbnail and not an actual image.

Page View displays a close-up of a single page and you can open a PaperPort® item by double-clicking on it. As long as you have the appropriate application on your computer to display it, you can also double-click a non-PaperPort® item to open it.

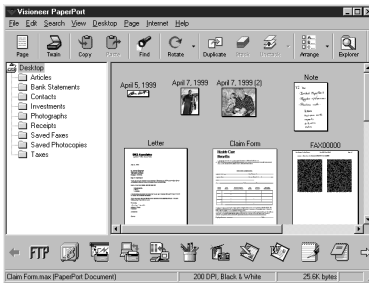

Desktop View displays items as thumbnails

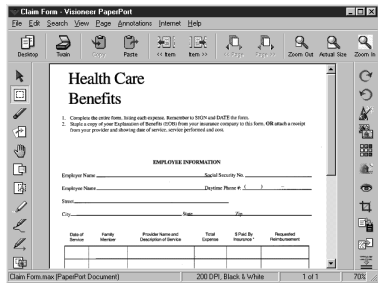

Page View displays each item as a full page

Organizing Your Items in Folders

PaperPort® has an easy-to-use filing system for organizing your items. The filing system consists of folders and items that you select to view in Desktop View. An item can be a PaperPort® item or a non-PaperPort® item:

- Folders are arranged in a “tree” structure in the Folder View. You use this pane to select folders and view their items in Desktop View.
- You can simply drag and drop an item onto a folder. When the folder is highlighted, release the mouse button and the item is stored in that folder.
- Folders can be “nested”—that is, stored in other folders.
- When you double-click a folder, its items (both PaperPort® MAX files and other files) appear on the Desktop.
- You can also use Windows® Explorer to manage the folders and items shown in Desktop View.

Links to Many Other Applications

PaperPort® automatically recognizes many other applications on your computer and creates a “working link” to them. The Link Bar at the bottom of Desktop view shows icons of those linked applications. To use a link, drag an item onto one of the icons to start the application represented by the icon. A typical use of the Link Bar is to select an item and then fax it.

This sample Link Bar shows several applications with links to PaperPort®.



If PaperPort® does not automatically recognize one of the applications on your computer, you can manually create a link using the **Create New Link** command. (See *PaperPort® Help* for more information about creating new links.)

Using ScanSoft™ TextBridge® OCR (Converting Image Text to Text You Can Edit)

Software by:



ScanSoft™ TextBridge® OCR is automatically installed with PaperPort® when you install Multi-Function Link® Pro on your computer.

PaperPort® can quickly convert the text on a PaperPort® item (which is really just a picture of the text) into text that you can edit with a word processing application. PaperPort® uses the optical character recognition application ScanSoft™ TextBridge, which comes with PaperPort®—**OR**—PaperPort® uses your application if it is already on your computer. You can convert the entire item, or by using the **Copy As Text** command, you can select only a portion of the text to convert.

Dragging an item onto a word-processing link icon starts PaperPort®’s built-in OCR application, or you can use your own OCR application.



Importing Items from Other Applications

In addition to scanning items, you can bring items into PaperPort® in a variety of ways and convert them to PaperPort® (MAX) files in several different ways:

- Print to the Desktop View from another application, such as Microsoft Excel.
- Import files saved in other file formats, such as Windows® Bitmap (BMP) or Tag Image File Format (TIFF).

Exporting Items in Other Formats

You can export or save PaperPort® items in several popular file formats. For Windows® 95/98/98SE, and Windows NT® Workstation Version 4.0, Windows® 2000 Professional and Windows® ME, you can export formats BMP, PCX, DCX, JPG, TIF, PDF, PNG, FPX, HFX, or self-viewing. For Windows® 3.1x, you can export file formats BMP, PCX, DCX, JPG, TIF, PDF, HFX and GIF. For example, you could create a file for an Internet Web site and export it as a JPEG file. Web pages often use JPEG files for displaying images.

Exporting an Image File

- 1 Select the Export command from the File pull-down menu in the PaperPort® window. The Export ‘XXXXX’ As dialog box will be displayed.
- 2 Select the drive and directory where you want to store the file.
- 3 Enter the new file name and choose the file type or select a name from the File Name text box. (You can scroll through the Directories and File Name listing for prompting.)
- 4 Select the **OK** button to save your file, or **Cancel** to return to the PaperPort® without saving it.

Accessing the Scanner

To choose the **Brother MFL Pro® Color** as your scanner driver, select it under the “Select scanner”—**OR**—“Select source” option in your software.

From the PaperPort® window, select **Acquire** from the File drop-down menu or select the **TWAIN** or **Scan** button. The Multi-Function Link® Pro Scanner Setup dialog box will appear:

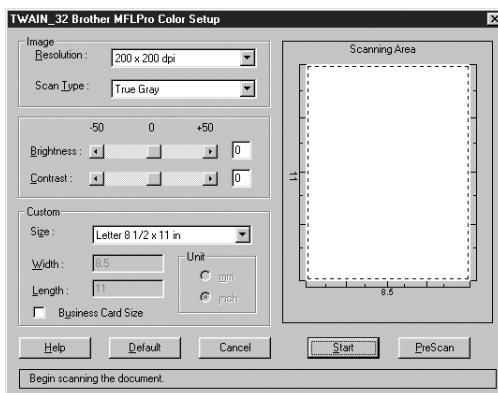

Scanning an Image into Your PC

- 1 Insert document(s) face up in the ADF, or face down on the scanner glass.
- 2 Adjust the following settings, if needed, in the Scanner Setup window:
 - Resolution
 - Scan Type (Black & White, Gray [Error Diffusion], True Gray, 256 color, 24 bit color, 24 bit color (Fast))
 - Brightness
 - Contrast
 - Size
- 3 Select the **Start** button from the Scanner window.

When scanning is completed, close the scanner window. The PaperPort® screen will appear showing the image you scanned highlighted in red.

Settings in the Scanner Window

Image

Resolution

Resolution: Select the scanning resolution from the Resolution drop down list. Higher resolutions take more memory and transfer time, but can achieve a finer scanned image.



When the setting is True Gray, 256 color and 24 bit color 200 × 100 dpi and 200 × 400 dpi is not available.

Scan Type

Black & White: Set the image Type to Black & White for text or line art. For photographic images, set the image type to Gray (Error Diffusion) or True Gray.

Gray (Error Diffusion) is used for documents that contain photographic images or graphics. (Error Diffusion is a method for creating simulated gray images by placing black dots in a specific matrix instead of true gray dots.)

Colors: Choose either 256 Color, which scans up to 256 colors, 24-bit color, which scans up to 16.8 million colors. Although using 24-bit color creates an image with the most accurate colors, the image file will be approximately three times larger than a file created with 256 Color.

Brightness

Brightness: Adjusting the brightness settings to obtain the best image. The Brother Multi-Function Link® Pro offers 100 brightness settings (-50 to 50). The default value is 0, representing an “average” setting.

You can set the brightness level by dragging the sidebar to the right to lighten the image or to the left to darken the image. You can also type a value in the box to set the settings.

If the scanned image is too light, set a lower brightness value and scan the document again.

If the image is too dark, set a higher brightness value and scan the document again.

Contrast

The contrast setting is adjustable only when you have selected one of the gray scale settings, but it is not available when Black & White is selected as the gray Scale.

Increasing the contrast level (by dragging the slider to the right) emphasizes dark and light areas of the Image, while decreasing the contrast level (by dragging the slider to the left) reveals more detail in gray areas. Instead of using the slider, you can type a value in the box to set the contrast.

Custom

Size

Set the Size to one of the following:

- Letter (8 1/2 × 11 in.)
- A4 (210 × 297 mm.)
- Legal (8 1/2 × 14 in.)
- A5 (148 × 210 mm.)
- B5 (182 × 257 mm.)
- Executive (7 1/4 × 10 1/2 in.)
- Business Card (60 × 90 mm.)
- Custom (User adjustable from 0.35 × 0.35 in. to 8.5 × 14 in.)

After you select a custom size, you can adjust the scanning area further by using the left mouse button to drag the dotted outline of the scanning area. This is required when you want to crop an image when scanning.

Business Card Size

To scan business cards, select the Business Card (60 × 90 mm.) size setting and place the business card at the top center of a carrier sheet.



Carrier sheets are available from your Dealer.

When scanning photographs or other images for use in a word processor or other graphics application, you should try different settings for the contrast, mode and resolution to see which settings best suit your needs.

PreScanning an Image

PreScanning allows you to scan an image quickly at a low resolution. A thumbnail version of the image will appear in the Scanning Area. This is only a preview of the image so you can see how it will look. The PreScan button is used to preview an image for cropping any unwanted portions from the image. When you are satisfied with the preview, select the **Start** button to scan the image.

- 1 Insert document face up in the ADF, or face down on the scanner glass.
- 2 Click the **PreScan** button:

The entire document will be scanned into the PC and will appear in the Scanning Area of the Scanner window.

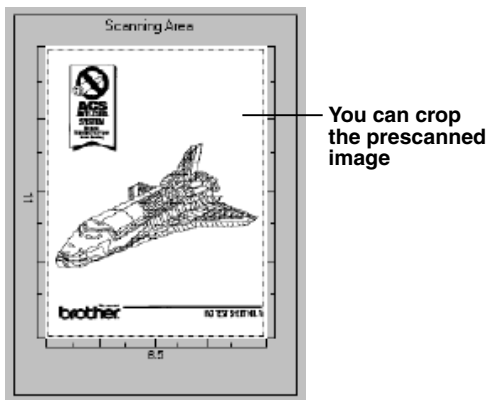

- 3 To crop a portion of the document to be scanned, drag any side or corner of the dotted outline in the Scanning Area with the left mouse button. Adjust the dotted outline until it surrounds only the portion of the document you wish to scan.
- 4 Place the original face up in the ADF again, if you used the ADF in Step 1.
- 5 Adjust the settings for Resolution, Color Type (scan type), Brightness, Contrast, and Size in the Scanner Setup window, as needed.
- 6 Select the **Start** button.
This time only the selected area of the document will appear in the PaperPort® window.
- 7 In the PaperPort® window, use the options available in the Markups pull-down menu and the Crop option in the Options pull-down menu to refine the image.

11 Using Automatic E-Mail Printing

For Windows® 95, 98, 98SE, Me Only

Main Features

- You can use Automatic E-Mail Printing with other E-mail software: Brother Automatic E-Mail Printing has some extra operations that other E-mail software, such as Netscape Navigator™ or MS Internet Mail, do not support.
- Automatic E-Mail Printing can be configured for a multiple user account: In Brother Automatic E-Mail Printing you can set up more than one E-mail account on a single PC so you can print E-mail in each account automatically.
- Automatic access to your specified POP3 server at the specified time: You can specify the time when the Brother Automatic E-Mail Printing automatically accesses the server to check for new mail.
- Provides an “In Memory” printer driver: You can receive and print E-mail data at the same time, by searching for a specified character string in the mail header. It allows you to see the sender, subject and relevant part of the mail content.

Before You Use this Software

Please read *Using Automatic E-Mail Printing* in the **On-Line Documentation** on the CD-ROM. Check the online README.WRI file in the root directory of the CD-ROM for last-minute important information and troubleshooting tips not included in the On-Line Documentation.

To Access the On-Line Documentation



After you have installed the Brother driver(s) for your model and operating system, click **View On-Line Documentation** for operating instructions.

To Install Automatic E-mail Printing (Optional Application):

- 1 Insert MFL Pro CD-ROM into your CD-ROM drive.
- 2 Click on **Install Software** from the main CD-ROM screen.
- 3 Click **Automatic E-mail Printing**.



This is optional software and will not be required for printing and scanning operations.

The “Automatic E-mail Print” option is NOT available for Windows NT® 4.0 and Windows® 2000 Professional.

12 Using the Brother DCP with a New Power Macintosh® G3, G4 or iMac™/iBook

Set up Your USB Equipped Apple® Macintosh® G3, G4, iMac™ or iBook with Mac OS 8.5/8.5.1/8.6/9.0/9.0.4/9.1

Note Before you can connect the DCP to your Macintosh®, you must purchase a USB cable that is no longer than 6 feet (1.8 meters).

To work with your DCP your USB Equipped Apple® Macintosh® must be set up with Mac OS 8.5/8.5.1/8.6/9.0/9.0.4/9.1 (The Brother Scanner Driver works only with Mac OS 8.6/9.0/9.0.4/9.1)

Using Brother Printer Driver with Your Apple® Macintosh®

To select the Printer:

- 1 From the Apple menu, open the **Chooser**.

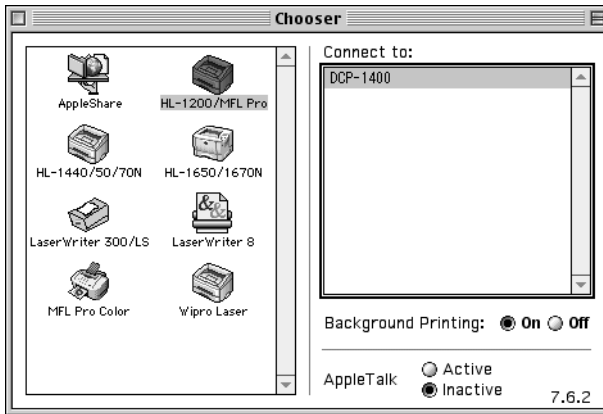

- 2 Click HL-1200/MFL Pro icon. On the right side of the Chooser, click the printer to which you want to print. Close the Chooser.

To print the document:

- 3 From your Macintosh scanning application software such as Simple Text, click *File menu* and select *Page Setup*. You can change the settings for **Paper Size**, **Orientation** and **Scaling**, and then click **OK**.

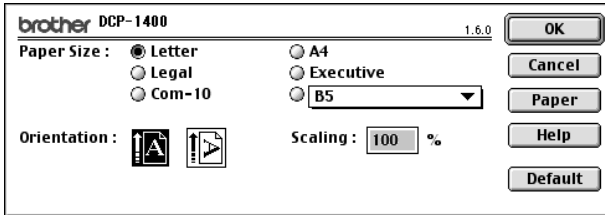

- 4 From your Macintosh scanning application software such as Simple Text, click *File menu* and select *Print*. Click **Print** to start printing.

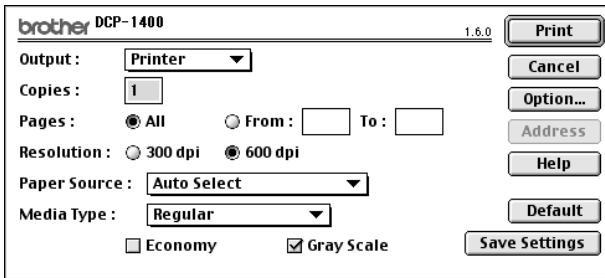

Note If you want to change **Copies**, **Pages**, **Resolution**, **Paper Source** and **Media Type**, select your settings before clicking **Print**.

Option Setup allows you to select **Duplex**.

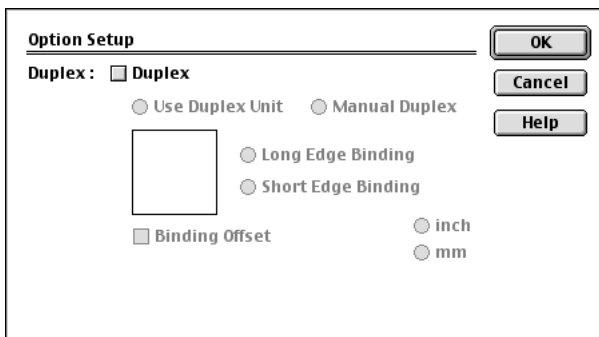

Using Brother TWAIN Scanner Driver with Your Apple® Macintosh®

The Brother DCP software includes a TWAIN Scanner driver for Macintosh®. This Macintosh® TWAIN Scanner driver can be used with application that supports the TWAIN specification. You can use PaperPort® for scanning.

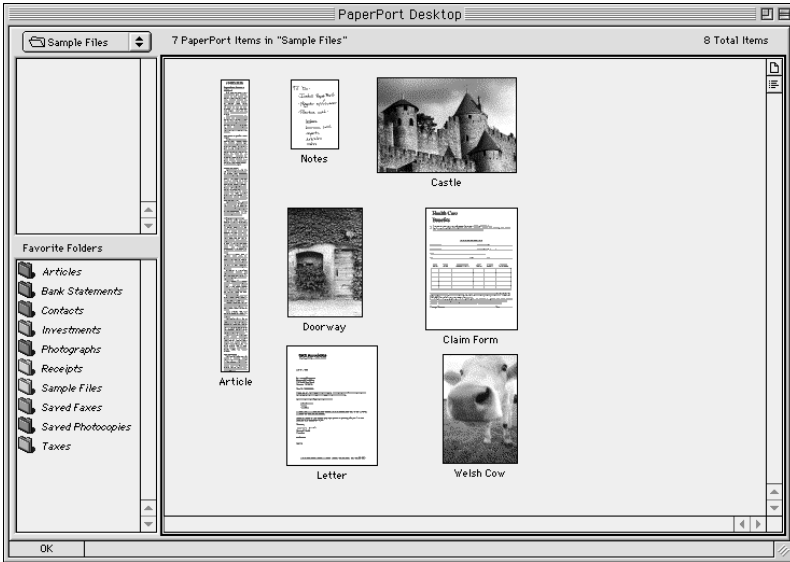

Accessing the Scanner

Run your PaperPort® software. You will see the **PaperPort® icon** in the upper right corner of your screen. The first time you use the Brother TWAIN driver, set it as the default by choosing the *Select Source*, and then click the *PaperPort® icon*. Afterward, for each original you scan, choose *Acquire Image* by clicking the *PaperPort® icon*. The Scanner setup dialog box will appear.

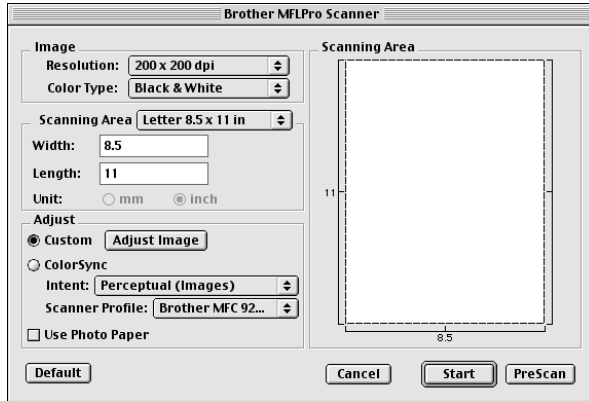

Scanning a Document into Your Macintosh G3, G4 or iMac

- 1 Place the original in the ADF.
- 2 Adjust the following settings, if needed, in the scanner setup dialog box:
 - *Resolution*
 - *Color Type*
 - *Brightness*
 - *Contrast*
 - *Scanning Area*
- 3 Click **Start**.

When scanning is finished, the image will appear in your graphics application.

Settings in the Scanner Window

Image

Resolution

Choose the scanning resolution from the Resolution pop-up menu. Higher resolutions take more memory and transfer time, but can achieve a finer scanned image. (Each model has different resolutions. See Specification.)

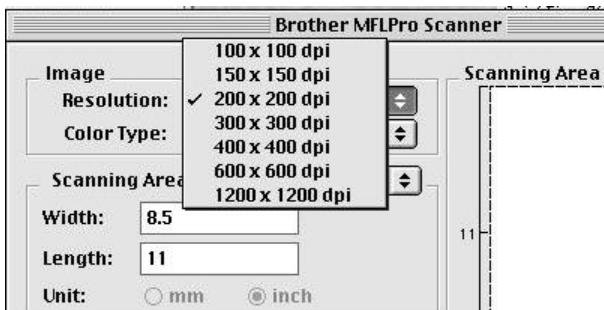

Scanning Area

Set the **Size** to one of the following:

- *Letter (8.5 × 11 inches)*
- *A4 (210 × 297 mm)*
- *Legal (8.5 × 14 inches)*
- *A5 (148 × 210 mm)*
- *B5 (182 × 257 mm)*
- *Executive (7.25 × 10.5 inches)*
- *Business Card (90 × 60 mm)*
- *Custom (User adjustable from 0.35 × 0.35 inches to 8.5 × 14 inches)*

After you choose a custom size, you can adjust the scanning area. Click and hold the mouse button as you drag the mouse to crop the image.

Width: Enter the width of the custom size.

Length: Enter the length of the custom size.

Business Card Size

To scan business cards, select the Business Card size setting (90 × 60 mm) and place the business card at the top center of a carrier sheet.



Carrier sheets are available from your Dealer.

When scanning photographs or other images for use in a word processor or other graphics application, it is a good idea to try different settings for the contrast, mode and resolution to determine which settings look best.

Miscellaneous

Brightness

Adjust the brightness settings to obtain the best image. The Brother TWAIN Scanner driver offers 100 brightness settings (-50 to 50). The default value is 0, representing an “average” setting.

You can set the brightness level by dragging the slider to the right to lighten the image or to the left to darken the image. You can also type a value in the box to set the setting. Click **OK**.

If the scanned image is too light, set a lower brightness value and scan the document again.

If the image is too dark, set a higher brightness value and scan the document again.

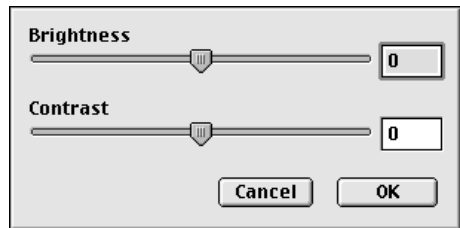

Contrast

The contrast setting is adjustable only when you have selected one of the gray scale settings, but it is not available when Black & White is selected as the Gray Scale.

Increasing the contrast level (by dragging the slider to the right) emphasizes dark and light areas of the Image, while decreasing the contrast level (by dragging the slider to the left) reveals more detail in gray areas. Instead of using the slider, you can type a value in the box to set the contrast. Click **OK**.

PreScanning an Image

PreScanning allows you to scan an image quickly at a low resolution. A thumbnail version will appear in the Scanning Area. This is only a preview of the image, so you can see how it will look. The PreScan button is used to preview an image for cropping any unwanted portions from the image. When you are satisfied with the preview, click Start to scan the image.

1 Insert the original face up in the ADF.

2 Click **PreScan**.

The entire original will be scanned into your Macintosh G3 or iMac and will appear in the Scanning Area of the Scanner dialog box:

3 To scan a portion of the prescanned image, click and drag the mouse to crop it.

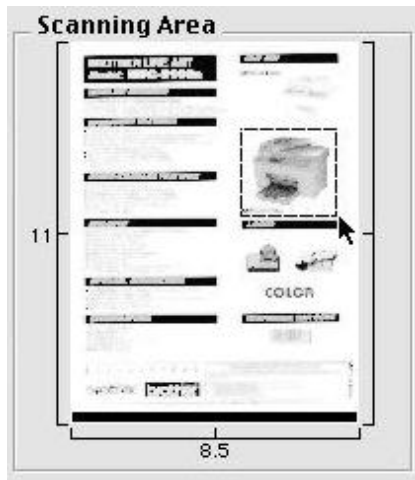

4 Insert original in the ADF of the Brother DCP again.

5 Adjust the settings for Resolution, Color Type (Gray Scale), Brightness, Contrast, and Size in the Scanner Setup dialog box, as needed.

6 Click **Start**.

This time only the selected area of the original will appear in the Scanning Area.

7 Use your application software for editing and refining the image as usual.

13 Optional Accessories

Paper Cassette #2 (Option)

You can purchase the Paper Cassette #2 accessory (**LT400**) to use as a third paper source. Cassette #2 holds up to 250 sheets of 20 lb. (75 g/m²) paper.

Paper Cassette #2:	Holds approx. 250 sheets of 20 lb. (75 g/m ²) Letter/A4 paper
Basis Weight:	16 to 28 lb. (60 to 105 g/m ²)
Caliper:	0.003 to 0.005 inches. (0.08 to 0.13 mm)
Moisture Content:	4% to 6% by weight
Smoothness:	100 to 250 (Sheffield)
We Recommend: Cut sheet:	Xerox 4200DP 20 lb, Champion Paper One 20 lb, Hammermill Laser Paper 24 lb

14 Troubleshooting and Routine Maintenance

Troubleshooting

IMPORTANT

For technical and operational assistance, you must call the country where you purchased the printer. Calls must be made *from within* that country.

Error Messages

As with any sophisticated office product, errors may sometimes occur. If this happens, your DCP often identifies the problem and displays an error message. The table below explains the most common error messages.

You can correct most problems by yourself. If you need additional help, call the Brother fax-back system.

In USA:

1-800-521-2846

Error Messages		
Error Message	Cause	Action
CHANGE DRUM SOON	The drum unit is near the end of its life.	Use the drum unit until you have a print quality problem; then replace the drum unit with a new one.
	The drum counter was not reset.	1. Open the front cover, and then press Clear Settings . 2. Press 1 to reset.
CHECK PAPER CHECK PAPER #1 CHECK PAPER #2	The DCP is out of paper or paper is not properly loaded in the paper cassette.	Refill the cassette or remove the paper and load it again.
CHECK SCAN LOCK	The scanner lock is locked.	Release the scanner lock lever, and then press Stop .
COOLING DOWN WAIT FOR A WHILE	The temperature of the drum unit or toner cartridge is too hot. The DCP will pause its current print job and go into cooling down mode. During the cooling down mode, you will hear the cooling fan running while the display on the DCP shows COOLING DOWN , and WAIT FOR A WHILE .	You must wait 20 minutes for it to cool.

Error Messages		
Error Message	Cause	Action
COVER OPEN PLS CLOSE COVER	The front cover was not completely closed.	Close the front cover for the drum unit.
CHECK ORIGINAL	Originals were not inserted or fed properly, or original scanned from ADF was longer than about 40 inches (90cm).	See <i>Original Jams and Paper Jams</i> , page 14-3.
MACHINE ERROR XX	DCP has a mechanical problem.	Call Brother Customer Service: In USA: 1-800-284-4329 In Canada: 1-877-BROTHER In Montreal: 1-514-685-6464
OUT OF MEMORY (May occur when the DCP is used as a printer.)	DCP memory capacity has been exceeded.	Turn off the power, and then turn it back on. Data remaining in the memory of the DCP will be deleted. <ul style="list-style-type: none"> • If you have installed the Windows® driver, try again after setting the True Type mode to “Print as Graphics” in the PRINT menu of your application software. • Reduce the print resolution or reduce the complexity of your document.
PLS OPEN COVER	A page, piece of paper or paper clip, etc. may be jammed inside the DCP.	Open the front cover. If you see any jammed paper or other item, gently pull it out, then close the front cover. If the error message remains, open and close the front cover again. If the DCP cannot reset itself, it will display MACHINE ERROR XX . Please call Brother Customer Service and tell them the DCP Error number at: In USA: 1-800-284-4329 In Canada: 1-877-BROTHER In Montreal: 1-514-685-6464
PAPER JAM	The paper is jammed in the DCP.	See page 14-3.
TONER EMPTY	Toner cartridge is not installed. —OR— Toner is used up and printing is not possible.	Reinstall the toner cartridge. —OR— Replace the toner cartridge with a new one. (See page 14-17.)
TONER LOW	If the LCD shows TONER LOW , you can still print. But the toner is depleted and the DCP is telling you that the toner will soon run out.	Order a new toner cartridge now.

Original Jams and Paper Jams

Based upon where the original or printed sheet is jammed, follow the appropriate set of instructions to remove it.

Original is Jammed in the top of the ADF Unit

- 1 Remove any paper from the ADF that is not jammed.
- 2 Lift the ADF cover.
- 3 Pull the jammed original out to the left.
- 4 Close the ADF cover.
- 5 Press **Stop**.

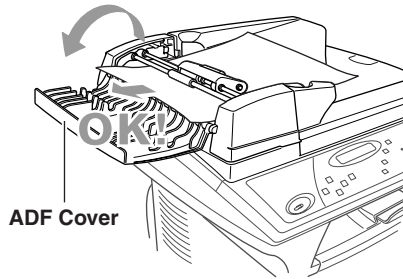

Original is Jammed inside the ADF Unit

- 1 Lift the document cover.
- 2 Remove any paper from the ADF that is not jammed.
- 3 Lift the ADF unit.
- 4 Pull the jammed original out to the right.
- 5 Close the ADF unit.
- 6 Press **Stop**.

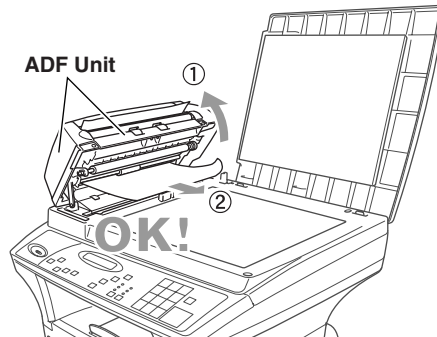

Paper Jam

Before you can clear a paper jam error, you must find out where the paper is stuck. See the following three types of paper jams.

WARNING

Do not use force to pull the jammed paper from the paper tray because you may damage the DCP and cause toner to scatter on the next printed pages.

After you use the DCP, some internal parts are extremely **HOT!** When you open the front, never touch the shaded parts shown in the following diagram.

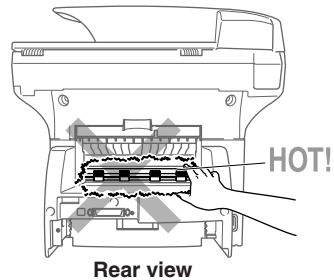
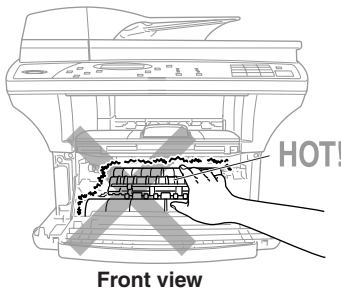

Paper is Jammed in the Paper Cassette

- 1 Pull the paper cassette out of the DCP.
- 2 Remove any crinkled sheets.

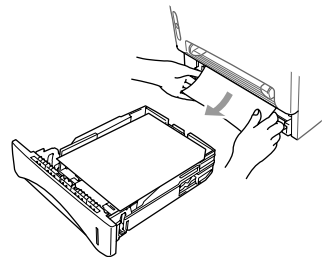

- 3 Adjust the guides to fit.
- 4 Press down on the paper to flatten it in the paper cassette.
- 5 Reinstall the paper cassette.

Paper is Jammed near the Drum Unit

- 1 Open the front cover.
- 2 Remove the drum unit but do not force it if it cannot be removed easily. Instead, pull the edge of the jammed paper from the paper cassette.

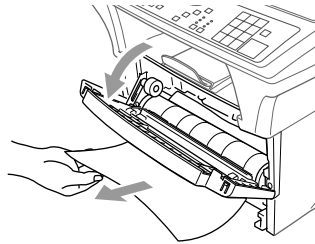
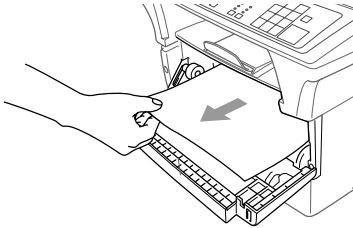

- 3 Gently pull out the jammed paper.
- 4 Reinstall the drum unit.
- 5 Close the front cover.

Paper is Jammed in the Fuser Unit

- 1 Open the rear cover.
- 2 Pull out the jammed paper. When you have to pull paper out the back of the DCP, the fuser may get dirty with toner powder and cause the next printed page(s) to look messy. Print a few copies of the test page until the pages print clearly.
- 3 Close the rear cover.

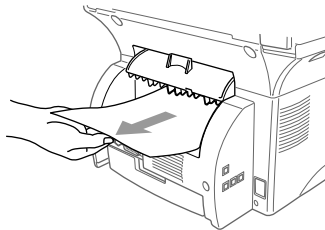



If You Are Having Difficulty with Your DCP





If you think there is a problem with your DCP, *make a copy first*. If the copy looks good, the problem is probably not your DCP. Check the chart below and follow the troubleshooting tips.

DIFFICULTY	SUGGESTIONS
Copy Quality Difficulties	
Vertical streaks appear in copies.	Sometimes you may see vertical streaks on your copies. Either the scanner or the primary corona wire for printing is dirty. Clean them both. (See pages 14-14 and 14-16.)
General Printing Difficulties	
The DCP does not print.	Check the following: <ul style="list-style-type: none"> • The DCP is plugged in. (See page 2-8.) • The toner cartridge and drum unit are installed properly. (See page 2-4.) • The interface cable is securely connected between the DCP and computer. (See Quick Setup Guide.) • Check to see if LCD is showing an error message. (See page 14-1 to 14-2.)
The DCP prints unexpectedly or it prints garbage.	Reset the DCP or unplug the electrical cord and plug it back in. Check the primary settings in your application software to make sure it is set up to work with your DCP.
The DCP cannot print full pages of a document.	The DCP received a very complex print job and could not process part of the page. This print may be solved in several ways. If you are using Windows® 95/98/98SE/Me/2000 Professional or Windows NT® Workstation Version 4.0 with the supplied printer driver, see the “Windows® Setup Printing Difficulties” section. Try to reduce the complexity of your document or reduce print resolution.
The DCP prints first couple of pages correctly, then some pages have text missing.	Your computer is not recognizing the printer’s input buffer full signal. Please make sure to connect the printer cable correctly.
The DCP cannot print full pages of a document. OUT OF MEMORY message occurs.	Reduce the printer resolution. Reduce the complexity of your document and try again. Reduce the graphic quality or the number of font sizes within your application software.
My headers or footers appear when I view my document on the screen but do not show up when I print them.	Most laser printers have a restricted area that will not accept print. Usually these are the first two lines and last two lines, leaves 62 printable lines. Adjust the top and bottom margins in your document to allow for this.
Scanning Difficulties	
TWAIN Errors appear while scanning.	Make sure the Brother TWAIN Driver is selected as the primary source. In PaperPort®, from the File menu select File, select source, and then highlight the Brother TWAIN Driver and click Select.

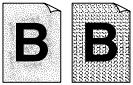
DIFFICULTY	SUGGESTIONS
Software Difficulties	
<p>You see the “New Hardware Found” message on your PC screen (although you have already installed the drivers in Windows 95).</p>	<p>Click on “Do not install a driver. (Windows will not prompt you again)” and click “OK”.</p>
<p>You see the “Update Device Driver Wizard” or “Add New Hardware Wizard” message on your PC screen (although you have already installed the drivers in Windows 95 or 98).</p>	<p>Follow the instructions from the installer, then click “Next”. Click “Finish” when it appears on the screen.</p>
<p>“Unable to write to LPT1” or “LPT1 already in use” Error Message appears.</p> <p>“DCP is Busy” or “DCP Connect Failure” Error Message appears.</p>	<ol style="list-style-type: none"> 1. Make sure the DCP is on (plugged into the AC outlet) and that it is connected directly to the computer using the bundled IEEE-1284 bi-directional parallel cable. The cable must not go through another peripheral device (such as a Zip Drive, External CD-ROM Drive, or Switch box). 2. Make sure the DCP is not displaying an error message on the LCD Display. 3. Make sure no other device drivers, which also communicate through the parallel port, are running automatically when you boot up the computer (such as, drivers for Zip Drives, External CD-ROM Drive, etc.). Suggested areas to check: (<i>Load=, Run=command lines in the win.ini file or the Statup Group</i>) 4. Check with you computer manufacturer to confirm that the computer’s parallel port settings in the BIOS are set to support a bi-directional machine, i.e. (Parallel Port Mode – ECP)
<p>“DCP Connect Failure”</p>	<p>If the DCP is not connected to your PC and you have loaded the Brother software, the PC will show “DCP Connect Failure” each time you restart Windows®. You can ignore this message or you can turn it off by deselecting the AutoLoad PopUp check box in the Brother Control Center. (See <i>How to Turn Off AutoLoad</i>, page 9-2.)</p>

DIFFICULTY	SUGGESTIONS
DOS Setup Printing Difficulties	
I cannot print from my application software.	Check that the DOS application software interface settings match those of your printer. For example, if you are using a parallel printer cable, you would probably set your DOS software printer port to LPT1. Check for an error message on the LCD.
The DCP prints, but it prints incorrect information. Sometimes it prints a couple of characters and then ejects the pages.	This is an indication that your application printer emulation setting and the DCP's printer emulation do not match. Check your application software to make sure you selected the correct printer driver. The DCP emulates HP LaserJet IIP. Try setting the DCP to HP emulation in Remote Printer Console and then select the HP LaserJet IIP printer in your application software.
The DCP prints part of my document but does not print the last page (The LCD shows REMAINED DATA).	This is a common problem with database software and spreadsheet software when they are not correctly set up. The data has been sent to the printer but the printer did not receive the Page Eject command. Press Reset to eject the page. Then ask your software supplier how to add a Page Eject (or Form Feed) command to the end of your print job.
How can I change the user settings or default settings on the DCP?	Use the Remote Printer Console (RPC) program.
Paper Handling Difficulties	
The DCP does not load paper. The LCD shows CHECK PAPER or PAPER JAM .	Check to see if the CHECK PAPER or PAPER JAM message appears on the LCD. If it is empty, load a new stack of paper into the paper cassette. If there is paper in the paper cassette, make sure it is straight. If the paper is curled, you should straighten it. Sometimes it is helpful to remove the paper, turn the stack over and put it back into the paper cassette. Reduce the amount of paper in the paper cassette, then try again. Check the manual feed mode is not selected in the printer driver.
The DCP does not feed paper from the manual feed slot.	Reinsert the paper firmly, load one sheet at a time. Make sure that manual feed mode is selected in the printer driver.
How can I load envelopes?	You can load envelopes from the manual feed slot. Your application software must be set up to print the envelope size you are using. This is usually done in the Page Setup or Document Setup menu of your software. Refer to your software application manual.
What paper can I use?	You can use plain paper, envelopes, transparencies and labels that are made for laser machines. (For information on paper you can use, see <i>Acceptable Paper</i> , page 2-5.)
How can I clear paper jams?	See <i>Paper Jam</i> , page 14-4.

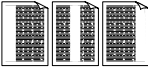
DIFFICULTY	SUGGESTIONS
Print Quality Difficulties	
Printed pages are curled.	Thin Paper (17lb-18.4lb) can cause this problem. Make sure you select the Paper Type that suits the paper in your multi-purpose sheet feeder. (See <i>Paper Type</i> , page 5-6 and 5-10 and <i>Media Type</i> , page 8-4.)
Printed pages are smeared.	Rough surfaces or thick media can cause “smeared pages” — OR —“the toner to smear.” Make sure you select the Paper Type that suits the paper in your multi-purpose sheet feeder. (See <i>Paper Type</i> , page 5-6 and 5-10 and <i>Media Type</i> , page 8-4.)
Printouts are too dark or light.	Adjust the print conditions in the Print Density setting. It has been factory set to the middle position. (See <i>Setting the Print Density</i> , page 4-2.)
Printed pages contain white stripes.  White Stripes or Faint Images	You may fix this by wiping the scanner window with a clean soft cloth. (See <i>Routine Maintenance</i> and <i>Cleaning the Drum Unit</i> , on pages 14-14 and 14-16.) If you still see white stripes or faint images and the LCD shows CHANGE DRUM SOON , replace the drum unit with a new one. Check the DCP’s environment. Conditions such as humidity and high temperatures may cause this print defect to occur.
Printed pages are stained with toner or have vertical stripes.  Dark Stripes or Toner Stains	Clean the DCP’s interior and the primary corona wire of the drum unit. (See <i>Routine Maintenance</i> and <i>Cleaning the Drum Unit</i> , on pages 14-14 and 14-16.) Make sure that the tab of the corona wire is at the Home (▼) position. If after cleaning, you still see dark stripes or toner stains and the LCD shows CHANGE DRUM SOON , replace the drum unit with a new one.
Printed pages have white spots in black text and graphic areas.  White Spots	Make sure that you use paper that meets the specifications. Rough surface or thick media can cause the problem. If you still see white spots and the LCD shows CHANGE DRUM SOON , replace the drum unit with a new one. Check the DCP’s environment; conditions such as high humidity may cause this situation to occur.
Toner scatters and stains the printed page.  Scattering Toner	Adjust the print conditions in the Print Density setting. Remove the drum unit and clean the DCP’s interior. (See <i>Routine Maintenance</i> and <i>Cleaning the Drum Unit</i> , on pages 14-14 and 14-16.) Make sure that you use paper that meets specifications. (See page 2-5.) If you still have scattered toner and the LCD shows CHANGE DRUM SOON , replace the drum unit with a new one. Check the DCP’s environment; high temperature and high humidity may cause this condition to occur.

DIFFICULTY	SUGGESTIONS
<p>The whole page is printed black.</p>  <p>Black Page</p>	<p>Clean the DCP's interior and the primary corona wire of the drum unit. (See page 14-16.) Also, do not use heat sensitive paper as it will cause this problem. After cleaning, if the printed pages are still black or the LCD shows CHANGE DRUM SOON, replace the drum unit with a new one. The drum unit may be damaged.</p>
<p>Nothing printed on the page.</p>  <p>White Page</p>	<p>Make sure that the toner cartridge is not empty. Wipe electric terminals referring to <i>Routine Maintenance</i> and <i>Cleaning the Drum Unit</i>, on pages 14-14 and 14-16. Make sure that a torn piece of paper does not remain on the scanner window.</p>
<p>Printed pages are marked at regular intervals.</p>  <p>Example of Regular Marking</p>	<p>Markings may disappear by themselves. Try copying multiple pages to clear this problem. Markings may occur if the DCP has not been used for a long time. A possible cause is that the surface of the drum is scratched. You must then replace the drum unit with a new one. If the markings do not disappear, it may be that the drum was marked or damaged by excessive exposure to light. In this case, replace the drum unit with a new one.</p>
<p>Printed pages are blurred at the center or at either edge.</p>  <p>Blurred Page</p>	<p>Certain environmental conditions such as humidity and high temperatures may cause this condition to occur. Make sure the DCP is placed on a flat, horizontal surface. Remove the drum unit with the toner cartridge installed. Try rocking them from side to side. You may clear a blurred page by wiping the scanner windows with a clean soft cloth. (See <i>Routine Maintenance</i> and <i>Cleaning the Drum Unit</i>, on pages 14-14 and 14-16.) If a blurred page occurs after cleaning and the LCD shows CHANGE DRUM SOON, replace the drum unit with a new one.</p>
<p>Ghost images appear on printed pages.</p>  <p>Ghost Images</p>	<p>Adjust the print conditions by changing the Print Density setting, page 4-2—OR—Rough surfaces or thick media can cause a ghost image. Make sure you select the Paper Type that suits the paper in your multi-purpose sheet feeder. (See <i>Paper Type</i>, page 5-6 and <i>Media Type</i>, page 8-4.)</p>



The drum unit is a consumable item and it is necessary to replace it periodically.

Packing and Shipping the DCP

Whenever you transport the DCP, use the packing materials that came with your DCP. If you do not pack the DCP correctly, you could void your warranty.

- 1 Unplug the DCP from the AC outlet.

WARNING

Do not unplug the DCP after a print job until you hear the final click.

- 2 Plug the DCP into the AC outlet again. And leave it for 5 seconds.

Lock the Scanner Lock

- 3 Push the blue Scanner Lock Lever up to lock the scanner. This lever is located on the rear left underside of the scanner cover.

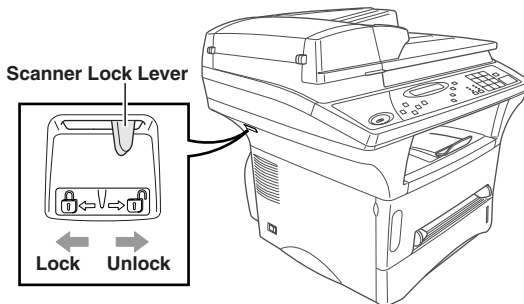

Caution

If the message **CHECK SCAN LOCK** appears on the LCD, unlock the scanner immediately, and then press **Stop**.

WARNING

Damage caused to your DCP by failure to lock the scanner before moving and shipping will void your warranty.

- 4 Open the front cover.
- 5 Remove the drum unit.

! Caution

Remove the drum unit and toner cartridge assembly. Leave the toner cartridge installed in the drum unit.

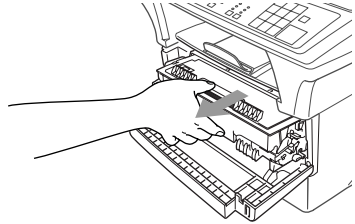

- 6 Place the drum unit and toner cartridge assembly into the plastic bag and seal the bag.

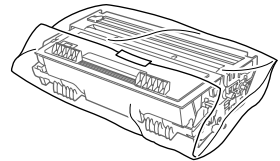

- 7 Close the front cover. Fold down the front output bin extension.
- 8 Wrap the DCP in the plastic bag and place it in the original carton box with the original packing material.

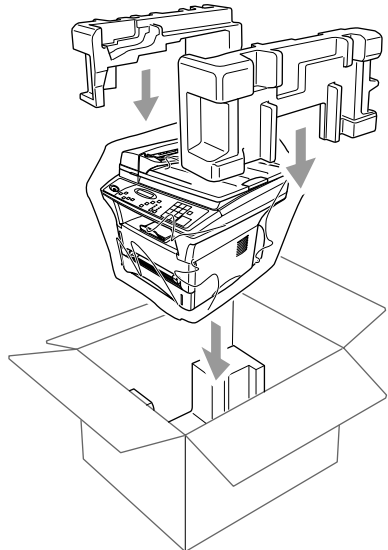
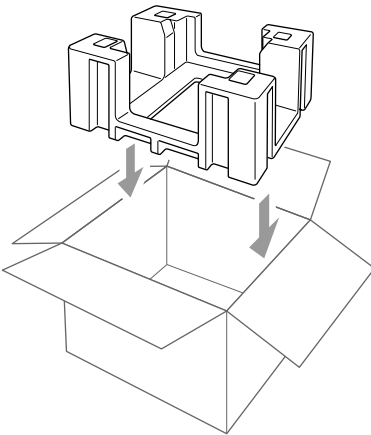

- 9 Pack the drum unit, toner cartridge assembly parallel cable, AC cord and printed materials in the original carton as shown below:

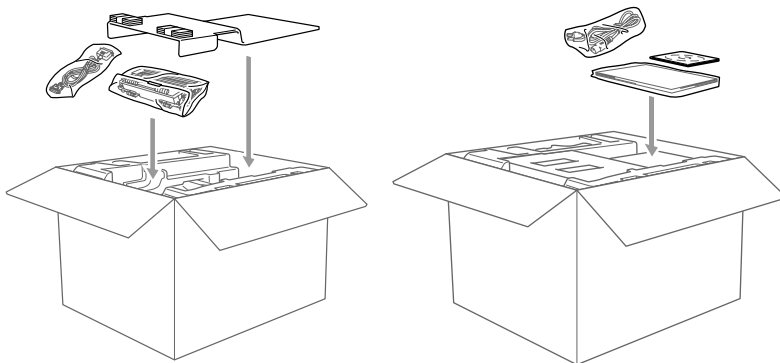

Note If you are returning the DCP to Brother as part of the Exchange Service, pack *only* the DCP. Keep all separate parts to use with your “Exchange” machine.

- 10 Close the carton and tape it shut.

Routine Maintenance

Cleaning the Scanner

Unplug the DCP and lift the document cover. Clean the scanner glass and the white film with isopropyl alcohol on a lint free cloth.

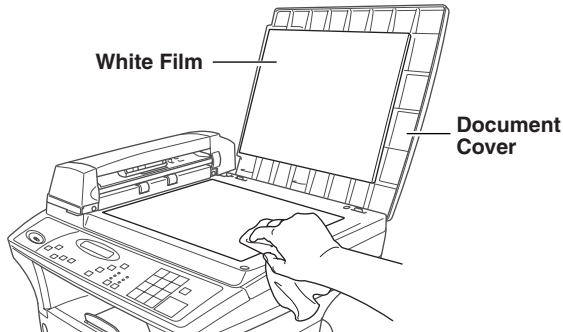

Lift the ADF unit. Clean the white roller and the glass strip under the roller with isopropyl alcohol on a lint-free cloth.

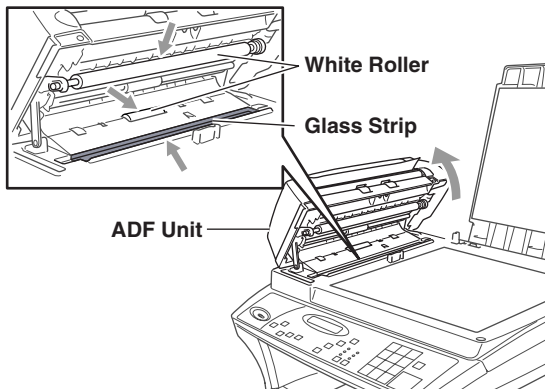

If the screen *still* displays a scanner error, call Brother Customer Service for assistance at 1-800-284-4329 (**in USA**), 1-877-BROTHER (**in Canada**), or 1-514-685-6464 (**in Montreal**).

Cleaning the Printer

! Caution

- Do *not* use isopropyl alcohol to remove dirt from the control panel. It may crack the panel.
- Do *not* use isopropyl alcohol to clean the scanner window or toner sensor.
- Do *not* touch the scanner window with your finger.
- The drum unit contains toner, so handle it carefully. If toner scatters and your hands or clothes get dirty, immediately wipe it off or wash it with cold water.

- 1 Open the front cover.
- 2 Remove the drum unit assembly.

! WARNING

Just after you have used the DCP, some internal parts of the DCP are extremely **HOT!** When you open the front cover of the DCP, never touch the shaded parts as shown in the diagram below.

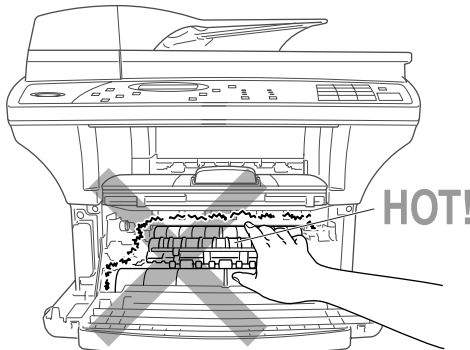

Front view

- 3 Gently clean the scanner window by wiping with a clean soft dry cloth. Do *not* use isopropyl alcohol.

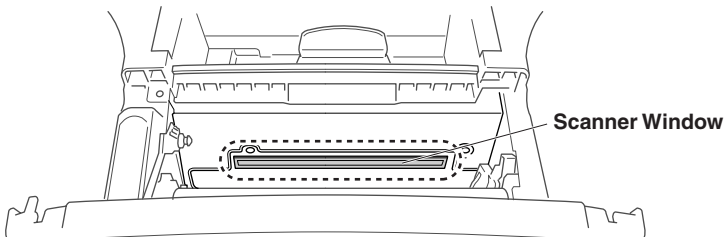

Cleaning the Drum Unit

We recommend placing the drum unit on a drop cloth or large disposable paper to avoid spilling and scattering toner.

- 1 Clean the primary corona wire inside the drum unit by gently sliding the tab from right to left several times.
- 2 Return the tab and snap it into the Home position (▼).

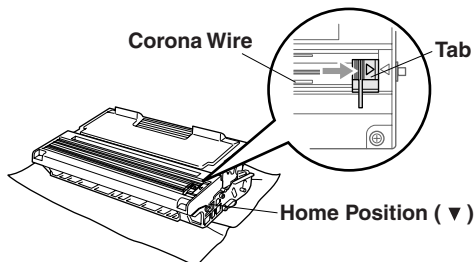

! Caution

If the tab is not at Home position (▼), printed pages may have vertical stripes.

- 3 Reinstall the drum unit into the DCP.
(See *Replacing the Drum Unit*, page 14-19.)
- 4 Close the front cover.
- 5 Plug in the power cord.

Replacing the Toner Cartridge

The DCP can print *up to* 6,000 pages using a *high yield* toner cartridge. When the toner cartridge is running low, the LCD shows **TONER LOW**. The DCP is supplied with a *standard* toner cartridge that must be replaced after approximately 3,000 pages. Actual page count will vary depending on your average document type (i.e., standard letter, detailed graphics).



It is a good idea to keep a new toner cartridge ready for use when you see the **TONER LOW** warning.

Discard the used toner cartridge according to local regulations. If you are not sure of them, your local Sanitation Department. Be sure to seal the toner cartridge tightly so toner powder does not spill out of the cartridge. When discarding used toner cartridges, keep them separate from domestic garbage.

We recommend that you clean the DCP when you replace the toner cartridge.

How to Replace the Toner Cartridge

WARNING

Just after you use the DCP, some internal parts of the DCP will be extremely **HOT!** So, never touch the shaded parts shown in the illustration.

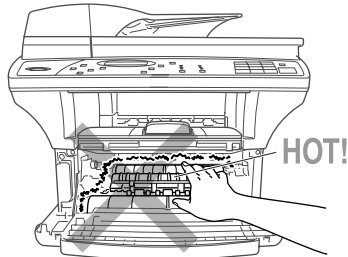

Front view

- 1 Open the front cover and pull out the drum unit.

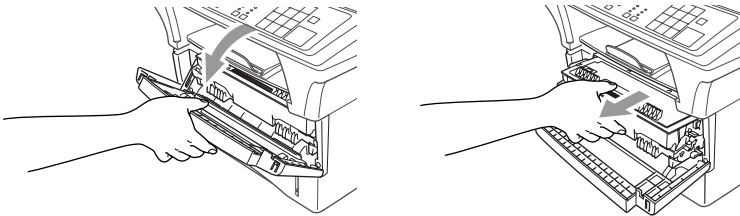

Place the drum unit on a drop cloth or large piece of disposable paper to avoid spilling and scattering the toner.

- 2 Hold down the lock lever on the right and pull the toner cartridge out of the drum unit assembly.

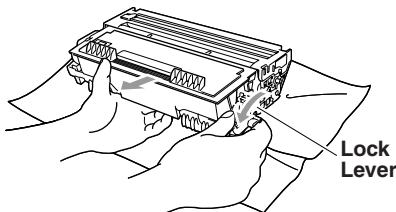

Caution

Handle the toner cartridge carefully. If toner scatters on your hands or clothes, immediately wipe it off or wash it with cold water.

- 3 Unpack the new toner cartridge. Place the used toner cartridge into the aluminum bag and discard it according to local regulations.

! Caution

- Wait to unpack the toner cartridge until immediately before you install it in the DCP. If a toner cartridge is left unpacked for a long period of time, the toner life is shortened.
 - You can use only a genuine Brother toner cartridge (**TN-430 or TN-460**), which is specially formulated to ensure top print quality. Using another brand of toner cartridge may void your DCP's warranty. Warranty coverage does not apply to problems caused by the use of 3rd party Toner, 3rd party Toner Cartridge or 3rd party Drum unit.
- 4 Gently rock the toner cartridge from side to side five or six times to distribute the toner evenly inside the cartridge.

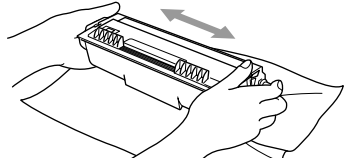

- 5 Remove the protective cover.

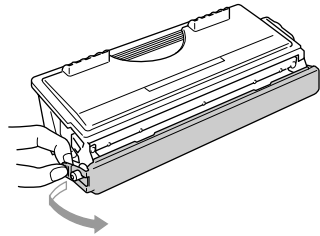

- 6 Insert the new toner cartridge in the drum unit until it clicks into place.

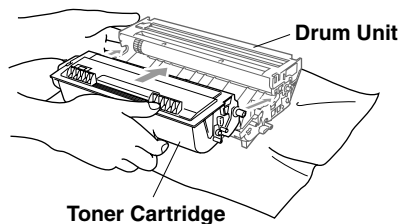

- 7 Clean the primary corona wire inside the drum unit by gently sliding the blue tab from right to left several times. Return the blue tab to the Home position (▼) before reinstalling the drum unit assembly.

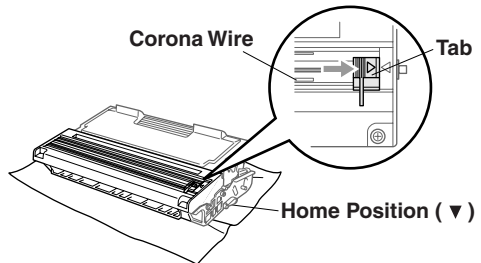

- 8 Reinstall the drum unit and close the front cover.

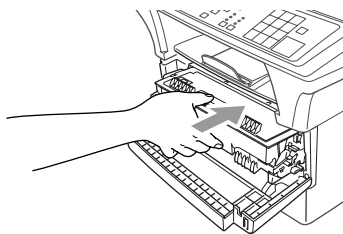

Replacing the Drum Unit

The DCP uses a drum unit to create print images on paper. If the LCD shows **CHANGE DRUM SOON**, the drum unit is near the end of its life and it is time to purchase a new one.

Even if the LCD shows **CHANGE DRUM SOON**, you may be able to continue printing without having to replace the drum unit for a while. However, if there is a noticeable deterioration in the output print quality (even before **CHANGE DRUM SOON** appears), then the drum unit should be replaced. You should clean the DCP when you replace the drum unit. (See page 14-16.)

! Caution

When removing the drum unit, handle it carefully because it contains toner. If toner scatters and your hands or clothes get dirty, immediately wipe it off or wash it with cold water.



The drum unit is a consumable item, and it is necessary to replace it periodically. There are many factors that determine the actual drum life, such as temperature, humidity, type of paper and how much toner you use for the number of pages per print job. The estimated drum life is *up to* 20,000 pages. The actual number of pages your drum will print may be significantly less than these estimates. Because we have no control over the many factors that determine the actual drum life, we cannot guarantee a minimum number of pages that will be printed by your drum.

! WARNING

Just after you have used the DCP, some internal parts of the DCP are extremely **HOT!** So please be careful.

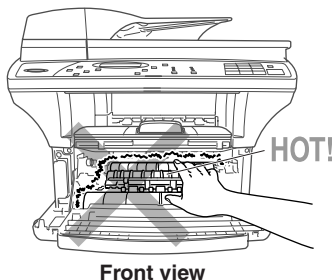

Follow these steps to replace the drum unit:

- 1 Open the front cover.
- 2 Remove the old drum unit. Place the drum unit on a drop cloth or disposable paper to avoid scattering toner.

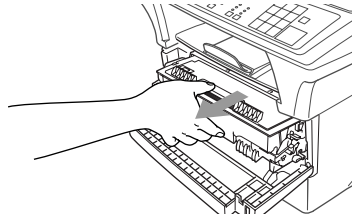

- 3 Hold down the lock lever on the right and pull the toner cartridge out of the drum unit assembly. (See *Replacing the Toner Cartridge*, page 14-16.)

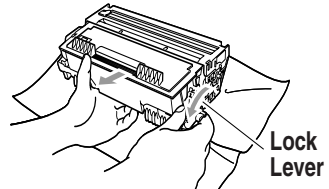

- 4 Discard the used drum unit according to local regulations. If you are not sure of them, call your local Sanitation Department. Be sure to seal the drum unit tightly so toner powder does not spill out of the unit. When discarding used drum units, keep them separate from domestic garbage.
- 5 Wait to unpack the new drum unit until immediately before installing it. Place the old drum unit into the aluminium bag and discard it according to local regulations.
- 6 Reinstall the toner cartridge into the new drum unit. (See *Replacing the Toner Cartridge*, page 14-16.)
- 7 Reinstall the new drum unit, keeping the front cover *open*.
- 8 Press **Clear Settings**.
- 8 Press **1** and when the LCD shows **ACCEPTED**, and close the front cover.

REPLACE DRUM?
1.YES 2.NO

! Caution

If toner scatters and your hands or clothes get dirty, immediately wipe it off or wash it with cold water.

15 Important Information

Regulations and warnings

These notices are in effect on models sold and used in the United States only.

If you experience trouble with DCP-1400, please contact a Brother Authorized Service Center for information on service or repair.

If you are not able to solve a problem with your multi-function center, contact Brother Customer Service. (See *Brother Numbers*, page i.)

WARNING

For protection against the risk of electrical shock, always disconnect all cables from the wall outlet before servicing, modifying or installing the equipment.

Laser Safety

This equipment is certified as a Class I laser product under the U.S. Department of Health and Human Services (DHHS) Radiation Performance Standard according to the Radiation Control for Health and Safety Act of 1968. This means that the equipment does not produce hazardous laser radiation.

Since radiation emitted inside the equipment is completely confined within protective housings and external covers, the laser beam cannot escape from the machine during any phase of user operation.

FDA Regulations

U.S. Food and Drug Administration (FDA) has implemented regulations for laser products manufactured on and after August 2, 1976. Compliance is mandatory for products marketed in the United States. The following label on the back of the machine indicates compliance with the FDA regulations and must be attached to laser products marketed in the United States.

Manufactured:

BROTHER CORP. (ASIA) LTD.

BROTHER BUJI NAN LING FACTORY

Gold Garden Industry, Nan Ling Village, Buji, Rong Gang, Shenzhen, China.

This product complies with FDA radiation performance standards,

21 CFR Subchapter J.



WARNING

Use of controls, adjustments or performance of procedures other than those specified in this manual may result in hazardous invisible radiation exposure.



Caution

Changes or modifications not expressly approved by Brother Industries, Ltd. may void the user's authority to operate the equipment.

Internal laser radiation

Max. Radiation Power 5 mW

Wave Length 760 - 810 nm

Laser Class Class IIIb (Accordance with 21 CFR Part 1040.10)

Federal Communications Commission (FCC) Declaration of Conformity (For USA Only)

Responsible Party: Brother International Corporation
100 Somerset Corporate Boulevard
Bridgewater, NJ 08807-0911 USA
TEL: (908) 704-1700

declares, that the products

Product Name: DCP-1400

comply with Part 15 of the FCC Rules. Operation is subject to the following two conditions: (1) This device may not cause harmful interference, and (2) this device must accept any interference received, including interference that may cause undesired operation.

This equipment has been tested and found to comply with the limits for a Class B digital device, pursuant to Part 15 of the FCC Rules. These limits are designed to provide reasonable protection against harmful interference in a residential installation. This equipment generates, uses, and can radiate radio frequency energy and, if not installed and used in accordance with the instructions, may cause harmful interference to radio communications. However, there is no guarantee that interference will not occur in a particular installation. If this equipment does cause harmful interference to radio or television reception, which can be determined by turning the equipment off and on, the user is encouraged to try to correct the interference by one or more of the following measures:

- Reorient or relocate the receiving antenna.
- Increase the separation between the equipment and receiver.

Connect the equipment into an outlet on a circuit different from that to which the receiver is connected.

Consult the dealer or an experienced radio/TV technician for help.

Important

Changes or modifications not expressly approved by Brother Industries, Ltd. could void the user's authority to operate the equipment.

Industry Canada Compliance Statement (For Canada Only)

This Class B digital apparatus complies with Canadian ICES-003.

Cet appareil numérique de la classe B est conforme à la norme NMB-003 du Canada.

Important – About the Interface Cable

A shielded interface cable should be used to ensure compliance with the limits for a Class B digital device.

Warranty

You must use the IEEE-1284 shielded parallel cable provided by Brother Industries, Ltd. (See *Ordering Accessories and Supplies*, page ii)

International ENERGY STAR® Compliance Statement

As an ENERGY STAR® Partner, Brother Industries, Ltd. has determined that product meets the ENERGY STAR® guidelines for energy efficiency.



Important Safety Instructions

- 1** Read all of these instructions.
- 2** Save them for later reference.
- 3** Follow all warnings and instructions marked on the product.
- 4** Unplug this product from the wall outlet before cleaning. Do not use liquid or aerosol cleaners. Use a damp cloth for cleaning.
- 5** Do not place this product on an unstable cart, stand, or table. The product may fall, causing serious damage to the product.
- 6** Slots and openings in the cabinet and the back or bottom are provided for ventilation. To ensure reliable operation of the product and to protect it from overheating, these openings must not be blocked or covered. The openings should never be blocked by placing the product on a bed, sofa, rug, or other similar surface; near or over a radiator or heater; or in a built-in wall unit or cabinet without ventilation.
- 7** This product should be operated from the type of power source indicated on the label. If you are not sure of the type of power available, consult your dealer or local power company.
- 8** Use only the power cord supplied with this machine.
- 9** This product is equipped with a 3-wire grounding type plug, a plug having a third (grounding) pin. This plug will fit into only a grounding-type power outlet. This is a safety feature. If you are unable to insert the plug into the outlet, contact your electrician to replace your obsolete outlet. Do not defeat the purpose of the grounding-type plug, by using an adapter.
- 10** Do not allow anything to rest on the power cord. Do not place this product where people can walk on the cord.
- 11** If an extension cord is used with this product, make sure that the total ampere ratings on the products plugged into the extension cord do not exceed the extension cord ampere rating. The total of all products plugged into the wall outlet must not exceed 15 amperes (USA only).
- 12** Never push objects of any kind into this product through cabinet slots, since they may touch dangerous voltage points or short out parts resulting in the risk of fire or electric shock. Never spill liquid of any kind on the product.
- 13** This product must be installed near a power outlet that is easily accessible. In case of emergencies, you must disconnect the power cord from the power outlet in order to shut off power completely.

- 14** Unplug this product from the wall outlet and refer servicing to a Brother Authorized Service Center under the following conditions:
- A** When the power cord is damaged or frayed.
 - B** If liquid has been spilled into the product.
 - C** If the product has been exposed to rain or water.
 - D** If the product does not operate normally when the operating instructions are followed. Adjust only those controls that are covered by the operating instructions. Improper adjustment of other controls may result in damage and will often require extensive work by a qualified technician to restore the product to normal operation.
 - E** If the product has been dropped or the cabinet has been damaged.
 - F** If the product exhibits a distinct change in performance, indicating a need for service.
- 15** Do not attempt to service this product yourself, as opening or removing covers may expose you to dangerous voltage points and/or other risks, and may void your warranty. Refer all servicing to a Brother Authorized Service Center. A list of Brother Authorized Service Centers has been included for your convenience, or you may contact Brother Customer Service numbers for your nearest Brother Authorized Service Center. (See *Brother Numbers*, page i.)
- 16** To protect your product against power surges, we recommend the use of a power protection device (Surge Protector).
- 17** When using your DCP basic, safety precautions should always be followed to reduce the risk of fire, electric shock and injury to persons, including the following:
- Do not use this product near appliances that use water, a swimming pool or in a wet basement.
 - Use only the power cord indicated in this manual.
- 18** Brother cannot accept any financial or other responsibilities that may be the result of your use of this information, including direct, special or consequential damages. There are no warranties extended or granted by this document.

Trademarks

Brother is a registered trademark of Brother Industries, Ltd.

The Brother logo is a registered trademark of Brother Industries, Ltd.

Multi-Function Link is a registered trademark of Brother Industries, Ltd.

© Copyright 1996–2001 Brother Industries, Ltd. All rights reserved.

TextBridge and PaperPort are registered trademarks of ScanSoft, Inc.

Windows and Windows NT, Microsoft, MS-DOS, Excel and Word are registered trademarks of Microsoft in the U.S. and other countries.

NT is a trademark of Northern Telecom Limited.

Macintosh and Quick Draw are registered trademarks and iMac, iBook and TrueType are trademarks of Apple Computer, Inc.

Centronics is a trademark of Genicom Corporation.

Epson is a registered trademark and FX-80 and FX-850 are trademarks of Seiko Epson Corporation.

Hewlett Packard is a registered trademark and HP LaserJet II, IIP, and IID are trademarks of Hewlett-Packard Company.

IBM, IBM PC, and Proprinter are registered trademarks of International Business Machines Corporation.

Hammermill copyplus white is a registered trademark of International Paper.

All other terms and brand and product names mentioned in this manual are registered trademarks of their respective companies.

Glossary

- ADF (Automatic Document Feeder)** Originals can be placed in the ADF and scanned one at a time automatically.
- Automatic E-Mail Printing** Software application that automatically prints incoming e-mail messages on the DCP. (Instructions are on the CD-ROM).
- beeper volume** Volume setting for the beep when you press a key or make an error.
- Brother Control Center** A window that enables you to click on a button to choose the type of scanning operation you want to perform. If you set up the Control Center window to load each time you boot your PC, this window will appear each time you place an original in the ADF.
- Brother Resource Manager** The Brother Resource Manager application must be running for you to use your DCP with your Windows® computer. Multi-Function Link® Pro Suite software and the MFL Pro Suite Printer Driver automatically load the Resource Manager, as needed. The Resource Manager allows the single bi-directional Parallel port on the machine to simulate a Communications port for scanning and to simulate a Parallel port for Windows® GDI printing.
- Contrast** A setting that compensates for dark or light originals, by lightening dark documents or darkening light originals.
- gray scale** The shades of gray available for copying photographs.
- LCD (liquid crystal display)** The display screen on the DCP that shows interactive messages during On-Screen Programming and defaults to the date and time when the DCP is idle.
- Menu mode** Programming mode for changing the settings of your DCP.
- Multi-Function Link® Pro Suite software** Turns your DCP into a printer and a scanner and enables PC faxing using the DCP.
- OCR (optical character recognition)** The bundled ScanSoft® TextBridge® software application converts an image of text to text that you can edit.
- Photo** A copy mode resolution setting that uses varying shades of gray for the best representation of photographs.
- scanning** The process of sending an electronic image of an original paper document into your computer.
- ScanSoft® PaperPort® for Brother** Document management application where you can view received faxes and scanned originals.
- ScanSoft® TextBridge®** Optional Character Recognition (OCR) software that converts a scanned image of text into text you can edit in your word processing application.
- temporary settings** You can select certain options for each copy you make without changing the default settings. Temporary copy settings remain for 45 seconds after copying so you won't have to set them again for additional copies.
- TrueType fonts** The fonts that are used in the Windows® operating systems. If you install the Brother TrueType fonts, more types of fonts will be available for Windows® applications.

S Specifications

Product Description

Three performance modes are available for the 3in1 model DCP-1400: Copier, Scanner and Printer.

Paper

Paper Specifications for the Cassette

Cut Sheet	
Basis Weight:	16 to 28 lb. (60 to 105 g/m ²)
Caliper:	0.003 to 0.005 inches. (0.08 to 0.13 mm)
Moisture Content:	4% to 6% by weight

Manual Feed Slot

	Cut Sheet	Envelopes
Basis Weight:	16 to 43 lb. (60 to 161 g/m ²)	20 to 24 lb. (75 to 90 g/m ²)
Caliper:	0.003 to 0.008 inches. (0.08 to 0.2 mm)	0.003 to 0.005 inches. (0.084 to 0.14 mm)
Moisture Content:	4% to 6% by weight	4% to 6% by weight

Scanner

Document Size	ADF Width: 5.8" to 8.5" (148 mm to 216 mm) ADF Length: 2.75" to 8.5" (70 mm to 216 mm) Scanner Width: Max. 8.5" (216 mm) Scanner Length: Max. 11.7" (297 mm)
Resolution	Up to 9,600 × 9,600 (interpolated) Up to 600 × 2,400 (optical)
Scanning/Printing Width	8.2 inches (208 mm)
Automatic Document Feeder (ADF)	Up to 50 sheets (26.4 lbs)

Consumable Items

Toner cartridge Life Expectancy:

Up to 6,000 pages/*high yield* toner cartridges

Up to 3,000 pages/*standard* toner cartridges

(when printing letter size or A4 paper at 5% print coverage)



Toner life expectancy will vary depending upon the type of average print job.

Drum Unit Life Expectancy: up to 20,000 pages



There are many factors that determine the actual drum life, such as temperature, humidity, type of paper, toner you use and number of pages per print job.

Electrical and Environment

Temperature	Operating 50 - 90.5° F (10 - 32.5° C) Storage 32 - 104° F (0 - 40° C)
Humidity	Operating: 20 to 80% (without condensation) Storage: 20 to 80% (without condensation)
Warm-Up	Max. 25 seconds at 73.4° F (23° C)
First Print	15 seconds (using Letter size paper in multi-purpose sheet feeder)
Power Source	120V AC 50/60Hz (USA, Canadian Version Only)
Power Consumption	Average Operating (Copying): 350 W (25° C) Peak: 940 W Sleep Mode: 15 W or less Stand by: 75 W or less (25° C)
Noise	Operating: 53 dB A or less Stand by: 30 dB A or less
Dimensions	19.4 × 18 × 16.9 inches (492 × 456 × 429 mm)
Weight	35.2 lbs/(17 kg) (Without Carton)

Printer

Emulation	Brother Printing System for Windows® and emulation mode of HP LaserJet IIP (PCL level 4)
Printer Driver	Windows® 95/98/98SE/Me/2000 and Windows NT® Workstation Version 4.0 driver supporting Brother Native Compression mode and bi-directional capability Apple® Macintosh® QuickDraw® Driver for OS 8.5/8.51/8.6/9.0/9.0.4/9.1
Interface	Bi-directional parallel (IEEE-1284); USB (Universal Serial Bus) 1.1
Memory Capacity	8 MB
Print Method	Electrophotography by semiconductor laser beam scanning
Resolution	600 dots/inch
Print Quality	Normal printing mode Economy printing mode (saves up to 50% of the normal toner usage)
Print Speed	Up to 15 pages/minute (when loading letter size paper from paper cassette)

TrueType Fonts on CD-ROM

35 TrueType compatible soft-fonts for Windows® on the bundled CD-ROM.

Computer Requirements

Minimum System Requirements					
Computer Platform & Operating System Version		Processor Minimum Speed	Minimum RAM	Recommended RAM	Available Hard Disk Space
Windows® Operating Systems	95, 98, 98SE	Pentium 75MHz	24MB	32MB	50MB
	Me	Pentium 150MHz	32MB	64MB	
	NT® Workstation 4.0	Pentium 75MHz			
	2000 Professional	Pentium 133MHz	64MB	128MB	
	XP*	Pentium 233MHz			
Apple iMac™/iBook™/ G3/G4 Operating Systems	OS 8.5 – 8.51 (Printing Only)	All base models meet minimum requirements			50MB
	OS 8.6 – 9.2 (Printing and Scanning)				
	Mac OS X v.10/10.1 (Printing Only) †				
<p>NOTE: USB is not supported under Windows® 95 or Windows NT® 4.0</p> <p>All registered trademarks referenced herein are the property of their respective companies.</p> <p>* Printer Driver and Scanner Driver can be downloaded from http://solutions.brother.com</p> <p>† Printer Driver can be downloaded from http://solutions.brother.com</p>					

Parallel Interface

Interface Connector Printer Side: Amphenol FCN-685J036-L/X or equivalent
A shielded cable should be used.

Pin Assignment

Pin No.	Signal	Direction	Pin No.	Signal	Direction
1	DATA STROBE	Input	19	0V(S.G.)	-
2	DATA 1	Input	20	0V(S.G.)	-
3	DATA 2	Input	21	0V(S.G.)	-
4	DATA 3	Input	22	0V(S.G.)	-
5	DATA 4	Input	23	0V(S.G.)	-
6	DATA 5	Input	24	0V(S.G.)	-
7	DATA 6	Input	25	0V(S.G.)	-
8	DATA 7	Input	26	0V(S.G.)	-
9	DATA 8	Input	27	0V(S.G.)	-
10	$\overline{\text{ACKNLG}}$	Output	28	0V(S.G.)	-
11	BUSY	Output	29	0V(S.G.)	-
12	PE	Output	30	0V(S.G.)	-
13	SLCT	Output	31	$\overline{\text{INPUT PRIME}}$	Input
14	$\overline{\text{AUTO FEED}}$	Input	32	$\overline{\text{FAULT}}$	Output
15	N.C.	-	33	N.C.	-
16	0V (S.G.)	-	34	N.C.	-
17	0V (S.G.)	-	35	N.C.	-
18	+5V	-	36	$\overline{\text{SLCT IN}}$	Input

USB (Universal Serial Bus) Interface

Pin Assignment

Pin No.	Signal
1	Vol (+5V)
2	- Data Serial Data -
3	+ Data Serial Data +
4	Ground

TrueType Fonts on CD-ROM

35 TrueType compatible soft-fonts for Windows® on the bundled CD-ROM.

Resident Fonts

The following bitmapped fonts are resident in the DCP.

Brougham 10 (12 point)	upright/normal
Brougham 12 (10 point)	upright/normal
Letter Gothic 16.66 (8.5 point)	upright/normal

(Portrait and Landscape are available for the above.)

Symbol Sets/Character Sets

*HP mode

- ISO14 JIS ASCII
- ISO57 Chinese
- ISO11 Swedish
- HP Spanish
- ISO17 Spanish
- ISO10 Swedish
- ISO16 Portuguese
- ISO84 Portuguese
- ISO85 Spanish
- PC-8
- PC-8 D/N
- PC-8 Turkish
- PC-850
- PC-852
- PC-860
- PC-865
- Roman 8
- ISO Latin 1
- (ECMA-94)
- ISO60 Norwegian 1
- ISO61 Norwegian 2
- ISO4 UK
- ISO25 French
- ISO69 French
- HP German
- ISO21 German
- ISO15 Italian
- ISO6 ASCII
- Legal
- ISO2 IRV
- PC-863



If you want to know which characters are in each symbol/character set, print the CHARSETS.PRN file from “The Print Form” option in the Direct Access Menu of the Remote Printer Console Program.

□ HP LaserJet IIP

Roman 8										ISO Latin1																					
0	1	2	3	4	5	6	7	8	9	A	B	C	D	E	F	0	1	2	3	4	5	6	7	8	9	A	B	C	D	E	F
	0	@	P	'	p					À	Á	Â	Ã	Ä	Å	0	0	@	P	'	p						±	±	±	±	±
1		1	A	Q	a	q				Ã	Ä	Å	Ö	Ø	·	1		1	A	Q	a	q					±	±	±	±	±
2		"	2	B	R	b	r			È	É	Ê	Ë	Ì	Í	2		"	2	B	R	b	r				±	±	±	±	±
3		#	3	C	S	c	s			Ë	Ê	Ë	Ì	Í	Î	3		#	3	C	S	c	s				±	±	±	±	±
4		\$	4	D	T	d	t			Ê	Ë	Ì	Í	Î	Ï	4		\$	4	D	T	d	t				±	±	±	±	±
5		%	5	E	U	e	u			Ï	Î	Ï	Ñ	Ò	Ó	5		%	5	E	U	e	u				±	±	±	±	±
6		&	6	F	V	f	v			Ñ	Ò	Ó	Ô	Õ	Ö	6		&	6	F	V	f	v				±	±	±	±	±
7		'	7	G	W	g	w			Ò	Ó	Ô	Õ	Ö	×	7		'	7	G	W	g	w				±	±	±	±	±
8		(8	H	X	h	x			Ó	Ô	Õ	Ö	×	÷	8		(8	H	X	h	x				±	±	±	±	±
9)	9	I	Y	i	y			Ô	Õ	Ö	×	÷	¸	9)	9	I	Y	i	y				±	±	±	±	±
A		*	:	J	Z	j	z			Õ	Ö	×	÷	¸	¸	A		*	:	J	Z	j	z				±	±	±	±	±
B		+	;	K	[k	{			Ö	×	÷	¸	¸	¸	B		+	;	K	[k	{				±	±	±	±	±
C		<	<	L	\	l				×	÷	¸	¸	¸	¸	C		<	<	L	\	l					±	±	±	±	±
D		-	=	M]m					÷	¸	¸	¸	¸	¸	D		-	=	M]m						±	±	±	±	±
E		.	>	N	^	n	-			¸	¸	¸	¸	¸	¸	E		.	>	N	^	n	-				±	±	±	±	±
F		/	?	O	_	o	¸			¸	¸	¸	¸	¸	¸	F		/	?	O	_	o	¸				±	±	±	±	±

The following table shows characters available only in the corresponding character set. The numbers at the top of the table are code values with which characters are to be replaced in the Roman 8 character set. For other characters, see character set of Roman 8.

SYMBOL SET	23	24	40	5B	5C	5D	5E	60	7B	7C	7D	7E
ISO2 IRV	#	□	@	[\]	^	~	{		}	—
ISO4 UK	E	\$	@	[\]	^	~	{		}	—
ISO6 ASCII	#	\$	@	[\]	^	~	{		}	—
ISO10 Swedish	#	□	@	Ä	Ö	Å	Ä	Ö	ä	ö	å	—
ISO11 Swedish	#	□	É	Ä	Ö	Å	Ü	é	ä	ö	å	ü
ISO14 JIS ASCII	#	\$	@	[v]	^	~	{		}	—
ISO15 Italian	E	\$	§	·	ç	é	è	ù	à	ò	è	ì
ISO16 Portuguese	#	\$	§	À	Ç	Õ	·	·	ã	ç	õ	·
ISO17 Spanish	E	\$	§	ı	Ñ	¿	·	·	ñ	ç	·	·
ISO21 German	#	\$	§	Ä	Ö	Ü	·	·	ä	ö	ü	ß
ISO25 French	E	\$	à	·	ç	§	·	·	é	ù	è	·
ISO57 Chinese	#	¥	@	{	\	}	·	·	{		}	—
ISO60 Norwegian1	#	\$	@	Æ	Ø	Å	·	·	æ	ø	å	—
ISO61 Norwegian2	§	\$	@	Æ	Ø	Å	·	·	æ	ø	å	
ISO69 French	E	\$	à	·	ç	§	·	·	é	ù	è	·
ISO84 Portuguese	#	\$	·	À	Ç	Õ	·	·	ã	ç	õ	·
ISO85 Spanish	#	\$	·	ı	Ñ	Ç	¿	·	ñ	ç	·	·
HP German	E	\$	§	Ä	Ö	Ü	·	·	ä	ö	ü	ß
HP Spanish	#	\$	@	ı	Ñ	¿	·	·	{	ñ	}	—

Index

A

- accessories and supplies ii
- assembly and connections 2-4
 - drum unit assembly 2-4
 - loading paper 2-6
 - power cord and 3-prong plug 2-8
 - scanner lock 2-3

B

- Brother
 - accessories and supplies ii
 - Customer Service i
 - fax-back system i
 - Frequently Asked Questions (FAQs) i
 - product support i
 - warranties
 - Canada vi
 - Notice-Disclaimer of Warranties iii
 - USA iv
- Brother Control Center
 - using and configuring 9-1 to 9-14

C

- cleaning (routine maintenance)
 - drum unit 14-16
 - printer 14-15
 - scanner 14-14
- computer requirements S-4
- connections
 - parallel 2-1, 7-1, S-5
 - USB 2-1, 12-1, S-5
- control panel 1-2
- copying 5-1
 - 2 in 1 5-8
 - 4 in 1 5-8
- contrast 5-6
- Copy Mode 5-7
- default settings 5-9
- enlarging 5-4
- multiple 5-1, 5-2

- photographs 5-9
 - poster 5-8
 - quality 14-6
 - reducing 5-4
 - resolution (Copy Mode) 5-5
 - scannable area 5-1
 - single 5-1
 - sort 5-5
 - temporary settings 5-3
 - using ADF 5-1
 - using scanner glass 5-2
- Customer Service i

D

- DOS 6-1
- driver
 - Macintosh
 - printers 12-1
 - scanner 12-3
- drivers
 - Macintosh®
 - printer 12-1
 - Windows®
 - printer 7-1, 8-1
 - scanner 10-4
- drum unit
 - replacing 14-19

E

- envelopes
 - printing 2-7
 - sizes 2-5
- error messages on LCD 14-1
 - CHECK PAPER 14-1
 - OUT OF MEMORY 5-2, 14-2

J

- jams
 - paper 14-5

L

LCD (Liquid Crystal Display) 3-1

M

Macintosh® G3, G4 or iMac™ 12-1
maintenance, routine 14-1, 14-14
manual feed slot 2-5, 2-7
multi-purpose sheet feeder 2-5, 2-6

O

OCR (ScanSoft™ TextBridge®) 10-1
Options key 5-5

P

packing list 2-1
paper
 jams 14-4
 loading 2-6
 size and specifications 2-5, 4-1
printing 7-1
 density 4-2
 difficulties 14-6 to 14-10
 driver 7-1
 E-mail 11-1
 emulation
 Macintosh® 12-1
 Windows® 7-1
 envelopes 2-7
 jams
 original 14-3
 paper 14-3
 manual feed slot 2-7, 7-3
 PC software settings 7-1
 Reset key (clear printer memory) 7-7
 resolution S-3
 specifications S-1
 speed S-3
 thicker paper and card stock 7-5
 transparencies 7-3
 two-sided (manual duplexing) 7-2
programming at-a-glance 3-1
 default settings 3-2

temporary settings 3-4

R

remote printer console 7-1
resolution
 print S-3
 scan 10-5

S

safety instructions 15-4
scanner drivers
 Macintosh® 12-3
 Windows® 10-1
Scanner Lock 2-3, 14-11
scanning (Windows®)
 Scan Image 9-3
 Scan to E-mail 9-3
 Scan/OCR 9-3
shipping the machine 14-11
simultaneous printing/copying/scanning 7-6
software (Macintosh®)
 Prescanning into Macintosh 12-7
 printing with Brother driver 12-1
 scanner settings 12-5
 scanning with Brother TWAIN driver 12-3
software (Windows®)
 Brother Control Center 9-1
 for DOS users 6-1
 PaperPort® for Brother 10-1
 exporting an image file 10-4
 prescanning an image 10-7
 scanning into PC 10-4, 10-5
 uninstall 10-1
 viewing files 10-2
ScanSoft™ TextBridge® OCR 10-1

T

- toner cartridge
 - replacing 14-16, 14-17
 - Toner Save 4-2
- transparencies 2-7
- troubleshooting 14-1
 - difficulties with machine 14-6
 - copy quality 14-6
 - DOS setup 14-8
 - paper handling 14-8
 - printing 14-6, 14-9
 - scanning 14-6
 - software 14-7
 - error messages on LCD 14-1
 - jams 14-3 to 14-5
 - machine 14-1 to 14-2

V

- volume, setting
 - beeper 4-1

W

- warranties
 - Canada vi
 - Notice of Disclaimer iii
 - USA iv
- World Wide Web i



Brother International Corporation
100 Somerset Corporate Boulevard
P.O. Box 6911
Bridgewater, NJ 08807-0911 USA

Brother International Corporation (Canada) Ltd.
1 rue Hôtel de Ville,
Dollard-des-Ormeaux, QC, CANADA H9B 3H6

Visit us on the World Wide Web
<http://www.brother.com>

These machines are made for use in the USA and CANADA only. We cannot recommend using them overseas because the power requirements of your Digital Copier/Printer may not be compatible with the power available in foreign countries. **Using USA or CANADA models overseas is at your own risk and will void your warranty.**

Free Manuals Download Website

<http://myh66.com>

<http://usermanuals.us>

<http://www.somanuals.com>

<http://www.4manuals.cc>

<http://www.manual-lib.com>

<http://www.404manual.com>

<http://www.luxmanual.com>

<http://aubethermostatmanual.com>

Golf course search by state

<http://golfingnear.com>

Email search by domain

<http://emailbydomain.com>

Auto manuals search

<http://auto.somanuals.com>

TV manuals search

<http://tv.somanuals.com>