

Before you can use the MFC, you must set up the hardware and install the driver. To help you get started in setting up the machine and installing the driver and software, please read this "Quick Setup Guide" for proper set up and installation instructions.

### Step 1



## Setting Up the Machine

### Step 2



## Installing the Driver & Software



## Setup is Complete!

For the latest drivers and to find the best solution for your problem or question, access the Brother Solutions Center directly from the driver or go to <http://solutions.brother.com>. Keep this "Quick Setup Guide", User's Guide and supplied CD-ROM in a convenient place for quick and easy reference at all times.

Setting Up  
the Machine

Windows®  
USB

Windows®  
Parallel

Windows  
NT® 4.0  
Parallel

Installing the Driver & Software

Windows®  
Network



Macintosh®  
USB

Macintosh®  
Network

For  
Administrators

# Getting Started

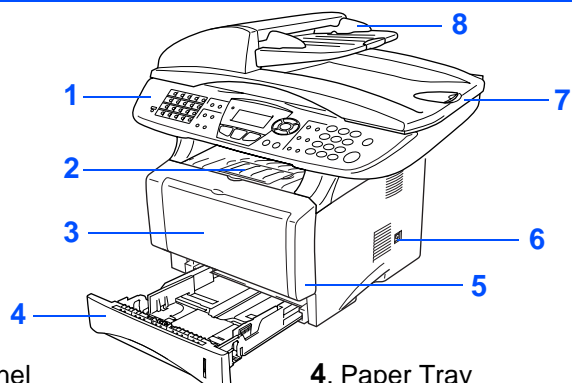
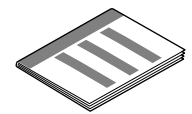
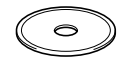
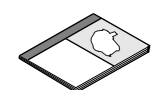
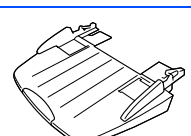
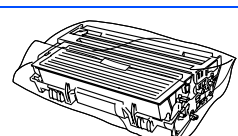
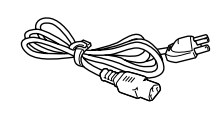
## Carton Components

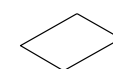
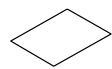
<b>MFC</b>  <b>1. Control Panel</b> <b>2. Face-down Output Tray Support Flap with Extension (Support Flap)</b> <b>3. Multi-purpose Tray (MP Tray)</b> <b>4. Paper Tray</b> <b>5. Front Cover</b> <b>6. Power Switch</b> <b>7. Document Cover</b> <b>8. Automatic Document Feeder (ADF)</b>		 <b>Quick Setup Guide</b>	
		 <b>CD-ROM</b>	
		 <b>User's Guide</b>	
 <b>ADF Support</b>	 <b>Drum Unit Assembly</b> (including Toner Cartridge)	 <b>AC Power Cord</b>	
 <b>Telephone Line Cord</b>	 <b>USB Cable</b>	 <b>Test Sheet</b> (USA only)	 <b>Accessory Order Form</b>

Carton components may differ from one country to another.  
Save all packing materials and the carton.



- *The parallel cable is not a standard accessory.*
- *For Parallel use a bi-directional shield interface cable that is IEEE 1284-compliant, and not longer than 6 feet (2 meters).*
- *For USB: use a Hi-Speed USB 2.0 interface cable that is not longer than 6 feet (2 meters).*
- *Please make sure that you use a Hi-Speed USB 2.0 certified cable if your computer uses a Hi-Speed USB 2.0 interface.*
- *Even if your computer has a USB 1.1 interface, you can connect the MFC.*

### **Warning**

When you move the MFC, grasp the side handholds that are under the scanner. Do NOT carry the MFC by holding it at the bottom.

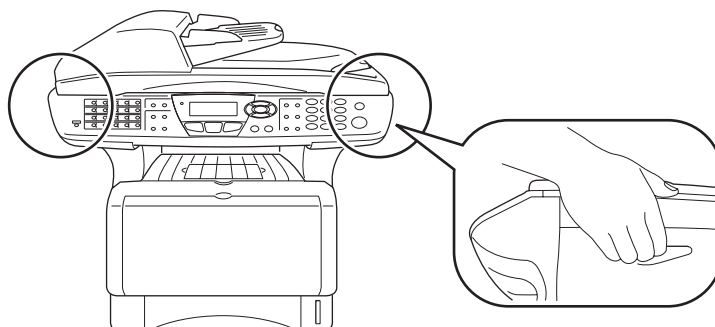



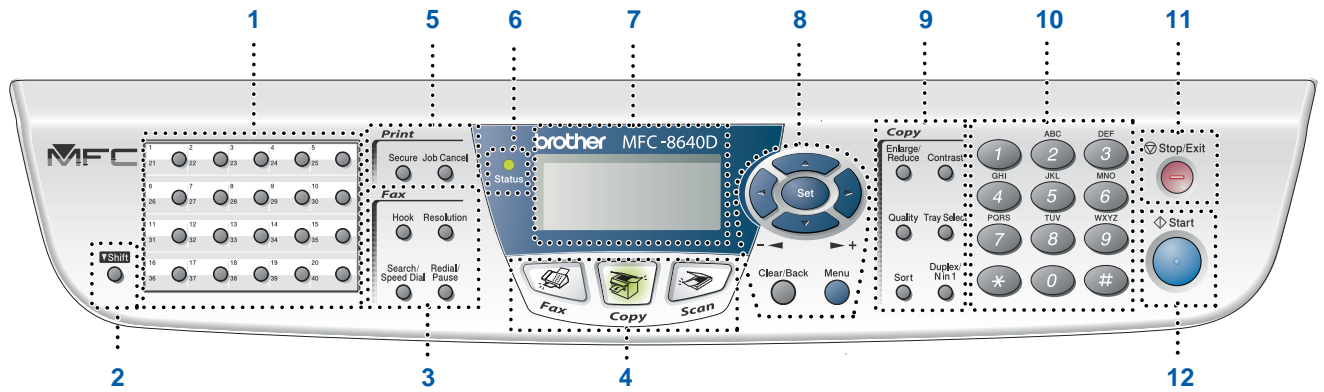

# Control Panel



1. One Touch keys	5. Print keys	9. Copy keys (Temporary Settings)
2. Shift	6. Status LED (Light-Emitting Diode)	10. Dial Pad
3. Fax and telephone keys	7. 5-Line Liquid Crystal Display (LCD)	11. Stop/Exit
4. Mode keys	8. Navigation keys	12. Start



For the details of the control panel, see "Control panel overview" in Chapter 1 of the User's Guide.

 <p><b>Warning</b></p> <p>Indicates warnings that must be observed to prevent possible personal injury.</p>	 <p><b>Hint</b></p> <p>Indicates cautions that must be observed to use the MFC properly or to prevent damage to the MFC.</p>	 <p><b>Hint</b></p> <p>Indicates notes and useful tips to remember when using the MFC.</p>	 <p><b>User's Guide</b></p> <p>Indicates reference to the User's Guide.</p>
--	---	---	--

# Table of Contents

## Step 1

## Setting Up the Machine

1. Install the Automatic Document Feed (ADF) Support .....	4
2. Install the Drum Unit Assembly .....	4
3. Load Paper in the Paper Tray .....	5
4. Release the Scanner Lock.....	6
5. Install the Power Cord and Phone Line .....	7
6. Selecting a Receive Mode .....	8
7. Setting the Date and Time .....	9
8. Setting Your Station ID .....	10
9. Selecting Your Language (Canada Only).....	11
10. Sending in the Product Registration and Test Sheet (USA Only) .....	11

## Step 2

## Installing the Driver & Software

Windows®

Supplied CD-ROM "MFL-Pro Suite" .....	12
For USB Interface Cable Users	
(For Windows® 98/98SE/Me/2000 Professional/XP).....	14
■ For Windows® 98/98SE/Me Users Only .....	16
■ For Windows® 2000 Professional Users Only.....	17
■ For Windows® XP Users Only .....	20
For Parallel Interface Cable Users	
(For Windows® 98/98SE/Me/2000 Professional/XP).....	23
■ For Windows® 98/98SE/Me Users Only .....	25
■ For Windows® 2000 Professional Users Only.....	26
■ For Windows® XP Users Only .....	30
For Windows NT® Workstation Version 4.0 Users .....	33
For Network Interface Cable Users	
(For Windows® 98/98SE/Me/NT/2000 Professional/XP).....	35

Macintosh®

For USB Interface Cable Users.....	38
■ For Mac OS® 8.6 to 9.2 .....	38
■ For Mac OS® X 10.1/10.2.1 or greater.....	40
For Network Interface Cable Users .....	42
■ For Mac OS® 8.6 to 9.2 .....	42
■ For Mac OS® X 10.1/10.2.1 or greater.....	44

## ■ For Administrators

Network User's Guide Chapter Map (NC-9100h) .....	46
Installing the BRAdmin Professional Configuration Utility (Windows® Users Only) .....	47
Setting your IP Address, Subnet Mask and Gateway using BRAdmin Professional (Windows® Users Only).....	48
Options .....	49
Replacement Consumables.....	49

# Step 1

# Setting Up the Machine

## 1 Install the Automatic Document Feed (ADF) Support

 Do NOT connect the interface cable. Connecting the interface cable is done when installing the driver.

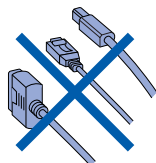

- 1 Open the ADF cover.

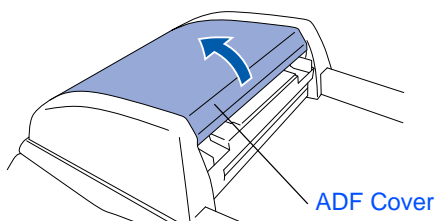

- 2 Insert the tabs of ADF support into the holes of the ADF one side at a time.

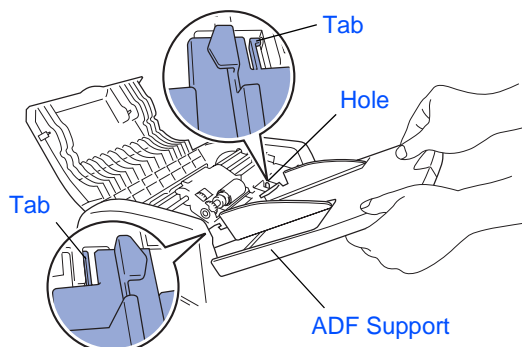

- 3 Push ADF Support down until it latches in place.

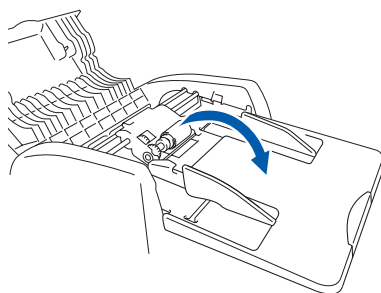

- 4 Close the ADF cover.

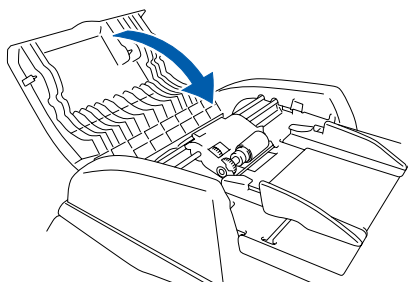

## 2 Install the Drum Unit Assembly

- 1 Open the front cover by pressing the front cover release button.

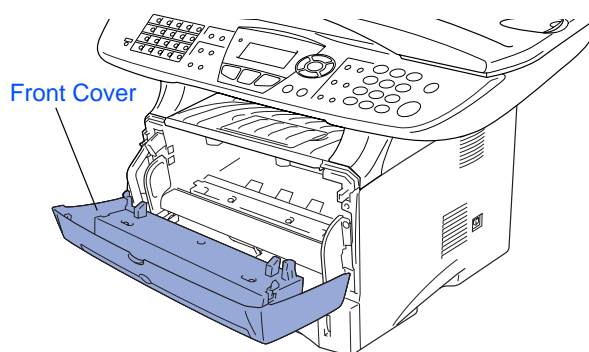
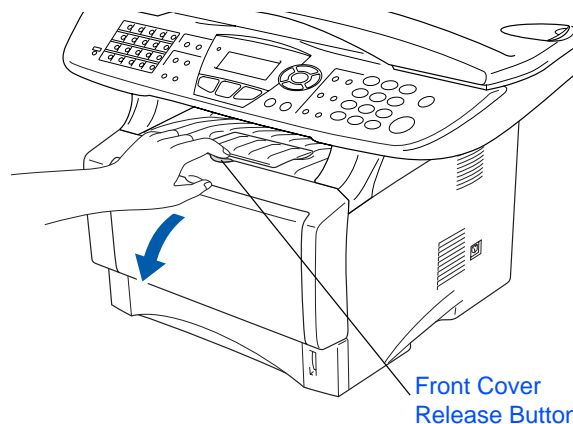

- 2 Unpack the drum unit assembly. Remove the protective part.

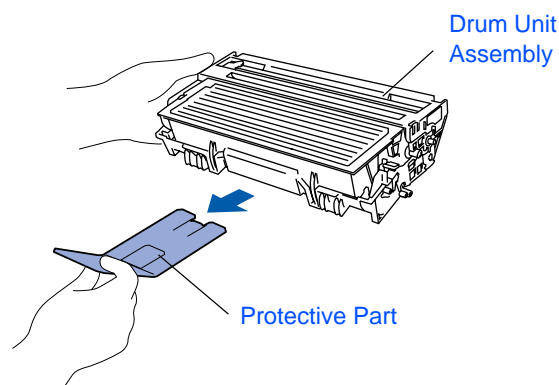

- 3 Rock it from side to side several times to distribute the toner evenly inside the assembly.

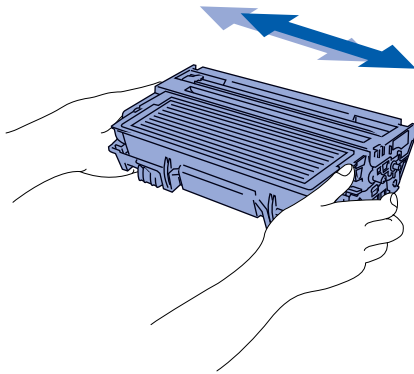

- 4 Push the drum unit assembly into the machine (until it snaps into place).

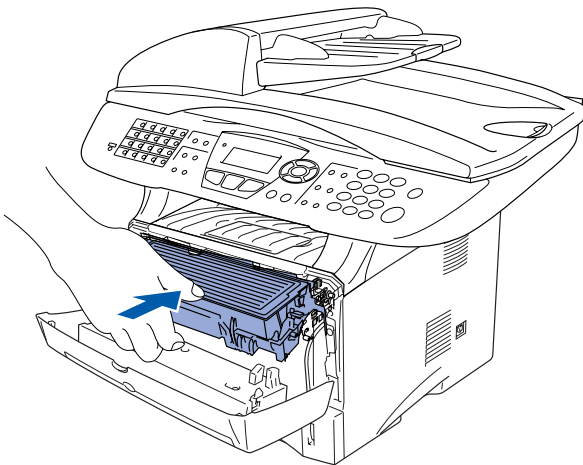

- 5 Close the front cover of the machine.

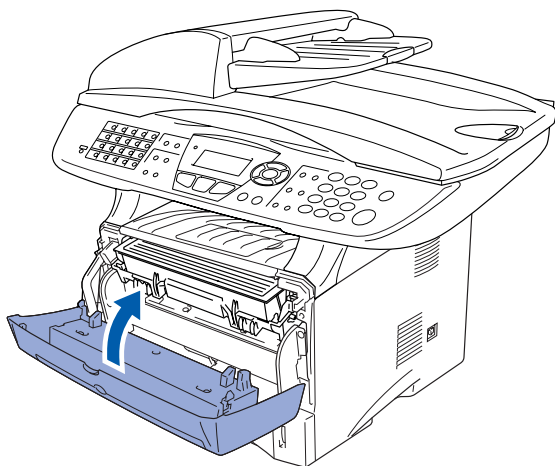

## 3 Load Paper in the Paper Tray

- 1 Pull the paper tray completely out of the machine.

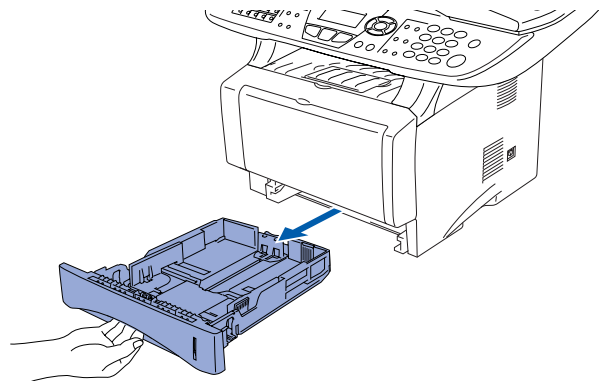

- 2 While pressing the paper guide release lever, slide the adjusters to fit the paper size. Check that the guides are firmly in the slots on the tray.

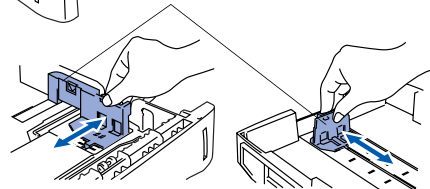
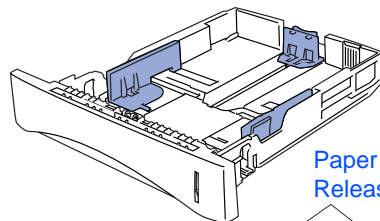

*For Legal size paper, press the universal guide release button and pull out the rear of the paper tray.*

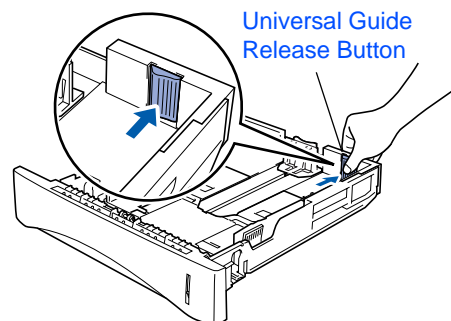

# Step 1

## Setting Up the Machine

- 3 Fan the stack of paper well to avoid paper jams and misfeeds.

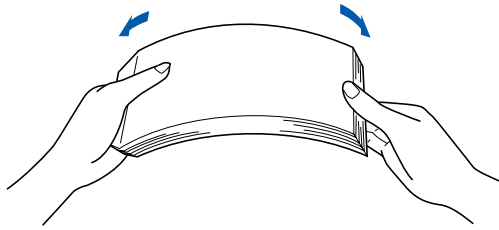

- 4 Put paper in the paper tray. Check that the paper is flat in the tray and below the maximum paper mark.

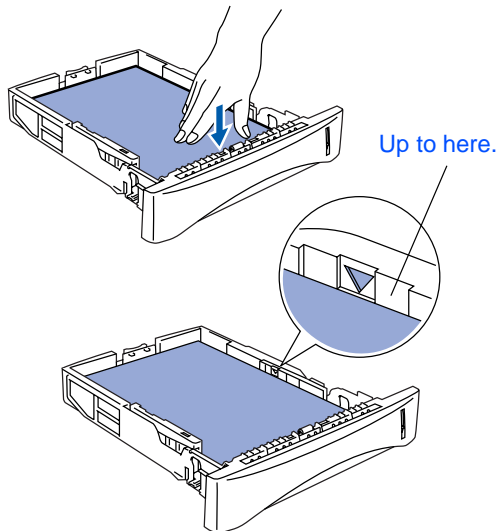

- 5 Put the paper tray firmly back in the machine and unfold the support flap before you use the machine.

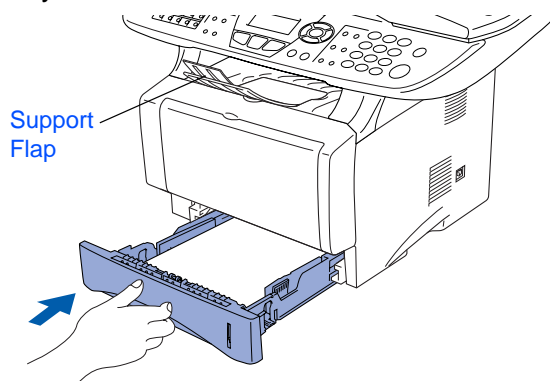

For details on supported paper specifications, see "Paper" in Chapter 2 (User's Guide).

## 4 Release the Scanner Lock

- 1 Push the lever up to unlock the scanner. (The gray scanner lock lever is located at the back left under side of the document cover.)

Scanner Lock Lever

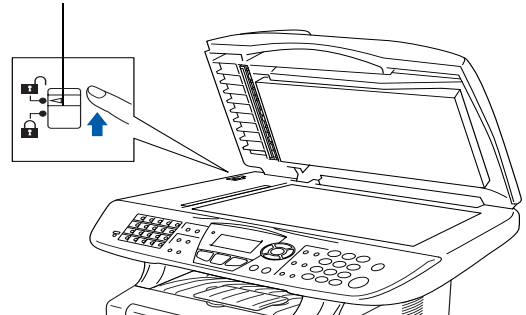



## 5

## Install the Power Cord and Phone Line



Do not connect the Parallel or USB cable yet.

- 1 Make sure that the power switch is off. Connect the AC power cord to the machine.

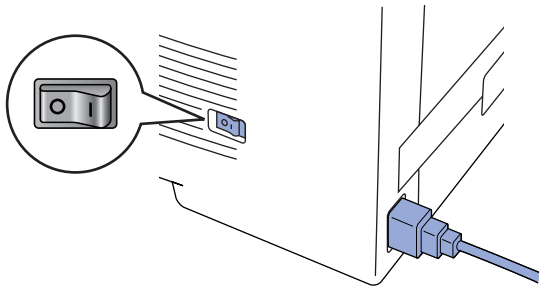

- 2 Plug the AC power cord into an AC outlet. Turn the power switch on.



If Check Scan Lock appears on the LCD, immediately release the scanner lock and press **Stop/Exit**.

- 3 Connect one end of the telephone line cord to the jack on the MFC marked **LINE** and the other end to a modular wall jack.

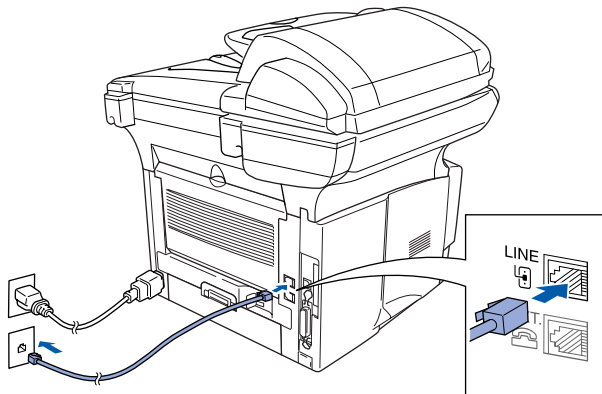

If you are sharing one phone line with an external telephone, connect it as shown below.

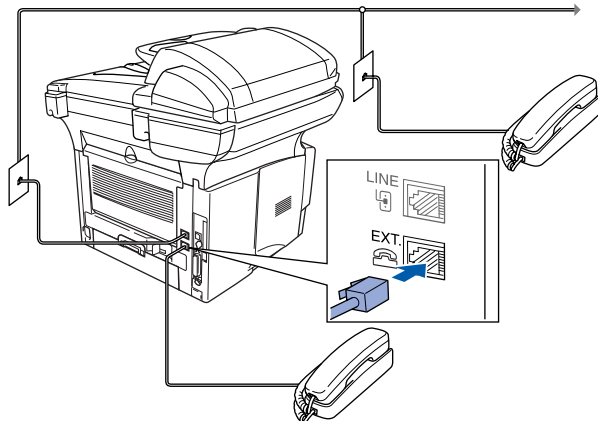

If you are sharing one phone line with an external telephone answering device, connect it as shown below.



Please set the receive mode to External TAD.

For more details, see "Connecting the MFC" in Chapter 1 of the User's Guide.

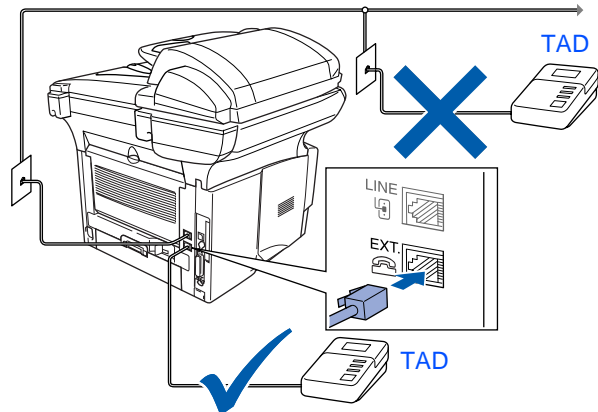

### Warning

- The MFC must be grounded using a 3-prong plug.
- Since the MFC is grounded through the power outlet, you can protect yourself from potentially hazardous electrical conditions on the telephone network by keeping the power to your MFC on when you connect it to a telephone line. Similarly, you can protect yourself when you want to move your MFC by disconnecting the telephone line first and then the power cord.



# Step 1

# Setting Up the Machine

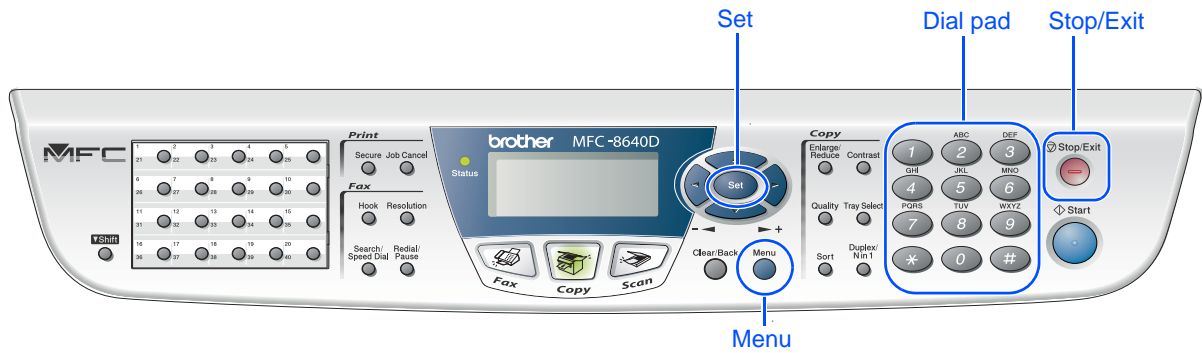

## 6 Selecting a Receive Mode

Choose the **Receive** mode which best suits your needs.

- 1 Press the **Menu** key.
- 2 Press **0** key.
- 3 Press **1** key.
- 4 Press **▲** or **▼** to select the mode.
- 5 Press the **Set** key.
- 6 Press the **Stop/Exit** key.

Are you connecting an external telephone or external telephone answering device to the MFC?

Yes

No

Are you using the voice message function of your external telephone answering device?

**Fax Only**

The MFC automatically answers every call as a fax.

No

Do you want the MFC to answer fax and telephone calls automatically?

Yes

**Fax/Tel**

The MFC controls the line and automatically answers every call. If the call is not a fax, the phone will ring for you to pick up the call.

No

**Manual**

You control the phone line and must answer every call yourself.

Yes

**External TAD**

Your external telephone answering device (TAD) automatically answers every call. Voice messages are stored on the external TAD. Fax messages are printed.



For more details, see "Setup Receive" in Chapter 5 of the User's Guide.

## 7 Setting the Date and Time

The MFC displays the date and time, and prints it on every fax you send.

- 1 Press the **Menu** key.
- 2 Press the **0** key.
- 3 Press the **2** key.
- 4 Enter the last two digits of the year on the dial pad, and then press the **Set** key.

```
02.Date/Time
      03/XX/2005

      Year:2005

Enter & Set Key
```

(e.g. Enter **0, 5** for 2005.)

- 5 Enter the two digits for the month on the dial pad, and then press the **Set** key.

```
02.Date/Time
      XX/XX/2005

      Month:03

Enter & Set Key
```

(e.g. Enter **0, 3** for March.)

- 6 Enter the two digits for the day on the dial pad, and then press the **Set** key.

```
02.Date/Time
      03/XX/2005

      Day:01

Enter & Set Key
```

(e.g. Enter **0, 1**.)

- 7 Enter the time in 24-hour format on the dial pad, and then press the **Set** key.

```
02.Date/Time
      03/01/2005

      Time:15:25

Enter & Set Key
```

(e.g. Enter **1, 5, 2, 5** for 3:25 P.M.)

- 8 Press the **Stop/Exit** key.



*If you want to repeat from step 1, press the **Stop/Exit** key.*

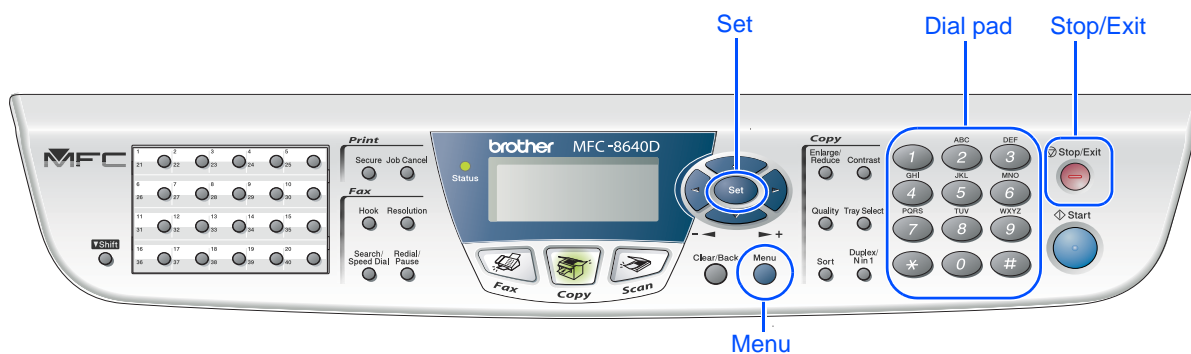

## 8 Setting Your Station ID

You should store your name and fax number to be printed on all fax pages that you send.

- 1 Press the **Menu** key.
- 2 Press the **0** key.
- 3 Press the **3** key.
- 4 Enter your fax number (up to 20 digits) on the dial pad, and then press the **Set** key.

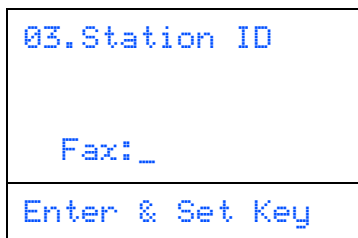

- 5 Enter your telephone number (up to 20 digits) on the dial pad, and then press the **Set** key.  
(If your telephone number and fax number are the same, enter the same number again.)

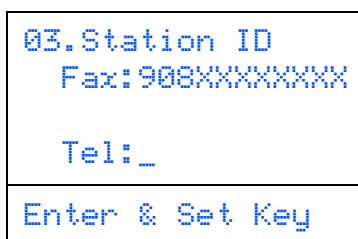

- 6 Use the dial pad to enter your name (up to 20 characters), and then press the **Set** key.

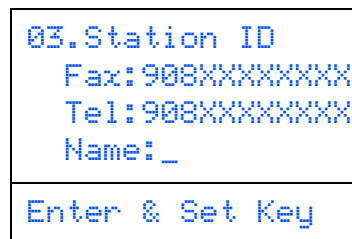

- Refer to the following chart for entering your name.
- If you need to enter a character that is on the same key as the previous character, press  to move the cursor to the right.

Press key	One time	Two times	Three times	Four times
2	A	B	C	2
3	D	E	F	3
4	G	H	I	4
5	J	K	L	5
6	M	N	O	6
7	P	Q	R	S
8	T	U	V	8
9	W	X	Y	Z





For more details, see "Setting the Station ID" in Chapter 4 of the User's Guide.

- 7 Press the **Stop/Exit** key.



If you want to repeat from step 1, press the **Stop/Exit** key.

## 9 Selecting Your Language (Canada Only)

- 1 Press the **Menu** key.
- 2 Press the **0** key.
- 3 Press the **5** key.
- 4 Select your language (ENGLISH or FRENCH) by using  or , and then press the **Set** key.



- 5 Press the **Stop/Exit** key.

## 10 Sending in the Product Registration and Test Sheet (USA Only)

- 1 Fill out the Product Registration and Test Sheet.

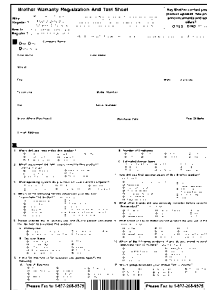

- 2 Place the sheet face up in the Automatic Document Feeder.

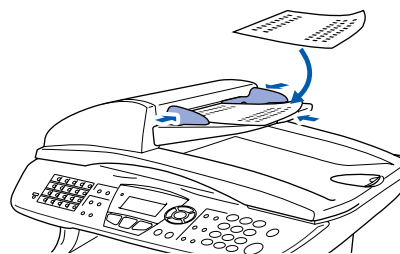

Make sure  (Fax) is illuminated in Green.

- 3 Enter the toll-free fax number:  
1-877-268-9575.

- 4 Press the **Start** key.



You will receive a confirmation fax of your Product Registration.



You can also register your product online using the On-Line Registration link from the installation CD-ROM or go to <http://www.brother.com/registration>

Go to Next page to  
install the driver

## Supplied CD-ROM “MFL-Pro Suite”

The CD-ROM includes the following items:

### Windows®

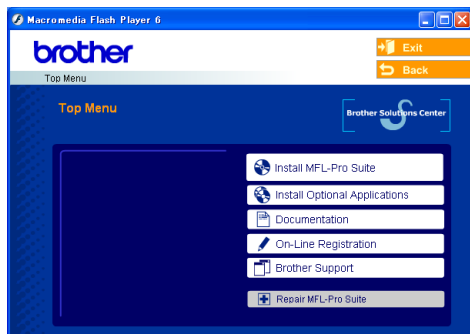

MFL-Pro Suite includes Printer Driver, Scanner Driver, ScanSoft® PaperPort® 9.0SE, ScanSoft® OmniPage® and True Type® fonts. PaperPort® 9.0SE is a document management application for viewing scanned documents. ScanSoft® OmniPage®, which is integrated into PaperPort® 9.0SE, is an OCR application that converts an image into text and inserts it into your default word processor.

### Macintosh®



#### Install MFL-Pro Suite

You can install the MFL-Pro Suite and multifunction drivers.



#### Install Optional Applications

You can install additional MFL-Pro Suite software utilities.



#### Documentation\*1

View the User's Guide and other documentation in PDF format (Viewer included).



#### On-Line Registration

You will be pointed to the Brother Product Registration Web page for quick registration of your machine.



#### Brother Support

View contact information for Brother Customer Service and how to locate a Brother Authorized Service Center.



#### Repair MFL-Pro Suite

If an error occurred during the installation of the MFL-Pro Suite, use this selection to automatically repair and re-install the MFL-Pro Suite.



#### Start Here OS 8.6-9.2

You can install the printer driver, scanner driver and Presto!® PageManager® for Mac OS® 8.6 - 9.2.



#### Start Here OSX

You can install the printer driver, scanner driver, remote setup program and Presto!® PageManager® for Mac OS® 10.1/10.2.1 or greater.



#### ReadMe!

You can get important information and troubleshooting tips.



#### Documentation\*1

View the User's Guide and other documentation in PDF format.



#### Brother Solutions Center

You can access the Brother Solutions Center which is a Web site offering information about your Brother product including FAQs, User's Guides, Driver updates and Tips for using your machine.



#### On-Line Registration

You will be pointed to the Brother Product Registration Web Page for quick registration of your machine.

\*1 The User's Guide on the CD-ROM includes the Software and Network User's Guide for features available when connected to a computer (e.g. Printing and scanning).



Follow the instructions on this page for your operating system and interface cable.

Setting Up  
the Machine

Windows®



**USB Interface Cable Users** ..... Go to page 14  
(For Windows® 98/98SE/Me/2000 Professional/XP)

Windows®  
USB



**Parallel Interface Cable Users** ..... Go to page 23  
(For Windows® 98/98SE/Me/2000 Professional/XP)

Windows®  
Parallel



**Windows NT® Workstation Version 4.0 Users ...** Go to page 33  
(For Parallel Interface Cable Users)

Windows  
NT® 4.0  
Parallel



**Network Interface Cable Users**..... Go to page 35  
(For Windows® 98/98SE/Me/NT/2000 Professional/XP)

Windows®  
Network

Macintosh®



**USB Interface Cable Users**  
■ For Mac OS® 8.6 to 9.2 ..... Go to page 38  
■ For Mac OS® X 10.1/10.2.1 or greater ..... Go to page 40

Macintosh®  
USB



**Network Interface Cable Users**  
■ For Mac OS® 8.6 to 9.2 ..... Go to page 42  
■ For Mac OS® X 10.1/10.2.1 or greater ..... Go to page 44

Macintosh®  
Network

**For Administrators** ..... Go to page 46

For  
Administrators



# Step 2

# Installing the Driver & Software



## For USB Interface Cable Users

(For Windows® 98/98SE/Me/2000 Professional/XP)

**Make sure that you have completed the instructions from Step 1 “Setting Up the Machine” on pages 4 - 11.**

- 1 Turn off and unplug the MFC from the AC outlet and disconnect it from your computer, if you have already connected an interface cable.

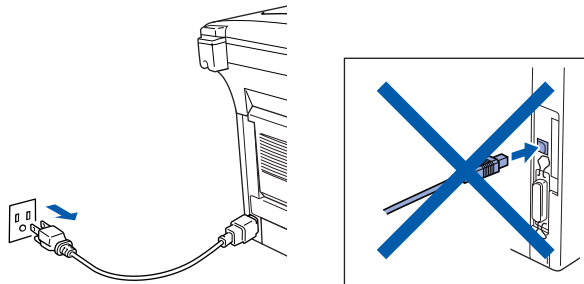

- 2 Turn on your computer. (For Windows® 2000 Professional/XP, you must be logged on as the administrator.)
- 3 Insert the supplied CD-ROM into your CD-ROM drive. If the model name screen appears, select your machine. If the language screen appears, select your language.



- 4 The CD-ROM main menu will appear. Click **Install MFL-Pro Suite**.



*If this window does not appear, use Windows® Explorer to run the **setup.exe** program from the root directory of the Brother CD-ROM.*

*If you see the following screen, click **OK** to install the Windows® updates. After the updates are installed, your PC may restart. Then the installation will automatically continue.*

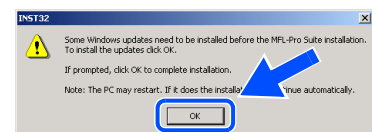

*If the installation does not continue automatically, please open the main menu again by ejecting then reinserting the CD-ROM disc or double-click the **setup.exe** program from the root directory, and continue from Step 4 to install the MFL-Pro Suite.*

- 5 After reading and accepting the ScanSoft® PaperPort® 9.0SE License Agreement, click **Yes**.

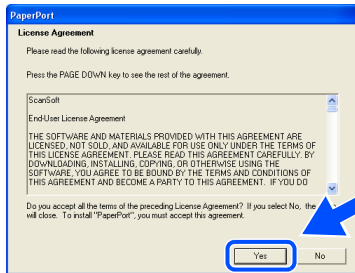

- 6 The installation of PaperPort® 9.0SE will automatically start and is followed by the installation of MFL-Pro Suite.



If an error message appears during the installation process, you can repair and reinstall the software. From the CD menu, select **Repair MFL-Pro Suite** and follow the instructions on the screen.

- 7 When the Brother MFL-Pro Suite Software License Agreement window appears, read the agreement, then click **Yes** if you agree to its terms.

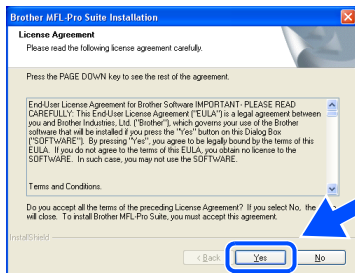

- 8 Select **Local Connection**, and then click **Next**. The installation will continue.

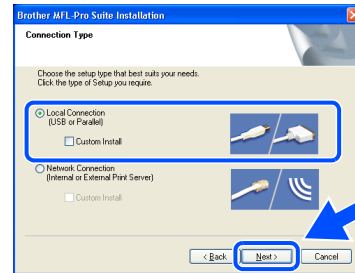

If you want to install the PS driver, select **Custom Install** and then follow the on-screen instructions. When the **Select Components** screen appears, check **PS Printer Driver**, and then continue following the on-screen instructions.

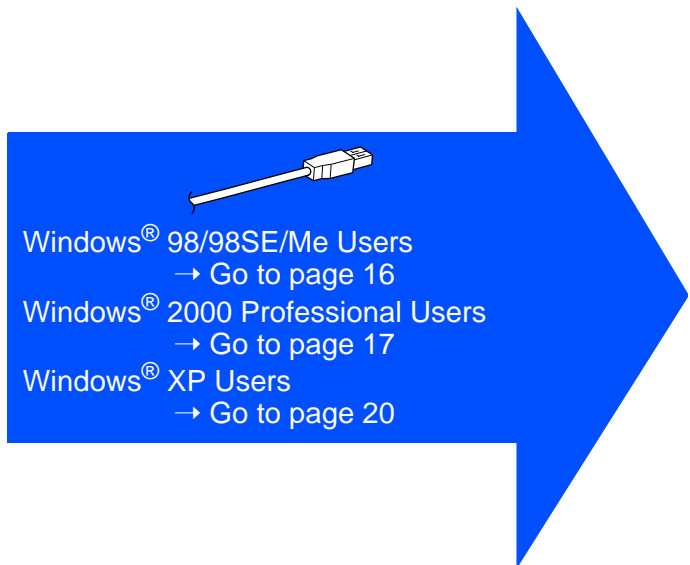



## For USB Interface Cable Users

(For Windows® 98/98SE/Me/2000 Professional/XP)

## For Windows® 98/98SE/Me Users Only

Make sure that you followed the instructions in 1 to 8 on pages 14 - 15.

- 9 When the screen appears, connect the USB interface cable to your PC, and then connect it to the MFC.

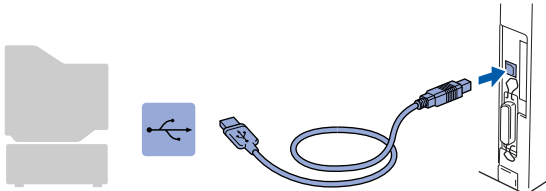
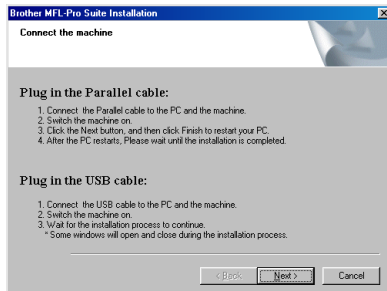

- 10 Plug in the power cord and turn on the MFC.

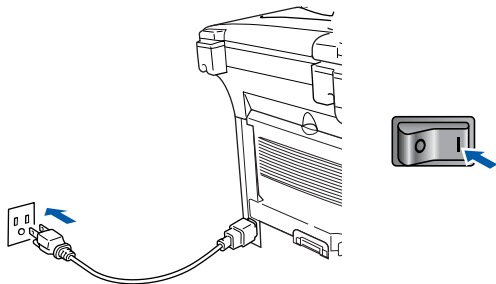

It will take a few seconds for the installation screens to appear.

The installation of the Brother drivers will automatically start. The installation screens appear one after another, please wait for a while.

- 11 When the Brother on-line Registration screen is displayed, make your selection and follow the on-screen instructions.

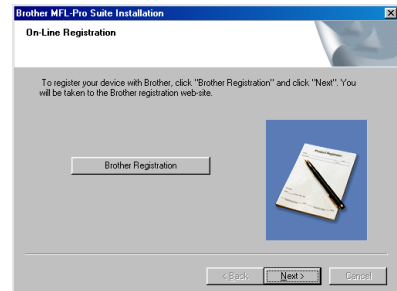

- 12 When the following screen appears, click **Finish** and wait as the PC restarts Windows and continues the installation.

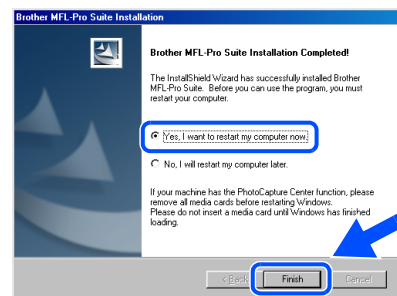

*If the installation is unsuccessful, try installing again using **Repair MFL-Pro Suite** option from the main menu. Select **Repair MFL-Pro Suite** and follow the instructions on the screen.*

**OK!** The MFL-Pro Suite, PC-FAX, Printer driver and Scanner driver have been installed and the installation is now complete.

## For Windows® 2000 Professional Users Only

Make sure that you followed the instructions in 1 to 8 on pages 14 - 15.

- 9 When this screen appears, connect the USB interface cable to your PC, and then connect it to the MFC. Plug in the power cord and turn on the MFC.

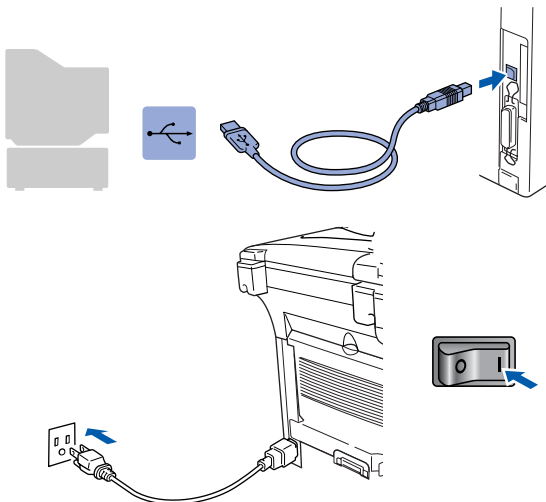
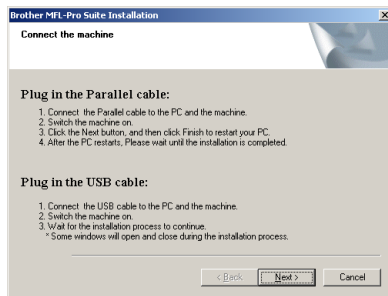

It will take a few seconds for the installation screen to appear.

The installation of the Brother drivers will automatically start. Follow the instructions on the screen.

- 10 When the Brother on-line Registration screen is displayed, make your selection and follow the on-screen instructions.

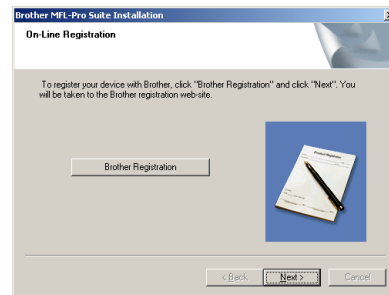

- 11 When the following screen appears, click **Finish** and wait as the PC restarts Windows and continues the installation.

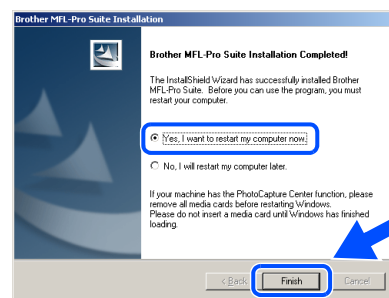

- OK! A Basic Universal printer driver was installed with the MFL-Pro Suite which is certified for use with Windows® operating systems.

Brother also offers a full featured printer driver (Native driver) that includes more features than the Basic Universal driver. However, this driver does not include a Windows® certificate. To install the Brother Native driver proceed to step 12.



For details on what features are available see chapter 2 of the Software User's Guide.

Continued...

# Step 2

# Installing the Driver & Software



For USB Interface Cable Users

(For Windows® 98/98SE/Me/2000 Professional/XP)

## Brother Native driver Installation

- 12 Click **Start** and select **Settings** and then **Printers**. Click on **Add a printer** and the Add Printer Wizard will start. When this screen appears, click **Next**.

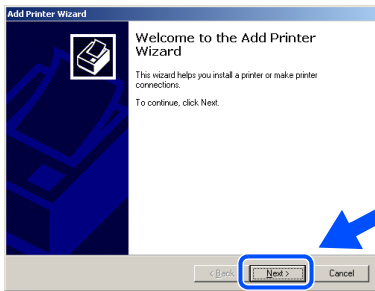

- 13 Un-check the **Automatically detect and install my Plug and Play printer** selection and then click **Next**.

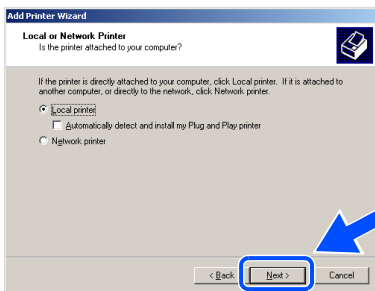

- 14 Select **USBXXX** from the pull down window for the Printer Port Selection and then click **Next**.

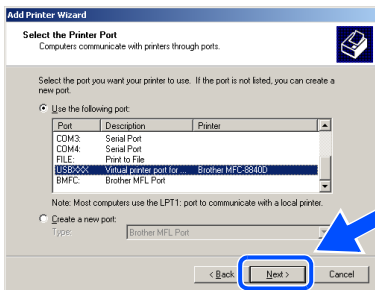

- 15 Click on **Have Disk**.

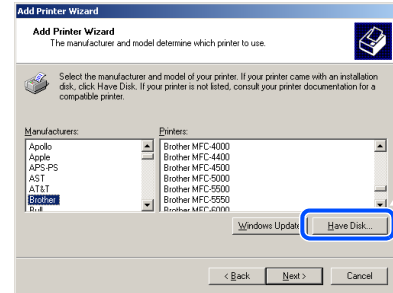

- 16 Browse the CD-ROM and highlight your language folder and click **Open**. Highlight the **W2K** folder and click **Open**. Highlight the **Addprt** folder and click **Open**.

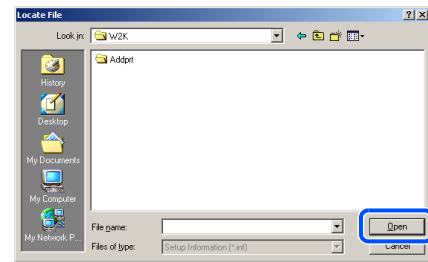

- 17 Click **Open**.

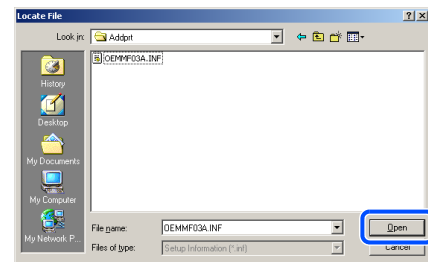

- 18 Make sure **X:\USA\W2K\Addprt** is displayed in the window and click **OK** (X:\ is the drive letter of your CD-ROM).

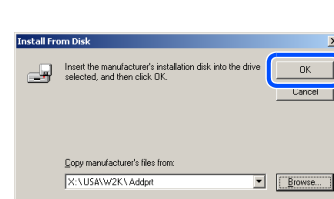

- 19 Highlight the model you are installing from the list of machines and click **Next**.

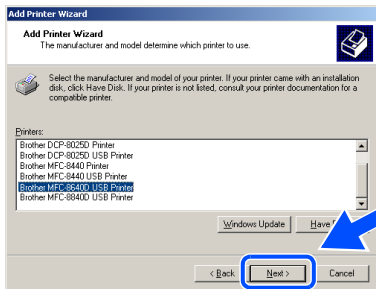

Make sure you select a USB printer.

- 20 The model you are installing will be listed in the window. Select **Yes** or **No** if you want this driver to be your default printer.

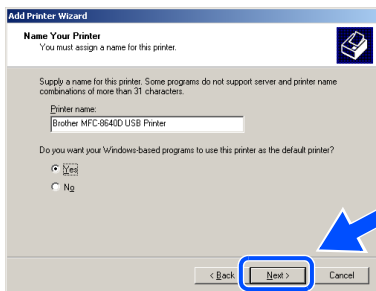

- 21 If this screen appears, select **Do not share this printer** and **Next**.

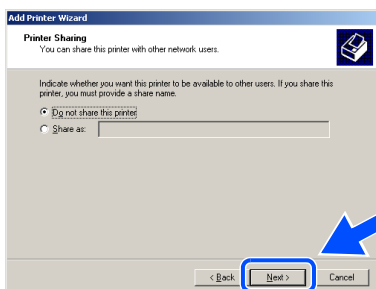

- 22 Select **Yes** and **Next** to print a test page.

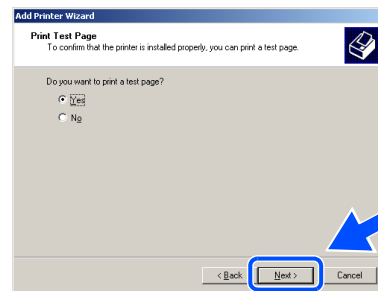

- 23 When this screen appears, click **Finish**.

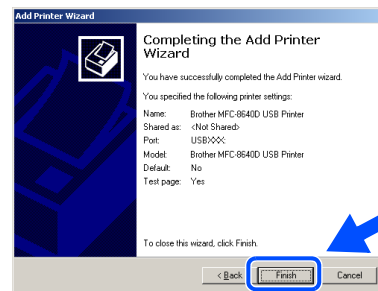

- 24 If the Digital Signature Not Found dialog box appears, click **Yes**.

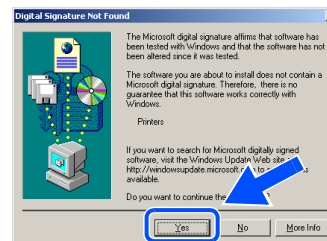

- 25 If the test page printed, click **OK**.

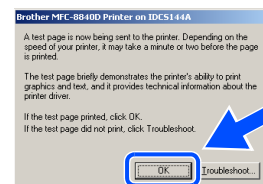

There will be two Brother printer drivers listed in the Printers selection. The driver with "Printer" after the model name (ex. Brother MFC-8640D Printer) is the Brother Native Driver.

- OK!** The Brother Native Drivers have been installed and the installation is now complete.



## For USB Interface Cable Users (For Windows® 98/98SE/Me/2000 Professional/XP)

### For Windows® XP Users Only

Make sure that you followed the instructions in 1 to 8 on pages 14 - 16.

- 9 When this screen appears, connect the USB interface cable to your PC, and then connect it to the MFC. Plug in the power cord and turn on the MFC.

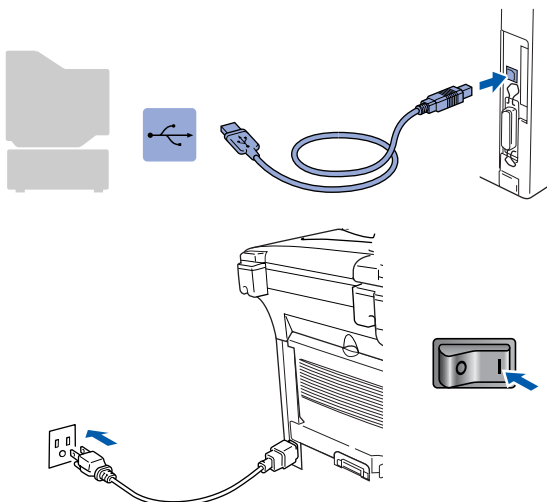
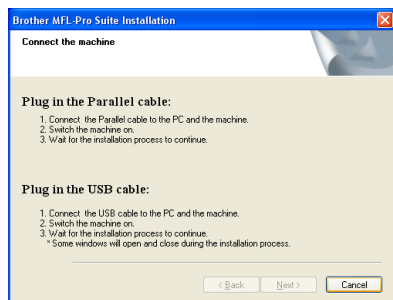

It will take a few seconds for the installation screen to appear.

The installation of the Brother drivers will automatically start. The screens appear one after another, please wait for a while.

- 10 When the Brother on-line Registration screen is displayed, make your selection and follow the on-screen instructions.

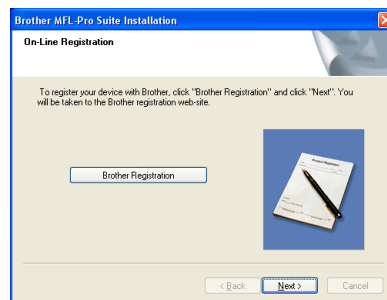

- 11 When the following screen appears, click **Finish** and wait as the PC restarts Windows and continues the installation.

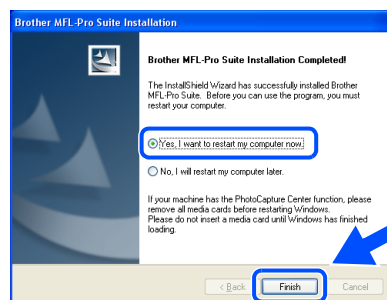

- OK!** A Basic Universal printer driver was installed with the MFL-Pro Suite which is certified for use with Windows® operating systems.

Brother also offers a full featured printer driver (Native driver) that includes more features than the Basic Universal driver. However, this driver does not include a Windows® certificate. To install the Brother Native driver proceed to step 12.



For details on what features are available see chapter 2 of the Software User's Guide.

## Brother Native driver Installation

- 12 Click **Start** and select **Printers and Faxes**. Click on **Add a printer** and the Add Printer Wizard will start. When this screen appears, click **Next**.



- 13 Un-check the **Automatically detect and install my Plug and Play printer** selection and then click **Next**.

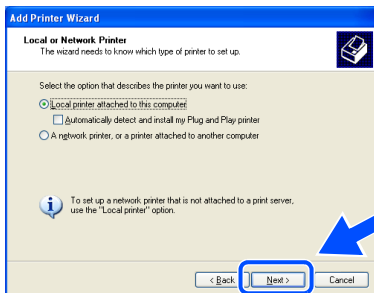

- 14 Select **USBXXX** from the pull down window for the Printer Port Selection and then click **Next**.

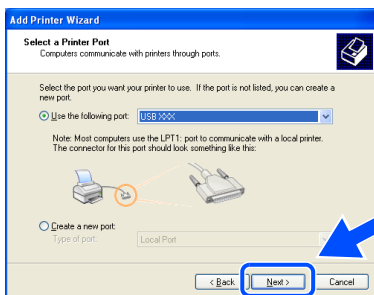

- 15 Click on **Have Disk**.

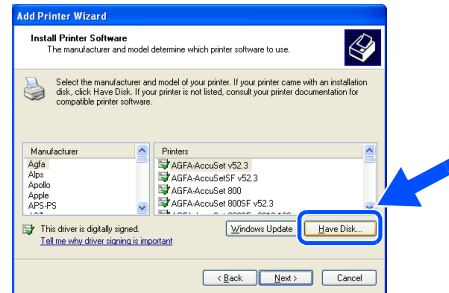

- 16 Browse the CD-ROM and highlight your language folder and click **Open**. Highlight the **WXP** folder and click **Open**. Highlight the **Addprt** folder and click **Open**.

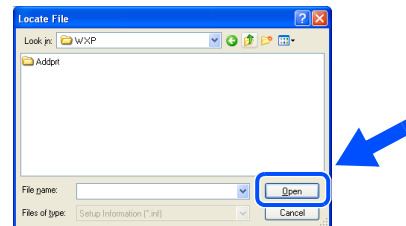

- 17 Click **Open**.

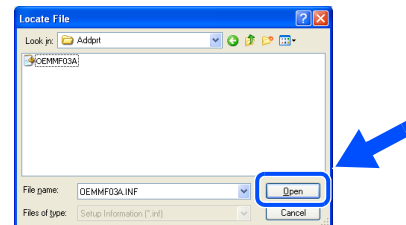

- 18 Make sure **X:\USA\WXP\Addprt** is displayed in the window and click **OK** (X:\ is the drive letter of your CD-ROM).

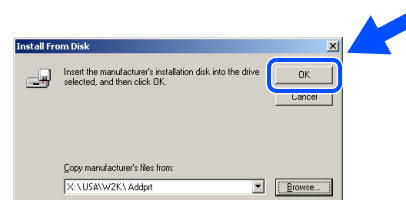

Continued...

# Step 2

# Installing the Driver & Software



## For USB Interface Cable Users

(For Windows® 98/98SE/Me/2000 Professional/XP)

- 19 Highlight the model you are installing from the list of machines and click **Next**.

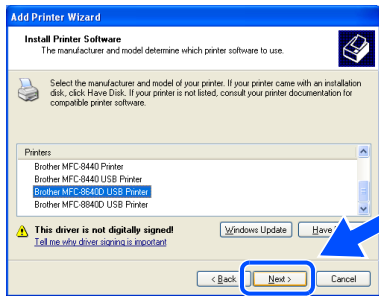

Make sure you select a USB printer.

- 20 The model you are installing will be listed in the window. Select **Yes** or **No** if you want this driver to be your default printer.

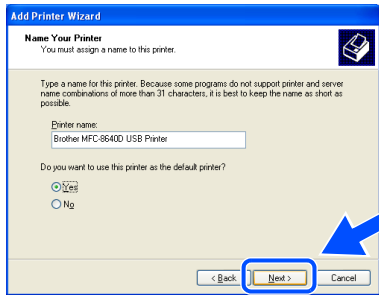

- 21 If this screen appears, select **Do not share this printer** and **Next**.

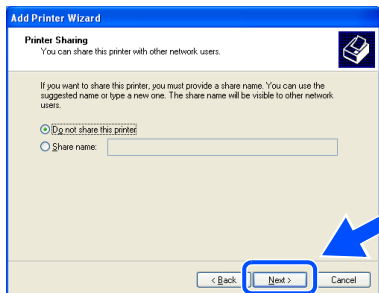

- 22 Select **Yes** and **Next** to print a test page.

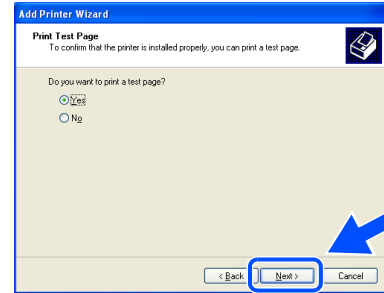

- 23 When this screen appears, click **Finish**.

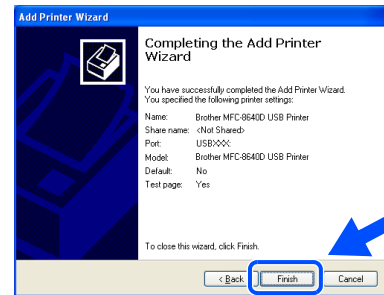

- 24 When the Windows Logo testing screen appears, click **Continue Anyway**.



There will be two Brother printer drivers listed in the "Printers" selection. The driver with Printer after the model name (ex. Brother MFC-8640D Printer) is the Brother Native Driver.



The Brother Native Drivers have been installed and the installation is now complete.

## For Parallel Interface Cable Users (For Windows® 98/98SE/Me/2000 Professional/XP)

Make sure that you have completed the instructions from Step 1 “Setting Up the Machine” on pages 4 - 11.

- 1 Switch off and unplug the MFC from the AC outlet and disconnect it from your computer, if you have already connected an interface cable.

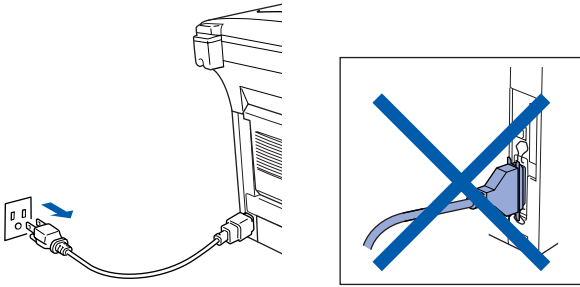

- 2 Turn on your computer.  
(For Windows® 2000 Professional/XP, you must be logged on as the administrator.)
- 3 Insert the supplied CD-ROM into your CD-ROM drive. If the model name screen appears, select your machine. If the language screen appears, select your language.

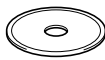

- 4 The CD-ROM main menu will appear. Click **Install MFL-Pro Suite**.



If this window does not appear, use Windows® Explore to run the **setup.exe** program from the root directory of the Brother CD-ROM.



If you see the following screen, click **OK** to install the Windows® updates. After the updates are installed your PC may restart. Note: If it does the installation will automatically continue.

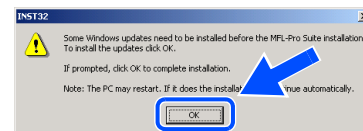

If the installation does not continue automatically, please open the installer menu again by double-clicking the **setup.exe** program from the root directory of the Brother CD-ROM, and continue from Step 4.

Continued...

# Step 2

# Installing the Driver & Software

## For Parallel Interface Cable Users (For Windows® 98/98SE/Me/2000 Professional/XP)

- 5 After reading and accepting the ScanSoft® PaperPort® 9.0SE License Agreement, click **Yes**.

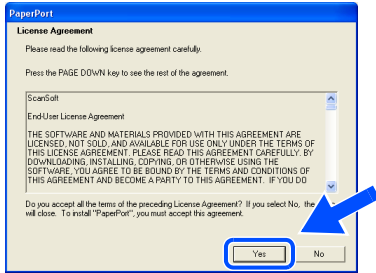

- 6 The installation of PaperPort® 9.0SE will automatically start and is followed by the installation of MFL-Pro Suite.



If an error message appears during the installation process, you can repair and reinstall the software. From the CD menu, select **Repair MFL-Pro Suite** and follow the instructions on the screen.

- 7 When the Brother MFL-Pro Suite Software License Agreement window appears, read the agreement, then click **Yes** if you agree to its terms.

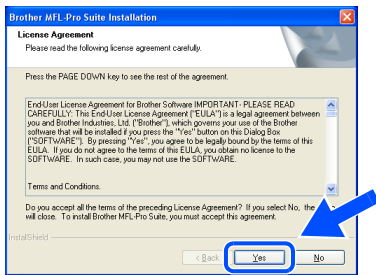

- 8 Select **Local Connection**, and then click **Next**. The installation will continue.

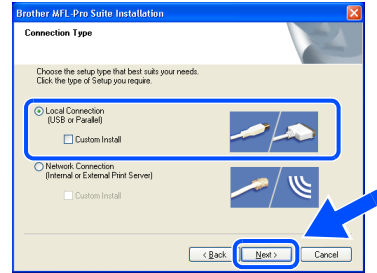

If you want to install the PS driver, select **Custom Install** and then follow the on-screen instructions. When the **Select Components** screen appears, check **PS Printer Driver**, and then continue following the on-screen instructions.

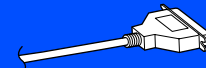

Windows® 98/98SE/Me Users  
→ Go to page 25  
Windows® 2000 Professional Users  
→ Go to page 26  
Windows® XP Users  
→ Go to page 30

## For Windows® 98/98SE/Me Users Only

Make sure that you followed the instructions in 1 to 8 on pages 23 - 24.

- 9 When the screen appears, connect the parallel interface cable to your PC, and then connect it to the MFC. Plug in the power cord and turn on the MFC.

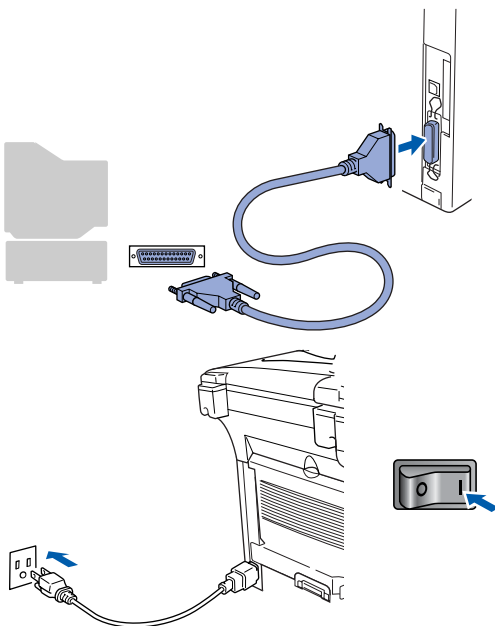
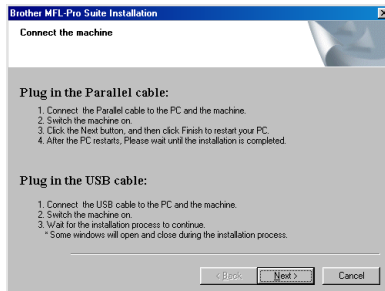

- 10 Click **Next**.

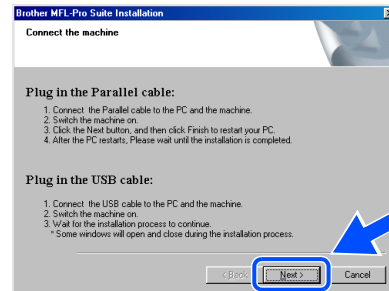

- 11 When the Brother on-line Registration screen is displayed, make your selection and follow the on-screen instructions.

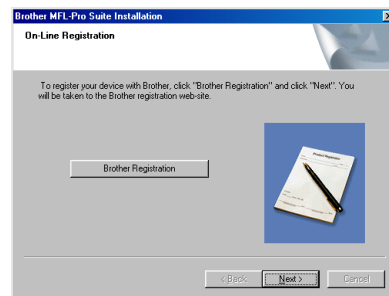

- 12 When the following screen appears, click **Finish** and wait as the PC restarts Windows and continues the installation.

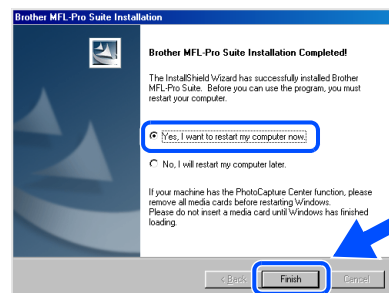

- 13 After the computer restarts, the installation of the Brother drivers will automatically start. Follow the instructions on the screen.

- OK!** The MFL-Pro Suite, PC-FAX, Printer driver and Scanner driver have been installed and the installation is now complete.



## For Parallel Interface Cable Users (For Windows® 98/98SE/Me/2000 Professional/XP)

### For Windows® 2000 Professional Users Only

Make sure that you followed the instructions in 1 to 8 on pages 23 - 24.

- 9 When the screen appears, connect the parallel interface cable to your PC, and then connect it to the MFC.  
Plug in the power cord and turn on the MFC.

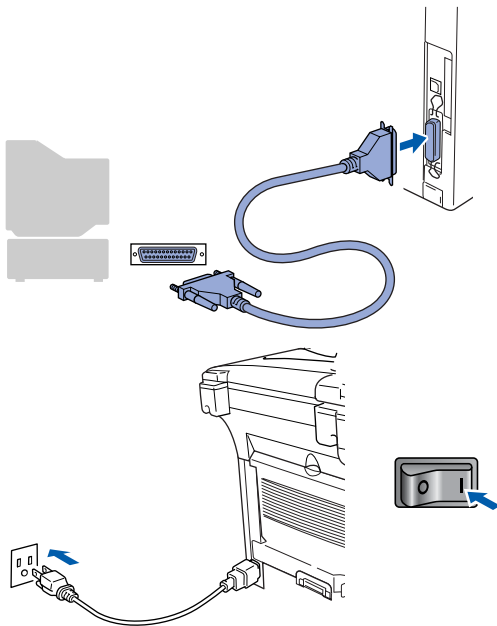
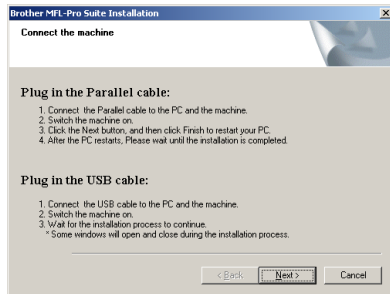

- 10 Click **Next**.

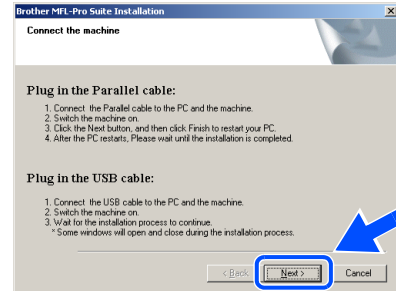

- 11 When the Brother on-line Registration screen is displayed, make your selection and follow the on-screen instructions.

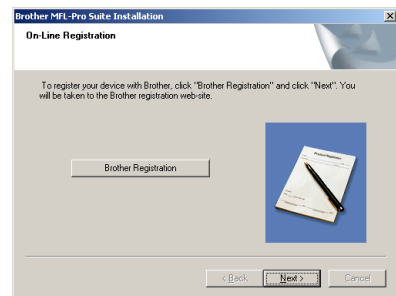

- 12 When the following screen appears, click **Finish** and wait as the PC restarts Windows and continues the installation.

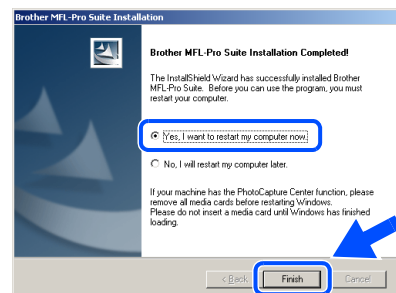

- 13 After the computer restarts, the installation of the Brother drivers will automatically start. Follow the instructions on the screen.
- 14 If the **Digital Signature Not Found** dialog boxes appear, click **Yes** to install the driver.

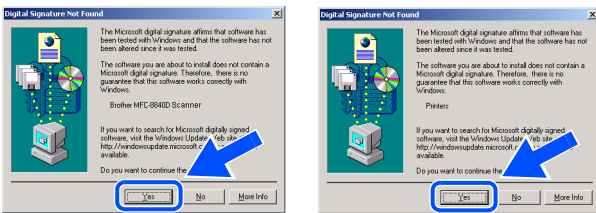

- OK!** A Basic Universal printer driver was installed with the MFL-Pro Suite which is certified for use with Windows® operating systems.

Brother also offers a full featured printer driver (Native driver) that includes more features than the Basic Universal driver. However, this driver does not include a Windows® certificate. To install the Brother Native driver proceed to step 15.



For details on what features are available see chapter 2 of the Software User's Guide.

## Brother Native driver Installation

- 15 Click **Start** and select **Settings** and then **Printers**. Click on **Add a printer** and the Add Printer Wizard will start. When this screen appears, click **Next**.

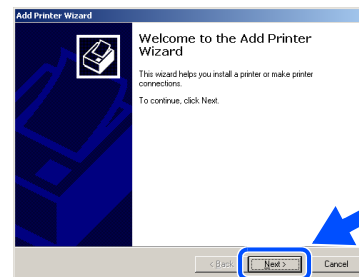

- 16 Un-check the **Automatically detect and install my Plug and Play printer** selection and then click **Next**.

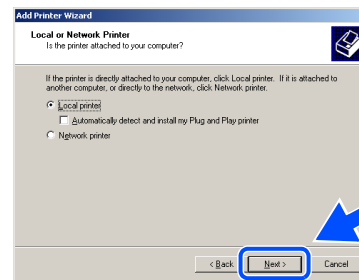

- 17 Select **BMFC (Brother MFL Port)** from the pull down window for the Printer Port Selection and then click **Next**.

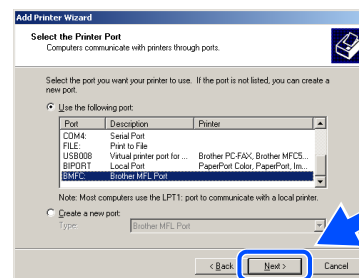

Continued...

## For Parallel Interface Cable Users (For Windows® 98/98SE/Me/2000 Professional/XP)

- 18 Click on **Have Disk**.

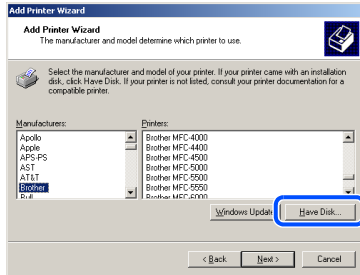

- 22 Highlight the model you are installing from the list of machines and click **Next**.

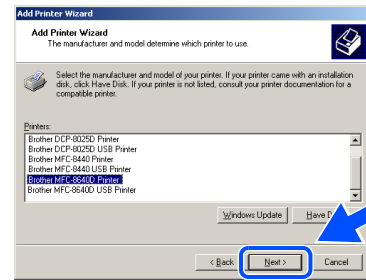

- 19 Browse the CD-ROM and highlight your language folder and click **Open**. Highlight the **W2K** folder and click **Open**. Highlight the **Addprt** folder and click **Open**.

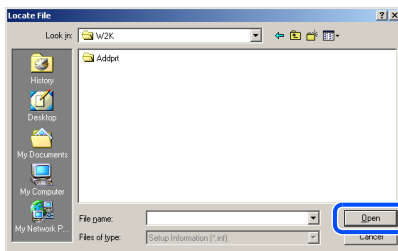

 Make sure you **do not** select a USB printer.

- 23 The model you are installing will be listed in the window. Select **Yes** or **No** if you want this driver to be your default printer.

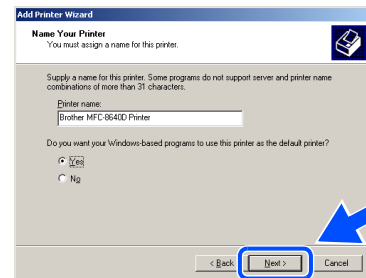

- 20 Click **Open**.

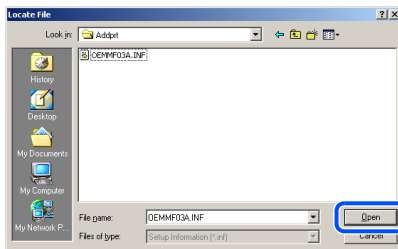

- 24 If this screen appears, select **Do not share this printer** and **Next**.

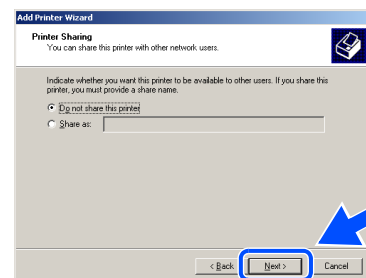

- 21 Make sure **X:\USA\W2K\Addprt** is displayed in the window and click **OK** (X:\ is the drive letter of your CD-ROM).

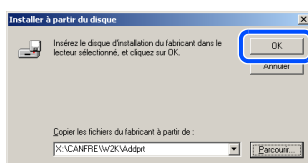

- 25 Select **Yes** and **Next** to print a test page.

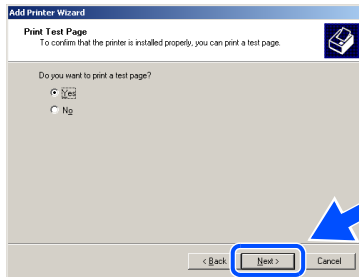

- 26 When this screen appears, click **Finish**.



- 27 If the Digital Signature Not Found dialog box appears, click **Yes**.

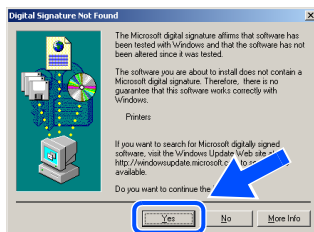

- 28 If the test page printed, click **OK**.

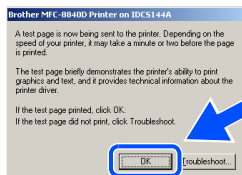

There will be two Brother printer drivers listed in the Printers selection. The driver with "Printer" after the model name (ex. Brother MFC-8640D Printer) is the Brother Native Driver.

- OK!** The Brother Native Drivers have been installed and the installation is now complete.

## For Parallel Interface Cable Users (For Windows® 98/98SE/Me/2000 Professional/XP)

### For Windows® XP Users Only

Make sure that you followed the instructions in 1 to 8 on pages 23 - 24.

- 9 When the screen appears, connect the parallel interface cable to your PC, and then connect it to the MFC.  
Plug in the power cord and turn on the MFC.

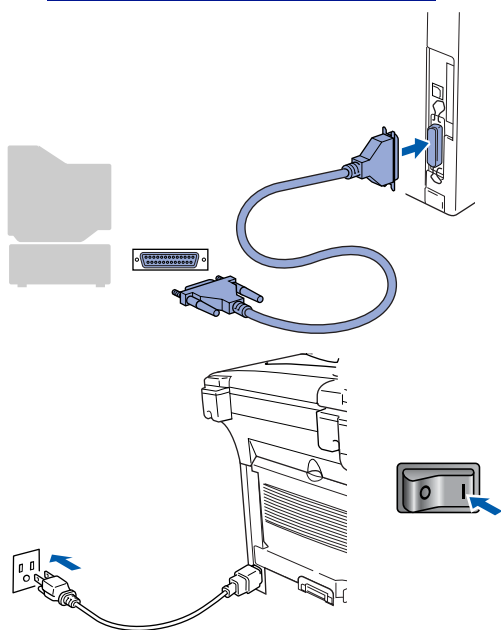
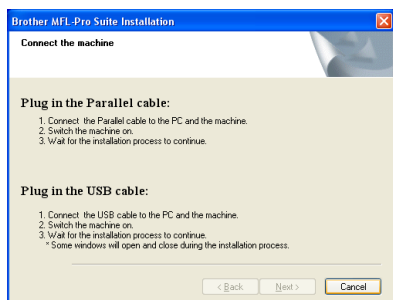

The installation of the Brother drivers will automatically start. The screens appear one after another, please wait for a while.

- 10 When the Brother on-line Registration screen is displayed, make your selection and follow the on-screen instructions.



- 11 When the following screen appears, click **Finish** and wait as the PC restarts Windows and continues the installation.

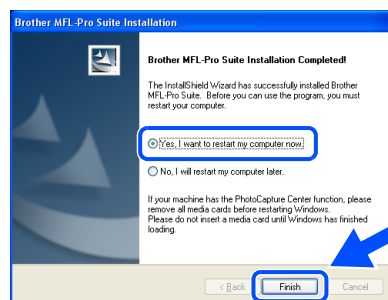

- OK!** A Basic Universal printer driver was installed with the MFL-Pro Suite which is certified for use with Windows® operating systems.

Brother also offers a full featured printer driver (Native driver) that includes more features than the Basic Universal driver. However, this driver does not include a Windows® certificate. To install the Brother Native driver proceed to step 12.



For details on what features are available see chapter 2 of the Software User's Guide.

## Brother Native driver Installation

- 12 Click **Start** and select **Printers and Faxes**. Click on **Add a printer** and the Add Printer Wizard will start. When this screen appears, click **Next**.



- 13 Un-check the **Automatically detect and install my Plug and Play printer** selection and then click **Next**.

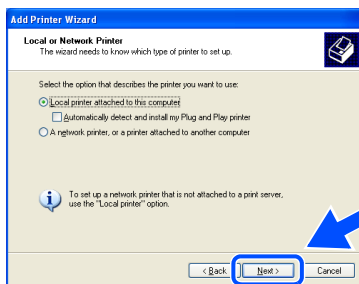

- 14 Select **BMFC (Brother MFL Port)** from the pull down window for the Printer Port Selection and then click **Next**.

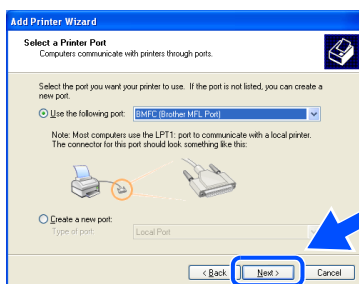

- 15 Click on **Have Disk**.

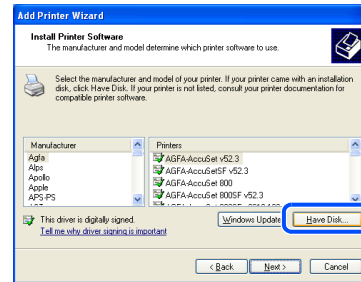

- 16 Browse the CD-ROM and highlight your language folder and click **Open**. Highlight the **WXP** folder and click **Open**. Highlight the **Addprt** folder and click **Open**.

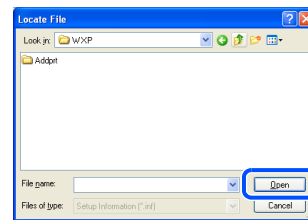

- 17 Click **Open**.

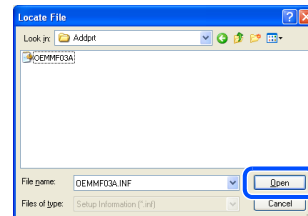

- 18 Make sure **X:\USA\WXP\Addprt** is displayed in the window and click **OK** (X:\ is the drive letter of your CD-ROM).



Continued...



# Step 2

# Installing the Driver & Software

## For Parallel Interface Cable Users (For Windows® 98/98SE/Me/2000 Professional/XP)

- 19 Highlight the model you are installing from the list of machines and click **Next**.

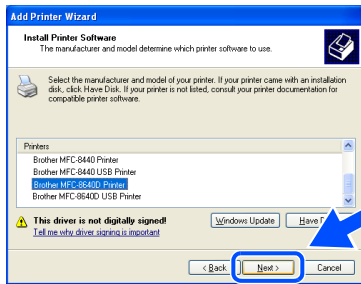

Make sure you **do not** select a USB printer.

- 20 The model you are installing will be listed in the window. Select **Yes** or **No** if you want this driver to be your default printer.

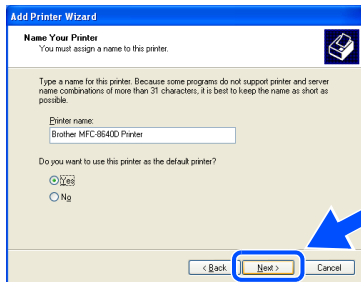

- 21 If this screen appears, select **Do not share this printer** and **Next**.

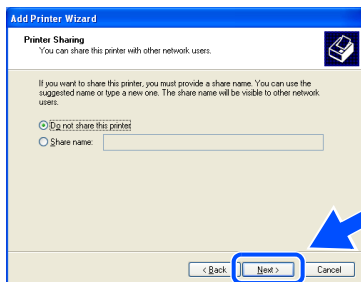

- 22 Select **Yes** and **Next** to print a test page.

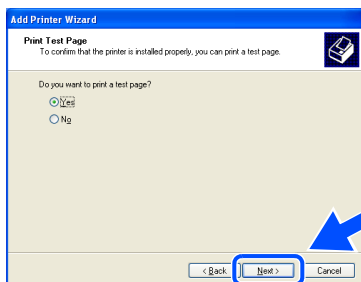

- 23 When this screen appears, click **Finish**.

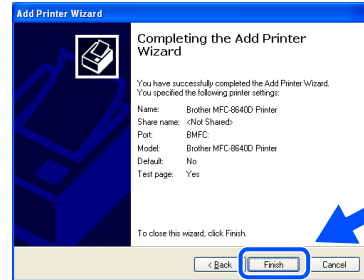

- 24 When the Windows Logo testing screen appears, click **Continue Anyway**.

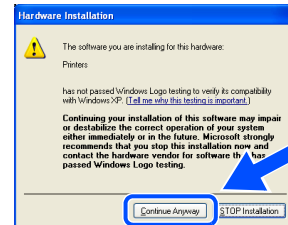

There will be two Brother printer drivers listed in the Printers selection. The driver with "Printer" after the model name (ex. Brother MFC-8640D Printer) is the Brother Native Driver.

- OK!** The Brother Native Drivers have been installed and the installation is now complete.

## For Windows NT® Workstation Version 4.0 Users

Make sure that you followed the instructions from Step 1 “Setting Up the Machine” on pages 4 - 11.

- 1 Turn on your computer. You must be logged on as the Administrator.
- 2 Connect the parallel interface cable to your computer, and then connect it to the MFC.

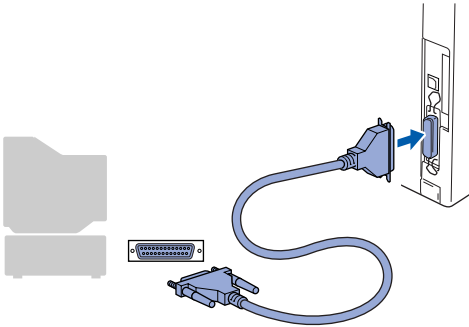

- 3 Plug in the power cord and turn on the MFC.

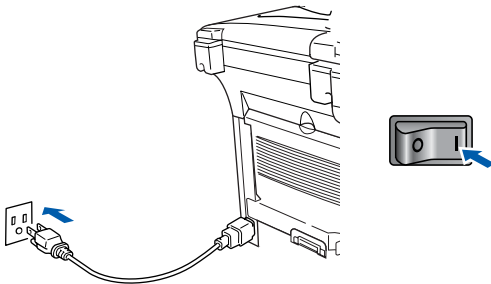

- 4 Insert the supplied CD-ROM into your CD-ROM drive. If the model name screen appears, select your machine. If the language screen appears, select your language.



- 5 The CD-ROM main menu will appear. Click **Install MFL-Pro Suite**.



If this window does not appear, use Windows® Explorer to run the **setup.exe** program from the root directory of the Brother CD-ROM.



If you see the following screen, click **OK** to install the Windows® updates. After the updates are installed your PC may restart. Note: If it does the installation will automatically continue.

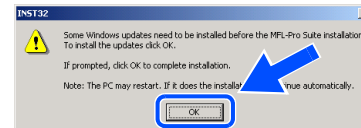

If the installation does not continue automatically, please open the installer menu again by double-clicking the **setup.exe** program on the Brother CD-ROM, and continue from Step 5.

Continued...

# Step 2

# Installing the Driver & Software



## For Windows NT® Workstation Version 4.0 Users

- 6 After reading and accepting the ScanSoft® PaperPort® 9.0SE License Agreement, click **Yes**.

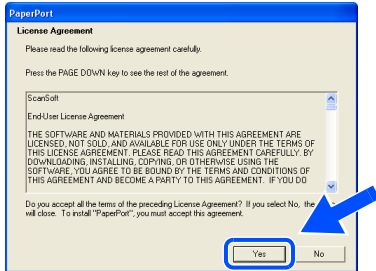

- 7 The installation of PaperPort® 9.0SE will automatically start and is followed by the installation of MFL-Pro Suite.



If an error message appears during the installation process, you can repair and reinstall the software. From the CD menu, select **Repair MFL-Pro Suite** and follow the instructions on the screen.

- 8 When the Brother MFL-Pro Suite Software License Agreement window appears, read the agreement, then click **Yes** if you agree to its terms.

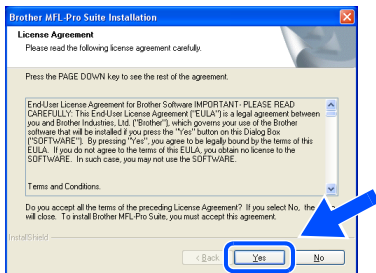

- 9 Select **Local Connection**, and then click **Next**. The installation will continue.

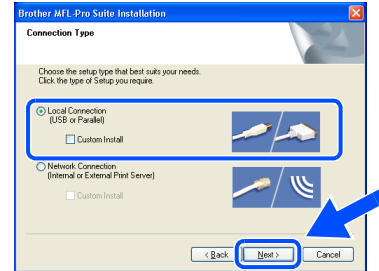

If you want to install the PS driver, select **Custom Install** and then follow the on-screen instructions. When the **Select Components** screen appears, check **PS Printer Driver**, and then continue following the on-screen instructions.

- 10 When the Brother on-line Registration screen is displayed, make your selection and follow the on-screen instructions.



- 11 When the following screen appears, click **Finish** and wait as the PC restarts Windows and continues the installation.

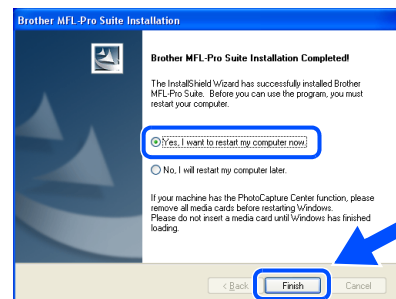

**OK!** The MFL-Pro Suite, PC-FAX, Printer driver and Scanner driver have been installed and the installation is now complete.

## For Network Interface Cable Users (For Windows® 98/98SE/Me/NT/2000 Professional/XP)

Make sure that you have completed the instructions from Step 1 "Setting Up the Machine" on pages 4 - 11.

Before installation, if you are using Personal Firewall software, disable it. Once you are sure that you can print, re-start your Personal Firewall software.

- 1 Make sure that the NC-9100h (Network Print/Fax Server) is installed into the MFC (See "Optional accessories" in Chapter 13 of the User's Guide.)
- 2 Connect the network cable to the machine, and then connect it to a free port on your hub.

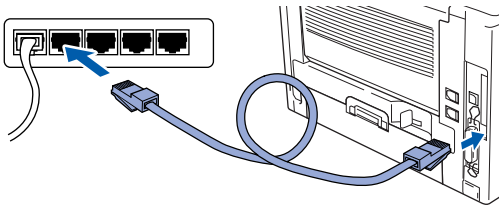

- 3 Plug in the power cord and turn on the MFC.

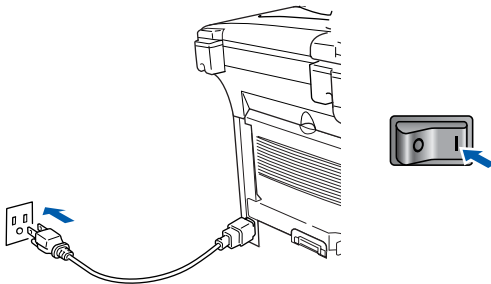

- 4 Turn on your computer.  
(For Windows® 2000 Professional/XP/Windows NT® 4.0, you must be logged on as the administrator.)

- 5 Insert the supplied CD-ROM into your CD-ROM drive. If the model name screen appears, select the MFC. If the language screen appears, select your language.



- 6 The CD-ROM main menu will appear. Click **Install MFL-Pro Suite**.



If this window does not appear, use Windows® Explorer to run the **setup.exe** program from the root directory of the Brother CD-ROM.



If you see the following screen, click **OK** to install the Windows® updates. After the updates are installed your PC may restart. Then the installation will automatically continue.

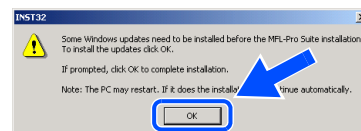

If the installation does not continue automatically, please open the main menu again by ejecting then reinserting the CD-ROM disc or double-click the **setup.exe** program from the root directory, and continue from Step 6 to install the MFL-Pro Suite.

Continued...

# Step 2

# Installing the Driver & Software

## For Network Interface Cable Users (For Windows® 98/98SE/Me/2000 Professional/XP)

- 7 After reading and accepting the ScanSoft® PaperPort® 9.0SE License Agreement, click **Yes**.

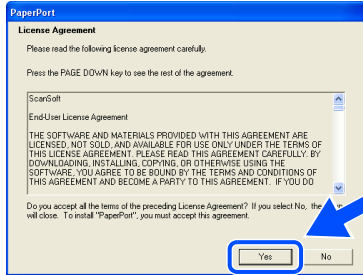

- 8 The installation of PaperPort® 9.0SE will automatically start and is followed by the installation of MFL-Pro Suite.



If an error message appears during the installation process, you can repair and reinstall the software. From the CD menu, select **Repair MFL-Pro Suite** and follow the instructions on the screen.

- 9 When the Brother MFL-Pro Suite Software License Agreement window appears, read the agreement, then click **Yes** if you agree to its terms.

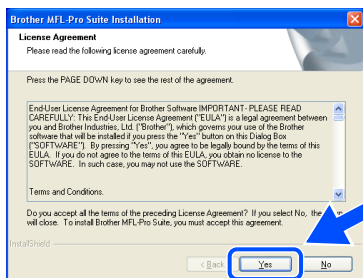

- 10 Select **Network Connection**, and then click **Next**.

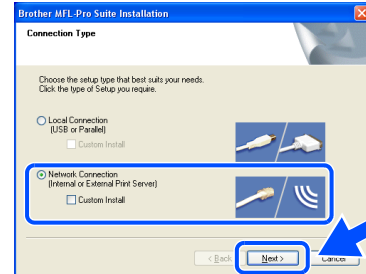

If you want to install the PS driver, select **Custom Install** and then follow the on-screen instructions. When the **Select Components** screen appears, check **PS Printer Driver**, and then continue following the on-screen instructions.

- 11 The installation of the Brother drivers will automatically start. The installation screens appear one after another, please wait for a while.

- 12 If the MFC is configured for your network, select the MFC from the list, and then click **Next**.



This window will not appear if there is only one machine connected on the network, it will be selected automatically.

If the MFC is not yet configured for use on your network, the **Configure IP Address** window will appear. Enter the IP address information appropriate to your network by following the on-screen instructions.

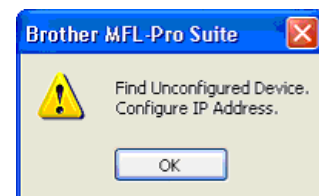

- 13 When the Brother on-line Registration screen is displayed, make your selection and follow the on-screen instructions.

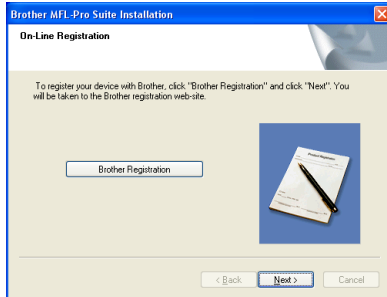

- 14 When the following screen appears, click **Finish** and wait as the PC restarts Windows and continues the installation.

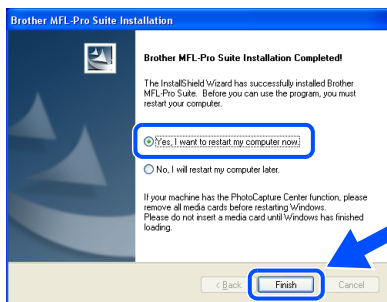

- OK!** The MFL-Pro Suite, Network Printer driver, Network Scanner driver have been installed and the installation is now complete.



*Network Scanning is not supported in Windows NT® 4.0.*

## For USB Interface Cable Users

### For Mac OS<sup>®</sup> 8.6 to 9.2

Make sure that you have completed the instructions from Step 1 “Setting Up the Machine” on pages 4 - 11.

- 1 Turn off and unplug the MFC from the AC outlet and disconnect it from your Macintosh<sup>®</sup> if you already connected an interface cable.

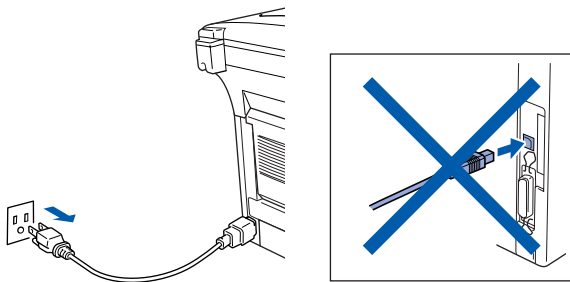

- 2 Turn on your Macintosh<sup>®</sup>.
- 3 Insert the supplied CD-ROM into your CD-ROM drive.



- 4 Double-click the **Start Here OS 8.6-9.2** icon to install the printer and scanner drivers. If the language screen appears, select your language.

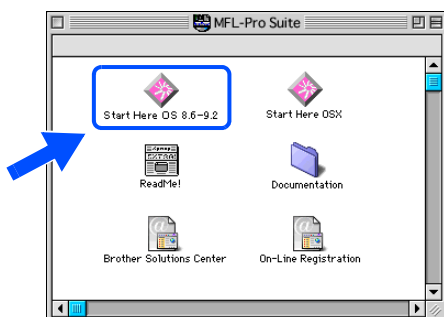

- 5 Click **MFL-Pro Suite** to install.



- 6 Follow the on-screen instructions, and restart your Macintosh<sup>®</sup>.
- 7 Connect the USB interface cable to your Macintosh<sup>®</sup>, and then connect it to the MFC.

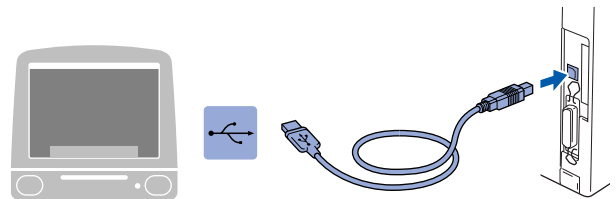

**DO NOT** connect the MFC to a USB port on a keyboard or a non powered USB hub.

- 8 Plug in the power cord and turn on the MFC.

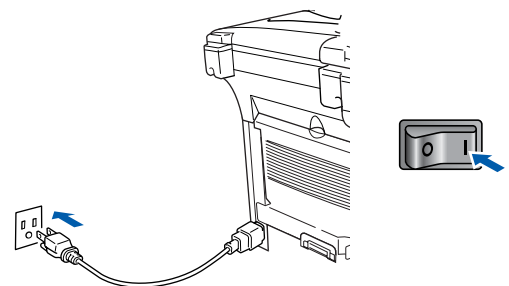



- 9 From the Apple® menu, open the **Chooser**.



- 10 Click the **Brother Laser** icon.  
On the right side of the **Chooser**, select the machine to which you want to print.  
Close the **Chooser**.

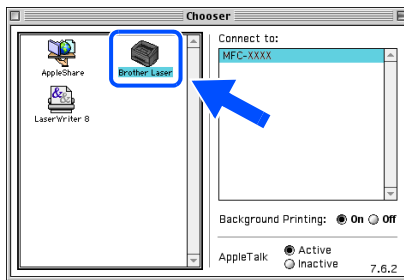

- OK!** The **MFL-Pro Suite, Printer driver and Scanner driver** have been installed.



*ControlCenter2.0 is not supported in Mac OS® 8.6 to 9.2.*

- 11 To install Presto!® PageManager®, click the **Presto! PageManager** icon and follow the on-screen instructions.

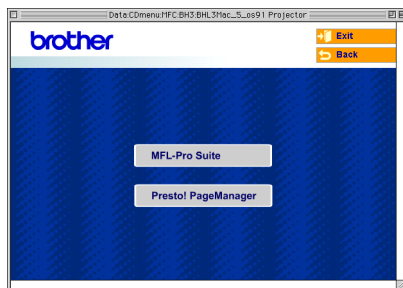

*You can easily scan, share and organize photos and documents using Presto!® PageManager®.*

- OK!** **Presto!® PageManager®** has been installed and the installation is now complete.

## For USB Interface Cable Users

### For Mac OS<sup>®</sup> X 10.1/10.2.1 or greater

Make sure that you have completed the instructions from Step 1 “Setting Up the Machine” on pages 4 - 11.



For Mac OS<sup>®</sup> X 10.2.0 user, please upgrade to Mac OS<sup>®</sup> X 10.2.1 or greater. (The latest information for Mac OS<sup>®</sup> X, please visit at: <http://solutions.brother.com>)

- 1 Turn off and unplug the MFC from the AC outlet and disconnect it from your Macintosh<sup>®</sup> if you already connected an interface cable.

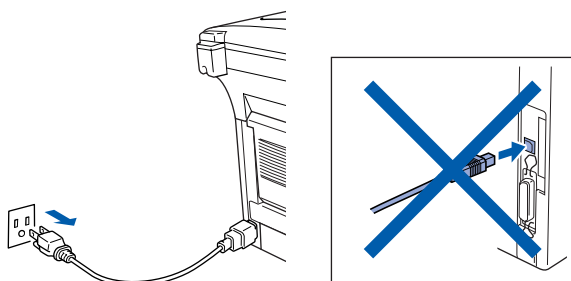

- 2 Turn on your Macintosh<sup>®</sup>.
- 3 Insert the supplied CD-ROM into your CD-ROM drive.



- 4 Double-click the **Start Here OSX** icon to install the printer driver, Scanner driver and Remote Setup program. If the language screen appears, select your language.



- 5 Click **MFL-Pro Suite** to install.



- 6 Follow the on-screen instructions, and restart your Macintosh<sup>®</sup>.
- 7 After the **DeviceSelector** window appears, connect the USB interface cable to your Macintosh<sup>®</sup> and then to the machine.

The **DeviceSelector** window will not appear if the USB interface cable has been connected before restarting your Macintosh<sup>®</sup> or if you are overwriting a previously installed version of the Brother Software. If you encounter this problem continue with the installation skipping step 10 and then see the Software User's Guide Chapter 7 for details on selecting what machine the ControlCenter2.0 will connect with.



- 8 Connect the USB interface cable to your Macintosh<sup>®</sup>, and then connect it to the MFC.

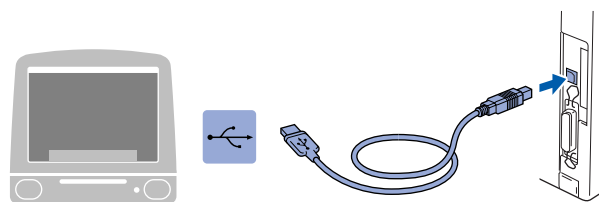

**DO NOT** connect the MFC to a USB port on a keyboard or a non powered USB hub.

- 9 Plug in the power cord and turn on the MFC.

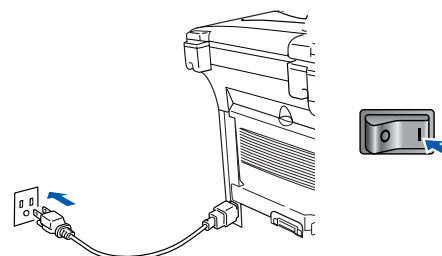

- 10 Select **USB** and then click **OK**.



- 11 Select **Applications** from the **Go** menu.

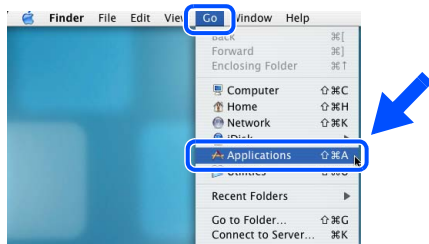

- 12 Open the **Utilities** folder.



- 13 Open the **Print Center** icon.

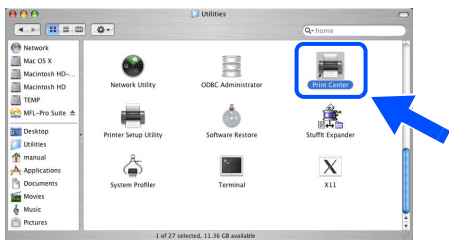

- 14 Click **Add**.

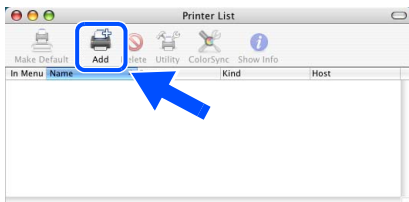

- 15 Select **USB**.

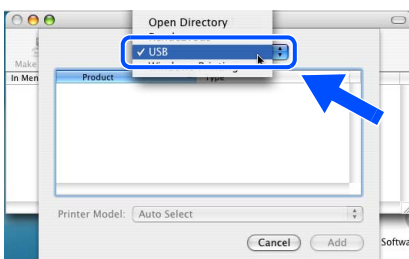

- 16 Select **MFC-8640D**, and then click **Add**.

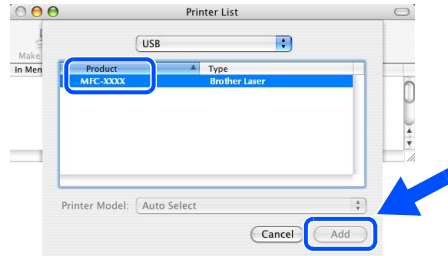

- 17 Select **Quit Printer Setup Utility** from the **Printer Setup Utility** menu.

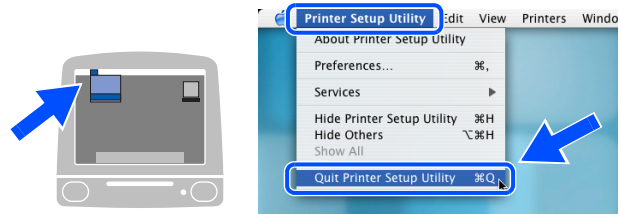

- OK!** The **MFL-Pro Suite**, **Printer driver**, **Scanner driver** and **Remote Setup Program** have been installed and the installation is now complete.

*Scanning and ControlCenter2.0 is not supported in Mac OS® X 10.1.*

- 18 To install **Presto!® PageManager®**, click the **Presto! PageManager** icon and follow the on-screen instructions.



*You can easily scan, share and organize photos and documents using Presto!® PageManager®.*

- OK!** **Presto!® PageManager®** has been installed and the installation is now complete.

## For Network Interface Cable Users

### For Mac OS<sup>®</sup> 8.6 to 9.2

Make sure that you have completed the instructions from Step 1 "Setting Up the Machine" on pages 4 - 11.

- 1 Make sure that the NC-9100h (Network Print/Fax Server) is installed into the MFC. (See "Optional accessories" in Chapter 13 of the User's Guide.)
- 2 Turn off and unplug the MFC from the AC outlet and disconnect it from your Macintosh<sup>®</sup> if you already connected an interface cable.

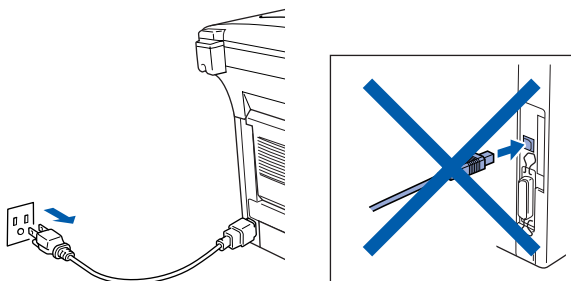

- 3 Turn on your Macintosh<sup>®</sup>.
- 4 Insert the supplied CD-ROM into your CD-ROM drive.



- 5 Double-click the **Start Here OS 8.6-9.2** icon to install the printer and scanner drivers. If the language screen appears, select your language.

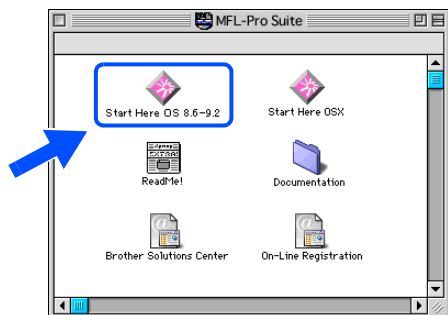

- 6 Click **MFL-Pro Suite** to install.



- 7 Follow the on-screen instructions, and restart your Macintosh<sup>®</sup>.
- 8 Connect the network interface cable to the MFC, and then connect it to a free port on your hub.

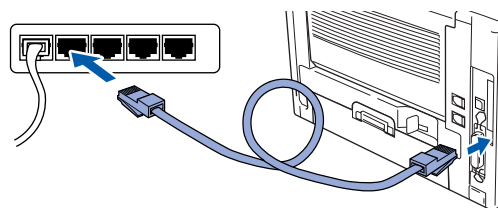

- 9 Plug in the power cord and turn on the MFC.

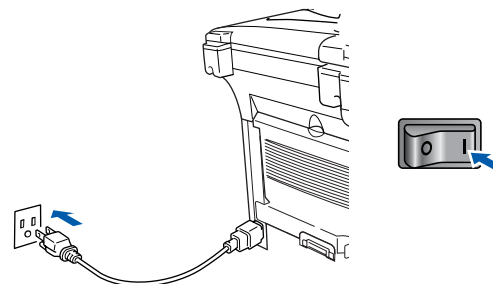

- 10 Open the **Chooser** from the **Apple** menu.



- 11 Click the **Brother Laser (AT)** icon, and then select **BRN\_XXXXXX\_P1**.  
Close the **Chooser**.

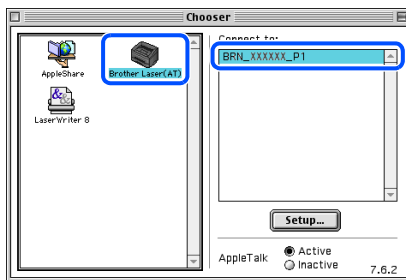

*xxxxxx are the last six digits of the Ethernet address.*



*Network User's Guide Chapter 7 on the CD-ROM.*

- OK!** The setup is now complete.

## For Network Interface Cable Users

### For Mac OS<sup>®</sup> X 10.1/10.2.1 or greater

Make sure that you have completed the instructions from Step 1 "Setting Up the Machine" on pages 4 - 11.

- 1 Make sure that the NC-9100h (Network Print/Fax Server) is installed into the MFC (See "Optional accessories" in Chapter 13 of the User's Guide.)
- 2 Turn off and unplug the MFC from the AC outlet and disconnect it from your Macintosh<sup>®</sup> if you already connected an interface cable.

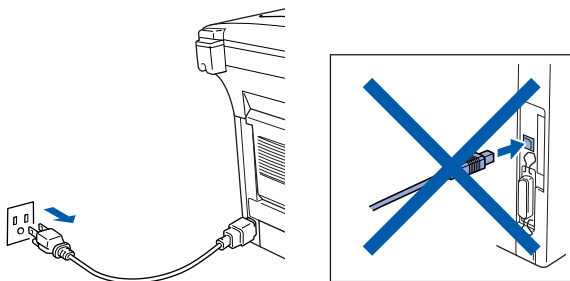

- 3 Turn on your Macintosh<sup>®</sup>.
- 4 Insert the supplied CD-ROM into your CD-ROM drive.



- 5 Double-click the **Start Here OSX** icon to install the printer driver and Remote Setup program. If the language screen appears, select your language.



- 6 Click **MFL-Pro Suite** to install.



- 7 Follow the on-screen instructions, and restart your Macintosh<sup>®</sup>.
- 8 After the **DeviceSelector** window appears, connect the network interface cable to your Macintosh<sup>®</sup> and then to the machine.

The **DeviceSelector** window will not appear if you have also connected a USB interface cable to the machine before restarting your Macintosh<sup>®</sup> or if you are overwriting a previously installed version of the Brother Software. If you encounter this problem continue with skipping steps 11 through 13 and then see the Software User's Guide Chapter 7 for details on selecting what machine the ControlCenter2.0 will connect with.



- 9 Connect the network interface cable to the MFC, and then connect it to a free port on your hub.

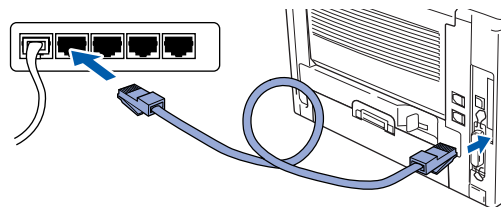

- 10 Plug in the power cord and turn on the MFC.

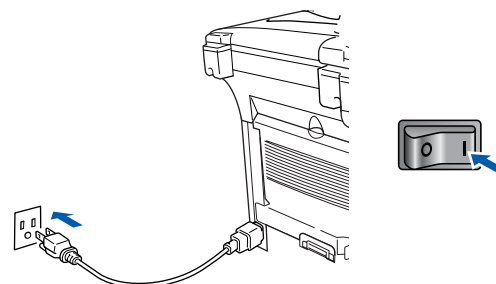



- 11 Select **Network** and then click **OK**.

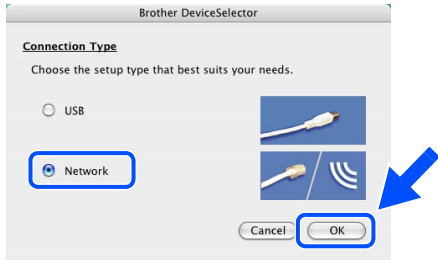

- 12 Click **Browse**.

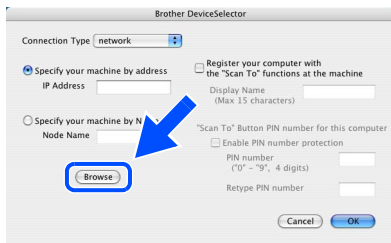

- 13 Select your model name, and then click **OK**. Then click **OK** again to close the **DeviceSelector**.

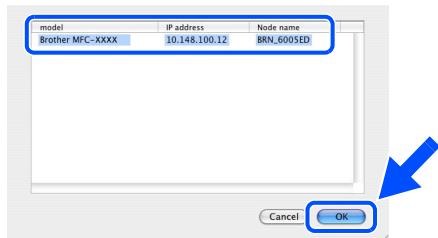

- 14 Select **Applications** from the **Go** menu.

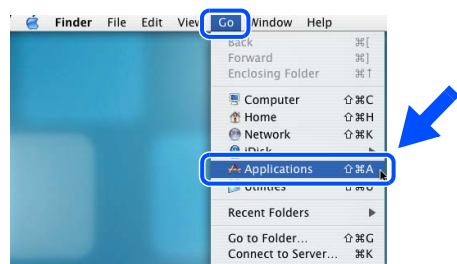

- 15 Open the **Utilities** folder.



- 16 Open the **Print Center** icon.



- 17 Click **Add**.

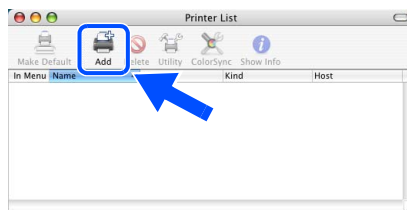

- 18 Select **AppleTalk**.

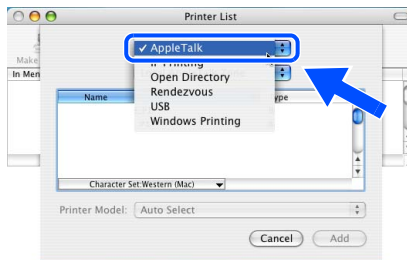

- 19 Select **BRN\_XXXXXX\_P1** and then click the **Add** button.

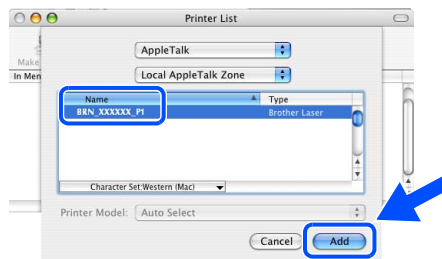

 xxxxxx are the last six digits of the Ethernet address.

- 20 Select **Quit Printer Setup Utility** from the **Printer Setup Utility** menu.

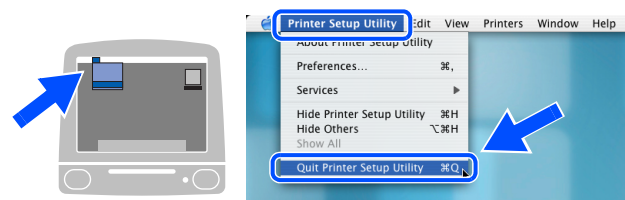

-  **OK!** The setup is now complete.

 Please see *Network User's Guide Chapter 7* on the CD-ROM for more information about using *Simple Network Configuration*.



# For Administrators

This section is for using the printer on a network. An administrator should set up the printer using the following steps.

## Network User's Guide Chapter Map (NC-9100h)

### Windows®

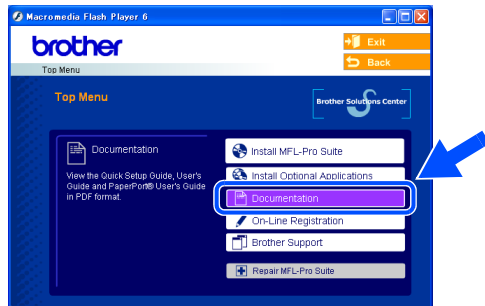

### Macintosh®



Windows® 98/Me	Peer-to-Peer	TCP/IP	Chapter 3	Peer-to-Peer Printing
		NetBIOS	Chapter 4	NetBIOS Peer-to-Peer Printing
	Brother Internet Print	TCP/IP	Chapter 5	Configuring Internet Print for Windows®
	Netware	IPX/SPX	Chapter 6	Novell Netware Printing
Windows NT®	Peer-to-Peer	TCP/IP	Chapter 2	TCP/IP Printing
		NetBIOS	Chapter 4	NetBIOS Peer-to-Peer Printing
		DLC/LLC	Chapter 8	DLC Printing
	Brother Internet Print (NT® 4.0 only)	TCP/IP	Chapter 5	Configuring Internet Print for Windows®
Netware	IPX/SPX	Chapter 6	Novell Netware Printing	
Windows® 2000/XP	Peer-to-Peer  (Windows® 2000 only)	TCP/IP	Chapter 2	TCP/IP Printing
		NetBIOS	Chapter 4	NetBIOS Peer-to-Peer Printing
		DLC/LLC	Chapter 8	DLC Printing
	IPP (Internet Printing Protocol)	TCP/IP	Chapter 2	TCP/IP Printing
	Brother Internet Print	TCP/IP	Chapter 5	Configuring Internet Print for Windows®
Netware	IPX/SPX	Chapter 6	Novell Netware Printing	
UNIX/Linux		TCP/IP	Chapter 1	UNIX Printing
Macintosh®		AppleTalk	Chapter 7	Apple talk (Ether Talk TCP/IP Printing)
		TCP/IP	Chapter 7	Apple talk (Ether Talk TCP/IP Printing)
		Simple Network Configuration	Chapter 7	Simple Network Configuration
OS2 Warp Server LAN Server		TCP/IP	Chapter 2	TCP/IP Printing
		NetBIOS	Chapter 4	NetBIOS Peer-to-Peer Printing

# Installing the BRAdmin Professional Configuration Utility (Windows<sup>®</sup> only)

The BRAdmin Professional utility is designed to manage your Brother network connected devices such as network-ready Multifunction devices and/or network-ready printers in a Local Area Network (LAN) environment.

BRAdmin Professional can also be used to manage devices from other manufacturers whose products support SNMP (Simple Network Management Protocol).

For more information on BRAdmin Professional go to <http://solutions.brother.com>

- 1 Insert the supplied CD-ROM into your CD-ROM drive. The opening screen will appear automatically. Follow the on-screen instructions.



- 2 Click the **Install Optional Applications** icon on the main menu screen.



- 3 Click **BRAdmin Professional** and follow the on-screen instructions.

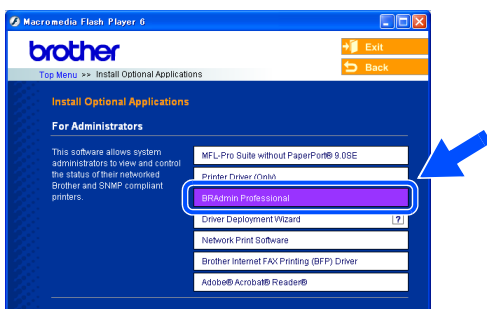

The default password for the print server is **“access”**. You can use BRAdmin Professional or a web browser to change this password.

Setting Up  
the Machine

Windows<sup>®</sup>  
USB

Windows<sup>®</sup>  
Parallel

Windows  
NT<sup>®</sup> 4.0  
Parallel

Windows<sup>®</sup>  
Network

Macintosh<sup>®</sup>  
USB

Macintosh<sup>®</sup>  
Network

For  
Administrators

# Setting your IP Address, Subnet Mask and Gateway using BRAdmin Professional (Windows® Users Only)

- 1 Start BRAdmin Professional, and select **TCP/IP**.

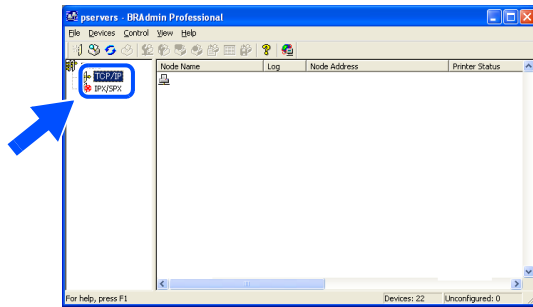

- 2 Select **Search Active Devices** from the **Devices** menu. BRAdmin will search for new devices automatically.

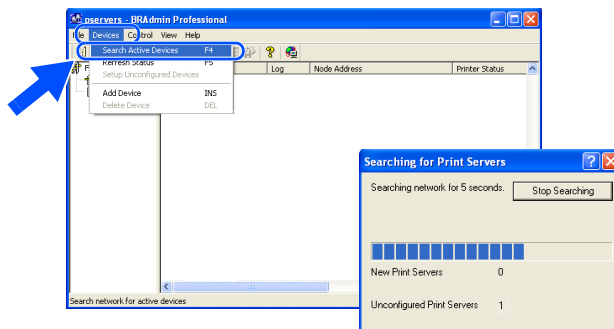

- 3 Double-click the new device.

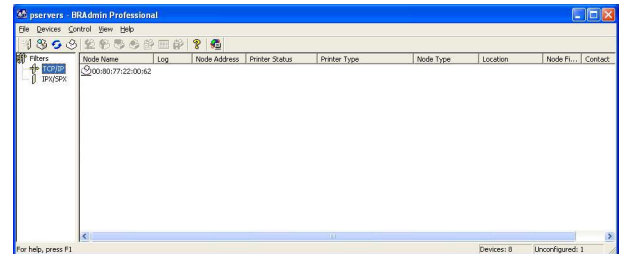

- 4 Enter the **IP Address**, **Subnet Mask** and **Gateway**, and then click the **OK** button.

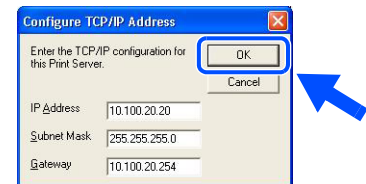

- 5 The address information will be saved to the printer.

# Options

The MFC has the following optional accessories. You can expand the capabilities of the MFC by adding these items.

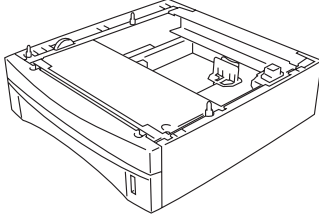
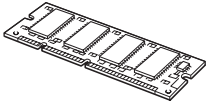
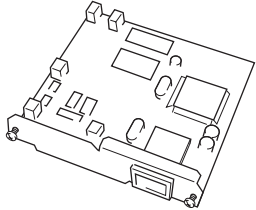
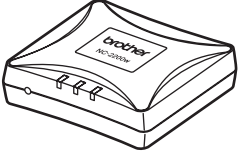
<p align="center"><b>Lower Tray Unit</b></p>	<p align="center"><b>DIMM Memory</b></p>
<p align="center"><b>LT-5000</b></p>	
 <p>Second lower paper tray expands total input capacity by another 250 sheets to a total input capacity of 500 sheets.</p>	 <p>For more details, see "Memory Board" in Chapter 13 (User's Guide).</p>
<p align="center"><b>Network Print/Fax Server ]</b></p>	<p align="center"><b>External Wireless Print/Scan Server</b></p>
<p align="center"><b>NC-9100h</b></p>	<p align="center"><b>NC-2200w</b></p>
 <p>The optional Network Print/FAX Server (NC-9100h) transforms your MFC into a Network Multi Function Center, offering Network Printing / Network PC-FAX and Network Scanning capability.</p>	 <p>The optional External Wireless Print/Scan Server (NC-2200w) provides wireless (IEEE 802.11b) network printing and the network scanning capability.</p>

# Replacement Consumables

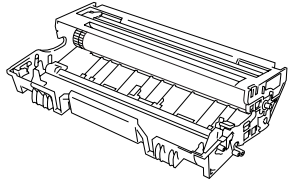
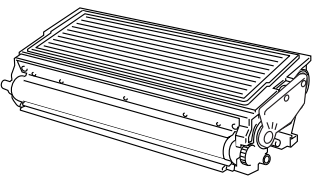
<p align="center"><b>Drum Unit</b></p>	<p align="center"><b>Toner</b></p>
<p align="center"><b>DR-510</b></p>	<p align="center"><b>TN-540/TN-570</b></p>
 <p>Up to 20,000 A4/Letter pages @ 5% coverage.</p>	 <p>TN-540: Up to 3,300 A4/Letter pages @ 5% coverage. TN-570: Up to 6,500 A4/Letter pages @ 5% coverage.</p>

Setting Up  
the Machine

Windows®  
USB

Windows®  
Parallel

Windows  
NT® 4.0  
Parallel

Windows®  
Network

Macintosh®  
USB

Macintosh®  
Network

For  
Administrators

## Trademarks

The Brother logo is a registered trademark of Brother Industries, Ltd.

Brother is a registered trademark of Brother Industries, Ltd.

Multi-Function Link is a registered trademark of Brother International Corporation.

©2005 Brother Industries, Ltd. All rights reserved.

Windows, Microsoft and Windows NT are registered trademarks of Microsoft in the U.S. and other countries.

Macintosh, QuickDraw, iMac and iBook are trademarks or registered trademarks of Apple Computer, Inc.

Postscript and Postscript Level 3 are registered trademarks or trademarks of Adobe Systems Incorporated.

PaperPort and OmniPage are registered trademarks of ScanSoft, Inc.

Presto! PageManager is a registered trademark of NewSoft Technology Corporation.

Each company whose software title is mentioned in this manual has a Software License Agreement specific to its proprietary programs.

**All other brand and product names mentioned in this manual are registered trademarks of their respective companies.**

## Compilation and Publication

Under the supervision of Brother Industries Ltd., this manual has been compiled and published, covering the latest product descriptions and specifications.

The contents of this manual and the specifications of this product are subject to change without notice.

Brother reserves the right to make changes without notice in the specifications and materials contained herein and shall not be responsible for any damages (including consequential) caused by reliance on the materials presented, including but not limited to typographical and other errors relating to the publication.

This product is designed for use in a Professional Environment.

©2005 Brother Industries, Ltd. ©1998-2005 TROY Group, Inc.

©1983-2005 PACIFIC SOFTWARES INC.

**brother**®

## Free Manuals Download Website

<http://myh66.com>

<http://usermanuals.us>

<http://www.somanuals.com>

<http://www.4manuals.cc>

<http://www.manual-lib.com>

<http://www.404manual.com>

<http://www.luxmanual.com>

<http://aubethermostatmanual.com>

Golf course search by state

<http://golfingnear.com>

Email search by domain

<http://emailbydomain.com>

Auto manuals search

<http://auto.somanuals.com>

TV manuals search

<http://tv.somanuals.com>