

## Making cooking as much fun as eating

Please read this instruction manual. This will ensure that you make full use of all the technical benefits the compact microwave oven has to offer.

It will provide you with important safety information. You will be familiarised with the individual components of your new microwave. And we will show you how to make settings step by step. It is quite simple.

The tables list the adjustment values and shelf levels for numerous well-known dishes. All these dishes are tested in our cooking studio.

In the unlikely event of a malfunction, look here for information on how to rectify minor faults yourself.

A detailed table of contents will help you to find your way around quickly.

Enjoy your meal.

---

## Instruction manual



HBC86K7.0

en

---

9000 039 068

B300585

# Table of contents

<b>Important information</b> .....	<b>5</b>
Before installation .....	5
Safety information .....	5
Safety information for microwave operation .....	7
Causes of damage .....	9
<b>Your new microwave oven</b> .....	<b>10</b>
The control panel .....	10
Buttons for selecting the microwave wattage .....	10
Function selector .....	11
Rotary knob .....	11
Control buttons and display panel .....	12
Fold away control knobs .....	12
Types of heating .....	13
Oven and Accessories .....	16
Cooling fan .....	17
<b>Before using for the first time</b> .....	<b>18</b>
Set the time .....	18
Selecting the language for the text display .....	18
Heating up the oven .....	18
Pre-cleaning the accessories .....	19
<b>The microwave</b> .....	<b>19</b>
Ovenware .....	20
Setting procedure .....	20
Selecting several follow-on microwave power settings .....	22

# Table of contents

<b>Setting the oven</b> .....	<b>23</b>
Setting procedure .....	23
If the oven is to switch off automatically .....	25
If the oven is to switch on and off automatically . . . .	26
<b>Rapid heating</b> .....	<b>27</b>
Setting procedure .....	28
<b>Setting the oven and microwave in combination</b>	<b>28</b>
Setting procedure .....	29
<b>Automatic programming</b> .....	<b>31</b>
Setting procedure .....	31
Notes on Automatic programs .....	34
Program table .....	37
<b>Memory</b> .....	<b>41</b>
Storing memory settings .....	41
Starting the Memory function .....	43
<b>Clock</b> .....	<b>44</b>
Setting procedure .....	45
<b>Auto start</b> .....	<b>46</b>
<b>Basic settings</b> .....	<b>46</b>
Setting procedure .....	47
<b>Childproof lock</b> .....	<b>48</b>
<b>Timer</b> .....	<b>49</b>
Setting procedure .....	49
<b>Safety switch-off</b> .....	<b>50</b>

# Table of contents

<b>Care and cleaning</b> .....	<b>51</b>
Appliance exterior .....	51
Oven .....	51
Cleaning the glass panels .....	54
Seal .....	56
Accessories .....	56
<b>Troubleshooting</b> .....	<b>56</b>
Replacing the oven lightbulb .....	58
Changing the door seal .....	59
<b>After-Sales Service</b> .....	<b>60</b>
<b>Tables and tips</b> .....	<b>61</b>
Defrosting, heating up and cooking with the microwave .....	61
Tips for microwave operation .....	66
Meat, poultry, fish .....	66
Advice on roasting and grilling .....	70
Cakes and pastries .....	70
Baking tips .....	73
Energy saving tips .....	74
Bakes, gratins, toast .....	74
Deep-Frozen Ready Meals .....	75
Braising .....	76
Tips for braising .....	77
<b>Acrylamide in food</b> .....	<b>78</b>
What can you do? .....	78
<b>Test dishes</b> .....	<b>80</b>

---

# Important information

Read this instruction manual carefully. Only then will you be able to operate your appliance safely and correctly.

Please keep the instruction and installation manual in a safe place. Please pass on these instruction manuals to the new owner if you sell the appliance.

---

## Before installation

### Disposing in an environmentally-responsible manner



Unpack the appliance and dispose of the packaging in an environmentally-responsible manner.

This appliance is labelled in accordance with the European Directive 2002/96/EG concerning used electrical and electronic appliances (waste electrical and electronic equipment – WEEE).

The guideline determines the framework for the return and recycling of used appliances as applicable.

### Transport damage

Check the appliance for damage after unpacking it. Do not connect the appliance if it has been damaged in transport.

### Electrical connection

If the power cable is damaged, it must be replaced by a specialist trained by the manufacturer in order to prevent hazards.

### Installing and connecting your microwave oven

Please observe the special installation manual.

---

## Safety information



This appliance is intended for domestic use only. Only use the microwave oven for preparing foodstuffs.

### Environment



Never expose the appliance to excessive heat or moisture. There is a risk of short-circuiting.

## Children and the microwave

Children are only permitted to use the solo microwave function if they have been instructed how to do so. They must be able to operate the microwave oven correctly. They must understand the hazards indicated in the instruction manual. Children must be supervised by adults at all times during combination oven operation. There is a risk of burning.

## Hot oven



Open the oven door carefully. Hot steam may escape.

Never touch the surfaces of heating and cooking appliances.

Never touch the internal surfaces of the microwave oven or the heating elements. There is a risk of burning.

Children must be kept at a safe distance from the appliance.

Never place combustible items in the microwave oven. Risk of fire!

Never open the microwave oven door if there is smoke inside. There is a risk of burning. Switch off the microwave oven. Pull out the mains plug or switch off the appliance by the fuse in the fuse box.

Never trap cables of electrical appliances in the hot oven door. The cable insulation could melt. There is a risk of short-circuiting.

## Damaged microwave oven door or door seal



Never use the microwave if the microwave oven door is open or if the door seal is damaged. Otherwise microwave energy may escape. Do not use the microwave again until it has been repaired.

## Inadequate cleaning



Clean the appliance on a regular basis. The surface of the appliance could be destroyed and the appliance could corrode over time if it is not cleaned with sufficient care. Microwave energy could escape.

## Repairs



Incorrect repairs are dangerous. There is a risk of electrocution!

Repairs may only be carried out by after-sales service technicians who have been fully trained by us.

If the appliance is faulty, switch it off by the fuse in the fuse box or disconnect the appliance at the mains. Contact the after-sales service.

You must not open the casing. The oven is a high voltage appliance. Risk of electrocution!

---

## Safety information for microwave operation



Use of the microwave is intended exclusively for the preparation of foodstuffs. Using the microwave for other purposes may be dangerous and may result in damage e.g. grains or cereals could catch fire when heated. Risk of fire

### Microwave power and time



Do not select a microwave power or time setting that is higher than necessary. The food could catch fire. The appliance could be damaged. Risk of fire  
Follow the information provided in the instruction manual.

### Ovenware



Only use ovenware that is suitable for use in a microwave.

Porcelain or ceramic ovenware can have small perforations in the handles or lid. These perforations conceal a cavity below. Any liquid that penetrates this cavity could cause the ovenware to crack. There is a risk of injury.

Meals heated in the microwave oven give off heat. The ovenware can become hot. There is a risk of burning. Always use an oven cloth or oven gloves to remove ovenware and accessories from the microwave.

### Packaging



Never heat meals in heat-retaining packages. Risk of fire.

Do not leave food heating unattended in containers made of plastic, paper or other combustible materials.

Airtight packaging may burst when food is heated. There is a risk of burning.

Follow the information provided on the packaging. Always use an oven cloth or oven gloves to remove meals.

## Drinks



There is a possibility of delayed boiling when a liquid is heated. This means that the liquid reaches boiling temperature without the usual steam bubbles rising to the surface. Even if the container only vibrates a little, the hot liquid can suddenly boil over or spatter. There is a risk of burning.

When heating liquids, always place a spoon in the container. This will prevent delayed boiling.

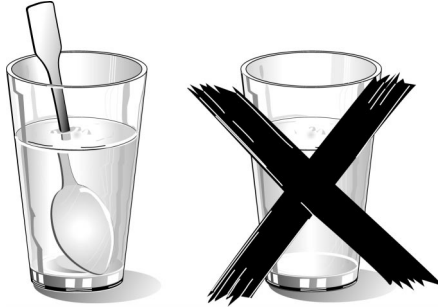

Never heat drinks in containers that have been tightly sealed. There is a risk of explosion.

Never overheat alcoholic drinks. There is a risk of explosion.

## Baby food



Never heat baby food in closed containers. Always remove the lid or teat.

Stir or shake well after the food has been heated. This is the only way to ensure even heat distribution. There is a risk of burning.

Check the temperature of the food before it is given to the child.

## Foods with shells or skin



Never cook eggs in their shells. Never reheat hard-boiled eggs as they may crack or explode. The same applies to shellfish and crustaceans. There is a risk of burning.

Always prick the yoke when frying or poaching eggs.

Always prick the skin of foodstuffs with peels or skins such as apples, tomatoes, potatoes and sausages before cooking to prevent the peel or skin from bursting.

## Drying food



Never use the microwave to dry food. Risk of fire



**Food with a low water content**



Do not defrost or heat food at too high a power or for too long if the food has a low water content, e.g. bread. Risk of fire

**Cooking oil**



Never use the microwave to heat cooking oil on its own. Risk of fire

---

## **Causes of damage**

**Baking tray or aluminium foil on the microwave floor**

Do not place baking trays on the microwave floor. Do not line the microwave floor with aluminium foil. This causes heat to accumulate. Baking and roasting times will no longer be correct and the enamel will be damaged.

**Water in the oven**

Never pour water directly into a hot microwave. This could damage the enamel.

**Fruit juice**

Do not place too much on the universal pan when baking very moist fruit cakes. Fruit juice dripping from the universal pan leaves stains that cannot be removed.

**Cooling with the microwave oven door open**

Only leave the microwave oven to cool with the door closed. Do not allow anything to become trapped in the microwave oven door. The fronts of adjacent units may be damaged over time even if you only leave the microwave oven door open slightly.

**Very dirty oven seal**

If the oven door seal is very dirty, the door will no longer close properly when the microwave is in operation. The front of adjacent units could be damaged. Keep the seal clean.

**Using the microwave oven door as a seat**

Do not stand or sit on the microwave oven door.

**Using the microwave oven without food**

Do not switch on the microwave unless there is food inside. The microwave could be overloaded if it is switched on without any food inside. An exception to this rule is for short-term testing of ovenware (see notes on ovenware).

# Your new microwave oven

Here you will learn more about your new microwave oven. The control panel and its switches and indicators are explained here. The types of heating available and the accessories included with your oven will be explained here.

## The control panel

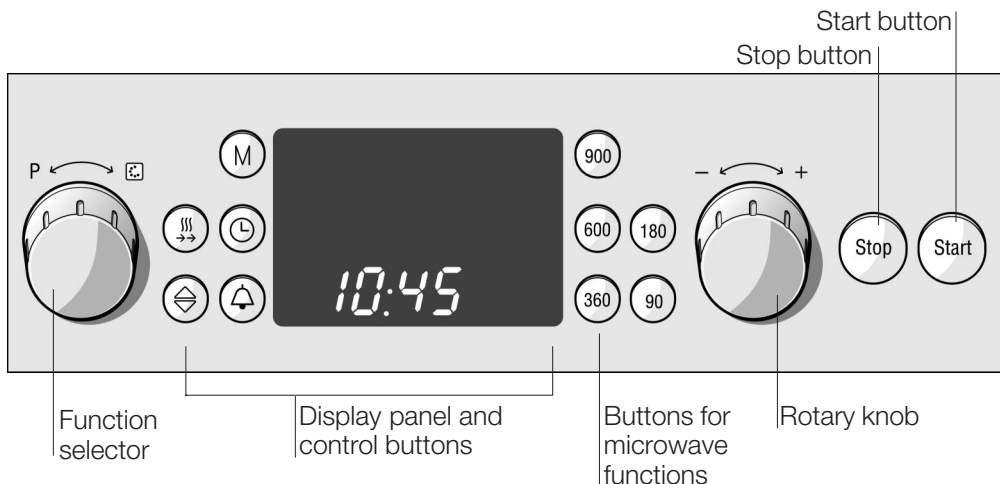

## Buttons for selecting the microwave wattage

Use these buttons to select the microwave wattage required.

90 W	for defrosting delicate foods
180 W	for defrosting and continued cooking
360 W	for cooking meat and heating delicate foods
600 W	for heating and cooking food
900 W	for heating liquids

The wattage selected is shown in the display when a button is pressed.

## Function selector

Set the mode of operation and the temperature using the function selector. Turning the function selector clockwise shows the type of heating and anticlockwise the programmes.

In the display you will see the type of heating you have selected and in the second line a temperature or level as a default value.

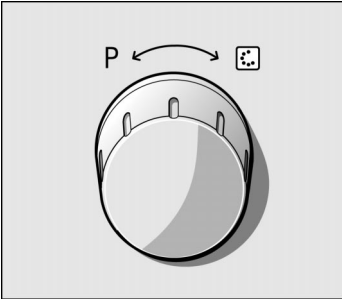

Mode of operation	Temperature range/levels
Top/bottom heating	30 - 300 °C
Intensive heat	100 - 300 °C
Hot air	30 - 250 °C
3D hot air	30 - 250 °C
Bottom heating	30 - 200 °C
Hot air grilling	100 - 250 °C
Grill, small area	low, moderate, high
Grill, large area	low, moderate, high
Braising	70 - 100 °C
Plate warming	30 - 70 °C
Keep warm	60 - 100 °C
Automatic programme	11 Program groups 51 Programs



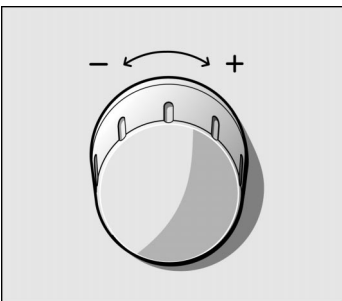

## Rotary knob

You use the rotary knob to set the time, duration, end time, timer, and weight for the automatic programs.



Ranges	
1 sec - 10.00 h	Duration
1 sec - 1.30 h	Microwave duration Exception: 900 W = 1 sec - 30 min
Weight	Depending on the program
1 sec - 10.00 h	Timer period

## Control buttons and display panel

 button	Use to change line in the text display
Rapid heating button 	Use to heat the oven quickly
Clock button 	Use to select the time or the end time →
M button	Use to select a memory mode
Timer button 	Use to select the kitchen timer function independent of the oven
Stop button	Use to stop oven operation or to cancel a setting
Start button	Use to start oven operation

The values set can be seen in the display panel.

The text display guides you through the setting. It shows the selected mode of operation and temperature or level. It shows the automatic program dishes and gives you information on settings. The text displays can be shown in several languages.

The heating indicator provides a visual display of the temperature increase. The heating indicator does not appear during grilling or the automatic programme.

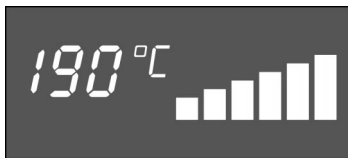

## Fold away control knobs

The control knobs fold away. To move them in and out, press the control knob.

You can turn the control knob clockwise or anti-clockwise.

## Types of heating

Different types of heating are available with the oven. You can therefore select the best method for cooking any dish.

### Microwaves

Microwaves are converted into heat in foodstuffs. Microwaves are suitable for rapid defrosting, warming, melting, and cooking.

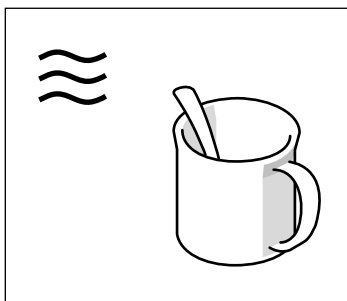

### Top/bottom heating

This ensures the even distribution of heat onto the cake or roast from the top and bottom of the oven. This is the optimal method for cooking sponge cakes in tins and sponge flans and cakes in the universal pan. Top and bottom heating is also suitable for lean joints of beef, veal and game.

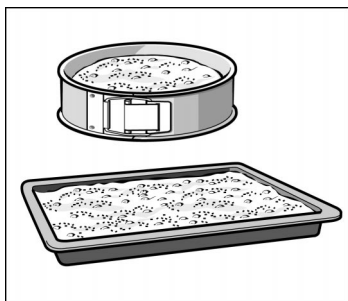

### Intensive heat

The strong heat from below gives baked goods a particularly crispy base. Savoury cakes such as Quiche Lorraine no longer require pre-baking. Intensive heat is also the ideal type of heating for baking in moulds made from tin, glass or porcelain, which reflect heat or are poor heat conductors.



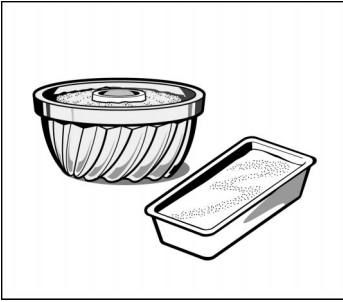

### Hot air

A fan on the back wall distributes the heat from the top and bottom elements equally throughout the oven. You can use hot air to bake sponge cakes in tins.

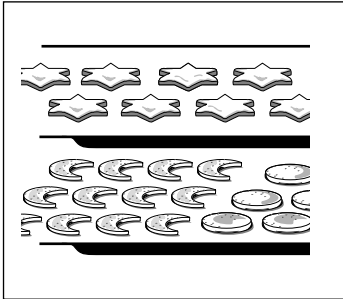

### 3D hot air

A ventilator on the back wall distributes heat from the upper and lower elements and the ring element evenly in the oven.

Using 3D hot air, you can bake cakes and biscuits on two levels. The required oven temperatures are lower than those for top and bottom heating. Additional baking trays may be obtained from specialist shops.

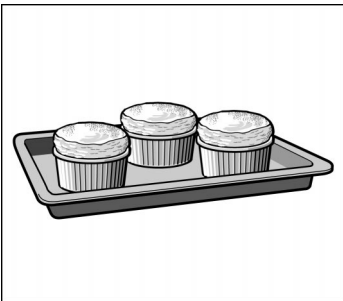

### Bottom heating

Using the bottom heating element, you can bake or brown meals from below. This is also suitable for cooking meals in a water bath.

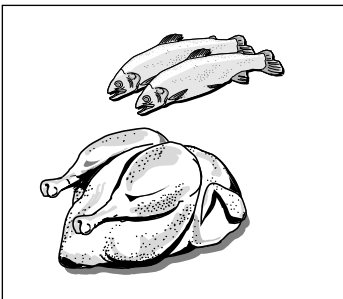

### Hot air grilling

This type of heating involves the grill element and the fan switching on and off alternately. During the pause in heating, the fan circulates the heat generated by the grill around the food. This ensures that pieces of meat are crisped and brown on all sides.

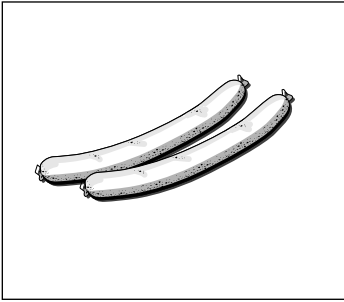

### Grill, small area

Only the middle section of the grill heating element is switched on.

This type of heating is ideal for cooking small quantities and saves energy. Place the items to be grilled in the centre of the wire rack.

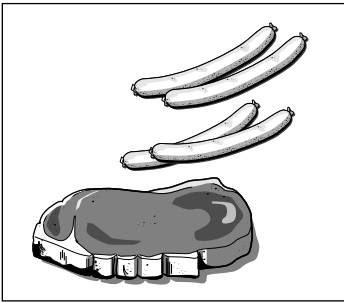

### Grill, large area

The entire area under the grill heating element becomes hot. This is ideal if you wish to cook several steaks, sausages, pieces of fish or slices of toast.

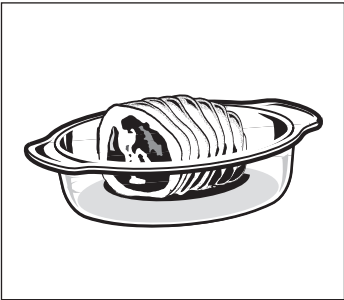

### Braising

Braising in the temperature range from 70 °C to 100 °C produces particularly succulent results with all types of meat.

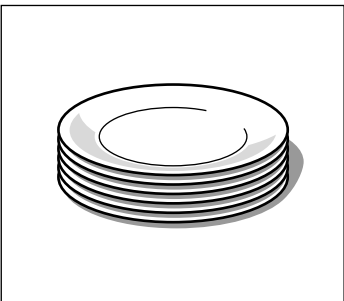

### Plate warming

You can use temperatures from 30 °C to 70 °C to warm porcelain dishes.

Food does not cool down as quickly in warmed dishes, and drinks also remain warm longer.

Always use an oven cloth or oven glove when removing dishes from the oven.

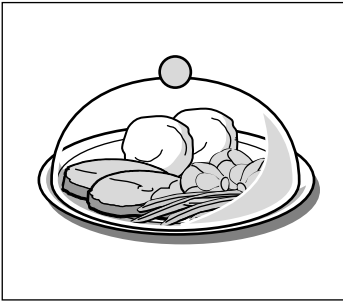

### Keep warm

You can use temperatures from 60°C to 100 °C to keep food warm. Remember that warm food spoils more easily, so you should therefore not keep dishes warm for longer than two hours.

---

## Oven and Accessories

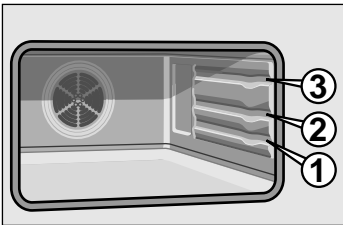

The accessories can be inserted into the oven at 3 different levels.



You can pull the accessories out by two thirds without causing them to tip. This enables easy removal of dishes from the oven.

### Accessories

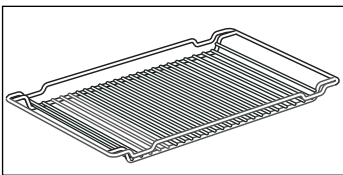
Accessories may be purchased at a later date from the after-sales service or from specialist shops. Please specify the HEZ/HMZ number.



### Wire rack

For ovenware, cake tins, roasting tins and grilled foods. The wire rack can be used with the curvature facing up  or down .

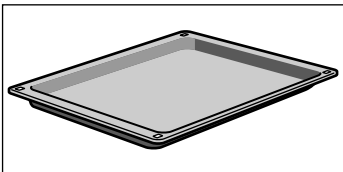

### Universal pan HEZ862000

For large roasts, dry and moist cakes, bakes and gratins. It can also act as a splashguard if you are grilling meat directly on the wire rack. To do this, insert the universal pan at level 1.

Insert the universal pan into the oven with the tapered edge facing the oven door.



## Special accessory

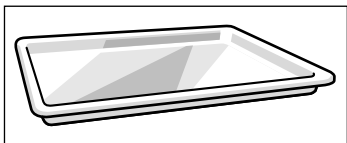

### **Glass pan HEZ863000**

For large roasts, dry and moist cakes, bakes and gratins. It can also act as a splashguard if you are grilling meat directly on the wire rack. To do this, insert the universal pan at level 1.

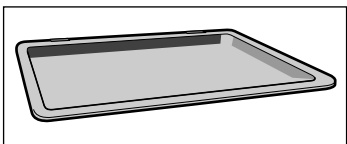

### **Enamel baking tray HEZ861000**

for cakes and biscuits.

Push the baking tray as far as possible into the oven, with the sloping edge facing towards the oven door.

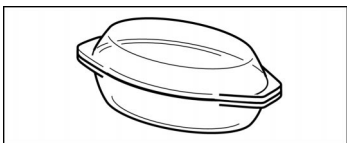

### **Glass roasting dish HMZ21 GB**

for braised dishes and bakes that are cooked in the oven. This is particularly suitable for automatic programs.

## Note

Condensation may appear on the door panel, interior walls and floor. This is normal and does not affect the operation of the microwave. Wipe away the condensation after cooking.

---

## Cooling fan

The oven is equipped with a cooling fan. It switches on and off automatically when necessary. The warm air escapes above the door.

The oven remains cold when the microwave is in operation. The cooling fan may switch on anyway. The fan may run on even when microwave operation has ended.

---

# Before using for the first time

This section tells you everything you need to do before using the cooker for the first time.

Heat the oven and clean the accessories. Read the safety instructions in the “Important information” section.

Firstly, check to see if the ⌚ clock symbol and three zeros are flashing in the display. “Set time” appears in the display.

---

## Set the time

1. Set the time using the rotary knob.
2. Press the ⌚ clock button.

The oven is now ready for use.

---

## Selecting the language for the text display

The texts appearing in the display of your appliance are in German.

You can choose different languages for the text display.

### Changing the language

1. Press the “M” button until “Sprache auswählen” appears in the first line.
2. Use the button  to change to the second line.
3. Use the function selector to choose the language.
4. Press the “M” button.  
The language is saved.



---

## Heating up the oven

Heat the empty oven with the door closed to remove the new oven smell.

### Method

1. Using the function selector, choose hot air.

2. Use button  to change to the second line.
3. Using the function selector, set the temperature to 250 °C.
4. Press the  clock button. The display shows 20.00 minutes.
5. Press the Start button.

After 20 minutes, the oven switches itself off. The display reads “End time”. A signal sounds. Press the Stop button. The signal stops and the time is displayed again.

Ventilate the kitchen for as long as the oven is heated.

---

## Pre-cleaning the accessories

Please wash the accessories thoroughly with soapy water and a cleaning cloth before using them.

---

## The microwave

The microwave can be used solo, i.e. on its own, or in combination with a different type of heating.

Here you will find information about ovenware and how to set the microwave.

### Tables and tips

The Tables and tips section contains a number of examples of how to defrost, heat and cook using the microwave.

---

## Ovenware

### Suitable ovenware

Suitable dishes are heat-resistant ovenware made of glass, glass ceramic, porcelain, ceramic or heat-resistant plastic. These materials do not reflect microwaves.

You can also use serving dishes. This saves you having to transfer food from one dish to another. You should only use ovenware with gold or silver rims if the manufacturer guarantees that they are suitable for use in microwave ovens.

### Unsuitable ovenware

Metal ovenware is unsuitable.

Metal reflects microwaves. Food in covered metal containers will remain cold.

Important Metal - e.g. a spoon in a glass - must be kept at least 2 cm from the oven walls and the inside of the door. Sparks could destroy the glass on the inside of the door.

### Ovenware test

Do not switch on the microwave unless there is food inside.

The following ovenware test is the only exception to this rule.

Perform the following test if you are unsure whether your ovenware is unsuitable for use in the microwave: heat the empty ovenware at maximum power for between 30 and 60 seconds. Check the temperature of the ovenware during this period. The ovenware should still be cold or warm to the touch. The ovenware is unsuitable if it becomes hot or sparks are generated.

---

## Setting procedure

Microwave power can be set to 900 watts for a maximum of 30 minutes. A cooking time of 90 minutes is possible with all other power settings.

Example:  
Microwave power 600 W, 3 minutes

1. Press the button for the microwave power setting you require.

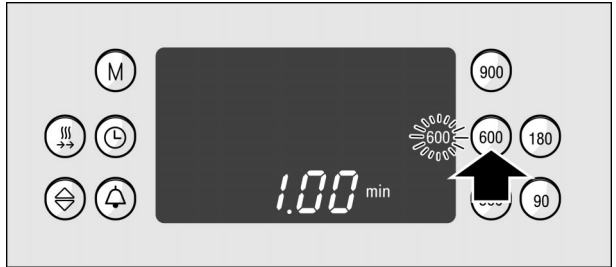

2. Set the cooking time using the rotary knob.

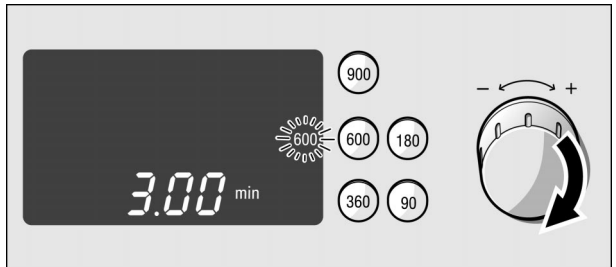

3. Press the Start button.  
The cooking time counts down in the display.

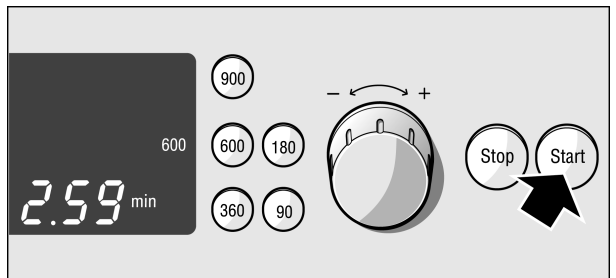

**The cooking time has elapsed**

A signal sounds. The oven switches off. The display shows "End time" or "Oven cooling". The clock reappears in the display if you press the Stop button or open the oven door.

**To change the cooking time**

You may change the cooking time at any time.

## Pausing

Open the oven door. The program is interrupted. The cooling fan may run on. Press the Start button again once you have closed the door. The program will then continue.

If you forget to press the Start button, you will hear a signal after three seconds. "Press Start button" appears in the display.

## Canceling the setting

Press the Stop button twice or open the oven door and press the Stop button once.

## Notes

Cooking time is displayed as follows:

up to **1.00** min in blocks of 1 second

up to **15.00** min in blocks of 10 seconds

up to **1.00** h in blocks of 30 seconds

up to **1.30** h in blocks of 5 minutes.

You can also set the cooking time first and then the microwave power.

---

## Selecting several follow-on microwave power settings

You can select up to three power settings and cooking times for your dish.

Make settings as described in steps 1 and 2. Then select a second power setting and cooking time and if necessary a third.

Now press the Start button.

The total cooking time appears in the display. It counts back to zero. The active power setting lights up more brightly.

## Note

You can also select the same power setting twice: e.g. 600 watts - 360 watts - 600 watts.

The 900 W power setting can only be selected once.

Once the oven has been started, you can no longer change the cooking time.

# Setting the oven

## Switching off the oven manually

There are various ways in which you can set your oven.

## The oven switches off automatically

The oven switches off automatically when the meal is ready.

## The oven switches on and off automatically

You can leave the kitchen for a long time.

## Tables and tips

You can set the oven so that you place the meal in the oven in the morning and it is ready at lunch time.

In the “Tables and tips” section, you will find suitable settings for many dishes.

## Setting procedure

Example:  
Top/bottom heating, 190 °C

1. Turn the function selector clockwise until the required type of heating appears.  
The default temperature or setting is displayed in the second line.



2. Press the  button to move to the second line.

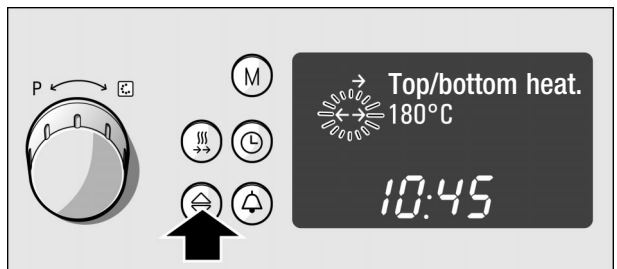

3. Use the function selector to set the required temperature or setting.

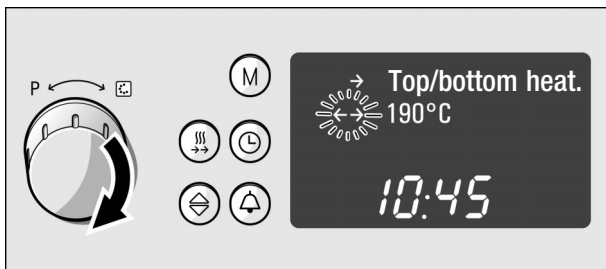

4. Press the Start button.

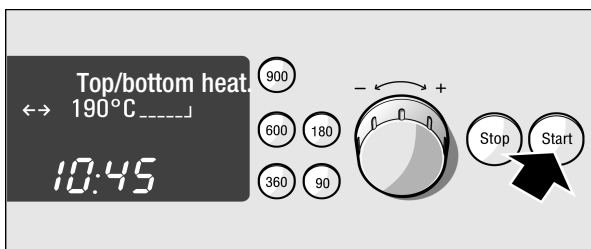

### Switching off

When the dish is ready, press the Stop button twice or open the oven door and press the Stop button once. The display goes out.

### Changing the setting

You may change the temperature or grill setting at any time.

### Pausing

Open the oven door. The cooling fan may run on. Press the Start button again once you have closed the door. The program will then continue. If you forget to press the Start button, you will hear a signal after three seconds. "Press Start button" appears in the display.

### Cancelling the setting

Press the Stop button twice or open the oven door and press the Stop button once. The display goes out.

### Heating indicator

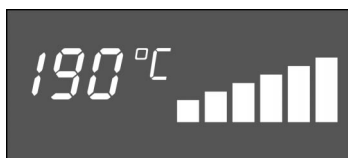

The heating indicator provides a visual display of increasing oven temperature. The heating indicator does not appear if you are grilling.



## If the oven is to switch off automatically

4. Press the ⌚ clock button. 20 minutes appears in the display. Set the required cooking time using the rotary knob.

Make the settings as described in steps 1 to 3. Set the cooking time for your dish.

Example:  
Cooking time 45 minutes

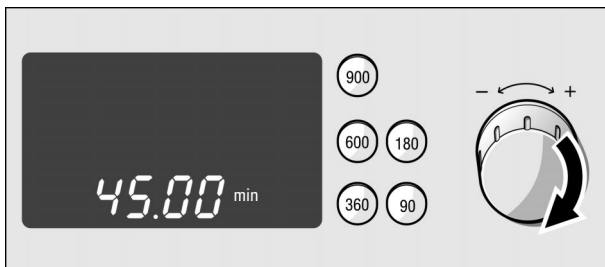

5. Press the Start button.

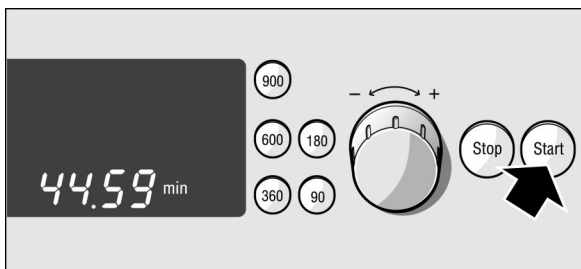

The cooking time counts down in the display.

### The cooking time has elapsed

A signal sounds. The oven switches off. The display shows "End time" or "Oven cooling". The clock reappears in the display if you press the Stop button or open the oven door.

### Changing the setting

You may change the cooking time and temperature at any time.

### Pausing

Press the Stop button or open the oven door. Press the Start button after closing the door.

### Cancelling the setting

Press the Stop button twice or open the door and press the Stop button once.

## Note

You can also set the cooking time first and then the type of heating and temperature. Set the cooking time using the rotary knob and then the type of heating using the function selector. Press the  button and change the temperature. Start the oven.



## If the oven is to switch on and off automatically

Please remember that easily spoiled foods must not be allowed to remain in the oven for too long.

Make the settings as described in steps 1 to 4. Do not start the oven yet.

Example:

It's 10:45 a.m. The dish will take 45 minutes to cook and must be ready at 12:45 p.m.

5. Press the  clock button until "Set end time" is displayed. The  end time symbol flashes in the display and the end time is shown. This is the time at which the dish will be ready.



6. Use the rotary knob to set a later end time.

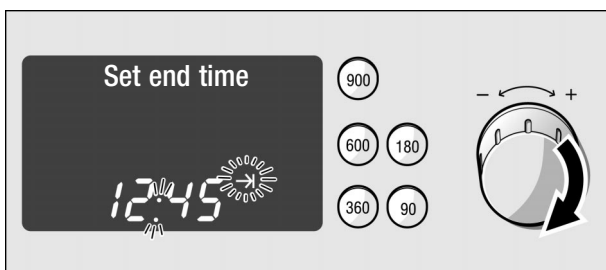

## 7. Press the Start button.

The setting is adopted. The display will show the end time until the oven switches on. The → end time symbol lights up. The oven switches on at the appropriate time.

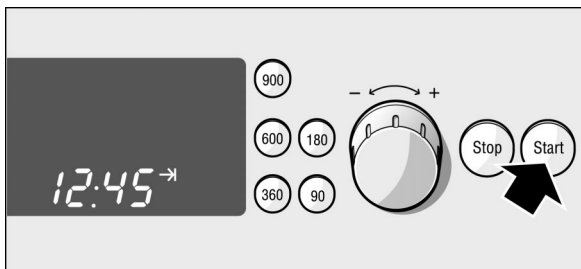

### To change the end time.

The oven must not be switched on. Press the ⌚ clock button thrice and change the end time.

### The cooking time has elapsed

A signal sounds. The oven switches off. The display shows “End time” or “Oven cooling”. The clock reappears in the display when you press the Stop button.

### Cancelling the setting

Press the Stop button once.

### Note

You can change the setting while the symbol is flashing.

The setting has been adopted if the symbol is lit.

In the meantime, you can call up the preset time, duration and end time. To do so, press the ⌚ clock button.

---

## Rapid heating

This allows you to heat up the oven particularly quickly. The rapid heating function is not suitable for all types of heating.

### Suitable types of heating

Top/bottom heating

Intensive heat

Hot air



3D hot air

Rapid heating is also suitable for the types of heating that combine the oven and microwave.

The set cooking time will only begin after the preheating time has elapsed.

---

## Setting procedure

1. Set the oven as required.
2. Press the rapid heating button .  
The symbol  is shown in the display.
3. Press the Start button.  
The oven will heat up.

### Rapid heating is complete

You will hear a short signal. The  symbol will go out. Put your dish in the oven. Press the Start button again. Only at this point does the preset duration begin counting down.

### Cancelling the rapid heating function

Press the rapid heating button . The symbol will go out. The rapid heating process is cancelled.

### Pausing

Press the Stop button. To continue rapid heating, press the Start button again.

### Notes

The rapid heating function will not work if the temperature set is below 100 °C.  
If the temperature in the oven is only slightly below the temperature set, the rapid heating function is not necessary. It will not switch on.

---

## Setting the oven and microwave in combination

On this setting, a type of heating is in operation at the same time as the microwave.

You cannot combine the 900 W microwave setting with a type of heating. If you try to do this, "Not possible" appears in the display.

You can set up to three microwave settings and times, but only one type of heating and temperature. You can set a duration of up to 1 hour and 30 minutes.

## Suitable types of heating:

Top/bottom heating  
Hot air  
3D hot air  
Hot air grilling  
Grill, small area  
Grill, large area

## Setting procedure

Example:

Microwave power 600 W, 35 minutes,  
hot air grilling 180 °C

1. Press the button for the microwave setting you require.

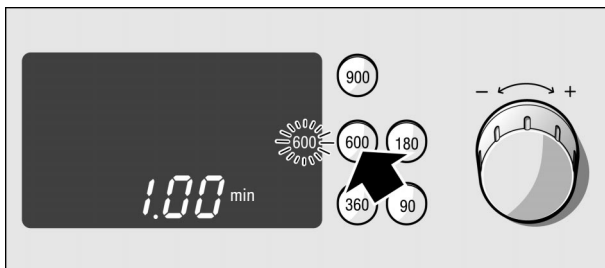

2. Set the required cooking time using the rotary knob.



3. Turn the function selector clockwise until the required type of heating appears.

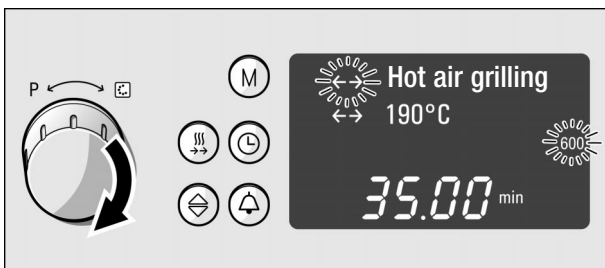

4. Press the  button to move to the second line.



5. Use the function selector to set the required temperature or level.

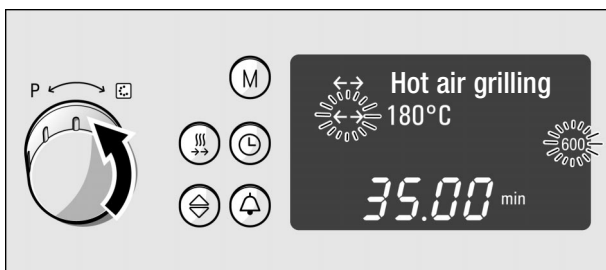

6. Press the Start button.  
The cooking time counts down in the display.

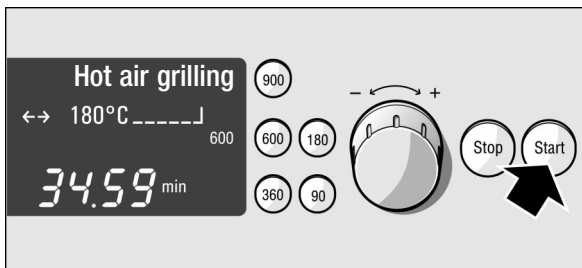

**The cooking time has elapsed**

A signal sounds. The oven switches off. The display shows "End time" or "Oven cooling". Open the oven door or press the Stop button.

**Changing the setting**

You may change the temperature, grill setting or cooking time at any time.

**Pausing**

Open the oven door. The program is interrupted. The cooling fan may run on. Press the Start button again once you have closed the door. The program will then continue.

If you forget to press the Start button, you will hear a signal after three seconds. "Press Start button" appears in the display.

## Canceling the setting

Press the Stop button twice or open the oven door and press the Stop button once.

## Setting the oven and microwave oven to switch on and off automatically

Make the settings as described in steps 1 to 5. Press the j clock button until “Set end time” is displayed. Use the rotary knob to set a later end time and then press the Start button again.

## Note

You can also set the type of heating and temperature first and then the microwave power and cooking time.

---

# Automatic programming

---

## Setting procedure

You can use the automatic programming to defrost food with the greatest of ease and prepare a variety of dishes quickly and easily.

The automatic programming contains 11 program groups covering a total of 51 programs.

Example:

Minced meat, deep frozen, 1000 g

1. Turn the function selector clockwise and select a program group.



2. Press the  button.  
The first program and default weight appear in the display.

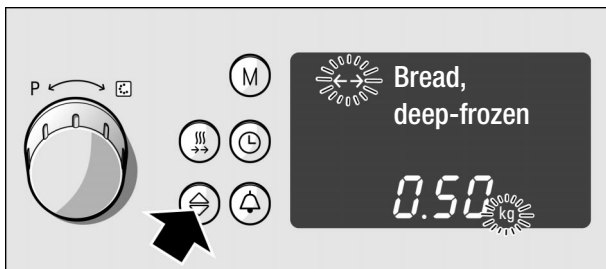

3. Use the function selector to select the required program.  
The default weight appears in the display.

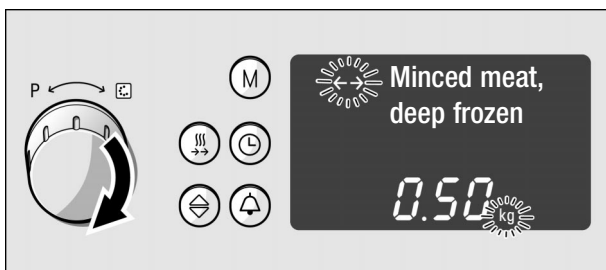

4. Use the rotary knob to set the weight required.

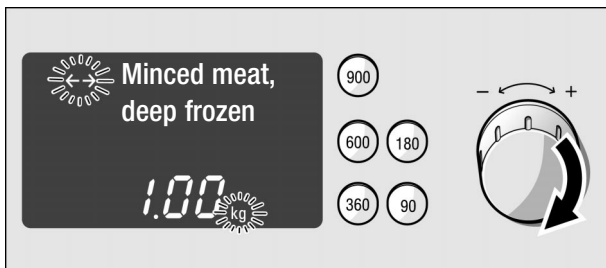

5. Press the Start button.  
The time counts down in the display.

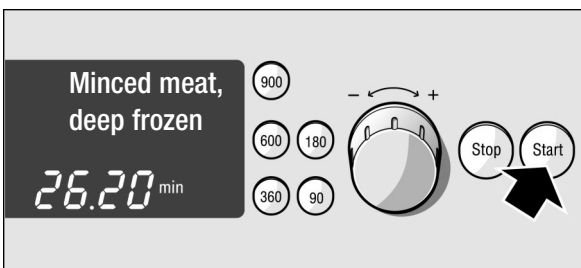

### The time has elapsed

A signal sounds. The oven switches off. "End time" appears in the display. If the oven is still hot, "Oven cooling" is displayed. Open the oven door or press the Stop button.



## Adjusting the cooked food to suit individual tastes

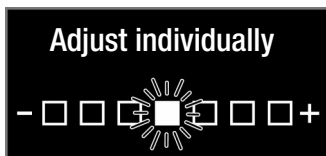

If the cooked food is not cooked to suit your taste, you can change it.

Make the settings as described in steps 1 to 4. Press and hold the  button for a few seconds and use the function selector to move the lit field to the left or right. to the left = food cooked at lower intensity to the right = food cooked at higher intensity

If you always like your food to be cooked at a lower or higher intensity, you can change the “Adjust individually” setting.

See the Basic settings section for more details.

## Information on the accessories

You can obtain information on the accessories required by pressing the “M” memory button.

## Pausing

Open the oven door. The cooling fan may run on. Press the Start button again once you have closed the door. The program will then continue. If you forget to press the Start button, you will hear a signal after three seconds. “Press Start button” appears in the display.

## Cancelling

Press the Stop button twice or open the oven door and press the Stop button once.

## Setting the program to switch on and off automatically

Please remember that easily spoiled foods must not be allowed to remain in the oven for too long. Make the settings as described in steps 1 to 4. Press the j clock button until “Set end time” is displayed. Use the rotary knob to set the end time to later, and press the Start button again.

## Notes

The cooking time cannot be changed.

The heating indicator is not shown in the automatic programming.

Some programs call for the food to be stirred or turned. “Please turn” or “Please stir” appears in the display. A signal sounds. The text remains in the display until the oven door is opened or the program is complete.

---

## Notes on Automatic programs

Remove the food from all packaging and weigh it. If you cannot enter the exact weight, round it up or down.

For the programs, always use microwave-proof ovenware such as glass, ceramic, or the universal pan. See the notes on accessories in the program table.

Place the food in the cold oven.

A table with suitable foods, the appropriate weight range, and the required accessories is included at the end of the notes.

It is not possible to set weights outside of the weight range.

When cooking many dishes, you will hear a signal after a short period. Turn or stir the food as directed.

If possible, freeze and store food flat and in portions at  $-18^{\circ}\text{C}$ .

Put the frozen food on a flat dish, e.g. a glass or porcelain plate.

Cover thin pieces and protruding pieces with small pieces of aluminium foil. This prevents these parts from overcooking. Ensure that the foil does not touch the oven walls.

After defrosting, allow the food to defrost for a further 10 to 90 minutes until it reaches room temperature.

Liquid will be produced when defrosting meat, poultry or fish. Drain off this liquid when turning and under no circumstances should it be used for other purposes or be allowed to come into contact with other foods.

Place beef, lamb and pork on the dish fatty-side down first.

Bread should only be defrosted in the required amounts, as it quickly becomes stale.

After turning, remove any minced meat that has already defrosted.

## Defrosting

Poultry should be placed in the dish breast-side down and poultry pieces skin-side down. Cover legs and wings with small pieces of aluminium foil.

For whole fish, cover the tail with aluminium foil, for fish fillets cover the edges and for fish cutlets cover the protruding ends.

## **Vegetables**

Vegetables, fresh: Cut into pieces of equal size. Add two tablespoons of water for every 100 g vegetables.

Vegetables, frozen: This program is only suitable for blanched, and not pre-cooked vegetables. The program is not suitable for frozen vegetables in cream sauce. Add 1 to 2 tablespoons of water per 100 g. Do not add water to spinach or red cabbage.

## **Potatoes**

Boiled potatoes: Cut into pieces of a uniform size. Add 2 tablespoons of water per 100 g potatoes, and add salt to taste.

Potatoes boiled in their skins: Use potatoes of equal size. Wash the potatoes and prick them all over. Place the wet potatoes in a dish. Do not add water.

## **Cereal products**

Cereal products foam a lot during cooking. Therefore use a tall dish with a lid for all cereal products. Enter the weight of the uncooked cereal product (without liquid).

Rice: Do not use boil-in-the-bag rice. Add two to two and a half times the amount of liquid to the rice.

Polenta: For polenta, add two to three times the amount of water.

Couscous: Add two times the amount of liquid to the couscous.

Quinoa: Add double the amount of liquid to the quinoa.

Millet: Add two to two and a half times the amount of liquid to the millet.

**Fish** Whole fish, fresh: Add 1 to 3 tablespoons of water or lemon juice.  
Fillet of fish, fresh: Add 1 to 3 tablespoons of water or lemon juice.

Breaded squid rings, deep-frozen: They must be suitable for cooking in the oven.

**Poultry** Place the chicken in the dish breast-side down.  
Place chicken pieces in the dish skin-side down.  
Cook the turkey breast without the skin. Add 100-150 ml liquid to the turkey breast. Add another 50-100 ml liquid after turning if necessary.

**Meat** Cook sirloin fatty-side down first.  
Beef joint, roast veal, leg of lamb and roast pork: The roast should cover two thirds of the dish base. Add 50 ml liquid to the roast. Add another 50-100 ml liquid after turning if necessary.  
Add 50-100 ml liquid to the meat loaf.

**Bake, deep-frozen** Place the meal in microwavable ovenware on the wire rack in shelf position 1.

**Potato products, deep-frozen** Chips, croquettes and fried potatoes must be suitable for preparation in the oven.

**Snacks, deep-frozen** Spring rolls and mini spring rolls must be suitable for preparation in the oven. Pretzels can be put in the oven without being defrosted beforehand.

**Pizza, deep-frozen** Use pre-cooked, deep-frozen pizza and pizza baguettes.

**Standing time** Some dishes need some cooling down time in the oven after the program has ended.

<b>Meal</b>	<b>Standing time</b>
Vegetables	approx. 5 minutes
Potatoes	approx. 5 minutes. Strain the remaining water.
Cereal products	5 10 minutes

Meal	Standing time
Turkey breast	10 minutes
Sirloin, beef joint, roast veal, leg of lamb, roast pork, meat loaf	10 minutes

## Program table

Program group Program	Suitable foodstuffs	Weight range in kg	Ovenware/accessories, shelf height
<b>Defrosting</b>			
Bread, deep-frozen***	Wheat bread, mixed bread, wholemeal bread	0.20 - 1.50	Flat dish without lid, Wire rack, level 1
Cakes, dry, deep-frozen*	Sponge cake without icing, yeast cake	0.20 - 1.50	Flat dish without lid, Wire rack, level 1
Cakes, moist, deep-frozen	Sponge cake with fruit without frosting, icing or gelatine, with no butter-filling or cream	0.20 - 1.20	Flat dish without lid, Wire rack, level 1
Minced meat, deep frozen*	Minced beef, lamb, or pork	0.15 - 1.00	Flat dish without lid, Wire rack, level 1
Beef, deep-frozen**	Beef joint, roast veal, steak	0.20 - 2.00	Flat dish without lid, Wire rack, level 1
Lamb, deep-frozen**	Leg of lamb, lamb shoulder, roast lamb	0.50 - 2.00	Flat dish without lid, Wire rack, level 1
Boned pork, deep-frozen**	Roasting joint without bones, roast chops, schnitzel, casserole	0.20 - 2.00	Flat dish without lid, Wire rack, level 1
Whole poultry, deep-frozen**	Chicken, duck	0.70 - 2.00	Flat dish without lid, Wire rack, level 1
Poultry pieces, deep-frozen**	Chicken thigh, half a chicken, leg of goose, goose breast, duck breast	0.20 - 1.20	Flat dish without lid, Wire rack, level 1
Whole fish, deep-frozen**	Trout, haddock, cod	0.20 - 1.20	Flat dish without lid, Wire rack, level 1
Fish fillet, deep-frozen**	Fillet of pike, cod, salmon, rosefish, pollock, pike-perch	0.20 - 1.00	Flat dish without lid, Wire rack, level 1
Fish steak, deep-frozen**	Cod, pike, haddock, salmon steak	0.20 - 1.00	Flat dish without lid, Wire rack, level 1

\* Signal to turn approximately ½ of the time has passed

\*\* Signal to turn after ⅓ and ⅔ of the time has passed

\*\*\* Signal to turn after ⅔ of the time has passed

Program group Program	Suitable foodstuffs	Weight range in kg	Ovenware/accessories, shelf height
<b>Vegetables</b>			
Vegetables, fresh*	Cauliflower, broccoli, carrots, cabbage turnips, leeks, peppers, courgettes	0.20 - 1.00	Flat dish with lid, Wire rack, level 1
Vegetables, deep-frozen*	Cauliflower, broccoli, carrots, cabbage turnip, red cabbage, spinach	0.15 - 1.00	Flat dish with lid, Wire rack, level 1
* Signal to stir ½ of the time has passed			
<b>Potatoes</b>			
Boiled potatoes*	Firm potatoes, quite firm potatoes, floury potatoes	0.20 - 1.00	Flat dish with lid, Wire rack, level 1
Jacket potatoes*	Firm potatoes, quite firm potatoes, floury potatoes	0.20 - 1.00	Flat dish with lid, Wire rack, level 1
* Signal to stir ½ of the time has passed			
<b>Cereal products</b>			
Long-grain rice*		0.10 - 0.50	Tall dish with lid, Wire rack, level 1
Basmati rice*		0.10 - 0.50	Tall dish with lid, Wire rack, level 1
Natural rice*		0.10 - 0.50	Tall dish with lid, Wire rack, level 1
Polenta*		0.10 - 0.50	Tall dish with lid, Wire rack, level 1
Couscous**		0.10 - 0.50	Tall dish with lid, Wire rack, level 1
Quinoa*		0.10 - 0.50	Tall dish with lid, Wire rack, level 1
Millet*		0.10 - 0.50	Tall dish with lid, Wire rack, level 1
* Signal for stirring, depending on weight, after approx. 2-14 minutes.			
** Signal to stir after 1-2 minutes.			
<b>Fish</b>			
Whole fish, fresh	Trout, mackerel, pike-perch	0,30 - 1,10	Tall dish with lid, Wire rack, level 1
Fish fillet, fresh	Fillet of pike, cod, rosefish, pollock, pike-perch	0.20 - 1.00	Tall dish with lid, Wire rack, level 1
Breaded squid rings, deep-frozen*		0.20 - 0.50	Universal pan, level 2
* Signal to turn after ¾ of the time has passed			

Program group Program	Suitable foodstuffs	Weight range in kg	Ovenware/accessories, shelf height
<b>Poultry</b>			
Whole chicken, fresh*		0.80 - 1.80	Tall dish with lid, Wire rack, level 1
Chicken portions, fresh	Chicken thigh, half a chicken	0.40 - 1.20	Tall dish with lid, Wire rack, level 1
Turkey breast, fresh**	Skinless turkey breast	0.80 - 2.00	Flat dish with lid, Wire rack, level 1
* Signal to turn after $\frac{2}{3}$ of the time has passed if whole chicken			
** Signal to turn after $\frac{1}{2}$ of the time has passed			
<b>Meat</b>			
Sirloin, fresh*	Sirloin, 5 - 6 cm in height	0.80 - 2.00	Dish without lid, Wire rack, level 1
Sirloin, rare, fresh*	Sirloin, 5 - 6 cm in height	0.80 - 2.00	Dish without lid, Wire rack, level 1
Beef joint, fresh**		0.80 - 2.00	Flat dish with lid, Wire rack, level 1
Roast veal, fresh*	Upper leg, joint	0.80 - 2.00	Flat dish with lid, Wire rack, level 1
Leg of lamb medium-rare, fresh*	Boned leg of lamb	1.00 - 2.00	Flat dish with lid, Wire rack, level 1
Roast pork, fresh*	Boned neck joint, roast chops	0.80 - 2.00	Flat dish with lid, Wire rack, level 1
Roast pork + crackling		0.80 - 2.00	Flat dish with lid, Wire rack, level 1
Meat loaf	Meat loaf, 8 cm in height	0.80 - 1.50	Dish with lid, Wire rack, level 1
* Signal to turn $\frac{1}{2}$ of the time has passed			
** Signal to turn after $\frac{1}{3}$ and $\frac{2}{3}$ of the time has passed.			
<b>Bake, deep-frozen</b>			
Lasagna bolognese, deep-frozen		0.40 - 1.00	Dish without lid, Wire rack, level 1
Canneloni, deep-frozen		0.40 - 1.00	Dish without lid, Wire rack, level 1
Macaroni bake, deep-frozen		0.40 - 1.00	Dish without lid, Wire rack, level 1

Program group Program	Suitable foodstuffs	Weight range in kg	Ovenware/accessories, shelf height
<b>Potato products, deep-frozen</b>			
	Chips, thick-cut, deep-frozen*	0.20 - 0.60	Universal pan, level 2
	Chips, thin-cut, deep-frozen*	0.20 - 0.50	Universal pan, level 2
	Croquettes, deep-frozen*	0.20 - 0.70	Universal pan, level 2
	Fried potatoes, deep-frozen*	0.20 - 0.80	Universal pan, level 2
* Signal to turn after $\frac{2}{3}$ of the time has passed.			
<b>Snacks, deep-frozen</b>			
	Spring rolls, deep-frozen*	0.10 - 1.00	Universal pan, level 2
	Mini spring rolls, deep-frozen*	0.10 - 0.60	Universal pan, level 2
	Pretzels, deep-frozen	0.10 - 0.40	Universal pan, level 2
* Signal to turn $\frac{1}{2}$ of the time has passed			
<b>Pizza, deep-frozen</b>			
	Pizza, precooked, thin base, deep-frozen	0.30 - 0.50	Universal pan, level 1
	Pizza, precooked, thick base, deep-frozen	0.40 - 0.60	Universal pan, level 1
	Mini pizza, precooked, deep-frozen	0.15 - 0.60	Universal pan, level 1
	Pizza baguette, deep-frozen	0.10 - 0.75	Universal pan, level 1



# Memory

You can use the memory to create your own programs. You can save the settings for six dishes and use them again at any time in the future.

It is useful to use the memory if you are preparing a dish that requires several different settings, or if you prepare a particular dish frequently.

You can also save a meal from the automatic program function.

## Storing memory settings

1. Press the “M” memory button.  
“Set memory” shows in the display and a 1 indicating the first memory location.

To change to a different memory location, press the “M” memory button again.

2. Press the button for the microwave power setting you require.

Select one of the six memory locations and set it.

Example:

Memory location 1, 360 W, 7 minutes, hot air, 220 °C

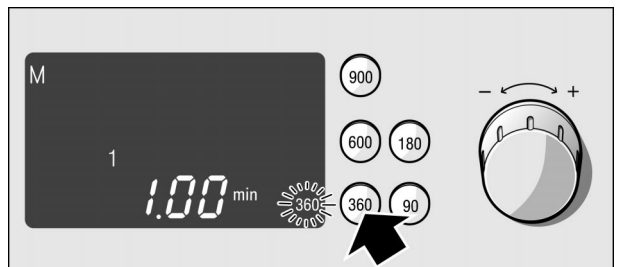
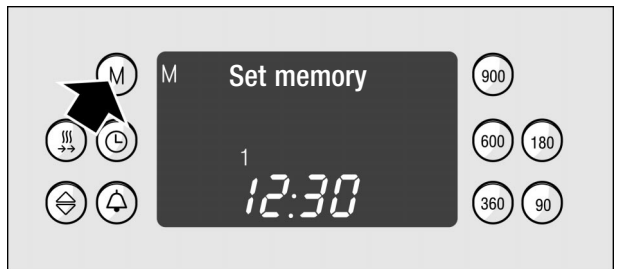

3. Set the cooking time using the rotary knob.

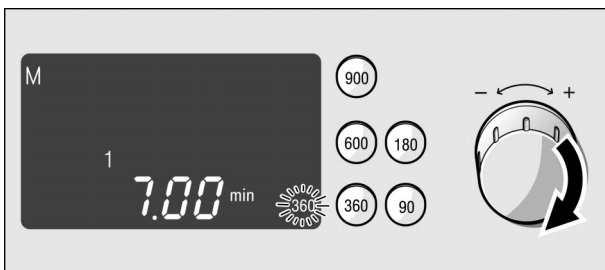

4. Use the function selector to set the type of heating.

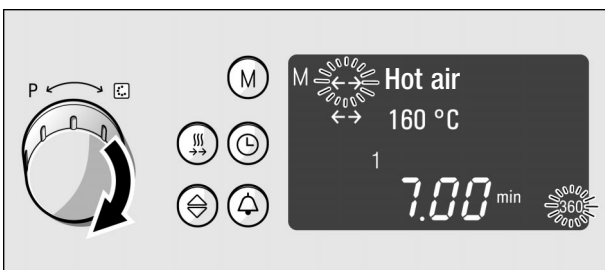

5. Press the  button to move to the second line.



6. Use the function selector to set the required temperature or grill setting.

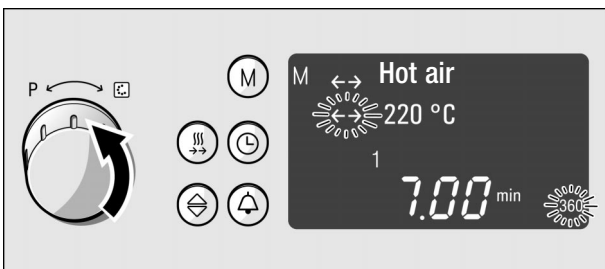

- Press the “M” memory button. “Stored” appears in the display. The clock reappears in the display.



You can store the memory settings and start the oven at the same time. To do this, press the Start button, not the “M” memory button.

You can also store a meal from the automatic program function.

## Replacing memory location

If you want to replace a memory location, select the memory location. The old settings are displayed. Press the Stop button and select new settings.

## Starting the Memory function

The stored settings for your dishes can easily be called up.

Place the dish in the oven.

Example:

Memory location 1, 360 W, 7 minutes, hot air, 220 °C

- Press the “M” memory button. 1 appears for memory location 1.

To change the memory location, press the “M” memory button again.

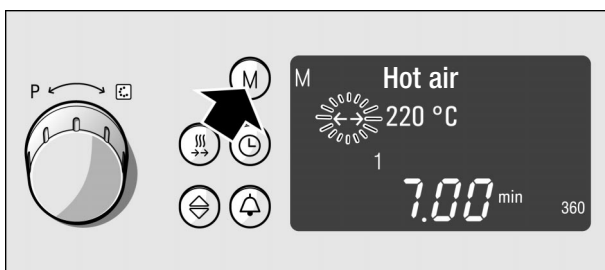

## 2. Press the Start button.

The cooking time counts down in the display.

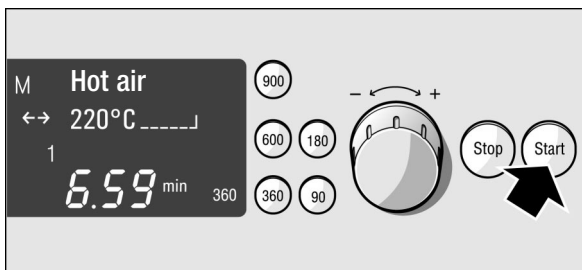

### The cooking time has elapsed

A signal sounds. The oven switches off. The display shows “End time” or “Oven cooling”. Open the oven door or press the Stop button.

### Pausing

Open the oven door. The cooling fan may run on. Press the Start button again once you have closed the door. The program will then continue. If you forget to press the Start button, you will hear a signal after three seconds. “Press Start button” appears in the display.

### Cancelling the setting

Press the Stop button twice or open the oven door and press the Stop button once.

### Switching the oven on and off automatically

Select the memory location using the “M” memory button. Press the ⌚ hour button and extend the end time.

### Note

Once the oven has been started, you can no longer change the memory location.

The temperature, grill setting and cooking time can only be changed once the oven has been started.

---

## Clock

When the oven is first connected or after a power cut, three zeros and the ⌚ clock symbol will flash in the display. “Set time” appears.

## Setting procedure

Example: 13:00

1. Set the time using the rotary knob.

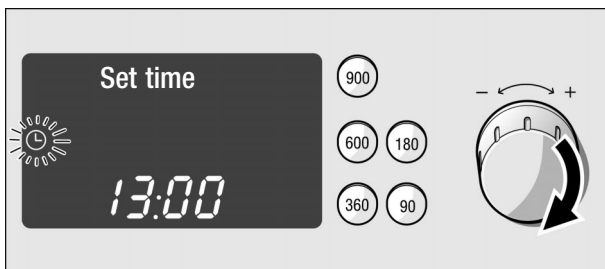

2. Press the ⌚ clock button. The time is adopted.

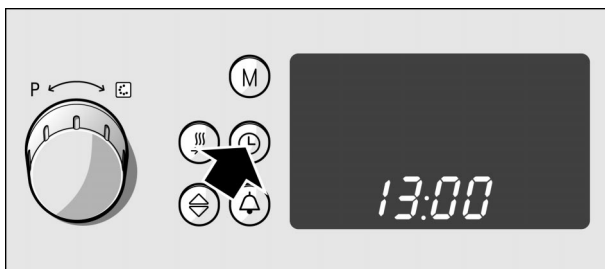

### Changing the time e.g. from summer to winter time

Press the ⌚ clock button. Make settings as described in steps 1 and 2.

### Hiding the clock

The oven is set so that the clock is permanently displayed.

The basic setting can be changed to

“Clock only when in use” - the clock is hidden and only appears when the oven is in use

1. Press the “M” memory button until “Select language” appears in the first line of the display.
2. Turn the function selector until “Clock display” appears in the first line.
3. Move to the second line using the ⏏ button and then use the function selector to select “only when in use”.
4. Press the “M” memory button. The change is stored.

The clock is running in the background.  
Further details can be found in the “Basic settings” section.

**Note**

The clock display does not light up to full brightness between 10.00 p.m. and 6.00 a.m.

---

## Auto start

Your appliance is set up in such a way that you need to press the Start button in order to start the selected oven operation.

“Auto start” starts oven operation automatically when you close the oven door.

In the “Basic settings” section, see the “How to make the settings” section to read how to change to Auto start.

---

## Basic settings

Your oven has several basic settings. Before using the appliance for the first time, ensure that the display is in the correct language. The basic setting is German. You can change all the basic settings individually at any time.

---

Basic setting	Function	Change to
“Select language “German”	Language for the text display	additional languages are possible
“Signal duration too short” = 5 tones	Signal after a certain length of time	“Signal duration medium” = 30 tones “Signal duration long” = 40 tones

Basic setting	Function	Change to
"Signal volume" = medium	Volume of the signal	"Signal volume" = low = high
Clock display "permanently" is always displayed	Time	Clock display "only when in use" The clock is displayed for as long as the oven is in operation
"Auto start off" = start operation using the Start button	Start operation	"Auto start on" = operation starts automatically without using the Start button
"Adjust individually"  - □ □ □ □ ■ □ □ □ +	Changes cooking result in automatic programs	for example, adjust individually Cooking always more intensive  - □ □ □ □ □ ■ □ +

## Setting procedure

You may select different languages.

Example:

Changing language to English

1. Press and hold the "M" memory button for a few seconds.  
The basic setting "Sprache auswählen" appears in the first line of the display and "Deutsch" in the second line.



2. Press the  button to move to the second line.



3. Use the function selector to change the basic setting.



4. Press the “M” memory button. The change is stored.

### Changing other basic settings

Press and hold the “M” memory button for a few seconds. Use the function selector to select the basic setting you want to change. Set as described in steps 2 to 4.

---

## Childproof lock

The oven has a childproof lock to prevent children switching it on accidentally.

### Locking the oven

Hold down the Stop button for a few seconds. “Childproof lock active” is displayed in the display. All functions are blocked.

### Unlocking

Hold down the Stop button for a few seconds again. The lock is released.

### Note

You can still set the time and timer when the oven is locked.

The childproof lock remains active after a power cut.



# Timer

You can use the timer as a kitchen timer. It operates independently of the oven.

The timer has a special signal.

You can also set the timer if the childproof lock is active.

## Setting procedure

Example:  
20 minutes

1. Press the  timer button. "Set timer" appears in the display.

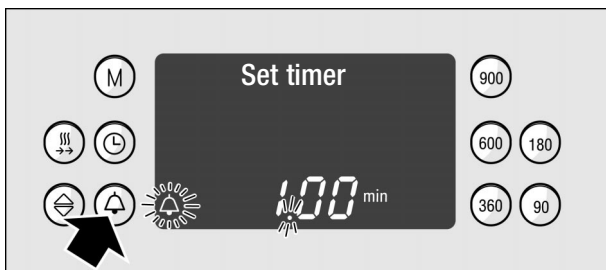



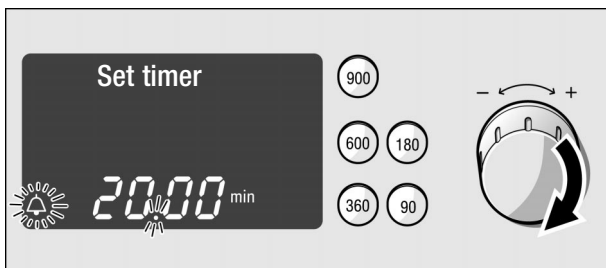

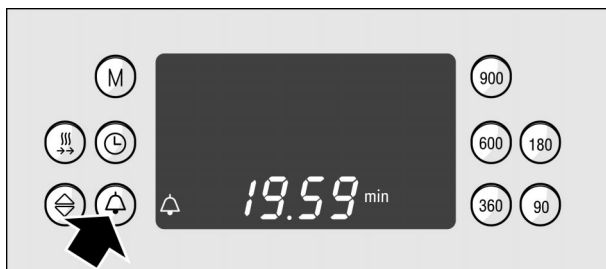

2. Set the alarm time using the rotary knob.



3. Press the  timer button. The time counts down in the display.



<b>The time has elapsed</b>	A signal sounds. Press the  timer button. The clock reappears in the display.
<b>Changing the timer period</b>	Press the  timer button. Use the rotary knob to change the time, then press the  timer button again.
<b>Cancelling the setting</b>	Press the  timer button and then the Stop button. When the oven is in operation at the same time: Press the  timer button and set the time on the timer to zero using the rotary knob. Press the  timer button again. The oven continues to operate.

---

## Safety switch-off

If you forget to switch off the oven, the safety switch-off function will be activated. Oven operation will be interrupted. The temperature or grill setting determines when this will happen.

If the oven is no longer heating up, **5** appears in the display.

Heating is interrupted until you press the Stop button..  
The **5** will disappear.  
Now you can reset the oven.

<b>Cancelling safety switch-off</b>	If you enter a duration, the oven will then switch off at the required time. The safety switch-off is cancelled.
-------------------------------------	---

---

# Care and cleaning

Do not use high-pressure cleaners or steam jets.

---

## Appliance exterior

Wipe the oven with water and a little detergent. Dry it with a soft cloth.

Sharp or abrasive cleaning products are not suitable. If an abrasive substance comes into contact with the frontage, wash it off immediately with water.

Slight differences in the colours on the front of the appliance are caused by the use of different materials, such as glass, plastic and metal.

### Appliances with stainless steel fronts

Always remove any flecks of limescale, grease, cornflour and egg white immediately. Corrosion can form under such flecks.

Clean the oven using water and a little detergent. Dry the surface with a soft cloth.

### Appliances with aluminium fronts

Use a mild window-cleaning detergent. Using a soft window cloth or a non-fluffing microfibre cloth, wipe lightly in a horizontal direction.

Harsh cleaning products, scratchy sponges and rough cleaning cloths are not suitable.

---

## Oven

### Cleaning self-cleaning surfaces in the oven

Never use coarse scouring pads or cleaning sponges. Oven cleaner may only be used on the enamelled surfaces of the oven.

The rear wall and ceiling of the oven are coated with self-cleaning enamel. The surfaces clean themselves while the oven is in operation. Large splashes sometimes only disappear after the oven has been used several times.

Never use oven cleaner on self-cleaning surfaces.

## Cleaning the enamelled surfaces of the oven

Should the enamel become slightly stained, this will not affect its self-cleaning properties.

Use hot soapy water or a vinegar solution.

It is best to use oven cleaner if the oven is very dirty. Only use oven cleaner in a cold oven.

Note:

Enamel is baked on at very high temperatures. This can cause some slight colour variation. This is normal and does not affect the function. Do not use coarse scouring pads or strong cleaning agents to remove such discolorations.

The edges of thin trays cannot be completely enamelled. As a result, these edges can be rough. Anti-corrosion protection is guaranteed.

## Cleaning the glass cover on the oven ceiling

The glass cover on the oven ceiling can be removed. Caution – the oven must be cold.

### Removal

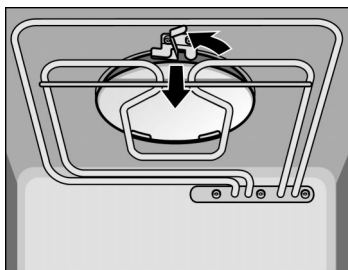

1. Put a tea towel in the oven.
2. Pull the clips on the oven ceiling forward. Push the front glass cover down with the thumbs of your other hand. Release the clips.

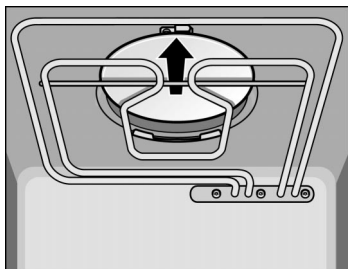

3. Slide the cover forward using both hands and place it on the grill heating element.

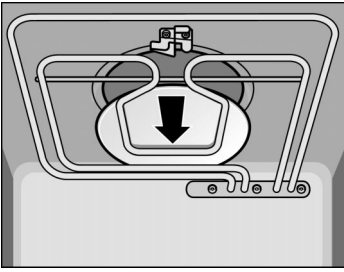

4. Slide it back again slightly.

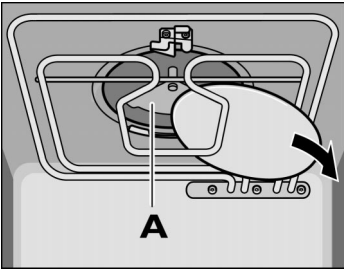

5. Tilt it to the side and downward and remove it.



**Do not touch or clean the microwave aerial (A).**

If the oven is only lightly soiled:  
Rinse the glass cover with hot water.

In the event of heavy soiling:  
Clean the glass cover and the enamelled surfaces of  
the oven.

## Installation

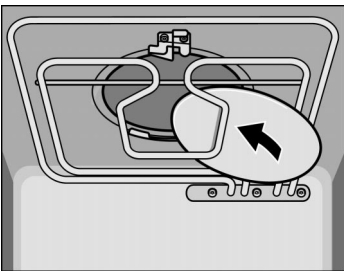

1. Slide the cover in with the smooth side facing down, and place it on the grill heating element.

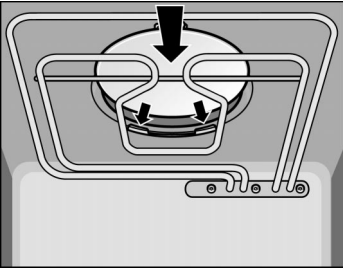

2. Using both hands, slide it backward into the two latches.

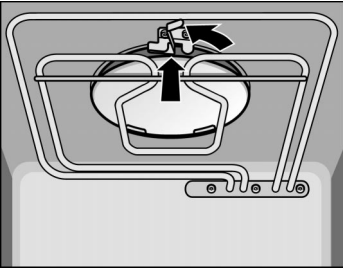

3. Pull the clips forward and push the glass cover upward. Release the clips.

Remove the tea towel from the oven.



**Do not operate the appliance without the microwave glass cover.**

---

## Cleaning the glass panels

The glass panels on the oven door can be removed to assist cleaning.



Important - the oven must be cold. There is a risk of burns.

### Removal

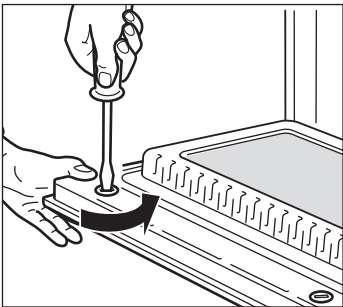

1. Open the oven door.
2. Loosen the two screws on the door using a slotted crewdriver (blade width 8-11 mm). Hold the door panels with one hand when doing so.

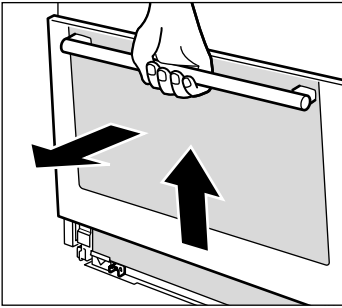

**3.** Position the door at an angle and pull the panel out upwards using the door handle.

**4.** Close the door.

Clean the glass panels with glass cleaner and a soft cloth.

## Installation

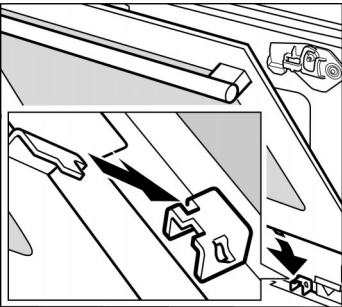

**1.** Insert the panel into the guide, raise it slightly and hook it in at the top.

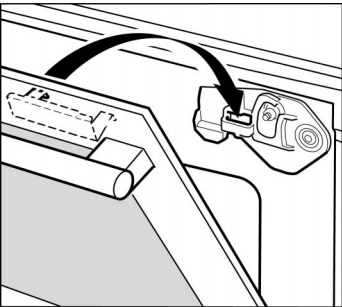

**2.** Raise the panel slightly and attach it at the top.

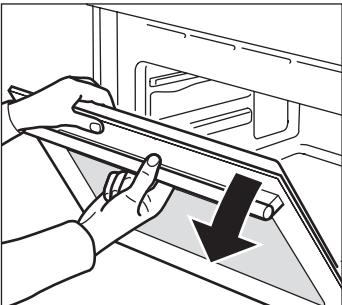

**3.** Open the door fully, while holding the panels with one hand.

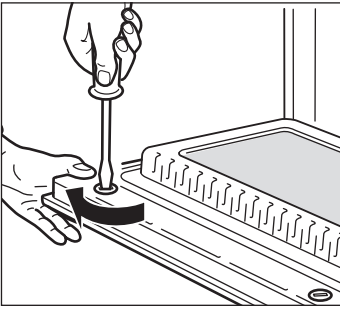

4. Screw in the screws using a slotted crewdriver (blade width 8-11 mm). Close the door.

**The oven must not be used again until the panels have been correctly fitted.**

---

## Seal

Clean the seal on the oven door using detergent. Do not use sharp or abrasive cleaning products.

---

## Accessories

Immediately after use, soak the accessories in washing-up liquid. Food residues can then be easily removed with a brush or sponge.

---

# Troubleshooting

Should a malfunction occur, it is often only due to a minor fault. Please read the following instructions before calling the after-sales service:

Malfunction	Possible cause	Notes/remedial action
The oven does not work.	The plug is not plugged in to the mains.	Plug it in.
	Power cut	Check whether the kitchen light switches on.
	Blown fuse	Look in the fuse box to make sure that the fuse for the appliance is okay.



<b>Malfunction</b>	<b>Possible cause</b>	<b>Notes/remedial action</b>
	Faulty control	Switch the appliance off using the fuse in the fuse box. Wait approximately 10 seconds and then switch it back on.
Three zeros flash in the clock display.	Power cut	Reset the time.
The oven is not in operation. A cooking time appears in the display.	The rotary knob was accidentally pressed.	Press the Stop button.
	The Start button was not pressed after the setting had been made.	Press the Start button or clear the setting by pressing the Stop button.
The microwave does not switch on.	The door is not properly closed.	Check whether leftover food or a foreign object is trapped in the door.
	The Start button was not pressed.	Press the Start button.
The food takes longer than usual to heat up.	The microwave setting is too low.	Select a higher microwave setting.
	You have placed a larger amount of food than normal in the oven.	Double the amount = almost double the cooking time.
	The food was colder than usual.	Stir or turn the food during cooking.
A "5" is shown in the clock display.	The safety switch-off was activated. The oven was operated for a long period without the setting being changed.	Press the Stop button.
The clock display contains the error message "E1" or "E2".	The temperature sensor has failed.	Call after-sales service. It is possible to use the microwave function alone.

Malfunction	Possible cause	Notes/remedial action
The clock display contains the error message "E9", "E10", or "E11".	The microwave has a malfunction.	Press the Stop button. The fault message goes out. Start microwave operation again. If the fault message appears again, please call the after-sales service. It is possible to operate the oven without the microwave.
The clock display contains the error message "E16" or "E17".	Technical fault.	Contact the after-sales service.
Microwave operation is cancelled for no obvious reason.	The microwave has a fault.	If this fault occurs repeatedly, please call the after-sales service. It is possible to operate the oven without the microwave.

**Repairs may only be carried out by fully trained after-sales service engineers.** Incorrect repairs may result in serious injury to the user.

## Replacing the oven lightbulb

The oven lightbulb can be replaced. Heat-resistant 12 V 20 W halogen bulbs are available from the after-sales service or in specialized stores.

When removing a new halogen bulb from the packaging, always use a dry cloth. This will increase the life of the bulb.

### Method

1. Switch off the fuse in the fuse box or unplug the oven at the mains.
2. Place a tea towel in the cold oven to prevent damage.
3. Remove the glass cover. To do this, open the glass cover at the bottom with your hand. If it proves difficult to remove the glass cover, try using a spoon. (Fig. A)

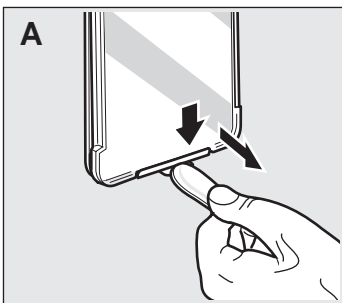

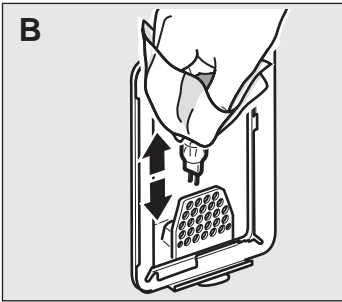

4. Remove the lamp and replace with a lamp of the same type. (Fig. B)

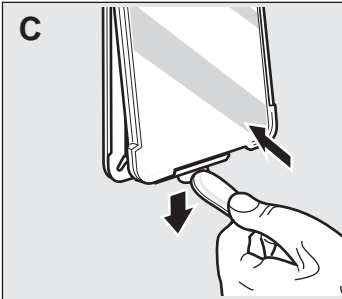

5. Fit the glass cover back on. (Fig. C)

6. Remove the tea towel. Switch on the fuse in the fuse box again or plug in the mains power.

## Changing the door seal

If the door seal is defective, it must be changed. Replacement seals for you appliance are available from our after-sales service. Please specify the E number and FD number of your appliance.

1. Open the oven door.
2. Pull off the old door seal.
3. There are 5 hooks attached to the door seal. Use these hooks to fit the new seal to the oven door.

Note: The joint at the bottom centre of the door seal is perfectly normal.

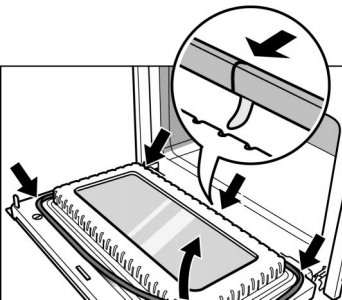

---

# After-Sales Service

If your appliance needs repairing, you can contact our after-sales service. You will find the address and telephone number of your nearest after-sales service centre in the phone book. The after-sales service centres listed will also be happy to advise you of a service point in your local area.

## E number and production number

Please quote the E number (product number) and the FD number (production number) of your appliance when contacting the after-sales service. The nameplate with these numbers is located inside the oven. You can make a note of these numbers in the space below to save time in the event of your appliance malfunctioning.

E no.	FD no.
-------	--------

After-sales service ☎
-----------------------

This appliance complies with the standards EN 55011 and CISPR 11.

The product is classified in group 2, class B.

Group 2 means that microwaves are used for the purpose of heating foodstuffs.

Class B means that the appliance is suitable for use in a private household environment.

---

# Tables and tips

This table contains a selection of dishes and the optimum settings at which to cook them. You can use the table to look up which microwave setting, type of heating, and temperature are most suitable for your dish, which accessories to use, and at what height to set the wire rack. You will find a variety of tips about ovenware and preparation, and a small troubleshooting section in case anything should go wrong.

---

## Defrosting, heating up and cooking with the microwave

The following tables provide you with numerous options and adjustment values for the microwave.

The times specified in the tables are only guidelines. They may vary according to the ovenware used, the quality, temperature and consistency of the food.

Time ranges are often specified in the tables. Set the shortest time first and then extend the time if necessary.

It may be that you have different quantities from those specified in the tables.

A rule of thumb can be applied:

Double amount - just under double cooking time,  
half amount - half the cooking time.

Position the wire rack at level 1. Place the ovenware in the centre of the wire rack. The food will then absorb the microwaves from all sides.

### Defrosting

Place the frozen food in an open container on the wire rack.

Delicate parts such as the legs and wings of chicken or fatty outer layers of roasts can be covered with small pieces of aluminium foil. The foil must not touch the oven walls. You can remove the foil half way through the defrosting time.

Turn or stir the food once or twice during the defrosting time. Large pieces of food should be turned several times. Turn to remove any liquid that results from defrosting.

Leave defrosted items to stand at room temperature for a further 10 minutes to 1 hour so that the temperature can even out. The giblets can be removed from poultry at this point.

	<b>Amount</b>	<b>Microwave setting (watts), Cooking time in minutes</b>	<b>Notes</b>
Whole joints of meat e.g. beef, pork, veal (with or without bones)	800 g	180 W, 15 mins. + 90 W, 10 - 15 mins.	Turn several times.
	1.000 g	180 W, 15 mins. + 90 W, 20 - 30 mins.	
	1.500 g	180 W, 25 mins. + 90 W, 25 - 30 mins.	
Diced or sliced beef, pork and veal	200 g	180 W, 5 mins. + 90 W, 4 - 6 mins.	Separate the pieces of meat when turning.
	500 g	180 W, 8 mins. + 90 W, 5 - 10 mins.	
	800 g	180 W, 10 mins. + 90 W, 10 - 15 mins.	
Mixed minssced meat	200 g	90 W, 10 - 15 mins.	Freeze flat if possible. Turn several times during defrosting and remove meat which has already been defrosted.
	500 g	180 W, 5 mins. + 90 W, 10 - 15 mins.	
	800 g	180 W, 10 mins. + 90 W, 15 - 20 mins.	
	1000 g	180 W, 13 mins. + 90 W, 20 - 25 mins.	
Poultry or poultry portions	600 g	180 W, 5 mins. + 90 W, 13 - 18 mins.	Turn half way through.
	1.200 g	180 W, 10 mins. + 90 W, 20 - 25 mins.	
Duck	2.000 g	180 W, 20 mins. + 90 W, 30 - 40 mins.	Turn several times.
Goose	4.500 g	180 W, 30 mins. + 90 W, 60 - 80 mins.	Turn every 20 minssutes. Drain off any liquid produced by defrosting.
Fillet of fish, fish steak, slices	400 g	180 W, 5 mins. + 90 W, 10 - 15 mins.	Separate defrosted items.
Whole fish	300 g	180 W, 3 mins. + 90 W, 10 - 15 mins.	Turn half way through.
	600 g	180 W, 8 mins. + 90 W, 10 - 15 mins.	
Vegetables, e.g. peas	300 g	180 W, 8 - 13 mins.	Stir carefully half way through.
	600 g	180 W, 10 mins. + 90 W, 8 - 13 mins.	
Fruit e.g. raspberries	300 g	180 W, 7 - 10 mins.	Stir carefully during defrosting and separate the defrosted parts.
	500 g	180 W, 8 mins. + 90 W, 5 - 10 mins.	
Butter, softening	125 g	90 W, 7 - 9 mins.	Remove the packaging completely.
	250 g	180 W, 2 mins. + 90 W, 3 - 5 mins.	
Whole loaf	500 g	180 W, 3 mins. + 90 W, 10 - 15 mins.	Turn half way through.
	1.000 g	180 W, 3 mins. + 90 W, 15 - 25 mins.	

	<b>Amount</b>	<b>Microwave setting (watts), Cooking time in minutes</b>	<b>Notes</b>
Cakes, dry e.g. sponge cakes	500 g 750 g	90 W, 10 - 15 mins. 180 W, 2 mins. + 90 W, 10 - 15 mins.	Separate pieces of cake. Only for cakes without icing, cream or crème pâtissière.
Cakes, moist e.g. fruit cake and cheese cake	500 g 750 g	180 W, 5 mins. + 90 W, 15 - 20 mins. 180 W, 10 mins. + 90 W, 15 - 20 mins.	Only for cakes without icing, cream or gelatine.

### **Defrosting, heating up or cooking frozen foods**

Take ready-made meals out of their packaging. They will heat up more quickly and evenly if you place them in microwavable dishes. Different parts of the meal may heat up at different rates.

Food which is laid flat heats up quicker than if it is piled high. Therefore it is best to spread out the food so that it lies flat in the container. You should not place layers of food on top of each other.

Always cover the food. If you do not have a suitable lid for your dish, use a plate or special microwave foil.

You should stir or turn the food two to three times during heating.

Once you have heated up the meals, leave them to stand for another 2 to 5 minutes so that the temperature can stabilize.

The individual taste of the food is retained to a large degree. You can therefore go easy on salt and spices.

	<b>Amount</b>	<b>Microwave setting (watts), Cooking time in minutes</b>	<b>Notes</b>
Menu, one-course meal, ready-made meal in two to three parts	300-400 g	600 watts, 11 - 15 mins.	covered
Soups	400-500 g	600 watts, 8 - 13 mins.	covered
Stews	500 g	600 watts, 10 - 15 mins.	covered
	1.000 g	600 watts, 20 - 25 mins.	
Slices or pieces of meat in sauce, e.g. goulash	500 g	600 watts, 12 - 17 mins.	covered
	1.000 g	600 watts, 25 - 30 mins.	
Fish, e.g. fillets	400 g	600 watts, 10 - 15 mins.	covered
	800 g	600 watts, 18 - 23 mins.	

	Amount	Microwave setting (watts), Cooking time in minutes	Notes
Side dishes, e.g. rice, noodles	250 g	600 watts, 2 - 5 mins.	covered, add water
	500 g	600 watts, 7 - 10 mins.	
Vegetables e.g. peas, broccoli and carrots	300 g	600 watts, 8 - 12 mins.	covered, add 1 tbsp water
	600 g	600 watts, 13 - 18 mins.	
Creamed spinach	450 g	600 watts, 11 - 16 mins.	simmer without adding water

## Heating food

Take ready-made meals out of their packaging. They will heat up more quickly and evenly if you place them in microwavable dishes. Different parts of the meal may heat up at different rates.



When heating liquids, always place a teaspoon in the container to stop the liquid from boiling over. When boiling is delayed, the liquid comes to the boil without the customary steam bubbles. Even if the container only vibrates a little, the liquid can boil over a lot or spatter. This can cause injuries and scalding.

Always cover the food. If you do not have a suitable lid for your dish, use a plate or special microwave foil.

You should stir or turn the food several times during heating. Monitor the temperature.

Once you have heated up the meals, leave them to stand for another 2 to 5 minutes so that the temperature can stabilize.

	Amount	Microwave power setting, cooking time in minutes	Notes
Full meal, one-course meal, ready-to-eat meal (2-3 components)	350-500 g	600 watts, 4-8 mins	Covered
Drinks	150 ml	900 watts, 1-3 mins	Place a spoon in the container. Do not overheat alcoholic drinks. Check during heating.
	300 ml	900 watts, 3-4 mins	
	500 ml	900 watts, 4-5 mins	
Baby food, e.g. milk bottles*	50 ml	360 watts, ½-1 mins	Without the lid or teat. Always shake well or stir after heating. You must check the temperature
	100 ml	360 watts, 1-1½ mins	
	200 ml	360 watts, 1-2 mins	



		Amount	Microwave power setting, cooking time in minutes	Notes
Soup,	1 cup	175 g	900 watts, 1½-2 mins	
	2 cups	175 g each	900 watts, 2-4 mins	
	4 cups	175 g each	900 watts, 4-6 mins	
Slices or pieces of meat in sauce		500 g	600 watts, 7-10 mins	Covered
Stew		400 g	600 watts, 5-7 mins	Ovenware with lid
		800 g	600 watts, 7-10 mins	
Vegetables,	1 portion	150 g	600 watts, 2-3 mins	Add a little liquid.
	2 portions	300 g	600 watts, 3-5 mins	

\* Place milk bottles on the oven floor.

## Cooking food

Always cook food in covered dishes. You should stir or turn the food during cooking.

The individual taste of the food is retained to a large degree. You can therefore go easy on salt and spices.

Food which is laid flat heats up quicker than if it is piled high. Therefore it is best to spread out the food so that it lies flat in the container. If possible, you should not place layers of food on top of each other.

Once you have cooked the meals, leave them to stand for another 2 to 5 minutes so that the temperature can stabilize.

		Amount	Microwave power setting, cooking time in minutes	Notes
Fresh whole chicken, without giblets		1500 g	600 watts, 25-30 mins	Turn half way through the cooking time.
Fish fillet, fresh		400 g	600 watts, 8-13 mins	
Vegetables, fresh		250 g	600 watts, 6-10 mins	Cut vegetables into pieces of equal size. Add 1 to 2 tablespoons of water per 100 g of vegetables.
		500 g	600 watts, 10-15 mins	
Side dishes, e.g. potatoes		250 g	600 watts, 8-11 mins	Cut potatoes into pieces of equal size. Add 1 to 2 tablespoons of water per 100 g and stir.
		500 g	600 watts, 12-15 mins	
		750 g	600 watts, 15-22 mins	
e.g. rice		125 g	600 watts, 4-6 mins + 180 watts, 12-15 mins	Add twice the amount of liquid and use a high-sided dish.
		250 g	600 watts, 7-9 mins + 180 watts, 15-20 mins	

	Amount	Microwave power setting, cooking time in minutes	Notes
Desserts, e.g. milk pudding (instant)	500 ml	600 watts, 5-8 mins	Stir the pudding thoroughly 2 to 3 times during cooking using an egg whisk.
Fruit, stewed fruit	500 g	600 watts, 9-12 mins	

## Tips for microwave operation

**No settings are given for specified amounts of food.**

Increase or decrease the cooking times according to the following rule of thumb:

Double the amount = almost double the time

Half the amount = half the time

**The food becomes too dry.**

Set a shorter cooking time next time or select a lower microwave setting. Cover the food and add more liquid.

**After the time has elapsed, the food is not defrosted, is not hot or is not cooked.**

Set a longer time. Larger amounts and deeper dishes take longer to cook.

**At the end of the cooking time, the food is overcooked on the outside but undercooked in the middle.**

Stir the food during the cooking time and next time select a lower setting and a longer duration.

**After defrosting, the poultry or meat is cooked on the outside but still frozen in the middle.**

Next time select a lower microwave setting. In addition, turn large amounts of meat or poultry frequently when defrosting.

## Meat, poultry, fish

**About the tables**

The temperature and roasting time depend on the type and amount of food being cooked. This is why temperature ranges are given in the tables. Begin with the lower temperature and, if necessary, use a higher setting the next time.

For more information, see the “Tips for grilling and roasting” section which follows the tables.

## Ovenware

You may use any heat-resistant ovenware which are suitable for use in a microwave. Metal roasting dishes can only be used for roasting without the microwave feature.

Hot glass dishes should be placed on a dry kitchen towel after removal from the oven. The glass could crack if placed on a cold or wet surface.

The ovenware can become very hot. Use oven gloves to take the ovenware out of the oven.





## Notes on roasting



Use a deep tin for roasting.











Check that your ovenware fits in the cooker. It should not be too large.

Add 2 to 3 soup spoons of liquid to lean meat, and 8 to 10 soup spoons of liquid to pot roasts, depending on the size.

Turn the meat after half the cooking time has elapsed. When the roast is ready, switch off the oven and leave the roast to stand for 10 minutes with the oven door closed. This allows the meat juices to distribute more evenly.

Hot air	
Top/bottom heating	
Hot air grilling	
Grill, large area	

	Microwave setting in watts, cooking time in minutes	Level	Type of heating	Temperature in °C, grill setting	Notes
Pot-roasted beef approx. 1,000 g	–, 120 mins	1		150-170	Dish with lid on wire rack. Turn twice.
Sirloin, medium rare approx. 1,000 g	180 W, 30-40 mins	1		240-260	Uncovered dish. Turn half way through the cooking time. When finished, leave to stand for 10 minutes.
Pork without crackling, approx. 750 g, e.g. neck	180 W, 40-50 mins	1		220-240	Dish with lid on wire rack. Turn half way through the cooking time.

	Microwave setting in watts, cooking time in minutes	Level	Type of heating	Temperature in °C, grill setting	Notes
Pork with crackling* approx. 1,500 g e.g. shoulder	600 W, 10 mins + -, 115-125 mins	1		180-200	Uncovered dish. When finished, leave to stand for 10 minutes. Do not turn.
Loin of pork, approx. 1,000 g	90 W, 55-65 mins	1		210-230	Dish with lid. When finished, leave to stand for 10 minutes.
Meatloaf approx. 1000 g	600 W, 10 mins + 180 W, approx. 50 mins	1		190-210	Dish without lid on wire rack. When finished, leave to stand for 10 minutes.
Whole chicken approx. 1,000-1,200 g	360 W, 25-35 mins	1		230-250	Dish with lid on wire rack. Cook with the breast side down. Turn the chicken 2/3 of the way through the cooking time.
Chicken portions, e.g. chicken quarters approx. 800 g	360 W, 35-40 mins	1		170-190	Uncovered dish on wire rack. Cook with the skin side down. Do not turn.
Duck 1,500-1,700 g	180 W, 60-80 mins	1		170-190	Universal pan. Turn twice.
2 duck breasts each 300-400 g	90 W, 18-22 mins	2**		High	Cook with the skin side down. Turn after 10 minutes.
2 goose breasts each approx. 500 g	90 W, 20-25 mins	2**		210-230	Cook with the skin side down. Turn after approx. 10 minutes.
4 goose breasts approx. 1,500 g	180 W, 35-45 mins	2**		170-190	Turn after approx. 20 minutes. After turning, pierce the skin.
Goose 3,000-3,500 g	180 W, 80-90 mins	1		170-190	Universal pan. Turn twice.

\* Make cuts in the pork rind.

\*\* Wire rack at level 2, universal pan at level 1. Add 50 ml water to the universal pan.

## Notes on grilling

Always grill with the oven door closed and do not preheat.

If possible, grill pieces of meat which are of the same thickness. Steaks should be at least 2 to 3 cm thick. Such pieces will be browned evenly and stay juicy and soft in the middle. Only salt the steaks after they have been grilled.







Turn the meat with tongs. If you pierce the meat with a fork, it will lose its juices and dry out.

Red meat such as beef browns quicker than white meat such as veal or pork. Do not worry about this. Grilled white meat or fish is often only lightly browned on the surface. Nevertheless it is done on the inside and is juicy.

Note: The grill element automatically switches itself off and back on again. This is normal. The number of times this happens depends on the grill setting you have selected.

Grill, large area 

Grill, small area 

	Amount	Weight	Level	Type of heating	Grill	Cooking time in minutes
Steaks 2-3 cm thick	2-3 servings	approx. 200 g each	1+3**		high high	1st side: approx. 10 - 15 mins. 2nd side: approx. 5 - 10 mins.
Neck fillets 2-3 cm thick	2-3 servings	approx. 120 g each	1+3**		moderate moderate	1st side: approx. 15 - 20 mins. 2nd side: approx. 10 - 15 mins.
Sausages	4-6 servings	approx. 150 g each	1+3**		high high	1st side: approx. 10 - 15 mins. 2nd side: approx. 5 - 10 mins.
Fish steak*	2-3 servings	approx. 150 g each	1+3**		high high	1st side: approx. 10 - 12 mins. 2nd side: approx. 8 - 12 mins.
Whole fish* e.g. trout	2-3 servings	approx. 300 g each	1+3**		moderate moderate	1st side: approx. 10 - 15 mins. 2nd side: approx. 10 - 15 mins.
Toast	12 slices		3		high high	1st side: approx. 4 - 6 mins. 2nd side: approx. 2 - 3 mins.
Toast	4 slices***		3		high high	1st side: approx. 5 - 6 mins. 2nd side: approx. 3 - 4 mins.

\* Grease the wire rack with oil before grilling.

\*\* Insert the wire rack at level 3 and the universal pan at level 1.

\*\*\* Place the slices of bread next to each other in the middle of the wire rack.

---

## Advice on roasting and grilling

---

**The table does not contain specifications for the weight of the roast**

Select the next lowest weight from the instructions and extend the time.

---

**How can you tell when the roast is ready.**

Use a meat thermometer (available from specialist stores) or implement a “spoon test”. Press a spoon onto the roast. If it feels firm, it is ready. If it can be pressed in, it needs to be cooked for a little longer.

---

**The roast looks good, but the sauce is burnt.**

Next time, use a smaller roasting dish and add more liquid.

---

**The roast looks good, but the sauce is too light and watery.**

Next time, use a larger roasting dish and add less liquid.

---

**The microwave setting was switched on. The roast is not cooked through.**

Carve the roast, prepare the sauce in the roasting pan, place the meat slices into the sauce and finish off the cooking using the microwave setting only.

Next time, use the microwave function from the start of the cooking process. Use a meat thermometer and leave the finished roast to stand in the oven for a further 10 minutes.

---

---

## Cakes and pastries

### About the tables

The times given apply to dishes placed in a cold oven.

The temperature and baking time depend on the consistency and amount of the mixture. This is why temperature ranges are given in the tables. Begin with the lower temperature and, if necessary, use a higher setting the next time, since a lower temperature allows more even browning.

More information can be found in the “Baking tips” section which follows the tables.

Always place the cake tin in the centre of the wire rack.





## Baking tins

It is best to use dark-coloured metal baking tins.

When using the microwave, use baking containers made of glass, ceramic, or plastic. These must be heat-resistant up to 250 °C. Cakes will not brown so well if you use these types of baking containers.

Hot air 

Top/bottom heating 

Cake	Ovenware	Level	Microwave setting in watts	Cooking time in minutes	Type of heating	Temperature in °C
Nut cake	Springform cake tin	1	90 watts	35-45		170-180
Fruit or cheese cake with short pastry*	Springform cake tin	1	360 watts	30-40		170-180
Fruit cake, fine sponge mixture	Ring mould or Springform cake tin	1	90 watts	30-40		160-180
Sponge cake, simple	Ring-shaped cake/ Vienna ring tin	1	90 watts	30-40		160-180







\* Allow cakes to cool in the oven for approximately 20 minutes.









Top/bottom heating 

Intensive heat 

Hot air 

3D hot air 

Cake	Ovenware	Level	Type of heating	Temperature in °C	Cooking time in minutes
Sponge cake, delicate (e.g. pound cake)*	Ring-shaped/ Vienna ring cake tin	1		150-170	60-80
Cake base made from shortcrust pastry	Springform cake tin	1		170-190	30-40
Cake base made from sponge mixture	Fruit base cake tin	2		160-180	25-35
Sponge flan (hot water sponge cake)	Springform cake tin	1		170-180	30-40
Cake with dry topping (sponge)	Universal pan	2		170-180	25-35
Cake with dry topping (sponge)	Universal pan Enamel baking tray***	1 3		150-170	40-50



Cake	Ovenware	Level	Type of heating	Temperature in °C	Cookingtime in minutes
Cake with moist topping e.g. yeast dough with apple crumble	Universal pan	2		170-190	45-55
Cake with moist topping e.g. yeast dough with apple crumble	Universal pan	1		160-180	50-60
	Enamel baking tray***	3			
Plaited loaf made with 500 g flour	Universal pan	2		160-180	40-50
Stollen made with 500 g flour	Universal pan	2		150-170	60-70
Flan	Universal pan	1		190-200	40-50
Pizza	Universal pan	1		210-230	30-40
Pizza	Universal pan	1		210-230	40-50
	Enamel baking tray***	3			
Yeast bread 1 kg** (preheat****)	Universal pan	2		300	10
				+ 180	15-25
Savoury cakes (e. g. quiche/onion tart)	Springform cake tin or quiche dish	1		55-65	180-200







\* Allow cakes to cool for approximately 20 minutes in the oven.

\*\* Never pour water directly into the hot oven.

\*\*\* Enamel baking trays are available as optional accessories in specialist shops.

\*\*\*\* Preheat using rapid heating.

Top/bottom heating   
3D hot air 

Small baked products		Level	Type of heating	Temperature in °C	Cookingtime in minutes
Biscuits	Universal pan	2		150-170	20-30
Biscuits	Universal pan	1		140-160	30-40
	Enamel baking tray*	3			
Meringue	Universal pan	2		80-100	90-110
Macaroons	Universal pan	2		120-140	35-45
Macaroons	Universal pan	1		110-130	40-50
	Enamel baking tray*	3			
Puff pastry	Universal pan	2		180-200	30-40



Small baked products		Level	Type of heating	Temperature in °C	Cooking time in minutes
Puff pastry	Universal pan	1	☉	210-230	30-40
	Enamel baking tray*	3			
Bread rolls (e.g. rye rolls)	Universal pan	2	☐	200-220	20-30
Cream puffs	Universal pan	2	☐	210-230	35-45
Viennese whirls	Universal pan	2	☐	150-170	25-35
Viennese whirls	Universal pan	1	☉	140-160	40-50
	Enamel baking tray*	3			

\* Additional baking trays are available as optional accessories in specialized shops.

## Baking tips

**You wish to cook to your own recipe.**

Refer to the instructions in the tables for similar types of food.

**How to check that a sponge cake is cooked properly.**

Approximately 10 minutes before the end of the baking time specified in the cooking instructions, pierce the deepest part of the cake using a cocktail stick. The cake is done if the cocktail stick comes out clean.

**The cake collapses.**

Next time you should add less liquid or set the oven temperature around 10 degrees lower. Observe the cooking times in the recipe.

**The cake has risen in the centre but is lower at the edges.**

Only grease the base of the springform cake tin. As soon as the cake is ready, carefully loosen the cake around the edges using a knife.

**The cake is too dark.**

Select a lower temperature and cook the cake for a little longer.

**The cake is too dry.**

Use a toothpick to make small holes in the baked cake. Then drizzle fruit juice or alcohol over the top. Next time you should decrease the temperature by around 10 degrees and reduce the baking times.

**The bread or cake (e.g. cheesecake) looks fine, but is soggy on the inside (soft, with watery areas).**

Next time you should add a little less liquid and cook for a little longer at a lower temperature. For cakes with a moist topping, you should first bake the base, sprinkle it with almonds or breadcrumbs and then add the topping. Please observe the recipe and the baking times.

---

**The cake does not turn out when turned upside down.**

Allow the cake to cool for 5 to 10 minutes after baking, it will then turn out of the tin more easily. If it still does not turn out, carefully loosen the edges using a knife. Turn the cake upside down again and wrap a cold, wet cloth around the tin. Next time you should grease the tin well and add some breadcrumbs also.

---

**You have checked the oven temperature with your own thermometer and have discovered a discrepancy.**

The oven temperature was checked by the manufacturer. The temperature was taken from the centre of the oven after a specified time during a test roasting. Each piece of ovenware and each accessory will affect the measured value, meaning that there will always be a discrepancy.

---

**Sparks appear between the dish and the wire rack.**

Check whether the outside of the dish is clean. Alter the position of the dish in the oven. If this does not help, continue to bake without using the microwave function. The baking time is consequently extended.

---

---

## Energy saving tips

Only preheat the oven if it specifies in the recipe or in the table in the instruction manual that you should do so.

Use non-stick, black painted or enamelled tins. They absorb the heat especially well.

If you have several cakes to bake it is best to bake them one after the other. The oven is still warm. This shortens the baking time for the second cake.

For long cooking times, it is possible to switch off the oven 10 minutes before the end of the cooking time and thus use the residual heat to finish off the cooking.

---



## Bakes, gratins, toast





The table applies to dishes placed in a cold oven.

Place the bake in microwaveable ovenware on the wire rack.

Use large flat ovenware for bakes and gratins. Food takes longer to cook in narrow, deep containers and browns more on top.

Bakes and gratins should be left to cook in the oven for a further 5 minutes after the oven has been switched off.

Hot air grilling   
Grill large area 



Dish	Amount	Ovenware	Level	Microwave wattage	Cooking time in minutes	Type of heating	Temp. in °C Setting
Sweet bakes (e.g. quark and fruit bake)	Approx. 1500 g	Shallow ovenproof dish 4-5 cm	1	360 W	25-35		140-160
Savoury bakes made from cooked ingredients (e.g. pasta bake)	Approx. 1000 g	Shallow ovenproof dish 4-5 cm	1	600 W	20-25		150-170
Savoury bakes made from raw ingredients* (e.g. potato gratin)	Approx. 1100 g	Shallow casserole dish	1	600 W	20-25		180-200
Toast with topping*	2-4 slices	Universal pan	2	Depending on topping: 180 W	8-10		High





\* Toast slices of bread in advance



## Deep-Frozen Ready Meals

Please observe the instructions on the packaging.

The values in the table apply to dishes placed in a cold oven.

Top/bottom heating   
Hot air   
3D hot air 

Dish	Level	Type of heating	Temperature in °C	Cooking time in minutes
Fruit strudel	2		200-220	30-40
Chips	2		220-230	20-25
Pizza	1		180-200	20-25
Pizza baguette	1		180-190	15-20

Dish		Level	Type of heating	Temperature in °C	Cooking time in minutes
Croquettes	Universal pan	2		200-220	25-35
Fried potatoes	Universal pan	2		200-220	25-35
2 pizzas	Wire rack	1		190-210	20-30
	Universal pan	3			

## Braising

Braising is the ideal cooking method for all tender pieces of meat which are to be cooked medium rare or medium. Meat remains very succulent and tender. Advantages: The benefit of this cooking method is that it allows lots of scope for menu planning because slow-cooked meat is easy to keep warm.

### Suitable ovenware

Use flat ovenware such as a porcelain serving plate.

### Method

1. Select “Braising” using the function selector and set the temperature to 90 °C. Preheat the oven and a dish on the wire rack at level 2.
2. Rapidly heat a little fat in a pan. Sear the meat and immediately transfer to the preheated dish.
3. Return the dish and the meat to the oven, and leave to braise. A braising temperature of 90 °C is ideal for most meats.

### Tips for braising meat

Only use fresh, clean meat.

Sear the meat at a very hot temperature and for a sufficiently long time.

Do not cover the meat when braising in the oven.

Even larger pieces of meat do not need to be turned.

Meat can be carved immediately following braising. No standing time is required.

Due to the special braising method, the meat always looks pink in the middle. This does not mean, however, that it is raw or not well done enough.

## Table

All tender joints of beef, pork, veal and lamb are suitable for braising. Searing and braising times depend on the size of the piece of meat.

Searing time refers to the time the meat spends in hot fat.

Dish	Searing on the hotplate (time in minutes)	Cooking in the oven (time in minutes)
<b>Small pieces of meat</b>		
Cubes or strips	1-2 all over	20-30
Small cutlets, steaks or médaillons	1-2 per side	35-50
<b>Medium-sized pieces of meat</b>		
Fillet (400-800 g)	4-5 all over	75-120
Saddle of lamb (approximately 450 g)	2-3 per side	50-60
<b>Large pieces of meat</b>		
Fillet ( over 900 g)	6-8 all over	120-150
Sirloin (1.1-2 kg)	8-10 all over	210-300

## Tips for braising

**Braised meat is not as hot as conventionally roasted meat.**

Warm the plates and serve sauces very hot.

**To keep braised meat warm,**

after braising, turn the temperature down to 70 °C. Small pieces of meat can be kept warm for up to 45 minutes, larger pieces for up to 2 hours.

---

# Acrylamide in food

Experts are currently discussing how dangerous acrylamide in food can be. We have compiled this information sheet for you on the basis of current research.

## Where does acrylamide come from?

Acrylamide in food does not come from external contamination. It is formed in the food itself during preparation - provided that the food contains carbohydrate and protein. Exactly how this happens has not yet been completely explained. However, it appears that the acrylamide content is strongly influenced by:

high temperatures  
a low water content in food  
intensive browning of the food.

## What sort of foods are affected?

Acrylamide forms mostly in grain and potato products that are prepared at high temperatures, e.g.:

crisps, chips,  
toast, rolls, bread,  
baked goods made from shortcrust pastry (speciality biscuits and cakes).

---

## What can you do?

1 You can avoid high levels of acrylamide when baking, frying and grilling.

The following recommendations were published by AID<sup>1</sup> and BMVEL<sup>2</sup> to help you minimise acrylamide levels:

### In general

Keep cooking times as short as possible.

“Brown rather than burn” - cook food only until it is golden brown.

The larger and thicker the food is, the less acrylamide it contains.

## Baking

Set the temperature to a maximum of 200 °C when using the top/bottom heating setting, and to a maximum of 180 °C for the 3D hot air setting.

Cookies: Set the temperature to a maximum of 190 °C when using the top/bottom heating setting, and to a maximum of 170 °C for the 3D hot air setting. The presence of egg or egg yolk in a recipe reduces the formation of acrylamide.

Spread oven chips evenly over the baking sheet in one layer where possible. To prevent the food from drying out quickly, place at least 400 g on each baking sheet.

<sup>1</sup> AID "Acrylamide" information leaflet, published by AID (German Evaluation and Information Service for Nutrition, Agriculture and Forestry) and BMVEL (German Federal Ministry for Consumer Protection, Food and Agriculture), as at 12/02, Internet: <http://www.aid.de>.

<sup>2</sup> BMVEL press release 365, as at 4.12.2002, Internet:<http://www.verbraucherministerium.de>

# Test dishes

The quality and function of microwave combination appliances is tested by testing institutes using the following dishes.

In accordance with standards EN 60705, IEC 60705 DIN 44547 and EN 60350



## Microwave defrosting

Meal	Microwave setting (watts), Cooking time in minutes	Notes
Meat	180 W, 7 + 90 W, 7-10	Place the 22 cm diameter Pyrex dish on the wire rack, level 1. Remove the defrosted meat after approximately 13 minutes.

## Microwave cooking



Dish	Microwave setting (watts), Cooking time in minutes	Notes
Custard	360 W, 20 + 180 W, 20-25	Place the Pyrex dish on the wire rack, level 1.
Sponge	600 W, 8-10	Place the 22 cm diameter Pyrex dish on the wire rack, level 1.
Meat loaf	600 W, 20-25	Place the Pyrex dish on the wire rack, level 1.

## Combined microwave cooking

Hot air grilling   
Top/bottom heating 

Dish	Microwave setting (watts), Cooking time in minutes	Type of heating	Temperature in °C	Notes
Potato gratin	600 W, 20-25		170-190	Place the 22 cm diameter Pyrex dish on the wire rack, level 1.







Dish	Microwave setting (watts), Cooking time in minutes	Type of heating	Temperature in °C	Notes
Cake	180 W, 15-20		180-200	Place the 22 cm diameter Pyrex dish on the wire rack, level 1.
Chicken*	360 W, 25-30		200-220	Turn after 15 minutes.









\* Insert the wire rack at level 2 and the universal pan at level 1.

In accordance with DIN 44547 and EN 60350

## Baking

The values in the table apply to dishes placed in a cold oven.

Top/bottom heating   
Hot air   
3D hot air   
Intensive heat 

	Ovenware and notes	Level	Type of heating	Temperature in °C	Baking time in minutes
Viennese whirls	Universal pan	2		160-180	20-30
	Universal pan	2		150-170	20-30
	Enamel baking tray* + universal pan**	1+3		140-160	40-50
Small Cakes	Universal pan	2		160-180	25-35
	Universal pan	2		140-160	25-35
Small Cakes (preheat)	Enamel baking tray* + Universal pan**	1+3		160-180	35-45
Hot water sponge cake	Springform cake tin on the wire rack	1		170-180	30-40
Yeast cakes on a baking tray	Universal pan	2		170-190	45-55
	Enamel baking tray* + universal pan**	1+3		160-180	50-60

	Ovenware and notes	Level	Type of heating	Temperature in °C	Baking time in minutes
German apple pie	2 tinplate 20 cm diameter spring forms*** directly on the wire rack	1		200-220	70-90

\* Enamel baking trays are available as optional accessories in specialist shops



\*\* When baking on two levels, always place the universal pan above the enamel baking tray.

\*\*\* Place the cakes diagonally on the trays.

## Grilling

The values in the table apply to dishes placed in a cold oven.

Grill, large area 

Dish	Accessories	Level	Type of heating	Setting	Cooking time in minutes
Toast	Wire rack	3		High	5-8
Beefburgers, x 12*	Wire rack and universal pan	3 1		High	30

Turn half way through the cooking time.





## Free Manuals Download Website

<http://myh66.com>

<http://usermanuals.us>

<http://www.somanuals.com>

<http://www.4manuals.cc>

<http://www.manual-lib.com>

<http://www.404manual.com>

<http://www.luxmanual.com>

<http://aubethermostatmanual.com>

Golf course search by state

<http://golfingnear.com>

Email search by domain

<http://emailbydomain.com>

Auto manuals search

<http://auto.somanuals.com>

TV manuals search

<http://tv.somanuals.com>