

OWNER'S GUIDE

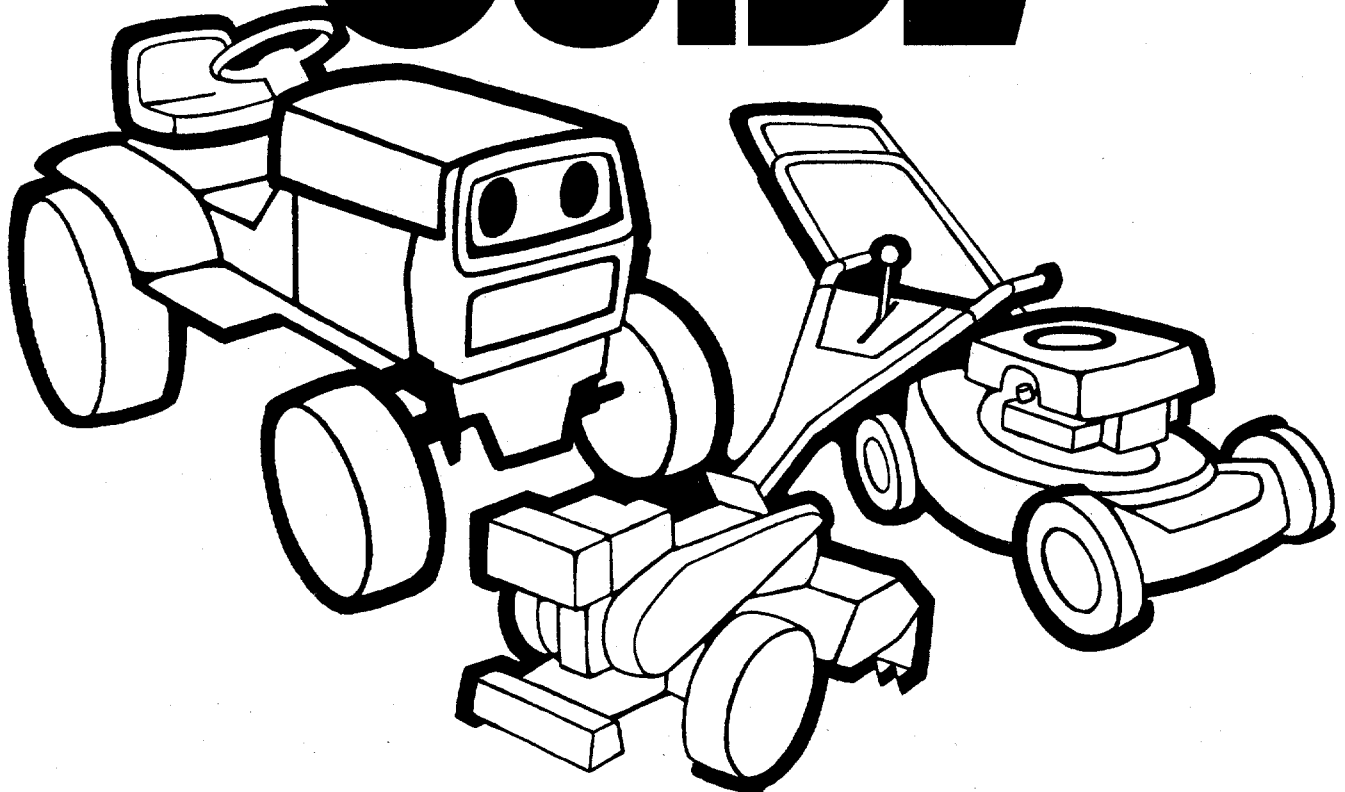

**ASSEMBLY
OPERATION
MAINTENANCE
PARTS LIST**

**IMPORTANT:
Read Safety Rules
and Instructions**

MODEL NUMBERS

120-337A

120-337-300

22"

**REAR DISCHARGE
SELF-PROPELLED
MOWERS**

INDEX

Safe Operation Practices	3	Belt Removal	14
Assembly Instructions	4	Handle Storage	16
Controls	8	Off-Season Storage	16
Operation Instructions	9	Exploded Parts View	18, 20
Adjustments	10	Repair Parts List	19, 21
Lubrication	12	Parts Information	Back Cover
Maintenance	12		

LIMITED WARRANTY

For one year from the date of original retail purchase, MTD PRODUCTS INC will either repair or replace, at its option, free of charge, F.O.B. factory or authorized service firm, any part or parts found to be defective in material or workmanship. Transportation charges for any parts submitted for replacement under this warranty must be paid by the purchaser unless such return is requested by MTD PRODUCTS INC.

This warranty will not apply to any part which has become inoperative due to misuse, excessive use, accident, neglect, improper maintenance, alterations, or unless the unit has been operated and maintained in accordance with the instructions furnished. This warranty does not apply to the engine, motor, battery, battery charger or component parts thereof. Please refer to the applicable manufacturer's warranty on these items.

This warranty will not apply where the unit has been used commercially.

Warranty service is available through your local authorized service dealer or distributor. If you do not know the dealer or distributor in your area, please write to the Customer Service Department of MTD.

The return of a complete unit will not be accepted by the factory unless prior written permission has been extended by MTD.

This warranty gives you specific legal rights. You may also have other rights which vary from state to state.



WARNING

TO PURCHASERS OF INTERNAL COMBUSTION ENGINE EQUIPPED MACHINERY OR DEVICES IN THE STATE OF CALIFORNIA

The equipment which you have just purchased does not have a spark arrester. If this equipment is used on any forest covered land, brush covered land, or grass covered unimproved land in the State of California, before using on such land, the California law requires that a spark arrester be provided. In addition, spark arrester is required by law to be in effective working order. The spark arrester must be attached to the exhaust system and comply with Section 4442 of the California Public Resources Code.

IMPORTANT

It is suggested that this manual be read in its entirety before attempting to assemble or operate. Keep this manual in a safe place for future reference and for ordering replacement parts.

This unit is shipped WITHOUT GASOLINE or OIL. See operating section of this manual for proper fuel and engine oil recommendations.

Your rotary mower is a precision piece of power equipment, not a plaything. Therefore, exercise extreme caution at all times.

SAFE OPERATION PRACTICES FOR WALK-BEHIND MOWERS

TRAINING

1. Read the Operating and Service Owner's Manual carefully. Be thoroughly familiar with the controls and the proper use of the equipment.
2. Never allow children to operate a power mower. Only persons well acquainted with these rules of safe operation should be allowed to use your mower.
3. Keep the area of operation clear of all persons, particularly small children and pets. Stop engine when they are in the vicinity of your mower. Although the area of operation should be completely cleared of foreign objects, a small object may have been overlooked and could be accidentally thrown by the mower in any direction.

PREPARATION

1. Thoroughly inspect the area where the equipment is to be used. Remove all stones, sticks, wire, bones and other foreign objects which could be picked up and thrown by the mower in any direction.
2. Do not operate equipment when barefoot or wearing open sandals. Always wear substantial footwear.
3. Do not wear loose fitting clothing that could get caught on the mower.
4. Check the fuel before starting the engine. Do not fill the gasoline tank indoors, when the engine is running, or while the engine is still hot. Wipe off any spilled gasoline before starting the engine.
5. Disengage the self-propelled mechanism or drive clutch on units so equipped before starting the engine.
6. Never attempt to make a wheel or cutting height adjustment while the engine is running.
7. Mow only in daylight or in good artificial light.
8. Never operate the equipment in wet grass. Always be sure of your footing. Keep a firm hold on the handle and walk, never run.

OPERATION

1. Do not change the engine governor settings or overspeed the engine. Excessive engine speeds are dangerous.
2. Do not put hands or feet near or under rotating parts. Keep clear of the discharge opening at all times.
3. Stop the blade(s) when crossing gravel drives, walks or roads.
4. After striking a foreign object, stop the engine, remove the wire from the spark plug, and thoroughly inspect the mower for any

damage. Repair the damage before restarting and operating the mower.

5. If the equipment should start to vibrate abnormally, stop the engine and check immediately for the cause. Vibration is generally a warning of trouble.
6. Stop the engine whenever you leave the mower, before cleaning the mower housing, and when making any repairs or inspections.
7. When cleaning, repairing or inspecting, make certain the blade and all moving parts have stopped. Disconnect the spark plug wire, and keep the wire away from the plug to prevent accidental starting.
8. Before attempting to unclog the mower or discharge chute, stop the engine and be sure the blade(s) have stopped completely. Disconnect the spark plug wire and keep the wire away from the plug to prevent accidental starting.
9. Do not run the engine indoors.
10. Shut the engine off and wait until the blade comes to a complete stop before removing the grass catcher or unclogging chute.
11. Mow across the face of slopes, never up-and-down. Exercise extreme caution when changing direction on slopes. Do not mow excessively steep slopes.
12. Always disconnect electric mowers (line operated) before cleaning, repairing or adjusting.
13. Never operate mower without proper guards, plates or other safety protective devices in place.
14. Keep washout ports and other mower-housing service openings closed when mowing.
15. **DO NOT OPERATE** this mower with the chute doors open, unless the complete grass catcher is properly mounted on the mower.

MAINTENANCE AND STORAGE

1. Check the blade and engine mounting bolts at frequent intervals for proper tightness.
2. Keep all nuts, bolts, and screws tight to be sure the equipment is in safe working condition.
3. Never store the equipment with gasoline in the tank inside of a building where fumes may reach an open flame or spark. Allow the engine to cool before storing in any enclosure.
4. To reduce fire hazard, keep the engine free of grass, leaves, or excessive grease.
5. Check the grass catcher bag frequently for wear or deterioration. For safety protection replace only with new bag meeting original equipment specifications.

ASSEMBLY INSTRUCTIONS

Contents of Hardware Pack

- A (2) Hand Knobs
- B (2) Curved Carriage Bolts 5/16-18 x 1.75" Long
- C (1) Hex Bolt 1/4-20 x 1.50" Long
- D (1) Hex Lock Nut 1/4-20 Thd.
- E (2) Hairpin Cotters
- F (3) Cable Ties

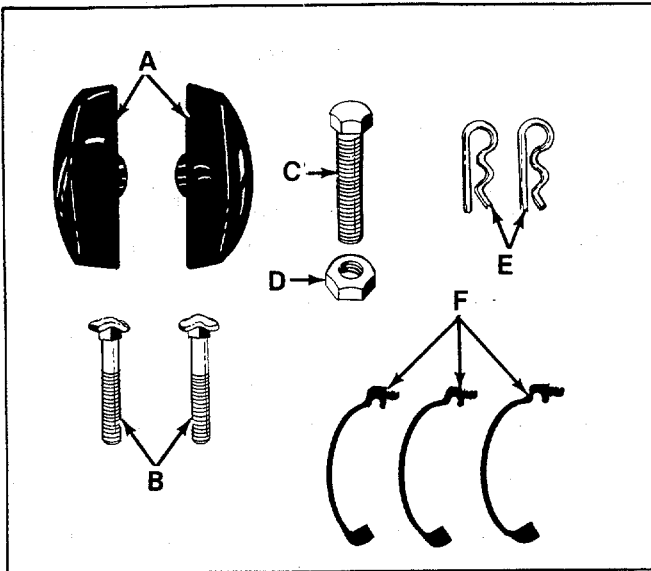

FIGURE 1.

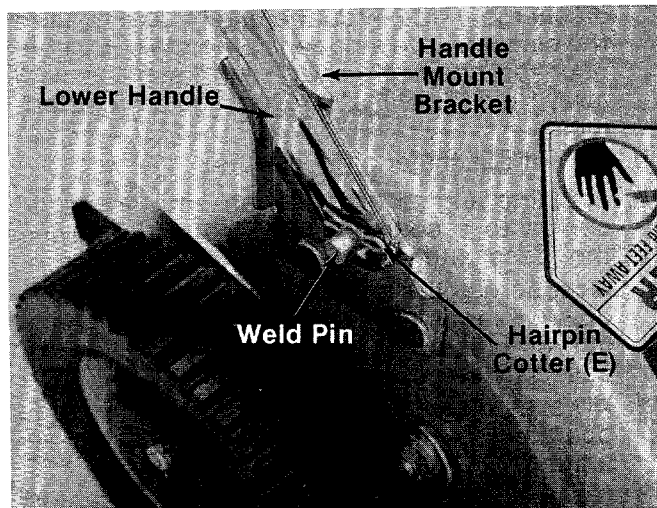

FIGURE 2.

1. Remove the lawn mower, loose parts, hardware pack and literature from the carton. Make certain all parts and literature have been removed before the carton is discarded.
2. Extend the throttle control which is attached to the mower and place on the floor. Be careful not to bend or kink control wire.
3. Place lower handle in position over weld pins in handle mount brackets on deck. Secure by placing two hairpin cotters (E) in inner hole on weld pins. See figure 2.

NOTE

It may be necessary to bend the ends of the lower handle inward slightly to assure a snug fit against the bracket mounting area.

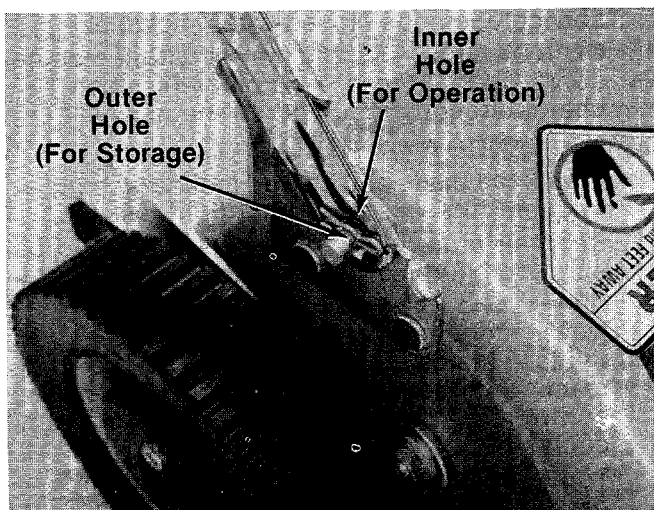

FIGURE 3.

NOTE

There are two (2) holes in the handle mount brackets. Place hairpin cotter in the inner hole for operation. The outer hole is for storage. See figure 3.

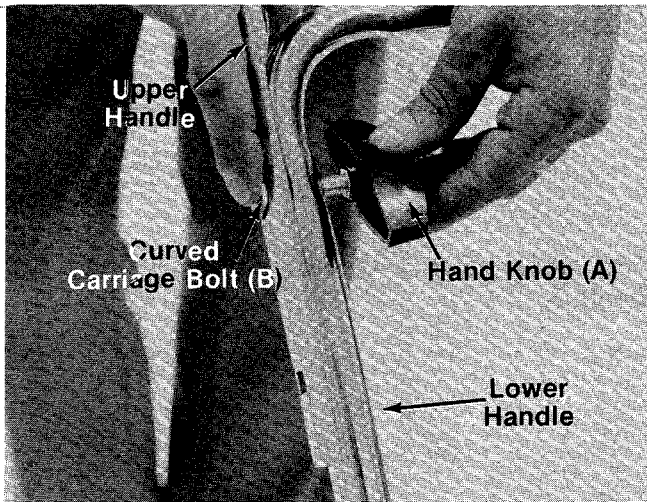

FIGURE 4.

4. There are two height positions for the handle. Place upper handle (with the clutch control attached) in position over lower handle, selecting hole for either high or low position. Refer to figure 24. Secure with two curved carriage bolts (B) and hand knobs (A) as shown in figure 4. The knobs can be either to the inside or the outside of the handle.

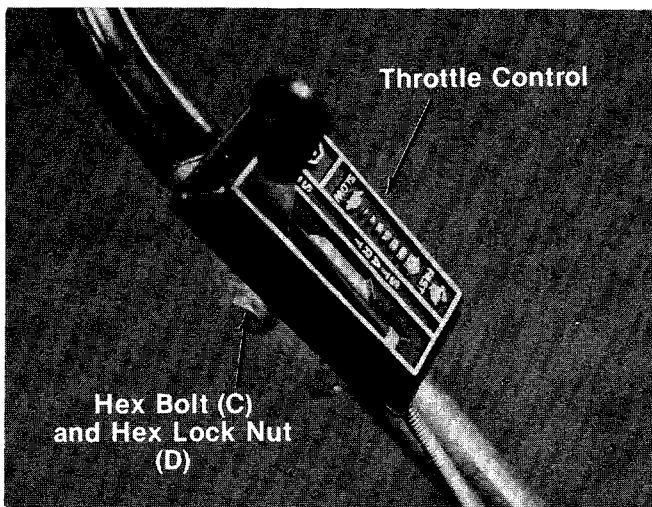

FIGURE 5.

5. Place the throttle control in position on the **left** hand side of upper handle. Secure with hex bolt (C) and hex lock nut (D) provided. See figure 5.



Reference to left or right side of machine is from operator's position at the handle facing forward.

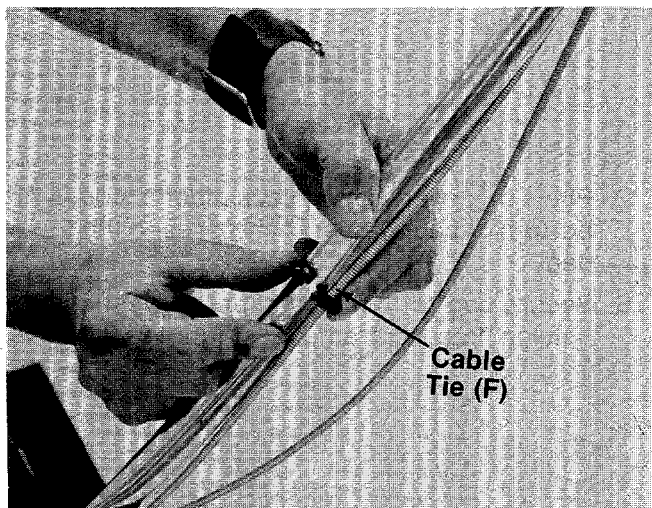
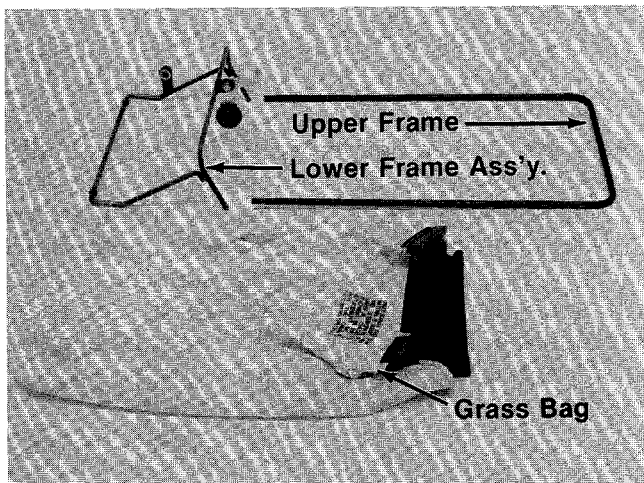

FIGURE 6.

6. Secure throttle control cable and clutch cable to handle with cable ties (F) provided. See figure 6.
7. Check **all** nuts and bolts for correct tightness.

ASSEMBLY Grass Catcher



← The grass catcher is partially assembled. See figure 7.

FIGURE 7.

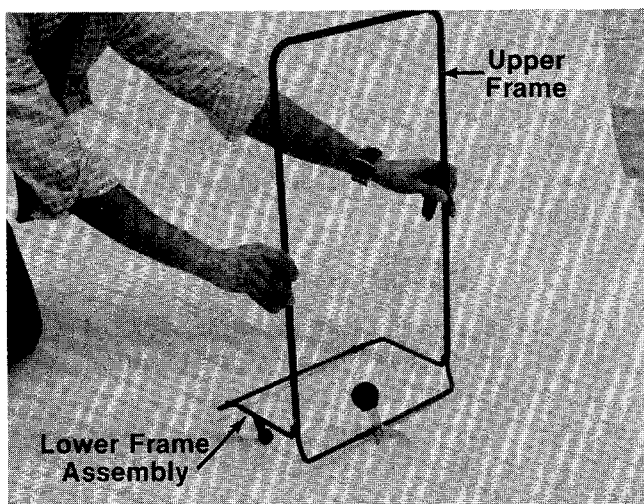

← 1. Place the upper frame over the lower frame assembly as shown in figure 8.

FIGURE 8.

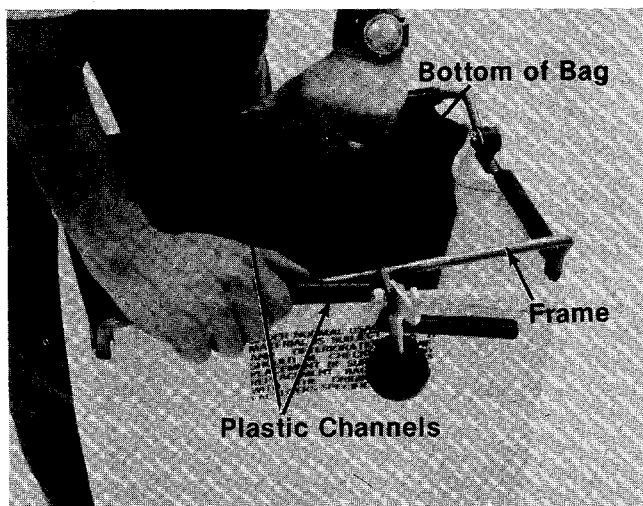

← 2. Place bag over frame (black plastic side is the bottom of bag). Upper frame goes to the top of bag.
3. Secure bag to frame by slipping plastic channels on bag over frame. See figure 9.

FIGURE 9.

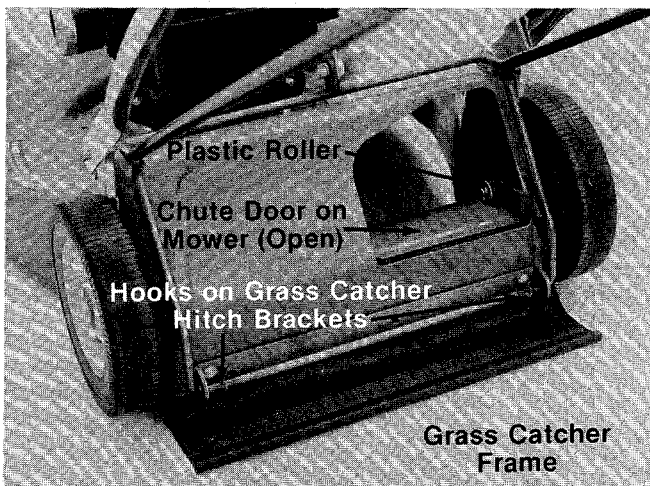

FIGURE 10.

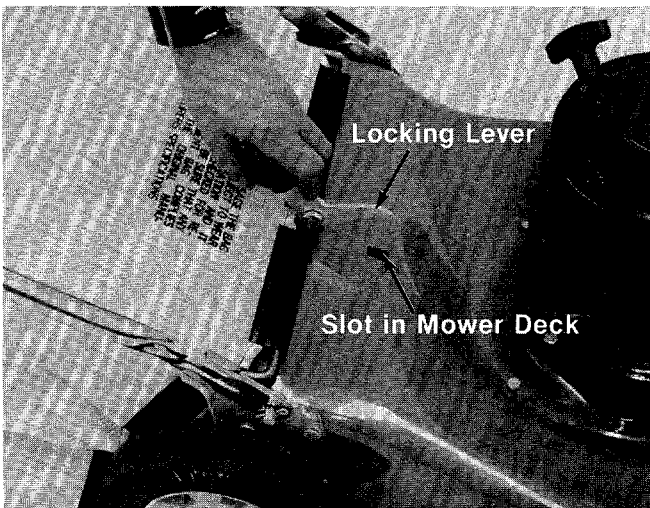

FIGURE 11.

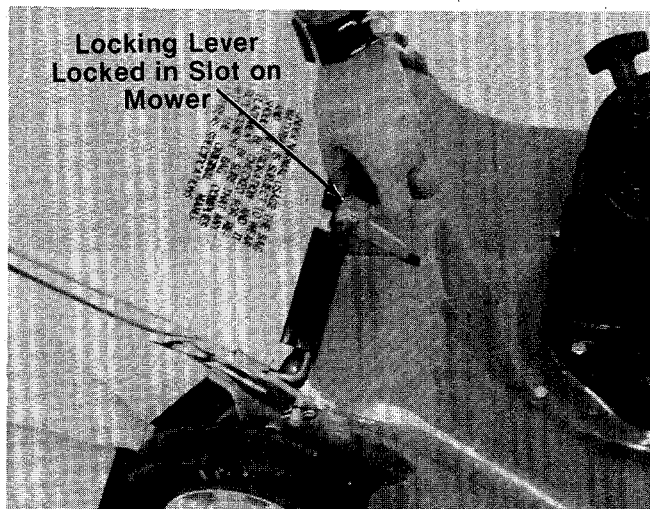

FIGURE 12.

TO ATTACH BAG TO MOWER



WARNING

DO NOT operate the mower with the chute door open unless the complete grass catcher is properly mounted on the mower.

1. Attach the grass catcher frame to grass catcher hitch bracket on rear of the mower by hooking grass catcher into hooks on grass catcher hitch bracket. See figure 10.
2. Lift the rear of grass catcher up. The roller on the grass catcher will push the chute door on the mower open. See figure 10.



NOTE

Figure 10 is shown with the chute door open for photo clarity only.

3. Move the locking lever forward and hook in slot on mower. See figures 11 and 12.

TO REMOVE GRASS CATCHER

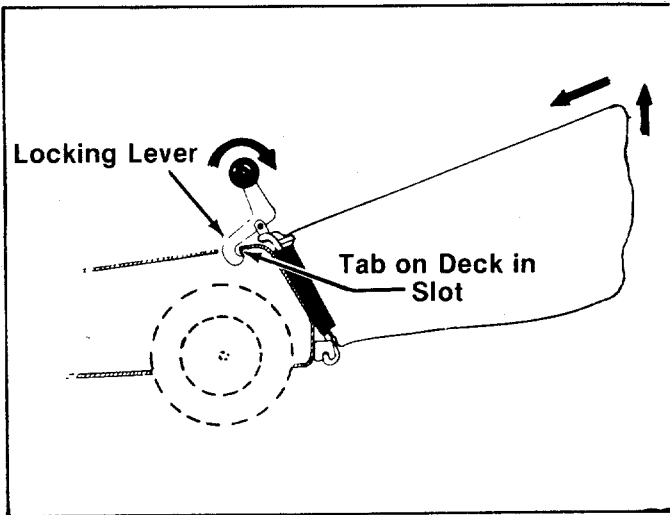

1. To remove the grass catcher, lift the rear of grass catcher, push forward and unhook locking lever.
2. Lift off grass catcher. See figure 13.

FIGURE 13.

CONTROLS

THROTTLE CONTROL

The throttle control is located on the left side of the handle. It is used to regulate the engine speed and to stop the engine. See figure 14.

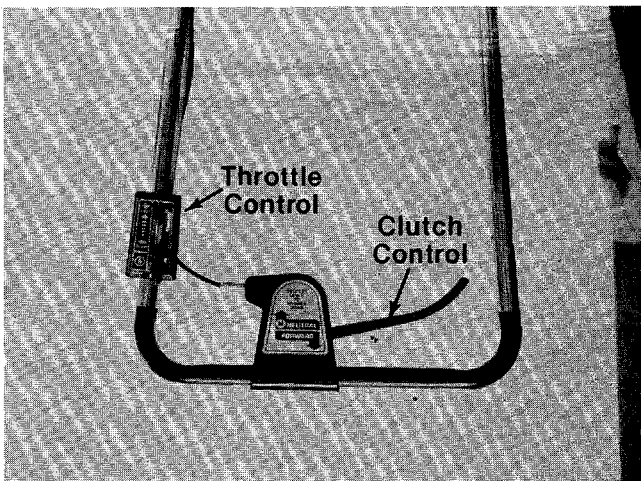

FIGURE 14.

CLUTCH CONTROL

Squeezing the clutch control engages the drive mechanism to the rear wheels. Releasing the clutch control stops the rear wheels from driving. Release the clutch control to slow down when negotiating an obstacle, making a turn or stopping. See figures 14, 15 and 16.

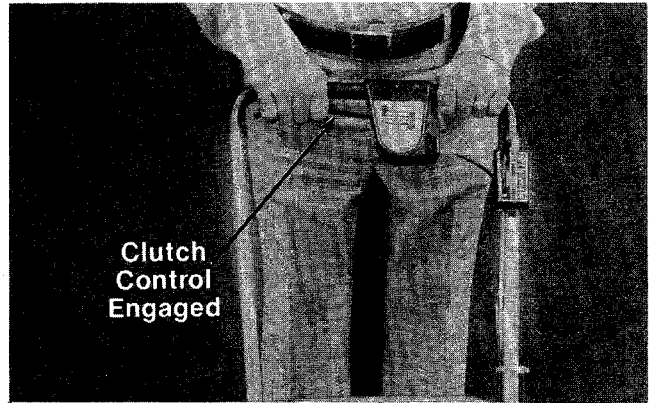

FIGURE 15.

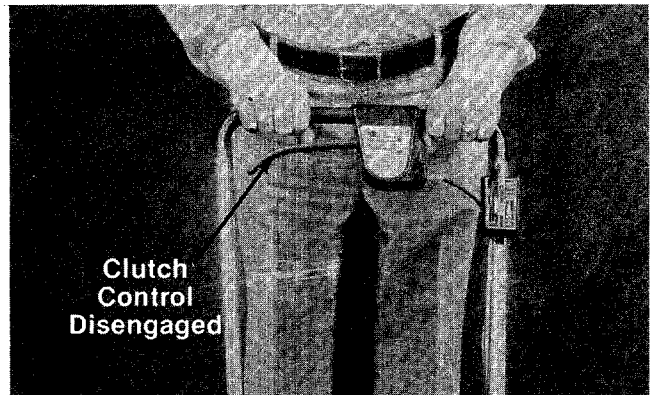

FIGURE 16.



The blade continues to rotate when the clutch is released.

OPERATION

DO NOT OPERATE THIS MOWER WITH THE CHUTE DOOR OPEN, UNLESS THE COMPLETE GRASSCATCHER IS PROPERLY MOUNTED ON THE MOWER.



FIGURE 17.

Keep hands and feet away from the chute area on cutting deck. See figure 17.



For shipping purposes your mower is set with the wheels in a low cutting height position. For best results, raise the cutting position until it is determined which height is best for your lawn. See adjustment section.

BEFORE STARTING

1. Before each use, check for proper clutch operation by performing the following before starting the engine:
With the clutch control released, push mower forward. It should move freely.
Pull mower backward. It should move freely.
If it does not and the rear wheels tend to lock up, the clutch may not be releasing completely. Do not attempt to start the engine until corrections have been made. Check the control cable for severe bend, kinks and binding, grass build up in the pulley groove, proper

positioning of the pulley scraper finger. Be certain the cable housing is secure in the socket on the belt cover.

Correct and adjust as required. See adjustment section. Test again.

2. Check to see that the handle is in the operating detent in the brackets on the deck, and the upstop projections restrict the handle from moving up and forward. If necessary, remove the left side from the mounting pin on the deck bracket. Push inward to decrease the spacing between the two sides of the handle until it is slightly less than the spacing of the deck brackets. Reinstall over the mounting pin and secure the hair cotter pin in the inner holes.
3. Fill sump with oil, using a high quality detergent oil classified "For Service SC, SD, SE or MS." Use SAE 30, SAE 10W-30 or SAE 10W-40 viscosity grade oil. Nothing should be added to the recommended oil.

Place engine level. Remove oil fill plug. See figure 18. Fill to point of overflowing. Pour slowly. Capacity 1 1/4 pints.

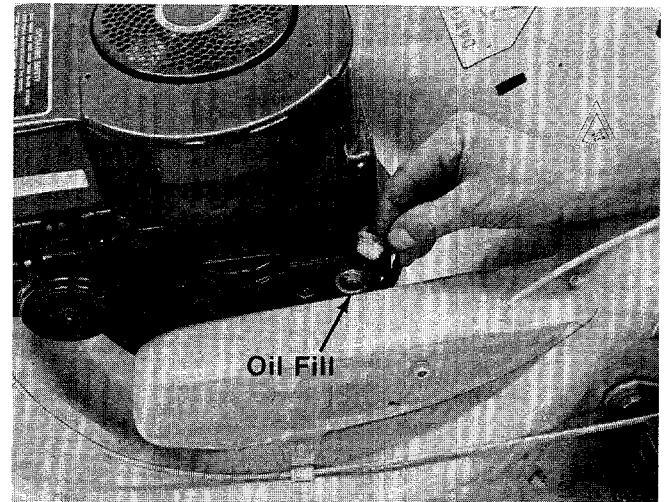

FIGURE 18.

4. **Fill fuel tank**, using clean, fresh, lead-free or leaded "regular" grade automotive gasoline. Fill tank completely.
DO NOT MIX OIL WITH GASOLINE.

TO START ENGINE

1. Move throttle control lever to "START" position.
2. Place foot on the right side of the deck and hold handle to prevent tipping the unit. Grasp starter handle as shown in figure 19 and pull out rapidly. Return it slowly to the engine. Repeat if necessary.

NOTE

This engine features a unique Automatic Choke. In case of flooding, move control to "STOP" and pull starter six times. Then move control to "START" position and start engine. If engine continues to flood, rotate the carburetor needle valve 1/8 turn clockwise to obtain a leaner mixture. See Carburetor Adjustment on page 13.

This mower is designed to be operated at full throttle to give you the best cut and do the most effective job of bagging the cut grass.



FIGURE 19.

TO STOP ENGINE

1. Move throttle control lever to "STOP" position.
2. Remove spark plug wire from spark plug and ground to prevent accidental starting while equipment is unattended.

Be sure that lawn is clear of stones, sticks, wire, or other objects which could damage lawn mower or engine. For best results and to insure more even grass distribution, do not mow when lawn is excessively wet.

IMPORTANT

After striking a foreign object, stop the engine. Remove wire from spark plug, thoroughly inspect the mower for any damage, and repair the damage before restarting and operating the mower.

ADJUSTMENTS

CAUTION

Do not at any time make any adjustment to lawn mower without first stopping engine and disconnecting spark plug wire.

CUTTING HEIGHT

An adjusting plate and thumb lever at each wheel position provides cutting height adjustment. Each adjusting plate has five holes. Height of cut will be changed when the thumb lever is moved from one hole to another. Simply depress the lever towards wheel and move wheel and lever assembly to desired position. See figure 20.

Cutting height will be raised as front and rear levers are lowered. Cutting height will be lowered as front and rear levers are raised. All wheels must be positioned at the same height.

For rough or uneven lawns, move the wheels to a position which will give a higher cutting height.

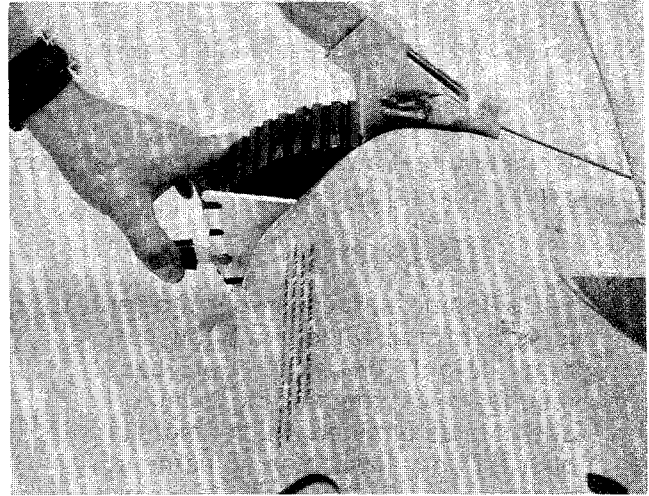

FIGURE 20.

CLUTCH CONTROL ADJUSTMENT

1. To increase belt tension, loosen jam nut and back off two or three threads. Thread the barrel nut on end of control cable outward two or three threads. Retighten jam nut. See figure 21.
2. To decrease belt tension, loosen jam nut and back off two or three threads. Thread the barrel nut on end of control cable inward two or three threads. Retighten jam nut. See figure 21.

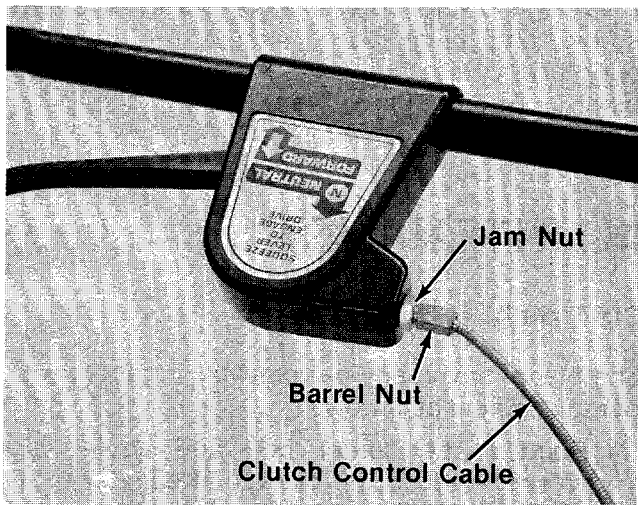

FIGURE 21.

THROTTLE

If adjustment becomes necessary, the throttle control wire assembly can be reset as follows:

1. Loosen, but do not remove, the screw securing throttle control wire assembly at engine. See figure 22.
2. Move throttle control lever on handle to "FAST" position.
3. Move lever to which control wire is fastened at engine to full open position. Retighten screw to secure throttle control wire assembly.

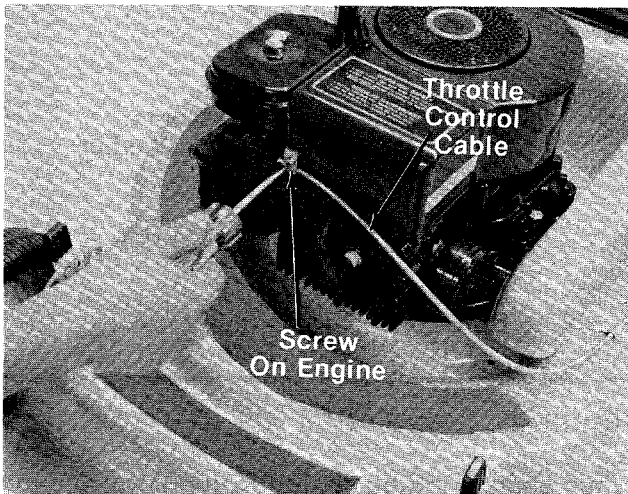

FIGURE 22.

HANDLE POSITION

The upper handle can be adjusted to a high or low position. The operator of the lawn mower can easily adjust the handle position by unscrewing the two knobs, removing the two bolts and reassembling in the other position. No tools are necessary to make this adjustment. See figure 23.

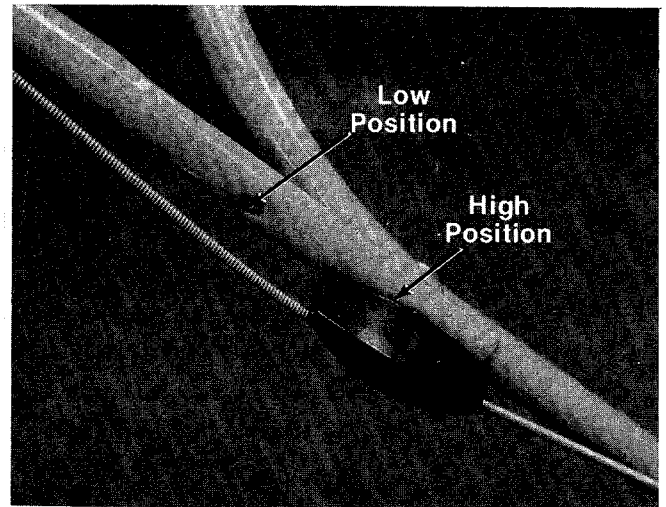

FIGURE 23.



WARNING

If any adjustments are made to the engine while the engine is running (e.g. carburetor), disengage all clutches and blades. Keep clear of all moving parts. Be careful of heated surfaces and muffler.

CARBURETOR ADJUSTMENTS (See figure 24)

Minor carburetor adjustments may be required to compensate for differences in fuel, temperature, altitude and load.

All carburetor adjustments should be made with the air cleaner on engine. Air cleaner mounting screw must be in carburetor when engine is run. Best adjustment is made with a fuel tank half full of gasoline.

To Adjust Carburetor:

1. Start engine and run long enough to warm it to operating temperature.

If engine is out of adjustment so that it will not start, close the needle valve by turning it clockwise. Then open needle valve 1-1/2 turns counterclockwise.
2. Move engine control to run engine at normal operating speed.
 - a. Turn needle valve in clockwise until engine starts to lose speed (lean mixture).
 - b. Then slowly turn needle valve out counterclockwise past the point of smoothest operation until engine just begins to run unevenly (rich mixture).
 - c. Turn needle valve back in clockwise very slowly till engine runs evenly.

- d. Final adjustment of the needle valve should be slightly to the rich side (turn counterclockwise) of the mid-point.
3. Move engine control to SLOW. Turn idle adjusting screw until a fast idle is obtained (1750 R.P.M.).
4. To check adjustment, move engine control from SLOW to FAST speed. Engine should accelerate smoothly. If engine tends to stall or die out, increase idle speed or readjust carburetor, usually to a slightly richer mixture.

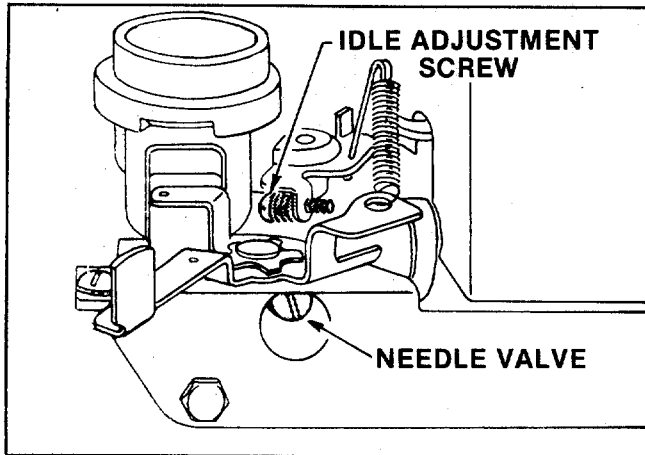

FIGURE 24.

LUBRICATION



Always stop engine and disconnect spark plug wire before cleaning, lubricating or doing any kind of work on lawn mower.

Wheels—Wheel bearings are of self-lubricating Fortiflex. They require no lubrication.

Engine—Follow engine manual for lubrication instructions.

Throttle—Periodically lubricate throttle control lever and throttle wire assembly with a few drops of light oil (SAE No. 10 or 20) for ease of operation.

Chain—To lubricate the chain, remove the master link and chain. Soak the chain in kerosene or a solvent, and let it air dry. Wipe the chain with a rag saturated with SAE 30 oil. Reassemble the chain to the sprockets. Closed end of the master link clip should face in direction of chain travel.

If the rotary mower is operated in a sandy area, the chain should not be lubricated. Excessive oil on a chain will collect dirt and cause excessive wear on the chain and sprockets.

Discharge Chute Door Mechanism—The torsion spring and pivot point should be lubricated periodically with light oil to prevent any rust or binding. Door must work freely.

MAINTENANCE

CUTTING BLADE

The blade may easily be removed for sharpening or replacement as follows:

1. Remove the center bolt and center lock washer holding the blade and adapter to the engine crankshaft.
2. Remove the blade and adapter from the crankshaft.
3. Be careful not to lose the key on the crankshaft. See figure 25.
4. Remove the two smaller bolts, lock washers and nuts holding the blade to the adapter. See figure 25.

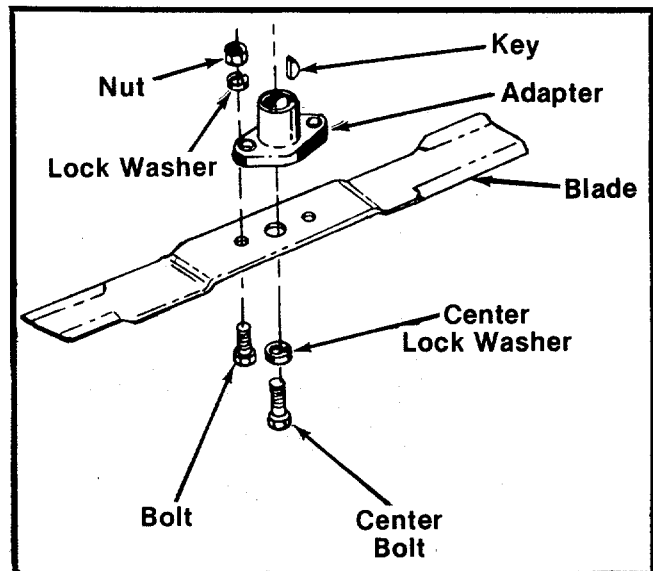

FIGURE 25.

When sharpening blade, follow the original angle of grind as a guide. It is extremely important that each cutting edge receives an equal amount of grinding to prevent an unbalanced blade. An unbalanced blade will cause excessive vibration when rotating at high speeds and may cause damage to the mower.

The blade can be tested for balance by balancing it on a screw driver. Remove metal from the heavy side until it balances evenly. See figure 26.

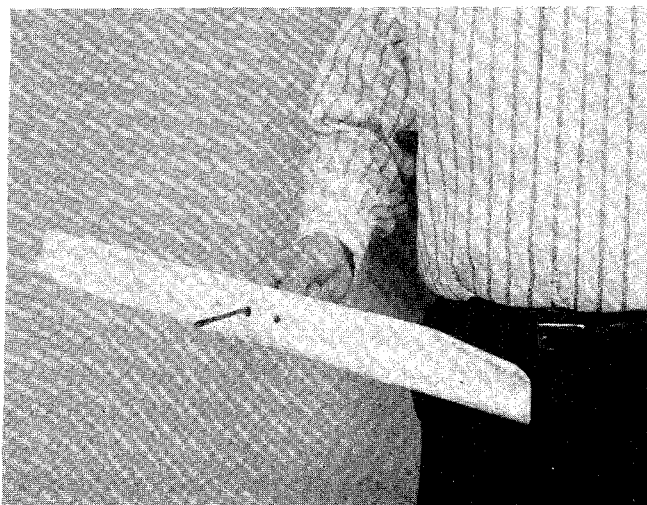

FIGURE 26.



When replacing the blade, be sure the side of the blade marked "Bottom" or having the part number is facing the ground when the mower is in the operating position.

To insure safe operation of your unit, ALL nuts and bolts must be checked periodically for correct tightness.

Blade Mounting Torque

3/8" Dia. Bolt—375 in. lb. min., 450 in. lb. max.
5/16" Dia. Bolt 150 in. lb. min., 250 in. lb. max.

DECK

The underside of mower deck should be cleaned after each period of use as grass clippings, leaves, dirt and other matter will accumulate. This accumulation of grass clippings, etc., is undesirable as it will invite rust and corrosion and may cause an uneven discharge of grass clippings at the next cutting.

Pay particular attention to the area of the rear baffle and chain. Grass may accumulate in this area and must be cleaned out periodically to prevent possible problems with the clutch engagement.

The deck may be cleaned by tilting the mower forward or on its side and scraping clean with a suitable tool or by washing with a stream of water from a garden hose.



CAUTION

Do not direct the stream of water at a hot engine as damage to the engine may result. Be sure spark plug wire is disconnected.

ENGINE OIL

CHECK OIL LEVEL before starting engine and after every 5 hours of operation.

ADD oil as necessary to keep level full to point of overflowing.

Before removing oil fill plug, clean area around plug to prevent dirt from entering oil fill hole.

Engine should be in a level position when checking oil.

CHANGE OIL after first 5 hours of operation. Thereafter change every 25 hours. Change oil while engine is warm. Oil may be drained thru drain on bottom of engine. To drain completely, always place engine level when draining thru the bottom. Oil capacity 1-1/4 pints. See figure 27.

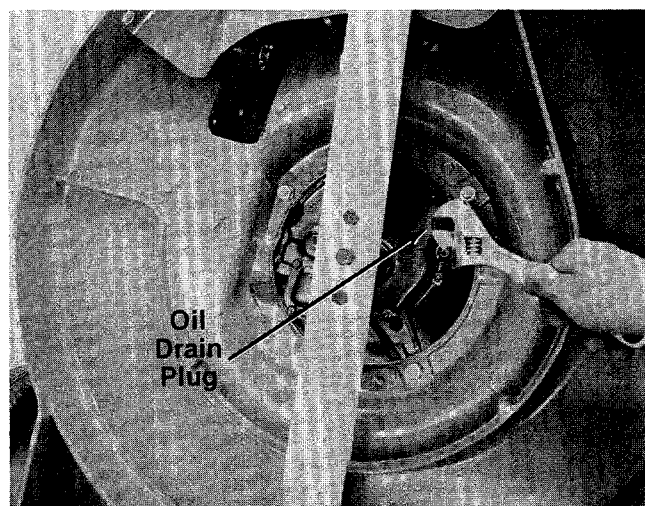

FIGURE 27.

AIR CLEANER

CLEAN AIR CLEANER and re-oil element every 25 hours under normal conditions. Clean every few hours under extremely dusty conditions. Poor engine performance and flooding usually indicates that the air cleaner should be serviced. See figure 28.

1. Remove screw.
2. Remove air cleaner carefully to prevent dirt from entering carburetor.
3. Take air cleaner apart and clean.
 - a. WASH foam element in kerosene or a liquid detergent and water to remove dirt.
 - b. DRY foam completely by wrapping and squeezing in a cloth.
 - c. SOAK foam with engine oil. Squeeze to distribute and remove excess oil.
4. Reassemble parts and fasten to carburetor.

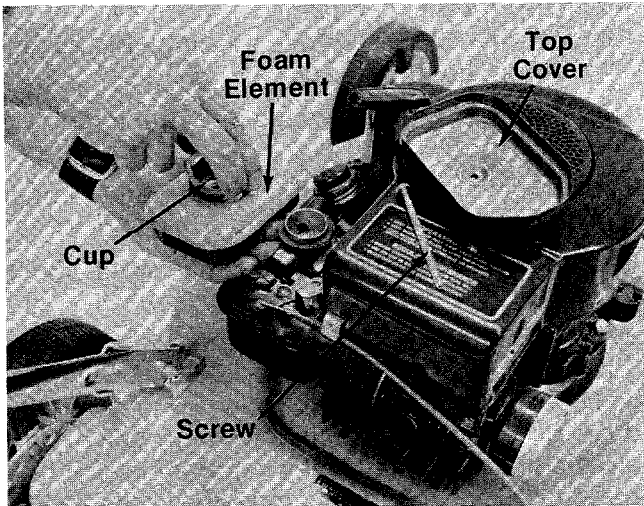

FIGURE 28.

SPARK PLUG

The spark plug gap should be cleaned (see figure 29) and reset to a 0.030-inch clearance once a season (see figure 30). Spark plug replacement is recommended at the start of each mowing season; check engine parts list for correct plug type.

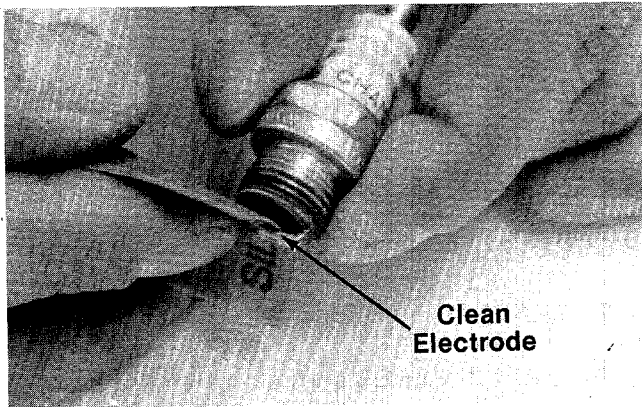

FIGURE 29.

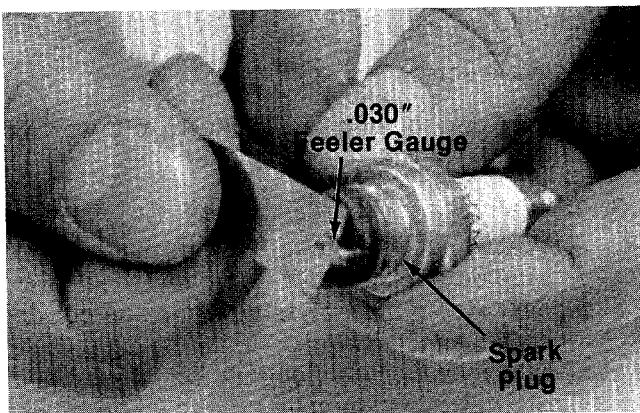

FIGURE 30.

NOTE

Whenever the spark plug is removed for cleaning, it is advisable to replace the spark plug gasket with a new gasket.

BELT REMOVAL

1. Remove the spark plug wire and ground it.
2. Drain the fuel tank or place a piece of plastic film beneath the cap to prevent gasoline leakage.
3. Remove the three screws holding the cable clip and belt guard (and idler assembly). See figures 31 and 32.

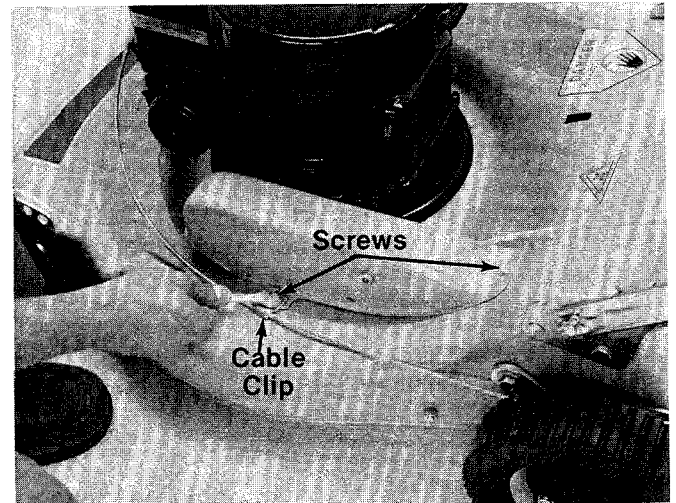

FIGURE 31.

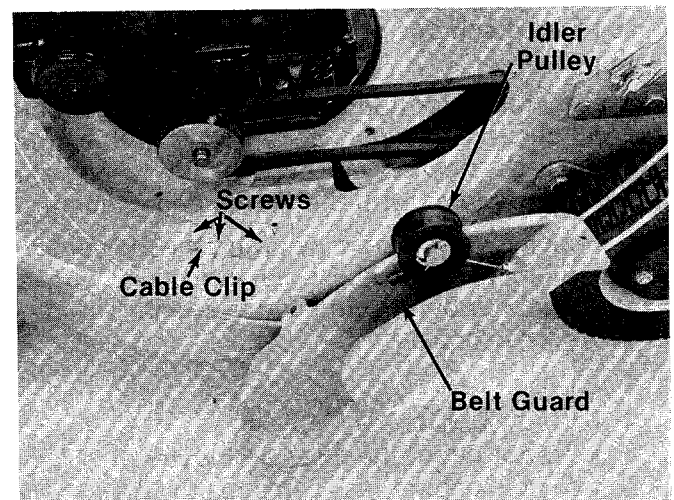

FIGURE 32.

- Remove the belt from the idler as you lift off the belt guard.
- Remove hex nut and lock washer from height adjustment lever on left side of mower as shown in figure 33.



FIGURE 33.

- Place the mower on its side.



Make sure that the mower is secure and cannot tip over.

- Remove two screws, nuts and lock washers. Remove one hex nut and lock washer from cover plate. See figure 34.



FIGURE 34.

- Remove the cover plate. See figure 35.

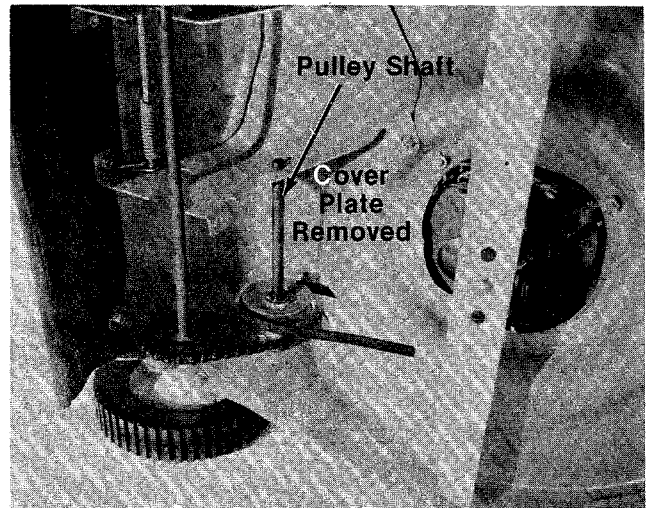

FIGURE 35.

- Remove the master link from the chain. See figure 36.

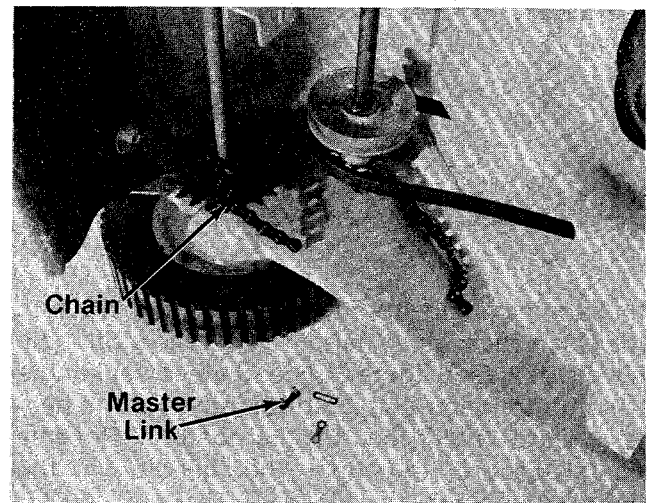

FIGURE 36.

- Remove the chain, pulley shaft and belt. See figure 37.

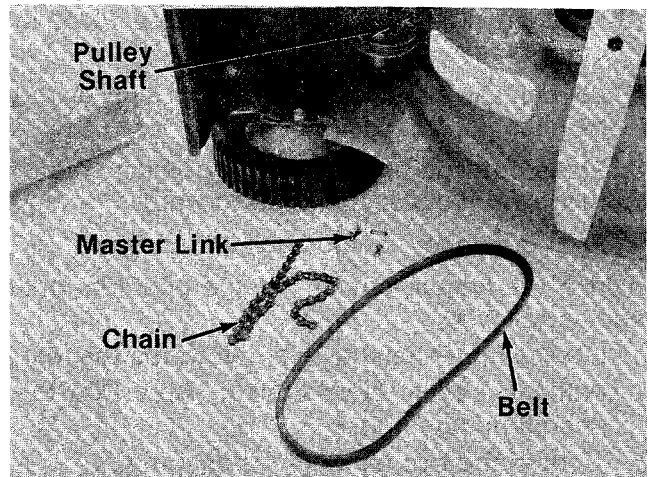

FIGURE 37.

11. Reassemble in reverse order with the new belt, making certain the idler pulley is under the belt. See figure 38.



When reinstalling the chain, be sure the closed end of the master link clip faces in the direction of chain travel.

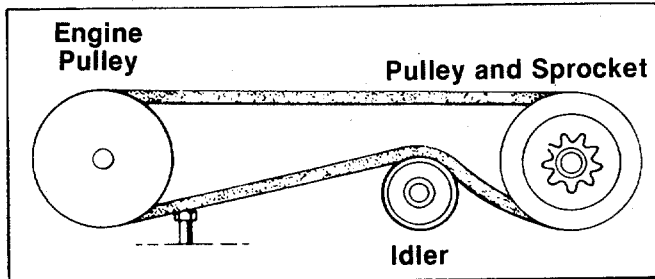

FIGURE 38.

HANDLE STORAGE

The handle can be stored in an upright position to take less space. Move hairpin cotters to outer hole on weld pins (see figure 3). Grasp the lower handle at the bottom and pull apart slightly. Tip the handle forward. It will lock in this position. Reverse this procedure to place the handle in the operating position.

The handle on this model may also be folded away completely for storage.

1. Remove hairpin cotters from inner hole on weld pins on handle mount brackets. Place in outer hole.
2. Loosen the hand knobs on each side of the handle.
3. Press outward on the bottom of each side of the lower handle, and push forward.
4. Fold the upper handle back and down.

To take the handle out of storage position, proceed as follows.

1. Lift the upper handle up and towards the rear.
2. Pull the handle back until it locks into the operator's position.
3. Tighten the two hand knobs securely.
4. Move the hairpin cotters to the inner hole on the weld pins.

OFF-SEASON STORAGE

If the machine is to be inoperative for a period longer than 30 days, the following procedures are recommended:

1. Working outdoors, drain all fuel from the fuel tank. Use a clean dry cloth to absorb the small amount of fuel remaining in the tank. Then run the engine until all fuel in the carburetor is exhausted.



Do not drain fuel while smoking, or if near an open fire.

2. Drain all the oil from the crankcase (this should be done after the engine has been operated and is still warm). Refill the crankcase with clean new oil.
3. Disconnect the spark plug wire and remove the spark plug from the cylinder. Pour about 2 or 3 tablespoons of engine oil into the cylinder. Turn the engine over several times to spread out the oil. Replace the spark plug, but do not connect the wire.
4. Clean the engine and the entire mower thoroughly.
5. Lubricate all lubrication points.

 **NOTE**

The use of any accessory on this Rotary Mower other than those manufactured by the mower manufacturer is **not** recommended.



DO NOT operate the mower with the chute door open unless the complete grass catcher is properly mounted on the mower.



The mower shall not be operated without the protective shield on the rear of the mower in place.

 **NOTE:**

Under normal usage bag material is subject to wear and should be checked periodically. Be sure any replacement bag complies with the mower manufacturer's recommendations.

For replacement bags, use only factory authorized replacement bag No. 764-0171.

129-337A 129-337-300

IF YOU WRITE TO US ABOUT THIS ARTICLE
OR IF YOU ORDER REPLACEMENT PARTS AL-
WAYS MENTION THIS MODEL & SERIAL NO
MODEL

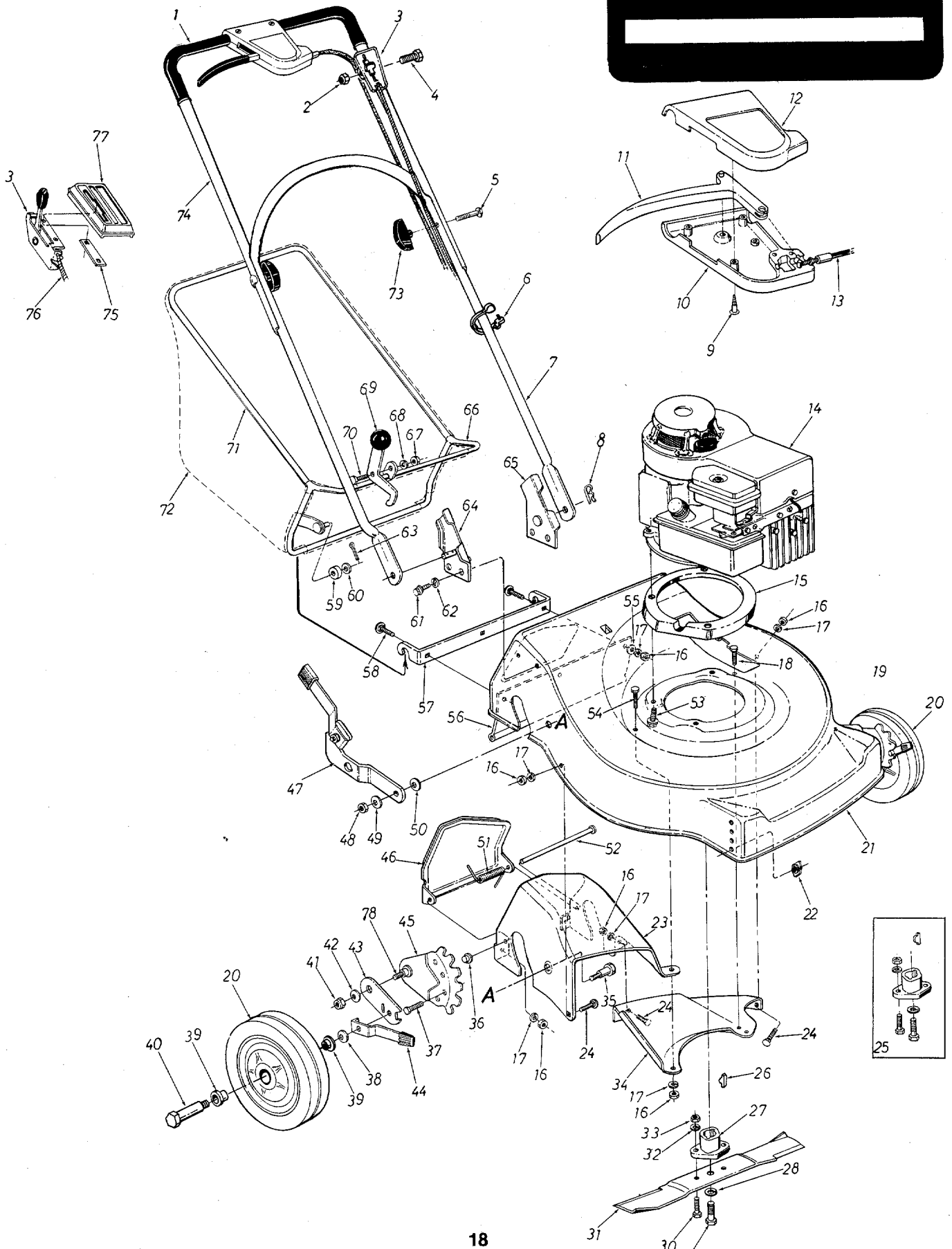

PARTS LIST FOR MODEL 120-337A AND 120-337-300

REF. NO.	PART NO.	COLOR CODE	DESCRIPTION	NEW PART	REF. NO.	PART NO.	COLOR CODE	DESCRIPTION	NEW PART
1	718-0145		Grip		40	738-0102		Shld. Bolt	
2	712-0107		Hex Cent. L-Nut 1/4-20 Thd.		41	712-0375		Hex Cent. L-Nut 3/8-16 Thd.	
3	746-0179		Throttle Control Ass'y. Comp.		42	736-0255		Belleville Wash. .50" I.D. x 1.14" O.D. x .029	
4	710-0606		Hex Bolt 1/4-20 x 1.50" Lg.*		43	10619		Pivot Bar	
5	710-0405		Curved Hd. Carriage Bolt 5/16-18 x 1.75" Lg.		44	10531		Spring Lever Ass'y. w/Knob	
6	726-0188		Plastic Cable Tie		45	12323		Index Plate	
7	749-0393		Lower Handle	N	46	13407	-456	Chute Door	
8	714-0104		Hairpin Cotter 5/16" Dia.		47	10639		Pivot Brkt. Ass'y.—R.H.	
9	710-0353		Slotted Oval Hd. Self-Tap Scr.		48	712-0342		Hex Jam Nut 3/8-16 Thd.	
10	731-0408		Rear Control Cover		49	736-0105		Belleville Wash. 3/8" I.D.	
11	731-0406		Lever—Clutch Control		50	736-0219		Belleville Wash. .440 I.D.	
12	731-0407		Front Control Cover		51	732-0346		Torsion Spring	
13	746-0308		Clutch Control Cable 58" Lg. Engine		52	738-0386		Hinge Pin .250" Dia. x 7.25" Lg.	
14	—		Engine Mount Cover Plate		53	710-0654		Hex Wash. Hd. Self-Tap Scr. 3/8-16 x .88" Lg.	N
15	13773	-452	Hex Nut 1/4-20 Thd.*		54	710-0258		Hex Bolt 1/4-20 x .62" Lg.*	
16	712-0287		L-Wash. 1/4" I.D.*		55	736-0211		FI-Wash. .285" I.D. x 1.25" O.D. x .060 Thk.	
17	736-0329		Hex Wash. Hd. Self-Tap Scr. 1/4-20 x .75" Lg.		56	731-0449		Rear Flap Ass'y.	N
18	710-0642		Height Adj. Ass'y.—L.H.		57	14012	-456	Grass Catcher Hitch Brkt.	
19	12321 12322		Height Adj. Ass'y.—R.H. (Not Shown)		58	710-0703		Carriage Bolt 1/4-20 x .75" Lg.*	
20	734-0894		Wheel Ass'y. Comp.—Front 8.0 x 1.75		59	731-0430		Plastic Roller	
21	14005	-456	22" Deck Ass'y.	N	60	736-0185		FI-Wash. .406" I.D. x .74" O.D. x .063	
22	712-0297		Oval Nut 3/8-16 Thd. (Special)		61	710-0776		Hex Wash. Hd. Self-Tap Scr. 1/4-20 x .62" Lg.	N
23	13406	-456	Rear Chute—R.H.		62	736-0329		L-Wash. 1/4" I.D.*	
24	710-0167		Carriage Bolt 1/4-20 x .50" Lg.*		63	714-0507		Cotter Pin 3/32" Dia. x .75" Lg.*	
25	10769		Blade Adapter Kit		64	12296		Handle Mount Brkt. Ass'y.— R.H.	
26	714-0365		#6 Hi-Pro Key 5/32 x 5/8" Dia.		65	12297		Handle Mount Brkt. Ass'y.— L.H.	
27	10769		Blade Adapter Kit		66	13924		Grass Catcher—Lower Frame Ass'y.	
28	736-0217		L-Wash. 3/8" I.D. Heavy Duty		67	712-0267		Hex Nut 5/16-18 Thd.*	
29	710-0459		Hex Bolt 3/8-24 x 1.50" Lg. (Grade 5)		68	736-0119		L-Wash. 5/16" I.D.*	
30	710-0117		Hex Bolt 5/16-24 x 1.00" Lg. (Grade 5)		69	13435		Cam—Lever Grip Ass'y.	
31	742-0125		22" Blade		70	738-0140		Shld. Bolt .437" Dia. x .180" Lg.	
32	736-0119		L-Wash. 5/16" I.D.*		71	749-0278		Grass Catcher Upper Frame	
33	712-0123		Hex Nut 5/16-24 Thd.*		72	764-0171		Grass Bag	
34	14014	-456	Rear Chute Baffle—L.H.	N	73	09966		Hand Knob	
35	738-0430		Shld. Bolt .50" Dia. x .685" Lg.		74	749-0376		Upper Handle	N
36	726-0106		Push Nut 1/4" Rod		75	726-0134		Speed Nut #8-32 Twin Type	
37	710-0209		Hex Sems Bolt 3/8-16 x .62" Lg.*		76	746-0375		Conduit and Wire	N
38	736-0105		Belleville Wash. 3/8" I.D.		77	731-0344		Plastic Cover	
39	741-0262		Plastic Flange Bearing		78	738-0269		Shld. Bolt.	

*For faster service obtain standard nuts, bolts, and washers locally. If these items cannot be obtained locally, order by part number and size as shown on parts list.

(456—Radiant Tangerine)

When ordering parts, if color or finish is important use the appropriate color code shown above. (e.g. Radiant Tangerine Finish—14005 (456).)

NOTE: The engine is not under warranty by the mower manufacturer... If repairs or service is needed on the engine, please contact your nearest authorized engine service outlet. Check the "Yellow Pages" of your telephone book under "Engines—Gasoline."



120-337A 120-337-300

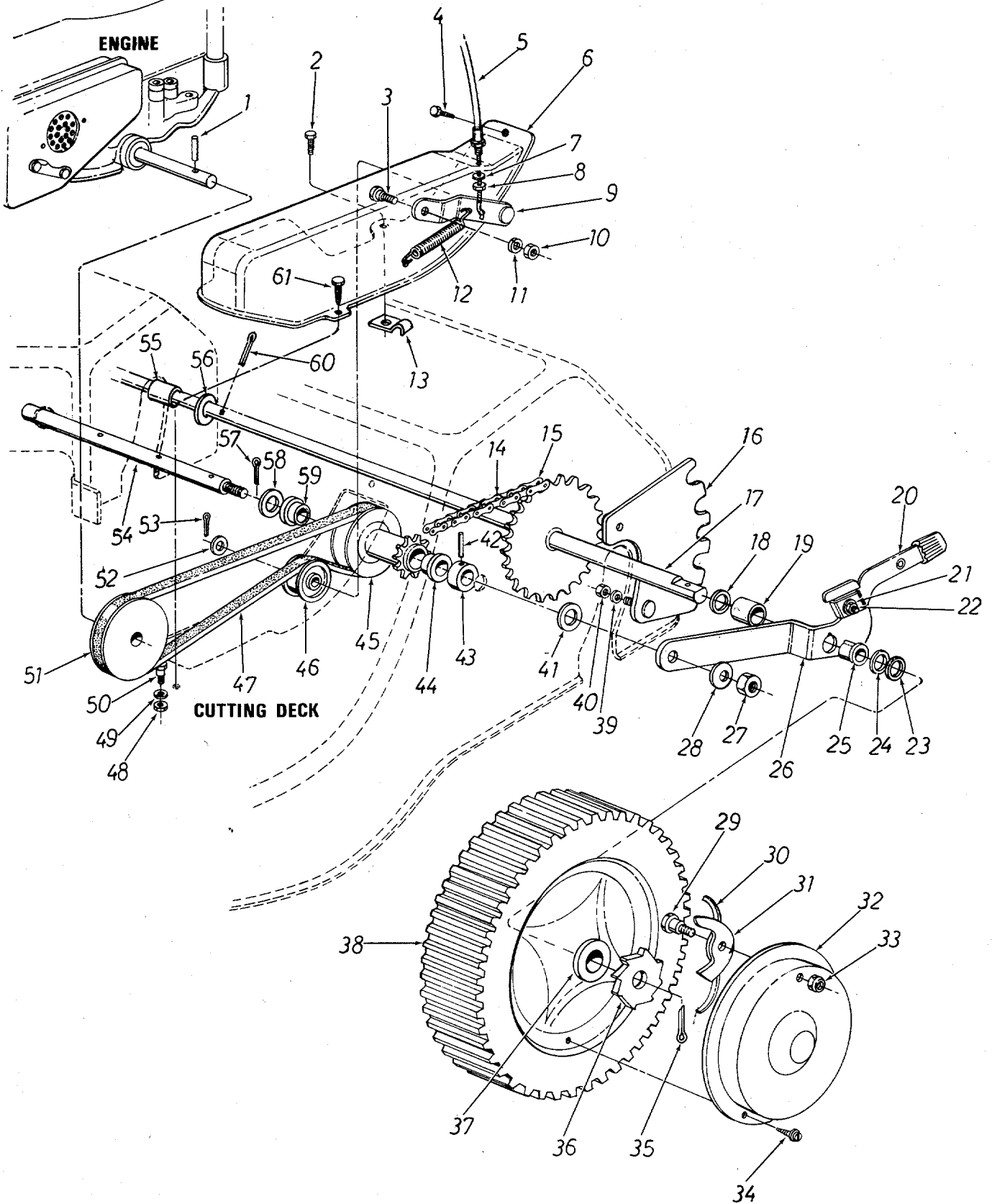

PARTS LIST FOR MODEL 120-337A AND 120-337-300

REF. NO.	PART NO.	COLOR CODE	DESCRIPTION	NEW PART	REF. NO.	PART NO.	COLOR CODE	DESCRIPTION	NEW PART
1	715-0105		Spring Pin Roll 3/16" Dia. x 1.50" Lg.		33	712-0219		Elastic Stop Nut 1/4-20 Thd.	
2	710-0642		Hex Tap Scr. 1/4-20 x .75" Lg.*		34	710-0748		Pan Hd. Tap Scr. #12 x .50" Lg.	
3	738-0255		Shld. Bolt .375" Dia. x .171 Lg.		35	714-0115		Cotter Pin 1/8" Dia. x 1.00" Lg.*	
4	710-0599		Hex Wash. Hd. Self-Tap Scr. 1/4-20 x .50" Lg.		36	748-0187		Ratchet—Rear Wheel	
5	746-0308		Clutch Control Cable 58" Lg.		37	741-0262		Flange Brg. Plastic .50" I.D.	
6	12309	—456	Belt Cover		38	734-0880		Wheel Ass'y. Comp. 8.0 x 1.75"—Rear	
7	736-0329		L-Wash. 1/4" I.D.*		39	736-0119		L-Wash. 5/16" I.D.*	
8	712-0298		Hex Jam Nut 1/4-20 Thd.*		40	712-0267		Hex Nut 5/16-18 Thd.*	
9	13415		Idler Brkt. Ass'y.		41	736-0219		Belleville Wash. .400" I.D.	
10	712-0287		Hex Nut 1/4-20 Thd.*		42	715-0120		Spring Pin Spiral 3/16" Dia. x 1.00" Lg.	
11	736-0329		L-Wash. 1/4" I.D.*		43	750-0387		Spacer .505" I.D. x .880" O.D. x .44	
12	732-0357		Tension Spring		44	748-0248		Flange Brg. .506 I.D.—Plastic	
13	12894		Cable Clip		45	756-0191		Pulley w/9 Tooth Sprocket Ass'y.	
14	713-0144		#48 Chain 1/2" Pitch x 31 Links		46	756-0192		Plastic Flat Idler Pulley	
15	713-0122		#48 Master Link		47	754-0252		"V"-Belt 1/2" x 33" Long	N
16	10641		Index Plate Ass'y.—L.H. (Rear)		48	712-0267		Hex Nut 5/16-18 Thd.*	
	10642		Index Plate Ass'y.—R.H. (Rear—Not Shown)		49	736-0119		L-Wash. 5/16" Scr.*	
17	13414		Rear Shaft Ass'y.	N	50	738-0140		Shld. Bolt .437" Dia. x .180" Lg.	
18	1540-086		FI-Wash. .51" I.D. x 1.00" O.D. x .125" Thk.		51	756-0115		Engine Pulley	
19	750-0190		Spacer .70" I.D. x 7/8" O.D. x 1.00" Lg.		52	736-0160		FI-Wash. .531" I.D. x .930" O.D. x .050" Thk.	
20	10531		Spring Lever Ass'y. w/Knob		53	714-0115		Cotter Pin 1/8" Dia. x 1.00" Lg.*	
21	736-0105		Belleville Wash. 3/8" I.D.		54	738-0471		Pulley Shaft 10.0" Lg.	N
22	712-0342		Hex Jam Nut 3/8-16 Thd.		55	750-0190		Spacer .70" I.D. x 7/8" O.D. x 1.00" Lg.	
23	736-0160		FI-Wash. .531 I.D. x .930 O.D. x .050" Thk.		56	736-0160		FI-Wash. .531" I.D. x .930" O.D. x .050 Thk.	
24	736-0160		FI-Wash. .531 I.D. x .930 O.D. x .050" Thk.		57	714-0111		Cotter Pin 3/32" Dia. x 1.00" Lg.*	
25	748-0142		Flange Bearing .503" I.D.		58	736-0160		FI-Wash. .531" I.D. x .930" O.D. x .050" Thk.	
26	10638		Pivot Bracket Ass'y.—L.H.		59	741-0248		Flange Brg. .506 I.D. Plastic	
27	712-0342		Hex Jam Nut 3/8-16 Thd.		60	714-0111		Cotter Pin 3/32" Dia. x 1.00" Lg.*	
28	736-0219		Belleville Wash. .400" I.D.		61	710-0599		Hex Wash. S. Tap Scr. 1/4-20 x .50" Lg.	
29	738-0137		Shoulder Bolt .342" Dia. x .268 Lg.						
30	10622		Nylon Spring						
31	748-0188		Pawl						
32	10647		Hub Cap—Rear Wheel						

*For faster service obtain standard nuts, bolts and washers locally. If these items cannot be obtained locally, order by part number and size as shown on parts list.

(456—Radiant Tangerine)

When ordering parts, if color or finish is important use the appropriate color code shown above. (e.g. Radiant Tangerine Finish—14005 (456).)

NOTE: The engine is not under warranty by the mower manufacturer... If repairs or service is needed on the engine, please contact your nearest authorized engine service outlet. Check the "Yellow Pages" of your telephone book under "Engines—Gasoline."



This instruction manual covers various models and all specifications shown do not necessarily apply to your model. Specifications subject to change without notice or obligation.

PARTS INFORMATION

POWER EQUIPMENT PARTS AND SERVICE

Parts and service for all MTD manufactured power equipment are available through the authorized service firms listed below. All orders should specify the model number of your unit, parts number, description of parts and the quantity of each part required.

ALABAMA	BIRMINGHAM
Auto Electric & Carburetor Co.	2625 4th Ave. S. 35233
ARKANSAS	FORT SMITH
Mity Mite Motors, Inc.	4515 South 16th Street 72901
	NORTH LITTLE ROCK
Sutton's Lawn Mower Shop	Rt. 4 Box 368. 72117
CALIFORNIA	PORTERVILLE
Billious	75 North D Street 93257
	SAN BERNARDINO
Lawn Mower Supply Co	25608 E. Baseline 92410
	SAN FRANCISCO
J.W. Jewett Co.	981 Folsom St. 94107
COLORADO	DENVER
South Denver Lawn Equip.	527 West Evans 80223
FLORIDA	JACKSONVILLE
Radco Distributors	2403 Market St. 32206
	OPA LOCKA
Small Eng. Dist.	2351 N.W. 147th St. 33054
GEORGIA	EAST POINT
East Point Cycle & Key.	2834 Church St. 30344
ILLINOIS	LYONS
Keen Edge Co.	8615 Ogden Ave. 60534
INDIANA	ELKHART
Parts & Sales Inc.	2101 Industrial Pkwy. 46514
IOWA	DUBUQUE
Power Lawn & Garden Equip.	2551 J.F. Kennedy. 52001
LOUISIANA	NEW ORLEANS
Suhren Engine Co.	8330 Earhart Blvd. 70118
MARYLAND	TAKOMA PARK
Center Supply Co.	6867 New Hampshire Ave. 20012
MASSACHUSETTS	SPRINGFIELD
Morton B. Collins Co.	300 Birnie Ave. 01107
MICHIGAN	LANSING
Lorenz Service Co.	2500 S. Pennsylvania. 48910
	MOUNT CLEMENS
Power Equipment Dist.	36463 South Gratiot .. 48043
MINNESOTA	HOPKINS
Hance Distributing Inc.	420 Excelsior Ave. W. 55343
	ST. PAUL
Power Tools Inc.	3771 Sibley Memorial Hwy. 55122
MISSISSIPPI	BILOXI
Biloxi Sales & Service, Inc.	506 Caillavet St. 39533
MISSOURI	KANSAS CITY
Automotive Equip. Service	3117 Holmes St. 64109
	ST. JOSEPH
Ross-Frazier Supply Co.	8th and Monteray 64503
	ST. LOUIS
Henzler, Inc.	2015 Lemay Ferry Rd. 63125
NEW JERSEY	BELLMAWR
Lawnmower Parts Inc.	717 Creek Rd. 08030
	RUTHERFORD
Feld Distributor	28 Glen Rd. 07070
NEW YORK	CARTHAGE
Gamble Dist., Inc.	West End Ave. 13619

BRIGGS AND STRATTON, TECUMSEH AND PEERLESS PARTS AND SERVICE

Briggs & Stratton, Tecumseh and Peerless parts and service should be handled by your nearest authorized engine service firm. Check the yellow pages of your telephone directory under the listing: **Engines—Gasoline**, Briggs & Stratton or Tecumseh Lauson.

	SYRACUSE
GTP Leisure Products Inc.	420 Marcellus St. 13204
NORTH CAROLINA	GOLDSBORO
Smith Hardware Co.	515 N. George St. 27530
	GREENSBORO
Dixie Sales Company	327 Battleground Ave. 27402
OHIO	CARROLL
Stebe's Mid-State Mower Supply ...	Box 366-71 High St. ... 43112
	CLEVELAND
Bleckrie, Inc.	7900 Lorain Ave. 44102
	WADSWORTH
National Central.	687 Seville Rd. 44281
	YOUNGSTOWN
Burton Supply Co.	1301 Logan Ave. Box 929 .. 44501
OKLAHOMA	ADA
Ada Auto Supply	301 E. 12th St. 74820
	MUSKOGEE
Victory Motors, Inc.	605 S. Cherokee. 74401
	OKLAHOMA CITY
Forest Sales Inc.	1039 NW 63rd St. 73116
OREGON	PORTLAND
Kenton Supply Co.	8216 N. Denver Ave. ... 97217
PENNSYLVANIA	CHESTER
Stull Equipment Corp.	742 W. Front St. 19013
	HARRISBURG
EECO Inc.	4021 N. 6th St. 17110
	PHILADELPHIA
Thompson Rubber Co.	5222-24 N. Fifth St. ... 19120
	PITTSBURGH
Bluemont Co.	11125 Frankstown Rd. 15235
TENNESSEE	KNOXVILLE
Master Repair Service.	2000 Western Ave. ... 379
	MEMPHIS
Memphis Cycle & Supply Co.	421 Monroe Ave. 38100
American Sales & Service, Inc.	1922 Lynnbrook. 38116
TEXAS	DALLAS
Marr Brothers, Inc.	423 E. Jefferson. 75203
	FORT WORTH
Woodson Sales Corp.	1702 N. Sylvania 76111
	HOUSTON
Bullard Supply Co.	2409 Commerce St. 77003
	SAN ANTONIO
Catto & Putty, Inc.	414 Live Oak 78298
UTAH	SALT LAKE CITY
A-1 Engine & Mower Co.	437 E. 9th St. 84111
VERMONT	BURLINGTON
Vermont Hdwe. Co. Inc.	180 Flynn Ave. 05401
VIRGINIA	RICHMOND
RBI Corp.	963 Myers St. 23260
WASHINGTON	SEATTLE
Bailey's Inc.	1414 14th Ave. 98102
WEST VIRGINIA	CHARLESTON
Young's, Inc.	233 Virginia St., E. 25301
WISCONSIN	APPLETON
Automotive Supply Co.	123 S. Linwood Ave. ... 54911

WARRANTY PARTS AND SERVICE POLICY

The purpose of warranty is to protect the customer from defects in workmanship and materials, defects which are NOT detected at the time of manufacture. It does not provide for the unlimited and unrestricted replacement of parts. Use and maintenance are the responsibility of the customer. The manufacturer cannot assume responsibility for conditions which it has no control. Simply put, if it's the manufacturer's fault, it's the manufacturer's responsibility; if it's the customer's fault, it's the customer's responsibility.

CLAIMS AGAINST THE MANUFACTURER'S WARRANTY INCLUDES

1. Replacement of Missing Parts on new equipment.
2. Replacement of Defective Parts within the warranty period.
3. Repair of Defects within the warranty period.

All claims MUST be substantiated with the following information:

1. Model Number of unit involved.
2. Date unit was purchased or first put into service.
3. Date of failure.
4. Nature of failure.

Free Manuals Download Website

<http://myh66.com>

<http://usermanuals.us>

<http://www.somanuals.com>

<http://www.4manuals.cc>

<http://www.manual-lib.com>

<http://www.404manual.com>

<http://www.luxmanual.com>

<http://aubethermostatmanual.com>

Golf course search by state

<http://golfingnear.com>

Email search by domain

<http://emailbydomain.com>

Auto manuals search

<http://auto.somanuals.com>

TV manuals search

<http://tv.somanuals.com>