

# UniFlame®

## OWNER'S MANUAL

### Outdoor Charcoal Grill

Model No.  
**252740**



#### **WARNING**

**FOR YOUR SAFETY:**

**For Outdoor Use Only**  
(outside any enclosure)

**Solamente Para Uso En Exteriores**  
(fuera de cual quier recinto)

## **Table of contents**

Important Safeguards .....	1
Detailed Parts List & Hardware .....	5
Assembly Instructions	
Step 1 .....	7
Step 2 .....	7
Step 3 .....	8
Step 4 .....	8
Step 5 .....	8
Step 6 .....	9
Step 7 .....	9
Step 8 .....	9
Step 9 .....	10
Operating Your Grill .....	11
Cleaning and Care .....	13
Warranty .....	15
Recipes .....	17

Save these instructions for future reference. If you are assembling this unit for someone else, give this manual to the user for future reference.

**Si necesita ayuda llame al 1-800-762-1142  
No devuelva el artículo al lugar de compra.**







## **Indice**

Advertencias y Precauciones .....	2
Lista Detallada de Piezas y Elementos de Ferretería. ....	5
Instrucciones de Montaje	
Paso 1 .....	7
Paso 2 .....	7
Paso 3 .....	8
Paso 4 .....	8
Paso 5 .....	8
Paso 6 .....	9
Paso 7 .....	9
Paso 8 .....	9
Paso 9 .....	10
Funcionamiento de su Parrilla .....	12
Limpieza y Cuidado .....	14
Garantía .....	16
Recetas Premiadas para Barbacoa .....	18

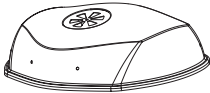
Conserve estas instrucciones para futuras consultas.  
Si está montando esta unidad para otra persona,  
entregue este manual para futuras consultas.

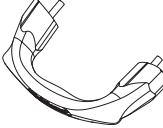
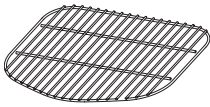
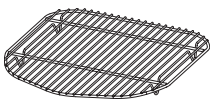
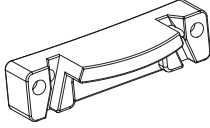

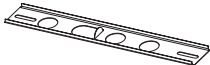
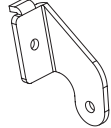
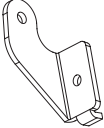
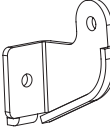
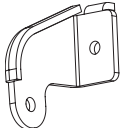
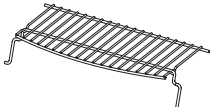
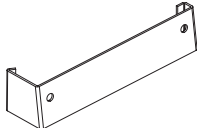
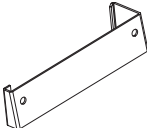









## Detailed Parts List / Lista Detallada de Piezas

<p><b>1. Lid . . . . . 1 pc</b> <b>Reorder number 55-13-90</b> 1. Tapa . . . . . (1) No. de pedido 55-13-90</p>	<p><b>2. Grill Bottom . . . . . 1 pc</b> <b>Reorder number 55-13-91</b> 2. Cuenco de la parrilla (1) No. de pedido 55-13-91</p>	<p><b>3. Wire Leg . . . . . 2 pc</b> <b>Reorder number 55-13-92</b> 3. Pata de varilla . . . . . (2) No. de pedido 55-13-92</p>	<p><b>4. Lid Handle. . . . . 1 pc</b> <b>Reorder number 55-13-93</b> 4. Manija de la tapa . . . (1) No. de pedido 55-13-93</p>
			
<p><b>5. Cooking Grid . . . . . 1 pc</b> <b>Reorder number 55-13-94</b> 5. Rejilla de cocción. . . (1) No. de pedido 55-13-94</p>	<p><b>6. Charcoal Gir . . . . . 1 pc</b> <b>Reorder number 55-13-95</b> 6. Rejilla para el carbón (1) No. de pedido 55-13-95</p>	<p><b>7. Side handle. . . . . 2 pc</b> <b>Reorder number 55-13-96</b> 7. Manija de los lados . (2) No. de pedido 55-13-96</p>	<p><b>8. Lid Air Vent. . . . . 1 set</b> <b>Reorder number 55-13-97</b> 8. Regulador de aire de la tapa . . . . . (1 juego) No. de pedido 55-13-97</p>
			
<p><b>9. Air Damper . . . . . 1 pc</b> <b>Reorder number 55-13-98</b> 9. Regulador de aire . . (1) No. de pedido 55-13-98</p>	<p><b>10. Hinge-A . . . . . 1 pc</b> <b>Reorder number 55-13-99</b> 10. Bisagra-A . . . . . (1) No. de pedido 55-13-99</p>	<p><b>11. hinge-B . . . . . 1 pc</b> <b>Reorder number 55-13-100</b> 11. Bisagra-B . . . . . (1) No. de pedido 55-13-100</p>	<p><b>12. Hinge-C . . . . . 1 pc</b> <b>Reorder number 55-13-101</b> 12. Bisagra-C . . . . . (1) No. de pedido 55-13-101</p>
			
<p><b>13. Hinge-D . . . . . 1 pc</b> <b>Reorder number 55-13-102</b> 13. Bisagra-D . . . . . (1) No. de pedido 55-13-102</p>	<p><b>14. Warming Rack . . 1 pc</b> <b>Reorder number 55-13-103</b> 14. Rejilla de calentamiento(1) No. de pedido 55-13-103</p>	<p><b>15. Side Handle Support-A</b> <b>1 pc</b> <b>Reorder number 55-13-104</b> 15. Soporte "A" para manija lateral . . . . . (1) No. de pedido 55-13-104</p>	<p><b>16. Side Handle Support-B</b> <b>1 pc</b> <b>Reorder number 55-13-105</b> 16. Soporte "B" para manija lateral . . . . . (1) No. de pedido 55-13-105</p>
			

**Contact 1-800-762-1142 for assistance.  
Do not return to place of purchase.  
Si necesita ayuda llame al 1-800-762-1142  
No devuelva el artículo al lugar de compra.**

**UniFlame®**

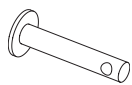
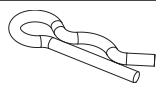
## Hardware / Elementos de Ferretería

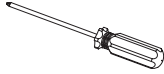
A		<b>Large Bolts 2 pcs.</b> Reorder number <b>55-13-106</b> <i>Pernos grandes</i> (2) No. de pedido 55-13-106	B		<b>Medium Bolts 2 pcs.</b> Reorder number <b>55-13-107</b> <i>Pernos medianos</i> (2) No. de pedido 55-13-107
C		<b>Small Bolts 5 pcs.</b> Reorder number <b>55-13-108</b> <i>Pernos pequeños</i> (5) No. de pedido 55-13-108	D		<b>Air Damper Bolts 2 pcs.</b> Reorder number <b>55-13-109</b> <i>Pernos del regulador de aire</i> (2) No. de pedido 55-13-109
E		<b>Large Wing Nuts 8 pcs.</b> Reorder number <b>55-13-110</b> <i>Tuercas de mariposa grandes</i> (8) No. de pedido 55-13-110	F		<b>Small Wing Nuts 9 pcs.</b> Reorder number <b>55-13-111</b> <i>Tuercas de mariposa pequeñas</i> (9) No. de pedido 55-13-111
G		<b>Large Lock Washers 2 pcs.</b> Reorder number <b>55-13-112</b> <i>Arandelas de cierre grandes</i> (2) No. de pedido 55-13-112	H		<b>Small Lock Washers 9 pcs.</b> Reorder number <b>55-13-113</b> <i>Arandelas de cierre pequeñas</i> (9) No. de pedido 55-13-113
I		<b>Large Washers 2 pcs.</b> Reorder number <b>55-13-114</b> <i>Arandelas grandes</i> (2) No. de pedido 55-13-114	J		<b>Small Washers 8 pcs.</b> Reorder number <b>55-13-115</b> <i>Arandelas pequeñas</i> (8) No. de pedido 55-13-115
K		<b>Pins 2 pcs.</b> Reorder number <b>55-13-116</b> <i>Pasadores</i> (2) Reorder number 55-13-116	L		<b>Cotter Pins 2 pcs.</b> Reorder number <b>55-13-117</b> <i>Pasadores de horquilla</i> (2) No. de pedido 55-13-117
M		<b>Heat Resistant Washers 6 pcs.</b> Reorder number <b>55-13-118</b> <i>Arandelas resistentes al calor</i> (6) No. de pedido 55-13-118	N		<b>Rectangle Heat Resistant Washers 2 pcs.</b> Reorder number <b>55-13-119</b> <i>Piezas rectangulares resistentes al calor</i> (2) No. de pedido 55-13-119
O		<b>Screwdriver 1 pcs.</b> Reorder number <b>55-13-120</b> <i>Destornillador</i> (1) No. de pedido 55-13-120			

## Assembly Instructions

### For Best Results

Remove all contents from packaging, and make sure all parts are present before attempting to assemble! Tighten all bolt connections by hand first, then when the grill is fully assembled, go back and tighten.

## Instrucciones de Montaje

### Para Obtener los Mejores Resultados

¡Saque todos los componentes del embalaje y asegúrese de que todas las piezas están presentes antes de iniciar el montaje! Apriete primero todas las conexiones de tornillos a mano, a continuación, cuando la parrilla esté completamente montada, acabe de apretar las conexiones.

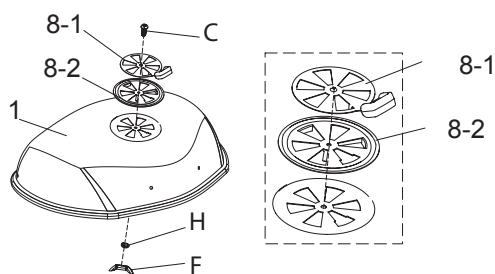

### Step 1

Attach lid air vent (8) to lid (1) using one small bolt (C), one medium lock washer (H), and one small wing nut (F).

**Note:** Assure that tab in air damper top (8-1) fits in notched section of air damper bottom (8-2), and in corresponding section in lid. See insert picture.

### Paso 1

Fije el regulador de aire (8) a la tapa (1) usando un perno pequeño (C), una arandela de cierre mediana (M), y una tuerca de mariposa pequeña (F).

**Nota:** Asegúrese de que la lengüeta en la parte de arriba del regulador de aire (8-1) encaja en la sección con muesca de la parte de abajo del regulador de aire (8-2) y en la sección correspondiente de la tapa. Vea la figura.

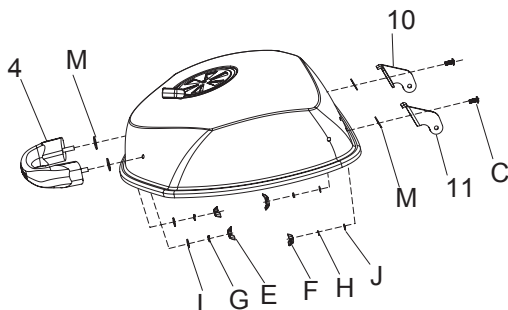

### Step 2

Attach lid handle (4) to lid (1) using heat resistant washers (M), large washers (I), large lockwashers (G), and large wing nuts (E).

Next attach hinge-a (10) and hinge-b (11), as shown using small bolts (C), heat-resistant washers (M), small washers (J), small lock washers (H), and small wing nuts (F), as shown.

### Paso 2

Fije la manija (4) en la tapa (1) usando arandelas resistentes al calor (M), arandelas grandes (I), arandelas de cierre grandes (G), y tuercas de mariposa grandes (E).

Luego, asegure la bisagra "a" (10) y la bisagra "b" (11), como queda indicado usando los pequeños (C), arandelas resistentes al calor (M), arandelas pequeñas (J), arandelas de cierre pequeñas (H), y tuercas de mariposa pequeñas (F), tal como se indica.

**Contact 1-800-762-1142 for assistance.  
Do not return to place of purchase.  
Si necesita ayuda llame al 1-800-762-1142  
No devuelva el artículo al lugar de compra.**

# UniFlame®

### Step 3

Attach hinge-c (12) and hinge-d (13) to grill bottom (2) using small bolts (C), heat resistant washers (M), small washers (J), small lock washers (H), and small wing nuts (F), as shown.

### Paso 3

Instale la bisagra "c" (12) y la bisagra "d" (13) en el cuenco de la parrilla (2) usando pernos pequeños (C), arandelas resistentes al calor (M), arandelas pequeñas (J), arandelas de cierre pequeñas (H), y tuercas de mariposa pequeñas (F), como se ilustra.

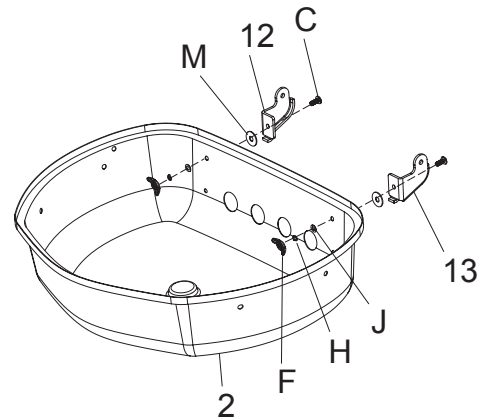

### Step 4

Apply air damper (9) to rear portion of grill bottom using air damper bolts (D) and large wing nuts (E), as shown.

### Paso 4

Instale el regulador de aire (9) en la parte trasera del cuenco usando pernos (D) del regulador de aire y tuercas de mariposa grandes (E), como se ilustra.

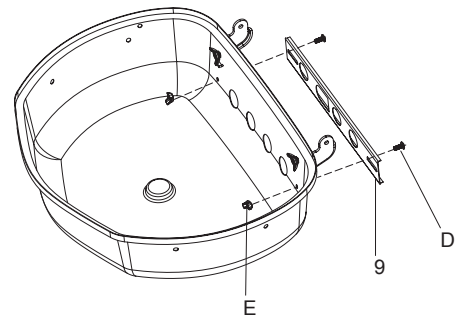

### Step 5

Attach side handle (7), heat resistant washers (N), and side handle support-b (16) to left side of grill bowl using large bolts (A), small washers (J), small lock washers (H), and small wing nuts (F), as shown. Repeat steps using medium bolt (B) instead of large bolt (A) for rear bolt assembly.

Repeat steps to attach handle (7), rectangle heat resistant washer (N) and side handle support-a (15) to right side of grill bottom.

**Note:** The medium bolt (B) goes to the rear when attaching handle. Large bolt (A) is used to attach both handles at the front bolt opening on each handle.

### Paso 5

Fije la manija lateral (7), las piezas rectangulares resistentes al calor (N), y el soporte "b" (16) en el lado izquierdo del cuenco usando pernos grandes (A), arandelas pequeñas (J), arandelas de cierre pequeñas (H), y tuercas de mariposa pequeñas (F), como se ilustra. Repita el mismo procedimiento usando un perno mediano (B) en vez de un perno grande (A) para el montaje en la parte trasera.

Repita los pasos anteriores para fijar la manija (7), la pieza rectangular resistente al calor (N) y el soporte "a" (15) de la manija en la parte derecha del cuenco de la parrilla.

**Nota:** El perno mediano (B) se tiene que colocar atrás al instalar la manija. Use el perno grande (A) para fijar ambas manijas insertándolo en la abertura frontal de cada manija.

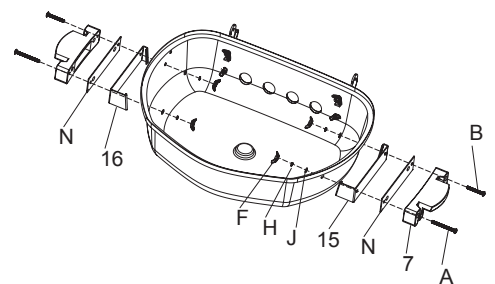



UniFlame Corporation  
A wholly owned subsidiary of Blue Rhino Corporation (NASDAQ-RINO)  
104 Cambridge Plaza Drive, Winston-Salem, NC 27104 USA  
1.800.762.1142, [www.bluerhino.com](http://www.bluerhino.com)

© 2003 CPD Associates, All Rights Reserved  
Made in China



## Free Manuals Download Website

<http://myh66.com>

<http://usermanuals.us>

<http://www.somanuals.com>

<http://www.4manuals.cc>

<http://www.manual-lib.com>

<http://www.404manual.com>

<http://www.luxmanual.com>

<http://aubethermostatmanual.com>

Golf course search by state

<http://golfingnear.com>

Email search by domain

<http://emailbydomain.com>

Auto manuals search

<http://auto.somanuals.com>

TV manuals search

<http://tv.somanuals.com>