

# CHICAGO

## Electric<sup>®</sup> Power Tools

# BREAKER HAMMER

**Model 94882**

### ASSEMBLY AND OPERATING INSTRUCTIONS



Diagrams within this manual may not be drawn proportionally.  
Due to continuing improvements, actual product may differ slightly from the product described herein.

**Distributed exclusively by Harbor Freight Tools<sup>®</sup>.**

3491 Mission Oaks Blvd., Camarillo, CA 93011

Visit our website at: <http://www.harborfreight.com>



**Read this material before using this product.  
Failure to do so can result in serious injury.  
SAVE THIS MANUAL.**

Copyright<sup>®</sup> 2006 by Harbor Freight Tools<sup>®</sup>. All rights reserved. No portion of this manual or any artwork contained herein may be reproduced in any shape or form without the express written consent of Harbor Freight Tools.

**For technical questions or replacement parts, please call 1-800-444-3353.**

## PRODUCT SPECIFICATIONS

Electrical Requirement	120 Volt / 60 Hz / 16 Amps (running)
Impactor Travel	2-3/8"
Overall Dimensions	25" L X 10-7/8" W X 9-3/8" H (hammer only)
Blows per minute	1100 - 2100
Retainer Style	Spring loaded rotational lock (2 positions only)
Retainer Capacity	3/4" (19mm)
Bit hardness	46-56 HRC
Bit Dimensions:	Chisel Bit: 3/4" Shank X 14-1/4" L Bull Point Bit: 3/4" Shank X 1" W X 14-1/4" L
Noise Level	88 DBa @ 3 feet
Impact Energy	3.7 to 18.4 Ft/Lbs.
Tool Weight	33.75 Lbs.

**NOTE: Plug this tool into a 20 Amp. dedicated circuit.**

## SAVE THIS MANUAL

You will need this manual for the safety warnings and precautions, assembly, operating, inspection, maintenance and cleaning procedures, parts list and assembly diagram. Keep your invoice with this manual. Write the invoice number on the inside of the front cover. Keep this manual and invoice in a safe and dry place for future reference.

## GENERAL SAFETY RULES

 **WARNING!**

**READ AND UNDERSTAND ALL INSTRUCTIONS**  
Failure to follow all instructions listed below may result in  
electric shock, fire, and/or serious injury.  
**SAVE THESE INSTRUCTIONS**

### WORK AREA

1. **Keep your work area clean and well lit.** Cluttered benches and dark areas invite accidents.

2. **Do not operate power tools in explosive atmospheres, such as in the presence of flammable liquids, gases, or dust.** Power tools create sparks which may ignite the dust or fumes.
3. **Keep bystanders, children, and visitors away while operating a power tool.** Distractions can cause you to lose control. Protect others in the work area from debris such as chips and sparks. Provide barriers or shields as needed.

### ELECTRICAL SAFETY

4. **Grounded tools must be plugged into an outlet properly installed and grounded in accordance with all codes and ordinances. Never remove the grounding prong or modify the plug in any way. Do not use any adapter plugs. Check with a qualified electrician if you are in doubt as to whether the outlet is properly grounded.** If the tools should electrically malfunction or break down, grounding provides a low resistance path to carry electricity away from the user.
5. **Double insulated tools are equipped with a polarized plug (one blade is wider than the other). This plug will fit in a polarized outlet only one way. If the plug does not fit fully in the outlet, reverse the plug. If it still does not fit, contact a qualified electrician to install a polarized outlet. Do not change the plug in any way.** Double insulation  eliminates the need for the three wire grounded power cord and grounded power supply system.
6. **Avoid body contact with grounded surfaces such as pipes, radiators, ranges, and refrigerators.** There is an increased risk of electric shock if your body is grounded.

7.  **Do not expose power tools to rain or wet conditions.** Water entering a power tool will increase the risk of electric shock.

8. **Do not abuse the Power Cord. Never use the Power Cord to carry the tools or pull the Plug from an outlet. Keep the Power Cord away from heat, oil, sharp edges, or moving parts. Replace damaged Power Cords immediately.** Damaged Power Cords increase the risk of electric shock.
9. **When operating a power tool outside, use an outdoor extension cord marked “W-A” or “W”.** These extension cords are rated for outdoor use, and reduce the risk of electric shock.

### PERSONAL SAFETY

10. **Stay alert. Watch what you are doing, and use common sense when operating a power tool. Do not use a power tool while tired or under the influence of drugs, alcohol, or medication.** A moment of inattention while operating power tools may result in serious personal injury.

11. **Dress properly. Do not wear loose clothing or jewelry. Contain long hair. Keep your hair, clothing, and gloves away from moving parts.** Loose clothes, jewelry, or long hair can be caught in moving parts.
12. **Avoid accidental starting. Be sure the Power Switch is off before plugging in.** Carrying power tools with your finger on the Power Switch, or plugging in power tools with the Power Switch on, invites accidents. Make sure you are prepared to begin work before turning the Power Switch (62) "ON".
13. **Remove adjusting keys or wrenches before turning the power tool on.** A wrench or a key that is left attached to a rotating part of the power tool may result in personal injury.
14. **Do not overreach. Keep proper footing and balance at all times.** Proper footing and balance enables better control of the power tool in unexpected situations.
15.  **Always wear eye, hearing, and breathing protection.** Wear ANSI-approved safety impact eye glasses, ANSI-approved hearing protectors, and ANSI-approved dust mask or respirator when using this product. Also, non-skid safety shoes and a hard hat must be used for appropriate conditions.

#### TOOL USE AND CARE

16. **Do not use the power tool if the Power Switch does not turn it on or off.** Any tool that cannot be controlled with the Power Switch is dangerous and must be replaced or repaired.
17.  **Disconnect the Power Cord Plug from the power source before making any adjustments, changing accessories, or storing the tool.** Such preventive safety measures reduce the risk of starting the tool accidentally.
18. **Store idle tools out of reach of children and other untrained persons.** Tools are dangerous in the hands of untrained users.
19. **Maintain tools with care. Keep cutting tools sharp and clean.** Properly maintained tools with a sharp cutting edge are less likely to bind and are easier to control. Do not use a damaged tool. Tag damaged tools "Do not use" until repaired.
20. **Check for misalignment or binding of moving parts, breakage of parts, and any other condition that may affect the tool's operation. If damaged, have the tool serviced before using.** Many accidents are caused by poorly maintained tools.
21. **Use only accessories that are recommended by the manufacturer for your model.** Accessories that may be suitable for one tool may become hazardous when used on another tool.

## SERVICE

24. **Tool service must be performed only by qualified repair personnel.** Service or maintenance performed by unqualified personnel could result in a risk of injury.
25. **When servicing a tool, use only identical replacement parts. Follow instructions in the “*Inspection, Maintenance, And Cleaning*” section of this manual.** Use of unauthorized parts or failure to follow maintenance instructions may create a risk of electric shock or injury.

## GROUNDING

### WARNING!

**Improperly connecting the grounding wire can result in the risk of electric shock. Check with a qualified electrician if you are in doubt as to whether the outlet is properly grounded. Do not modify the power cord plug provided with the tool. Never remove the grounding prong from the plug. Do not use the tool if the power cord or plug is damaged. If damaged, have it repaired by a service facility before use. If the plug will not fit the outlet, have a proper outlet installed by a qualified electrician.**

## GROUNDED TOOLS: TOOLS WITH THREE PRONG PLUGS

1. Tools marked with “Grounding Required” have a three wire cord and three prong grounding plug. The plug must be connected to a properly grounded outlet. If the tool should electrically malfunction or break down, grounding provides a low resistance path to carry electricity away from the user, reducing the risk of electric shock. **(See Figure A, next page.)**
2. The grounding prong in the plug is connected through the green wire inside the cord to the grounding system in the tool. The green wire in the cord must be the only wire connected to the tool’s grounding system and must never be attached to an electrically “live” terminal. **(See Figure A.)**
3. Your tool must be plugged into an appropriate outlet, properly installed and grounded in accordance with all codes and ordinances. The plug and outlet should look like those in the following illustration. **(See Figure A page 6.)**

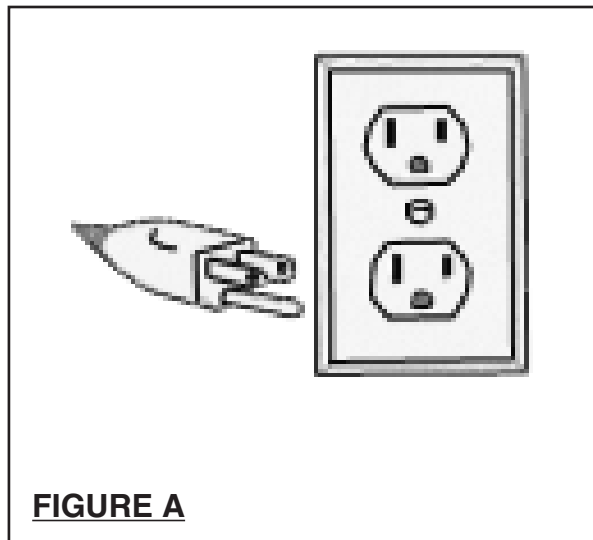

**FIGURE A**

**DOUBLE INSULATED TOOLS: TOOLS WITH TWO PRONG PLUGS**

4. Tools marked “Double Insulated” do not require grounding. They have a special double insulation system which satisfies OSHA requirements and complies with the applicable standards of Underwriters Laboratories, Inc., the Canadian Standard Association, and the National Electrical Code. **(See Figure B.)**
5. Double insulated tools may be used in either of the 120 volt outlets shown in the following illustration. **(See Figure B.)**

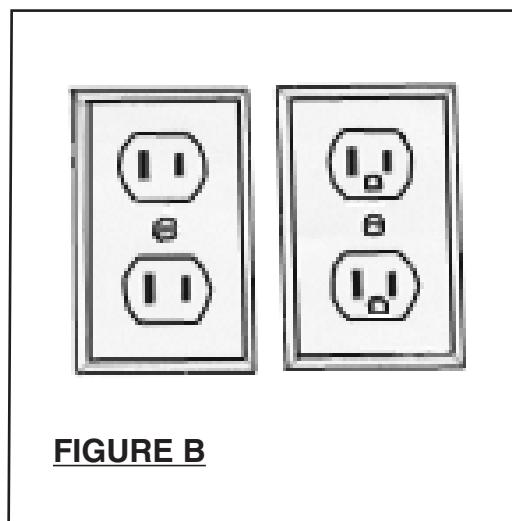

**FIGURE B**



## EXTENSION CORDS

1. **Grounded** tools require a three wire extension cord. **Double Insulated** tools can use either a two or three wire extension cord.
2. As the distance from the supply outlet increases, you must use a heavier gauge extension cord. Using extension cords with inadequately sized wire causes a serious drop in voltage, resulting in loss of power and possible tool damage. **(See Figure C)**
3. The smaller the gauge number of the wire, the greater the capacity of the cord. For example, a 14 gauge cord can carry a higher current than a 16 gauge cord. **(See Figure C, and Figure D.)**
4. If using more than one extension cord to make up the total length, make sure each cord contains at least the minimum wire size required.
5. If you are using one extension cord for more than one tool, add the nameplate amperes and use the sum to determine the required minimum cord size. **(See Figure C, and Figure D.)**
6. If you are using an extension cord outdoors, make sure it is marked with the suffix "W-A" ("W" in Canada) to indicate it is acceptable for outdoor use.
7. Make sure your extension cord is properly wired and in good electrical condition. Always replace a damaged extension cord or have it repaired by a qualified electrician before using it.
8. Protect your extension cords from sharp objects, excessive heat, and damp or wet areas.

RECOMMENDED MINIMUM WIRE GAUGE FOR EXTENSION CORDS*					
NAMEPLATE AMPERES (At Full Load)	EXTENSION CORD LENGTH				
	25 Feet	50 Feet	75 Feet	100 Feet	150 Feet
0 - 2.0	18	18	18	18	16
2.1 - 3.4	18	18	18	16	14
3.5 - 5.0	18	18	16	14	12
5.1 - 7.0	18	16	14	12	12
7.1 - 12.0	18	14	12	10	-
12.1 - 16.0	14	12	10	-	-
16.1 - 20.0	12	10	-	-	-

**FIGURE C** \* Based on limiting the line voltage drop to five volts at 150% of the rated amperes.

## SYMBOLOLOGY

	Double Insulated
	Canadian Standards Association
	Underwriters Laboratories, Inc.
<b>V</b> ~	Volts Alternating Current
<b>A</b>	Amperes
no xxx/min.	No Load Revolutions per Minute (RPM)

## SPECIFIC SAFETY RULES

1. **Maintain labels and nameplates on the Breaker Hammer.** These carry important information. If unreadable or missing, contact Harbor Freight Tools for a replacement.
2. **Industrial applications must follow OSHA requirements.**
3. **Check for damaged parts.** Before using this product, carefully check that it will operate properly and perform its intended function. Check for damaged parts and any other conditions that may affect the operation of this product. Replace or repair damaged or worn parts immediately.
4. **Always disconnect the Breaker Hammer from its electrical outlet before performing any services, maintenance, or cleaning** such as leaving the work area, moving the tool from one location to another, changing Saw Blades, cleaning sawdust from the unit, etc.
5. **WARNING!** Some dust created by power sanding, sawing, grinding, drilling, and other construction activities, contain chemicals known (to the State of California) to cause cancer, birth defects or other reproductive harm. Some examples of these chemicals are:
  - (a) Lead from lead-based paints;
  - (b) Crystalline silica from bricks and cement or other masonry products;
  - (c) Arsenic and chromium from chemically treated lumber.

Your risk from these exposures varies, depending on how often you do this type of work. To reduce your exposure to these chemicals; work in a well ventilated area, and work with approved safety equipment, such as those dust masks that are specially designed to filter out microscopic particles. (*California Health & Safety Code 25249.5, et seq.*)



6. **WARNING!** People with pacemakers should consult their physician(s) before using this product. Electromagnetic fields in close proximity to a heart pacemaker could cause interference to or failure of the pacemaker.

**WARNING:** Always wear ANSI-approved impact safety goggles. Wear a full face shield if you are producing metal filings or wood chips. Wear an ANSI-approved dust mask or respirator when working around metal, wood, and chemical dusts and mists. Always wear ear protection. Ear protection is required for any other persons in the work area.

**WARNING:** Be aware of flying concrete chips. Keep spectators clear of the work area.

**WARNING:** Do not operate this tool if you have back, neck, wrist, or other conditions or injuries that will be aggravated by the jerking forces this tool exerts upon its operator.

**WARNING:** Always use the side handle when operating this tool.

**NOTE:** Use the weight of the Breaker Hammer to break concrete. Use the tool in the vertical position whenever possible. This tool was intended to break larger pieces of concrete.

**WARNING:** If the Breaker Hammer ever gets out of your control, immediately release the Switch (62).

---

## VIBRATION HAZARD

---

This tool vibrates during use. Repeated or long-term exposure to vibration may cause temporary or permanent physical injury, particularly to the hands, arms and shoulders. To reduce the risk of vibration-related injury:

1. Anyone using vibrating tools regularly or for an extended period should first be examined by a doctor and then have regular medical check-ups to ensure medical problems are not being caused or worsened from use. Pregnant women or people who have impaired blood circulation to the hand, past hand injuries, nervous system disorders, diabetes, or Raynaud's Disease should not use this tool. If you feel any medical or physical symptoms related to vibration (such as tingling, numbness, and white or blue fingers), seek medical advice as soon as possible.
2. Do not smoke during use. Nicotine reduces the blood supply to the hands and fingers, increasing the risk of vibration-related injury.
3. Wear suitable gloves to reduce the vibration effects on the user.
4. Use tools with the lowest vibration when there is a choice between different processes.
5. Include vibration-free periods each day of work.
6. To reduce vibration, maintain the tool as explained in this manual. If any abnormal vibration occurs, stop use immediately.

REV 07j

## UNPACKING

When unpacking, check to make sure all parts shown on the **Parts Lists and Assembly Diagrams** on pages 12-14 are included. If any parts are missing or broken, please call Harbor Freight Tools at the number shown on the cover of this manual as soon as possible.

## ASSEMBLY INSTRUCTIONS

### How to attach and adjust the Side Handle:

1. Slide the Clamp (122) over the Collet (8). Secure it using the Knob (120). (**See Figure 1 below.**)
2. To adjust the angle of the Side Handle, loosen the Knob (120). Adjust the angle of the Side Handle, then tighten the Knob (120) to secure it.

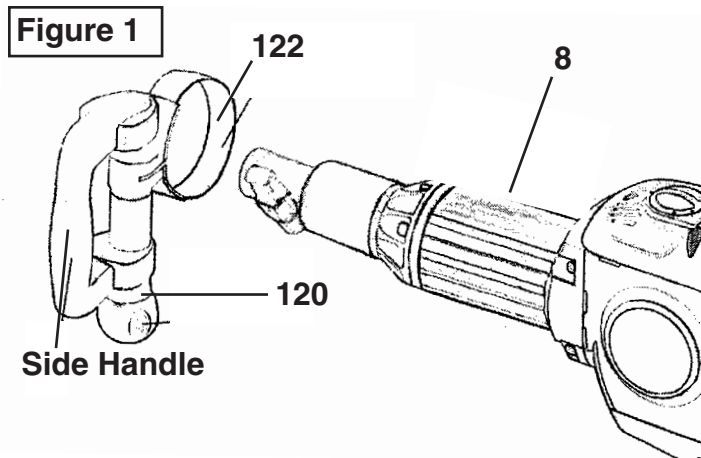

### **How to attach the chisels**

1. Slide the chisels into the Breaker Hammer with the flat cut-out side facing up and while the Rod (4) is aligned with the Chisel shank. See figure 2.
2. The Chisel has a flat space on the shaft that must be turned horizontally when it is inserted. See Figure 2. Pull out on the Pin and rotate it 90° to lock the Chisel in place. The Chisel should be able to move back and forth after it is locked but should not come out.

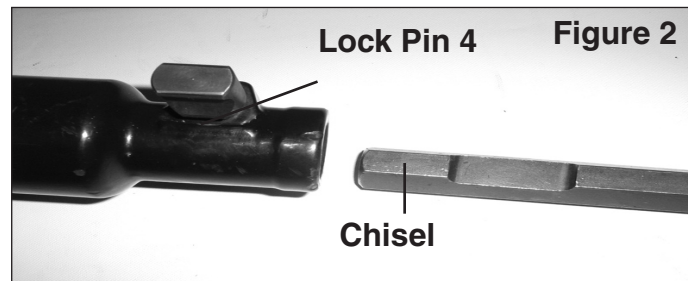

## **OPERATING INSTRUCTIONS**

### **IMPORTANT - READ BEFORE USE**

This Breaker Hammer may have decreased performance for a brief period at the beginning of each use. This warm-up period lasts approximately 3-5 minutes. This happens because the grease inside the tool may be thick, preventing the tool from operating at full efficiency while the motor is cold. This is normal and does not indicate a problem. To help reduce this effect, store this equipment in temperatures no lower than 50-60° F.

### **How to turn on the Breaker Hammer**

To turn on the Breaker Hammer, flip the Switch (62) shown below in Figure 3.

### **How to Adjust the impact level of the Breaker Hammer**

The Impact level is adjusted by turning the Knob (117). The numbers on the Knob indicate the level of impact. Number one is the lowest level, seven is the highest level. See Figure 4.

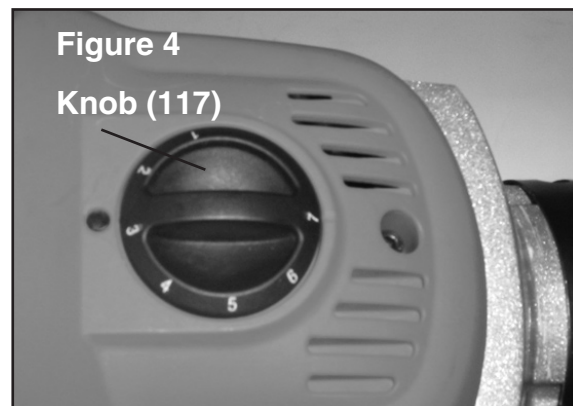
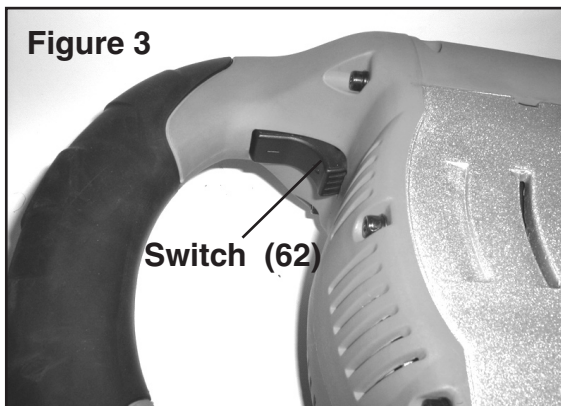

## OPERATING INSTRUCTIONS (CONTINUED)

### ***Chipping in a straight line with a chisel bit***

1. Use chalk or another suitable writing material and mark your work surface to delineate the area you intend to hammer.
2. Plug in the Breaker Hammer.
3. Grasp the main Handle (90) and side Handle (90) firmly with both hands. When you are sure that no people or animals are in the vicinity, and it's safe to begin, depress the Switch (62).
4. The Breaker Hammer will begin to break the top layer of concrete. If you push down, it will begin to break the next layer as well.
5. Keep moving the Breaker Hammer along the line you want to section, breaking concrete as you go. If the Breaker Hammer jumps off of the line or section, release the Switch (62) and reposition the Breaker Hammer.
6. When you are finished, release the Switch (62) and unplug the Breaker Hammer.

### ***Breaking up concrete with a bull point pit***

1. Place the bit on the center of a piece of concrete.
2. Grasp the main Handle (90) and side Handle (90) firmly with both hands. When you are sure that no people or animals are in the vicinity, and it's safe to begin, depress the Switch Knob (87).
3. As you break concrete into big chunks, release the Switch Knob (87) and move to other large pieces until all larger pieces are broken. Do not break up smaller pieces with this tool as it is too powerful and aggressive to control on small pieces.
4. When finished, release the Switch Knob (87) and unplug the Breaker Hammer.

## INSPECTION, MAINTENANCE, AND CLEANING

1.  **WARNING! Always disconnect the Breaker Hammer from its electrical power supply source before performing any inspection, maintenance, or cleaning procedure.**
2. Before each use, inspect the general condition of the Breaker Hammer. Inspect the switch, power plug and cord assembly, and extension cord (if used) for damage. Check for loose screws, misalignment, binding of moving parts and any other condition that may affect its safe operation. If abnormal noise or vibration occurs, turn off the Breaker Hammer immediately and have the problem corrected before further use.

**Do not use damaged equipment.**

## PARTS LIST

NO.	PART NAME	QTY	NO.	PART NAME	QTY
1	Bushing	1	42	Feather Key	2
2	Pin	1	43	Gear	1
3	Ring	1	44	Circlip	1
4	Pin	1	45	Bearing 6002NSK	2
5	Screw M6X40	6	46	Spacer	1
6	Washer	6	47	Spacer	1
7	Spring Washer	6	48	Circlip	1
8	Collet	1	49	Seal	1
9	O Ring	1	50	Bearing 620NSK	1
10	O Ring	1	51	Circlip	1
11	O Ring	1	52	Spring Washer	6
12	Spindle Cover	1	53	Washer	6
13	Seal	1	54	Screw M5X25	6
14	O Ring	1	55	Cord Jacket	1
15	Rear Bushing	1	56	Cord	1
16	Beat Piece	1	57	Capacitor	1
17	Bushing	1	58	Seal	1
18	Damper	1	59	Cover	1
19	Bushing	1	60	Screw ST4X18	2
20	O Ring	1	61	Cord Clip	1
21	Seal	1	62	Switch	1
22	O Ring	1	63	Actuator	1
23	O Ring	1	64	Rod	1
24	Cylinder Sleeve	1	65	Trigger	1
25	Ram	1	66	Pin	1
26	O Ring	1	67	Brush Housing	2
27	Front Housing	1	68	Carbon Brush	2
28	Spring Guide	1	69	Screw ST3X10	2
29	Spring	2	70	Brush Spring	2
30	Spring Guide	2	71	Screw	1
31	Copper Guard	1	72	Spring Washer	1
32	Spring guide	1	73	Washer	1
33	Screw M8X40	4	74	Fan Wheel	1
34	Washer	4	75	Cover	1
35	Spring Washer	4	76	Screw ST3X10	1
36	Screw M4X14	4	77	Screw M5X25	4
37	Side Cover	2	78	Washer	4
38	Bearing 620NSK	1	79	Spring Washer	4
39	Gear	1	80	Brush Plate	1
40	Washer	1	81	Sleeve Insulator	1
41	Gear	1			

REV 08b

**PARTS LIST CONTINUED**

<b>NO.</b>	<b>PART NAME</b>	<b>QTY</b>	<b>NO.</b>	<b>PART NAME</b>	<b>QTY</b>
82	Bearing 600NSK	1	105	Connecting Rod	1
83	Washer	1	106	Piston Pin	1
84	Magnetism Ring	1	107	Pin	1
85	Rotor	1	108	O Ring	1
86	Screw ST5X70	2	109	Eletronic Board	1
87	Stator	1	110	Screw ST4X14	2
88	Housing	1	111	Connecting Plate	1
89	Glass Fiberpipe	1	112	Cover	1
90	Handle	1	113	Spring Washer	5
91	Screw M5X18	6	114	Washer	5
92	Washer	6	115	Screw M5X25	5
93	Spring Washer	6	116	Detent	1
94	Screw M4X12	1	117	Knob	1
95	Cord Clip	1	118	Cover	1
96	Gear Case	1	119	Nut	1
97	O Ring	1	120	Knob Seal	1
98	Bearing 6304NSK	1	121	Handle	1
99	Crank Shaft	1	122	Clamp	1
100	Cover	1	123	Washer Clamp	2
101	Spring Washer	3	124	Bolt M8X180	1
102	Washer	3	125	Pointed Chisel	1
103	Screw M5X22	3	126	Case	1
104	Needle bearing	1	127	Square Chisel (not shown)	1

**PLEASE READ THE FOLLOWING CAREFULLY**

THE MANUFACTURER AND/OR DISTRIBUTOR HAS PROVIDED THE PARTS DIAGRAM IN THIS MANUAL AS A REFERENCE TOOL ONLY. NEITHER THE MANUFACTURER NOR DISTRIBUTOR MAKES ANY REPRESENTATION OR WARRANTY OF ANY KIND TO THE BUYER THAT HE OR SHE IS QUALIFIED TO MAKE ANY REPAIRS TO THE PRODUCT OR THAT HE OR SHE IS QUALIFIED TO REPLACE ANY PARTS OF THE PRODUCT. IN FACT, THE MANUFACTURER AND/OR DISTRIBUTOR EXPRESSLY STATES THAT ALL REPAIRS AND PARTS REPLACEMENTS SHOULD BE UNDERTAKEN BY CERTIFIED AND LICENSED TECHNICIANS AND NOT BY THE BUYER. THE BUYER ASSUMES ALL RISK AND LIABILITY ARISING OUT OF HIS OR HER REPAIRS TO THE ORIGINAL PRODUCT OR REPLACEMENT PARTS THERETO, OR ARISING OUT OF HIS OR HER INSTALLATION OF REPLACEMENT PARTS THERETO.

# ASSEMBLY DIAGRAM

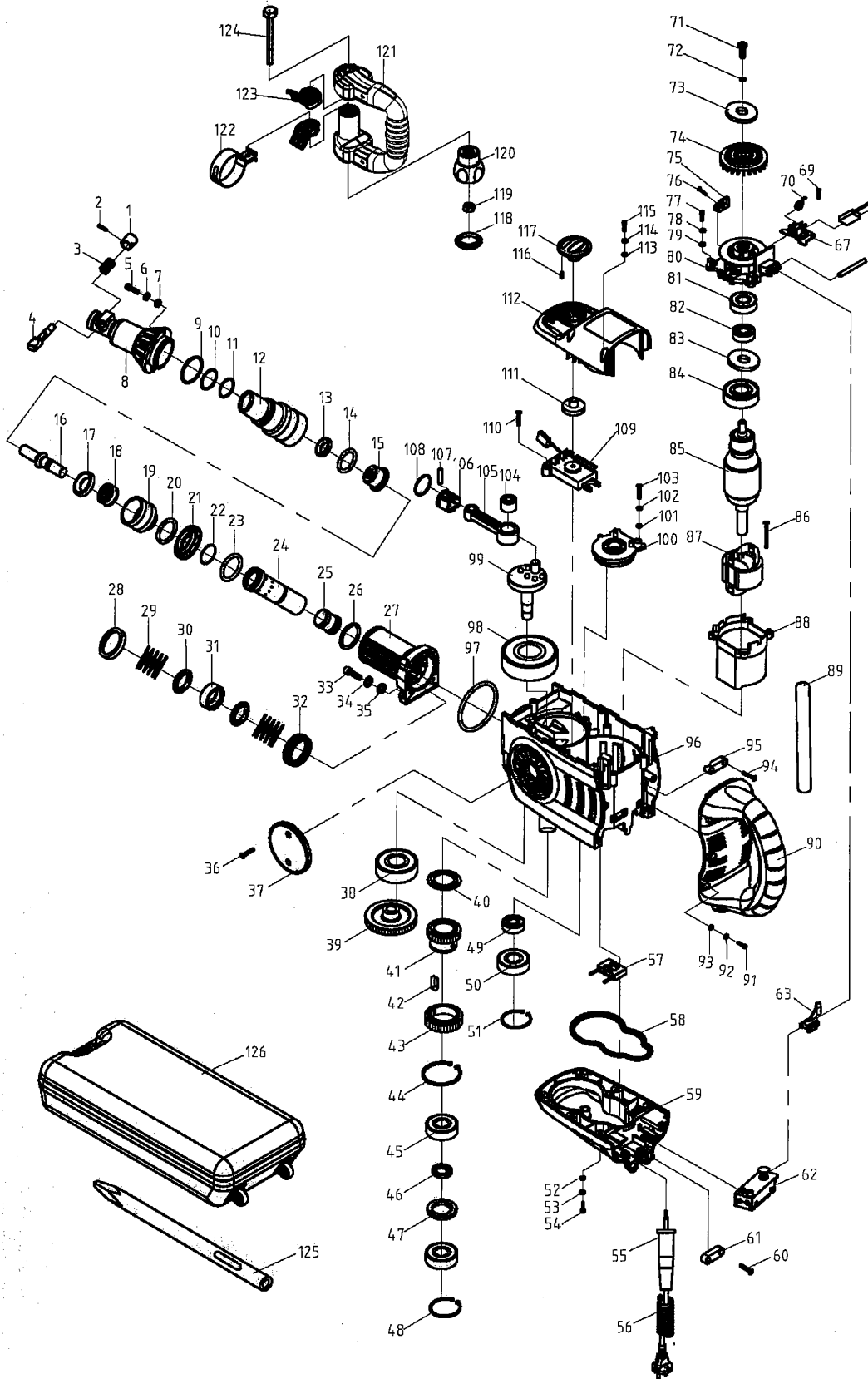



---

## LIMITED 90 DAY WARRANTY

---

Harbor Freight Tools Co. makes every effort to assure that its products meet high quality and durability standards, and warrants to the original purchaser that this product is free from defects in materials and workmanship for the period of 90 days from the date of purchase. This warranty does not apply to damage due directly or indirectly, to misuse, abuse, negligence or accidents, repairs or alterations outside our facilities, criminal activity, improper installation, normal wear and tear, or to lack of maintenance. We shall in no event be liable for death, injuries to persons or property, or for incidental, contingent, special or consequential damages arising from the use of our product. Some states do not allow the exclusion or limitation of incidental or consequential damages, so the above limitation of exclusion may not apply to you. THIS WARRANTY IS EXPRESSLY IN LIEU OF ALL OTHER WARRANTIES, EXPRESS OR IMPLIED, INCLUDING THE WARRANTIES OF MERCHANTABILITY AND FITNESS.

To take advantage of this warranty, the product or part must be returned to us with transportation charges prepaid. Proof of purchase date and an explanation of the complaint must accompany the merchandise. If our inspection verifies the defect, we will either repair or replace the product at our election or we may elect to refund the purchase price if we cannot readily and quickly provide you with a replacement. We will return repaired products at our expense, but if we determine there is no defect, or that the defect resulted from causes not within the scope of our warranty, then you must bear the cost of returning the product.

This warranty gives you specific legal rights and you may also have other rights which vary from state to state.

*3491 Mission Oaks Blvd. • PO Box 6009 • Camarillo, CA 93011 • (800) 444-3353*



## Free Manuals Download Website

<http://myh66.com>

<http://usermanuals.us>

<http://www.somanuals.com>

<http://www.4manuals.cc>

<http://www.manual-lib.com>

<http://www.404manual.com>

<http://www.luxmanual.com>

<http://aubethermostatmanual.com>

Golf course search by state

<http://golfingnear.com>

Email search by domain

<http://emailbydomain.com>

Auto manuals search

<http://auto.somanuals.com>

TV manuals search

<http://tv.somanuals.com>