

CHICAGO

Electric® Power Tools

3/8" CLOSE QUARTER DRILL

Model 92956

OPERATING INSTRUCTIONS



3491 Mission Oaks Blvd., Camarillo, CA 93011

Visit our Web site at: <http://www.harborfreight.com>

**TO PREVENT SERIOUS INJURY,
READ AND UNDERSTAND ALL WARNINGS
AND INSTRUCTIONS BEFORE USE.**

Copyright® 2005 by Harbor Freight Tools®. All rights reserved. No portion of this manual or any artwork contained herein may be reproduced in any shape or form without the express written consent of Harbor Freight Tools.

For technical questions or replacement parts, please call 1-800-444-3353.

PRODUCT SPECIFICATIONS

Item	Description
Electrical Requirements	120VAC / 60 Hz. 2 Prong, Polarized Power Cord Plug. 6'3" Long Power Cord. 0-1,500 RPM.
Chuck Capacity	1/16" – 3/8".
Chuck Type	3-Jaw, Keyed Chuck.
Drill Head Angle	90° Fixed Head.
Maximum Drilling Capacities	1/4" (Ferrous Material) 5/16" (Non-Ferrous Material) 1/2" (Wooden Material)
Trigger Type	Single Pole, Single Throw Switch.
Trigger Lock Type	Continuous Run Lock.
Rotation Directions	Clockwise & Counterclockwise.
Accessories	Chuck Key.
Overall Dimensions	2-13/16" W x 10-7/8" L x 5-1/4" H.
Unit Weight	3.80 Pounds.



SAVE THIS MANUAL

You will need this manual for the safety warnings and precautions, assembly, operating, inspection, maintenance and cleaning procedures, parts list and assembly diagram. Keep your invoice with this manual. Write the invoice number on the inside of the front cover. Keep this manual and invoice in a safe and dry place for future reference.

GENERAL SAFETY RULES



READ AND UNDERSTAND ALL INSTRUCTIONS
Failure to follow all instructions listed in the following pages may result in electric shock, fire, and/or serious injury.

SAVE THESE INSTRUCTIONS

WORK AREA

1. **Keep your work area clean and well lit.** Cluttered benches and dark areas invite accidents.

2. **Do not operate power tools in explosive atmospheres, such as in the presence of flammable liquids, gases, or dust.** Power tools create sparks which may ignite flammables.
3. **Keep bystanders, children, and visitors away while operating a power tool.** Distractions can cause you to lose control. Protect others in the work area from debris such as chips and sparks. Provide barriers or shields as needed.

ELECTRICAL SAFETY

4. **Grounded tools must be plugged into an outlet properly installed and grounded in accordance with all codes and ordinances. Never remove the grounding prong or modify the plug in any way. Do not use any adapter plugs. Check with a qualified electrician if you are in doubt as to whether the outlet is properly grounded.** If the tools should electrically malfunction or break down, grounding provides a low resistance path to carry electricity away from the user.
5. **Double insulated tools are equipped with a polarized plug (one blade is wider than the other). This plug will fit in a polarized outlet only one way. If the plug does not fit fully in the outlet, reverse the plug. If it still does not fit, contact a qualified electrician to install a polarized outlet. Do not change the plug in any way.** Double insulation eliminates the need for the three wire grounded power cord and grounded power supply system.
6. **Avoid body contact with grounded surfaces such as pipes, radiators, ranges, and refrigerators.** There is an increased risk of electric shock if your body is grounded.
7. **Do not expose power tools to rain or wet conditions.** Water entering a power tool will increase the risk of electric shock.
8. **Do not abuse the Power Cord. Never use the Power Cord to carry the tools or pull the Plug from an outlet. Keep the Power Cord away from heat, oil, sharp edges, or moving parts. Replace damaged Power Cords immediately.** Damaged Power Cords increase the risk of electric shock.
9. **When operating a power tool outside, use an outdoor extension cord marked “W-A” or “W”.** These extension cords are rated for outdoor use, and reduce the risk of electric shock.

PERSONAL SAFETY

10. **Stay alert. Watch what you are doing, and use common sense when operating a power tool. Do not use a power tool while tired or under the influence of drugs, alcohol, or medication.** A moment of inattention while operating power tools may result in serious personal injury.
11. **Dress properly. Do not wear loose clothing or jewelry. Contain long hair. Keep your hair, clothing, and gloves away from moving parts.** Loose clothes, jewelry, or long hair can be caught in moving parts.
12. **Avoid accidental starting. Be sure the Power Switch is off before plugging in.** Carrying power tools with your finger on the Power Switch, or plugging in power tools with the Power Switch on, invites accidents.
13. **Remove adjusting keys or wrenches before turning the power tool on.** A wrench or a key that is left attached to a rotating part of the power tool may result in personal injury.
14. **Do not overreach. Keep proper footing and balance at all times.** Proper footing and balance enables better control of the power tool in unexpected situations.
15. **Use safety equipment. Always wear eye protection.** Dust mask, non-skid safety shoes, hard hat, or hearing protection must be used for appropriate conditions.

TOOL USE AND CARE

16. **Use clamps (not included) or other practical ways to secure and support the workpiece to a stable platform.** Holding the work by hand or against your body is unstable and may lead to loss of control.
17. **Do not force the tool. Use the correct tool for your application.** The correct tool will do the job better and safer at the rate for which it is designed.
18. **Do not use the power tool if the Power Switch does not turn it on or off.** Any tool that cannot be controlled with the Power Switch is dangerous and must be replaced.
19. **Disconnect the Power Cord Plug from the power source before making any adjustments, changing accessories, or storing the tool.** Such preventive safety measures reduce the risk of starting the tool accidentally.
20. **Store idle tools out of reach of children and other untrained persons.** Tools are dangerous in the hands of untrained users.

21. **Maintain tools with care. Keep cutting tools sharp and clean.** Properly maintained tools with a sharp cutting edge are less likely to bind and are easier to control. Do not use a damaged tool. Tag damaged tools “Do not use” until repaired.
22. **Check for misalignment or binding of moving parts, breakage of parts, and any other condition that may affect the tool’s operation. If damaged, have the tool serviced before using.** Many accidents are caused by poorly maintained tools.
23. **Use only accessories that are recommended by the manufacturer for your model.** Accessories that may be suitable for one tool may become hazardous when used on another tool.

SERVICE

24. **Tool service must be performed only by qualified repair personnel.** Service or maintenance performed by unqualified personnel could result in a risk of injury.
25. **When servicing a tool, use only identical replacement parts. Follow instructions in the “*Inspection, Maintenance, And Cleaning*” section of this manual.** Use of unauthorized parts or failure to follow maintenance instructions may create a risk of electric shock or injury.

SPECIFIC SAFETY RULES

1. **Hold tool by insulated gripping surfaces when performing an operation where the cutting tools may contact hidden wiring or its own cord. Contact with a ‘live’ wire will make exposed metal parts of the tool ‘live’ and shock the operator.**
2. **Always wear ANSI approved safety impact eye goggles and full face shield when operating this product.**
3. **Maintain labels and nameplates on the Drill.** These carry important information. If unreadable or missing, contact Harbor Freight Tools for a replacement.
4. **Do not reach under or behind the material being drilled.**
5. **Make sure the workpiece is free from nails and any other foreign objects which can damage a drill bit.**
6. **Maintain a firm grip with both hands on the Drill, and position your body and arm to allow you to resist torque forces.**
7. **Do not use a dull or damaged drill bits.** Unsharpened or damaged drill bits cause excessive friction and binding.
8. **Use caution when drilling into existing walls or other blind areas.** Check for unexposed electrical wires and cables in the drilling path before drilling.

9. **Industrial applications must follow OSHA requirements.**
10. **Use the right tool or attachment for the right job.** Do not attempt to force a small tool or attachment to do the work of a larger industrial tool or attachment. There are certain applications for which this product was designed. It will do the job better and more safely at the rate for which it was intended. Do not modify this product, and do not use this product for a purpose for which it was not intended.
11. **Always turn off the Drill and unplug the Power Cord/Plug (31) from its electrical outlet before changing accessories or performing inspection, maintenance, or cleaning procedures.**

12.  **WARNING!** People with pacemakers should consult their physician(s) before using this product. Operation of electrical equipment in close proximity to a heart pacemaker could cause interference or failure of the pacemaker.

13.  **WARNING!** Some dust created by power sanding, sawing, grinding, drilling, and other construction activities, contain chemicals known (to the State of California) to cause cancer, birth defects or other reproductive harm. Some examples of these chemicals are: lead from lead-based paints, crystalline silica from bricks and cement or other masonry products, arsenic and chromium from chemically treated lumber. Your risk from these exposures varies, depending on how often you do this type of work. To reduce your exposure to these chemicals: work in a well ventilated area, and work with approved safety equipment, such as those dust masks that are specially designed to filter out microscopic particles. (*California Health & Safety Code 25249.5, et seq.*)

14.  **WARNING!** The warnings, precautions, and instructions discussed in this manual cannot cover all possible conditions and situations that may occur. The operator must understand that common sense and caution are factors which cannot be built into this product, but must be supplied by the operator.

SAVE THESE INSTRUCTIONS

GROUNDING

WARNING!

Improperly connecting the grounding wire can result in the risk of electric shock. Check with a qualified electrician if you are in doubt as to whether the outlet is properly grounded. Do not modify the power cord plug provided with the tool. Never remove the grounding prong from the plug. Do not use the tool if the power cord or plug is damaged. If damaged, have it repaired by a service facility before use. If the plug will not fit the outlet, have a proper outlet installed by a qualified electrician.

GROUNDING TOOLS: TOOLS WITH THREE PRONG PLUGS

1. Tools and equipment marked with “Grounding Required” have a three wire cord and three prong grounding plug. The plug must be connected to a properly grounded outlet. If the tool or equipment should electrically malfunction or break down, grounding provides a low resistance path to carry electricity away from the user, reducing the risk of electric shock. **(See Figure A.)**
2. The grounding prong in the plug is connected through the green wire inside the cord to the grounding system in the tool. The green wire in the cord must be the only wire connected to the tool’s grounding system and must never be attached to an electrically “live” terminal. **(See Figure A.)**
3. Your tool must be plugged into an appropriate outlet, properly installed and grounded in accordance with all codes and ordinances. The plug and outlet should look like that in the following illustration. **(See Figure A.)**

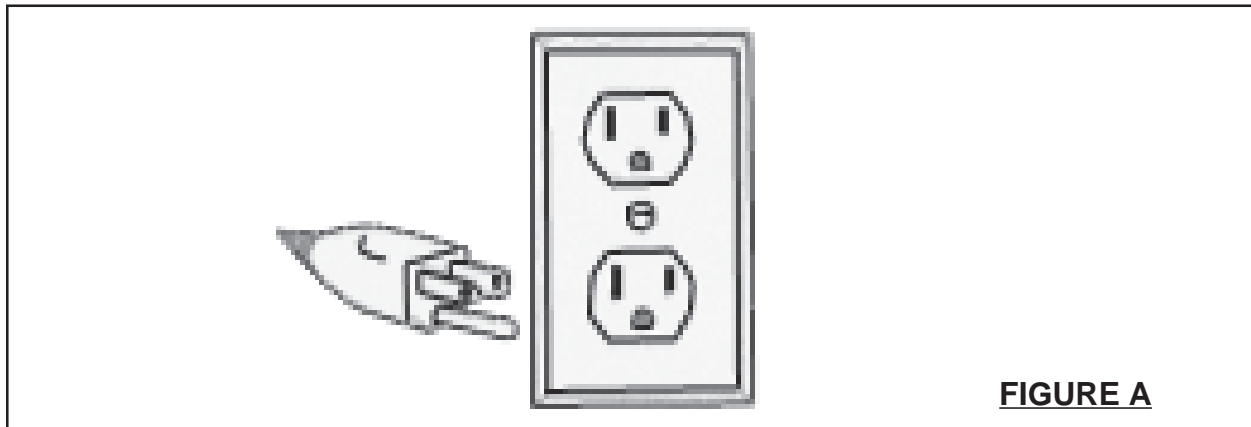
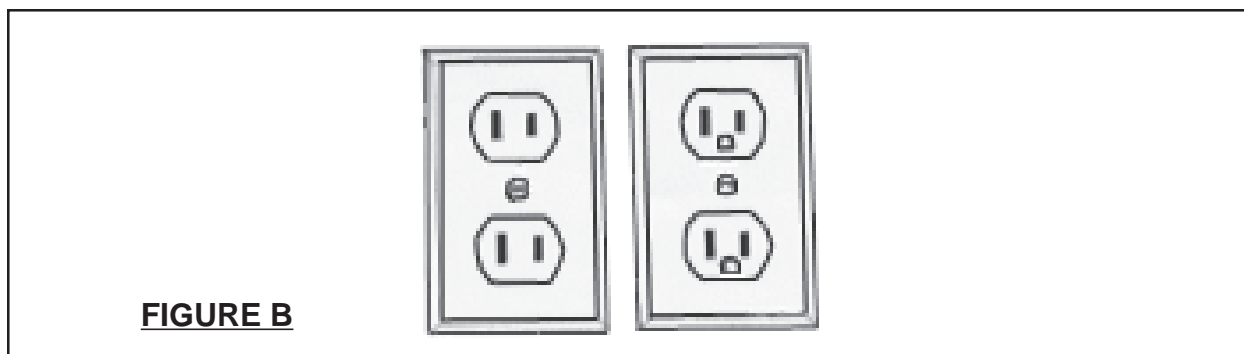

FIGURE A

DOUBLE INSULATED TOOLS: TOOLS WITH TWO PRONG PLUGS

1. Tools marked “Double Insulated” do not require grounding. They have a special double insulation system which satisfies OSHA requirements and complies with the applicable standards of Underwriters Laboratories, Inc., the Canadian Standard Association, and the National Electrical Code. **(See Figure B.)**
2. Double insulated tools may be used in either of the 120 volt outlets shown in the following illustration. **(See Figure B.)**



EXTENSION CORDS

1. **Grounded** tools require a three wire extension cord. **Double Insulated** tools can use either a two or three wire extension cord.
2. As the distance from the supply outlet increases, you must use a heavier gauge extension cord. Using extension cords with inadequately sized wire causes a serious drop in voltage, resulting in loss of power and possible tool damage. **(See Figure C, next page.)**
3. The smaller the gauge number of the wire, the greater the capacity of the cord. For example, a 14 gauge cord can carry a higher current than a 16 gauge cord. **(See Figure C.)**
4. When using more than one extension cord to make up the total length, make sure each cord contains at least the minimum wire size required. **(See Figure C.)**
5. If you are using one extension cord for more than one tool, add the nameplate amperes and use the sum to determine the required minimum cord size. **(See Figure C.)**
6. If you are using an extension cord outdoors, make sure it is marked with the suffix "W-A" ("W" in Canada) to indicate it is acceptable for outdoor use.
7. Make sure your extension cord is properly wired and in good electrical condition. Always replace a damaged extension cord or have it repaired by a qualified electrician before using it.
8. Protect your extension cords from sharp objects, excessive heat, and damp or wet areas.

RECOMMENDED MINIMUM WIRE GAUGE FOR EXTENSION CORDS* (120 VOLT)					
NAMEPLATE AMPERES (At Full Load)	EXTENSION CORD LENGTH				
	25 FEET	50 FEET	75 FEET	100 FEET	150 FEET
0-2.0	18	18	18	18	16
2.1-3.4	18	18	18	16	14
3.5-5.0	18	18	16	14	12
5.1-7.0	18	16	14	12	12
7.1-12.0	18	14	12	10	-
12.1-16.0	14	12	10	-	-
16.1-20.0	12	10	-	-	-

*Based on limiting the line voltage drop to five volts at 150% of the rated amperes.

FIGURE C

SYMBOLOLOGY



	Double Insulated
	Underwriters Laboratories, Inc.
	Canadian Standards Association
V ~	Volts Alternating Current
A	Amperes
no xxxx/min.	No Load Revolutions Per Minute (RPM)

FIGURE D

UNPACKING

When unpacking, check to make sure all accessories listed above are included, and that the product is intact and undamaged

PRODUCT FEATURES

NOTE:

For additional information regarding the parts mentioned in the following pages, refer to the **Assembly Diagram on page 14.**

1. **Drill Chuck (3) and Chuck Key (33):** The Close Quarter Drill is equipped with a 3/8" keyed Drill Chuck (3) that will accept drill bits (not included) with a 1/16" to 3/8" shank. Installing a drill bit into the Drill Chuck requires the use of the accessory Chuck Key (33). Always make sure the drill bits are firmly secured in the Drill Chuck prior to using the Drill. **(See Figure D.)**
2. **Trigger (30) and Trigger Lock (34):** The Trigger (30) is operated manually simply by squeezing the Trigger to turn on the Drill and releasing pressure on the Trigger to turn off the Drill. The Trigger features a Trigger Lock (34) for continuous running of the Drill. To set the Drill in a continuous run mode, squeeze the Trigger and depress the Trigger Lock. Then, release pressure on the Trigger. The Drill will continue to run. To turn off the Drill, squeeze and let up on the Trigger. **(See Figure D.)**
3. **Forward/Reverse Switch (35):** The Forward/Reverse Switch (35) is located directly above the Trigger (30). For **clockwise** rotation, move the Forward/Reverse Switch to the *right*. For a **counterclockwise** rotation, move the Forward/Reverse Switch to the *left*. Use the Forward/Reverse Switch only after the Hammer Drill has come to a complete stop. **(See Figure D.)**

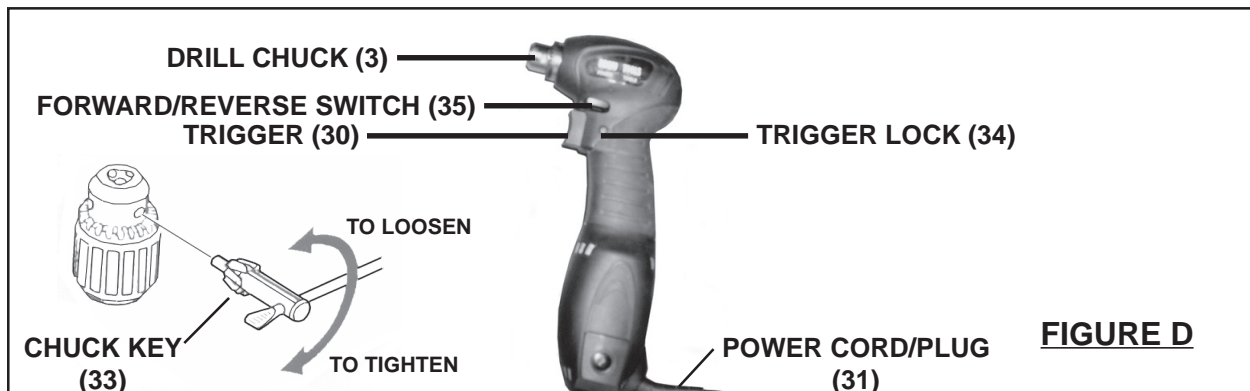



OPERATING INSTRUCTIONS

1. Use caution when drilling into existing walls or other blind areas. Check for unexposed electrical wires and cables in the drilling path before drilling.
2. Use the Forward/Reverse Switch (35) to select the desired rotation of the tool. **(See Figure D.)**
3. Insert a drill bit (not included) into the Drill Chuck (3), and secure the drill bit in the Drill Chuck with the Chuck Key (33). **(See Figure D.)**
4. Make sure the Trigger (30) is in its “**OFF**” position. Then, plug the Power Cord/ Plug (31) into the nearest 120 volt, grounded, electrical outlet. **(See Figure D.)**
5. Before drilling, clamp the object down securely. A poorly secured piece of material may result in personal injury and/or inaccurate drilling.
6. Mark the center of the hole to be drilled with a center punch to prevent the drill bit from “walking” when first beginning to drill.
7. **Hold the Drill firmly with both hands.**
8. Position the drill bit on the material that is to be drilled.
9. To begin drilling, squeeze the Trigger (30). The speed at which the Drill Chuck (3) rotates varies depending on how far in the Trigger is squeezed. **(See Figure D.)**
10. If desired, activate the Trigger Lock (34) to set the Drill in a continuous run mode. **(See Figure D.)**
11. Avoid overloading the Drill. Do not apply excessive pressure to the Drill while drilling. If the speed of the tool drops abnormally, decrease the pressure immediately. If the drill bit stops abruptly, or the drill bit becomes blocked, release the Trigger (30) at once. **(See Figure D.)**
12. Drill only as deep as is necessary. Do not drill deeper than necessary into walls or other areas where you cannot identify any possible hazards behind the drilling surface.
13. To reduce jamming as the drill bit breaks through the workpiece, decrease the drilling pressure when the point of the drill bit breaks through the workpiece.

14. When you have drilled the hole, remove the drill bit from the hole while the Drill Chuck (3) is still rotating. This prevents the drill bit from getting caught in the hole and causing damage.
15. Release pressure on the Trigger (30) to stop the Drill. **(See Figure D.)**
16. **Unplug the Drill from its electrical outlet.**
17. Remove the drill bit from the Drill Chuck (3). Then, store the Drill and its Chuck Key (33) in a dry, safe, location out of reach of children and other unauthorized users.

INSPECTION, MAINTENANCE, AND CLEANING

1.  **WARNING!** Always make sure the Trigger (30) is in its “OFF” position, and unplug the Power Cord/Plug (31) from its 120 volt electrical outlet before performing any inspection, adjustments, maintenance, or cleaning.
2. **Before each use**, inspect the general condition of the Drill. Check for loose screws, misalignment or binding of moving parts, cracked or broken parts, damaged electrical wiring, loose, cracked, or bent drill bits, and any other condition that may affect its safe operation. If abnormal noise or vibration occurs, have the problem corrected before further use.
Do not use damaged equipment.
3. **Daily:** With a soft brush, cloth, or vacuum, remove all dust and debris from the Drill. Then, use a premium quality, lightweight machine oil to lubricate all external moving parts.
4. **To replace the Carbon Brushes:** It may become necessary at sometime to replace the *two* Carbon Brushes (19) when the Motor performance decreases, or stops working completely. **The Carbon Brushes are located on each side of the Motor Housing (4) and Motor Housing Cover (17).** To do so, remove the two Brush Holder Covers (18). Then, remove the two Carbon Brushes from the Brush Holders (20). If the Carbon Brushes are worn down more than 1/2, replace *both* Carbon Brushes. If, however, the Carbon Brushes are just dirty they may be cleaned by rubbing them with a pencil eraser. When installing the Carbon Brushes, make sure the carbon portion of the Carbon Brushes contact the Motor Armature, and that the springs face away from the Motor. Also, make sure the springs operate freely. After cleaning or replacement, replace the Brush Holders. **NOTE:** New Carbon Brushes tend to arc or spark when first used *until* they wear and conform to the Motor’s Armature. **(See Figure E, next page.)**

5.  **CAUTION!** All maintenance, service, or repairs not listed in this manual are only to be attempted by a qualified service technician.

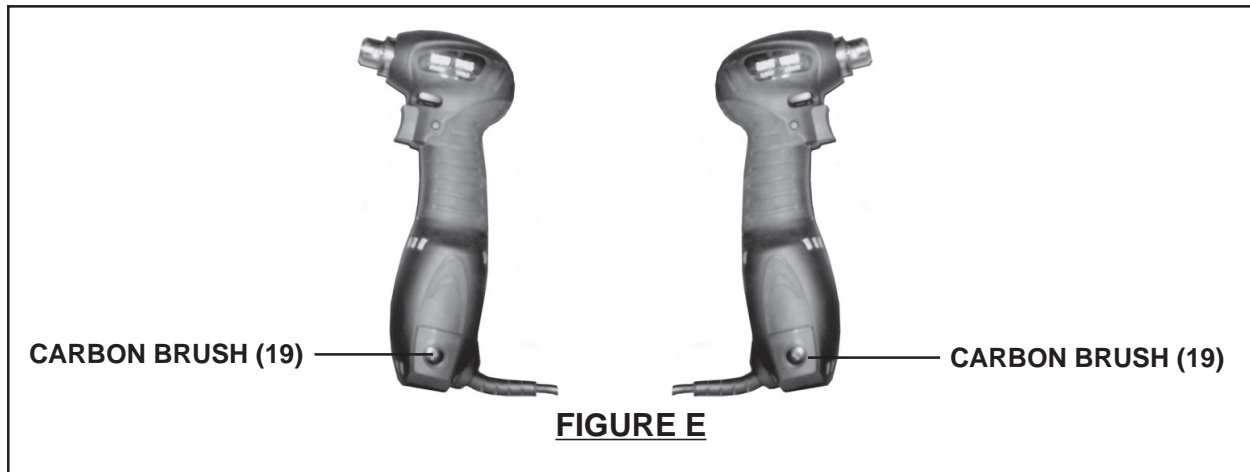

PLEASE READ THE FOLLOWING CAREFULLY

THE MANUFACTURER AND/OR DISTRIBUTOR HAS PROVIDED THE PARTS LIST AND ASSEMBLY DIAGRAM IN THIS MANUAL AS A REFERENCE TOOL ONLY. NEITHER THE MANUFACTURER OR DISTRIBUTOR MAKES ANY REPRESENTATION OR WARRANTY OF ANY KIND TO THE BUYER THAT HE OR SHE IS QUALIFIED TO MAKE ANY REPAIRS TO THE PRODUCT, OR THAT HE OR SHE IS QUALIFIED TO REPLACE ANY PARTS OF THE PRODUCT. IN FACT, THE MANUFACTURER AND/OR DISTRIBUTOR EXPRESSLY STATES THAT ALL REPAIRS AND PARTS REPLACEMENTS SHOULD BE UNDERTAKEN BY CERTIFIED AND LICENSED TECHNICIANS, AND NOT BY THE BUYER. THE BUYER ASSUMES ALL RISK AND LIABILITY ARISING OUT OF HIS OR HER REPAIRS TO THE ORIGINAL PRODUCT OR REPLACEMENT PARTS THERETO, OR ARISING OUT OF HIS OR HER INSTALLATION OF REPLACEMENT PARTS THERETO.

PARTS LIST

Part #	Description	Qty.	Part #	Description	Qty.
1	Screw (M5 x 20 Left)	1	19	Carbon Brush	2
2	Spring Washer (5)	1	20	Brush Holder	2
3	Drill Chuck	1	21	Gear Spindle (Z1)	1
4	Motor Housing	1	22	Ball Bearing (626)	1
5	Gear Housing	1	23	Link Bushing	1
6	Rubber Pin	1	24	Ball Bearing (608)	1
7	Ball Bearing (6002)	1	25	Armature	1
8	Pin	3	26	Ball Bearing (607)	1
9	Gear (Z4)	1	27	Field	1
10	Spindle	1	28	Screw (M4 x 20)	3
11	Gear (Z5)	1	29	Rubber Pin	1
12	Gear Spindle (Z3)	1	30	Trigger	1
13	Ball Bearing (626)	1	31	Power Cord/Plug	1
14	Gear (Z2)	1	32	Screw (ST4.2 x 14)	8
15	Ball Bearing (625)	1	33	Chuck Key (not shown)	1
16	Gear Housing Cover	1	34	Trigger Lock	1
17	Motor Housing Cover	1	35	Forward/Reverse Switch	1
18	Brush Holder Cover	2			

ASSEMBLY DIAGRAM

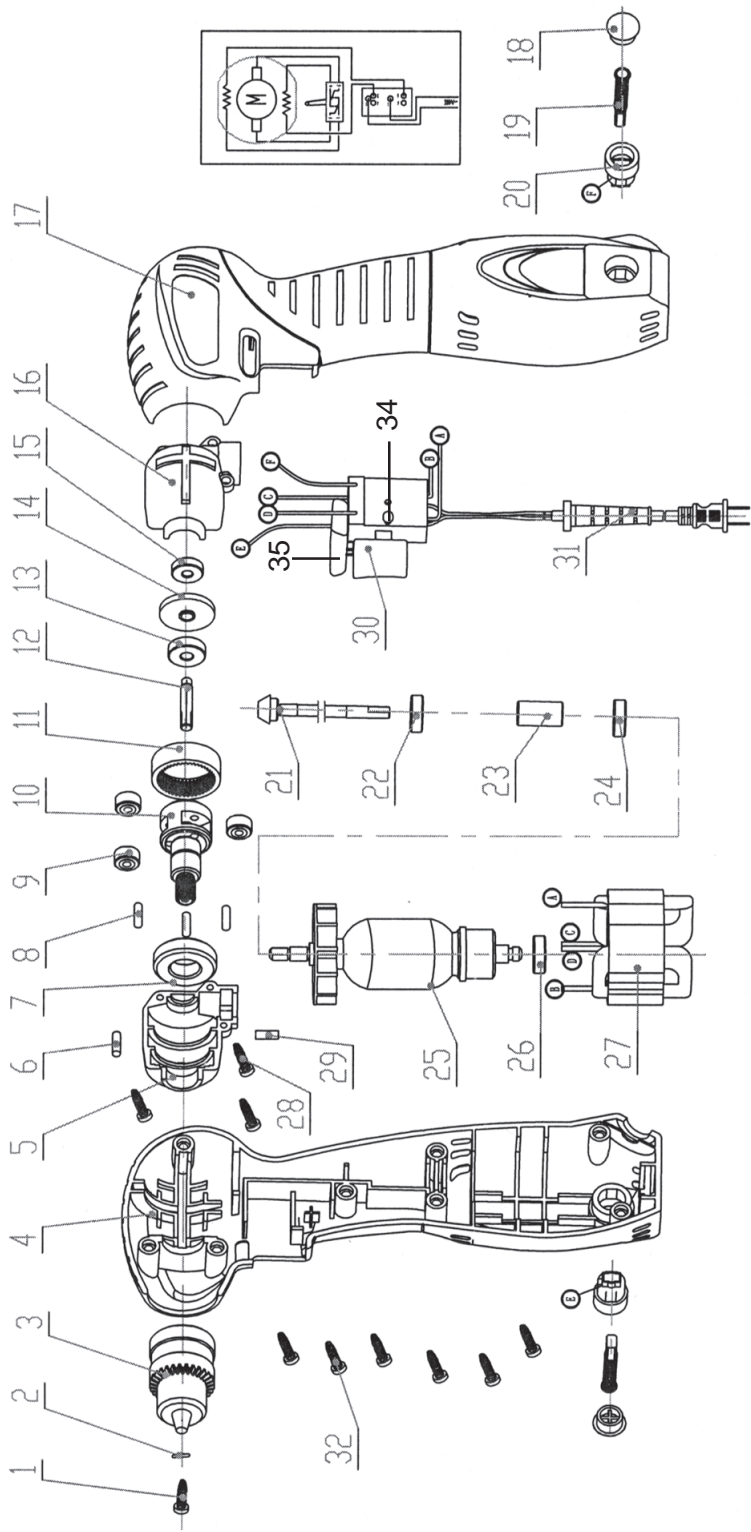

33: CHUCK KEY NOT SHOWN.

NOTE:
Some parts are listed and shown for assembly purposes only,
and are not available individually as replacement parts.

Free Manuals Download Website

<http://myh66.com>

<http://usermanuals.us>

<http://www.somanuals.com>

<http://www.4manuals.cc>

<http://www.manual-lib.com>

<http://www.404manual.com>

<http://www.luxmanual.com>

<http://aubethermostatmanual.com>

Golf course search by state

<http://golfingnear.com>

Email search by domain

<http://emailbydomain.com>

Auto manuals search

<http://auto.somanuals.com>

TV manuals search

<http://tv.somanuals.com>