

BenQ

MX880UST (Model Name: MX712 UST)

Digital Projector

User Manual

Welcome

Table of contents

Important safety instructions	3
Introduction	7
Projector features	7
Shipping contents	8
Projector exterior view	9
Controls and functions	10
Positioning your projector	14
Choosing a location	14
Obtaining a preferred projected image size	15
Connection	16
Connecting video source devices	17
Playing sound through the projector	18
Operation	20
Starting up the projector	20
Adjusting the projected image	21
Using the menus	23
Securing the projector	24
Switching input signal	26
Magnifying and searching for details	27
Selecting the aspect ratio	27
Optimizing the image	29
Setting the presentation timer	32
Remote paging operations	33
Freezing the image	33
Hiding the image	33
Utilizing FAQ function	33
Locking control keys	34
Operating in a high altitude environment	34
Creating your own startup screen	34

Adjusting the sound	35
Controlling the projector through a LAN environment	36
Presenting from a USB Reader	49
Shutting down the projector	50
Direct power off	50
Menu operation	51
Maintenance	60
Care of the projector	60
Lamp information	61
Troubleshooting	67
Specifications	68
Projector specifications	68
Dimensions	69
Timing chart	70
Warranty and Copyright information	72
Regulation statements	73

Important safety instructions

Your projector is designed and tested to meet the latest standards for safety of information technology equipment. However, to ensure safe use of this product, it is important that you follow the instructions mentioned in this manual and marked on the product.

Safety Instructions

1. **Please read this manual before you operate your projector.** Save it for future reference.



2. **Do not look straight at the projector lens during operation.** The intense light beam may damage your eyes.

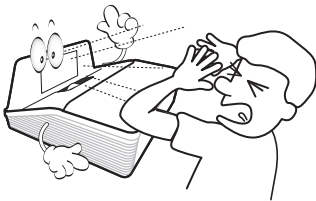

3. **Refer servicing to qualified service personnel.**

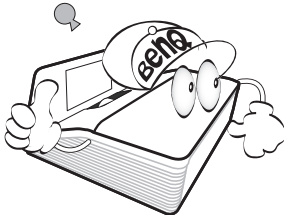

4. **Always open the lens shutter (if any) or remove the lens cap (if any) when the projector lamp is on.**

5. In some countries, the line voltage is NOT stable. This projector is designed to operate safely within a mains voltage between 100 to 240 volts AC, but could fail if power cuts or surges of ± 10 volts occur. **In areas where the mains voltage may fluctuate or cut out, it is recommended that you connect your projector through a power stabilizer, surge protector or uninterruptible power supply (UPS).**



6. Do not block the projection lens with any objects when the projector is under operation as this could cause the objects to become heated and deformed or even cause a fire. To temporarily turn off the lamp, press **BLANK** on the projector or remote control.

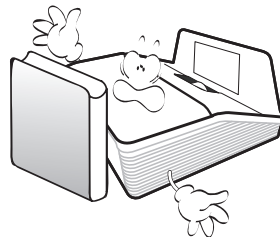

Safety Instructions (Continued)

7. The lamp becomes extremely hot during operation. Allow the projector to cool for approximately 45 minutes prior to removing the lamp assembly for replacement.

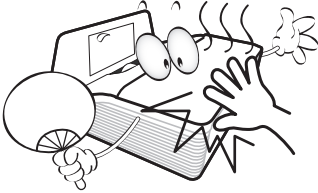

8. Do not operate lamps beyond the rated lamp life. Excessive operation of lamps beyond the rated life could cause them to break on rare occasions.



9. Never replace the lamp assembly or any electronic components unless the projector is unplugged.



10. Do not place this product on an unstable cart, stand, or table. The product may fall, sustaining serious damage.



11. Do not attempt to disassemble this projector. There are dangerous high voltages inside which may cause death if you should come into contact with live parts. The only user serviceable part is the lamp which has its own removable cover.

Under no circumstances should you ever undo or remove any other covers. Refer servicing only to suitably qualified professional service personnel.

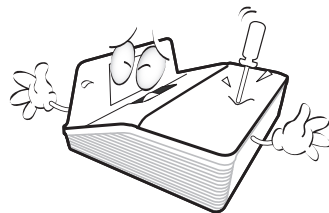

12. When the projector is under operation, you may sense some heated air and odor from its ventilation grill. It is a normal phenomenon and not a product defect.

Safety Instructions (Continued)

13. Do not place this projector in any of the following environments.

- Space that is poorly ventilated or confined. Allow at least 50 cm clearance from walls and free flow of air around the projector.
- Locations where temperatures may become excessively high, such as the inside of a car with all windows rolled up.
- Locations where excessive humidity, dust, or cigarette smoke may contaminate optical components, shorten the projector's life span and darken the image.



- Locations near fire alarms
- Locations with an ambient temperature above 40°C / 104°F
- Locations where the altitudes are higher than 3000 m (10000 feet).

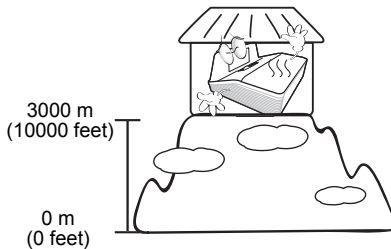

14. Do not block the ventilation holes.

- Do not place this projector on a blanket, bedding or any other soft surface.
- Do not cover this projector with a cloth or any other item.
- Do not place inflammables near the projector.

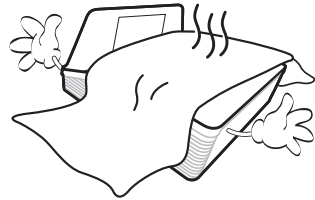

If the ventilation holes are seriously obstructed, overheating inside the projector may result in a fire.

15. Always place the projector on a level, horizontal surface during operation.

- Do not use if tilted at an angle of more than 10 degrees left to right, nor at angle of more than 15 degrees front to back. Using the projector when it is not fully horizontal may cause a malfunction of, or damage to, the lamp.



16. Do not stand the projector on end vertically. Doing so may cause the projector to fall over, causing injury or resulting in damage to the projector.

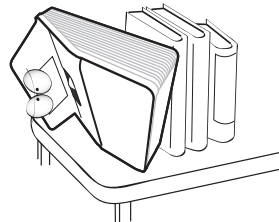

Safety Instructions (Continued)

17. Do not step on the projector or place any objects upon it. Besides probable physical damage to the projector, doing so may result in accidents and possible injury.

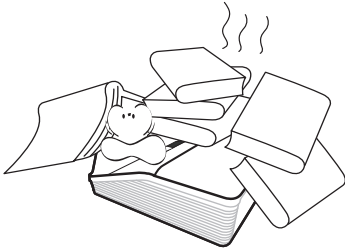

18. Do not place liquids near or on the projector. Liquids spilled into the projector may cause it to fail. If the projector does become wet, disconnect it from the power supply's power outlet and call BenQ to have the projector serviced.

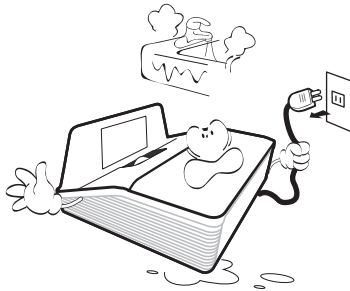

19. This product is capable of displaying inverted images for ceiling mount installation.



Use only BenQ's Ceiling Mount Kit for mounting the projector and ensure it is securely installed.

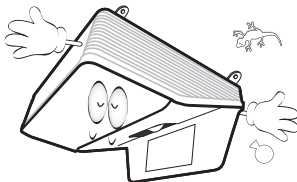

20. This apparatus must be earthed.



Ceiling mounting the projector

We want you to have a pleasant experience using your BenQ projector, so we need to bring this safety matter to your attention to prevent possible damage to person and property.

If you intend to mount your projector on the ceiling, we strongly recommend that you use a proper fitting BenQ projector ceiling mount kit and that you ensure it is securely and safely installed.

If you use a non-BenQ brand projector ceiling mount kit, there is a safety risk that the projector may fall from the ceiling due to an improper attachment through the use of the wrong gauge or length screws.

You can purchase a BenQ projector ceiling mount kit from the place you purchased your BenQ projector. BenQ recommends that you also purchase a separate Kensington lock compatible security cable and attach it securely to both the Kensington lock slot on the projector and the base of the ceiling mount bracket. This will perform the secondary role of restraining the projector should its attachment to the mounting bracket become loose.



Hg - Lamp contains mercury. Manage in accordance with local disposal laws. See www.lamprecycle.org.

Introduction

Projector features

The projector integrates high-performance optical engine projection and a user-friendly design to deliver high reliability and ease of use.

The projector offers the following features.

- Network Settings allowing management of projector status from a computer using a web browser
- Short throw lens to create larger images with less distance between the projector and the screen
- Microphone jack to output the sound through the projector speaker
- USB MINI-B jack to display computer signal through a USB cable
- USB TYPE-A jack to present images stored on a USB flash drive
- 3D function to enjoy the 3D movies, videos, and sporting events in a more realistic way by presenting the depth of the images
- Closed captioning to display the dialogue, narration, and sound effects of TV programs and videos
- Variable audio output
- Wall color correction allowing projection on surfaces of several predefined colors
- Quick auto search speeding up the signal detecting process
- Selectable password protected function
- 3D color management allowing color adjustments to your liking
- Selectable quick cooling function making the projector cool in a shorter time
- FAQ to troubleshoot operational problems with one quick key press
- Presentation timer for better control of time during presentations
- One-key auto-adjustment to display the best picture quality
- Digital keystone correction to correct distorted images
- Adjustable color balance control for data/video display
- Multi-language On-Screen Display (OSD) menus
- Switchable normal and economic modes to reduce the power consumption
- Built-in speakers providing mixed mono audio when an audio input is connected
- Component HDTV compatibility (YPbPr)



- **The apparent brightness of the projected image will vary depending on the ambient lighting conditions, selected input signal contrast/brightness settings, and is directly proportional to projection distance.**
- **The lamp brightness will decline over time and may vary within the lamp manufacturers specifications. This is normal and expected behavior.**

Shipping contents

Carefully unpack and verify that you have all of the items shown below. If any of these items are missing, please contact your place of purchase.

Standard accessories

 The supplied accessories will be suitable for your region, and may differ from those illustrated.

*The warranty card is only supplied in some specific regions. Please consult your dealer for detailed information.

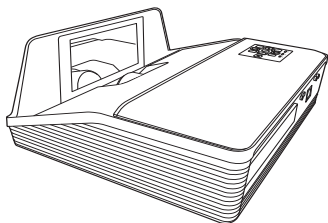

Projector

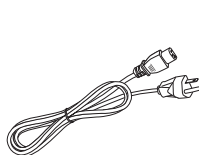

Power cord

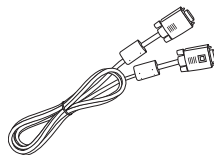

VGA cable



Quick start guide



User manual CD



Warranty card*

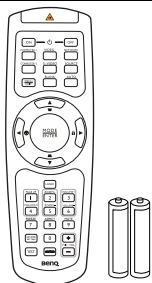

Remote control with batteries

Optional accessories

1. Spare lamp kit
2. Ceiling mount kit
3. RS232 cable
4. Wall mount kit

Projector exterior view

Front/upper side

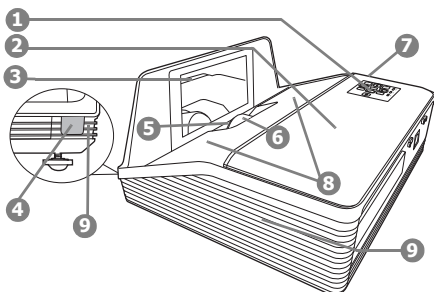

1. External control panel
(See "[Controls and functions](#)" on page 10 for details.)
2. Lamp cover
3. Mirror
4. IR remote sensor
5. Projection lens
6. Focus ring
7. Vent (cool air intake)
8. Speaker grill
9. Vent (heated air exhaust)

Rear/lower side

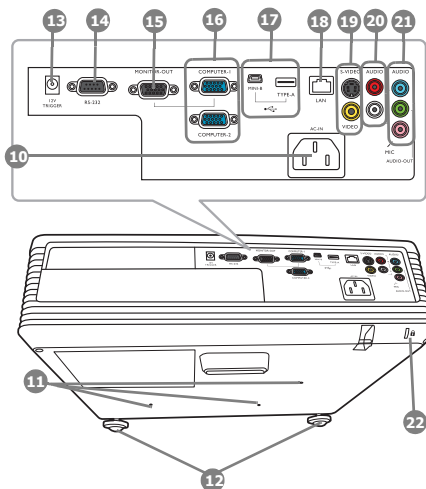

10. AC power jack
11. Ceiling mount holes
12. Adjuster feet
13. RS232 control port
14. RGB signal output jack
15. RGB (PC)/Component Video (YPbPr/YCbCr) signal input jack
16. USB ports
17. RJ45 LAN input jack
18. S-Video input jack
19. Video input jack
20. Audio (L/R) input jacks
21. Audio input jack
Audio output jack
Microphone jack
22. Kensington anti-theft lock slot

Controls and functions

Projector

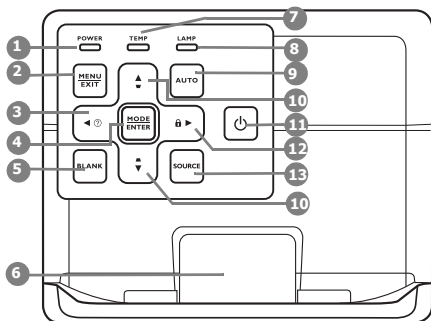

1. **POWER indicator light**

Lights up or flashes when the projector is under operation.

2. **MENU/EXIT**

Turns on the On-Screen Display (OSD) menu. Goes back to previous OSD menu, exits and saves menu settings.

3. **◀ Left/ (?)**

Starts the FAQ function.

4. **MODE/ENTER**

Selects an available picture setup mode.

Activates the selected On-Screen Display (OSD) menu item.

5. **BLANK**

Used to hide the screen picture.

6. **Focus ring**

Adjusts the focus of the projected image.

7. **TEMPerature warning light**

Lights up red if the projector's temperature becomes too high.

8. **LAMP indicator light**

Indicates the status of the lamp. Lights up or flashes when the lamp has developed a problem.

9. **AUTO**

Automatically determines the best picture timings for the displayed image.

10. **Keystone/Arrow keys (◻ / ▲ Up, ◻ / ▼ Down)**

Manually corrects distorted images resulting from an angled projection.

11. **⏻ POWER**

Toggles the projector between standby mode and on.

12. **▶ Right/ 🔒**

Activates panel key lock.

When the On-Screen Display (OSD) menu is activated, the #3, #10, and #12 keys are used as directional arrows to select the desired menu items and to make adjustments.

13. **SOURCE**

Displays the source selection bar.

Remote control

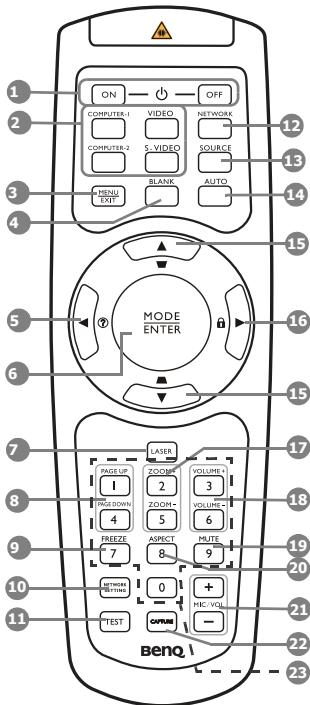

1. **ON/OFF**

Toggles the projector between standby mode and on.

2. **Source selection buttons (COMPUTER-1, COMPUTER-2, VIDEO, S-VIDEO)**

Selects an input source for display.

3. **MENU/EXIT**

Turns on the On-Screen Display (OSD) menu. Goes back to previous OSD menu, exits and saves menu settings.

4. **BLANK**

Used to hide the screen image.

5. **◀ Left/ ?**

Starts the FAQ function.

6. **MODE/ENTER**

Selects an available picture setup mode. Activates the selected On-Screen Display (OSD) menu item.

7. **LASER**

Emits visible laser pointer light for presentation purposes.

8. **PAGE UP/PAGE DOWN**

Operate your display software program (on a connected PC) which responds to page up/down commands (like Microsoft PowerPoint).

9. **FREEZE**

Freezes the projected image.

10. **NETWORK SETTING**

Enters network setting directly.

11. **TEST**

Displays the test pattern.

12. **NETWORK**

Searches the network signal and project it within a few seconds once available.

13. **SOURCE**

Displays the source selection bar.

14. **AUTO**

Automatically determines the best picture timings for the displayed image.

15. **Keystone/Arrow buttons (◻ /▲ Up, ◻ / ▼ Down)**

Manually corrects distorted images resulting from an angled projection.

16. **▶ Right/ 🔒**

Locks the buttons on the projector.

When the On-Screen Display (OSD) menu is activated, the #5, #15 and #16 buttons are used as directional arrows to select the desired menu items and to make adjustments.

17. **ZOOM+/ZOOM-**

Magnifies or reduces the projected image size.

18. **VOLUME+/VOLUME-**

Adjusts the sound level.

19. **MUTE**

Toggles projector audio between on and off.

20. **ASPECT**

Selects the display aspect ratio.

21. **MIC/VOL +/-**

Adjusts the microphone sound level.

22. **CAPTURE**

Captures the projected picture and save it as your startup screen.

23. **Numeric buttons**

Enters numbers in network settings.



Numeric buttons 1, 2, 3, 4 cannot be pressed when asked to enter password.

Operating the LASER pointer

The Laser Pointer is a presentation aid for professionals. It emits red colored light when you press it and the indicator lights up red.

The laser beam is visible. It is necessary to press and hold **LASER** for continuous output.

Avoid Exposure
Laser radiation is emitted from this aperture



Do not look into the laser light window or shine the laser light beam on yourself or others. See the warning messages on the back of the remote control prior to using it.

The laser pointer is not a toy. Parents should be mindful of the dangers of laser energy and keep this remote control out of the reach of children.

Remote control effective range

Infra-Red (IR) remote control sensor is located on the front of the projector. The remote control must be held at an angle within 30 degrees perpendicular to the projector's IR remote control sensors to function correctly. The distance between the remote control and the sensors should not exceed 8 meters (~ 26 feet).

Make sure that there are no obstacles between the remote control and the IR sensor on the projector that might obstruct the infra-red beam.

- **Operating the projector from the front**

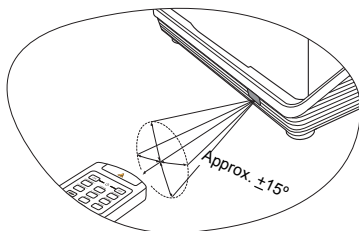

Replacing the remote control batteries

1. To open the battery cover, turn the remote control over to view its back, push on the finger grip on the cover and slide it up in the direction of the arrow as illustrated. The cover will slide off.
2. Remove any existing batteries (if necessary) and install two AAA batteries observing the battery polarities as indicated in the base of the battery compartment. Positive (+) goes to positive and negative (-) goes to negative.
3. Refit the cover by aligning it with the base and sliding it back down into position. Stop when it clicks into place.

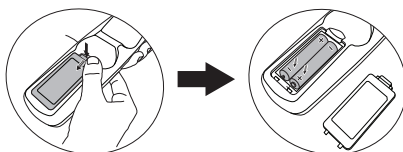

- ⚠ • **Avoid leaving the remote control and batteries in an excessive heat or humid environment like the kitchen, bathroom, sauna, sunroom or in a closed car.**
- **Replace only with the same or equivalent type recommended by the battery manufacturer.**
- **Dispose of the used batteries according to the manufacturer's instructions and local environment regulations for your region.**
- **Never throw the batteries into a fire. There may be danger of an explosion.**
- **If the batteries are dead or if you will not be using the remote control for an extended period of time, remove the batteries to avoid damage to the remote control from possible battery leakage.**

Positioning your projector

Choosing a location

Your projector is designed to be installed in one of four possible installation locations:

1. Front Table

Select this location with the projector placed on the table in front of the screen. This is the most common way to position the projector for quick setup and portability.

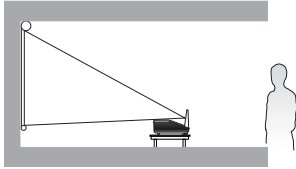

2. Front Ceiling

Select this location with the projector suspended upside-down from the ceiling in front of the screen.

Purchase the BenQ Projector Ceiling Mount Kit from your dealer to mount your projector on the ceiling.

Set **Front Ceiling** in the **SYSTEM SETUP: Basic > Projector Position** menu after you turn the projector on.

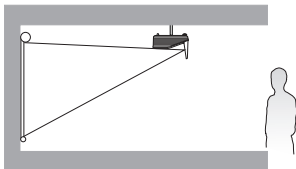

3. Rear Ceiling

Select this location with the projector suspended upside-down from the ceiling behind the screen.

Note that a special rear projection screen and the BenQ Projector Ceiling Mount Kit are required for this installation location.

Set **Rear Ceiling** in the **SYSTEM SETUP: Basic > Projector Position** menu after you turn the projector on.

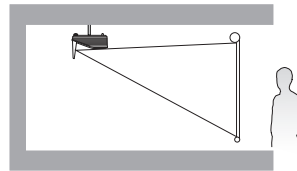

4. Rear Table

Select this location with the projector placed on the table behind the screen.

Note that a special rear projection screen is required.

Set **Rear Table** in the **SYSTEM SETUP: Basic > Projector Position** menu after you turn the projector on.

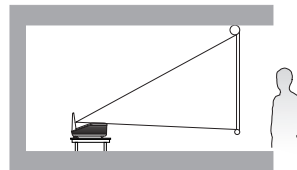

Your room layout or personal preference will dictate which installation location you select. Take into consideration the size and position of your screen, the location of a suitable power outlet, as well as the location and distance between the projector and the rest of your equipment.

Obtaining a preferred projected image size

The distance from the projector lens to the screen, the zoom setting, and the video format each factors in the projected image size.

For example, if you are using an 120-inch screen, the recommended projection distance is 715 mm and the vertical offset is 320 mm.

If your measured projection distance is 0.9 m (900 mm), the closest match in the "[Distance from Screen in mm](#)" column is 902 mm. Looking across this row shows that a 150" (about 3.8 m) screen is required.

Projection dimensions

Refer to "[Dimensions](#)" on page 69 for the center of lens dimensions of this projector before calculating the appropriate position.

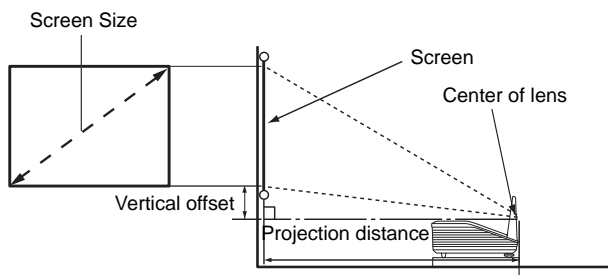

Screen Size				Distance from Screen in mm	Vertical offset in mm
Diagonal		W (mm)	H (mm)		
Inches	mm				
70	1778	1422	1067	404	186.7
80	2032	1626	1219	467	213.4
90	2286	1829	1372	529	240.0
100	2540	2032	1524	591	266.7
120	3048	2438	1829	715	320.0
150	3810	3048	2286	902	400.1
200	5080	4064	3048	1213	533.4
220	5588	4470	3353	1337	586.7
240	6096	4877	3658	1462	640.1

 There is 3% tolerance among these numbers due to optical component variations. BenQ recommends that if you intend to permanently install the projector, you should physically test the projection size and distance using the actual projector in situ before you permanently install it, so as to make allowance for this projector's optical characteristics. This will help you determine the exact mounting position so that it best suits your installation location.

Connection

When connecting a signal source to the projector, be sure to:

1. Turn all equipment off before making any connections.
2. Use the correct signal cables for each source.
3. Ensure the cables are firmly inserted.

- ☞ In the connections shown below, some cables may not be included with the projector (see "Shipping contents" on page 8). They are commercially available from electronics stores.
- The connection illustrations below are for reference only. The rear connecting jacks available on the projector vary with each projector model.

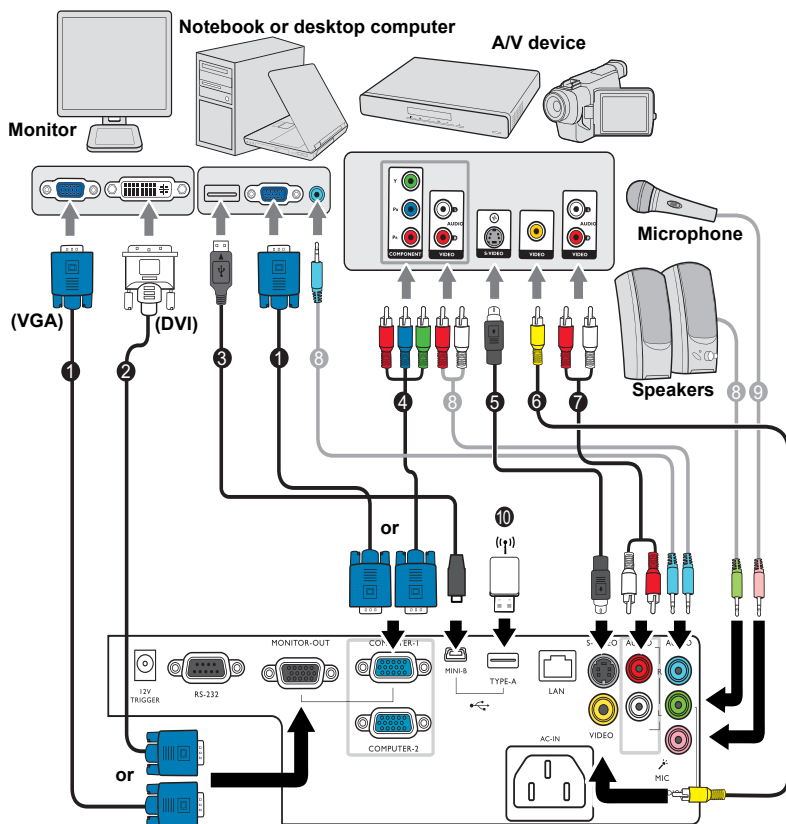





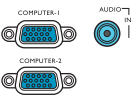

- | | |
|--|--|
| <ol style="list-style-type: none"> 1. VGA cable 2. VGA to DVI-A cable 3. USB cable 4. Component Video to VGA (D-Sub) adapter cable 5. S-Video cable | <ol style="list-style-type: none"> 6. Video cable 7. Audio L/R cable 8. Audio cable 9. Microphone 10. USB flash drive/USB wireless dongle |
|--|--|

- 
 Many notebooks do not turn on their external video ports when connected to a projector. Usually a key combo like FN + F3 or CRT/LCD key turns the external display on/off. Locate a function key labeled CRT/LCD or a function key with a monitor symbol on the notebook. Press FN and the labeled function key simultaneously. Refer to your notebook's documentation to find your notebook's key combination.
- The D-Sub output only works when an appropriate D-Sub input is made to the COMPUTER 1 jack.
- If you wish to use this connection method when the projector is in standby mode, make sure the Monitor Out function is turned on in the SYSTEM SETUP: Advanced menu. See "Standby Settings" on page 58 for details.

Connecting video source devices

You need only connect the projector to a video source device using just one of the connecting methods, however each provides a different level of video quality. The method you choose will most likely depend upon the availability of matching terminals on both the projector and the video source device as described below:

Terminal name	Terminal appearance	Picture quality
Component Video		 Better
S-Video		 Good
Video		 Normal

Connecting audio

The projector has two built-in mono speakers which are designed to provide basic audio functionality accompanying data presentations for business purposes only. They are not designed for, nor intended for stereo audio reproduction use as might be expected in home theater or home cinema applications. Any stereo audio input (if provided), is mixed into a common mono audio output through the projector speakers.

The built-in speaker will be muted when the **AUDIO OUT** jack is connected.

- 
 The projector is only capable of playing mixed mono audio, even if a stereo audio input is connected. See "Connecting audio" on page 17 for details.
- If the selected video image is not displayed after the projector is turned on and the correct video source has been selected, check that the video source device is turned on and operating correctly. Also check that the signal cables have been connected correctly.

Playing sound through the projector

You can make use of the projector (mixed mono) speaker in your presentations, and also connect separate amplified speakers to the **AUDIO OUT** socket of the projector.

If you have a separate sound system, you will most likely want to connect the audio output of your Video source device to that sound system, instead of to the mono audio projector.

You can also use a microphone to output the sound through the projector speaker.

Once connected, the audio can be controlled by the projector On-Screen Display (OSD) menus. See "[Audio Settings](#)" on page 57 for details.

The table below describes the connection methods for different devices, and where the sound is from.

Device	PC/Component Video	Video/S-Video	Microphone
Audio input port	AUDIO IN 1	AUDIO IN 2 (L/R)	MIC 
The projector can play the sound from...	AUDIO IN 1/MIC	AUDIO IN 2 (L/R)/MIC	<ul style="list-style-type: none"> • MIC • AUDIO IN 1/MIC • AUDIO IN 2 (L/R)/MIC
Audio output port	AUDIO OUT	AUDIO OUT	AUDIO OUT
<p>The selected input signal determines which sound will be played by the projector speaker, and which sound will be output from the projector when AUDIO OUT is connected. If you select a PC signal, the projector can play the sound received from AUDIO IN 1/MIC.</p>			

About the microphone input

- If you wish to use a microphone, connect a 3.5 mini jack cable microphone to the projector.
- You can use a wireless microphone as long as a wireless module is attached to the projector's microphone input jack and it works well with the associated devices. To ensure a quality use of the wireless microphone, it is recommended that your microphone conforms to the specifications listed in the table below.

Signal	Parameter	Min	Type	Max	
Microphone	Transducer Principle				Dynamic
	Impedance	300		1K	ohm
	Frequency response	600		16k	Hz

- There are two ways to adjust microphone volumes.
 - Directly set microphone volume levels in the **SYSTEM SETUP: Advanced > Audio Settings > Microphone Volume** menu or press **MIC/VOL** keys (+/-) on the remote control.
 - Set projector volume levels in the **SYSTEM SETUP: Advanced > Audio Settings > Volume** menu, or press **VOLUME+/VOLUME-** on the remote control. (The projector volume setting will affect the microphone volume.)
- To make the microphone input available when the projector is in standby mode, turn on the **SYSTEM SETUP: Advanced > Standby Settings > Microphone** menu.
- If the microphone is not working, check the volume setting and cable connection.

- You might get feedback noise from the microphone when you are too close to the speaker of the projector. Move the microphone away from the speaker of the projector. The greater volume you require, the greater distance you need to be away from the speaker to prevent the noise.

Operation

Starting up the projector

1. Plug the power cord into the projector and into a power outlet. Turn on the power outlet switch (where fitted). Check that the **POWER indicator light** on the projector lights orange after power has been applied.

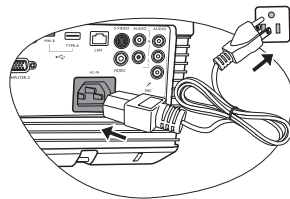

 **Please use the original accessories (e.g. power cord) only with the device to avoid possible dangers such as electric shock and fire.**

2. Press **POWER** on the projector or **ON** on the remote control to start the projector. As soon as the lamp lights up, a "Power On Tone" will be heard. The **POWER indicator light** flashes green and stays green when the projector is on.

The start up procedure takes about 30 seconds. In the later stage of start up, a startup logo is projected.

(If necessary) Rotate the focus ring to adjust the image clearness.

To turn off the ring tone, see "[Turning off the Power On/Off Ring Tone](#)" on page 35 for details.

 **If the projector is still hot from previous activity, it will run the cooling fan for approximately 90 seconds before energizing the lamp.**

3. If the projector is activated for the first time, select your OSD language following the on-screen instructions.
4. If you are prompted for a password, press the arrow keys to enter a six-digit password. See "[Utilizing the password function](#)" on page 24 for details.
5. Switch all of the connected equipment on.
6. The projector will start to search for input signals. The current input signal being scanned displays in the upper left corner of the screen. If the projector doesn't detect a valid signal, the message "No Signal" will continue displaying until an input signal is found.

Please select language		
English	한국어	Hrvatski
Français	Svenska	Română
Deutsch	Nederlands	Norsk
Italiano	Türkçe	Dansk
Español	Čeština	Български
Русский	Português	suomi
繁體中文	ไทย	Indonesian
简体中文	Polski	Ελληνικά
日本語	Magyar	
Press Enter to Confirm, Exit to leave		

You can also press **SOURCE** on the projector or remote control to select your desired input signal. See "[Switching input signal](#)" on page 26 for details.

 **If the frequency/resolution of the input signal exceeds the projector's operating range, you will see the message "Out of Range" displayed on a blank screen. Please change to an input signal which is compatible with the projector's resolution or set the input signal to a lower setting. See "[Timing chart](#)" on page 70 for details.**

Adjusting the projected image

Adjusting the projection angle

The projector is equipped with 2 adjuster feet. These adjusters change the image height and projection angle. To adjust the projector:

Screw the rear adjuster feet to fine-tune the horizontal angle.

To retract the foot, screw the rear adjuster feet in a reverse direction.

If the projector is not placed on a flat surface or the screen and the projector are not perpendicular to each other, the projected image becomes trapezoidal. To correct this situation, see "[Correcting keystone](#)" on [page 22](#) for details.

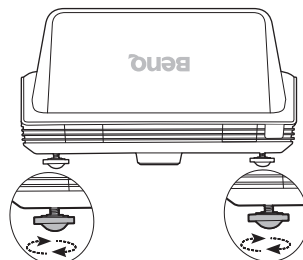

 **Do not look into the lens while the lamp is on. The strong light from the lamp may cause damage to your eyes.**

Auto-adjusting the image

In some cases, you may need to optimize the picture quality. To do this, press **AUTO** on the projector or remote control. Within 3 seconds, the built-in Intelligent Auto Adjustment function will re-adjust the values of Frequency and Clock to provide the best picture quality.

The current source information will be displayed in the corner of the screen for 3 seconds.

-  • **The screen will be blank while AUTO is functioning.**
- **This function is only available when PC signal (analog RGB) is selected.**

Fine-tuning the image clarity

Sharpen the image by rotating the focus ring.

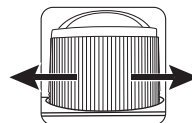
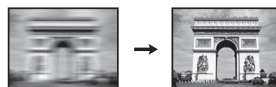





Correcting keystone

Keystoning refers to the situation where the projected image is noticeably wider at either the top or bottom. It occurs when the projector is not perpendicular to the screen.

To correct this, besides adjusting the height of the projector, you will need to manually correct it following ONE of these steps.



- Using the remote control

Press  /  on the projector or remote control to display the Keystone correction page. Press  to correct keystoning at the top of the image. Press  to correct keystoning at the bottom of the image.



- Using the OSD menu

- Press **MENU/EXIT** and then press **◀/▶** until the **DISPLAY** menu is highlighted.
- Press **▼** to highlight **Keystone** and press **MODE/ENTER**. The **Keystone** correction page displays.

Press  to correct keystoning at the top of the image. Press  to correct keystoning at the bottom of the image.

Using the menus

The projector is equipped with On-Screen Display (OSD) menus for making various adjustments and settings.

Below is the overview of the OSD menu.



The following example describes how to set the OSD language.

1. Press **MENU/EXIT** on the projector or remote control to turn the OSD menu on.
3. Press **▼** to highlight **Language** and press **◀/▶** to select a preferred language.



2. Use **◀/▶** to highlight the **SYSTEM SETUP: Basic** menu.
4. Press **MENU/EXIT** twice* on the projector or remote control to leave and save the settings.



*The first press leads you back to the main menu and the second press closes the OSD menu.

Securing the projector

Using a security cable lock

The projector has to be installed in a safe place to prevent theft. Otherwise, purchase a lock, such as the Kensington lock, to secure the projector. You can locate a Kensington lock slot on the rear side of the projector.

A Kensington security cable lock is usually a combination of key(s) and the lock. Refer to the lock's documentation for finding out how to use it.

Utilizing the password function

For security purposes and to help prevent unauthorized use, the projector includes an option for setting up password security. The password can be set through the On-Screen Display (OSD) menu.

WARNING: You will be inconvenienced if you activate the password functionality and subsequently forget the password. Print out this manual (if necessary) and write the password you used in this manual, and keep the manual in a safe place for later recall.

Setting a password

Once a password has been set and the power on lock is activated, the projector cannot be used unless the correct password is entered every time the projector is started.

1. Open the OSD menu and go to the **SYSTEM SETUP: Advanced > Security Settings** menu. Press **MODE/ENTER**. The **Security Settings** page displays.
2. Highlight **Change Security Settings** and press **MODE/ENTER**.
3. As pictured to the right, the four arrow keys (▲, ▶, ▼, ◀) respectively represent 4 digits (1, 2, 3, 4). According to the password you desire to set, press the arrow keys to enter six digits for the password.
4. Confirm the new password by re-entering the new password.



- Once the password is set, the OSD menu returns to the **Security Settings** page.
5. To activate the **Power On Lock** function, press ▲/▼ to highlight **Power On Lock** and press ◀/▶ to select **On**.
 6. To activate the **Splash Screen Lock** function, press ▲/▼ to highlight **Splash Screen Lock** and press ◀/▶ to select **On**.

When the **Splash Screen Lock** is activated, the **MyScreen** function in the **SYSTEM SETUP: Basic** menu will be password-protected.

IMPORTANT: The digits being input will display as asterisks on-screen. Write your selected password down here in this manual in advance or right after the password is entered so that it is available to you should you ever forget it.

Password: _ _ _ _ _

Keep this manual in a safe place.

7. To leave the OSD menu, press **MENU/EXIT**.

If you forget the password

If the password function is activated, you will be asked to enter the six-digit password every time you turn on the projector. If you enter the wrong password, the password error message as pictured to the right displays lasting for 3 seconds, and the **INPUT PASSWORD** message follows. You can retry by entering another six-digit password, or if you did not record the password in this manual, and you absolutely do not remember it, you can use the password recall procedure. See "[Entering the password recall procedure](#)" on page 25 for details.

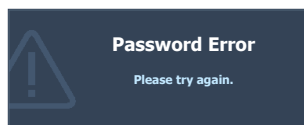

If you enter an incorrect password 5 times in succession, the projector will automatically shut down in a short time.

Entering the password recall procedure

1. Press and hold **AUTO** on the projector or remote control for 3 seconds. The projector will display a coded number on the screen.
2. Write down the number and turn off your projector.
3. Seek help from the local BenQ service center to decode the number. You may be required to provide proof of purchase documentation to verify that you are an authorized user of the projector.

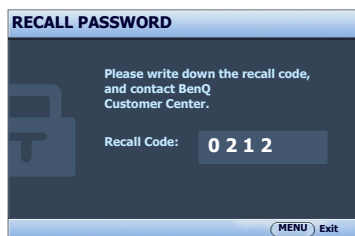

Changing the password

1. Open the OSD menu and go to the **SYSTEM SETUP: Advanced > Security Settings > Change Password** menu.
2. Press **MODE/ENTER**. The message "**INPUT CURRENT PASSWORD**" appears.
3. Enter the old password.
 - i. If the password is correct, another message "**INPUT NEW PASSWORD**" displays.
 - ii. If the password is incorrect, the password error message displays lasting for three seconds, and the message "**INPUT CURRENT PASSWORD**" displays for your retry. You can press **MENU/EXIT** to cancel the change or try another password.
4. Enter a new password.

 **IMPORTANT:** The digits being input will display as asterisks on-screen. Write your selected password down here in this manual in advance or right after the password is entered so that it is available to you should you ever forget it.

Password: _ _ _ _ _

Keep this manual in a safe place.

5. Confirm the new password by re-entering the new password.
6. You have successfully assigned a new password to the projector. Remember to enter the new password next time the projector is started.
7. To leave the OSD menu, press **MENU/EXIT**.

Disabling the password function

To disable password protection, go back to the **SYSTEM SETUP: Advanced > Security Settings > Change Security Settings** menu after opening the OSD menu system. Press **MODE/ENTER**. The message "**INPUT PASSWORD**" displays. Enter the current password.

- i. If the password is correct, the OSD menu returns to the **Security Settings** page. Press **▼** to highlight **Power On Lock** and press **◀/▶** to select **Off**. You will not have to enter the password next time when turning on the projector. Press **▼** to highlight **Splash Screen Lock** and press **◀/▶** to select **Off**. The **Splash Screen** function in the **SYSTEM SETUP: Basic** menu will be available for your change.
- ii. If the password is incorrect, the password error message displays lasting for three seconds, and the message **"INPUT PASSWORD"** displays for your retry. You can press **MENU/EXIT** to cancel the change or try another password.

 **Though the password function is disabled, you need to keep the old password in hand should you ever need to re-activate the password function by entering the old password.**

Switching input signal

The projector can be connected to multiple devices at the same time. However, it can only display one full screen at a time. When starting up, the projector automatically searches for the available signals.

Be sure the **Quick Auto Search** function in the **SOURCE** menu is **On** if you want the projector to automatically search for the signals.

To select the source:

- Using the remote control or projector
Press one of the Source buttons on the remote control, or press **SOURCE** on the projector repeatedly until your desired signal is selected.
- Using the OSD menu
 1. Press **SOURCE** on the projector or remote control. A source selection bar displays.
 2. Press **▲/▼** until your desired signal is selected and press **MODE/ENTER**.

Once detected, the selected source information will display at the corner of the screen for seconds. If there is multiple equipment connected to the projector, repeat steps 1-2 to search for another signal.



-  • **The brightness level of the projected image will change accordingly when you switch between different input signals. Data (graphic) "PC" presentations using mostly static images are generally brighter than "Video" using mostly moving images (movies).**
- **The native display resolution of this projector is in a 4:3 aspect ratio. For best display picture results, you should select and use an input signal which outputs at this resolution. Any other resolutions will be scaled by the projector depending upon the "aspect ratio" setting, which may cause some image distortion or loss of picture clarity. See ["Selecting the aspect ratio" on page 27](#) for details.**
- **Firewall in the PC must be switched off to allow Q Presenter and USB Display to work.**

Magnifying and searching for details

If you need to find the details on the projected picture, magnify the picture. Use the direction arrow keys for navigating the picture.

- Using the remote control
 1. Press **ZOOM+/ZOOM-** to display the Zoom bar. Press **ZOOM+** to magnify the center of the picture. Press the key repeatedly until the picture size is suitable for your need.
 2. Use the directional arrows (**▲**, **▼**, **◀**, **▶**) on the projector or remote control to navigate the picture.
 3. To restore the picture to its original size, press **AUTO**. You can also press **ZOOM-**. When the key is pressed again, the picture is further reduced until it is restored to the original size.
- Using the OSD menu
 1. Press **MENU/EXIT** and then press **◀ / ▶** until the **DISPLAY** menu is highlighted.
 2. Press **▼** to highlight **Digital Zoom** and press **MODE/ENTER**. The Zoom bar displays.
 3. Press **▲** repeatedly to magnify the picture to a desired size.
 4. To navigate the picture, press **MODE/ENTER** to switch to the panning mode and press the directional arrows (**▲**, **▼**, **◀**, **▶**) on the projector or remote control to navigate the picture.
 5. To reduce size of the picture, press **MODE/ENTER** to switch back to the zoom in/out function, and press **AUTO** to restore the picture to its original size. You can also press **▼** repeatedly until it is restored to the original size.



The picture can only be navigated after it is magnified. You can further magnify the picture while searching for details.

Selecting the aspect ratio

The “aspect ratio” is the ratio of the image width to the image height. Most analog TV and some computers are in 4:3 ratio, and digital TV and DVDs are usually in 16:9 ratio.

With the advent of digital signal processing, digital display devices like this projector can dynamically stretch and scale the image output to a different aspect than that of the image input signal.

To change the projected picture ratio (no matter what aspect the source is):

- Using the remote control
 1. Press **ASPECT** to show the current setting.
 2. Press **ASPECT** repeatedly to select an aspect ratio to suit the format of the video signal and your display requirements.
- Using the OSD menu
 1. Press **MENU/EXIT** and then press **◀ / ▶** until the **DISPLAY** menu is highlighted.
 2. Press **▼** to highlight **Aspect Ratio**.
 3. Press **◀ / ▶** to select an aspect ratio to suit the format of the video signal and your display requirements.

About the aspect ratio

- In the pictures below, the black portions are inactive areas and the white portions are active areas.
- OSD menus can be displayed on those unused black areas.

1. **Auto:** Scales an image proportionally to fit the projector's native resolution in its horizontal or vertical width. This is suitable for the incoming image which is neither in 4:3 nor 16:9 and you want to make most use of the screen without altering the image's aspect ratio.

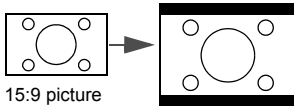

4. **16:9:** Scales an image so that it is displayed in the center of the screen with a 16:9 aspect ratio. This is most suitable for images which are already in a 16:9 aspect, like high definition TV, as it displays them without aspect alteration.

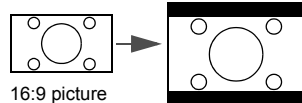

2. **Real:** The image is projected as its original resolution, and resized to fit within the display area. For input signals with lower resolutions, the projected image will display smaller than if resized to full screen. You could adjust the zoom setting or move the projector towards the screen to increase the image size if necessary. You may also need to refocus the projector after making these adjustments.

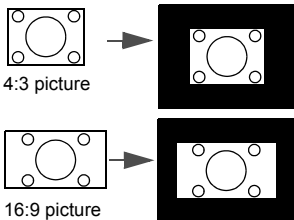

5. **16:10:** Scales an image so that it is displayed in the center of the screen with a 16:10 aspect ratio. This is most suitable for images which are already in a 16:10 aspect, as it displays them without aspect alteration.

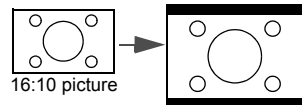

3. **4:3:** Scales an image so that it is displayed in the center of the screen with a 4:3 aspect ratio. This is most suitable for 4:3 images like some computer monitors, standard definition TV and 4:3 aspect DVD movies, as it displays them without aspect alteration.

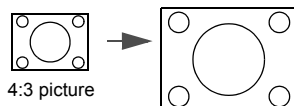

Optimizing the image

Using Wall Color

In the situation where you are projecting onto a colored surface such as a painted wall which may not be white, the Wall Color feature can help correct the projected picture's colors to prevent possible color difference between the source and projected pictures.

To use this function, go to the **DISPLAY > Wall Color** menu and press ◀/▶ to select a color which is closest to the color of the projection surface. There are several precalibrated colors to choose from: **Light Yellow**, **Pink**, **Light Green**, **Blue**, and **Blackboard**.

Selecting a picture mode

The projector is preset with several predefined picture modes so that you can choose one to suit your operating environment and input signal picture type.

To select an operation mode that suits your need, you can follow one of the following steps.

- Press **MODE/ENTER** on the projector or remote control repeatedly until your desired mode is selected.
- Go to the **PICTURE > Picture Mode** menu and press ◀/▶ to select a desired mode.
 1. **Dynamic mode:** Maximizes the brightness of the projected image. This mode is suitable for environments where extra-high brightness is required, such as using the projector in well lit rooms.
 2. **Presentation mode:** Is designed for presentations. The brightness is emphasized in this mode to match PC and notebook coloring.
 3. **sRGB mode:** Maximizes the purity of RGB colors to provide true-to-life images regardless of brightness setting. It is most suitable for viewing photos taken with an sRGB compatible and properly calibrated camera, and for viewing PC graphic and drawing applications such as AutoCAD.
 4. **Cinema mode:** Is appropriate for playing colorful movies, video clips from digital cameras or DVs through the PC input for best viewing in a blackened (little light) environment.
 5. **User 1/User 2 mode:** Recalls the settings customized based on the current available picture modes. See "[Setting the User 1/User 2 mode](#)" on page 29 for details.

Setting the User 1/User 2 mode

There are two user-definable modes if the current available picture modes are not suitable for your need. You can use one of the picture modes (except the **User 1/2**) as a starting point and customize the settings.

1. Press **MENU/EXIT** to open the On-Screen Display (OSD) menu.
2. Go to the **PICTURE > Picture Mode** menu.
3. Press ◀/▶ to select **User 1** or **User 2**.
4. Press ▼ to highlight **Reference Mode**.

 **This function is only available when User 1 or User 2 mode is selected up in the Picture Mode sub-menu item.**

5. Press ◀/▶ to select a picture mode that is closest to your need.
6. Press ▼ to select a menu item to be changed and adjust the value with ◀/▶. See "[Fine-tuning the image quality in user modes](#)" below for details.
7. When all settings have been done, highlight **Save Settings** and press **MODE/ENTER** to store the settings.

8. The confirmation message “**Setting Saved**” displays.

Fine-tuning the image quality in user modes

According to the detected signal type, there are some user-definable functions available when **User 1** or **User 2** is selected. Based on your needs, you can make adjustments to these functions by highlighting them and pressing ◀/▶ on the projector or remote control.

Adjusting Brightness

The higher the value, the brighter the image. And the lower the setting, the darker the image. Adjust this control so the black areas of the image appear just as black and that detail in the dark areas is visible.



Adjusting Contrast

The higher the value, the greater the contrast. Use this to set the peak white level after you have previously adjusted the Brightness setting to suit your selected input and viewing environment.



Adjusting Color

Lower setting produces less saturated colors. If the setting is too high, colors on the image will be overpowering, which makes the image unrealistic.

Adjusting Tint

The higher the value, the more reddish the picture becomes. The lower the value, the more greenish the picture becomes.

Adjusting Sharpness

The higher the value, the sharper the picture becomes. The lower the value, the softer the picture becomes.

Adjusting Brilliant Color

This feature utilizes a new color-processing algorithm and system level enhancements to enable higher brightness while providing truer, more vibrant colors in picture. It enables a greater than 50% brightness increase in mid-tone images, which are common in video and natural scenes, so the projector reproduces images in realistic and true colors. If you prefer images with that quality, select **On**. If you don't need it, select **Off**.

When **Off** is selected, the **Color Temperature** function is not available.

Selecting a color temperature

The options available for color temperature* settings vary according to the signal type selected.

1. **T1**: With the highest color temperature, T1 makes the image appear the most bluish white than other settings.
2. **T2**: Makes images appear bluish white.
3. **T3**: Maintains normal colorings for white.
4. **T4**: Makes images appear reddish white.

*About color temperatures:

There are many different shades that are considered to be "white" for various purposes. One of the common methods of representing white color is known as the "color temperature". A white color with a low color temperature appears to be reddish white. A white color with a high color temperature appears to have more blue in it.

3D Color Management

In most installation situations, color management will not be necessary, such as in classroom, meeting room, or lounge room situations where lights remain on, or where building external windows allow daylight into the room.

Only in permanent installations with controlled lighting levels such as boardrooms, lecture theaters, or home theaters, should color management be considered. Color management provides fine color control adjustment to allow for more accurate color reproduction, should you require it.

Proper color management can only be achieved under controlled and reproducible viewing conditions. You will need to use a colorimeter (color light meter), and provide a set of suitable source images to measure color reproduction. These tools are not provided with the projector, however, your projector supplier should be able to provide you with suitable guidance, or even an experienced professional installer.

The Color Management provides six sets (RGBCMY) of colors to be adjusted. When you select each color, you can independently adjust its range and saturation according to your preference.

If you have purchased a test disc which contains various color test patterns and can be used to test the color presentation on monitors, TVs, projectors, etc, you can project any image from the disc on the screen and enter the **3D Color Management** menu to make adjustments.

To adjust the settings:

1. Go to the **PICTURE** menu and highlight **3D Color Management**.
2. Press **MODE/ENTER** on the projector or remote control and the **3D Color Management** page displays.
3. Highlight **Primary Color** and press **◀/▶** to select a color from among Red, Yellow, Green, Cyan, Blue, or Magenta.
4. Press **▼** to highlight **Hue** and press **◀/▶** to select its range. Increase in the range will include colors consisted of more proportions of its two adjacent colors.

Please refer to the illustration to the right for how the colors relate to each other.

For example, if you select Red and set its range at 0, only pure red in the projected picture will be selected. Increasing its range will include red close to yellow and red close to magenta.

5. Press **▼** to highlight **Saturation** and adjust its values to your preference by pressing **◀/▶**. Every adjustment made will reflect to the image immediately.

For example, if you select Red and set its value at 0, only the saturation of pure red will be affected.

 **Saturation is the amount of that color in a video picture. Lower settings produce less saturated colors; a setting of "0" removes that color from the image entirely. If the saturation is too high, that color will be overpowering and unrealistic.**

6. Press **▼** to highlight **Gain** and adjust its values to your preference by pressing **◀/▶**. The contrast level of the primary color you select will be affected. Every adjustment made will reflect to the image immediately.

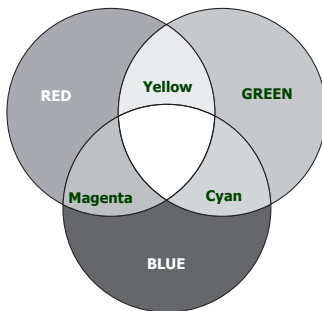

7. Repeat steps 3 to 6 for other color adjustments.
8. Make sure you have made all of the desired adjustments.
9. Press **MENU/EXIT** to exit and save the settings.

Setting the presentation timer

Presentation timer can indicate the presentation time on the screen to help you achieve better time management when giving presentations. Follow these steps to utilize this function:

1. Go to the **SYSTEM SETUP: Basic > Presentation Timer** menu and press **MODE/ENTER** to display the **Presentation Timer** page.
2. Highlight **Timer Period** and decide the time period by pressing **◀/▶**. The length of time can be set from 1 to 5 minutes in 1-minute increments and 5 to 240 minutes in 5-minute increments.

 **If the timer is already on, the timer will restart whenever the Timer Period is reset.**

3. Press **▼** to highlight **Timer Display** and choose if you want the timer to show up on the screen by pressing **◀/▶**.

Selection	Description
Always	Displays the timer on screen throughout the presentation time.
1 min/2 min/3 min	Displays the timer on screen in the last 1/2/3 minute(s).
Never	Hides the timer throughout the presentation time.

4. Press **▼** to highlight **Timer Position** and set the timer position by pressing **◀/▶**.

Top-Left → Bottom-Left → Top-Right → Bottom-Right

5. Press **▼** to highlight **Timer Counting Direction** and select your desired counting direction by pressing **◀/▶**.

Selection	Description
Count Up	Increases from 0 to the preset time.
Count Down	Decreases from the preset time to 0.

6. Press **▼** to highlight **Sound Reminder** and decide if you want to activate sound reminder by pressing **◀/▶**. If you select **On**, a double beep sound will be heard at the last 30 seconds of counting down/up, and a triple beep sound will be produced when the timer is up.
7. To activate the presentation timer, press **▼** and press **◀/▶** to highlight **On** and press **MODE/ENTER**.
8. A confirmation message displays. Highlight **Yes** and press **MODE/ENTER** on the projector or remote control to confirm. You will see the message “**Timer is On**” displaying on the screen. The timer starts counting when the timer is on.

To cancel the timer, perform the following steps:

1. Go to the **SYSTEM SETUP: Basic > Presentation Timer** menu and highlight **Off**. Press **MODE/ENTER**. A confirmation message displays.
2. Highlight **Yes** and press **MODE/ENTER** to confirm. You will see the message “**Timer is Off**” displaying on the screen.

Remote paging operations

Connect the projector to your PC or notebook with a USB cable prior to using the paging function. See "[Connection](#)" on page 16 for details.

You can operate your display software program (on a connected PC) which responds to page up/down commands (like Microsoft PowerPoint) by pressing **PAGE UP/PAGE DOWN** on the remote control.

If remote paging function doesn't work, check if the USB connection is correctly made and the mouse driver on your computer is updated to the latest version.

 **The remote paging function cannot work with Microsoft® Windows®98 operating system. Windows®XP or higher operating systems are recommended.**

Freezing the image

Press **FREEZE** on the remote control to freeze the image. The word "**FREEZE**" will display in the upper left corner of the screen. To release the function, press any key on the projector or remote control.

Even if an image is frozen on the screen, the pictures are running on the video or other device. If the connected devices have active audio output, you will still hear the audio even though the image is frozen onscreen.

Hiding the image

In order to draw the audience's full attention to the presenter, you can use **BLANK** on the projector or remote control to hide the screen image. The word "**BLANK**" appears in the corner of the screen while the image is hidden. When this function is activated with an audio input connected, the audio can still be heard.

You can set the blank time in the **SYSTEM SETUP: Basic > Operation Settings > Blank Timer** menu to let the projector return the image automatically after a period of time when there is no action taken on the blank screen. The length of time can be set from 5 to 30 minutes in 5-minute increments.

If the preset time spans are not suitable for your presentation, select **Disable**.

No matter **Blank Timer** is activated or not, you can press most of the keys on the projector or remote control to restore the picture.

 **Do not block the projection lens from projecting as this could cause the blocking object to become heated and deformed or even cause a fire.**

Utilizing FAQ function





The **INFORMATION** menu contains possible solutions to problems regarding image quality, installation, special feature operation and service information.

To get the FAQ information:



1. Press **◀ / (?)** on the projector or remote control or press **MENU/EXIT** to open the OSD menu and press **◀ / ▶** to highlight the **INFORMATION** menu.
2. Press **▼** to select **FAQ-Image and Installation** or **FAQ-Features and Service**.
3. Press **MODE/ENTER**.
4. Press **▲ / ▼** to select a problem and press **MODE/ENTER** for possible solutions.
5. To exit the OSD menu, press **MENU/EXIT**.

Locking control keys

With the control keys on the projector locked, you can prevent your projector settings from being changed accidentally (by children, for example). When the **Panel Key Lock** is on, no control keys on the projector will operate except  **POWER**.

1. Press /  on the projector or remote control or go to the **SYSTEM SETUP: Basic > Panel Key Lock** menu, and select **On** by pressing /  on the projector or remote control. A confirmation message displays.
2. Highlight **Yes** and press **MODE/ENTER** to confirm.

To release panel key lock, press and hold /  on the remote control or projector for 3 seconds.

You can also use the remote control to enter the **SYSTEM SETUP: Basic > Panel Key Lock** menu and press /  to select **Off**.



• **Keys on the remote control are still active when panel key lock is enabled.**

- If you press  **POWER** to turn off the projector without disabling panel key lock, the projector will still be in locked status the next time it is turned on.





Operating in a high altitude environment

We recommend you use the **High Altitude Mode** when your environment is between 1500 m –3000 m above sea level, and ambient temperature is between 0°C–35°C.



Do not use the High Altitude Mode if your altitude is between 0 m and 1500 m and ambient temperature is between 0°C and 35°C. The projector will be over cooled, if you turn the mode on under such a condition.

To activate the **High Altitude Mode**:

1. Press **MENU/EXIT** and then press /  until the **SYSTEM SETUP: Advanced** menu is highlighted.
2. Press  to highlight **High Altitude Mode** and press /  select **On**. A confirmation message displays.
3. Highlight **Yes** and press **MODE/ENTER**.

Operation under "**High Altitude Mode**" may cause a higher decibel operating noise level because of increased fan speed necessary to improve overall system cooling and performance.

If you use this projector under other extreme conditions excluding the above, it may display auto shut-down symptoms, which is designed to protect your projector from over-heating. In cases like this, you should switch to High Altitude mode to solve these symptoms. However, this is not to state that this projector can operate under any and all harsh or extreme conditions.

Creating your own startup screen

In addition to selecting the projector preset startup screen from among BenQ logo, Black or Blue screen, you can make your own startup screen that is a picture projected from your computer or video source.

To create your own startup screen, project the picture you want to use as your startup screen from either a computer or video source. The rest steps are as follows.

- Using the remote control

1. Press **CAPTURE** on the remote control.
 2. A confirmation message displays. Press **CAPTURE** or **MODE/ENTER** again.
 3. The message '**Screen Capturing...**' displays while the projector is processing the picture. Please wait.
 4. If the action is successful, you see the message '**Captured Succeeded**' on the screen. The captured picture is saved as **My Screen**.
 5. To view the captured picture displayed as the startup screen, set **My Screen** in the **SYSTEM SETUP: Basic > Splash Screen** menu and restart the projector.
 - Using the OSD menu
 1. Press **MENU/EXIT** and then press ◀/▶ until the **SYSTEM SETUP: Basic** menu is highlighted.
 2. Press ▼ to highlight **MyScreen** and press **MODE/ENTER**.
 3. Repeat steps 2-5 in the "Using the remote control" section to capture and view the captured picture.
- In the unlikely event that the capturing action fails, change your target picture.

Adjusting the sound

The sound adjustments made as below will have an effect on the projector speakers. Be sure you have made a correct connection to the projector audio input. See "[Connection](#)" on page 16 for how the audio input is connected.

Muting the sound

To temporarily turn off the sound:

1. Press **MENU/EXIT** and then press ◀/▶ until the **SYSTEM SETUP: Advanced** menu is highlighted.
2. Press ▼ to highlight **Audio Settings** and press **MODE/ENTER**. The **Audio Settings** page displays.
3. Highlight **Mute** and press ◀/▶ to select **On**.

Adjusting the sound level

To adjust the sound level, press **VOLUME+/VOLUME-** on the remote control, or:

1. Repeat steps 1-2 above.
2. Press ▼ to highlight **Volume** and press ◀/▶ to select a desired sound level.

Adjusting the microphone volume

To adjust the microphone sound level, press **MIC/VOL** keys (+/-) on the remote control, or:

1. Repeat steps 1-2 above.
2. Press ▼ to highlight **Microphone Volume** and press ◀/▶ to select a desired sound level.

Turning off the Power On/Off Ring Tone

To turn off the ring tone:

1. Repeat steps 1-2 above.
2. Press ▼ to highlight **Power On/Off Ring Tone** and press ◀/▶ to select **Off**.

 **The only way to change Power On/Off Ring Tone is setting On or Off here. Setting the sound mute or changing the sound level will not affect the Power On/Off Ring Tone.**

Controlling the projector through a LAN environment

You can manage and control the projector from one or more remote computers when they are properly connected to the same local area network.

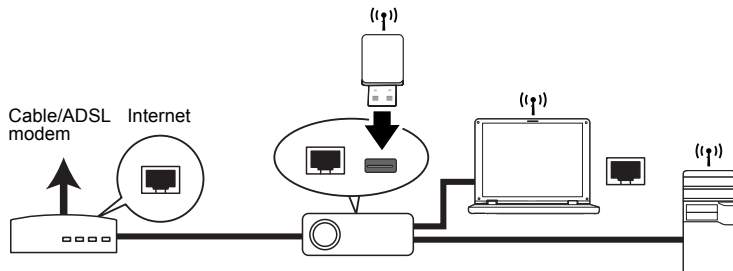

Cable connection

If you are in a DHCP environment:

1. Take a RJ45 cable and connect one end to the RJ45 LAN input jack of the projector and the other end to the RJ45 port on your Ethernet or router.
2. Do one of the following:
 - Press **NETWORK SETTING** on the remote control. The **Network Settings** page is displayed.
 - Press **MENU/EXIT** and then press **◀/▶** until the **SYSTEM SETUP: Advanced** menu is highlighted. Press **▼** to highlight **Network Settings** and press **MODE/ENTER**. The **Network Settings** page is displayed.
3. Highlight **Wired LAN** and press **MODE/ENTER**.
4. Make sure the **Status** is **Connect**.
5. Press **▼** to highlight **DHCP** and press **◀/▶** to select **On**.
6. Press **▼** to highlight **Apply** and press **MODE/ENTER**.
7. Re-enter the **Network Settings > Wired LAN** page. The **IP Address**, **Subnet Mask**, **Default Gateway**, and **DNS** settings will be displayed. Note down the IP address displayed in the **IP Address** row.

 If the IP Address still does not appear, contact your ITS administrator.

If you are in a non-DHCP environment:

1. Repeat steps 1-4 above.
2. Press **▼** to highlight **DHCP** and press **◀/▶** to select **Off**.
3. Contact your ITS administrator for information on the **IP Address**, **Subnet Mask**, **Default Gateway**, and **DNS** settings.
4. Press **▼** to select the item you want to modify and press **MODE/ENTER**.
5. Press **◀/▶** to move the cursor and the press **▲/▼** to enter the value.
6. To save the settings, press **MODE/ENTER**. If you do not want to save the settings, press **MENU/EXIT**.
7. Press **▼** to highlight **Apply** and press **MODE/ENTER**.

Wireless connection

To connect to the projector wirelessly, you have to plug a BenQ wireless dongle (optional) to the USB Type A connector on the projector, and then only a few OSD configuration steps are required.

1. Make sure the projector is turned on.
2. Do one of the following:
 - Press **NETWORK SETTING** on the remote control. The **Network Settings** page is displayed.
 - Press **MENU/EXIT** and then press ◀/▶ until the **SYSTEM SETUP: Advanced** menu is highlighted. Press ▼ to highlight **Network Settings** and press **MODE/ENTER**. The **Network Settings** page is displayed.
3. Highlight **Wireless LAN** and press **MODE/ENTER**.
4. Make sure the **Status** is **Connect**.
5. Make sure the **SSID** information is displayed.
6. Press ▼ to highlight **Connection Mode** and press ◀/▶ to select **AP** or **Infrastructure**.
In AP mode, you need to use your computer's wireless connection utility to search the projector's SSID and connect to it. Then you can search the projector with Q Presenter. To use **Infrastructure** mode, you should connect both your computer and projector to the same AP router and make connections with the IP address.



- **There are more wireless settings available on the Projector Network display System > Admin > Wireless LAN page.**
- **If you need more information about AP and Infrastructure modes, please refer to user documentations for Wireless Routers which are usually available on 3C stores.**

Controlling the projector remotely through a web browser

Once you have the correct IP address for the projector and the projector is on or in standby mode, you can use any computer that is on the same local area network to control the projector.

- ☞ • **If you are using Microsoft Internet Explorer, make sure it is version 7.0 or higher.**
- **The screenshots in this manual are for reference only, and may differ from the actual design.**

1. Enter the address of the projector in the address bar of your browser and press Enter.



2. The main page of the Projector Network Display System appears. This web page provides access to a variety of functions with a simple click.

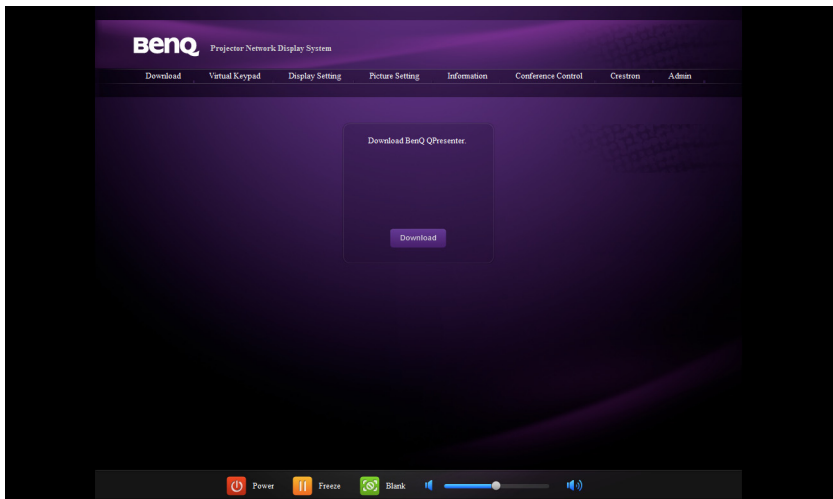

3. Click Download to save Q Presenter software on your computer. See "[Displaying images through Q Presenter](#)" on page 46 for details.

- The Virtual Keypad page displays a virtual keypad with which you can control the projector as if using the physical keypad on the projector. See ["Projector" on page 10](#) for how to operate it.



- The Display Setting page provides some selective OSD menu items necessary for controlling the projector or adjusting the projected pictures. See the chapter ["Menu operation"](#) for how to use them.

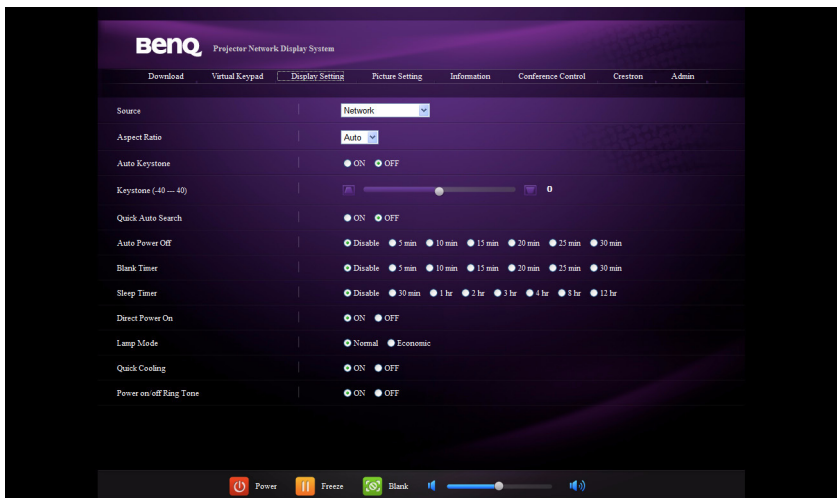

- The Picture Setting page provides all the OSD menu items in the **PICTURE** menu for adjusting the projected pictures. See "[2. PICTURE menu](#)" on page 55 for how to use them.

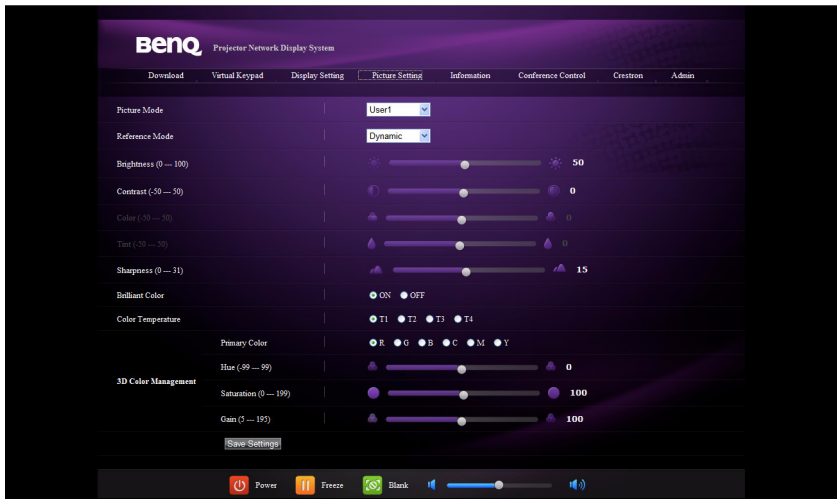

- The Information page displays the information about the projector status, network status.

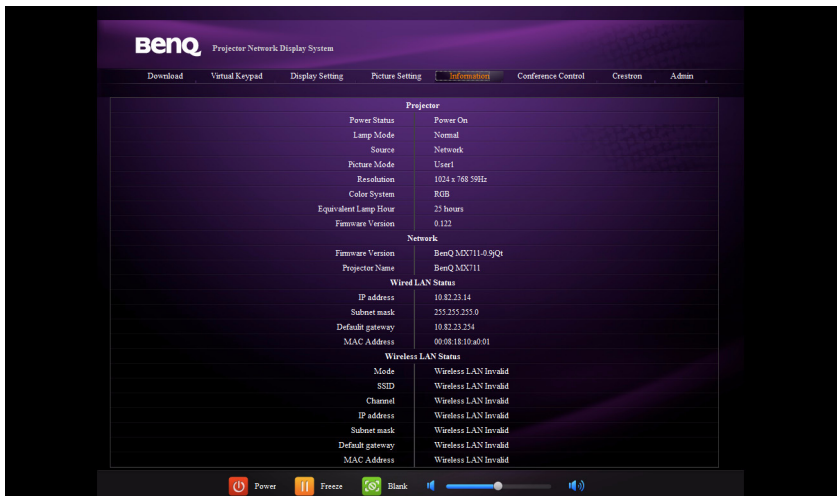

8. The Conference Control page allows you to control the display location in the same IP address when there are multiple users connecting to the projector.

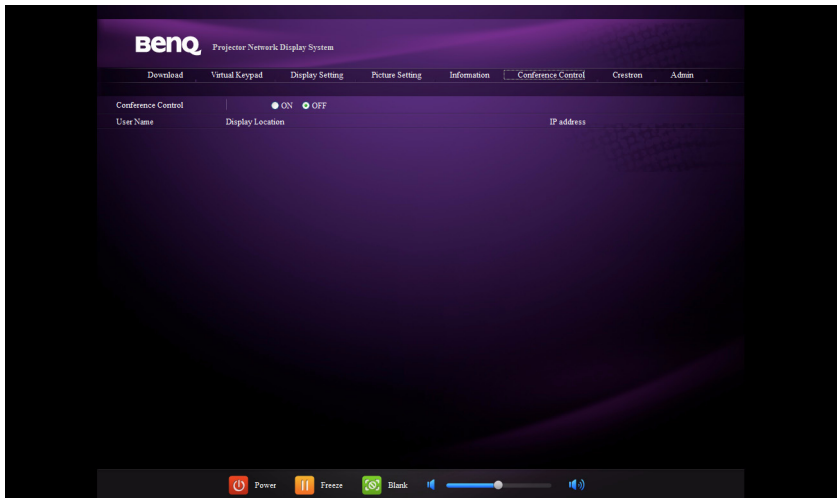

9. The Crestron (eControl) page displays the Crestron eControl user interface. The eControl page provides a variety of virtual keys to control the projector or adjust the projected pictures.



- i. These buttons function the same as the ones on the OSD menus or remote control. See "2. PICTURE menu" on page 55 and "Remote control" on page 11 for details.
- ii. To switch input source, click your desired signal.
- iii. The software is available in multiple languages.



The Menu button can also be used to go back to previous OSD menu, exit and save menu settings.

The tools page allows you to manage the projector, configure the LAN control settings and secure access of remote network operation on this projector.

- i. You can name the projector, keep track of its location and the person in charge of it.
- ii. You can adjust the **Network Settings**.
- iii. Once set, access to the remote network operation on this projector has been password-protected.
- iv. Once set, access to the tools page has been password-protected.

 **After making the adjustments, press the Send button and the data will be saved in the projector.**

- v. Press **exit** to go back to the remote network operation page.

The info page displays the information and status of this projector.

Press **exit** to go back to the remote network operation page.

For more information, visit <http://www.crestron.com> & www.crestron.com/getroomview.

6. To have access to the Admin page, you need to enter a password. The page provides more network settings. The default password is “0000”. If you want to change the password, enter the Basic page.



The Basic page allows you to change the password and set the maximum number of connected computers. The number of connected computer may affect the network display performance.

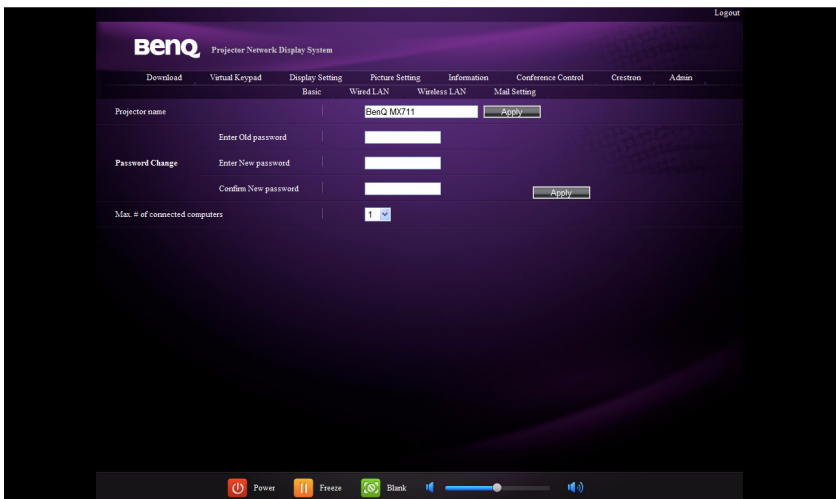

The Wired LAN page allows you to adjust the Wired LAN settings.

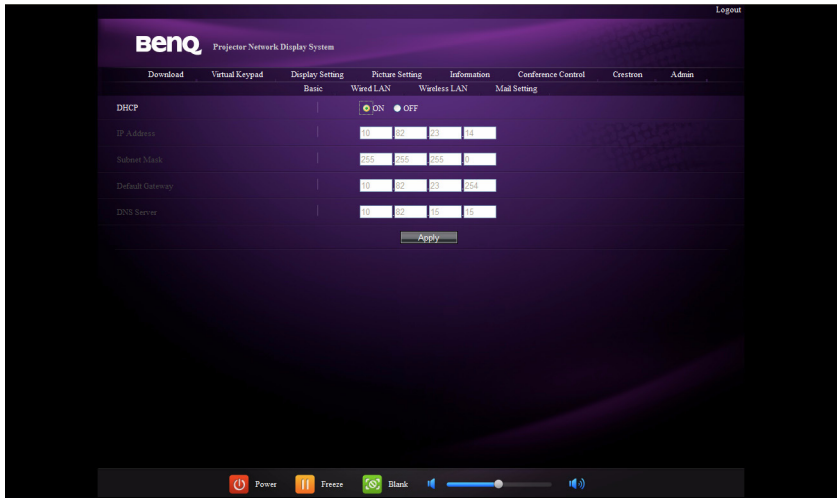

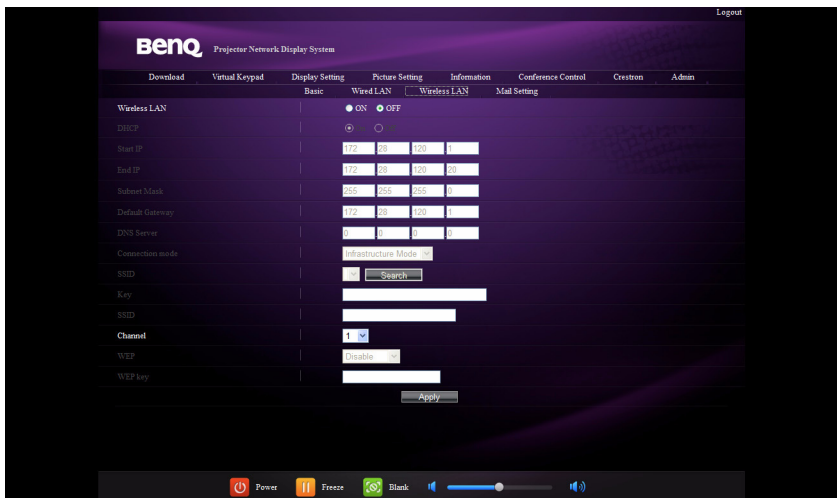

The Wireless LAN page allows you to adjust the Wireless LAN settings.

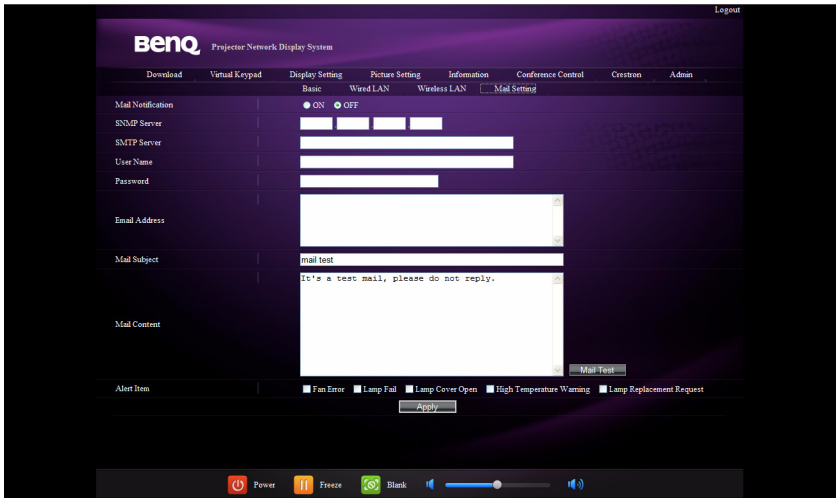

The maximum length for SSID is 16 bytes. Please use different SSID when more than two projectors are connecting through wireless LAN.

The Mail page allows you to send alert e-mail to your ITS administrator.



 You can first try the Mail Test function to check if the Alert Mail works.

7. These quick buttons are always provided on the web page for you to operate the projector.

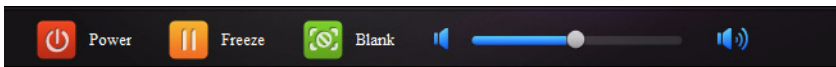

Displaying images through Q Presenter

Downloading and installing Q Presenter

Q Presenter is an application running on the host PC. It helps connect your computer to an available network projector and transfer the desktop contents to the network projector via local network connection.

1. Enter the main page of the Projector Network Display System. See steps 1-2 on page 38 for details.
2. Click the Download icon.
3. When the download is complete, install the software to your computer by clicking the exe file. Follow the on-screen instructions to complete the installation.
4. Launch Q Presenter.

Using Q Presenter

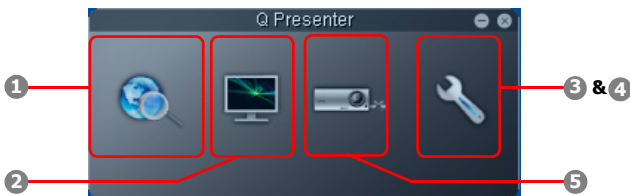

1. The Search page allows you to search and connect to a projector.

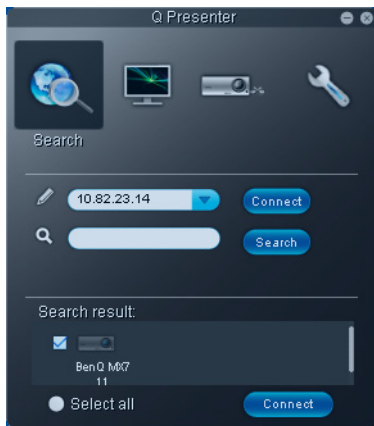

- To connect to a projector, type the projector IP address and click Connect.
- To search for projectors, simply click Search to list all the projectors on the same local area network. Click the desired projectors in the Search result list, and click Connect. You can also type a desired projector name and click Search.

2. The Special Feature page provides some advanced functions to manage the projected images.

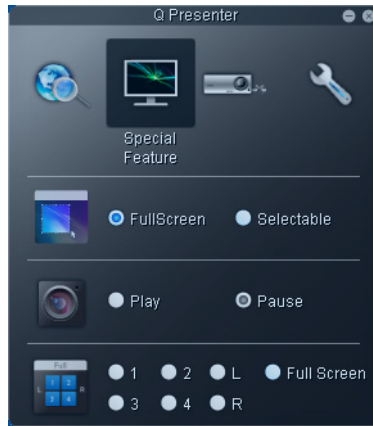

- To display a full screen, click Full Screen.
 - To display a partial screen, click Selectable. A square appears on your screen. You can adjust its size and place it where you want to project.
 - To pause projection, click Pause.
 - If there are multiple computers connected to the projector, you can decide a display location by clicking 1, 2, 3, 4, L, R, or Full Screen.
3. The Basic Settings page allows you to configure Q Presenter.

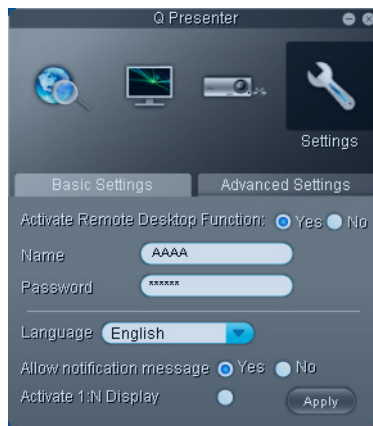

- To activate Remote Desktop function, click Yes. Type the name and password for your computer. Go to the projector OSD menu **SYSTEM SETUP: Advanced > Network Settings > Remote Desktop**, and enter **Account** (the name for your computer) and **Password**, and highlight **Connect**, press **MODE/ENTER**.

- The Q Presenter only accepts up to 8 characters consisting of English capitalized letters and digits 0-9 for the name, full 6 digits consisting of 1 to 4 for the password.
 - To change the Q Presenter interface language, click the down arrow to reveal a drop-down list and select a desired language. Click Apply.
 - To allow notification messages to appear, click Yes. Click Apply.
 - To display your computer screen on multiple projectors, click Activate 1:N Display. Click Apply. It can display up to 8 projectors at the same time.
4. The Advanced Settings page allows you to configure Q Presenter.

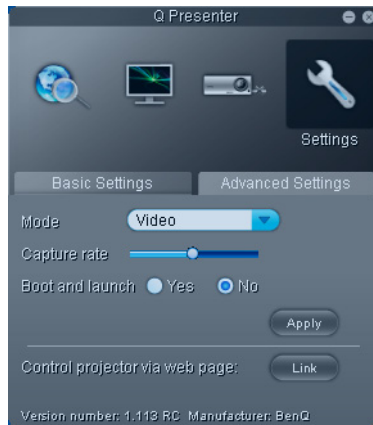

- To display still pictures, click the down arrow to reveal a drop-down list and select Graphic. Click Apply. To display video clips, click the down arrow to reveal a drop-down list and select Video. Click Apply.
Graphic mode: worse image quality but faster transmission speed.
Video mode: better image quality but slower transmission speed.
However, the actual transmission speed was determined by the network traffic at that time.
 - To adjust the capture rate, move the slide bar. The network bandwidth may also affect the performance.
 - To launch Q Presenter when your computer operating system is started, click Yes for Boot and launch. Click Apply.
 - To link to the Projector Network Display System web page, click Link.
5. Disconnect
- To disconnect from the projector(s), click the Disconnect icon.



- **Be sure to turn off other virtual network control programs before using Q Presenter.**
- **Firewall in the PC must be switched off to allow Q Presenter and USB Display to work.**
- **Wireless keyboard mouse combo is not supported by Pixelworks currently.**

Presenting from a USB Reader

This feature displays a slide show of images stored on a USB flash drive connected to the projector. It can eliminate the need for a computer source.

Supported image formats:

- JPEG(JPG)
- PNG
- TIFF
- BMP
- GIF



- A square box will display on the filename for unidentified characters.
- Thai filename is not supported.
- Files in GIF, TIFF, PNG and BMP formats can be displayed for the file size smaller than WXGA (1280 x 800) only.
- If a folder consists of more than 200 photos, only the first 200 photos can be displayed.

To view your pictures as a slideshow, follow these steps:

1. Plug the USB flash drive into the USB TYPE-A jack of the projector.
2. The projector automatically displays the thumbnails. Or you can manually select **USB Reader** from the source selection bar.

When viewing thumbnails

To	Press
open the folder	Enter
scroll through thumbnails	four arrow keys
return to a previous page	Auto
exit USB Reader	Exit
change to a different page	◀/▶
go back to the first page of that folder	Back
start a slide show	Slideshow when an image is highlighted.
adjust USB Reader settings	Setting

During a slide show

To	Press
go to the previous or next image	◀/▶
rotate the image by 90 degree clockwise/counterclockwise	▲/▼ (Rotation is temporary; the image returns to its original orientation when you go back to thumbnails)
return to a previous page	Auto
start/stop a slide show	Enter

Setting page

You can adjust the file order and Slideshow settings. When you are done, press OK to save the settings or press Cancel to ignore the change.

Shutting down the projector

1. Press **POWER** on the projector or **OFF** on the remote control, and a confirmation message will display prompting you.
If you don't respond in a few seconds, the message will disappear.
2. Press **POWER** a second time. The **POWER indicator light** flashes orange, the projection lamp shuts down, and the fans will continue to run for approximately 90 seconds to cool down the projector.

! To protect the lamp, the projector will not respond to any commands during the cooling process.

To shorten the cooling time, you can also activate the Quick cooling function. See **"Quick Cooling"** on page 57 for details.

3. Once the cooling process finishes, a **"Power Off Ring Tone"** will be heard. The **POWER indicator light** is a steady orange and fans stop. Disconnect the power cord from the power outlet.

☞ To turn off the power ring tone, see **"Turning off the Power On/Off Ring Tone"** on page 35 for details.

- If the projector is not properly shut down, to protect the lamp, when you attempt to re-start the projector, the fans will run for a few minutes to cool down. Press **POWER** again to start the projector after the fans stop and the **POWER indicator light** turns orange.
- Lamp life results will vary depending on environmental conditions and usage.

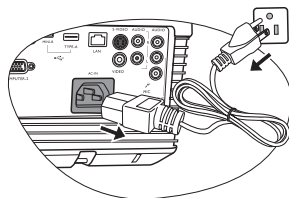

Direct power off

The AC power cord can be pulled out right after the projector is turned off. To protect the lamp, wait about 10 minutes before re-starting the projector. (When you attempt to re-start the projector, the fans may run for a few minutes to cool down. In such cases, press

POWER again to start the projector after the fans stop and the **POWER indicator light** turns orange.

Menu operation

Menu system

Please note that the on-screen display (OSD) menus vary according to the signal type selected and the projector model you are using.





Main menu	Sub-menu	Options	
1. DISPLAY	Wall Color	Off/Light Yellow/Pink/Light Green/Blue/Blackboard	
	Aspect Ratio	Auto/Real/4:3/16:9/16:10	
	Keystone		
	Position		
	Phase		
	H. Size		
	Digital Zoom		
	3D Sync	On/Off	
	3D Sync Invert	Disable/Invert	
	Teaching Template	Blackboard Whiteboard	Off/Letter Formation/Worksheet/Coordinate Chart Off/Letter Formation/Worksheet/Coordinate Chart
2. PICTURE	Picture Mode	Dynamic/Presentation/sRGB/Cinema/User 1/User 2	
	Reference Mode	Dynamic/Presentation/sRGB/Cinema	
	Brightness		
	Contrast		
	Color		
	Tint		
	Sharpness		
	Brilliant Color	On/Off	
	Color Temperature	T1/T2/T3/T4	
	3D Color Management	Primary Color	R/G/B/C/M/Y
		Hue	
		Saturation	
		Gain	
Save Settings			
3. SOURCE	Quick Auto Search	On/Off	
4. SYSTEM SETUP: Basic	Presentation Timer	Timer Period	1~240 minutes
		Timer Display	Always/1 min/2 min/3 min/Never
		Timer Position	Top-Left/Bottom-Left/Top-Right/Bottom-Right
		Timer Counting Direction	Count Down/Count Up
		Sound Reminder	On/Off
			On/Off



Main menu	Sub-menu	Options	
4. SYSTEM SETUP: Basic	Language	English/Français/Deutsch Italiano/Español/Русский 繁體中文/简体中文/日本語/한국어/ Svenska/Nederlands/Türkçe/ Čeština/Português/ไทย/ Polski Magyar/ Български/ Hrvatski/ Română/ Suomi/ Norsk/ Dansk /Indonesian/Ελληνικά	
	Projector Position	Front Table/Rear Table/Rear Ceiling/Front Ceiling	
	Menu Settings	Menu Display Time	5 sec/10 sec/15 sec/20 sec/25 sec/30 sec
		Menu Position	Center/Top-Left/Top-Right/ Bottom-Right/Bottom-Left
		Reminder Message	On/Off
	Operation Settings	Direct Power On	On/Off
		Auto Power Off	Disable /5 min/10 min/15 min/20 min/25 min/30 min
		Blank Timer	Disable /5 min/10 min/15 min/20 min/25 min/30 min
		Sleep Timer	Disable /30 min/1 hr/2 hr/3 hr/4 hr/8 hr/12 hr
	Panel Key Lock	On/Off	
	Background Color	Black/Blue/Purple/BenQ	
	Splash Screen MyScreen	Black/Blue/BenQ/My Screen	
5. SYSTEM SETUP: Advanced	Quick Cooling	On/Off	
	High Altitude Mode	On/Off	
	Audio Settings	Mute	On/Off
		Volume	
		Microphone Volume	
		Power On/Off Ring Tone	On/Off
	Lamp Settings	Lamp Mode	Normal/Economic
		Reset lamp timer	
		Equivalent Lamp Hour	
	Security Settings	Change Password	
		Change Security Settings	Power On Lock Splash Screen Lock
	Baud Rate	2400/4800/9600/14400/19200/ 38400/57600/115200	
	Test Pattern	On/Off	

Main menu	Sub-menu	Options		
5. SYSTEM SETUP: Advanced	Closed Caption	Closed Caption	On/Off	
		Enable		
		Caption Version	CC1/CC2/CC3/CC4	
	Standby Settings	Network	On/Off	
		Microphone	On/Off	
		Monitor Out	On/Off	
	Network Settings	Wired LAN	Status	
			DHCP	
			IP Address	
			Subnet Mask	
			Default Gateway	
			DNS Server	
			Apply	
			Status	
		Wireless LAN	SSID	
IP Address				
Connection Mode				
Remote Desktop		Account		
	Password			
	Connect			
	Reset All Settings			
6. INFORMATION	FAQ-Image and Installation			
	FAQ-Features and Service			
	Current System Status	<ul style="list-style-type: none"> • Source • Picture Mode • Resolution • Color System • Equivalent Lamp Hour • Firmware Version 		



Note that the menu items are available when the projector detects at least one valid signal. If there is no equipment connected to the projector or no signal detected, limited menu items are accessible.



Description of each menu

Function	Description
Wall Color	Corrects the projected picture's color when the projection surface is not white. See "Using Wall Color" on page 29 for details.
Aspect Ratio	There are several options to set the image's aspect ratio depending on your input signal source. See "Selecting the aspect ratio" on page 27 for details.
Keystone	Corrects any keystone of the image. See "Correcting keystone" on page 22 for details.
Position	<p>Displays the position adjustment page. To move the projected image, use the directional arrow keys. The values shown on the lower position of the page change with every key press you made until they reach their maximum or minimum.</p> <p> This function is only available when a PC signal (analog RGB) is selected.</p>
Phase	<p>Adjusts the clock phase to reduce image distortion.</p>  <p> This function is only available when a PC signal (analog RGB) is selected.</p>
H. Size	<p>Adjusts the horizontal width of the image.</p> <p> This function is only available when a PC signal (analog RGB) is selected.</p>
Digital Zoom	Magnifies or reduces the projected image. See "Magnifying and searching for details" on page 27 for details.
3D Sync	<p>This projector features a 3D function which enables you to enjoy the 3D movies, videos, and sporting events in a more realistic way by presenting the depth of the images. You need to wear a pair of 3D glasses to view the 3D images.</p> <ul style="list-style-type: none"> For a PC type signal: When the vertical frequency is 60Hz or 120Hz, and the content being projected is made with 3D technology, selecting On will present the 3D images. For a video type signal: When the content being projected is made with 3D technology, selecting On will present the 3D images. <p> When the 3D Sync function is On:</p> <ul style="list-style-type: none"> The brightness level of the projected image will decrease. The Picture Mode cannot be adjusted. The Keystone can only be adjusted within limited degrees.
3D Sync Invert	When you discover the inversion of the image depth, enable this function to correct the problem.

Function	Description
1. DISPLAY menu Teaching Template	<p>Provides several preset patterns for various teaching purposes.</p> <p>Choose Blackboard or Whiteboard first by pressing ▲/ ▼ and press ◀/▶ to choose the pattern you need. Press MODE/ENTER to activate the pattern.</p>
2. PICTURE menu	Picture Mode Pre-defined picture modes are provided so you can optimize your projector image set-up to suit your program type. See " Selecting a picture mode " on page 29 for details.
	Reference Mode Selects a picture mode that best suits your need for the image quality and further fine-tune the image based on the selections listed on the same page below. See " Setting the User 1/User 2 mode " on page 29 for details.
	Brightness Adjusts the brightness of the image. See " Adjusting Brightness " on page 30 for details.
	Contrast Adjusts the degree of difference between dark and light in the image. See " Adjusting Contrast " on page 30 for details.
	Color Adjusts the color saturation level -- the amount of each color in a video image. See " Adjusting Color " on page 30 for details.  This function is only available when a Video, S-Video or Component Video signal is selected.
	Tint Adjusts the red and green color tones of the image. See " Adjusting Tint " on page 30 for details.  This function is only available when a Video or S-Video signal is selected and the system format is NTSC.
	Sharpness Adjusts the image to make it look sharper or softer. See " Adjusting Sharpness " on page 30 for details.  This function is only available when a Video, S-Video or Component Video signal is selected.
	Brilliant Color See " Adjusting Brilliant Color " on page 30 for details.
	Color Temperature There are four color temperature settings available. See " Selecting a color temperature " on page 30 for details.
	3D Color Management See " 3D Color Management " on page 31 for details.
Save Settings Saves the settings made for User 1 or User 2 mode.	

Function	Description
3. SOURCE menu Quick Auto Search	See " Switching input signal " on page 26 for details.
Presentation Timer	Reminds the presenter to finish the presentation within a certain time frame. See " Setting the presentation timer " on page 32 for details.
Language	Sets the language for the On-Screen Display (OSD) menus. See " Using the menus " on page 23 for details.
Projector Position	The projector can be installed on a ceiling or behind a screen, or with one or more mirrors. See " Choosing a location " on page 14 for details.
4. SYSTEM SETUP: Basic menu Menu Settings	Menu Display Time Sets the length of time the OSD will remain active after your last key press. The range is from 5 to 30 seconds in 5-second increments. Menu Position Sets the On-Screen Display (OSD) menu position. Reminder Message Sets the reminder messages on or off.
Operation Settings	Direct Power On Allows the projector to turn on automatically once the power is fed through the power cord. Auto Power Off Allows the projector to turn off automatically if no input signal is detected after a set period of time. See " Setting Auto Power Off " on page 61 for details. Blank Timer Sets the image blank time when the Blank feature is activated, once elapsed the image will return to the screen. See " Hiding the image " on page 33 for details. Sleep Timer Sets the auto-shutdown timer. The timer can be set to a value between 30 minutes and 12 hours.

	Function	Description
4. SYSTEM SETUP: Basic menu	Panel Key Lock	Disables or enables all panel key functions except  POWER on the projector and keys on the remote control. See " Locking control keys " on page 34 for details.
	Background Color	Sets the background color for the projector.
	Splash Screen	Allows you to select which logo screen will display during projector start-up. The following options are available: BenQ logo, My Screen, Black screen, Blue screen.
	MyScreen	Captures and stores the projected picture as My Screen. See " Creating your own startup screen " on page 34 for details.  In the unlikely event that the capturing action fails, change your target picture.
5. SYSTEM SETUP: Advanced menu	Quick Cooling	Enables or disables the Quick Cooling function. Selecting On enables the function and projector cooling time will be shortened from a normal 90-second duration to approximately 30 seconds.
	High Altitude Mode	A mode for operation in high altitude areas. See " Operating in a high altitude environment " on page 34 for details.
	Audio Settings	Mute Volume Microphone Volume Power On/Off Ring Tone See " Adjusting the sound " on page 35 for details.
	Lamp Settings	Lamp Mode See " Setting Lamp Mode as Economic " on page 61 for details. Reset lamp timer See " Resetting the lamp timer " on page 65 for details. Equivalent Lamp Hour See " Getting to know the lamp hour " on page 61 for details on how the total lamp hour is calculated.
	Security Settings	Change Password You will be asked to enter the current password before changing to a new one. See " Utilizing the password function " on page 24 for details. Change Security Settings Power On Lock Splash Screen Lock See " Utilizing the password function " on page 24 for details.

Function	Description
5. SYSTEM SETUP: Advanced menu	<p>Baud Rate</p> <p>Selects a baud rate that is identical with your computer's so that you can connect the projector using a suitable RS-232 cable and update or download the projector's firmware. This function is intended for qualified service personnel.</p>
	<p>Test Pattern</p> <p>Selecting On enables the function and the projector displays the grid test pattern. It helps you adjust the image size and focus and check that the projected image is free from distortion.</p>
	<p>Closed Caption</p> <p>Closed Caption Enable Activates the function by selecting On when the selected input signal carries closed captions.</p> <ul style="list-style-type: none"> • Captions: An on-screen display of the dialogue, narration, and sound effects of TV programs and videos that are closed captioned (usually marked as "CC" in TV listings). <p> Set your screen aspect ratio to 4:3. This function is not available when the aspect ratio is "16:9" or "Real".</p> <p>Caption Version Selects a preferred closed captioning mode. To view captions, select CC1, CC2, CC3, or CC4 (CC1 displays captions in the primary language in your area).</p>
	<p>Standby Settings</p> <p>Network Selecting On enables the function. The projector is able to provide the network function when it is in standby mode.</p> <p>Microphone Selecting On enables the function. The projector can output the microphone signal when it is in standby mode and all the necessary equipment is correctly connected. See "Playing sound through the projector" on page 18 for details.</p> <p>Monitor Out Selecting On enables the function. The projector can output a VGA signal when it is in standby mode and the COMPUTER 1 jack is correctly connected to devices. See "Connection" on page 16 for how to make the connection.</p> <p> Enabling this function slightly increases the standby power consumption.</p>
	<p>Network Settings</p> <p>Wired LAN Wireless LAN Remote Desktop</p> <p>See "Controlling the projector through a LAN environment" on page 36 for details.</p>
	<p>Reset All Settings</p> <p>Returns all settings to the factory preset values.</p> <p> The following settings will still remain: Phase, H. Size, User 1, User 2, Language, Projector Position, High Altitude Mode, Security Settings, Remote Receiver, DHCP, SSID, Remote Desktop and Baud Rate.</p>

Function	Description	
6. INFORMATION menu	FAQ-Image and Installation	Displays possible solutions to problems you may encounter.
	FAQ-Features and Service	
	Current System Status	<p>Source Shows the current signal source.</p> <p>Picture Mode Shows the selected mode in the PICTURE menu.</p> <p>Resolution Shows the native resolution of the input signal.</p> <p>Color System Shows input system format: NTSC, PAL, SECAM, YUV, or RGB.</p> <p>Equivalent Lamp Hour Displays the number of hours the lamp has been used.</p> <p>Firmware Version Shows the firmware version of your projector.</p>

Maintenance

Care of the projector

Your projector needs little maintenance. The only thing you need to do on a regular basis is to keep the lens and case clean.

Never remove any parts of the projector except the lamp. Contact your dealer if other parts need replacing.

Cleaning the lens

Clean the lens whenever you notice dirt or dust on the surface.

- Use a canister of compressed air to remove dust.
- If there is dirt or smears, use lens-cleaning paper or moisten a soft cloth with lens cleaner and gently wipe the lens surface.
- Never use any type of abrasive pad, alkaline/acid cleaner, scouring powder, or volatile solvent, such as alcohol, benzene, thinner or insecticide. Using such materials or maintaining prolonged contact with rubber or vinyl materials may result in damage to the projector surface and cabinet material.

Cleaning the projector case

Before you clean the case, turn the projector off using the proper shutdown procedure as described in "[Shutting down the projector](#)" on page 50 and unplug the power cord.

- To remove dirt or dust, wipe the case with a soft, lint-free cloth.
- To remove stubborn dirt or stains, moisten a soft cloth with water and a neutral pH detergent. Then wipe the case.

 **Never use wax, alcohol, benzene, thinner or other chemical detergents. These can damage the case.**

Storing the projector

If you need to store the projector for an extended time, please follow the instructions below:

- Make sure the temperature and humidity of the storage area are within the recommended range for the projector. Please refer to "[Specifications](#)" on page 68 or consult your dealer about the range.
- Retract the adjuster feet.
- Remove the batteries from the remote control.
- Pack the projector in its original packing or equivalent.

Transporting the projector

It is recommended that you ship the projector with its original packing or equivalent. When you carry the projector yourself, please use the original box.

Lamp information

Getting to know the lamp hour

When the projector is in operation, the duration (in hours) of lamp usage is automatically calculated by the built-in timer.

 See "**Setting Lamp Mode as Economic**" below for more information on **Economic mode**.

To obtain the lamp hour information:

1. Press **MENU/EXIT** and then press **◀/▶** to highlight the **SYSTEM SETUP: Advanced** menu.
2. Press **▼** to highlight **Lamp Settings** and press **MODE/ENTER**. The **Lamp Settings** page displays.
3. You will see the **Equivalent Lamp Hour** information displaying on the menu.
4. To leave the menu, press **MENU/EXIT**.

You can also get the lamp hour information on the **INFORMATION** menu.

Extending lamp life

The projection lamp is a consumable item that normally can last up to 3000-4000 hours with proper usage. To keep the lamp life as long as possible, you can do the following settings via the OSD menu.

- **Setting Lamp Mode as Economic**

Using **Economic** mode reduces system noise and power consumption by 20%. If the **Economic** mode is selected, the light output will be reduced and result in darker projected pictures.

Setting the projector in **Economic** mode also extends the lamp operation life. To set **Economic** mode, go into the **SYSTEM SETUP: Advanced > Lamp Settings > Lamp Mode** menu and press **◀/▶**.

- **Setting Auto Power Off**

This function allows the projector to turn off automatically if no input signal is detected after a set period of time to prevent unnecessary waste of lamp life.

To set **Auto Power Off**, go into the **SYSTEM SETUP: Basic > Operation Settings > Auto Power Off** menu and press **◀/▶**. The time period can be set from 5 to 30 minutes in 5-minute increments. If the preset time lengths are not suitable for your presentation, select **Disable**. The projector will not automatically shut down in a certain time period.



Timing of replacing the lamp

When the **Lamp indicator** lights up red or a message appears suggesting it is time to replace the lamp, please install a new lamp or consult your dealer. An old lamp may cause a malfunction in the projector and in some instances the lamp may explode.

Go to <http://lamp.benq.com> for a replacement lamp.

 **The LAMP indicator light and TEMPerature warning light will light up if the lamp becomes too hot. Turn the power off and let the projector cool for 45 minutes. If the Lamp or Temp indicator still lights up after turning the power back on, please contact your dealer. See "Indicators" on page 66 for details.**

The following Lamp warning displays will remind you to change the lamp.

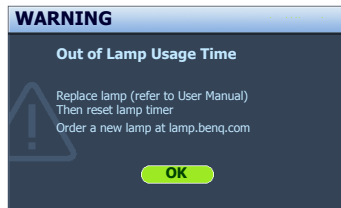
Status	Message
<p>Install a new lamp for optimal performance. If the projector is normally run with Economic selected (See "Getting to know the lamp hour" on page 61), you may continue to operate the projector until the next hour lamp warning appears.</p> <p>Press ENTER to dismiss the message.</p>	
<p>It is strongly recommended that you replace the lamp at this age. The lamp is a consumable item. The lamp brightness diminishes with use. This is normal lamp behavior. You can replace the lamp whenever you notice that the brightness level has significantly diminished.</p> <p>Press ENTER to dismiss the message.</p>	
<p>The lamp MUST be replaced before the projector will operate normally.</p> <p>Press ENTER to dismiss the message.</p>	

 "XXXX" shown in the above messages are numbers that vary depending on different models.

Replacing the lamp



- To reduce the risk of electrical shock, always turn the projector off and disconnect the power cord before changing the lamp.
- To reduce the risk of severe burns, allow the projector to cool for at least 45 minutes before replacing the lamp.
- To reduce the risk of injuries to fingers and damage to internal components, use caution when removing lamp glass that has shattered into sharp pieces.
- To reduce the risk of injuries to fingers and/or compromising image quality by touching the lens, do not touch the empty lamp compartment when the lamp is removed.
- This lamp contains mercury. Consult your local hazardous waste regulations to dispose of this lamp in a proper manner.
- To assure optimal performance from the projector, it is recommended that you purchase a qualified projector lamp for lamp replacement.
- If lamp replacement is performed while the projector is suspended upside-down from the ceiling, make sure that no one is underneath the lamp socket to avoid any possible injury or damage to the human eyes caused by fractured lamp.

1. Turn the power off and disconnect the projector from the power outlet. If the lamp is hot, avoid burns by waiting for approximately 45 minutes until the lamp has cooled.
2. Loosen the screws that secure the lamp cover on the side of the projector until the lamp cover loosens.

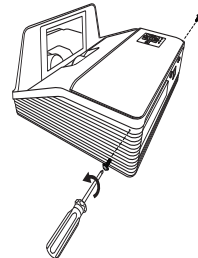

3. Remove the lamp cover from the projector.
4. Remove and dispose of the protection film.



- Do not turn the power on with the lamp cover removed.
- Do not insert your fingers between the lamp and the projector. The sharp edges inside the projector may cause injuries.

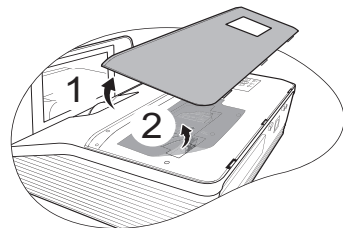

5. Disconnect the lamp connector from the projector as illustrated.
6. Loosen the screw that secures the lamp.

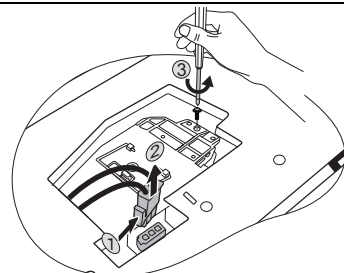

-
7. Lift the handle so that it stands up. Use the handle to slowly pull the lamp out of the projector.



- **Pulling it too quickly may cause the lamp to break and scatter broken glass in the projector.**
- **Do not place the lamp in locations where water might splash on it, children can reach it, or near flammable materials.**
- **Do not insert your hands into the projector after the lamp is removed. If you touch the optical components inside, it could cause color unevenness and distortion of the projected images.**

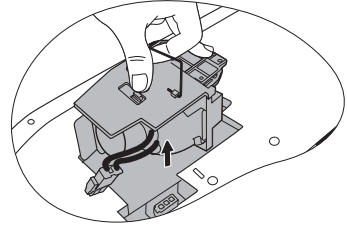

-
8. As shown in the figure, lower the new lamp.

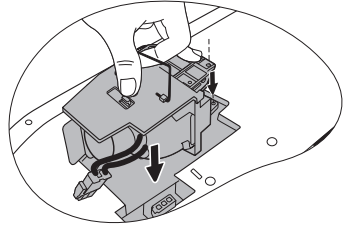

-
9. Reconnect the lamp connector.
10. Tighten the screw that secures the lamp.



- **Loose screw may cause a bad connection, which could result in malfunction.**
- **Do not over tighten the screw.**

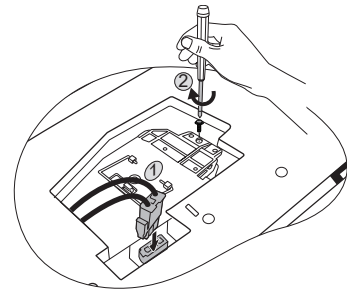

-
11. Ensure the handle is fully laid flat and locked in place.
12. Replace the lamp protection film that comes with the new lamp on the lamp compartment.
13. Replace the lamp cover on the projector.

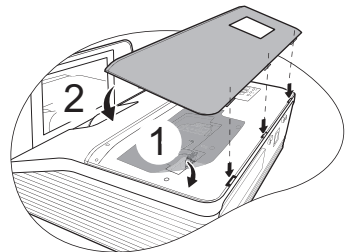

14. Tighten the screws that secure the lamp cover.



- **Loose screw may cause a bad connection, which could result in malfunction.**
- **Do not over tighten the screw.**

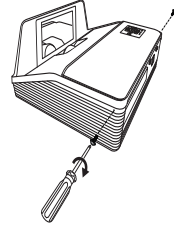

15. Connect the power and restart the projector.



Do not turn the power on with the lamp cover removed.



Resetting the lamp timer

16. After the startup logo, open the On-Screen Display (OSD) menu. Go to the **SYSTEM SETUP: Advanced > Lamp Settings** menu. Press **MODE/ENTER**. The **Lamp Settings** page displays. Highlight **Reset lamp timer**. A warning message displays asking if you want to reset the lamp timer. Highlight **Reset** and press **MODE/ENTER**. The lamp time will be reset to "0".



Do not reset if the lamp is not new or replaced as this could cause damage.

Indicators

Light			Status & Description
POWER 	TEMP 	LAMP 	
Power events			
Orange	Off	Off	Stand-by mode.
Green Flashing	Off	Off	Powering up.
Green	Off	Off	Normal operation.
Orange Flashing	Off	Off	<ul style="list-style-type: none"> The projector needs 90 seconds to cool down as it was abnormally shut down without the normal cooling down process. The projector needs to cool for 90 seconds after the power is turned off. The projector has shut down automatically. If you try to re-start the projector, it will shut down again. Please contact your dealer for assistance.
Lamp events			
Orange Flashing	Off	Red	The projector has shut down automatically. If you try to re-start the projector, it will shut down again. Please contact your dealer for assistance.
Off	Off	Red	<ol style="list-style-type: none"> The projector needs 90 seconds to cool down. Or Please contact your dealer for assistance.
Thermal events			
Off	Red	Off	The projector has shut down automatically. If you try to re-start the projector, it will shut down again. Please contact your dealer for assistance.
Off	Red	Red	
Off	Red	Green	
Off	Red	Orange	
Red	Red	Red	
Red	Red	Green	
Red	Red	Orange	
Green	Red	Red	
Green	Red	Green	
Green	Red	Orange	
Orange	Red	Red	
Orange	Red	Green	
Orange	Red	Orange	
Off	Green	Red	
Off	Green	Green	

Troubleshooting

② The projector does not turn on.

Cause	Remedy
There is no power from the power cord.	Plug the power cord into the AC power jack on the projector, and plug the power cord into the power outlet. If the power outlet has a switch, make sure that it is switched on.
Attempting to turn the projector on again during the cooling process.	Wait until the cooling down process has completed.

② No picture

Cause	Remedy
The video source is not turned on or connected correctly.	Turn the video source on and check that the signal cable is connected correctly.
The projector is not correctly connected to the input signal device.	Check the connection.
The input signal has not been correctly selected.	Select the correct input signal with the SOURCE key on the projector or remote control.
The lens cover is still closed.	Open the lens cover.

② Blurred image

Cause	Remedy
The projection lens is not correctly focused.	Adjust the focus of the lens using the focus ring.
The projector and the screen are not aligned properly.	Adjust the projection angle and direction as well as the height of the projector if necessary.
The lens cover is still closed.	Open the lens cover.

② Remote control does not work

Cause	Remedy
The batteries are out of power.	Replace the batteries with new ones.
There is an obstacle between the remote control and the projector.	Remove the obstacle.
You are too far away from the projector.	Stand within 8 meters (26 feet) of the projector.

② The password is incorrect

Cause	Remedy
You do not remember the password.	Please see "Entering the password recall procedure" on page 25 for details.

Specifications

Projector specifications

 All specifications are subject to change without notice.

Optical

Resolution
1024 x 768 XGA

Display system
1-CHIP DMD

Lens F/Number
F = 2.6

Lamp
230 W lamp

Electrical

Power supply
AC100–240V, 3.70 A, 50-60 Hz (Automatic)

Power consumption
380 W (Max); < 1 W (Standby)

Mechanical

Weight
5.8 Kg (12.78 lbs)

Output terminals

RGB output
D-Sub 15-pin (female) x 1

Speaker
(Stereo) 10 watt x 2

Audio signal output
PC audio jack x 1

Control

RS-232 serial control
9 pin x 1

Lan control
RJ45 x 1

IR receiver x 1

12V trigger x 1 (Max. 1A)

Input terminals

Computer input
RGB input
D-Sub 15-pin (female) x 2

Video signal input
S-VIDEO
Mini DIN 4-pin port x 1

VIDEO
RCA jack x 1

SD/HDTV signal input
Analog - Component RCA jack x 3
(through RGB input)

Audio signal input
Audio in
PC audio jack x 1
RCA audio jack (L/R) x 2
Microphone x 1

USB ports (Type-A x 1; Mini-B x 1)

Environmental Requirements

Operating temperature
0°C–40°C at sea level

Operating relative humidity
10%–90% (without condensation)

Operating altitude
0–1499 m at 0°C–35°C
1500–3000 m at 0°C–30°C (with
High Altitude Mode on)

Dimensions

404 mm (W) x 229 mm (H) x 324.3 mm (D)

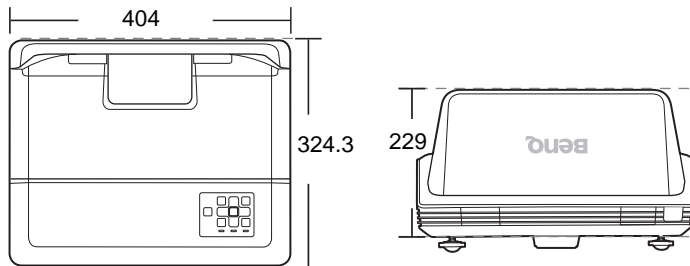

Wall mount installation

Wall Mount
screw: M4 x 8
(Max L = 8 mm)

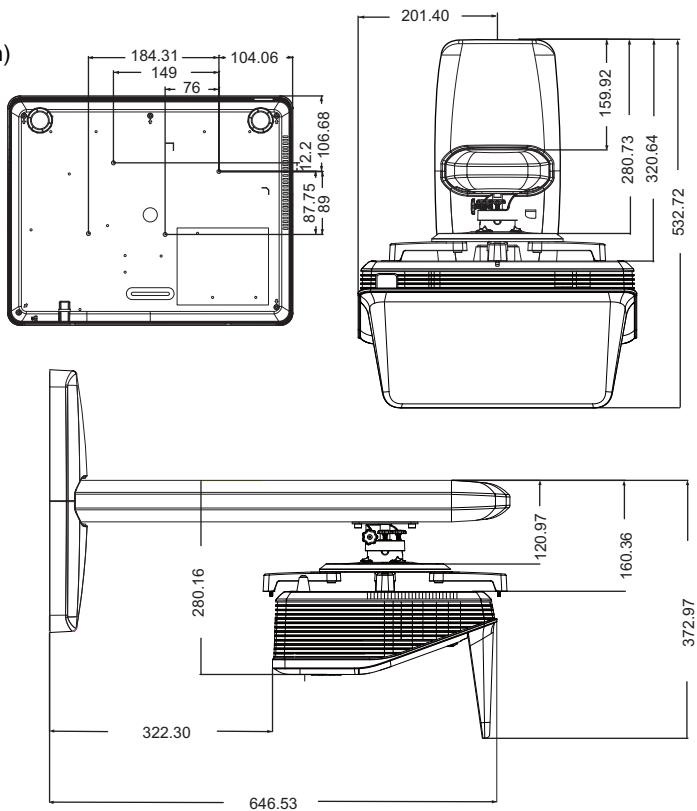

Unit: mm

Timing chart

Supported timing for PC input

Resolution	Mode	Vertical Frequency (Hz)	Horizontal Frequency (kHz)	Pixel Frequency (MHz)
640 x 480	VGA_60*	59.940	31.469	25.175
	VGA_72	72.809	37.861	31.500
	VGA_75	75.000	37.500	31.500
	VGA_85	85.008	43.269	36.000
720 x 400	VGA_70	70.087	31.469	28.3221
800 x 600	SVGA_60*	60.317	37.879	40.000
	SVGA_72	72.188	48.077	50.000
	SVGA_75	75.000	46.875	49.500
	SVGA_85	85.061	53.674	56.250
1024 x 768	XGA_60*	60.004	48.363	65.000
	XGA_70	70.069	56.476	75.000
	XGA_75	75.029	60.023	78.750
	XGA_85	84.997	68.667	94.500
1024 x 576	BenQ	60.0	35.820	46.966
1024 x 600	BenQ	64.995	41.467	51.419
1280 x 800	WXGA_60*	59.810	49.702	83.500
	WXGA_75	74.934	62.795	106.500
	WXGA_85	84.880	71.554	122.500
1280 x 1024	SXGA_60*	60.020	63.981	108.000
	SXGA_75	75.025	79.976	135.000
	SXGA_85	85.024	91.146	157.500
1280 x 960	1280 x 960_60*	60.000	60.000	108.000
	1280 x 960_85	85.005	85.938	148.500
1440 x 900	WXGA+_60*	59.887	55.935	106.500
1440 x 1050	SXGA+_60*	59.978	65.317	121.750
1600 x 1200	UXGA	60.000	75.000	162.000
640 x 480@67Hz	MAC13	66.667	35.000	30.240
832 x 624@75Hz	MAC16	74.546	49.722	57.280
1024 x 768@75Hz	MAC19	75.020	60.241	80.000
1152 x 870@75Hz	MAC21	75.060	68.680	100.000
640 x 480	VGA_120*	119.518	61.910	52.500
800 x 600	SVGA_120*	119.854	77.425	83.000
1024 x 768	XGA_120*	119.989	97.551	115.5
800 x 600	VESA DMT0D 120	119.972	76.305	73.25

 *Supported timing for 3D function.

Supported timing for Component-YPbPr input

Timing	Resolution	Vertical Frequency (Hz)	Horizontal Frequency (kHz)	Pixel Frequency (MHz)
480i	720 x 480	59.94/60	15.734/15.75	13.5
480p	720 x 480	59.94/60	31.467/31.5	27
576i	720 x 576	50	15.625	13.5
576p	720 x 576	50	31.25	27
720/50p	1280 x 720	50	37.5	74.25
720/60p	1280 x 720	59.939/60	44.955/45	74.175/74.25
1080/50i	1920 x 1080	50	28.125	74.25
1080/60i	1920 x 1080	59.939/60	33.716/33.75	74.175/74.25
1080/50P	1920 x 1080	50	56.25	148.5
1080/60P	1920 x 1080	59.939/ 60	67.432/67.5	148.35/148.5
1080/24P	1920 x 1080	24	27.00	74.25
1080/25P	1920 x 1080	25	28.125	74.25
1080/30P	1920 x 1080	30	33.75	74.25

 Displaying a 1080i(1125i)@60Hz or 1080i(1125i)@50Hz signal may result in slight image vibration.

Supported timing for Video and S-Video inputs

Video mode	Horizontal Frequency (kHz)	Vertical Frequency (Hz)	Color sub-carrier Frequency (MHz)
NTSC*	15.73	60	3.58
PAL	15.63	50	4.43
SECAM	15.63	50	4.25 or 4.41
PAL-M	15.73	60	3.58
PAL-N	15.63	50	3.58
PAL-60	15.73	60	4.43
NTSC4.43*	15.73	60	4.43

 *Supported timing for 3D function.

Warranty and Copyright information

Limited warranty

BenQ warrants this product against any defects in material and workmanship, under normal usage and storage.

Proof of purchase date will be required with any warranty claim. In the event this product is found to be defective within the warranty period, BenQ's only obligation and your exclusive remedy shall be replacement of any defective parts (labor included). To obtain warranty service, immediately notify the dealer from which you purchased the product of any defects.

Important: The above warranty shall be void if the customer fails to operate the product in accordance with BenQ's written instructions, especially the ambient humidity must be in-between 10% and 90%, temperature in-between 0°C and 35°C, altitude lower than 4920 feet, and avoiding to operate the projector in a dusty environment. This warranty gives you specific legal rights, and you may have other rights which vary from country to country.

For other information, please visit www.BenQ.com.

Copyright

Copyright 2010 by BenQ Corporation. All rights reserved. No part of this publication may be reproduced, transmitted, transcribed, stored in a retrieval system or translated into any language or computer language, in any form or by any means, electronic, mechanical, magnetic, optical, chemical, manual or otherwise, without the prior written permission of BenQ Corporation.

Disclaimer

BenQ Corporation makes no representations or warranties, either expressed or implied, with respect to the contents hereof and specifically disclaims any warranties, merchantability or fitness for any particular purpose. Further, BenQ Corporation reserves the right to revise this publication and to make changes from time to time in the contents hereof without obligation to notify any person of such revision or changes.

*DLP, Digital Micromirror Device and DMD are trademarks of Texas Instruments. Others are copyrights of their respective companies or organizations.

Patents

This BenQ projector is covered by the following patents:

U.S. patents 6,837,608; 7,275,834; 7,181,318. TW patents 202690; 205470; I228635; I259932.

China patents (中国发明专利) ZL01143168.7; ZL03119907.0; ZL200510051609.2

Regulation statements

FCC statement (for United States users)

CLASS B: This equipment generates, uses and can radiate radio frequency energy and, if not installed and used in accordance with the instructions, may cause harmful interference to radio communications. However, there is no guarantee that interference will not occur in a particular installation. If this equipment does cause harmful interference to radio or television reception, which can be determined by turning the equipment off and on, the user is encouraged to try to correct the interference by one or more of the following measures:

- Reorient or relocate the receiving antenna.
- Increase the distance between the equipment and receiver.
- Connect the equipment into an outlet on a circuit different from that to which the receiver is connected.
- Consult the dealer or an experienced radio/TV technician for help.

EEC statement (for European users)

This device complies with the requirements set out in the Council Directives on the Approximation of the Laws of the Member States relating Electromagnetic Compatibility (2004/108/EC), Low Voltage Directive (2006/95/EC), the Restriction of The Use of Certain Hazardous Substances in Electrical And Electronic Equipment Directive (2002/95/EC), Turkish EEE Directive, Commission Regulation (EC) No 1275/2008 implementing Directive 2005/32/EC of the European Parliament and of the Council with regard to ecodesign requirements for standby and off mode electric power consumption of electrical and electronic household and office equipment, and the Directive 2009/125/EC of the European parliament and of the council establishing a framework for the setting of ecodesign requirements for energy-related products.

WEEE directive

Disposal of Waste Electrical and Electronic Equipment by users in private households in the European Union.

This symbol on the product or on the packaging indicates that this can not be disposed of as household waste. You must dispose of your waste equipment by handing it over to the applicable take-back scheme for the recycling of electrical and electronic equipment. For more information about recycling of this equipment, please contact your city office, the shop where you purchased the equipment or your household waste disposal service. The recycling of materials will help to conserve natural resources and ensure that it is recycled in a manner that protects human health and environment.



Accessibility Requirements for Rehabilitation Act of 1973, Section 508

BenQ's commitment to accessible products allows us to support government in making accessible technology choices. BenQ's LCD monitors and projectors are compliant with Section 508 guidelines by including the assistive features as below:

- BenQ's monitors have colored "Power" indicators. While the indicator shows green, it means that the monitor is using the full power. While the indicator shows yellow or amber, it means that the monitor is in suspend or sleep mode and is using less than 2 watts of electricity.
- BenQ's monitors have a variety of settings of pre-programmed flicker-free timing to make the screen shown on the monitor readily accessible. The default timing setting is automatically turned on every time the monitor is powered up, and thus reduces the hassle of user intervention.
- BenQ's monitors and projectors have options for brightness and contrast adjustments that text and images could be displayed differently to meet the demands of the visually impaired. Other similar adjustments are also available by using the On-Screen Display (OSD) controls on the products.
- BenQ's monitors and projectors include user-selectable color controls, such as color temperature selections (Monitor: 5800K, 6500K and 9300K, Projector: 5500K, 6500K, 7500K and 9300K), with a wide range of contrast levels.
- BenQ's multimedia monitors and projectors usually have one or two speakers for audio performance which allow users (including hearing impaired) to interact with the computer systems connected. Speaker controls are typically located on the front-panel.
- Firmware of BenQ's monitors and projectors contain unique product information that helps computer systems to identify BenQ products and activate their Plug-and-Play function when connected.
- All BenQ's monitors and projectors are compatible with the PC99 standard. For example, connectors are color-coded to help users easily connecting products to computer systems correctly.
- Some models of BenQ's monitors and projectors contain additional USB and DVI ports for connection to more devices such as a special headphone to assist the hearing impaired.
- All BenQ monitors and projectors come with user manuals on compact discs which could be easily read by commercial software such as Adobe Reader via a connected computer system. These documents are also available on the BenQ's web site (www.BenQ.com). Other types of documents may be available upon requests.
- BenQ's customer service provides answers and assistance to all our customers through phone calls, facsimiles, e-mails, or web sites.

Free Manuals Download Website

<http://myh66.com>

<http://usermanuals.us>

<http://www.somanuals.com>

<http://www.4manuals.cc>

<http://www.manual-lib.com>

<http://www.404manual.com>

<http://www.luxmanual.com>

<http://aubethermostatmanual.com>

Golf course search by state

<http://golfingnear.com>

Email search by domain

<http://emailbydomain.com>

Auto manuals search

<http://auto.somanuals.com>

TV manuals search

<http://tv.somanuals.com>