

USER'S MANUAL

AXIS P7701 Video Decoder



About this Document

This manual is intended for administrators and users of the AXIS P7701 Video Decoder, and is applicable for firmware release 5.07 and later. It includes instructions for using and managing the decoder on your network. Previous experience of networking will be of use when using this product. Some knowledge of UNIX or Linux-based systems may also be beneficial, for developing shell scripts and applications. Later versions of this document will be posted to the Axis Website, as required. See also the product's online help, available via the web-based interface.

Liability

Every care has been taken in the preparation of this document. Please inform your local Axis office of any inaccuracies or omissions. Axis Communications AB cannot be held responsible for any technical or typographical errors and reserves the right to make changes to the product and manuals without prior notice. Axis Communications AB makes no warranty of any kind with regard to the material contained within this document, including, but not limited to, the implied warranties of merchantability and fitness for a particular purpose. Axis Communications AB shall not be liable nor responsible for incidental or consequential damages in connection with the furnishing, performance or use of this material. This product is only to be used for its intended purpose.

Intellectual Property Rights

Axis AB has intellectual property rights relating to technology embodied in the product described in this document. In particular, and without limitation, these intellectual property rights may include one or more of the patents listed at <http://www.axis.com/patent.htm> and one or more additional patents or pending patent applications in the US and other countries.

This product contains licensed third-party software. See the menu item "About" in the product's user interface for more information.

This product contains source code copyright Apple Computer, Inc., under the terms of Apple Public Source License 2.0 (see www.opensource.apple.com/apsl). The source code is available from <https://developer.apple.com/bonjour/>

Equipment Modifications

This equipment must be installed and used in strict accordance with the instructions given in the user documentation. This equipment contains no user-serviceable components. Unauthorized equipment changes or modifications will invalidate all applicable regulatory certifications and approvals.

Trademark Acknowledgments

Apple, Boa, Bonjour, Ethernet, Internet Explorer, Linux, Microsoft, Mozilla, Netscape Navigator, OS/2, Real, QuickTime, UNIX, Windows, WWW are registered trademarks of the respective holders. Java and all Java-based trademarks and logos are trademarks or registered trademarks of Sun Microsystems, Inc. in the United States and other countries. Axis Communications AB is independent of Sun Microsystems Inc. UPnP™ is a certification mark of the UPnP™ Implementers Corporation.

Support

Should you require any technical assistance, please contact your Axis reseller. If your questions cannot be answered immediately, your reseller will forward your queries through the appropriate channels to ensure a rapid response. If you are connected to the Internet, you can:

- download user documentation and firmware updates
- find answers to resolved problems in the FAQ database. Search by product, category, or phrases
- report problems to Axis support by logging in to your private support area
- visit Axis Support at www.axis.com/techsup

Contents

AXIS P7701 Video Decoder	4
Key features	4
Hardware overview	5
Unit connectors	6
LED indicators	7
Accessing the Video Decoder	8
Access from a browser	8
Setting the root password	9
Access from the internet	9
Video Sources	10
Adding a video source	10
Status	13
Video & Audio	14
General Setup	14
System Options	16
Security	16
Date & Time	16
Network	17
COM Port	21
Maintenance	21
Support	21
About	22
Sequence Mode	23
Auto sequence mode	23
Manual sequence mode	23
Alarms	24
Setting up alarms	24
Notification syntax	25
Resetting to Factory Default Settings	26
Troubleshooting	27
Checking the Firmware	27
Upgrading the Firmware	27
Technical Specifications for AXIS P7701	29
General performance considerations	30
Glossary of Terms	31
Index	37

AXIS P7701 Video Decoder

AXIS P7701 Video Decoder provides a simple monitoring solution by enabling analog or digital monitors to connect to and display live video from Axis network cameras and video encoders. AXIS P7701 is ideal for use with a public view monitor, and in large and small surveillance systems.

AXIS P7701 can decode full frame rate video streams in H.264 and MPEG-4 in all resolutions up to D1 (720x480 pixels in NTSC, 720x576 in PAL). Motion JPEG can be decoded in all resolutions up to 720p (1280x720).

AXIS P7701 can display video in resolutions up to 1280x720 pixels with its DVI output. The DVI interface is compatible with monitors with a digital or analog DVI input, and with VGA and HDMI monitors with the use of appropriate adaptors. On its composite video output, AXIS P7701 can display video up to D1 resolution. The audio out interface of AXIS P7701 supports the output of audio decoded from the AAC, G.726 or G.711 input formats.

Through an RS-422/RS-485 serial port, AXIS P7701 allows serial commands to be sent to legacy equipment used in a surveillance system.

An unlimited number of video sources can be shown in sequence. With auto-connect on alarm, AXIS P7701 can automatically display alarm-triggered video.

The decoder can be powered using Power over Ethernet (PoE), which simplifies installation. An external power supply can also be used.

In situations where only live video display is required—such as with a public view monitor at a store entrance, AXIS P7701 offers a more cost-effective solution than using a PC for connecting a monitor. AXIS P7701 can also complement a video management system by helping to offload the main server from decoding digital streams simply for display purposes.

Key features

- **Full frame rate decoding of H.264, MPEG-4 and Motion JPEG**
AXIS P7701 can decode H.264 and MPEG-4 at 30/25 (NTSC/PAL) fps in all resolutions up to D1 (720x480 pixels in NTSC, 720x576 pixels in PAL). It can decode Motion JPEG in all resolutions up to 720p (1280x720 pixels).
- **High-quality digital video using DVI interface**
Video can be digitally output in resolutions up to 1280 x 720 using the DVI interface. By using adaptors, monitors with either VGA or HDMI can be connected to AXIS P7701.
- **Analog output using composite video**
Composite video can be output at up to D1 (720x480 pixels in NTSC, 720x576 pixels in PAL) resolution via an RCA connector.
- **Sequence mode for multiple video sources**
Multiple video sources can be displayed in sequence, either manually or automatically. Video sources can also be auto connected when receiving an alarm.
- **High-quality audio**
AXIS P7701 can decode audio in AAC, G.726 or G.711 formats and output high quality analog audio.
- **Serial port communication**
Commands can be sent to surveillance equipment using the RS-422/485 serial port.
- **Advanced security and network management**
AXIS P7701 offers the highest degree of security, including user password, IP address filtering and reception of HTTPS encrypted video streams. AXIS P7701 has support for IP protocol version 6 in addition to the standard IPv4. IPv6 is a requirement in many large installations.

Hardware overview

Top view

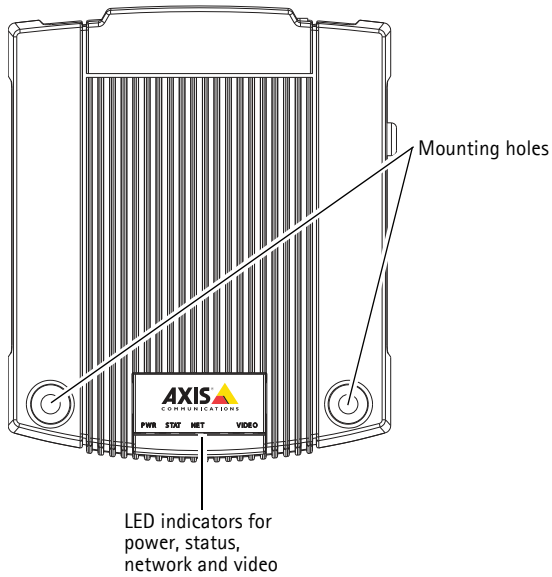

Rear view

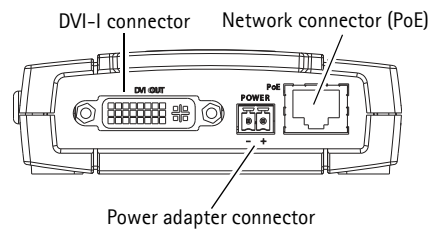

Audio, Video and I/O side view

RS-422/RS-485 connector

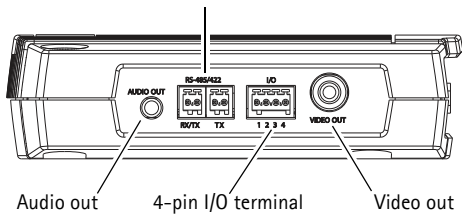

Control button side view

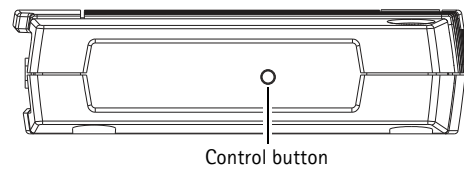

Dimensions

HxWxD = 33 x 99 x 118mm (1.3" x 3.9" x 4.7")
 Weight AXIS P7701 = 318g (0.7 lb) power supply excl.

Unit connectors

Network connector – RJ-45 Ethernet connector. Supports Power over Ethernet (PoE). Using shielded cables is recommended.

Power connector – 2-pin terminal block used for power input to the video decoder with the supplied power adapter or an external power supply 8-20V DC, max. 8.3 W.

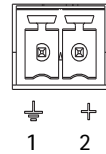

Function	Pin number	Description
GND	1	Ground
DC Power	2	Power input 8-20V DC, max 8.3W

Note:

Do not connect a power supply if the video decoder is connected to PoE.

Audio out – Audio output that can be connected to a public address (PA) system or an active speaker with a built-in amplifier. A pair of headphones can also be attached. A stereo connector must be used for the audio out.

DVI-I connector – The DVI-I connector has both analog and digital signals present simultaneously, so the DVI connector can be used to connect to a monitor with either digital or analog input.

For digital input, the DVI-I connector can also be used to connect the AXIS P7701 to a monitor with a DVI input, or to a monitor with a HDMI connector with the addition of a DVI-to-HDMI adapter.

The DVI connector can also be used with a DVI-to-VGA adapter to connect the AXIS P7701 to a monitor with a VGA analog input.

RCA connector – Standard phono-type connector for composite video in PAL or NTSC. Allows direct connection of an analog TV device.

Note:

If you connect the AXIS P7701 to a monitor using the RCA connector, you cannot use the DVI-I connector at the same time to connect to a second monitor.

I/O terminal connector – Used in applications for e.g. motion detection, event triggering, time lapse recording and alarm notifications. It provides the interface to:

- 1 digital input - For a video select button
- Auxiliary power and GND

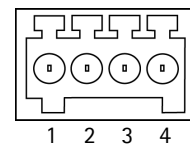

Function	Pin	Notes	Specifications
GND	1	Ground	
3.3V DC Power	2	Can be used to power auxiliary equipment. Note: This pin can <u>only</u> be used as power out.	Max. load = 250mA
Digital Input	3	Input for video select button.	
Unused	4	Unused	

Note:

The video switch is not part of the AXIS P7701, and there is currently no optional video switch available from Axis. However, it is possible for you to easily connect your own switch. See the connection diagram below..

The following connection diagram gives an example of how to connect an auxiliary device to the AXIS P7701.

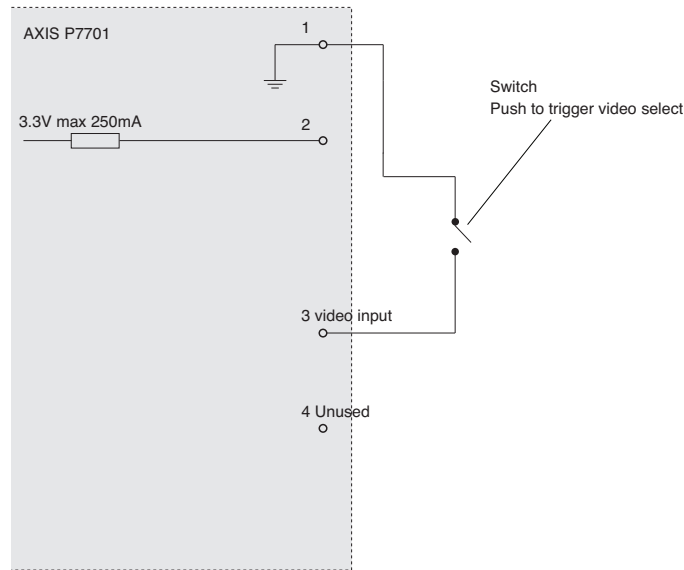

RS-422/RS-485 connector – Two 2-pin terminal blocks for RS-485/422 serial interface used to control auxiliary equipment, e.g. PTZ devices.

The RS-485/422 serial port can be configured to support:

- Two-wire RS-485 half duplex
- Four-wire RS-485 full duplex
- Two-wire RS422 simplex
- Four-wire RS422 full duplex point to point communication

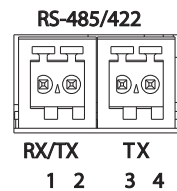

Function	Pin	Notes
RS-485/422 RX/TX A	1	(RX) For full duplex RS-485/422
RS-485/422 RX/TX B	2	(RX/TX) For half duplex RS-485
RS-485/422 TX A	3	(TX) For full duplex RS-485/422
RS-485/422 TX B	4	

LED indicators

LED	Color	Indication
Video	Green	Encoder/Camera is connected.
	Amber	Steady when connecting to an encoder/camera.
	Red	No encoder/camera is connected.
Network	Green	Steady for connection to a 100 Mbit/s network. Flashes for network activity.
	Amber	Steady for connection to 10 Mbit/s network. Flashes for network activity.
	Unlit	No network connection.
Status	Green	Steady green for normal operation.
	Amber	Steady during startup, during reset to factory default or when restoring settings.
	Red	Slow flash for failed upgrade.
Power	Green	Normal operation.
	Amber	Flashes green/amber during firmware upgrade.

Accessing the Video Decoder

To install this AXIS product, refer to the installation guide supplied with your product.

The video decoder can be used with most standard operating systems and browsers. The recommended browser is Microsoft Internet Explorer with Windows, Safari with Macintosh and Firefox with other operating systems. See *Technical Specifications for AXIS P7701*, on page 29.

Access from a browser

1. Start a browser (Internet Explorer, Firefox, Safari).
2. Enter the IP address or host name of the decoder in the **Location/Address** field of your browser.
To access the decoder from a Macintosh computer (Mac OSX), click on the Bonjour tab and select your AXIS product from the drop-down list (the Bonjour tab is only available in Safari).
3. If this is the first time you are accessing the decoder, see *Setting the root password*, on page 9. Otherwise enter your user name and password, set by the administrator.
4. The decoder's **Basic Setup** page appears in your browser.

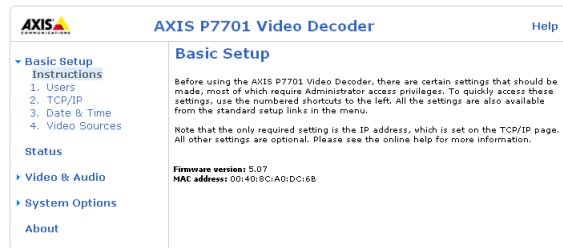

Setting the root password

1. When accessing the decoder for the first time, the **Configure Root Password** dialog appears.

Note:

Before you enter your password at this point, you can secure configuration of the root password via HTTPS by creating a self-signed certificate. To do so, click the **Create self-signed certificate...** button in the **Create Certificate** window.

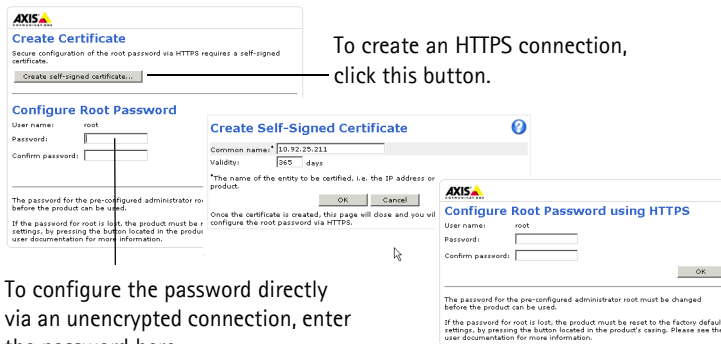

To configure the password directly via an unencrypted connection, enter the password here.

2. Enter a password and re-enter to confirm. Click **OK**. The **Enter Network Password** dialog appears.
3. Enter the password set in step 2, and click **OK**. If the password is lost, the decoder must be reset to the factory default settings. See page 23.

Note:

The default administrator user name 'root' is permanent and cannot be deleted.

Access from the internet

Once connected, the decoder is accessible on your local network (LAN). To access the decoder from the Internet you must configure your broadband router to allow incoming data traffic to the decoder. To do this, enable the NAT-traversal feature, which will attempt to automatically configure the router to allow access to the decoder. This is enabled from **System Options > Network > TCP/IP Advanced**.

For more information, please see *NAT traversal (port mapping) for IPv4*, on page 18. See also the **AXIS Internet Dynamic DNS Service** at www.axiscam.net For Technical notes on this and other topics, visit the Axis Support web at www.axis.com/techsup

Notes:

- HTTPS (Hypertext Transfer Protocol over SSL) is a protocol used to encrypt the traffic between web browsers and servers. The HTTPS certificate controls the encrypted exchange of information.
- The default administrator user **root** cannot be deleted.
- If the password for root is lost or forgotten, the video decoder must be reset to the factory default settings. See page 23.

Video Sources

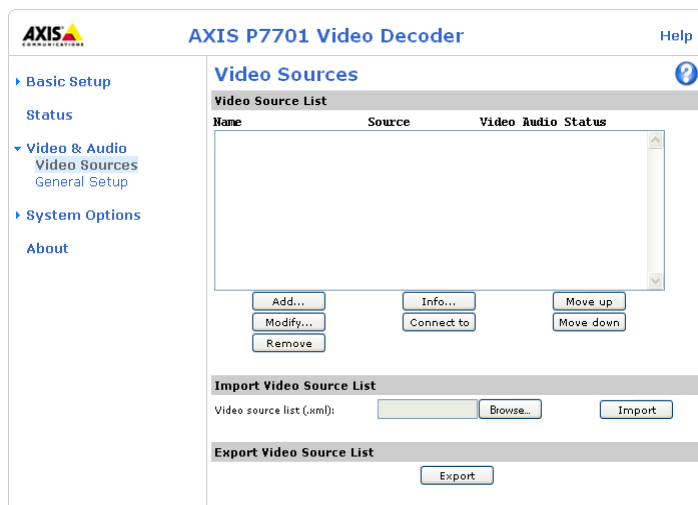

This section describes how to add and manage video sources (encoders and cameras) in the AXIS P7701 Network Video Decoder.

The Video Source List shows all of the sources currently added to the system. Various information about each source is shown, including the source's last known status.

A video source list can also be imported or exported.

Adding a video source

Click the **Add...** button to open the **Add Video Source** dialog.

When adding a new video source, ensure that it is correctly connected and powered up before attempting configuration. The following settings need to be made:

Name – Provide a unique name for the new video source.

Sequence mode – Select whether or not to include the video source in auto and/or manual sequence mode. If Auto is selected, also enter a Display time, to set how long the video source will be displayed for, before switching to the next source in the list. Note that if neither sequence mode is selected, the video source will only be displayed if the Connect to button in the video source list is clicked, or if an alarm triggers display of the source. See also page 14 for more information on sequence mode.

Video port number – Enter which video port on the video source should be accessed. Some different valid values are, for cameras 1, for video servers 1 to 4 or quad and for cameras supporting virtual image sources it is 1 to 8.

Http port – TCP/IP port to access http on video source.

Https port – TCP/IP port to access https on video source.

Transport method – Select which protocol to use for transport:

- Automatic
- RTSP unicast
- RTSP multicast
- RTSP tunnel
- HTTP
- HTTP RTSP tunnel
- HTTPS

Network settings

Address – Enter the IP address (or host name) of the video encoder or camera to add:

Example: 192.168.0.90

User Name and Password – If authentication is required by the video encoder or camera, enter the user name and password to access it.

Notes:

- Selecting a user with viewing rights only on the encoder or camera is recommended.
- The video encoder's or camera's home pages can be opened in your browser by clicking the provided button.

Video & audio settings

Stream profile – Some video encoders and cameras support multiple stream profiles. If this is available, select the profile to connect to. This value has no effect if the video encoder or camera only supports one stream profile.

Video type – Set the AXIS P7701 to automatically detect the video source format, or select the required format from the drop-down list. **Automatic** attempts to detect formats in the following order:

- H.264 RTP multicast
- H.264 RTP unicast
- H.264 RTP over RTSP
- H.264 RTP over RTSP over HTTP
- H.264 RTP over RTSP over HTTPS
- MPEG-4 RTP multicast
- MPEG-4 RTP unicast
- MPEG-4 RTP over RTSP
- MPEG-4 RTP over RTSP over HTTP
- MPEG-4 RTP over RTSP over HTTPS
- Motion JPEG
- Motion JPEG over HTTPS

Selecting **Automatic** is recommended in most cases, but there are exceptions. For example, if **Automatic** is selected and the video source supports **MPEG-4 Multicast**, then that format will automatically be selected. However, if the multicast data is not correctly routed, the video stream from the encoder or camera will not reach the AXIS P7701. In this case, the format should instead be set to **MPEG-4 unicast**.

As video sources are added to the AXIS P7701, they are stored in the decoder's cache. This makes reconnecting to a source much faster.

Notes:

- Performing certain actions will empty the unit's cache and start a new round of autodetection.
- When autodetect is used to connect to a new encoder or camera for the first time, the connection will take longer to complete.

Resolution – This setting is valid for firmware 5.xx for all codecs. To use a resolution other than the source's default value, select the custom radio button and enter the required resolution.

The resolutions available depend on the encoder or camera being used. Please see the encoder's or camera's online help for the available resolutions.

Compression – This setting is valid for firmware 5.xx for all codecs. To use a compression other than the source's default value, select the custom radio button and enter a compression value (0-100).

Audio – Select **Audio** to receive audio from the video source.

Preset position – If the video source has Pan/Tilt/Zoom capability, it is also possible to select a PTZ preset position view, by entering the name of the preset here. To add new preset positions, please refer to the manual for the video source. When you click **OK**, the PTZ device/camera should then move to the selected view.

Status

The **Status** page provides general status information, and also shows information on the video source currently connected to the AXIS P7701 Video Decoder. A list of recent log messages are displayed at the bottom of the page. For more information about log entries, please see the online help [?](#).

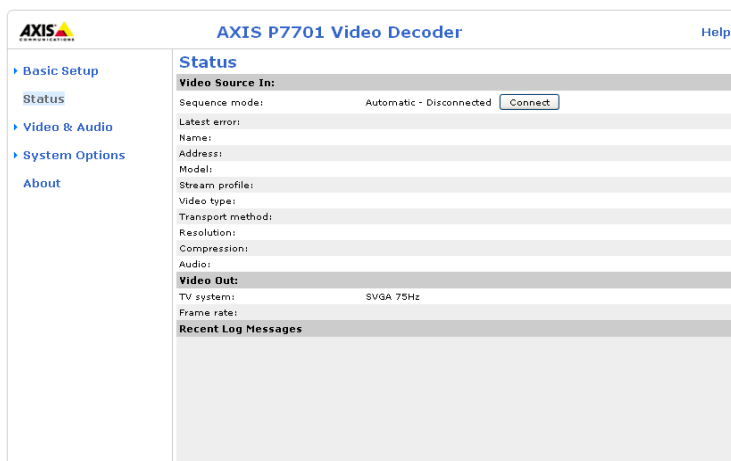

Video & Audio

General Setup

This page provides settings for configuring the start up mode, alarm notification, video and audio output.

General

The screenshot shows the 'General Setup' page for the AXIS P7701 Video Decoder. The page is divided into several sections:

- General:**
 - Connect at startup:
 - Automatic detection timeout: 10 [1..65536] (seconds)
 - Sequence mode: Automatic
 - Enable video select button:
- Alarms:**
 - Receive alarms:
 - Alarm display time: 30 [1..3600] (seconds)
 - Alarm port: 0 [0..65535] (0 = disabled)
- Video Out:**
 - Video output: VGA and DVI
 - TV system: SVGA 75Hz
 - Margin adjustment: 0 | **Screen** | 0 (pixels)
- Audio Out:**
 - Volume: 50 [0..100]

Buttons for 'Save' and 'Reset' are located at the bottom of the configuration area.

Connect at startup – When selected, the AXIS P7701 will automatically connect to the first video source in the video source list at startup. When unselected, it will stay disconnected and wait for user input or alarms.

Automatic detection timeout – This defines how long time the decoder will wait for a video source to respond before it goes to the next video source in the sequence.

Sequence mode – When set to **Automatic**, the AXIS P7701 automatically cycles through the video sources in the list on the **Video Sources** page. In **Manual** mode, the next source is displayed when the video select button is pressed. See page 14 for more information.

Video select button – Enables or disables the video select button.

Alarm

The AXIS P7701 can automatically switch to a video source that sends an alarm. See page 15 for more information.

Video Out

TV system – Select the TV system type to use. If you are using an analog monitor or television, most western European countries use the PAL system, whereas the system in the United States is NTSC. For digital monitors and HDMI ready televisions, the AXIS P7701 supports a resolution of up to 720p.

Consult the user documentation for your device to select a suitable resolution to set for **TV system**.

Video output – If you are using the RCA connector select **Composite**, otherwise select **VGA and DVI** if you are connecting your device to the AXIS P7701 via the DVI-I connector.

Margin adjustment - As video monitors often use too much of the available screen area, some parts of the monitored scene might not be visible. To correct this, the AXIS P7701 allows the margin to be adjusted on all 4 sides, so that the image is forced more towards the center of the screen. A margin is added by default, and values (number of TV-lines) in the following ranges are allowed:

- PAL - Vertical: 0 till 575, Horizontal: 0 till 719. The sum of the vertical values cannot exceed 575. The sum of the horizontal values cannot exceed 719.
- NTSC - Vertical: 0 till 479, Horizontal: 0 till 719. The sum of the vertical values cannot exceed 479. The sum of the horizontal values cannot exceed 719.

Audio out

Volume (0-100) - Set the level of the audio output on the AXIS P7701. The default value is 50. For more information see the online help 

System Options

Security

Change password

Enter a password for the administrator or root user, and then re-enter it to confirm the spelling. Click **OK**. The password has now been changed.

IP Address Filter

Enable IP Address Filtering to allow or deny access to the video decoder. Once enabled, the IP addresses in the list are allowed or denied access according to the choice made in the drop-down list **Allow/Deny the following IP addresses**.

The administrator can add up to 256 IP address entries to the list (a single entry can contain multiple IP addresses).

HTTPS

The video decoder supports encrypted browsing using HTTPS.

A **self-signed certificate** can be used until a Certificate Authority-issued certificate has been obtained. Click the **Create self-signed Certificate** button to install a self-signed certificate. Although self-signed certificates are free and offer some protection, true security is only implemented after the installation of a signed certificate issued by a certificate authority.

A signed certificate can be obtained from an issuing Certificate Authority by clicking the **Create Certificate Request** button. When the signed certificate is returned, click the **Install signed certificate** button to import the certificate. The properties of any certificate request currently resident in the decoder or installed can also be viewed by clicking the **Properties...** button. The **HTTPS Connection Policy** must also be set in the drop-down lists to enable HTTPS in the decoder.

For more information, please refer to the online help .

802.1X

IEEE 802.1X is an IEEE standard for port-based Network Admission Control. It provides authentication to devices attached to a network port (wired or wireless), establishing a point-to-point connection, or, if authentication fails, preventing access on that port. 802.1X is based on EAP (Extensible Authentication Protocol).

In a 802.1X enabled network switch, clients equipped with the correct software can be authenticated and allowed or denied network access at the Ethernet level.

Clients and servers in an 802.1X network may need to authenticate each other by some means. In the Axis implementation this is done with the help of digital certificates provided by a Certification Authority. These are then validated by a third-party entity, such as a RADIUS server, examples of which are Free Radius and Microsoft Internet Authentication Service.

To perform the authentication, the RADIUS server uses various EAP methods/protocols, of which there are many. The one used in the Axis implementation is EAPOL using EAP-TLS (EAP-Transport Layer Security).

The Axis network video device presents its certificate to the network switch, which in turn forwards this to the RADIUS server. The RADIUS server validates or rejects the certificate and responds to the switch, and sends its own certificate to the client for validation. The switch then allows or denies network access accordingly, on a preconfigured port.

Date & Time

Current Server Time – Displays the current date and time (24h clock).

New Server Time – Select your **time zone** from the drop-down list. If you want the server clock to automatically adjust for daylight savings time, select the **Automatically adjust for daylight saving time changes** option.

From the **Time Mode** section, select the preferred method to use for setting the time:

- **Synchronize with computer time** – sets the time from the clock on your computer.
- **Synchronize with NTP Server** – the decoder will obtain the time from an NTP server continuously.
- **Set manually** – this option allows you to manually set the time and date.

Note: If using a host name for the NTP server, a DNS server must be configured under **TCP/IP** settings. See **Network > Basic TCP/IP Settings** below.

Network

Basic TCP/IP Settings

Your Axis video decoder supports both IP version 4 and IP version 6. Both versions may be enabled simultaneously, and at least one version must always be enabled. When using IPv4, the IP address for the decoder can be set automatically via DHCP, or a static IP address can be set manually. If IPv6 is enabled, the video decoders receive an IP address according to the configuration in the network router. There are also options for setting up notification of changes in the IP address, and for using the AXIS Internet Dynamic DNS Service. For more information on setting the IP address, please see the online help .

Network Settings – Click the **View** button for an overview of the IP configuration of the video decoder.

IPv4 Address Configuration – Select the **Enable IPv4** box option to enable IPv4.

Obtain IP address via DHCP – Dynamic Host Configuration Protocol (DHCP) is a protocol that lets network administrators centrally manage and automate the assignment of IP addresses on a network. DHCP is enabled by default. Although a DHCP server is mostly used to set an IP address dynamically, it is also possible to use it to set a static, known IP address for a particular MAC address.

Note: DHCP should only be enabled if your DHCP server can update a DNS server, which then allows you to access the video decoder by name (host name). If DHCP is enabled and you cannot access the unit, run **AXIS IP Utility** to search the network for connected Axis products or reset the video decoder to factory default settings and then perform the installation again.

Use the following IP address – To use a static IP address for the video decoder, check the radio button and then make the following settings:

- **IP address** – Specify a unique IP address for your video decoder. (To check if the IP address you intend to use is available or not, click the **Test** button)
- **Subnet mask** – Specify the mask for the subnet the video decoder is located on
- **Default router** – Specify the IP address of the default router (gateway) used for connecting devices attached to different networks and network segments

IPv6 Address Configuration – Select the **Enable IPv6** box option to enable IPv6. Other settings for IPv6 are configured in the network router.

Services – Enable ARP/Ping setting of IP address – The IP address can be set using the ARP/Ping method, which associates the unit's MAC address with an IP address. Check this box to enable the service. Leave disabled to prevent unintentional resetting of the IP address.

Notes:

- The ARP/Ping service is automatically disabled two minutes after the unit is started, or as soon as an IP address is set. In order to reset the IP address, the decoder must be restarted to activate ARP/Ping for an additional two minutes.
- Pinging the unit is still possible when this service is disabled.

AXIS Internet Dynamic DNS Service – Use the **AXIS Internet Dynamic DNS** service to assign a host name for easy access to your video decoder (requires Internet access).

Click **System Options > Network > Basic > Settings...** to register the decoder with the Axis Internet Dynamic DNS service, or to modify the existing settings (requires access to the Internet). The domain name currently registered at the Axis Internet Dynamic DNS service for your product can at any time be removed.

For more information, please refer to the online help .

Advanced TCP/IP Settings

DNS Configuration – DNS (Domain Name Service) provides the translation of host names to IP addresses on your network.

Obtain DNS server address via DHCP – Automatically use the DNS server settings provided by the DHCP server. Click the **View** button to see the current settings.

Use the following DNS server address – Enter the desired DNS server by specifying the following:

Domain name – Enter the domain(s) to search for the host name used by the video decoders. Multiple domains can be separated by semicolons (;). The host name is always the first part of a Fully Qualified Domain Name, for example, **myserver** is the host name in the Fully Qualified Domain Name **myserver.mycompany.com** where **mycompany.com** is the Domain name.

Primary and Secondary DNS servers – Enter the IP addresses of the primary, and secondary DNS servers.

Note: This is not mandatory with regard to secondary DNS servers.

NTP Configuration – Check the **Obtain NTP server address via DHCP** radio button to automatically look up and use the NTP server settings as provided by DHCP. Click the **View** button to see the current settings.

Use the following NTP server address – To create manual settings, check this radio button and enter the host name or IP address of the NTP server.

Host Name Configuration – The video decoders can be accessed using a host name, instead of an IP address. The host name is usually the same as the assigned DNS Name.

For more information, please see *Security*, on page 16.

Link-Local IPv4 Address – This is enabled by default and assigns the video decoders an additional IP address for use with UPnP™. The decoder can have both a Link-Local IP and a static/DHCP-supplied IP address at the same time – these will not affect each other.

HTTP and HTTPS – The default HTTP/HTTPS port numbers (80 and 443 respectively) can be changed to any port within the range 1024–65535. This is useful for simple security port mapping, for example.

NAT traversal (port mapping) for IPv4 – A broadband router allows devices on a private network (LAN) to share a single connection to the Internet. This is done by forwarding network traffic from the private network to the "outside", that is, the Internet. Security on the private network (LAN) is increased since most broadband routers are pre-configured to stop attempts to access the private network (LAN) from the public network/Internet.

Use **NAT traversal** when your video decoders are located on an intranet (LAN) and you wish to make it available from the other (WAN) side of a NAT router. With NAT traversal properly configured, all HTTP traffic to an external HTTP port in the NAT router is forwarded to the decoder.

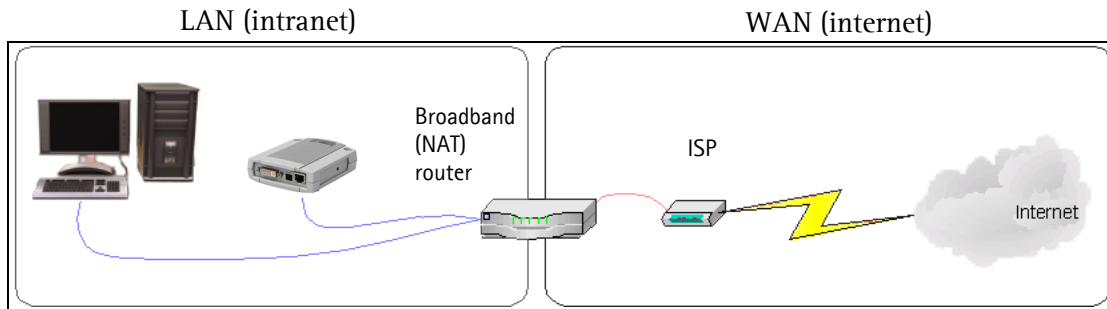

Notes:

- For NAT traversal to work, this must be supported by the broadband router.
- The broadband router has many different names: "NAT router", "Network router", "Internet Gateway", "Broadband sharing device" or "Home firewall" but the essential purpose of the device is the same.

Enable/Disable - when enabled, the video decoders attempt to configure port mapping in a NAT router on your network, using UPnP™. Note that UPnP™ must be enabled in the decoder (see **System Options > Network > UPnP**).

Use manually selected NAT router - select this option to manually select a NAT router and enter the IP address for the router in the field provided.

If a router is not manually specified, the video decoders automatically search for NAT routers on your network. If more than one router is found, the default router is selected.

Alternative HTTP port - select this option to manually define an external HTTP port. Enter the port number in the field provided. If no port is entered here a port number is automatically selected when NAT traversal is enabled.

Notes:

- An alternative HTTP port can be used/be active even if NAT traversal is disabled. This is useful if your NAT router does not support UPnP and you need to manually configure port forwarding in the NAT router.
- If you attempt to manually enter a port that is already in use, another available port is automatically selected.
- When the port is selected automatically it is displayed in this field. To change this enter a new port number and click Save.

FTP - The FTP server running in the video decoders enables the upload of new firmware, and user applications. Check the box to enable the service.

Proxy settings

Proxy settings allows you to set up an HTTP proxy server if, for example, you want the AXIS P7701 to be able to access cameras outside of a firewall. Follow the steps below to set up an HTTP proxy server:

1. Select enable to use the HTTP proxy server
2. Enter a descriptive name for the proxy server
3. Specify which port to use. The default port is 8080
4. Enter local network IP addresses with subnet mask
5. Enter the **User name** and **Password** for the proxy server

SMTP (email)

Enter the host names (or IP addresses) and port numbers for your primary and secondary mail servers in the fields provided, to enable the sending of notifications from the decoder to predefined addresses via SMTP.

If your mail server requires authentication, check the box for **Use authentication to log in to this server** and enter the necessary information. See the online help  for more information.

SNMP

The Simple Network Management Protocol (SNMP) allows remote management of network devices. An SNMP community is the group of devices and management station running SNMP. Community names are used to identify groups.

Depending on the level of security required, select the version of SNMP to use. The three levels of security are:

SNMP v1/v2 – Select either SNMP V1 that includes no security, or SNMP V2c that uses very simple security.

The community name can be specified as a password for read or read/write access to all supported SNMP objects. The community is the group of network devices using SNMP. The default password for the **Read Community** is **public** and the default password for the **Write community** is **write**.

Traps for SNMP v1/v2

Traps are used by the decoder to send messages to a management system for important events or status changes.

If **Enable traps** is selected, enter the IP address where the trap message is to be sent as well as the **Trap community** that should receive the message.

There are four types of traps available for the video decoder.

- Cold start
- Warm start
- Link up
- Authentication failed

SNMP v3 – SNMP V3 – provides encryption and secure passwords. HTTPS must be enabled. To use traps with SNMP v3 an SNMP v3 management application is required.

If the **Enable SNMP v3** option is enabled, provide the Initial user password. Note that the initial password is activated only when HTTPS is enabled and can only be set once.

If HTTPS is enabled, SNMP v1 and SNMP v2c should be disabled.

When SNMP configuration is ready, click **Save** to use the new settings or **Reset** to return to the default values.

UPnP™

The video decoder includes support for UPnP™. UPnP™ is enabled by default, and the video decoder then is automatically detected by operating systems and clients that support this protocol.

Bonjour

The video decoder includes support for Bonjour. When enabled, the decoder is automatically detected by operating systems and clients that support this.

Ports & Devices

This page allows configuration of the COM port. For more information please see the online help .

COM Port

The RS-422/RS-485 serial connector allows you to connect legacy and auxiliary equipment to the AXIS P7701. Once connected, an encoder or camera can be configured to receive data such as alarms and messages from these devices.

Serial port settings – Select the appropriate settings for connecting your auxiliary device to the AXIS P7701. Consult device's user documentation for the appropriate settings.

Use the **Mode** setting to either manually **Off**, or automatically **Auto**, send data from your device to an encoder or camera.

The auxiliary device can be connected to the AXIS P7701 using either the RS-485 or RS-422 serial interface. If RS-485 is selected, the data direction can be set to either **Full** or **Half** duplex.

For more information please see the online help .

Maintenance

Restart – The decoder is restarted without changing any settings.

Restore – The unit is restarted and most current settings are reset to factory default values. The settings that do not reset are:

- the boot protocol (DHCP or static)
- the static IP address
- the default router
- the subnet mask
- the product interface language
- the system time

Default – The default button should be used with caution. Pressing this returns the decoder's settings to the factory default values (including the IP address).

Upgrade Server – See *Upgrading the Firmware*, on page 27.

Support

The **Support Overview** page provides valuable information on troubleshooting and contact information, should you require technical assistance.

The **System Overview** page provides an overview of the decoder's status and settings. Information that can be found here includes the decoder's firmware version, IP address, video sources, security and recent log items. Many of the captions are also links to other pages where you can make adjustments to the decoder's settings.

Logs & Reports

When contacting Axis support, please be sure to provide a valid Server Report with your query. The Access Log is automatically included in the server report.

Information – the **Server Report** and **Parameter List** may prove useful when troubleshooting a problem or when contacting the Axis support web.

- **System Log** – Provides information about system events.
- **Access Log** – By default, the Access Log lists all failed attempts to access the decoder but can be configured to list all connections to the decoder, whether successful or not. Go to **Support > Logs & Reports > Configuration** and select the desired level of information from the list. See *Configuration – From the drop-down lists, select the level of information to be added to the System Log and Access Log files and the permitted size of the log files.*, on page 22

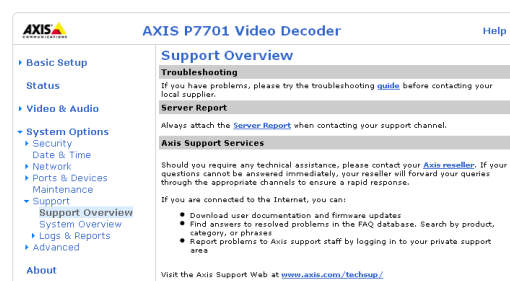

for more information.

The Access Log is useful for various purposes such as tracking all access to the decoder, simple web attraction tracking, system analysis and troubleshooting.

- **Server Report** – Provides information about the server status and should always be included when requesting support.
- **Parameter List** – Shows the unit's parameters and their current settings.

Configuration – From the drop-down lists, select the level of information to be added to the **System Log** and **Access Log** files and the permitted size of the log files.

The default information level for the Access Log is set to Critical & Warnings, i.e. failed connections. However, in an error situation and when requesting support, set it to the highest information level – Critical & Warnings & Info.

For the Log Level for Email, select from the drop-down list the level of information to send as email and enter the destination email address.

Advanced

Scripting is an advanced function that enables you to customize and use scripts. This function is a very powerful tool.

Note: Improper use may cause unexpected behavior or even cause loss of contact with the unit. If a script does cause problems, reset the unit to its factory default settings. A backup file may be of use to return the unit to its latest configuration.

Axis recommends that you do not use this function unless you understand the consequences. Note that Axis support does not provide assistance for problems with customized scripts.

For more information, please visit the Developer pages at www.axis.com/developer

Plain Config – this function is for the advanced user with experience of Axis video decoder configuration. All parameters can be set and modified from this page. Help is available from the standard help pages.

About

Here you can find basic information about your video decoder. You can also view third party software licenses.

Sequence Mode

The AXIS P7701 displays the video from the connected sources in 2 different sequence modes - auto mode and manual mode.

Auto sequence mode

In this mode, the video sources in the list on the Video Sources page are automatically cycled through, one by one. Auto mode can be paused and resumed by pressing the Video Select button.

Action/event	Result in auto sequence mode
Connection established	Video source displayed.
Connection to currently playing source is lost.	Screen goes blank and, depending on the remaining display time, the decoder either tries to reconnect or goes to the next source. The source cache is cleared, resulting in a new autodetection. See also Adding a video source, on page 10.
Video select button is pressed during display.	Automatic cycling is paused.
Video select button is pressed during pause.	Automatic cycling is resumed directly at the next source.
Parameters are changed.	The connection cache is cleared and all sources are autodetected again upon the next connection.
User presses Connect to button in web interface to connect to a video source not included in the auto mode list.	The decoder connects to that source. After the display time has elapsed, the next source in the auto list is selected.
Alarm received from video encoder or camera.	Alarm is ignored.

Manual sequence mode

When in manual mode, the AXIS P7701 displays a single video source and only skips to the next source when the video select button is pressed.

Action/event	Result in manual sequence mode
Connection established	Video source displayed.
Connection to currently playing source is lost.	The screen goes blank and the decoder attempts to reconnect. The source cache is cleared, resulting in a new autodetection.
Video select button is pressed during display.	Decoder cycles to next source. If the next source is not already cached, autodetection will occur.
Video select button is pressed during autodetect of next source.	Autodetect is aborted on that source and the decoder attempts to go to the next source.
Parameters are changed.	The connection cache is cleared and all sources are autodetected again, upon the next connection.
User uses Connect to button in web interface to connect to a video source not included in the manual mode list.	The decoder connects to that source. When the video select button is pressed, the next source in the manual mode list is selected.
Alarm notification received from video encoder or camera.	Decoder switches to display from the encoder or camera that sent the alarm.

Note: Keeping the video select button pressed for more than 2 seconds will disconnect the AXIS P7701.

Alarms

Many Axis video encoders and network cameras can send notification messages whenever certain types of events occur. These messages can be received by the AXIS P7701 and used as alarms. The incoming alarm causes the AXIS P7701 to switch to the video source in the alarm message. The AXIS P7701 automatically switches to the video source in the alarm message.

The notification messages sent by video encoders or cameras are the result of events occurring in those devices. These events may be triggered by an incoming signal on an input on the encoder or camera, or they may be the result of detected motion in the scene monitored by the encoder or camera.

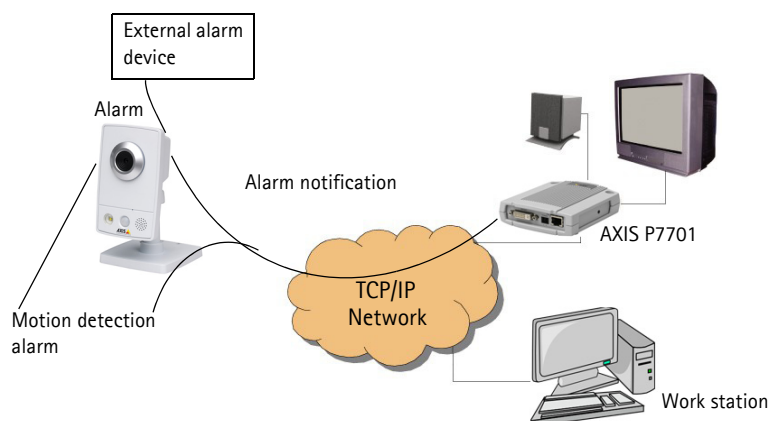

To allow alarms to be received by the AXIS P7701, the Sequence mode must be set to Manual, and Receive alarms must be set to Yes. Both settings are found on the General settings page. When enabled, the AXIS P7701 automatically switches to the video source specified in the alarm message.

Note: The ability to send TCP and HTTP notification messages depends on the Axis video encoder or camera being used.

Setting up alarms

For the AXIS P7701 to respond correctly to alarms, the following steps need to be taken:

1. To configure the AXIS P7701, add the video encoder or camera to the list of video sources. Refer to Adding a video source, on page 10 for instructions.
2. To configure the video encoder or network camera, add the AXIS P7701 as a TCP or HTTP Event Server. These screen shots show examples of both types of servers. Refer to the documentation of the video encoder or camera for instructions on how to set up an Event Server.

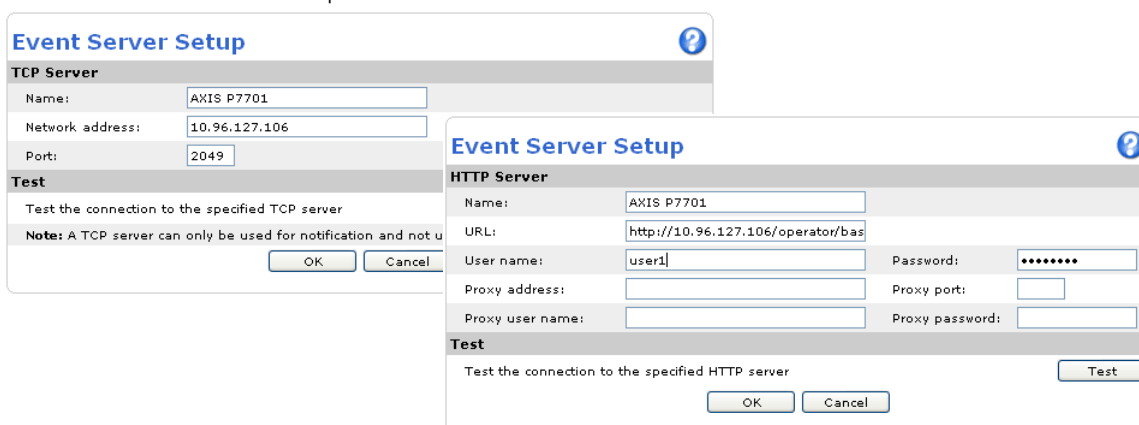

Notes:

- The URL for an HTTP event server should be set to: `http://<IP address>/axis-cgi/admin/alarm.cgi`
 - The TCP alarm port on the AXIS P7701 is configured on the Network Settings page.
3. Configure the Event Type to send a notification message to the event server (i.e. the AXIS P7701).

Notification syntax

The notification message is formatted differently for TCP and HTTP.

TCP notification syntax

Enter the notification message in the Message field, in the format:

```
sourcename=<name from list>&textmessage=<my message>
```

For example:

```
sourcename=DoorCam1&textmessage=Door is open
```

The message is sent to the TCP port (default 2048) on the AXIS P7701.

HTTP notification syntax

Enter the notification message in the Custom parameters field, in the format:

```
sourcename=<name from list>&textmessage=<my message>
```

For example:

```
sourcename=DoorCam1&textmessage=Door%20is%20open
```

The message is sent to the HTTP port (default 80) on the AXIS P7701.

Note: All non-alphanumerical characters included in an HTTP notification message must be URL-encoded. For example, a blank space must be written as `%20`, as in `Door%20is%20open`.

For more information, please see the online help. For more information concerning the video encoder or camera, see that product's documentation and online help.

Resetting to Factory Default Settings

To reset the AXIS P7701 to its original factory default settings, go to the **System Options > Maintenance** web page (as described in *Maintenance*, on page 21) or use the **Control button** (see page 5) as described below:

Using the Control Button

To reset the decoder to the factory default settings using the Control Button:

1. Disconnect the power cable or if using PoE, disconnect the network cable.
2. Press and hold the Control button while reconnecting power.
3. Keep the Control button pressed until the Status indicator displays amber (this may take up to 15 seconds).
4. Release the Control button.
5. When the Status indicator changes to green (which may take up to 1 minute), the process is complete and the decoder has been reset. The unit now has the default IP address 192.168.0.90

Note: For other methods of setting the IP address, please refer to the product's Installation Guide that accompanies the product, or download a copy from www.axis.com.

Troubleshooting

Checking the Firmware

Firmware is software that determines the functionality of the video decoder. One of your first actions when troubleshooting a problem should be to check the current firmware version. The latest version may contain a correction that fixes your particular problem. The current firmware version in your decoder is displayed on the page **About**.

Upgrading the Firmware

When you upgrade your decoder with the latest firmware from the Axis Web site, your decoder receives the latest functionality available. Always read the upgrade instructions and release notes available with each new release, before updating the firmware.

Note:

Preconfigured and customized settings are saved when the firmware is upgraded (providing the features are available in the new firmware) although this is not guaranteed by Axis Communications. Always read the instructions and release notes available with each new release, before upgrading the firmware.

1. Save the firmware file to your computer. The latest version of the firmware is available free of charge from the Axis website at www.axis.com/techsup
2. Go to **System Options > Maintenance** in the decoder's web pages.
3. In the **Upgrade Server** section, browse to the desired firmware file on your computer. Click **Upgrade**.

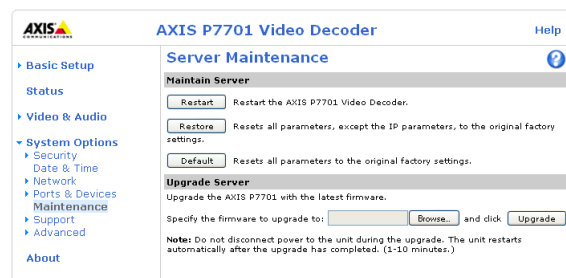

Notes:

- After starting the upgrade process, always wait at least 5-10 minutes before restarting the decoder, even if you suspect the upgrade has failed.
- Your dealer reserves the right to charge for any repair attributable to faulty upgrading by the user.
- The AXIS Camera Management software tool can be used for multiple upgrades. Please see the Axis website at www.axis.com for more information.

Emergency Recovery Procedure

If power or the network connection to the decoder is lost during the upgrade, the process fails and the unit becomes unresponsive. A flashing red Status LED indicates a failed upgrade. To recover the unit, follow the steps below. The serial number is found on the label attached to the bottom of the decoder.

1. **UNIX/Linux** - From the command line, type the following:

```
arp -s <IP address of decoder> <serial number> temp
ping -s 408 <IP address of decoder>
```

Windows - From a command/DOS prompt, type the following:

```
arp -s <IP address of decoder> <serial number>
ping -l 408 -t <IP address of decoder>
```

2. If the unit does not reply within a few seconds, restart it and wait for a reply. Press CTRL+C to stop Ping.
3. Open a browser and type in the decoder's IP address. In the page that appears, use the **Browse** button to select the upgrade file to use, for example, `axisp3343.bin`. Then click the **Load** button to restart the upgrade process.
4. After the upgrade is complete (1-10 minutes), the unit automatically restarts and shows a steady green on the Power and Status LEDs and flashing green or amber on the Network LED.
5. Reinstall the decoder, referring to the installation guide.

If the emergency recovery procedure does not get the decoder up and running again, please contact Axis support at www.axis.com/techsup/

Axis Support

If you contact Axis support, please help us to help you solve your problems by providing the server report, the log file and a detailed description of the problem.

Server Report - go to **System Options > Support > Support Overview**. The server report contains important information about the server and its software, as well as a list of the current parameters.

The **Log file** is available from **System Options > Support > Logs & Reports**. The Log file records events in the unit since the last system restart and can be a useful diagnostic tool when troubleshooting.

Symptoms, Possible Causes, and Remedial Action

Problems setting the IP address	
When using ARP/Ping	Try installation again. The IP address must be set within two minutes after power is applied to the decoder. Ensure the Ping length is set to 408. See Installation Guide.
The decoder is located on a different subnet	If the IP address intended for the decoder and the IP address of your computer are located on different subnets, you will not be able to set the IP address. Contact your network administrator to obtain an appropriate IP address.
The IP address is being used by another device	Disconnect the decoder from the network. Run the Ping command. (In a Command/DOS window, type ping and the IP address of the unit). If you receive: Reply from <IP address>: bytes = 32; time = 10 ms..... - this means that the IP address may already be in use by another device on your network. You must obtain a new IP address and reinstall the unit. If you see: Request timed out - this means that the IP address is available for use with your decoder. In this case, check all cabling and reinstall the unit.
Possible IP address conflict with another device on the same subnet	The static IP address in the decoder is used before the DHCP server sets a dynamic address. This means that if the same default static IP address is used by another device, there may be problems accessing the decoder. To avoid this, set the static IP address to 0.0.0.0.
The decoder cannot be accessed from a browser	
The IP address has been changed by DHCP	If the decoder and client are on the same network, Run AXIS IP Utility to locate the decoder. Identify the decoder using its model or serial number. Alternatively: 1) Move the decoder to an isolated network or to one with no DHCP or BOOTP server. Set the IP address again, using the AXIS IP Utility (see the Installation Guide) or the ARP/Ping commands. 2) Access the unit and disable DHCP in the TCP/IP settings. Return the unit to the main network. The unit now has a fixed IP address that will not change. 3) As an alternative to 2), if dynamic IP address via DHCP or BOOTP is required, select the required service and then configure IP address change notification from the network settings. Return the unit to the main network. The unit now has a dynamic IP address, but will notify you if the address changes.
Other networking problems	Test the network cable by connecting it to another network device, then Ping that device from your workstation. See instructions above.
The decoder is accessible locally, but not externally	
Broadband router configuration	To configure your broadband router to allow incoming data traffic to the decoder, enable the NAT-traversal feature which will attempt to automatically configure the router to allow access to the decoder. This is enabled from System Options > Network > TCP/IP Advanced .
Firewall protection	Check the Internet firewall with your system administrator.
Default routers required	Check if you need to configure the default router settings.
The Power indicator is not constantly lit	
Faulty power supply	Check that you are using the same indoor power supply that came with the product.
The Network indicator LEDs are flashing red rapidly	
Hardware failure	Contact your Axis dealer.

For further assistance, please contact your reseller or see the support pages on the Axis website at www.axis.com/techsup

Technical Specifications for AXIS P7701

Function/group	Item	Specification
Decoder	Models	AXIS P7701 Video Decoder
Video	Video compression	<ul style="list-style-type: none"> • H.264 • MPEG-4 Part 2 • Motion JPEG
	Resolutions	<ul style="list-style-type: none"> • H.264 and MPEG-4 Part 2; All resolutions up to D1 (720x480 in NTSC, 720x576 in PAL) • Motion JPEG; All resolutions up to 720p (1280x720)
	Frame rate H.264	30/25 (NTSC/PAL) fps in up to D1 resolution
	Frame rate MPEG-4 part 2	30/25 (NTSC/PAL) fps in up to D1 resolution
	Frame rate Motion JPEG	Up to 15 (NTSC/PAL) fps in 720p resolution
	Video streaming	<ul style="list-style-type: none"> • One stream H.264/Motion JPEG/MPEG-4 part 2 decoding
	Image settings	<ul style="list-style-type: none"> • NTSC/PAL • VGA (60/75Hz) • S-VGA (60/75Hz) • 1280 x 720 (16:9) via DVI-I connector
	Serial Connection	Forwarding of serial commands
Audio	Audio streaming	One way
	Audio compression	<ul style="list-style-type: none"> • AAC-LC 8 kHz 32 kbit/s, 16 kHz 64 kbit/s • G.711 PCM 8 kHz 64 kbit/s • G.726 ADPCM 8 kHz 32 or 24 kbit/s
	Audio input/output	Line output
Network	Security	Password protection, IP address filtering, HTTPS encryption, IEEE 802.1X network access control, digest authentication, user access log
	Supported protocols	IPv4/v6, HTTP, HTTPS, FTP, SMTP, Bonjour, UPnP, SNMPv1/v2c/v3(MIB-II), DNS, DynDNS, NTP, RTSP, RTP, TCP, UDP, IGMP, RTCP, ICMP, DHCP, ARP, SSL/TLS
System Integration	Application Programming Interface	Open API for software integration, including VAPIX® from Axis Communications available at www.axis.com
	Alarm triggers	Ability to receive external alarms according to specified VAPIX API
	Alarm events	Notification via email
General	Casing	<ul style="list-style-type: none"> • Metal casing. Standalone or wall mount
	Processors, memory	<ul style="list-style-type: none"> • TI TMS320DM6443, 128MB RAM, 128MB Flash
	Power	8-20 V DC, max. 8.3 W or Power over Ethernet IEEE 802.3af Class 3
	Connectors	<ul style="list-style-type: none"> • RCA composite video output • DVI-I (digital and analog) output • RJ-45 10BASE-T/100BASE-TX PoE • DC terminal block: 8-20 V DC max. 8.3 W • I/O terminal block: input for a video select button, and a 3.3V @ 250mA power output • RS485/ RS422 terminal block • 3.5 mm audio line/headphones output, mono
	Operating conditions	<ul style="list-style-type: none"> • 0-50 °C (32-122 °F) Humidity 20-80% RH (non-condensing)
	Approvals	<ul style="list-style-type: none"> • EN 55022 Class B, EN 61000-3-2, EN 61000-3-3, EN 55024, FCC Part 15 Subpart B Class B, ICES-003 Class B, VCCI Class B, C-tick AS/NZS CISPR22 Class B, IEC/EN 60950-1, KCC Class B
	Dimensions (HxWxD)	33 x 99 x 118 mm
	Weight	<ul style="list-style-type: none"> • 318 g (0.7lb)

General performance considerations

When setting up your system, it is important to consider how various settings and situations will affect performance. Some factors affect the amount of bandwidth (the bitrate) required, others can affect the frame rate, and some affect both. If the load on the CPU reaches its maximum, this will also affect the frame rate. Also, high image resolutions and lower compression levels result in larger images.

Glossary of Terms

720p – 720p refers to 720 lines of progressive video (720 lines per frame). Higher resolution than standard DVD, which is 480i or 480p. Usually refers to 1280x720 resolution in 1.78 aspect ratio.

ActiveX – A standard that enables software components to interact with one another in a networked environment, regardless of the language(s) used to create them. web browsers may come into contact with ActiveX controls, ActiveX documents, and ActiveX scripts. ActiveX controls are often downloaded and installed automatically as required.

Angle – The field of view, relative to a standard lens in a 35mm still camera, expressed in degrees, e.g. 30°. For practical purposes, this is the area that a lens can cover, where the angle of view is determined by the focal length of the lens. A wide-angle lens has a short focal length and covers a wider angle of view than standard or telephoto lenses, which have longer focal lengths.

ARP (Address Resolution Protocol) – This protocol is used to associate an IP address to a hardware MAC address. A request is broadcast on the local network to discover the MAC address for an IP address.

ARTPEC (Axis Real Time Picture Encoder) – This chip is used for image compression, and image processing such as conversion of raw image sensor data, color correction, sharpening, noise filtering etc.

ASIC (Application Specific Integrated Circuit) – A circuit designed for a specific application, as opposed to a general purpose circuit, such as a microprocessor.

Aspect ratio – A ratio of width to height in images. A common aspect ratio used for television screens and computer monitors is 4:3. High-definition television (HDTV) uses an aspect ratio of 9:16.

Autoiris (DC-Iris) – This special type of iris is electrically controlled by the camera, to automatically regulate the amount of light allowed to enter.

Bitmap – A bitmap is a data file representing a rectangular grid of pixels. It defines a display space and color for each pixel (or 'bit') in the display space. This type of image is known as a 'raster graphic.' GIFs and JPEGs are examples of image file types that contain bitmaps.

Because a bitmap uses this fixed raster method, it cannot easily be rescaled without losing definition. Conversely, a vector graphic image uses geometrical shapes to represent the image, and can thus be quickly rescaled.

Bit rate – The bit rate (in kbit/s or Mbit/s) is often referred to as speed, but actually defines the number of bits/time unit and not distance/time unit.

Bonjour – Also known as zero-configuration networking, Bonjour enables devices to automatically discover each other on a network, without having to enter IP addresses or configure DNS servers. Bonjour is a trademark of Apple Computer, Inc.

Broadband – In network engineering terms, this describes

transmission methods where two or more signals share the same carrier. In more popular terminology, broadband is taken to mean high-speed data transmission.

CCD (Charged Coupled Device) – This light-sensitive image device used in many digital cameras is a large integrated circuit that contains hundreds of thousands of photo-sites (pixels) that convert light energy into electronic signals. Its size is measured diagonally and can be 1/4", 1/3", 1/2" or 2/3".

CGI (Common Gateway Interface) – A specification for communication between a web server and other (CGI) programs. For example, a HTML page that contains a form might use a CGI program to process the form data once it is submitted.

CIF (Common Intermediate Format) – CIF refers to the analog video resolutions 352x288 pixels (PAL) and 352x240 pixels (NTSC). See also *Resolution*.

Client/Server – Client/server describes the relationship between two computer programs in which one program, the client, makes a service request from another program, the server, which fulfils the request. Typically, multiple client programs share the services of a common server program. A web browser is a client program that requests services (the sending of web pages or files) from a web server.

CMOS (Complementary Metal Oxide Semiconductor) – A CMOS is a widely used type of semiconductor that uses both negative and positive circuits. Since only one of the circuit types is on at any given time, CMOS chips require less power than chips using just one type of transistor. CMOS image sensors also allow processing circuits to be included on the same chip, an advantage not possible with CCD sensors, which are also much more expensive to produce.

Codec – In communications engineering, a codec is usually a coder/decoder. Codecs are used in integrated circuits or chips that convert e.g. analog video signals into a digital format for transmission. The codec also converts received digital signals back into analog format. A codec uses analog-to-digital conversion and digital-to-analog conversion in the same chip.

Codec can also mean compression/decompression, in which case it is generally taken to mean an algorithm or computer program for reducing the size of large files and programs.

Compression – See *Image compression*.

Composite video – A type of video signal in which all information—the red, blue, and green signals (and sometimes audio signals as well)—are mixed together. This is the type of signal used by analog televisions in the United States (see NTSC).

DC-Iris (Autoiris) – This special type of iris is electrically controlled by the camera, to automatically regulate the amount of light allowed to enter.

DHCP (Dynamic Host Configuration Protocol) – DHCP is a protocol that lets network administrators automate and centrally manage the assignment of Internet Protocol (IP) addresses to network devices in a network.

DHCP uses the concept of a 'lease' or amount of time that a given IP address will be valid for a computer. The lease time can

vary, depending on how long a user is likely to require the network connection at a particular location.

DHCP also supports static addresses for e.g. computers running web servers, which need a permanent IP address.

DNS (Domain Name System) – DNS is used to locate and translate Internet domain names into IP (Internet Protocol) addresses. A domain name is a meaningful and easy-to-remember name for an Internet address. For example the domain name `www.example.com` is much easier to remember than `192.0.34.166`. The translation tables for domain names are contained in Domain name servers.

D-1 – SMPTE digital VTR video standard. It has a resolution of 720×486 for NTSC systems and 720×576 for PAL systems.

Domain Server – Domains can also be used by organizations who wish to centralize the management of their (Windows) computers. Each user within a domain has an account that usually allows them to log in to and use any computer in the domain, although restrictions may also apply. The domain server is the server that authenticates the users on the network.

DVI – Digital Visual Interface, an interface standard that specifies a connector and signaling methods used to transmit video information in both analog and digital formats.

Ethernet – Ethernet is the most widely installed local area network technology. An Ethernet LAN typically uses special grades of twisted pair wires. The most commonly installed Ethernet systems are 10BASE-T and 100BASE-T10, which provide transmission speeds up to 10 Mbps and 100 Mbps respectively.

ETRAX (Ethernet Token Ring AXIS) – Axis' own microprocessor.

Factory default settings – These are the settings that originally applied for a device when it was first delivered from the factory. If it should become necessary to reset a device to its factory default settings, this will, for many devices, completely reset any settings that were changed by the user.

Firewall – A firewall works as a barrier between networks, e.g. between a Local Area Network and the Internet. The firewall ensures that only authorized users are allowed to access the one network from the other. A firewall can be software running on a computer, or it can be a standalone hardware device.

Focal length – Measured in millimeters, the focal length of a camera lens determines the width of the horizontal field of view, which in turn is measured in degrees.

FTP (File Transfer Protocol) – An application protocol that uses the TCP/IP protocols. It is used to exchange files between computers/devices on networks.

Frame – A frame is a complete video image. In the 2:1 interlaced scanning format of the RS-170 and CCIR formats, a frame is made up of two separate fields of 262.5 or 312.5 lines interlaced at 60 or 50 Hz to form a complete frame, which appears at 30 or 25 Hz. In video cameras with a progressive scan, each frame is scanned line-by-line and not interlaced; most are also displayed at 30 and 25 Hz.

Frame rate – The frame rate used to describe the frequency at

which a video stream is updated is measured in frames per second (fps). A higher frame rate is advantageous when there is movement in the video stream, as it maintains image quality throughout.

Gain – Gain is the amplification factor and the extent to which an analog amplifier boosts the strength of a signal. Amplification factors are usually expressed in terms of power. The decibel (dB) is the most common way of quantifying the gain of an amplifier.

Gateway – A gateway is a point in a network that acts as an entry point to another network. In a corporate network for example, a computer server acting as a gateway often also acts as a proxy server and a firewall server. A gateway is often associated with both a router, which knows where to direct a given packet of data that arrives at the gateway, and a switch, which furnishes the actual path in and out of the gateway for a given packet.

GIF (Graphics Interchange Format) – GIF is one of the most common file formats used for images in web pages. There are two versions of the format, 87a and 89a. Version 89a supports animations, i.e. a short sequence of images within a single GIF file. A GIF89a can also be specified for interlaced presentation.

GOV (Group Of VOPs) – A group of VOPs is the basic unit of an H.264 video stream. The GOV contains different types and numbers of VOPs (I-VOPs, P-VOPs) as determined by the GOV length and GOV structure. See also *VOP*.

GOV length – The GOV length determines the number of images (VOPs) in the GOV structure. See also *GOV* and *VOP*.

GOV structure – The GOV structure describes the composition of an H.264 video stream, as regards the type of images (I-VOPs or P-VOPs) included in the stream, and their internal order. See also *GOV* and *VOP*.

H.264 – Also known as MPEG-4 Part 10. This is the new generation compression standard for digital video. H.264 offers higher video resolution than Motion JPEG or MPEG-4 at the same bit rate and bandwidth, or the same quality video at a lower bit rate.

Half-duplex – See *Full-duplex*.

HDCP – High Bandwidth Digital Content protection, is designed to protect digital entertainment content that uses the DVI interface. HDCP encrypts the transmission of digital content between the video source or transmitter (e.g. encoder or camera) and the digital display or receiver (e.g. a monitor, television or projector).

HDMI – High-Definition Multimedia Interface is the first industry-supported uncompressed, all-digital audio/video interface. HDMI has the capacity to support existing high-definition video formats such as 720p, 1080i, and 1080p. It also supports enhanced definition formats like 480p, and standard definition formats such as NTSC or PAL.

HTML (Hypertext Markup Language) – HTML is the set of "markup" symbols or codes inserted in a file intended for display in web browser. The markup tells the browser how to display the page's words and images for the user.

HTTP (Hypertext Transfer Protocol) – HTTP is the set of rules for exchanging files (text, graphic images, sound, video, and other multimedia files) on the web. The HTTP protocol runs on top of the TCP/IP suite of protocols.

Hub – A (network) hub is used to connect multiple devices to the network. The hub transmits all data to all devices connected to it, whereas a switch will only transmit the data to the device it is specifically intended for.

Image compression – Image compression minimizes the file size (in bytes) of an image. Two of the most common compressed image formats are JPEG and GIF.

Interlacing – Interlaced video is video captured at 50 pictures (known as fields) per second, of which every 2 consecutive fields (at half height) are then combined into 1 frame. Interlacing was developed many years ago for the analog TV world and is still used widely today. It provides good results when viewing motion in standard TV pictures, although there is always some degree of distortion in the image.

To view interlaced video on e.g. a computer monitor, the video must first be de-interlaced, to produce progressive video, which consists of complete images, one after the other, at 25 frames per second. See also *Progressive scan*.

IP (Internet Protocol) – The Internet Protocol is a method transmitting data over a network. Data to be sent is divided into individual and completely independent "packets." Each computer (or host) on the Internet has at least one address that uniquely identifies it from all others, and each data packet contains both the sender's address and the receiver's address.

The Internet Protocol ensures that the data packets all arrive at the intended address. As IP is a connectionless protocol, which means that there is no established connection between the communication end-points, packets can be sent via different routes and do not need to arrive at the destination in the correct order.

Once the data packets have arrived at the correct destination, another protocol - Transmission Control Protocol (TCP) - puts them in the right order. See also *TCP*.

IP Address – An IP address is simply an address on an IP network used by a computer/device connected to that network. IP addresses allow all the connected computers/devices to find each other and to pass data back and forth.

To avoid conflicts, each IP address on any given network must be unique. An IP address can be assigned as fixed, so that it does not change, or it can be assigned dynamically (and automatically) by DHCP.

An IP address consists of four groups (or quads) of decimal digits separated by periods, e.g. 130.5.5.25. Different parts of the address represent different things. Some part will represent the network number or address, and some other part will represent the local machine address.

See also *IP (Internet Protocol)*.

I-VOP – See *VOP*.

JPEG (Joint Photographic Experts Group) – Together with the GIF file format, JPEG is an image file type commonly used on the web. A JPEG image is a bitmap, and usually has the file suffix '.jpg' or '.jpeg.' When creating a JPEG image, it is possible to configure the level of compression to use. As the

lowest compression (i.e. the highest quality) results in the largest file, there is a trade-off between image quality and file size.

kbit/s (kilobits per second) – A measure of the bit rate, i.e. the rate at which bits are passing a given point. See also *Bit rate*.

LAN (Local Area Network) – A LAN is a group of computers and associated devices that typically share common resources within a limited geographical area.

Linux – Linux is an open source operating system within the UNIX family. Because of its robustness and availability, Linux has won popularity in the open source community and among commercial application developers.

MAC address (Media Access Control address) – A MAC address is a unique identifier associated with a piece of networking equipment, or more specifically, its interface with the network. For example, the network card in a computer has its own MAC address.

Manual iris – This is the opposite to an autoiris, i.e. the camera iris must be adjusted manually to regulate the amount of light allowed to reach the image sensor.

Mbit/s (Megabits per second) – A measure of the bit rate, i.e. the rate at which bits are passing a given point. Commonly used to give the 'speed' of a network. A LAN might run at 10 or 100 Mbit/s. See also *Bit rate*.

Monitor – A monitor is very similar to a standard television set, but lacks the electronics to pick up regular television signals.

Motion JPEG – Motion JPEG is a simple compression/decompression technique for networked video. Latency is low and image quality is guaranteed, regardless of movement or complexity of the image. Image quality is controlled by adjusting the compression level, which in turn provides control over the file size, and thereby the bit rate.

High-quality individual images from the Motion JPEG stream are easily extracted. See also *JPEG*.

Megapixel – See *Pixel*.

MPEG-2 – MPEG-2 is the designation for a group of audio and video coding standards, and is typically used to encode audio and video for broadcast signals, including digital satellite and Cable TV. MPEG-2, with some modifications, is also the coding format used by standard commercial DVD movies.

Multicast – Bandwidth-conserving technology that reduces bandwidth usage by simultaneously delivering a single stream of information to multiple network recipients.

Network connectivity – The physical (wired or wireless) and logical (protocol) connection of a computer network or an individual device to a network, such as the Internet or a LAN.

NTSC (National Television System Committee) – NTSC is the television and video standard in the United States. NTSC delivers 525 lines at 60 half-frames/second.

NWay – A network protocol that automatically negotiates the highest possible common transmission speed between two devices.

PAL (Phase Alternating Line) – PAL is the dominant television standard in Europe. PAL delivers 625 lines at 50 half-frames/second.

Ping – Ping is a basic network program used diagnostically to check the status of a network host or device. Ping can be used to see if a particular network address (IP address or host name) is occupied or not, or if the host at that address is responding normally. Ping can be run from e.g. the Windows Command prompt or the command line in UNIX.

Pixel – A pixel is one of the many tiny dots that make up a digital image. The color and intensity of each pixel represents a tiny area of the complete image.

PoE (Power over Ethernet) – Power over Ethernet provides power to a network device via the same cable as used for the network connection. This is very useful for IP-Surveillance and remote monitoring applications in places where it may be too impractical or expensive to power the device from a power outlet.

PPP (Point-to-Point Protocol) – A protocol that uses a serial interface for communication between two network devices. For example, a PC connected by a phone line to a server.

PPTP (Point-to-Point Tunneling Protocol) – A protocol (set of communication rules) that allows corporations to extend their own corporate network through private "tunnels" over the public Internet. In this way a corporation can effectively use a WAN (Wide Area Network) as a large single LAN (Local Area Network). This kind of interconnection is known as a virtual private network (VPN).

Pre/post alarm images – The images from immediately before and after an alarm. These images are stored in a buffer for later retrieval.

Progressive scan – Progressive scan, as opposed to interlaced video, scans the entire picture, line by line every sixteenth of a second. In other words, captured images are not split into separate fields as in interlaced scanning.

Computer monitors do not need interlace to show the picture on the screen, but instead show them progressively, on one line at a time in perfect order, i.e. 1, 2, 3, 4, 5, 6, 7 etc., so there is virtually no 'flickering' effect. In a surveillance application, this can be critical when viewing detail within a moving image, such as a person running. A high-quality monitor is required to get the best from progressive scan. See also *Interlacing*.

Protocol – A special set of rules governing how two entities will communicate. Protocols are found at many levels of communication, and there are hardware protocols and software protocols.

Proxy server – In an organization that uses the Internet, a proxy server acts as an intermediary between a workstation user and the Internet. This provides security, administrative control, and a caching service. Any proxy server associated with a gateway server, or part of a gateway server, effectively separates the organization's network from the outside network and the local firewall. It is the firewall server that protects the network against outside intrusion.

A proxy server receives requests for Internet services (such as web page requests) from many users. If the proxy server is also

a cache server, it looks in its local cache of previously downloaded web pages. If it finds the page, it is returned to the user without forwarding the request to the Internet. If the page is not in the cache, the proxy server, acting as a client on behalf of the user, uses one of its own IP addresses to request the page from another server over the Internet. When the requested page is returned, the proxy server forwards it to the user that originally requested it.

P-VOP – See *VOP*.

Resolution – Image resolution is a measure of how much detail a digital image can hold: the greater the resolution, the greater the level of detail. Resolution can be specified as the number of pixel-columns (width) by the number of pixel-rows (height), e.g. 320x240.

Alternatively, the total number of pixels (usually in megapixels) in the image can be used. In analog systems it is also common to use other format designations, such as CIF, QCIF, 4CIF, etc.

RTCP (Real-Time Control Protocol) – RTCP provides support for real-time conferencing of groups of any size within an intranet. This support includes source identification and support for gateways like audio and video bridges as well as multicast-to-unicast translators.

RTCP offers quality-of-service feedback from receivers to the multicast group as well as support for the synchronization of different media streams.

RTP (Real-Time Transport Protocol) – RTP is an Internet protocol for the transport of real-time data, e.g. audio and video. It can be used for media-on-demand as well as interactive services such as Internet telephony.

RTSP (Real Time Streaming Protocol) – RTSP is a control protocol, and a starting point for negotiating transports such as RTP, multicast and Unicast, and for negotiating codecs.

RTSP can be considered a 'remote control' for controlling the media stream delivered by a media server. RTSP servers typically use RTP as the protocol for the actual transport of audio/video data.

Router – A device that determines the next network point to which a packet should be forwarded on its way to its final destination. A router creates and/or maintains a special routing table that stores information on how best to reach certain destinations. A router is sometimes included as part of a network switch. See also *switch*.

Server – In general, a server is a computer program that provides services to other computer programs in the same or other computers. A computer running a server program is also frequently referred to as a server. In practice, the server may contain any number of server and client programs. A web server is the computer program that supplies the requested HTML pages or files to the client (browser).

Sharpness – This is the control of fine detail within a picture. This feature was originally introduced into color TV sets that used notch filter decoders. This filter took away all high frequency detail in the black and white region of the picture. The sharpness control attempted to put some of that detail back in the picture. Sharpness controls are mostly superfluous in today's high-end TVs. The only logical requirement for it nowadays is on a VHS machine.

SMTP (Simple Mail Transfer Protocol) – SMTP is used for sending and receiving e-mail. However, as it is 'simple,' it is limited in its ability to queue messages at the receiving end, and is usually used with one of two other protocols, POP3 or IMAP. These other protocols allow the user to save messages in a server mailbox and download them periodically from the server.

SMTP authentication is an extension of SMTP, whereby the client is required to log into the mail server before or during the sending of email. It can be used to allow legitimate users to send email while denying the service to unauthorized users, such as spammers.

SNMP (Simple Network Management Protocol) – SNMP forms part of the Internet Protocol suite, as defined by the Internet Engineering Task Force. The protocol can support monitoring of network-attached devices for any conditions that warrant administrative attention.

Sockets – Sockets are a method for communication between a client program and a server program over a network. A socket is defined as 'the endpoint in a connection.' Sockets are created and used with a set of programming requests or 'function calls' sometimes called the sockets application programming interface (API).

SSL/TSL (Secure Socket Layer/Transport Layer Security)

These two protocols (SSL is succeeded by TSL) are cryptographic protocols that provide secure communication on a network. SSL is commonly used over HTTP to form HTTPS, as used e.g. on the Internet for electronic financial transactions. SSL uses public key certificates to verify the identity of the server.

Subnet/subnet mask – A subnet is an identifiably separate part of an organization's network. Typically, a subnet may represent all the machines at one geographic location, in one building, or on the same local area network (LAN). Having an organization's network divided into subnets allows it to be connected to the Internet with a single shared network address.

The subnet mask is the part of the IP address that tells a network router how to find the subnet that the data packet should be delivered to. Using a subnet mask saves the router having to handle the entire 32-bit IP address; it simply looks at the bits selected by the mask.

SVGA – Super VGA, is a set of graphics standards designed to offer greater resolution than VGA. SVGA supports 800 x 600 resolution, or 480,000 pixels.

Switch – A switch is a network device that connects network segments together, and which selects a path for sending a unit of data to its next destination. In general, a switch is a simpler and faster mechanism than a router, which requires knowledge about the network and how to determine the route. Some switches include the router function. See also *Router*.

TCP (Transmission Control Protocol) – TCP is used along with the Internet Protocol (IP) to transmit data as packets between computers over the network. While IP takes care of the actual packet delivery, TCP keeps track of the individual packets that the communication (e.g. requested a web page file) is divided into, and, when all packets have arrived at their destination, it reassembles them to re-form the complete file.

TCP is a connection-oriented protocol, which means that a connection is established between the two end-points and is

maintained until the data has been successfully exchanged between the communicating applications.

Telnet – Telnet is a simple method with which to access another network device, e.g. a computer. The HTTP protocol and the FTP protocols allow you to request specific files from remote computers, but do not allow you logon as a user of that computer. With Telnet, you log on as a regular user with whatever privileges you may have been granted for specific applications and data residing on that computer.

UDP (User Datagram Protocol) – UDP is a communications protocol that offers limited service for exchanging data in a network that uses the Internet Protocol (IP). UDP is an alternative to the Transmission Control Protocol (TCP). The advantage of UDP is that it is not required to deliver all data and may drop network packets when there is e.g. network congestion. This is suitable for live video, as there is no point in re-transmitting old information that will not be displayed anyway.

Unicast – Communication between a single sender and a single receiver over a network. A new connection is established for each new user.

URL (Uniform Resource Locator) – An "address" on the network.

Varifocal lens – A varifocal lens provides a wide range of focal lengths, as opposed to a lens with a fixed focal length, which only provides one.

VGA – Video Graphics Array is a graphics display system for PCs developed by IBM. In graphics mode, the resolution is either 640 by 480 (with 16 colors) or 320 by 200 (with 256 colors).

VPN (Virtual Private Network) – This creates a secure "tunnel" between the points within the VPN. Only devices with the correct "key" will be able to work within the VPN. The VPN network can be within a company LAN (Local Area Network), but different sites can also be connected over the Internet in a secure way. One common use for VPN is for connecting a remote computer to the corporate network, via e.g. a direct phone line or via the Internet.

VOP (Video Object Plane) – A VOP is an image frame in an H.264 video stream. There are several types of VOP:

- An I-VOP is complete image frame.

- A P-VOP codes the differences between images, as long as it is more efficient to do so. Otherwise it codes the whole image, which may also be a completely new image.

WAN (Wide-Area-Network) – Similar to a LAN, but on a larger geographical scale.

W-LAN (Wireless LAN) – A wireless LAN is a wireless local area network that uses radio waves as its carrier: where the network connections for end-users are wireless. The main network structure usually uses cables.

Web server – A web server is a program, which allows web browsers to retrieve files from computers connected to the Internet. The web server listens for requests from web browsers and upon receiving a request for a file sends it back to the

browser.

The primary function of a web server is to serve pages to other remote computers; consequently, it needs to be installed on a computer that is permanently connected to the Internet. It also controls access to the server whilst monitoring and logging server access statistics.

WPA-PSK (Wi-Fi Protected Access - Pre-Shared Key) - This wireless encryption method uses a pre-shared key (PSK) for key management. Keys can usually be entered as manual hex values, as hexadecimal characters, or as a Passphrase. WPA-PSK provides a greater degree of security than WEP.

Zoom lens - A zoom lens can be moved (zoomed) to enlarge the view of an object to show more detail.

Index

Numerics

802.1X 16

A

Alarm 6, 14, 24

AMC 9

ARP/Ping 17

Audio 6, 15

Auxiliary Power 6

B

Backup 22

Bonjour 8, 20

C

COM Port 21

Control Button 26

D

Date & Time 16

DNS Configuration 18

DNS Server 18

Domain Name 18

DVI-I connector 4, 6

E

Emergency Recovery 27

Enable ARP/Ping 17

H

HDMI 4

Host Name 18

HTTPS 9, 16, 18

I

I/O terminal connector 6

Input 6

IP Address Filtering 16

L

LED indicators 7

Live View Config 10

Logs & Reports 21

M

Maintenance 21

Motion Detection 6

N

NAT traversal 9, 18, 19

Network connector 6

Network Settings 17

NTP Server 17

P

Password 9, 16

Ports & Devices 20

Power connector 6

Proxy Settings 19

R

RCA connector 4, 6

Recovery 27

Resetting to Factory Default Settings 26

RS-422/RS-485 connector 4, 7

S

Security 16

Sequence Mode 23

Server Time 16

SMTP 20

SNMP 20

Status 13

Support 21

System Options 16

T

TCP/IP Settings 17

Time Mode 17

Troubleshooting 27

U

Upgrade Server 21

Upgrading the Firmware 27

UPnP 18, 20

V

Video Source 10

Free Manuals Download Website

<http://myh66.com>

<http://usermanuals.us>

<http://www.somanuals.com>

<http://www.4manuals.cc>

<http://www.manual-lib.com>

<http://www.404manual.com>

<http://www.luxmanual.com>

<http://aubethermostatmanual.com>

Golf course search by state

<http://golfingnear.com>

Email search by domain

<http://emailbydomain.com>

Auto manuals search

<http://auto.somanuals.com>

TV manuals search

<http://tv.somanuals.com>