

ASUS[®] 1710-S5

Intel[®] Xeon Tower/5U Rackmount Server
533MHz Front Side Bus Support

User Guide



Copyright © 2003 ASUSTeK COMPUTER INC. All Rights Reserved.

No part of this manual, including the products and software described in it, may be reproduced, transmitted, transcribed, stored in a retrieval system, or translated into any language in any form or by any means, except documentation kept by the purchaser for backup purposes, without the express written permission of ASUSTeK COMPUTER INC. ("ASUS").

ASUS provides this manual "as is" without warranty of any kind, either express or implied, including but not limited to the implied warranties or conditions of merchantability or fitness for a particular purpose. In no event shall ASUS, its directors, officers, employees, or agents be liable for any indirect, special, incidental, or consequential damages (including damages for loss of profits, loss of business, loss of use or data, interruption of business and the like), even if ASUS has been advised of the possibility of such damages arising from any defect or error in this manual or product.

Specifications and information contained in this manual are furnished for informational use only, and are subject to change at any time without notice, and should not be construed as a commitment by ASUS. ASUS assumes no responsibility or liability for any errors or inaccuracies that may appear in this manual, including the products and software described in it.

Product warranty or service will not be extended if: (1) the product is repaired, modified or altered, unless such repair, modification or alteration is authorized in writing by ASUS; or (2) the serial number of the product is defaced or missing.

Products and corporate names appearing in this manual may or may not be registered trademarks or copyrights of their respective companies, and are used only for identification or explanation and to the owners' benefit, without intent to infringe.

Product Name:	ASUS AP1710-S5
Manual Edition:	First Edition V1 (E1346)
Release Date:	July 2003

Contents

Notices	v
Safety information	vi
About this guide	viii
ASUS Contact Information	x
Chapter 1: Product introduction	1-1
1.1 System package contents	1-2
1.2 System specifications	1-3
1.3 Front panel features	1-4
1.4 Rear panel features	1-5
1.5 Internal features	1-6
1.6 LED information	1-7
Chapter 2: Hardware setup	2-1
2.1 Chassis cover	2-2
2.1.1 Removing the cover	2-2
2.1.2 Installing the cover	2-2
2.2 Motherboard information	2-3
2.3 Central Processing Unit (CPU)	2-4
2.3.1 Installing the CPU	2-5
2.3.2 Installing the heatsink and fan	2-6
2.4 System memory	2-8
2.4.1 Memory configurations	2-9
2.4.2 Installing a DIMM	2-10
2.4.3 Removing a DIMM	2-10
2.5 5.25-inch drives	2-11
2.5.1 Removing the front panel assembly	2-11
2.5.2 Installing a 5.25-inch drive	2-12
2.6 Hard disk drives	2-16
2.6.1 Installing a hard disk drive	2-16
2.7 Expansion cards	2-18
2.7.1 Installing a standard size expansion card	2-18
2.7.2 Installing a long expansion card	2-20
2.7.3 Removing an expansion card	2-21

Contents

2.8	Cable connections	2-22
2.8.1	Motherboard connections	2-22
2.8.2	SCSI backplane connections	2-23
2.9	Removable components	2-25
2.9.1	Chassis fan	2-25
2.9.2	HDD blower	2-26
2.9.3	Floppy disk drive	2-27
2.9.4	Power supply modules	2-29
2.9.5	Power supply case	2-30
2.9.6	Roller wheels	2-32
Appendix	A-1
A.1	Simple fixes	A-2
A.2	Redundant power module specification	A-4

Notices

Federal Communications Commission Statement

This device complies with FCC Rules Part 15. Operation is subject to the following two conditions:

- This device may not cause harmful interference, and
- This device must accept any interference received including interference that may cause undesired operation.

This equipment has been tested and found to comply with the limits for a Class B digital device, pursuant to Part 15 of the FCC Rules. These limits are designed to provide reasonable protection against harmful interference in a residential installation. This equipment generates, uses and can radiate radio frequency energy and, if not installed and used in accordance with manufacturer's instructions, may cause harmful interference to radio communications. However, there is no guarantee that interference will not occur in a particular installation. If this equipment does cause harmful interference to radio or television reception, which can be determined by turning the equipment off and on, the user is encouraged to try to correct the interference by one or more of the following measures:

- Reorient or relocate the receiving antenna.
- Increase the separation between the equipment and receiver.
- Connect the equipment to an outlet on a circuit different from that to which the receiver is connected.
- Consult the dealer or an experienced radio/TV technician for help.



WARNING! The use of shielded cables for connection of the monitor to the graphics card is required to assure compliance with FCC regulations. Changes or modifications to this unit not expressly approved by the party responsible for compliance could void the user's authority to operate this equipment.

Canadian Department of Communications Statement

This digital apparatus does not exceed the Class B limits for radio noise emissions from digital apparatus set out in the Radio Interference Regulations of the Canadian Department of Communications.

This class B digital apparatus complies with Canadian ICES-003.

Safety information

Electrical Safety

- Before installing or removing signal cables, ensure that the power cables for the system unit and all attached devices are unplugged.
- To prevent electrical shock hazard, disconnect the power cable from the electrical outlet before relocating the system.
- When adding or removing any additional devices to or from the system, ensure that the power cables for the devices are unplugged before the signal cables are connected. If possible, disconnect all power cables from the existing system before you add a device.
- If the power supply is broken, do not try to fix it by yourself. Contact a qualified service technician or your dealer.

Operation Safety

- Any mechanical operation on this server must be conducted by certified or experienced engineers.
- Before operating the server, carefully read all the manuals included with the server package.
- Before using the server, make sure all cables are correctly connected and the power cables are not damaged. If any damage is detected, contact your dealer as soon as possible.
- To avoid short circuits, keep paper clips, screws, and staples away from connectors, slots, sockets and circuitry.
- Avoid dust, humidity, and temperature extremes. Place the server on a stable surface.

Caution!

This product is equipped with a three-wire power cable and plug for the user's safety. Use the power cable with a properly grounded electrical outlet to avoid electrical shock.

Lithium-Ion Battery Warning

CAUTION! Danger of explosion if battery is incorrectly replaced. Replace only with the same or equivalent type recommended by the manufacturer. Dispose of used batteries according to the manufacturer's instructions.

CD-ROM Drive Safety Warning

CLASS 1 LASER PRODUCT



- Electrical hazard, do not remove chassis cover.
- This equipment is to be serviced by a trained personnel only.

About this guide

Audience

This user guide is intended for system integrators, and experienced users with at least basic knowledge of configuring a server.

Contents

This guide contains the following parts:

1. Chapter 1: Product Introduction

This chapter describes the general features of the AP1710-S5 server. It includes sections on front panel and rear panel specifications.

2. Chapter 2: Hardware setup

This chapter lists the hardware setup procedures that you have to perform when installing or removing system components.

3. Appendix

This appendix lists the common problems that you may encounter while using the AP1710-S5 server. It lists the possible causes of the problems and offers solutions. You may refer to this part and try to solve simple problems before calling customer support. The appendix also contains the redundant power module specifications for your reference.

Conventions

To make sure that you perform certain tasks properly, take note of the following symbols used throughout this manual.



WARNING: Information to prevent injury to yourself when trying to complete a task.



CAUTION: Information to prevent damage to the components when trying to complete a task.



IMPORTANT: Information that you **MUST** follow to complete a task.



NOTE: Tips and information to aid in completing a task.

References

Refer to the following sources for additional information and for product and software updates.

1. **ASUS PRL-DL Motherboard User Manual**

This manual contains detailed information about the PRL-DL motherboard.

2. **ASUS Websites**

The ASUS websites worldwide provide updated information on ASUS hardware and software products. The ASUS websites are listed in the ASUS contact information on page x.

3. **Optional Documentation**

Your product package may include optional documentations such as CD-ROM manual, warranty flyers, and others that may have been added by your dealer. These documents are not part of the standard server package.

ASUS Contact Information

ASUSTeK COMPUTER INC. (Asia-Pacific)

Address: 150 Li-Te Road, Peitou, Taipei, Taiwan 112
General Tel: +886-2-2894-3447
General Fax: +886-2-2894-7798
General Email: info@asus.com.tw

Technical Support

MB/Components (Tel): +886-2-2890-7121 (English)
Notebook (Tel): +886-2-2890-7122 (English)
Desktop/Server (Tel): +886-2-2890-7123 (English)
Support Fax: +886-2-2890-7698
Web Site: www.asus.com.tw

ASUS COMPUTER INTERNATIONAL (America)

Address: 44370 Nobel Drive, Fremont, CA 94538, USA
General Fax: +1-502-933-8713
General Email: tmd1@asus.com
Web Site: usa.asus.com

Technical Support

Support Fax: +1-502-933-8713
General Support: +1-502-995-0883
Notebook Support: +1-877-918-ASUS (2787)
Support Email: tsd@asus.com

ASUS COMPUTER GmbH (Germany and Austria)

Address: Harkort Str. 25, D-40880 Ratingen, Germany
Website Address: www.asuscom.de
Online Contact: www.asuscom.de/sales
Telephone: +49-2102-95990
General Fax: +49-2102-959911

Technical Support

Component Support: +49-2102-95990
Notebook Support: +49-2102-959910
Support Fax: +49-2102-959911
Online Support: www.asuscom.de/support

Chapter 1

This chapter describes the general features of the AP1710-S5 server. It includes sections on front panel and rear panel specifications.

Product introduction

1.1 System package contents

Check your ASUS AP1710-S5 package for the following items. Contact your dealer immediately if any of the items is damaged or missing.

1.1.1 Standard items

1. ASUS AS-35 Tower/5U Rackmount chassis including:
 - ASUS PRL-DL motherboard
 - 500W redundant power supply with single power module
 - BP6LS-AS 35 SCSI backplane board
 - CD-ROM drive
 - floppy disk drive
 - chassis fan
 - hot-swap SCSI hard disk drive trays (6 units)
 - chassis roller wheels (4 sets)
 - special CPU heatsink and fan assembly (2 sets)
2. ASUS PXL-S30 Ultra320 dual-channel SCSI RAID card
3. AC power cable
4. System screws and labels
5. Keys (2 pieces)
6. Support CDs
 - AP1710-S5 support CD including drivers, utilities, ASUS System Monitoring Agent (ASMA), and ASUS Server Web-Based Management (ASWM)
 - Trend Micro ServerProtect anti-virus software CD
7. Documentation
 - ASUS AP1710-S5 user guide
 - ASUS PRL-DL user guide
 - ASUS ASMS (ASMA+ASWM) user guide

1.1.2 Optional items

- ASUS AS-35 5U rackmount rail kit
- ASUS PXI-G45 Gb LAN Card
- LSI MegaRaid 320-I single channel-RAID card

1.2 System specifications

The ASUS AP1710-S5 server is a stylish server system featuring the ASUS PRL-DL motherboard. The server supports the Intel® Xeon™ processor in a 604-pin socket, and includes the latest I/O, LAN, and storage technologies through the chipsets embedded on the motherboard.

Chassis	Pedestal or rackmount 5U with removable front door bezel and chassis foot stand or roller-wheels.
Motherboard	ASUS PRL-DL (Extended ATX form factor: 12 in x 10.5 in)
Chipset	RCC Grand Champion SL Server 3.1 (GCSL) RCC Champion South Bridge 6.0 (CSB6)
Memory	Supports four 184-pin DDR PC2100/PC1600 registered ECC DDR DIMMs for up to 4GB system memory
Processor	Supports dual Intel® Xeon™ processors
Network Controller	Intel® 82540 Gigabit Ethernet controller
Drive Controller	LSI 53C1030/64-bit Dual-Ultra160 channels 2 x UltraDMA100 IDE channels 1 x ATA66 IDE channel
Graphics	ATI RAGE-XL PCI with 8MB PC100 SDRAM memory
Onboard I/O	PS/2 mouse/keyboard port, serial port, 15-pin VGA port, floppy disk drive connector, 3 x IDE connectors, 4 x USB ports (2 in front, 4 in rear panel), RJ-45 LAN port and 2 x 68-pin SCSI connectors
Expansion Slots	4 x 64-bit/33Mhz 3V PCI slot 1 x 32-bit/33Mhz 5V PCI slot
Drive Bays	1 x 3.25-inch FDD bay 3 x 5.25-inch drive bays 6 x hot-swap trays for 80-pin SCH2 SCSI hard drives
Management	ASUS System Monitoring Agent (ASMA) ASUS Server Web-based Management (ASWM)
Hardware Monitors	Voltage, temperature, and fan speed monitoring Automatic System Restart (ASR) feature
Power Supply	500W redundant power supply

1.3 Front panel features

The AP1710-S5 chassis displays a stylish front bezel with lock. The bezel covers the system components on the front panel and serves as security. Open the bezel to access the front panel components.

The power and reset buttons, LED indicators, CD-ROM drive, floppy drive, and two USB ports are located on the front panel. For future installation of 5.25-inch devices, two drive bays are available.

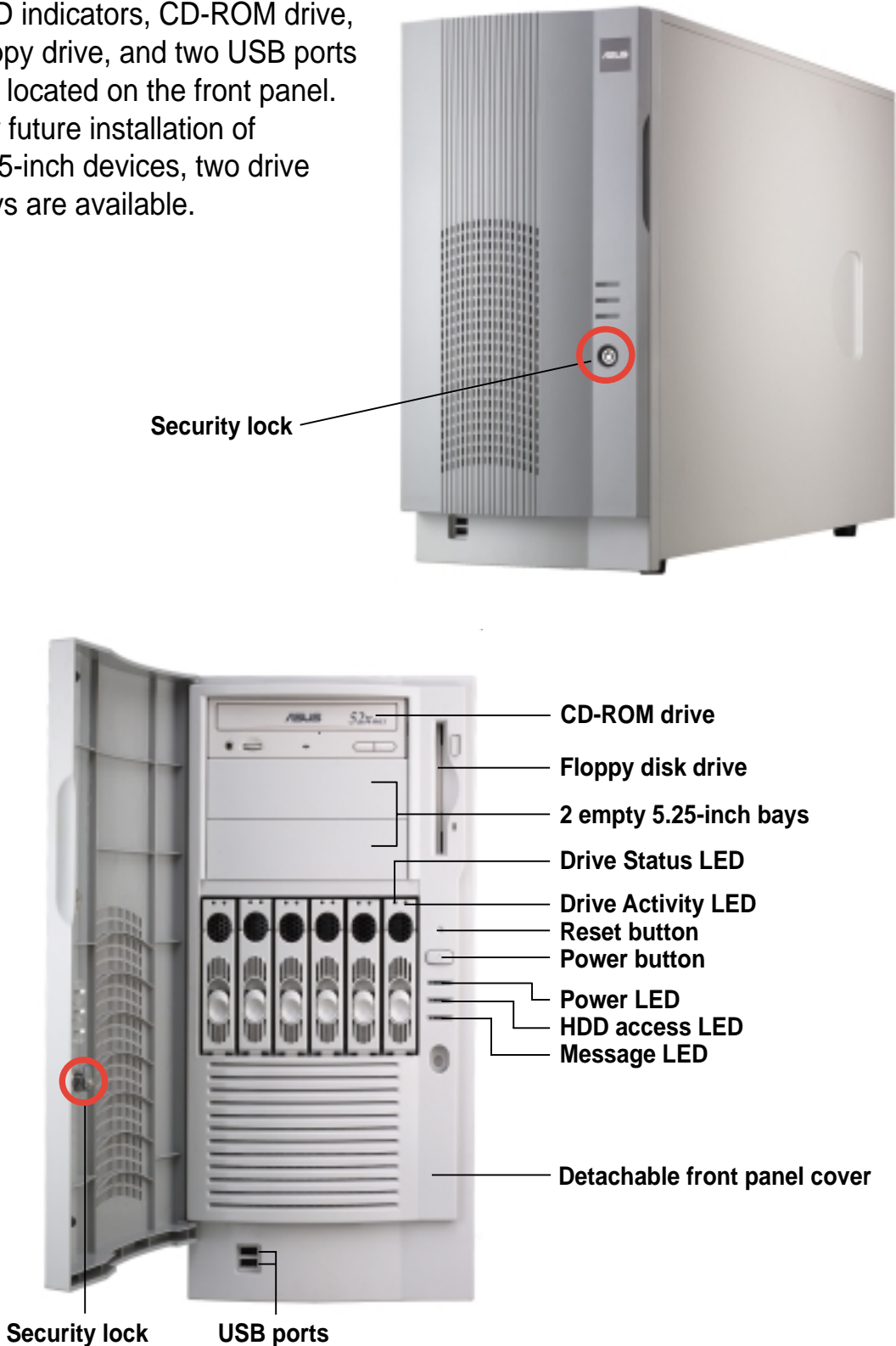

1.4. Rear panel features

The rear panel includes a slot for the motherboard rear I/O ports, six full-length expansion slots, a chassis lock and intrusion switch, a vent for the system fan, and redundant power supply modules.

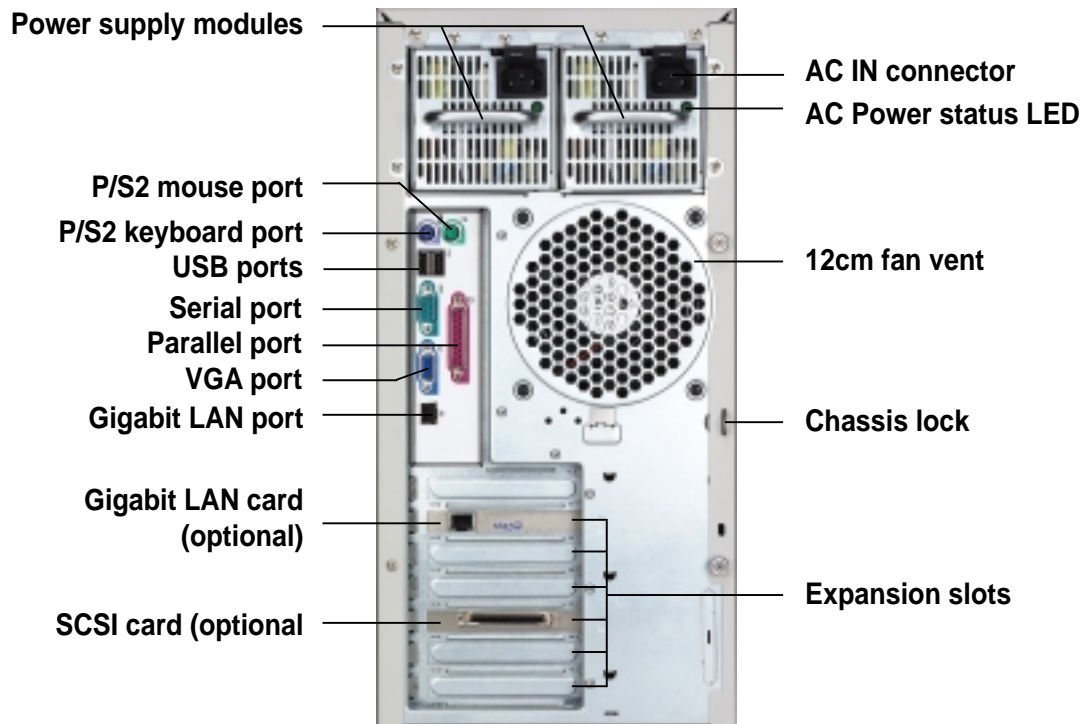

1.5 Internal features

The AP1710-S5 chassis includes the basic components as shown in the picture below.

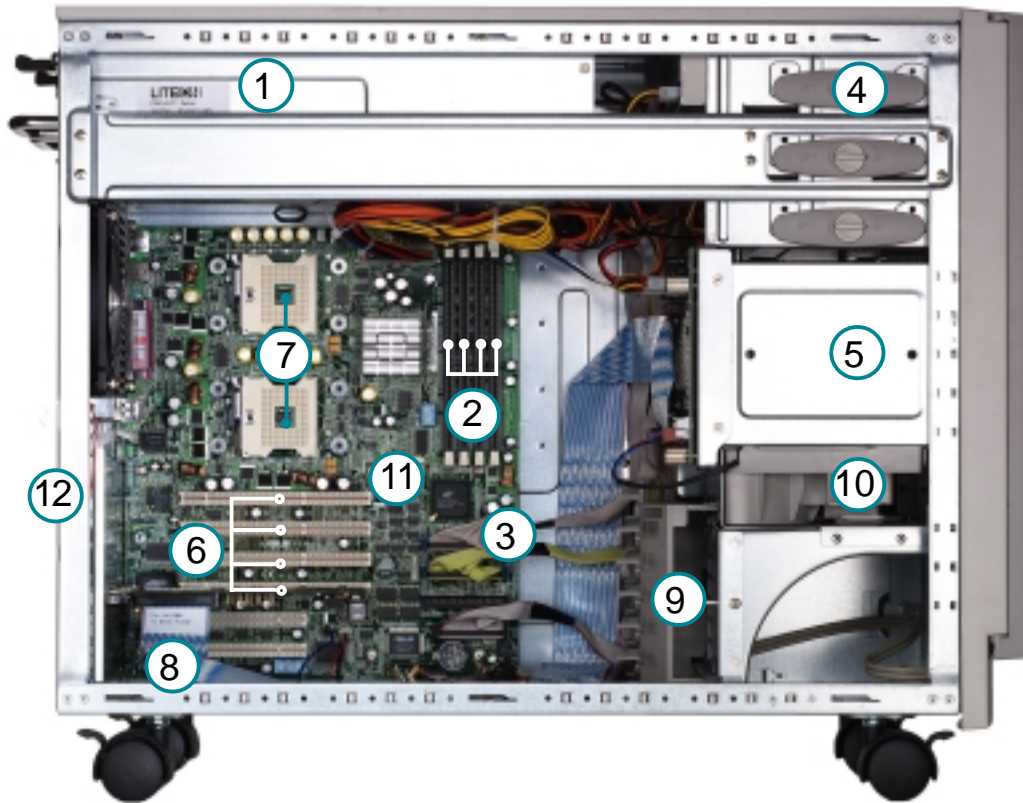

- | | |
|--------------------------------|----------------------------------|
| 1. Redundant power supply cage | 7. CPU sockets |
| 2. DDR DIMM sockets | 8. Internal 68-pin SCSI cable |
| 3. IDE connectors | 9. PCI long card support guide |
| 4. CD-ROM drive | 10. 12 cm hot swap module blower |
| 5. HDD hot swap modules | 11. PRL-DL motherboard |
| 6. 64-bit 3V PCI slots | 12. Chassis intrusion sensor |

1.6 LED information

The AP1710-S5 comes with five LED indicators. Refer to the picture for the LED location and the following table for the LED status description



LED	Icon	Display	Description
Drive Status LED		Green Red Red-Blinking	Bridge board connected to backplane Installed HDD is in good condition HDD failure HDD rebuilding using the RAID card SAF-TE* function
Drive Activity LED		Blinking	Read/write data into the HDD
Power LED		ON Blinking	System power ON Suspend mode
HDD Access LED		OFF Blinking	No activity Read/write data into the HDD
Message LED		OFF Blinking	System is normal; no incoming event ASMS indicates a HW monitor event

*SCSI Access Fault-Tolerant Enclosure



The Power, HDD Access and Message LEDs are visible even if the system front bezel is closed.

Chapter 2

This chapter lists the hardware setup procedures that you have to perform when installing or removing system components.

Hardware setup

2.1 Chassis cover

Before proceeding, prepare a Phillips and a flat head screw drivers that you might need to facilitate installation.

2.1.1 Removing the cover

1. Loosen the two thumb screws that hold the cover in place.
2. Slide the side cover for about half an inch to disengage it from the chassis.

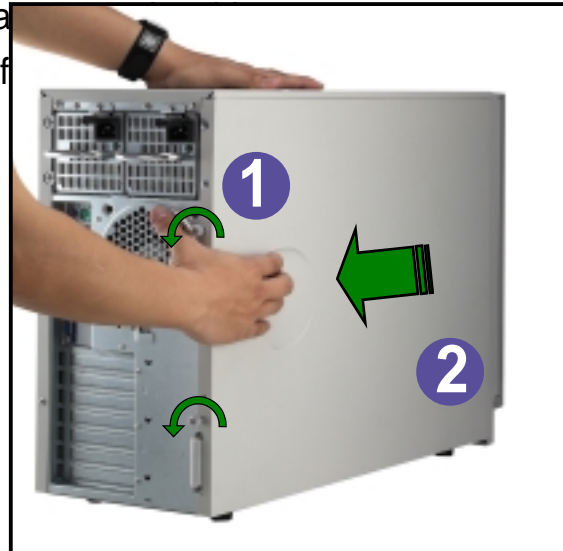

2.1.2 Installing the cover

1. Match and insert the hooks of the cover to the elongated holes on the side of the chassis. All the six hooks (three each on the top and bottom) of the cover must properly fit the designated holes.
2. Slide the cover toward the front until it snaps in place.
3. Tighten the thumb screws to secure the cover.

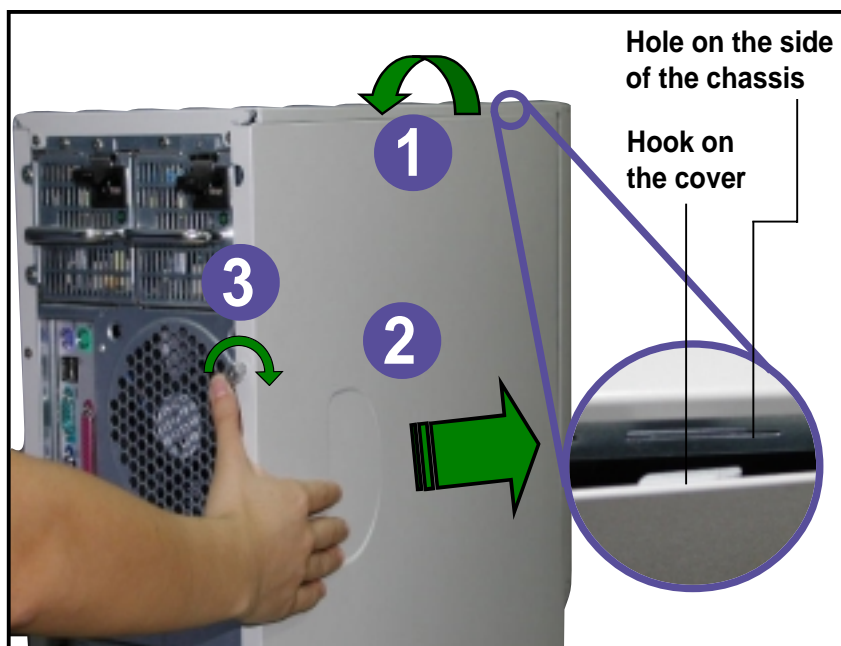

2.2 Motherboard information

The AP1710-S5 comes with the ASUS PRL-DL motherboard that uses the extended ATX form factor measuring 12 inches x 10.5 inches (30.5 x 26.67 cm).



Make sure to unplug the power cord before installing or removing any motherboard component or connection. Failure to do so may cause you physical injury and may damage motherboard components.

The motherboard is secured in the chassis by nine (9) screws as indicated by circles in the illustration below.

This side towards
the rear of the chassis

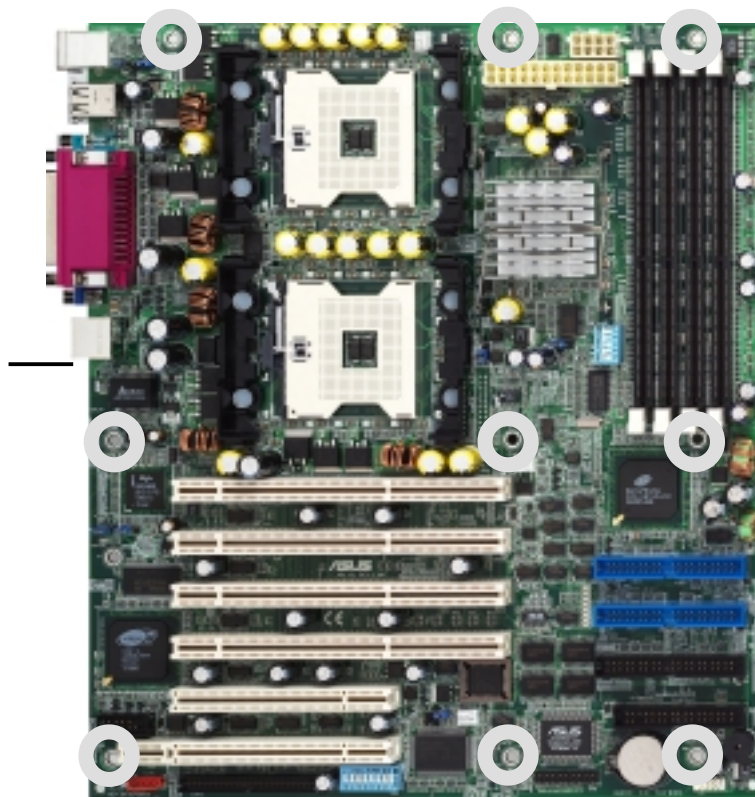

Refer to the motherboard user guide for detailed information on the motherboard.

2.3 Central Processing Unit (CPU)

The motherboard comes with dual surface mount 604-pin Zero Insertion Force (ZIF) sockets. The sockets are designed for the Intel® processors in the 604-pin package with 512KB L2 cache. The processor includes the Intel® NetBurst™ micro-architecture that features the hyper-pipelined technology, rapid execution engine, 533/400MHz system bus, and execution trace cache. Together, these attributes improve system performance by allowing higher core frequencies, faster execution of integer instructions, and data transfer rate of up to 4.26GB/s.

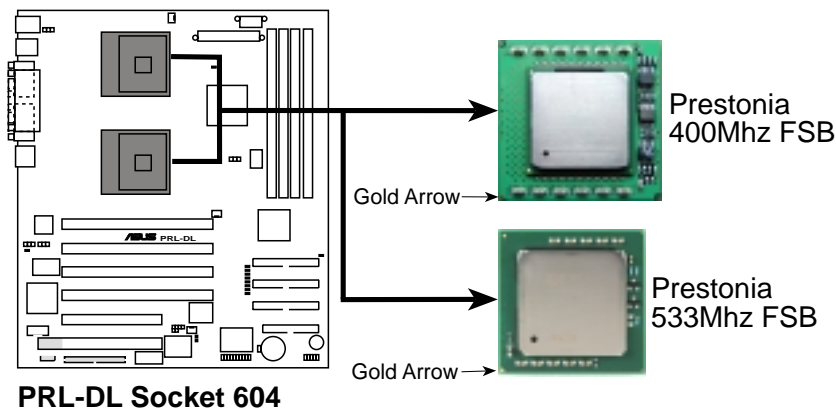

Note in the illustration that the CPU has a gold triangular mark on one corner. This mark indicates the processor Pin 1 that should match a specific corner of the CPU socket.



Incorrect installation of the CPU into the socket may bend the pins and severely damage the CPU!

CPU Socket 2
(outer socket)

CPU Socket 1
(inner socket)

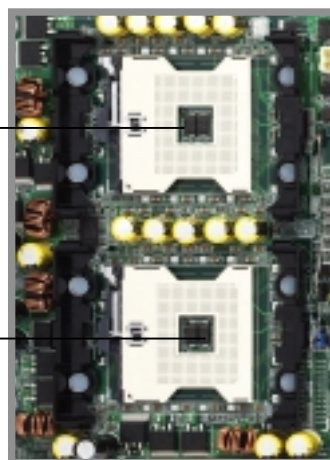

2.3.1 Installing the CPU



The motherboard supports either one or two CPUs. If you are installing only one CPU, you **MUST** install it in CPU socket 1.

Follow these steps to install a CPU.

1. Locate the 604-pin ZIF sockets on the motherboard. Unlock the socket by pressing the lever sideways, then lift it up to at least 115° angle.

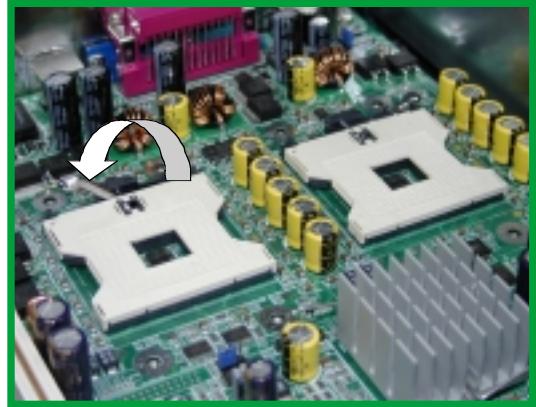

Make sure that the socket lever is lifted up to at least 115° angle, otherwise the CPU does not fit in completely.

2. Position the CPU above the socket as shown.
3. Carefully insert the CPU into the socket until it fits in place.

Marked Corner

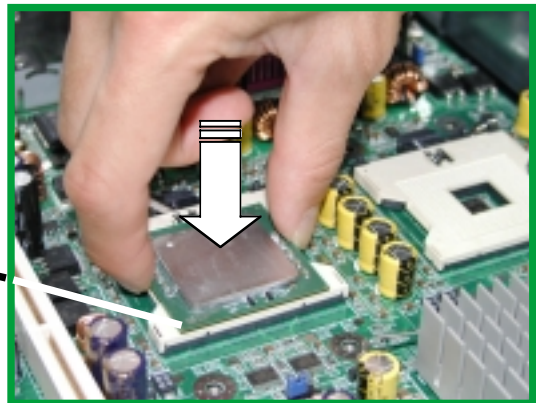

The CPU fits only in one correct orientation. **DO NOT** force the CPU into the socket to prevent bending the pins and damaging the CPU!

4. When the CPU is in place, press it firmly on the socket while you push down the socket lever to secure the CPU. The lever clicks on the side tab to indicate that it is locked.

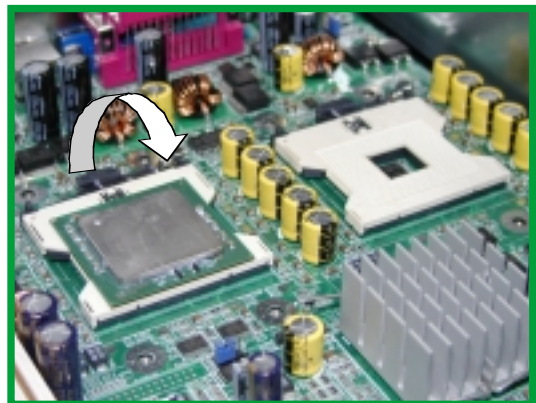

2.3.2 Installing the heatsink and fan

The Intel® Xeon™ processors require specially designed heatsink and fan assembly to ensure optimum thermal condition and performance.

Make sure that the heatsink with fan assembly is properly installed on the motherboard. A tilted or improperly installed heatsink and fan assembly can cause damage to motherboard CPU socket and/or CPU. To install the CPU heatsink and fan:

1. Place the heatsink with fan assembly on top of the installed CPU. Make sure it fits the screw holes of the heatsink bracket at the bottom of the CPU socket. (The heatsink bracket is pre-installed in the motherboard.)



2. Tighten all four (4) screws. Make sure all screws fit properly in place.



Take caution in tightening screws. Do not over-tighten screws, doing so may damage the motherboard!



TIP: Follow the sequence shown: half-tighten the screw on one corner of the heatsink and fan, then the next screw on the other corner and so on, making a cross pattern. Repeat until all four screws are tightened properly.



Make sure heatsink with fan assembly is mounted properly on the CPU to avoid burning the CPU and/or CPU socket.

3. When the heatsink and fan assembly is in place, connect the fan cable to the fan connector on the motherboard labeled CPUFAN1.



The fan cable plug is slotted so it fits only in one orientation. If it doesn't fit completely, try reversing it.

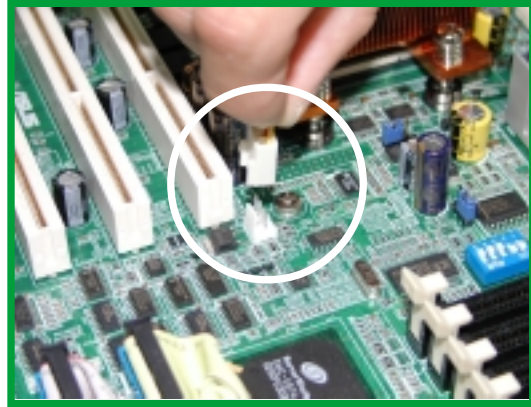

4. Make sure that the heatsink and fan assembly is stable in place and the fan power cable are connected properly.



Don't forget to connect the CPU fan cable. Hardware monitoring errors may occur if you fail to plug the fan cable.

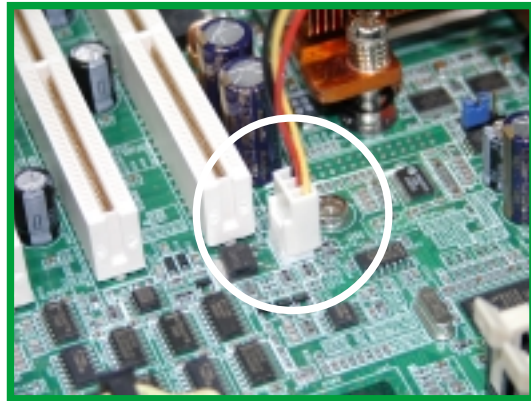

5. Repeat the same steps if you will install another CPU in the second CPU socket.



6. Use CPUFAN2 connector for the second CPU heatsink and fan assembly cable.

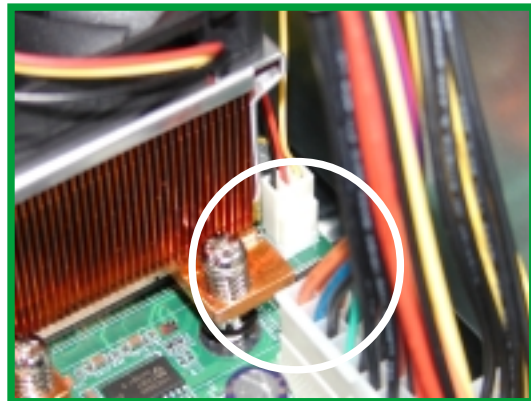

2.4 System memory

The motherboard comes with four Double Data Rate (DDR) Dual Inline Memory Module (DIMM) sockets. These sockets support up to 4GB system memory using 184-pin registered PC2100/PC1600 DIMMs with Serial Presence Detect (SPD) and Error Check and Correction (ECC).

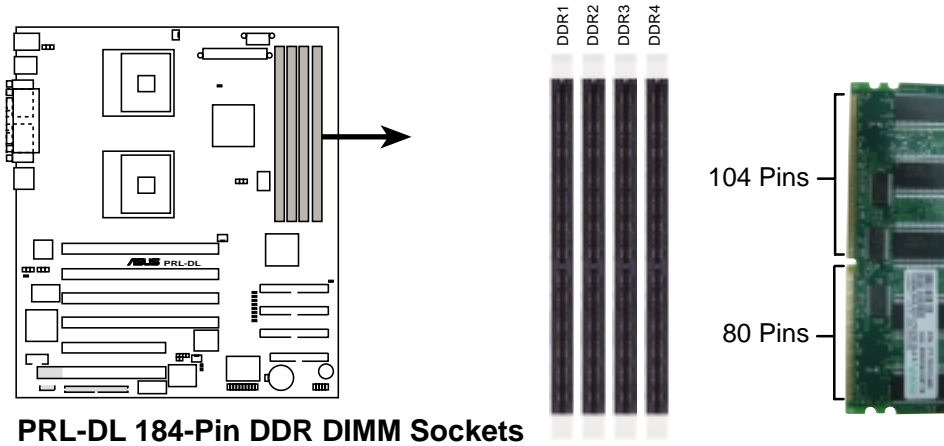

A DDR DIMM is keyed with a notch so that it fits in only one direction. DO NOT force a DIMM into a socket to avoid damaging the DIMM.

The DDR SDRAM technology evolved from the mainstream PC66, PC100, PC133 memory known as Single Data Rate (SDR) SDRAM. DDR memory however, has the ability to perform two data operations in one clock cycle, thus providing twice the throughput of SDR memory. For example, a 200MHz DDR DIMM will support a 100MHz memory bus, and a 266MHz DDR DIMM will support a 133MHz memory bus.

DDR Data Transfer Rate		DDR Base Frequency
266MHz	➔	133MHz
200MHz	➔	100MHz

A DDR DIMM has the same physical dimensions as an SDR DIMM, but it has a 184-pin footprint compared to the 168-pin of the SDR DIMM. Also, a DDR DIMM is single notched while an SDR DIMM is double notched. Therefore, a DDR DIMM is not backward compatible with SDR, and should be installed only in a socket specially designed for DDR DIMMs.

2.4.1 Memory configurations

The motherboard supports system memory of up to 4GB in a one-way non-interleaved configuration.

Memory configuration table

DIMM Socket	184-pin ECC DDR DIMM	Total Memory
DDRA1	SDRAM 128MB, 256MB, 512MB, 1GB, 2GB (x1) =	
DDRA2	SDRAM 128MB, 256MB, 512MB, 1GB, 2GB (x1) =	
DDRB1	SDRAM 128MB, 256MB, 512MB, 1GB, 2GB (x1) =	
DDRB2	SDRAM 128MB, 256MB, 512MB, 1GB, 2GB (x1) =	
Total System Memory (Max. 4GB)		=



The system chipset only supports PC2100/PC1600 registered ECC DIMMs. Make sure to use only the specified DIMM types for stable system operation.

2.4.2 Installing a DIMM



Make sure to unplug the power supply before adding or removing DIMMs or other system components. Failure to do so may cause severe damage to both the motherboard and the components.

Follow these steps to install a DIMM.

1. Unlock a DIMM socket by pressing the retaining clips outward.
2. Align a DIMM on the socket such that the notch on the DIMM matches the break on the socket.

Unlocked Retaining Clip

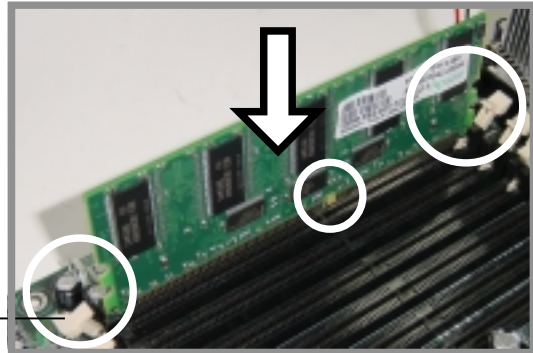

3. Firmly insert the DIMM into the socket until the retaining clips snap back in place and the DIMM is properly seated.

Locked Retaining Clip

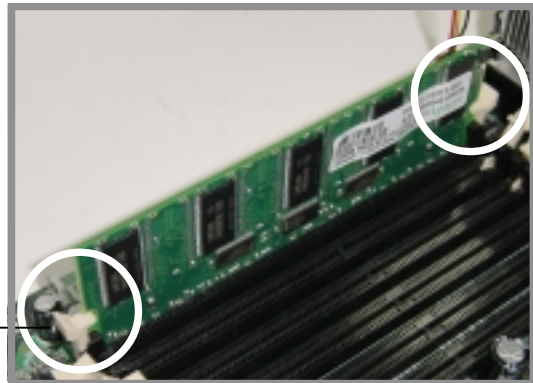

2.4.3 Removing a DIMM

Follow these steps to remove a DIMM.

1. Press the retaining clips outward simultaneously to unlock the DIMM.
2. Remove the DIMM from the socket.

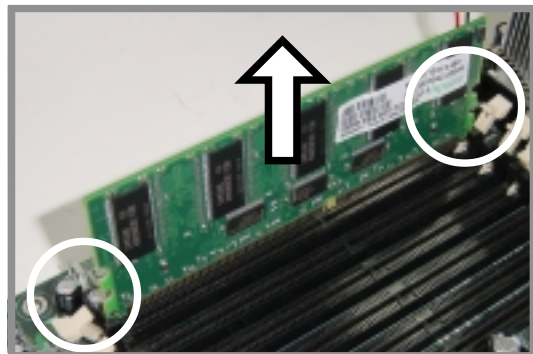

Support the DIMM lightly with your fingers when pressing the retaining clips. The DIMM might get damaged when it flips out with extra force.

2.5 5.25-inch drives



If you have previously used and powered up the system, and that it may be connected to an AC power source, make sure to unplug the power cable before installing or removing any system components. Failure to do so may cause severe damage to the motherboard and other system components!

Three 5.25-inch drive bays are located on the upper front part of the chassis. A CD-ROM drive that comes standard with the system package occupies the uppermost bay (*labeled 1*). The two lower bays (*labeled 2 and 3*) are available for additional 5.25-inch devices.



2.5.1 Removing the front panel assembly



Before you can install a 5.25-inch drive, you should first remove the front panel assembly (front bezel and front panel cover). The front panel assembly is attached to the chassis through four **hooked tabs** on the left side and four **hinge-like tabs** on the right side.

To remove the front panel assembly:

1. Use a flat-head screwdriver to detach the hooked tabs from the left side of the front panel.

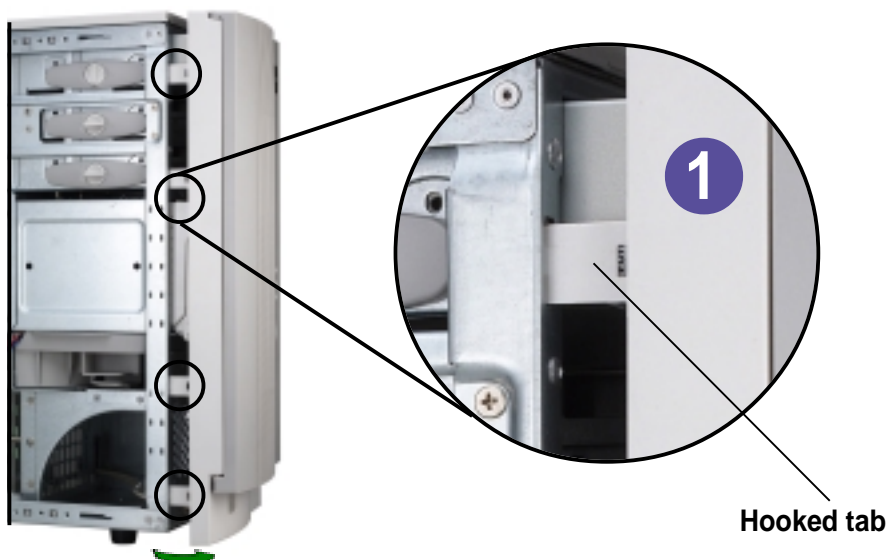

2. Pull and swing the left edge of the front panel outward.
3. Unhook the hinge-like tabs from the holes on the right side of the front panel to completely detach the front panel assembly from the chassis.

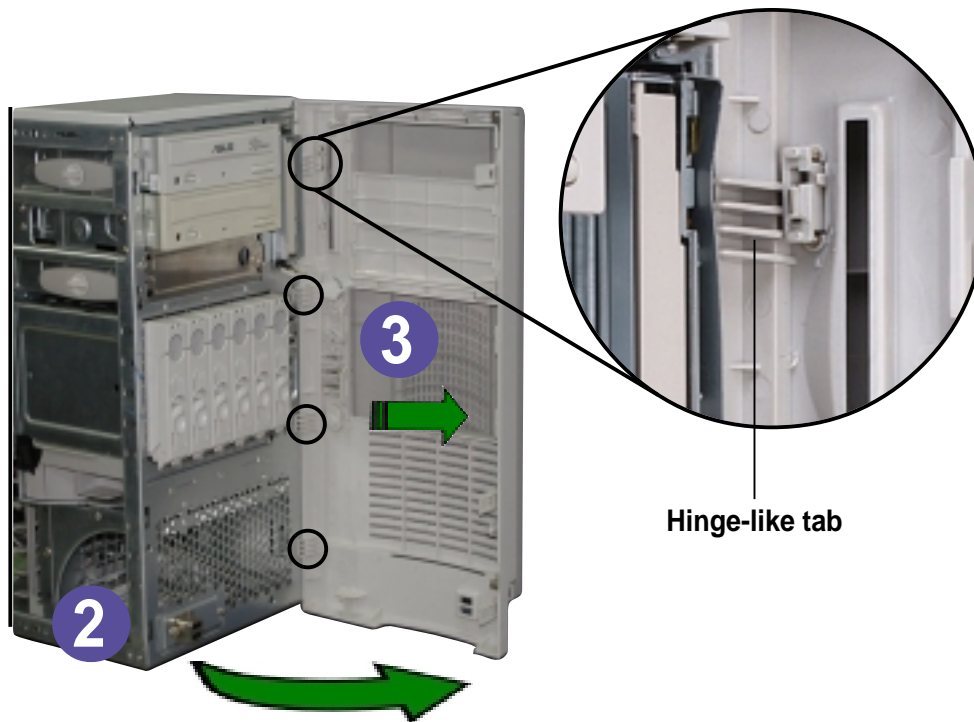

Do not use too much force when removing the front panel assembly..

2.5.2 Installing a 5.25-inch drive

To install a 5.25-inch drive:

1. Remove the metal cover of the bay where you wish to install the drive by pulling the cover outward.



- From the side of the drive bay, unlock and remove the screwless drive bay lock by turning the knob 45° counter-clockwise until it clicks on the reference point near the “unlocked icon.”

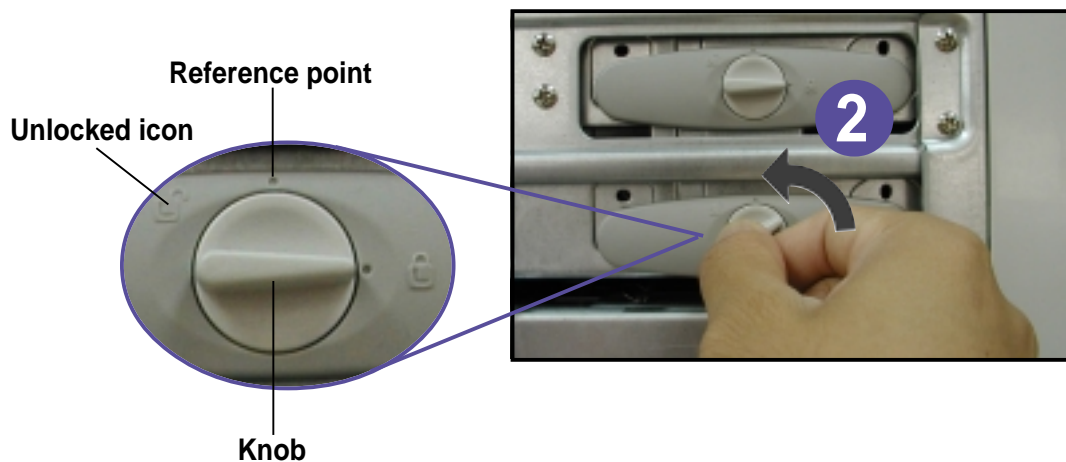

- When released, pull out the drive bay lock and set it aside.



- Carefully insert a 5.25-inch drive (such as a CD/DVD-ROM drive) into the bay until it is in place.



The drive is in place when the screw holes on the drive align with the holes on the side of the bay.

5. Secure the drive to the bay using the screwless drive bay lock that you removed earlier.
 - a. Match the two pegs on the lock to the holes on the drive bay.
 - b. Turn the knob 45° clockwise until it clicks on the reference point near the “locked icon.”

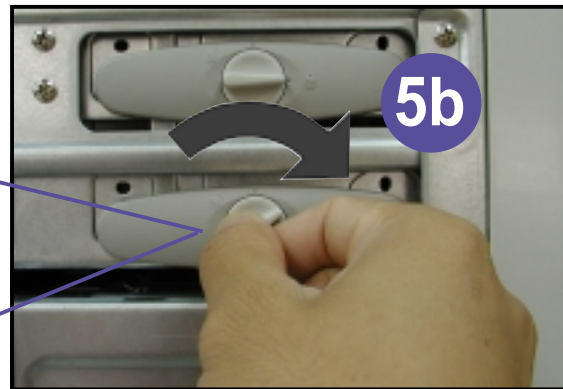
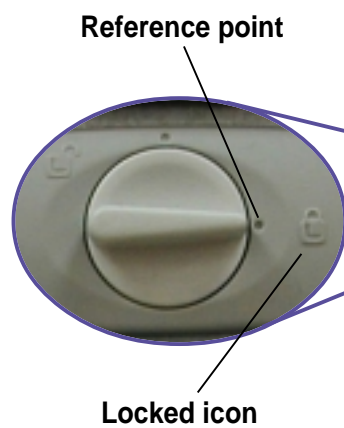
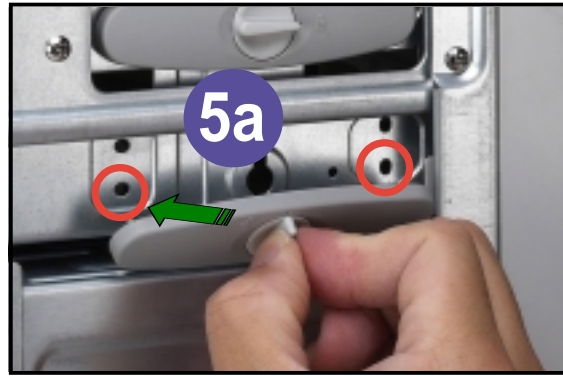

6. On the front panel assembly, detach the plastic bay cover opposite the 5.25-inch drive that you installed by pressing the two hooked tabs on each side of the bay cover.

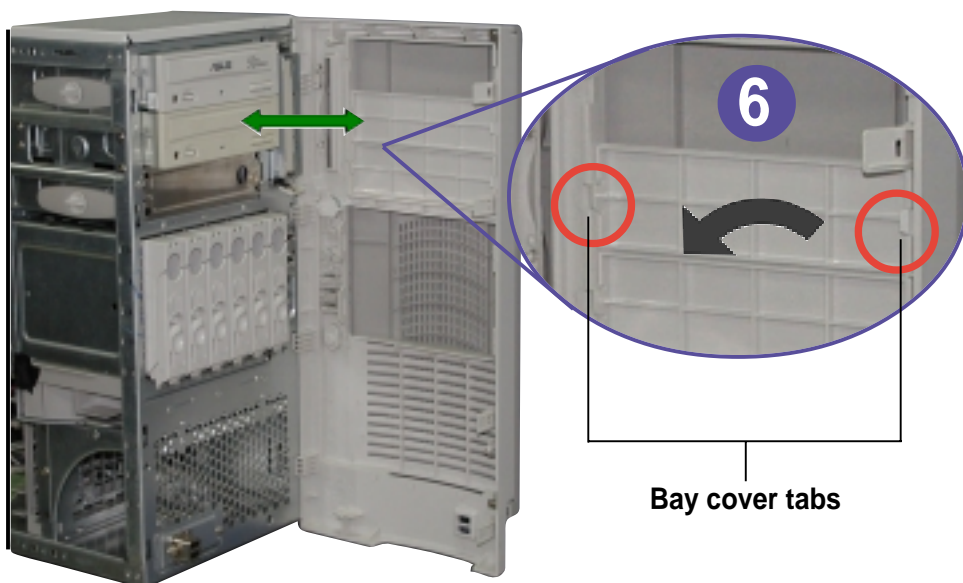

7. Re-install the front panel assembly (front bezel and front panel cover).
 - a. Insert the four hinge-like tabs to the holes on the right edge of the chassis.
 - b. Swing the front panel to the left and fit the four (4) hooked tabs to the left side of the chassis until the tabs snap in place.

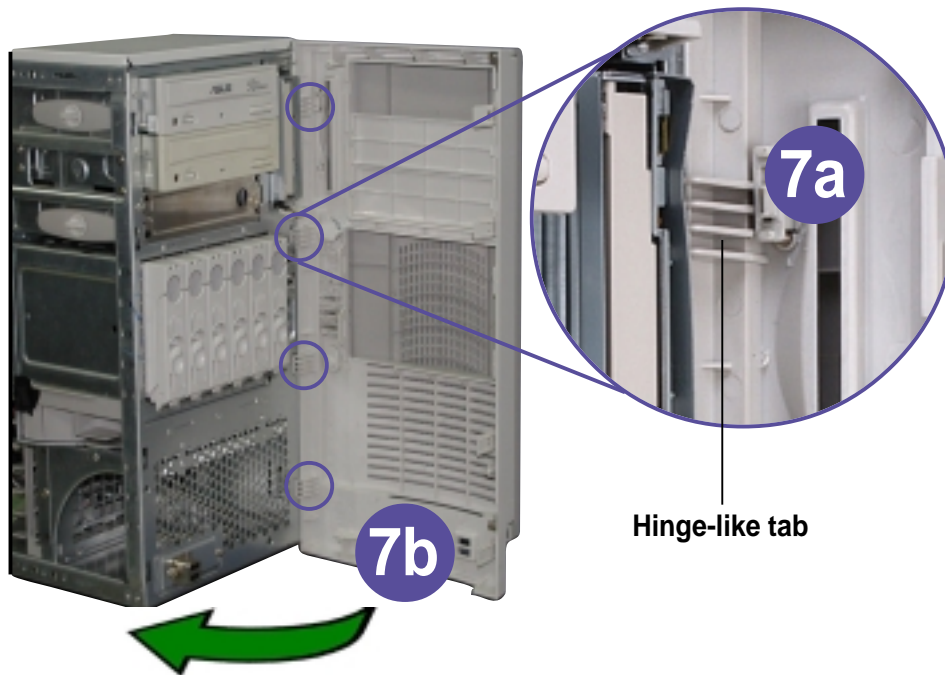

2.6 Hard disk drives

The AP1710-S5 comes with six externally accessible drive bays. In each drive bay is a removable tray for mounting an SCA SCSI hard disk drive.

2.6.1 Installing a hard disk drive

Follow these steps to install a SCSI hard disk drive.

1. Open the front panel door.
2. Release the drive bay by lifting the spring lock upwards, then pull the tray lever outwards.



Spring lock

3. The tray will slightly eject after the tray lever is pulled down. Pull the hard disk drive tray out from the chassis.

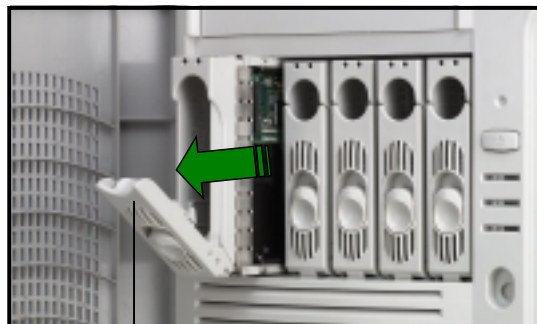

Tray lever

4. Place an SCA SCSI hard drive into the drive tray. Secure the drive with four (4) round head screws.

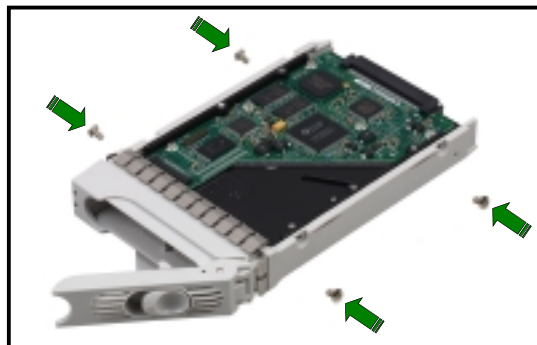

5. Insert the hard disk drive tray into the bay until it fits.
6. Push the tray lever back in place.

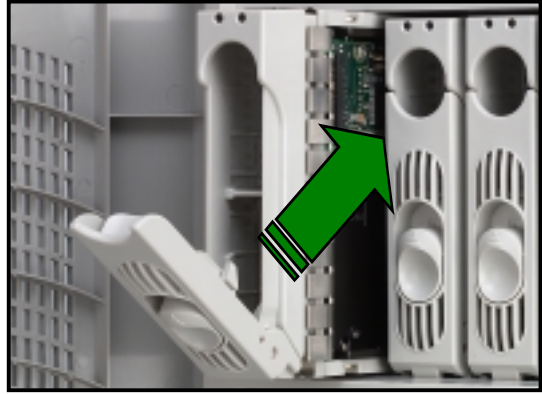

Make sure that the HDD tray is completely in place before you push the handle back to avoid damaging the drive and the tray.

2.7 Expansion cards

The chassis is designed with a screwless expansion slot frame on the rear panel. This design feature allows you to install or remove an expansion card in less steps.



Make sure to unplug the power cord before installing or removing expansion cards. Failure to do so may cause physical injury, and damage to the card and motherboard components!

2.7.1 Installing a standard size expansion card

To install an expansion card:

1. Release the card lock.
 - a. Press the card lock lever.
 - b. The card lock flips up.

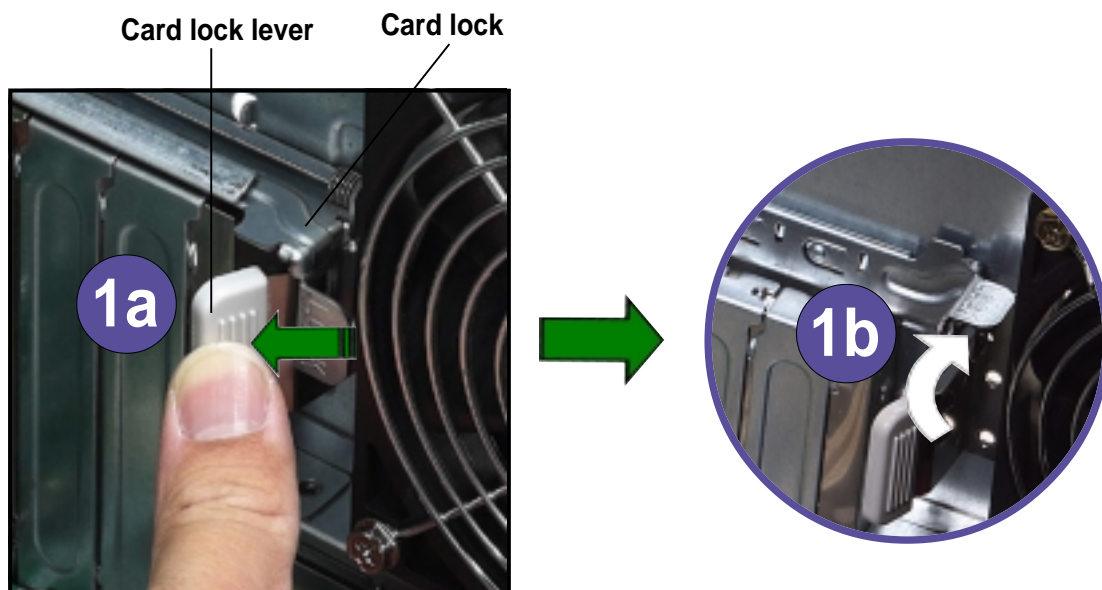

2. Slide out the metal bracket opposite the PCI slot where you wish to install the expansion card. You may use a flat-head screwdriver to easily remove the bracket.

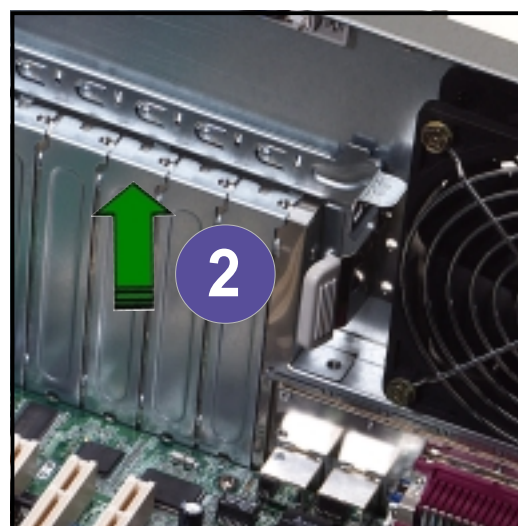

3. Install the expansion card making sure that it is properly seated on the slot.

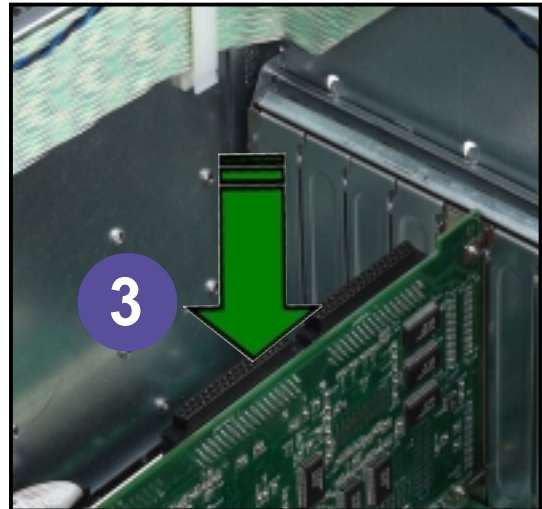

4. Press the end of the card lock marked "LOCK" to secure the card on the slot. A light click indicates that the card is locked in place.

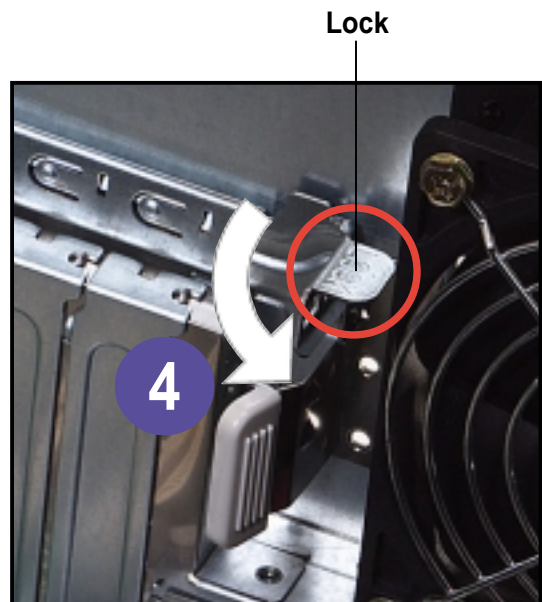

Refer to the card documentation for the card configuration details, and to the motherboard user guide in case you need to configure any jumpers after installing the expansion card.

2.7.2 Installing a long expansion card

If you are installing a long expansion card, such as some types of RAID cards, use the plastic card support located near the front of the chassis (under the backplane board) to keep the expansion cards firmly seated on the slots. This card support has individual card guides that correspond to each expansion slot.



Plastic long-card support

To install a long expansion card:

1. Position the expansion card above the PCI slot that you wish to use.
2. Insert one end of the card to the card guide opposite the PCI slot, and align the bracket end of the card to the expansion slot on the rear panel.
3. Slide in the card down until it is properly seated on the slot.
4. Secure the card using the screwless lock on the card guide.

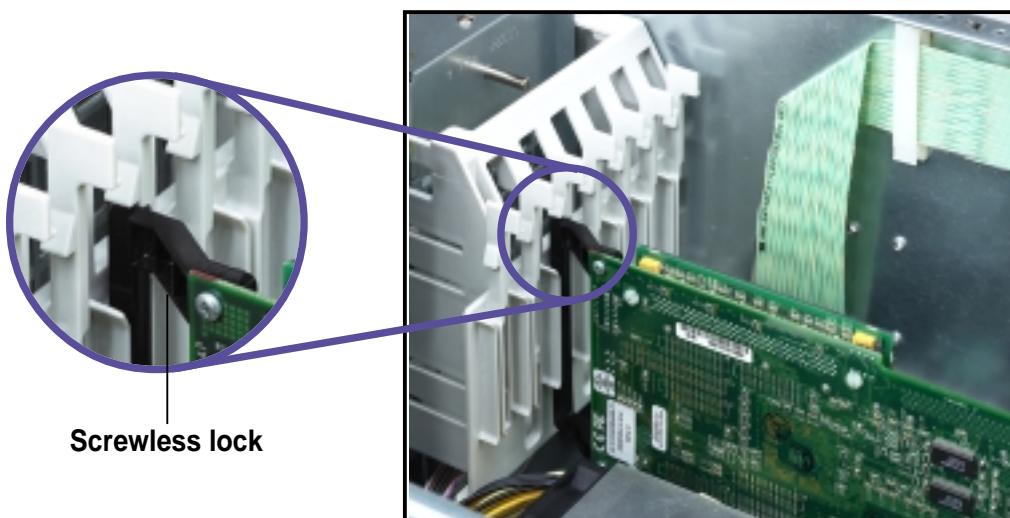

Screwless lock

2.7.3 Removing an expansion card

To remove an expansion card:

1. Release the card lock.
 - a. Press the card lock lever.
 - b. The card lock flips up.

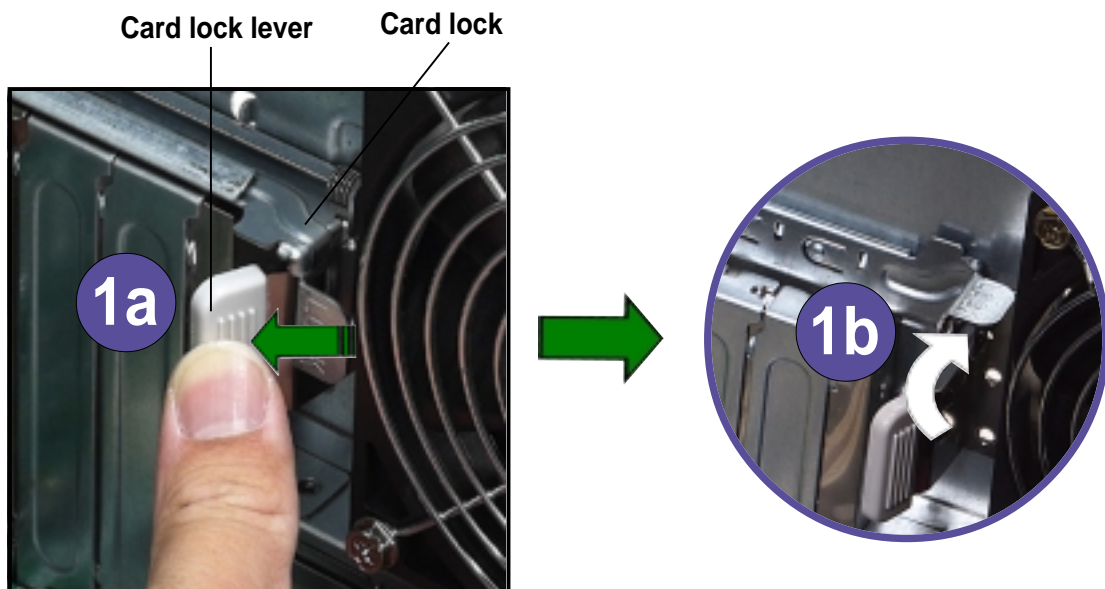

2. Pull out the card from the PCI slot.

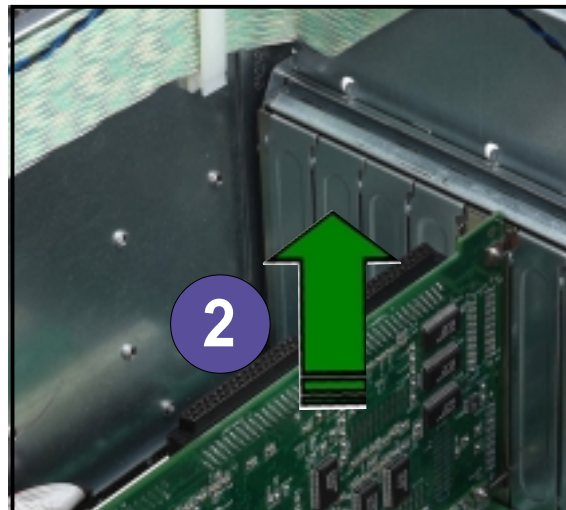

3. Press the end of the card lock marked "LOCK" to return it in place.

2.8 Cable connections

2.8.1 Motherboard connections

The AP1710-S5 chassis includes the power and signal cables that you need to connect to the motherboard, SCSI backplane and to the devices that you will install.



Most of the cables for the chassis kit are already connected upon shipment. When installing system devices and connecting cables, make sure that all cables are routed properly for better system stability and performance. Refer to the picture below when arranging cables.

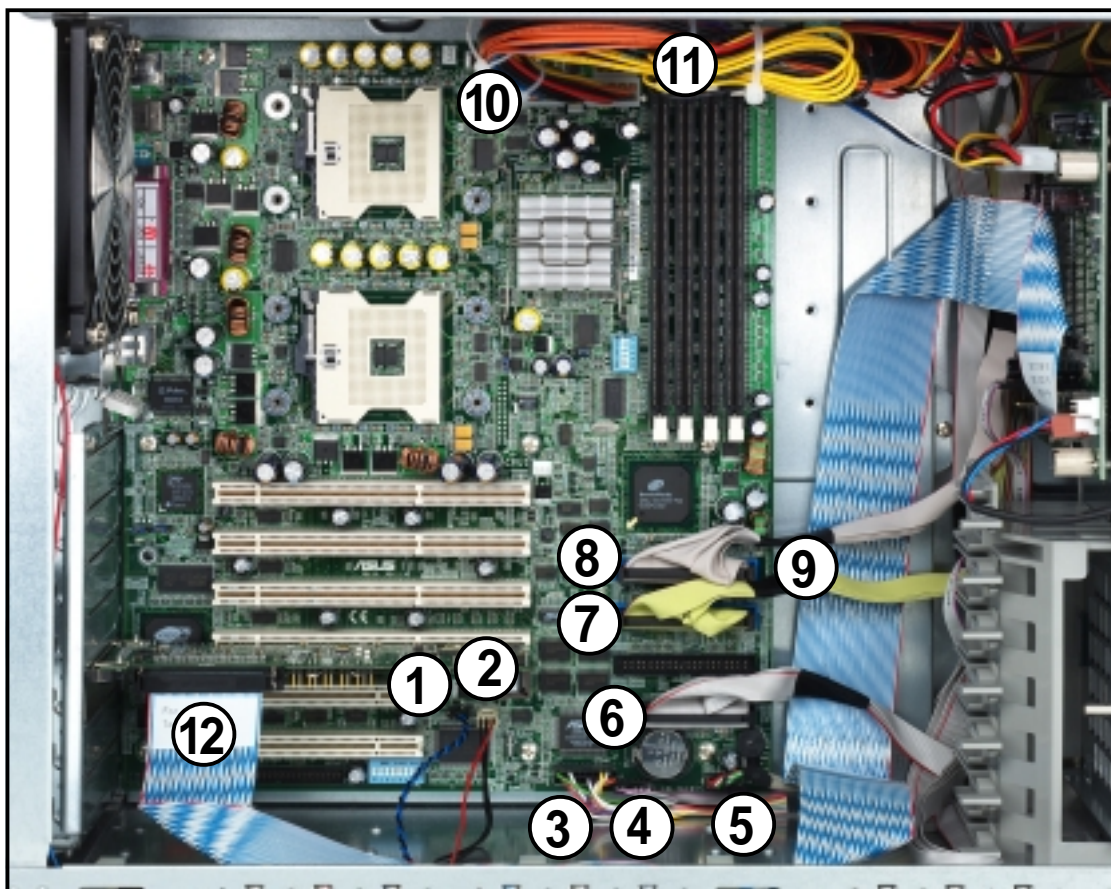

Standard cables connected to the motherboard

- | | |
|-----------------------------|-------------------------|
| 1. Chassis intrusion | 7. Secondary IDE |
| 2. Chassis fan | 8. Primary IDE |
| 3. 20-pin system panel | 9. HDD cable |
| 4. SMBus panel to backplane | 10. 24-pin ATX power |
| 5. Front USB connector | 11. 8-pin 12V AUX power |
| 6. Floppy disk drive | 12. SCSI controller |



Refer to the motherboard user guide for detailed information on the connectors.

2.8.2 SCSI backplane connections

The SCSI backplane has six 68-pin SCSI connectors to support SCA SCSI hard disks. The backplane design incorporates a hot-swap feature to allow easy connection or removal of SCSI hard disks. The LED connectors on the backplane connect to the front panel LEDs to indicate HDD access, HDD failure, thermal failure, or fan failure.

Front side

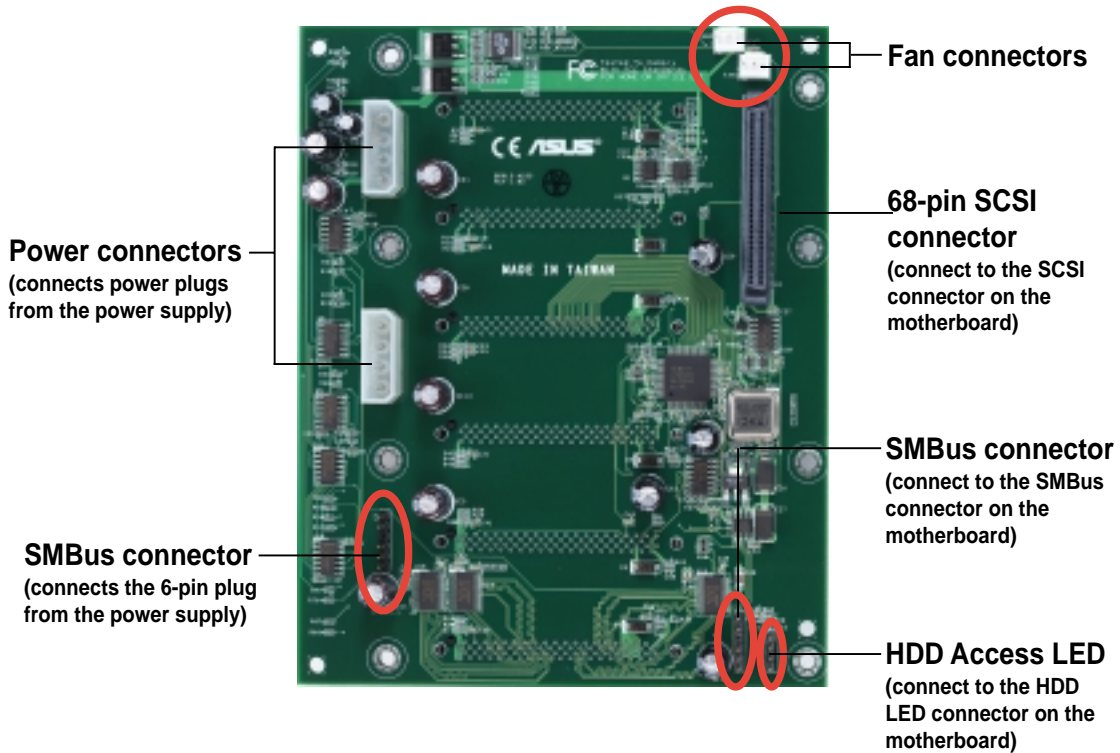

Back side

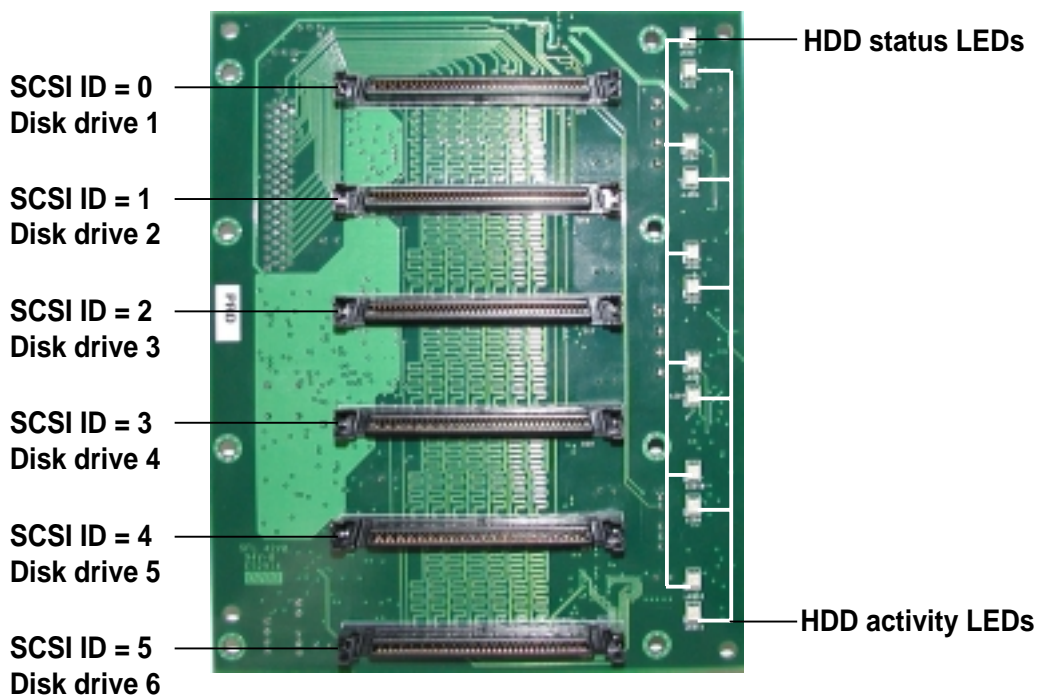

The following picture shows the SCSI backplane installed in the system and the cables connected to it.

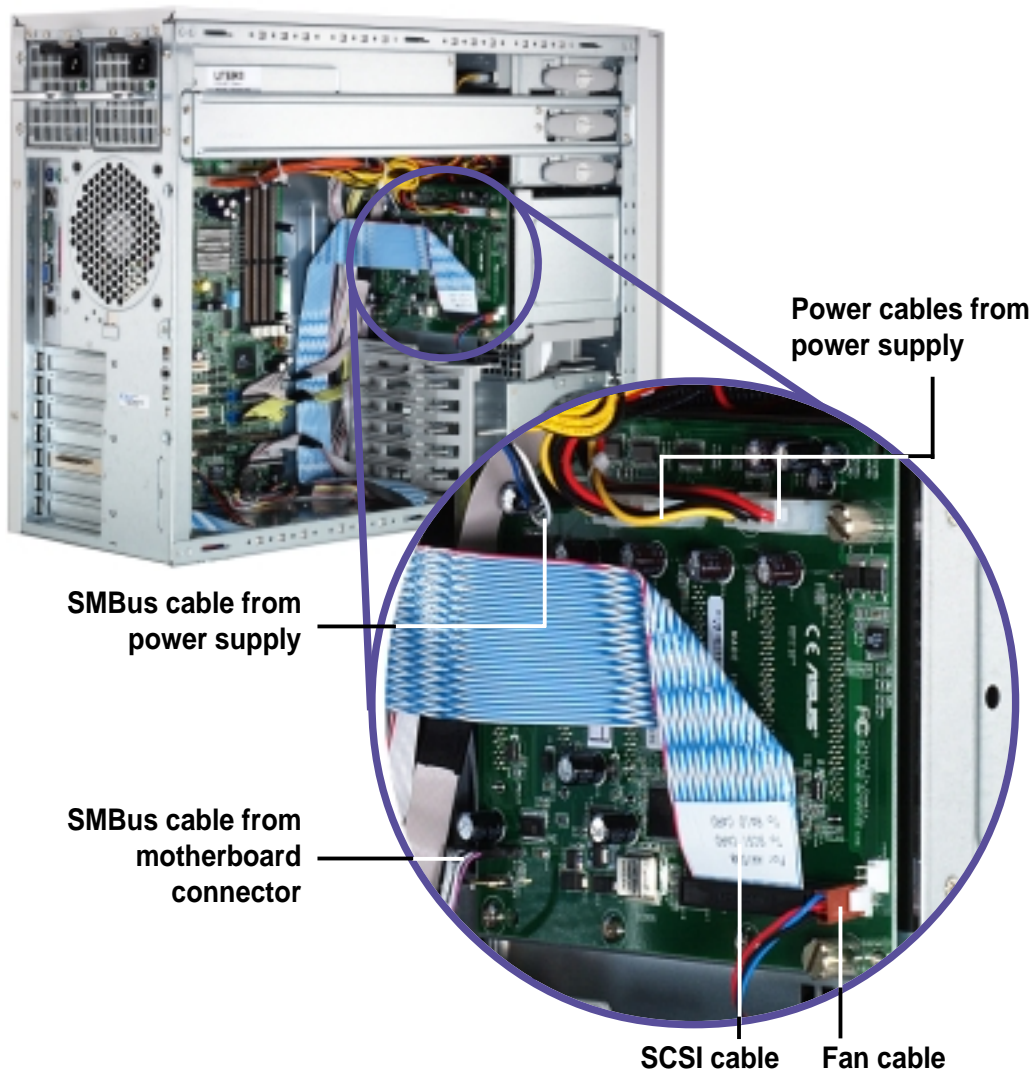

Use power plugs from both redundant power supply modules to ensure power redundancy.

2.9 Removable components

You may need to remove previously installed components when installing or removing system devices. This section describes how to remove the following components:

1. Chassis fan
2. HDD blower
3. Floppy disk drive
4. Power supply modules
5. Power supply case
6. Roller wheels

2.9.1 Chassis fan

To remove the 12-cm chassis fan:

1. Disconnect the 3-pin fan cable from the connector on the motherboard.
2. Use a flat screwdriver to push the pin locks on the four corners of the fan from the inside of the chassis.

Pin lock (tail-end)



3. Pull out the pin locks from the rear panel.
4. Remove the chassis fan.



2.9.2 HDD blower

To remove the HDD blower:

1. Disconnect the 3-pin HDD blower cable from the FAN 1 connector on the SCSI backplane.

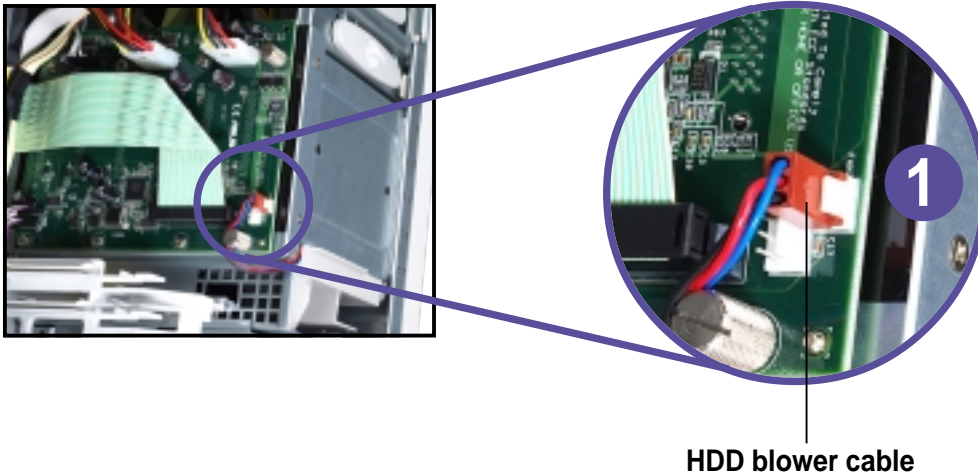

2. Press the tab at the bottom of the blower to release it from the chassis.
3. Pull out the HDD blower.

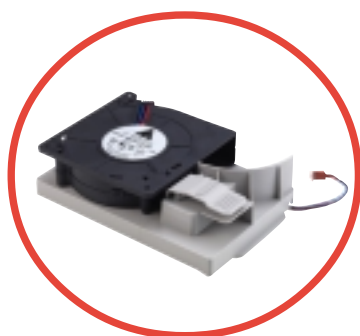
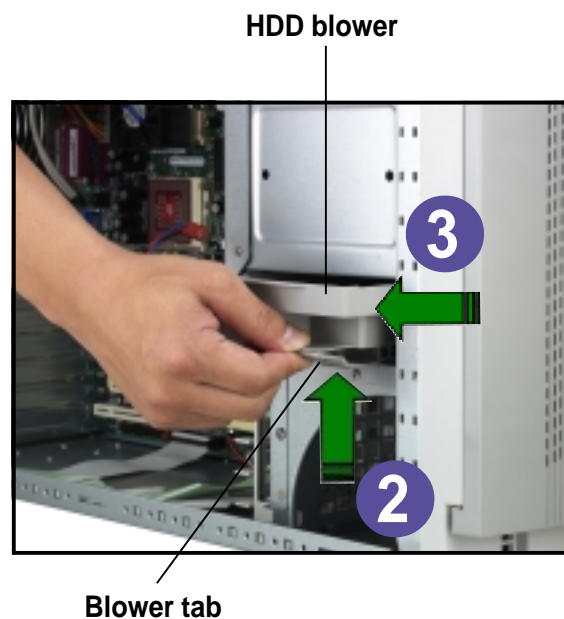

HDD blower

2.9.3 Floppy disk drive

To remove the floppy disk drive:

1. Remove the front panel assembly. Refer to “2.5.1 Removing the front panel assembly” on page 2-11.
2. Use a Phillips head screw driver to remove the right side chassis cover screws.

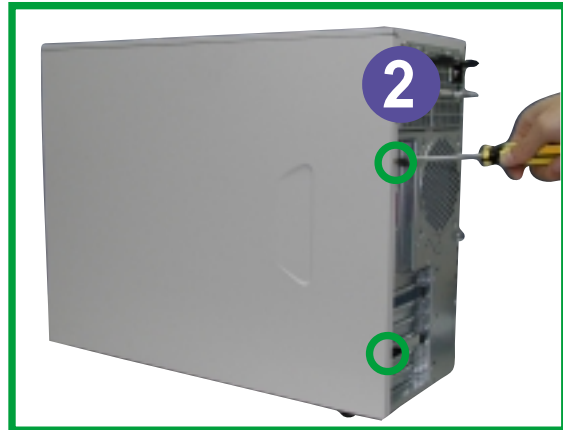

3. Pull out and detach the right side chassis cover. Set aside the cover.

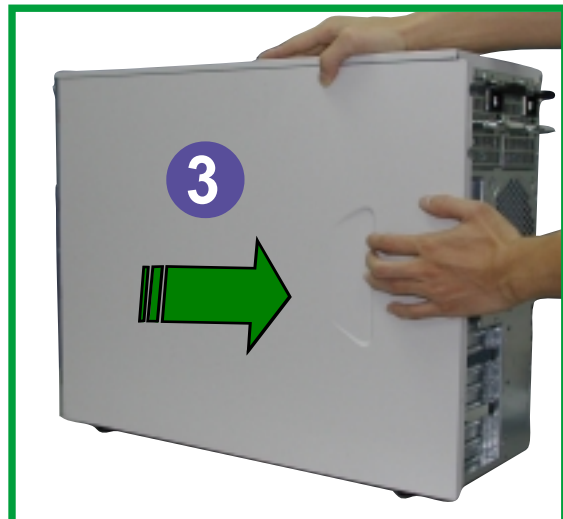

4. Locate the floppy disk drive cable and power connectors.

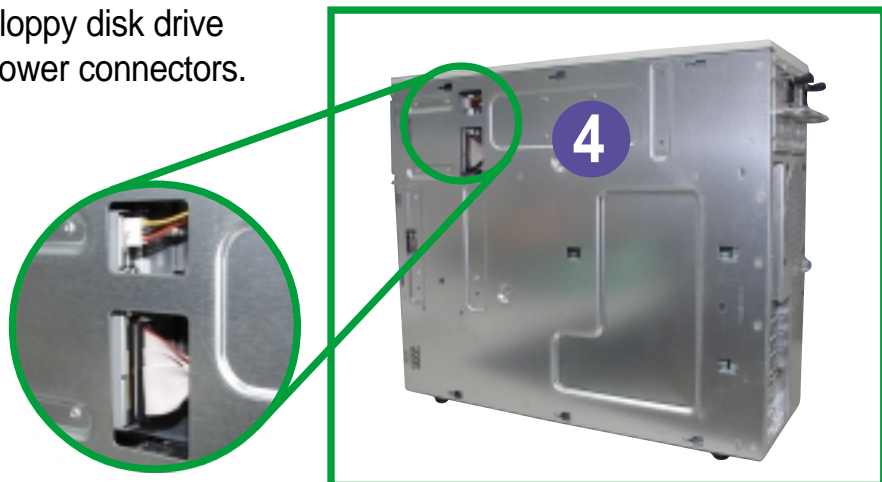

5. Detach the floppy disk drive cable.



6. Detach the floppy disk drive power cable.



7. Squeeze the floppy disk drive tray tabs while pulling the tray out of the chassis.



Floppy disk drive tray



2.9.4 Power supply modules

The AP1710-S5 has two power supply modules. These hot swap power modules can be removed or installed while the server is powered ON. One power module is enough to power the server. When two power supply modules are installed, the task of providing power to the server is shared.

To remove the redundant power supply module:

1. Remove the power module screw.
2. Press down the rubber lever
3. Pull the power module handle from the chassis.

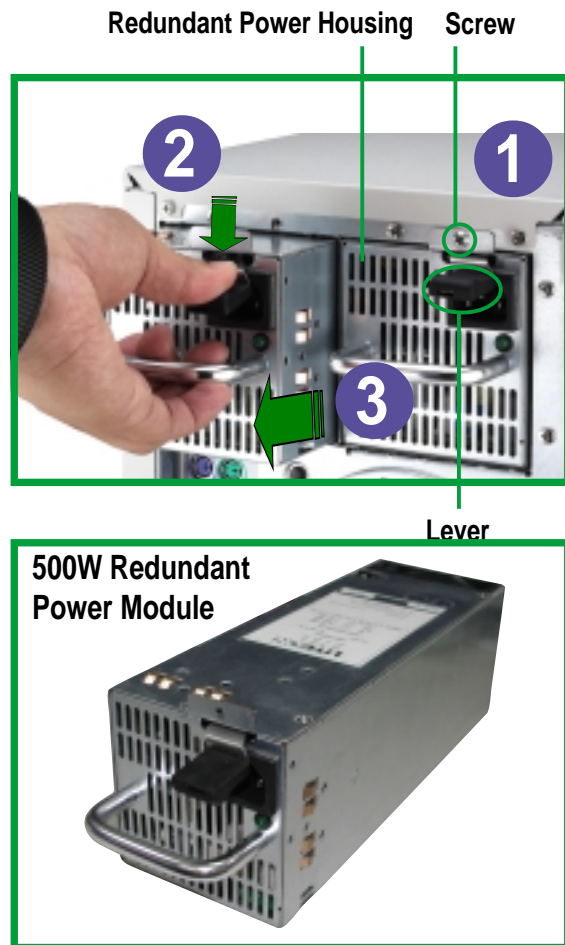

Refer to the Appendix for the redundant power module specification.

2.9.5 Power supply case

The redundant power modules are secured in a power supply case that connects to various power supply connectors on the SCSI backplane and the motherboard.

To remove the power supply case:

1. Remove the two (2) top chassis cover screws to release chassis top panel cover.
2. Remove all power cable connections from SCSI backplane and motherboard.



3. Remove the six (6) chassis bar screws and release chassis bar.



4. Remove the two (2) right-side chassis cover screws to release right-side cover.



5. Remove the four (4) power case side screws.



6. Remove the six (6) power case top screws.

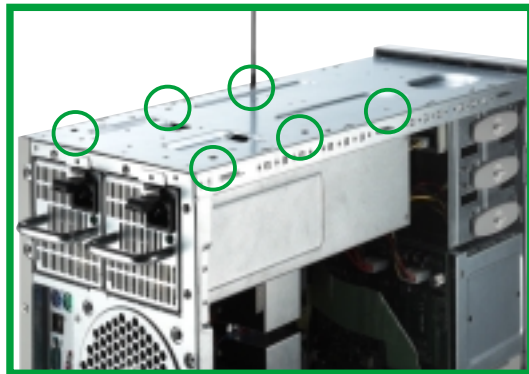

Make sure the power case is well supported or held when releasing the power case screws. The power case may accidentally drop and cause damage to other server system components.

7. Slowly pull-out the power case.

2.9.6 Roller wheels

The chassis comes with four roller wheels for convenient transport. Each wheel has a brake lock to stabilize the chassis in place.

To remove the chassis wheels:

1. Lay the chassis in its side.
2. Use a Phillips screwdriver to remove the screws that secure the wheels to the bottom of the chassis.

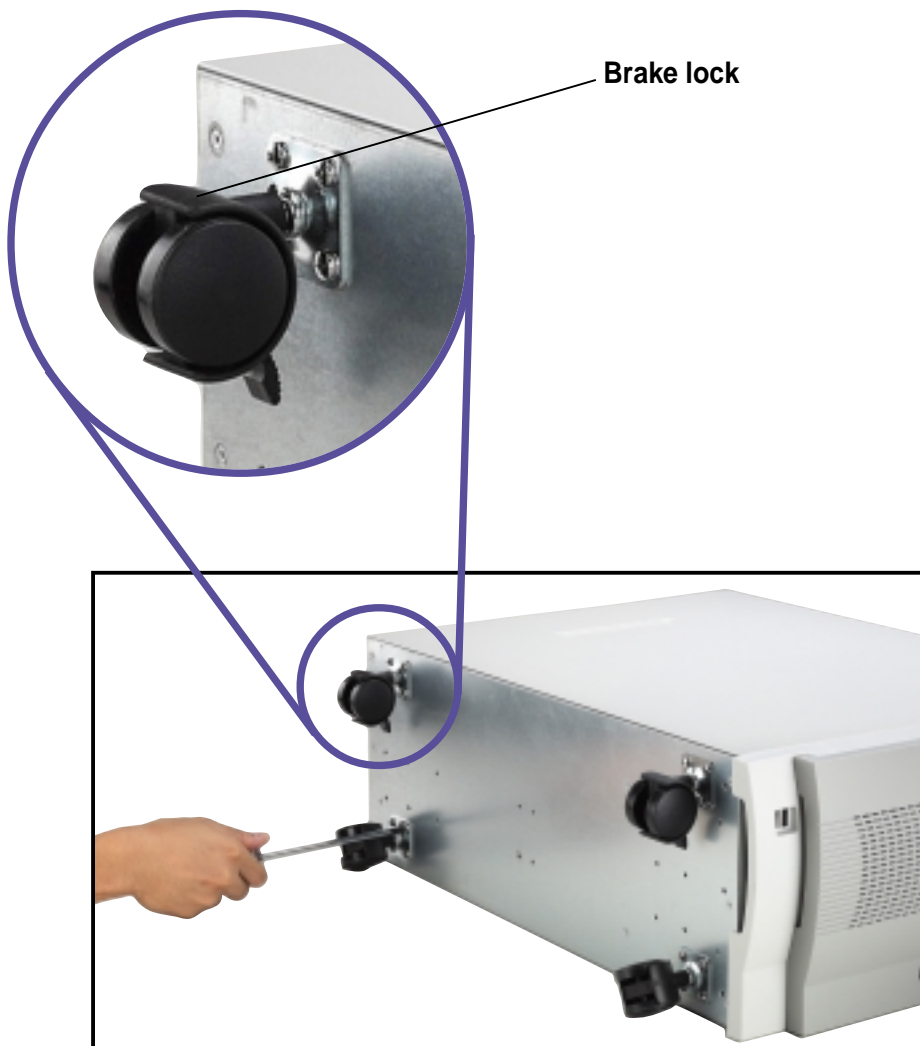

Remove the chassis roller wheels if you wish to mount the system to a rack. Refer to the Rackmount Kit manual for more information.

Appendix

This appendix lists the common problems that you may encounter while using the AP1710-S5 server. It lists the possible causes of the problems and offers solutions. You may refer to this part and try to solve simple problems before calling customer support. The appendix also contains the redundant power module specifications for your reference.

Appendix

A.1 Simple fixes



Some problems that you may encounter are not due to defects on the system or the components. These problems only requires simple troubleshooting actions that you can perform by yourself.

Problem	Action
The power LED on the server or on the monitor do not light up	<ol style="list-style-type: none">1. Check the power cable connection on the system rear panel if properly connected.2. Make sure that the power cables are connected to a grounded power outlet.
The keyboard does not work	Check the keyboard cable if properly connected to the keyboard port.
The mouse does not work	Check the mouse cable if properly connected to the mouse port.
The system does not perform power-on self tests (POST) after it was turned on	<ol style="list-style-type: none">1. Check the memory modules and make sure you installed the DIMMs the system supports.2. Make sure that the DIMMs are properly installed on the sockets.

Problem	Action
<p>The system continuously beeps after it was turned on</p>	<ol style="list-style-type: none"> 1. Check the memory modules and make sure you installed the DIMMs the system supports. 2. Make sure that the DIMMs are properly installed on the sockets. 3. Check if it has a VGA output.
<p>The message “Non-system disk or disk error” appears</p>	<ol style="list-style-type: none"> 1. Check if a bootable HDD is active. 2. Check if the HDDs are properly installed. On SCSI models, make sure that the cables are properly connected to the SCSI connectors on the backplane.
<p>Network connection not available</p>	<ol style="list-style-type: none"> 1. Make sure that the network cable is connected to the RJ-45 port on the rear panel. 2. Make sure that you have installed the LAN drivers from the support CD.

A.2 Redundant power module specifications

Output Voltage Regulation

Output Voltage	Min (V)	Nom (V)	Max (V)	Ripple/Noise
+3.33V	3.20	3.33	3.50	50mVp-p
+5V	4.75	5.00	5.25	50mVp-p
+12V	11.4	12.00	12.60	120mVp-p
-12V	-10.8	-12.00	-13.20	120mVp-p
+5VSB	4.75	5.00	5.25	50mVp-p

Output Current Capacity

Output Voltage	Min (A)	Max (A)	Max. Load (W)
+3.33V	1.0	24.5	81.6
+5V	1.0	17.5	87.5
+12V	2.0	25.0	300
-12V	0.0	0.2	2.4
+5VSB	0.1	2.0	10

Over-Voltage Protection (OVP)

Voltage	Min (V)	Max (V)
+3.33V	3.7	4.5
+5V	5.5	6.5
+12V	12.9	14.2

Free Manuals Download Website

<http://myh66.com>

<http://usermanuals.us>

<http://www.somanuals.com>

<http://www.4manuals.cc>

<http://www.manual-lib.com>

<http://www.404manual.com>

<http://www.luxmanual.com>

<http://aubethermostatmanual.com>

Golf course search by state

<http://golfingnear.com>

Email search by domain

<http://emailbydomain.com>

Auto manuals search

<http://auto.somanuals.com>

TV manuals search

<http://tv.somanuals.com>