

ASUS[®] P2B
Pentium[®] II Motherboard
USER'S MANUAL

USER'S NOTICE

No part of this manual, including the products and software described in it, may be reproduced, transmitted, transcribed, stored in a retrieval system, or translated into any language in any form or by any means, except documentation kept by the purchaser for backup purposes, without the express written permission of ASUSTeK COMPUTER INC. ("ASUS").

ASUS PROVIDES THIS MANUAL "AS IS" WITHOUT WARRANTY OF ANY KIND, EITHER EXPRESS OR IMPLIED, INCLUDING BUT NOT LIMITED TO THE IMPLIED WARRANTIES OR CONDITIONS OF MERCHANTABILITY OR FITNESS FOR A PARTICULAR PURPOSE. IN NO EVENT SHALL ASUS, ITS DIRECTORS, OFFICERS, EMPLOYEES OR AGENTS BE LIABLE FOR ANY INDIRECT, SPECIAL, INCIDENTAL, OR CONSEQUENTIAL DAMAGES (INCLUDING DAMAGES FOR LOSS OF PROFITS, LOSS OF BUSINESS, LOSS OF USE OR DATA, INTERRUPTION OF BUSINESS AND THE LIKE), EVEN IF ASUS HAS BEEN ADVISED OF THE POSSIBILITY OF SUCH DAMAGES ARISING FROM ANY DEFECT OR ERROR IN THIS MANUAL OR PRODUCT.

Product warranty or service will not be extended if: (1) the product is repaired, modified or altered, unless such repair, modification or alteration is authorized in writing by ASUS; or (2) the serial number of the product is defaced or missing.

Products and corporate names appearing in this manual may or may not be registered trademarks or copyrights of their respective companies, and are used only for identification or explanation and to the owners' benefit, without intent to infringe.

- Intel, LANDesk, and Pentium are registered trademarks of Intel Corporation.
- IBM and OS/2 are registered trademarks of International Business Machines.
- Symbios is a registered trademark of Symbios Logic Corporation.
- Windows and MS-DOS are registered trademarks of Microsoft Corporation.
- Sound Blaster AWE32 and SB16 are trademarks of Creative Technology Ltd.
- Adobe and Acrobat are registered trademarks of Adobe Systems Incorporated.

The product name and revision number are both printed on the product itself. Manual revisions are released for each product design represented by the digit before and after the period of the manual revision number. Manual updates are represented by the third digit in the manual revision number.

For previous or updated manuals, BIOS, drivers, or product release information, contact ASUS at <http://www.asus.com.tw> or through any of the means indicated on the following page.

SPECIFICATIONS AND INFORMATION CONTAINED IN THIS MANUAL ARE FURNISHED FOR INFORMATIONAL USE ONLY, AND ARE SUBJECT TO CHANGE AT ANY TIME WITHOUT NOTICE, AND SHOULD NOT BE CONSTRUED AS A COMMITMENT BY ASUS. ASUS ASSUMES NO RESPONSIBILITY OR LIABILITY FOR ANY ERRORS OR INACCURACIES THAT MAY APPEAR IN THIS MANUAL, INCLUDING THE PRODUCTS AND SOFTWARE DESCRIBED IN IT.

Copyright © 1998 ASUSTeK COMPUTER INC. All Rights Reserved.

Product Name:	ASUS P2B
Manual Revision:	1.03 E302
Release Date:	November 1998

ASUS CONTACT INFORMATION

ASUSTeK COMPUTER INC.

Marketing

Address: 150 Li-Te Road, Peitou, Taipei, Taiwan 112
Telephone: +886-2-2894-3447
Fax: +886-2-2894-3449
Email: info@asus.com.tw

Technical Support

Fax: +886-2-2895-9254
BBS: +886-2-2896-4667
Email: tsd@asus.com.tw
WWW: www.asus.com.tw
FTP: ftp.asus.com.tw/pub/ASUS

ASUS COMPUTER INTERNATIONAL

Marketing

Address: 6737 Mowry Avenue, Mowry Business Center, Building 2
Newark, CA 94560, USA
Fax: +1-510-608-4555
Email: info-usa@asus.com.tw

Technical Support

Fax: +1-510-608-4555
BBS: +1-510-739-3774
Email: tsd-usa@asus.com.tw
WWW: www.asus.com
FTP: ftp.asus.com.tw/pub/ASUS

ASUS COMPUTER GmbH

Marketing

Address: Harkort Str. 25, 40880 Ratingen, BRD, Germany
Telephone: 49-2102-445011
Fax: 49-2102-442066
Email: info-ger@asus.com.tw

Technical Support

Hotline: 49-2102-499712
BBS: 49-2102-448690
Email: tsd-ger@asus.com.tw
WWW: www.asuscom.de
FTP: ftp.asuscom.de/pub/ASUSCOM

CONTENTS

I. INTRODUCTION	7
How this Manual is Organized	7
Item Checklist	7
II. FEATURES	8
Features of the ASUS P2B Motherboard	8
The ASUS P2B Motherboard	9
III. INSTALLATION	10
Layout of the ASUS P2B Motherboard	10
Installation Steps	12
1. Jumpers	12
Jumper Settings	13
2. System Memory (DIMM)	17
DIMM Memory Installation Procedures:	18
3. Central Processing Unit (CPU)	19
Universal Retention Mechanism	19
Heatsinks	19
Installing the Processor	20
ASUS Smart Thermal Solutions	22
Recommended Heatsinks for Slot 1 Processors	23
4. Expansion Cards	24
Expansion Card Installation Procedure	24
Assigning IRQs for Expansion Cards	24
Assigning DMA Channels for ISA Cards	25
ISA Cards and Hardware Monitor	25
5. External Connectors	26
Power Connection Procedures	33
IV. BIOS SOFTWARE	34
Flash Memory Writer Utility	34
Main Menu	34
Managing and Updating Your Motherboard's BIOS	36
6. BIOS Setup	37
Load Defaults	38
Standard CMOS Setup	38
Details of Standard CMOS Setup:	38
BIOS Features Setup	41
Details of BIOS Features Setup	41

CONTENTS

Chipset Features Setup	44
Details of Chipset Features Setup	44
Power Management Setup	47
Details of Power Management Setup	47
PNP and PCI Setup	50
Details of PNP and PCI Setup	50
Load BIOS Defaults	52
Load Setup Defaults	52
Supervisor Password and User Password	53
IDE HDD Auto Detection	54
Save & Exit Setup	55
Exit Without Saving	55
V. DESKTOP MANAGEMENT	56
Desktop Management Interface (DMI)	56
Introducing the ASUS DMI Configuration Utility	56
System Requirements	56
Using the ASUS DMI Configuration Utility	57
Using the ASUS DMI Configuration Utility	57
VI. ASUS LAN Card	59
ASUS PCI-L101 Fast Ethernet Card	59
Features	60
Software Driver Support	60
Question and Answer	60

FCC & DOC COMPLIANCE

Federal Communications Commission Statement

This device complies with FCC Rules Part 15. Operation is subject to the following two conditions:

- This device may not cause harmful interference, and
- This device must accept any interference received, including interference that may cause undesired operation.

This equipment has been tested and found to comply with the limits for a Class B digital device, pursuant to Part 15 of the FCC Rules. These limits are designed to provide reasonable protection against harmful interference in a residential installation. This equipment generates, uses and can radiate radio frequency energy and, if not installed and used in accordance with manufacturer's instructions, may cause harmful interference to radio communications. However, there is no guarantee that interference will not occur in a particular installation. If this equipment does cause harmful interference to radio or television reception, which can be determined by turning the equipment off and on, the user is encouraged to try to correct the interference by one or more of the following measures:

- Re-orient or relocate the receiving antenna.
- Increase the separation between the equipment and receiver.
- Connect the equipment to an outlet on a circuit different from that to which the receiver is connected.
- Consult the dealer or an experienced radio/TV technician for help.

WARNING! The use of shielded cables for connection of the monitor to the graphics card is required to assure compliance with FCC regulations. Changes or modifications to this unit not expressly approved by the party responsible for compliance could void the user's authority to operate this equipment.

Canadian Department of Communications Statement

This digital apparatus does not exceed the Class B limits for radio noise emissions from digital apparatus set out in the Radio Interference Regulations of the Canadian Department of Communications.

I. INTRODUCTION

How this Manual is Organized

This manual is divided into the following sections:

- I. Introduction:** Manual information and checklist
- II. Features:** Information and specifications concerning this product
- III. Installation:** Instructions on setting up the motherboard
- IV. BIOS Software:** Instructions on setting up the BIOS software
- V. Support Software:** Information on the included support software

Item Checklist

Please check that your package is complete. If you discover damaged or missing items, please contact your retailer.

- (1) ASUS Motherboard
- (1) Universal Retention Mechanism for SECC/SECC2/SEPP
- (1) IDE ribbon cable for master and slave drives
- (1) Floppy ribbon cable for (1) 5.25inch floppy and (2) 3.5inch floppies
- (1) Bag of spare jumper caps
- (1) Support CD with drivers and utilities
- (1) User's manual

- S-P2FAN or P2T-Cable for Slot 1 processors
- IrDA-compliant infrared module (optional)
- ASUS PCI-L101 Wake-on-LAN 10/100 Ethernet Card (optional)

II. FEATURES

Features of the ASUS P2B Motherboard

The ASUS P2B is carefully designed for the demanding PC user who wants advanced features processed by the fastest CPU.

- **Multi-Speed:** Supports Intel Pentium® II (233 to 450MHz) and Celeron™ (266MHz and faster) processors.
- **Multi-Cache:** Supports processors with or without Pipelined Burst Level 2 cache.
- **Intel AGPset:** Features Intel's 440BX AGPset with I/O subsystems and front-side bus (FSB) platform, which boosts the traditional 66-MHz internal bus speed to 100MHz.
- **Enhanced ACPI and Anti-Boot Virus BIOS:** Features a programmable BIOS, offering enhanced ACPI for Windows 98 compatibility, built-in hardware-based virus protection through Trend ChipAway Virus, and autodetection of most devices for virtually automatic setup.
- **PC100 Memory Support:** Equipped with three DIMM sockets to support Intel PC100-compliant SDRAMs (8, 16, 32, 64, or 128MB) up to 384MB. These new SDRAMs are necessary to meet the enhanced 100MHz bus speed requirement.
- **Thermal Sensor Connector with Optional Sensor:** Accurately detects the CPU temperature of processors with the ASUS Smart Fan or the Intel boxed processor heatsink with fan when connected to an ASUS P2T-Cable.
- **Wake-On-LAN:** Supports Wake-On-LAN activity with special network cards, such as the ASUS PCI-L101 10/100 Fast Ethernet PCI card.
- **AGP Slot:** Supports Accelerated Graphics Port cards for high performance, component level interconnect targeted at 3D graphical display applications.
- **SB-Link™:** Features Creative's SB-Link™, allowing SB16 compatibility, using Intel's PC-PCI DMA and serialized IRQ protocols, to AWE64D or compatible PCI audio cards.
- **SMBus:** Features the System Management Bus interface, which is used to physically transport commands and information between SMBus devices.
- **PCI & ISA Expansion Slots:** Provides four 32-bit PCI and three 16-bit ISA slots.
- **Intelligence:** Supports Keyboard Power Up, Fan Status Monitoring and Alarm, Temperature Monitoring and Alert, Voltage Monitoring and Alert, System Resources Alert, Intel LANDesk Client Manager (LDCM), and ASUS PC Probe software.
- **Super Multi-I/O:** Provides two high-speed UART compatible serial ports and one parallel port with EPP and ECP capabilities. UART2 can also be directed from COM2 to the Infrared Module for wireless connections.
- **Desktop Management Interface (DMI):** Supports DMI through BIOS, which allows hardware to communicate within a standard protocol creating a higher level of compatibility. (Requires DMI-enabled components.) (See section V)
- **Ultra DMA/33 Bus Master IDE:** Comes with an onboard PCI Bus Master IDE controller with two connectors that support four IDE devices in two channels, supports UltraDMA/33, PIO Modes 3 and 4 and Bus Master IDE DMA Mode 2, and supports Enhanced IDE devices, such as Tape Backup, CD-ROM, and LS-120 drives.
- **Universal Retention Mechanism:** Supports a Pentium® II processor packaged in a Single Edge Contact Cartridge (SECC/SECC2) or a Celeron™ processor packaged in a Single Edge Processor Package (SEPP).
- **SCSI BIOS:** Supports optional ASUS SCSI controller cards through onboard SYMBIOS firmware.
- **IrDA:** Supports an optional infrared port module for wireless interface.
- **Concurrent PCI:** Allows multiple PCI transfers from PCI master buses to memory to CPU.

II. FEATURES

The ASUS P2B Motherboard

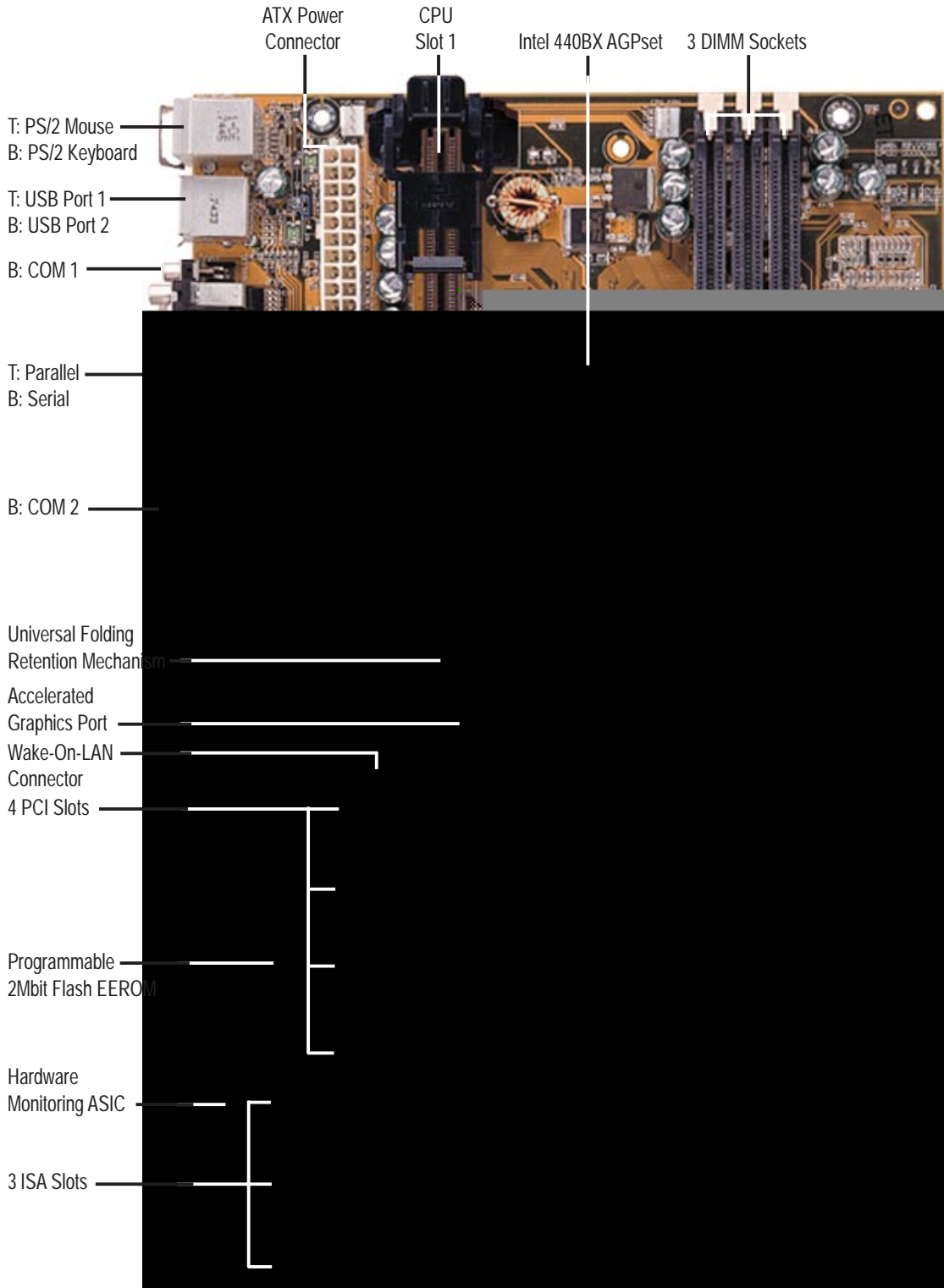

II. FEATURES
Motherboard Parts

III. INSTALLATION

Layout of the ASUS P2B Motherboard

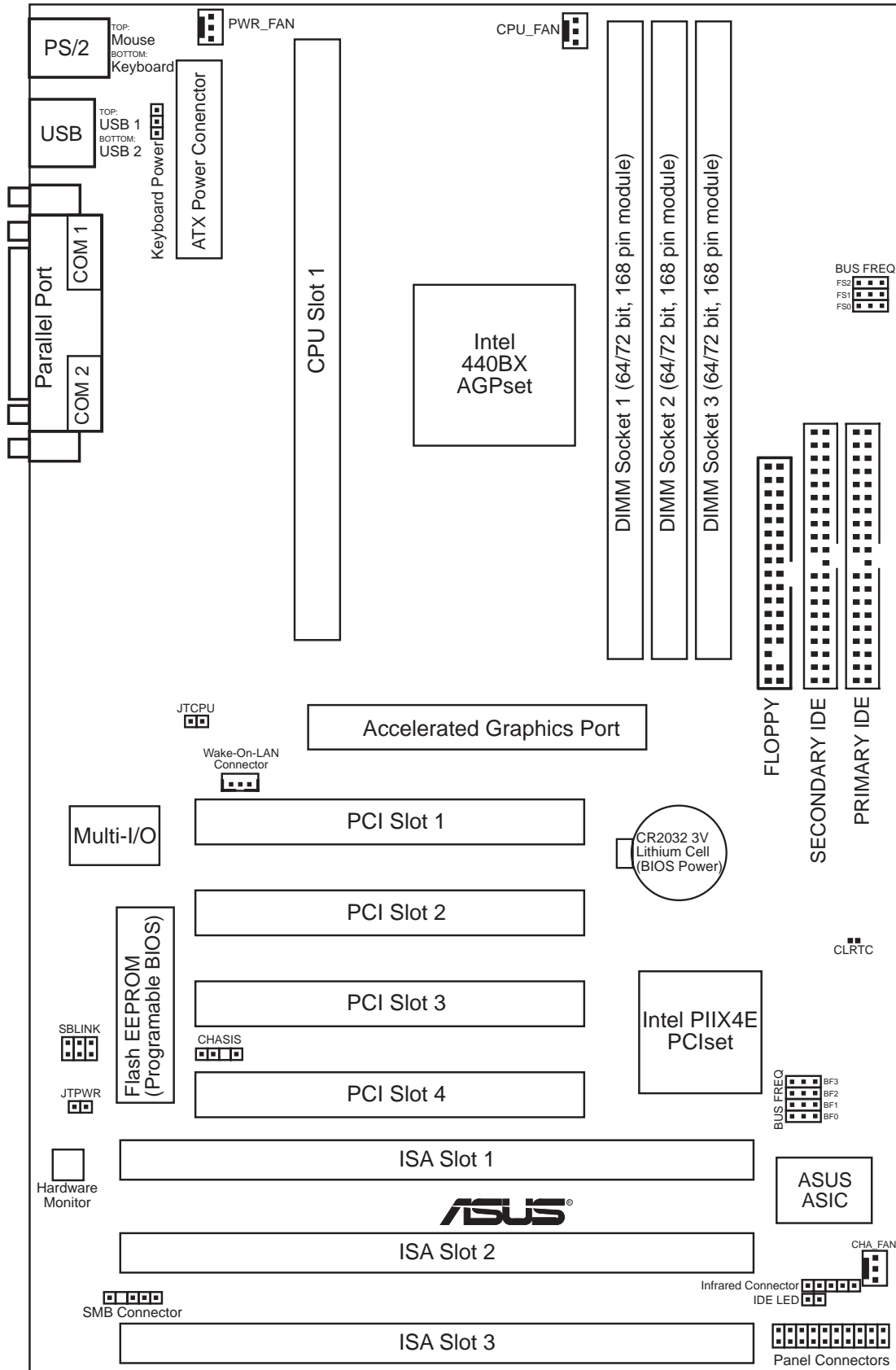

III. INSTALLATION
Board Layout

III. INSTALLATION

Jumpers

- | | |
|-----------------------|--|
| 1) CLRTC | p. 13 Clear Real Time Clock (RTC) RAM (Short/Clear CMOS) |
| 2) KBPWR | p. 13 Keyboard Power |
| 3) FS0, FS1, FS2 | p. 14 CPU External Clock (BUS) Frequency Selection |
| 4) BF0, BF1, BF2, BF3 | p. 14 CPU Core:BUS Frequency Multiple |

Expansion Slots/Sockets

- | | |
|---------------------------|---------------------------------------|
| 1) System Memory | p. 17 System Memory Support |
| 2) DIMM Sockets | p. 18 DIMM Memory Module Support |
| 3) CPU Slot 1 | p. 19 Pentium II/Celeron CPU Support |
| 4) SLOT1, SLOT2, SLOT3 | p. 24 16-bit ISA Bus Expansion Slots* |
| 5) PCI1, PCI2, PCI3, PCI4 | p. 24 32-bit PCI Bus Expansion Slots |
| 6) AGP | p. 25 Accelerated Graphics Port |

Hardware Monitor

- | | |
|-----------------|--------------------------------|
| 1) JTPWR, JTCPU | p. 23 Thermal Sensor Connector |
|-----------------|--------------------------------|

Connectors

- | | |
|--------------------------|---|
| 1) PS2KBMS | p. 26 PS/2 Keyboard Connector (6-pin female) |
| 2) PS2MBMS | p. 26 PS/2 Mouse Connector (6-pin female) |
| 3) PARALLEL | p. 27 Parallel (Printer) Port Connector (25-pin female) |
| 4) COM1, COM2 | p. 27 Serial Port COM1 & COM2 (two 9-pin male) |
| 5) FLOPPY | p. 27 Floppy Drive Connector (34-pin block) |
| 6) USB | p. 28 Universal Serial BUS Ports 1 & 2 (two 4-pin female) |
| 7) Primary/Secondary IDE | p. 28 Primary/Secondary IDE Connector (40-pin blocks) |
| 8) IDELED | p. 28 IDE LED Activity Light (2 pins) |
| 9) CHA_, PWR_, CPU_FAN | p. 29 Chassis, Power Supply, CPU Fan Power Lead (3-pin block) |
| 10) CHASIS | p. 29 Chassis Intrusion Alarm Lead (4-1 pins) |
| 11) IR | p. 30 Infrared Port Module Connector (5 pins) |
| 12) ATXPWR | p. 30 ATX Motherboard Power Connector (20-pin block) |
| 13) WOL_CON | p. 31 Wake on LAN Connector (3 pins) |
| 14) SBLINK | p. 31 SB-Link™ Connector (6-1 pins) |
| 15) SMB | p. 31 SMBus Connector (5-1 pins) |
| 16) MSG.LED (PANEL) | p. 32 System Message LED (2 pins) |
| 17) SMI (PANEL) | p. 32 SMI Switch Lead (2 pins) |
| 18) PWR.SW (PANEL) | p. 32 ATX Power & Soft-Off Switch Lead (2 pins) |
| 19) RESET (PANEL) | p. 32 Reset Switch Lead (2 pins) |
| 20) PWR.LED (PANEL) | p. 32 System Power LED Lead (3 pins) |
| 21) KEYLOCK (PANEL) | p. 32 Keyboard Lock Switch Lead (2 pins) |
| 22) SPEAKER (PANEL) | p. 32 Speaker Output Connector (4 pins) |

*The onboard hardware monitor uses the address 290H-297H so legacy ISA cards must not use this address otherwise conflicts will occur.

III. INSTALLATION

Installation Steps

Before using your computer, you must complete the following steps:

1. **Set Jumpers**
2. **Install Memory Modules**
3. **Install the Central Processing Unit (CPU)**
4. **Install Expansion Cards**
5. **Connect Ribbon Cables, Cabinet Wires, and Power Supply**
6. **Setup the BIOS Software**

1. Jumpers

WARNING! Computer motherboards and expansion cards contain very delicate Integrated Circuit (IC) chips. To protect them against damage from static electricity, you should follow some precautions whenever you work on your computer.

1. Unplug your computer when working on the inside.
2. Use a grounded wrist strap before handling computer components. If you do not have one, touch both of your hands to a safely grounded object or to a metal object, such as the power supply case.
3. Hold components by the edges and try not to touch the IC chips, leads or connectors, or other components.
4. Place components on a grounded antistatic pad or on the bag that came with the component whenever the components are separated from the system.

III. INSTALLATION

Jumper Settings

1. Clear Real Time Clock (RTC) RAM (CLRRTC)

The CMOS RAM is powered by the onboard button cell battery. To clear the RTC data: (1) Turn off your computer and unplug your AC power, (2) Short the two points labeled CLRRTC, (3) Turn on your computer, (4) Hold down <Delete> during bootup and enter BIOS setup to re-enter user preferences.

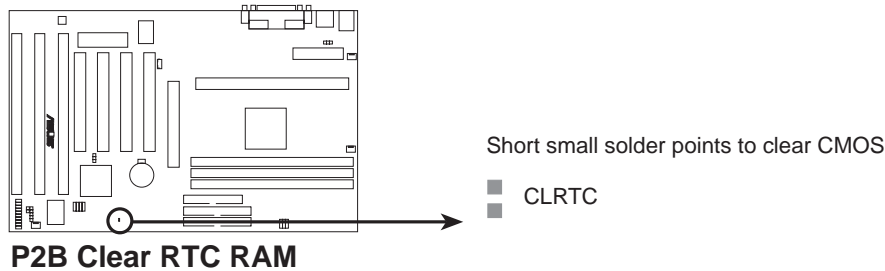

2. Keyboard Power Up (KBPWR)

This allows you to disable or enable the keyboard power up function. Set to *Enable* if you want to use your keyboard (by pressing <Spacebar>) to power up your computer. This feature requires an ATX power supply that can supply at least 300mA on the +5VSB lead and the new ACPI BIOS support. The default is set to *Disable* because not all computers have the appropriate ATX power supply. Your computer will not function if you set this to *Enable* and if you do not have the right ATX power supply.

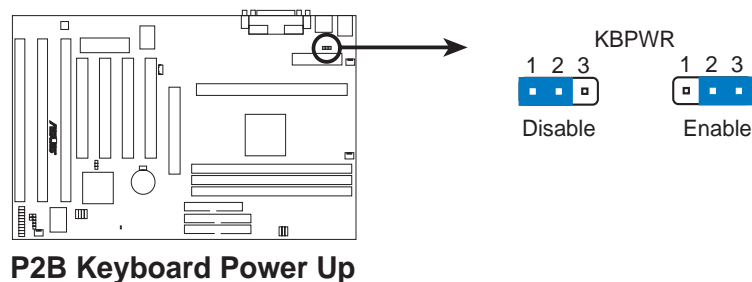

III. INSTALLATION

3. CPU Bus Frequency (FS0, FS1, FS2)

This option tells the clock generator what frequency to send to the CPU, DRAM, and 440BX AGPset. This allows the selection of the CPU's *External* frequency (or *BUS Clock*). The BUS Clock multiplied by the BUS Ratio equals the CPU's *Internal* frequency (the advertised CPU speed).

4. CPU Core:BUS Frequency Multiple (BF0, BF1, BF2, BF3)

This option sets the frequency ratio between the *Internal* frequency of the CPU and the CPU's *External* frequency. These must be set in conjunction with the *CPU Bus Frequency*.

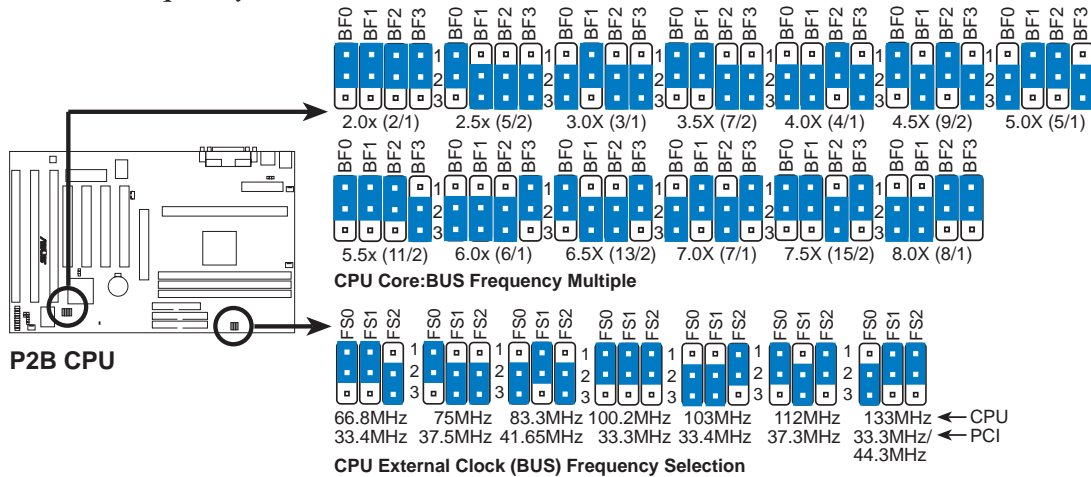

WARNING! Frequencies above 100MHz exceed the specifications for the on-board Intel Chipset and are not guaranteed to be stable.

Set the jumpers by the Internal speed of your processor as follows:

Intel CPU Model	Freq.	Ratio	(BUS Freq.)				(Freq. Ratio)			
			BUS F.	FS0	FS1	FS2	BF0	BF1	BF2	BF3
Pentium II	450MHz	4.5x	100MHz	[1-2]	[1-2]	[1-2]	[1-2]	[2-3]	[1-2]	[2-3]
Pentium II	400MHz	4.0x	100MHz	[1-2]	[1-2]	[1-2]	[2-3]	[2-3]	[1-2]	[2-3]
Pentium II	350MHz	3.5x	100MHz	[1-2]	[1-2]	[1-2]	[1-2]	[1-2]	[2-3]	[2-3]
Pentium II/Celeron	333MHz	5.0x	66MHz	[1-2]	[1-2]	[2-3]	[2-3]	[1-2]	[1-2]	[2-3]
Pentium II/Celeron	300MHz	4.5x	66MHz	[1-2]	[1-2]	[2-3]	[1-2]	[2-3]	[1-2]	[2-3]
Pentium II/Celeron	266MHz	4.0x	66MHz	[1-2]	[1-2]	[2-3]	[2-3]	[2-3]	[1-2]	[2-3]

NOTES: Overclocking your processor is not recommended. It may result in a slower speed. Voltage Regulator Output Selection (VID) is not needed for the Pentium II processor because it sends a VID signal directly to the onboard power controller.

(This page was intentionally left blank.)

(This page was intentionally left blank.)

III. INSTALLATION

2. System Memory (DIMM)

This motherboard uses only Dual Inline Memory Modules (DIMMs). Three sockets are available for **3.3Volt** (power level) unbuffered Synchronous Dynamic Random Access Memory (SDRAM) of either 8, 16, 32, 64, 128 or 256MB to form a memory size between 8MB to 768MB. One side (with memory chips) of the DIMM takes up one row on the motherboard.

To utilize the chipset's Error Checking and Correction (ECC) feature, you must use a DIMM module with 9 chips per side (standard 8 chips/side + 1 ECC chip) and make the proper settings through "Chipset Features Setup" in **IV. BIOS SOFTWARE**.

Memory speed setup is recommended through *SDRAM Configuration* under "Chipset Features Setup".

IMPORTANT (see **General DIMM Notes** below)

- **SDRAMs used must be compatible with the current Intel PC100 SDRAM specification.**

Install memory in any combination as follows:

DIMM Location	168-pin DIMM		Total Memory
Socket 1 (Rows 0&1)	SDRAM 8, 16, 32, 64, 128, 256MB	x1	
Socket 2 (Rows 2&3)	SDRAM 8, 16, 32, 64, 128, 256MB	x1	
Socket 3 (Rows 4&5)	SDRAM 8, 16, 32, 64, 128, 256MB	x1	
	Total System Memory (Max 768MB)	=	

General DIMM Notes

- **Use only PC100-compliant DIMMs.** This motherboard operates at 100MHz, thus most systems will not even boot if non-compliant modules are used because of the strict timing issues involved under this speed.
- Two possible memory chips are supported: SDRAM with and without ECC.
- SDRAM chips are generally thinner with higher pin density than EDO (Extended Data Output) chips.
- BIOS shows SDRAM memory on bootup screen.
- 8 chips/side modules do not support ECC, only 9 chips/side modules support ECC.
- Single-sided modules come in 16, 32, 64, 128MB; double-sided come in 32, 64, 128, 256MB.

III. INSTALLATION

DIMM Memory Installation Procedures:

Insert the module(s) as shown. Because the number of pins are different on either side of the breaks, the module will only fit in the orientation as shown. DRAM SIMM modules have the same pin contacts on both sides. SDRAM DIMMs have different pin contacts on each side and therefore have a higher pin density.

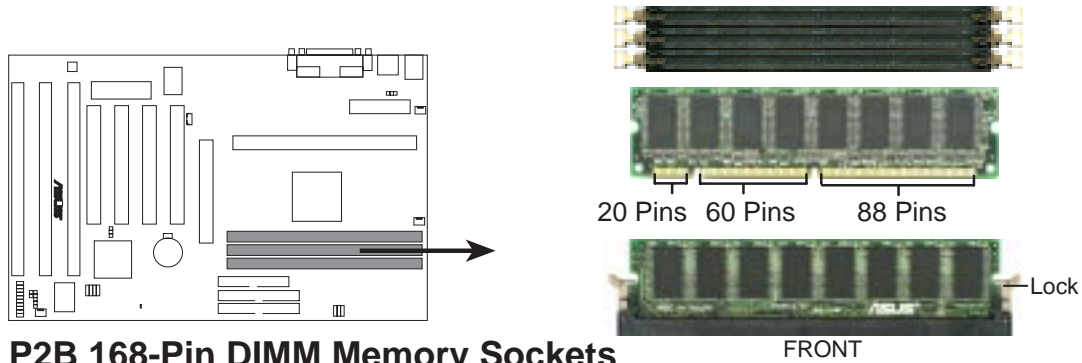

The DIMMs must be 3.3Volt unbuffered SDRAMs. To determine the DIMM type, check the notches on the DIMMs (see figure below).

168-Pin DIMM Notch Key Definitions (3.3V)

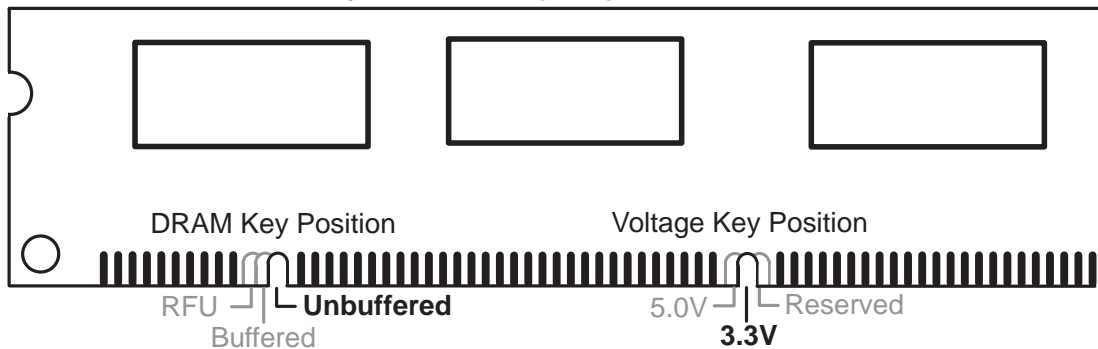

The notches on the DIMM will shift between left, center, or right to identify the type and also to prevent the wrong type from being inserted into the DIMM slot on the motherboard. You must tell your retailer the correct DIMM type before purchasing. This motherboard supports four clock signals.

III. INSTALLATION

3. Central Processing Unit (CPU)

Your motherboard provides a Slot 1 connector for a Pentium® II processor packaged in a Single Edge Contact Cartridge (SECC/SECC2) or a Celeron™ processor packaged in a Single Edge Processor Package (SEPP).

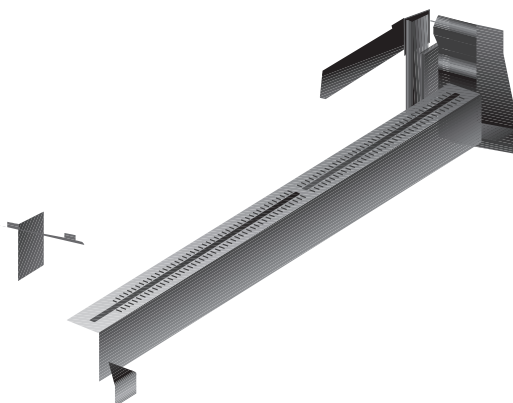

Heatsinks

The recommended heatsinks (see section on recommended heatsinks for Pentium II processors for more information) for the boxed Pentium II and Celeron processors are those with three-pin fans that can be connected to the fan connectors on the motherboard.

WARNING! Be sure that there is sufficient air circulation across the processor's heatsink by regularly checking that your CPU fan is working. Without sufficient circulation, the processor could overheat and damage both the processor and the motherboard. You may install an auxiliary fan, if necessary.

III. INSTALLATION

Installing the Processor

1. Unlock the URM's Folding Support Arms:

The folding support arms of the URM are locked when shipped.

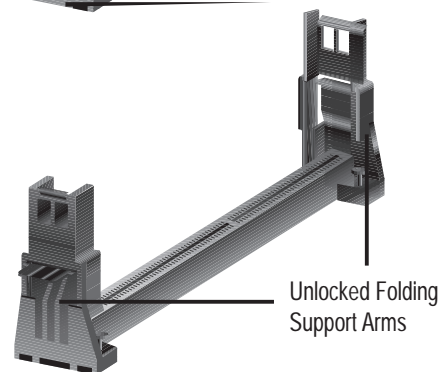
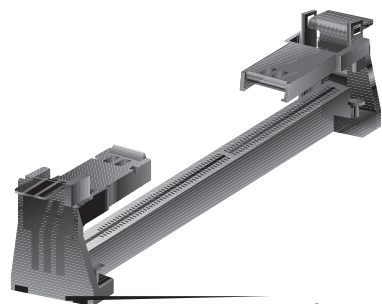

The URM is now ready for the installation of your processor.

2. Attach the Heatsink

NOTE: Follow carefully the heatsink attachment instructions included with your heatsink or processor. The following steps are provided only as a general guide and may not reflect those for your heatsink.

SECC with Pentium® II

Place the SECC face down on a flat surface and lay the heat sink flush on the back (metal side) of the SECC. Check the orientation of the heatsink against the illustration below. The thicker fin must be orientated toward the

SECC2 with Pentium® II/SEPP with Celeron™

Insert the heatsink clip through the holes at the SECC2/SEPP's back, making sure that the bottom of the clip plate sits against the processors' back. Remove the tab from the thermal grease, which is located on the bottom of the heatsink)

III. INSTALLATION

WARNING! Make sure the heatsink is mounted tightly against the SECC, SECC2 or SEPP; otherwise, the CPU will overheat. You may install an auxiliary fan to provide adequate circulation across the processor's passive heatsink.

3. Insert the SECC/SECC2/SEPP

SECC with Pentium® II only: Push the SECC's two locks inward until you hear a click (the picture in step 2 shows the locks in the outward position and inward in the picture below).

With the heatsink facing the motherboard's chipset, push the SECC, SECC2, or SEPP gently but firmly into the Slot 1 connector until it is fully inserted.

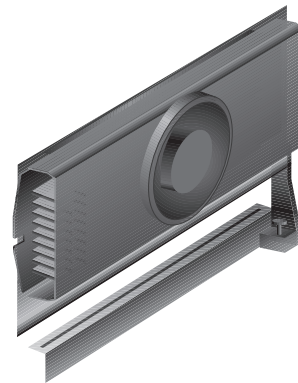

4. Secure the SECC/SECC2/SEPP

Secure the SECC/SECC2/SEPP in place by pushing the SECC/SECC2/SEPP until it is firmly seated on the Slot 1 connector.

SECC with Pentium® II only: The SECC locks should be outward when secured so that the lock shows through the retention mechanism's lock holes.

- 5. Attach the Thermal Sensor Cable (optional):** If you purchased an ASUS Smart Fan (ASUS S-P2FAN) with an integrated thermal sensor cable (ASUS P2T-Cable) or purchased separately the P2T-Cable, you can connect the thermal sensor cable to your motherboard's thermal sensor connector. (See next page for information on ASUS Smart Thermal Solutions.)

III. INSTALLATION

ASUS Smart Thermal Solutions

ASUS provides two smart solutions to Slot 1 CPU thermal problems: the **ASUS Smart Fan** or **ASUS S-P2FAN** and the **ASUS P2T-Cable**.

ASUS S-P2FAN

The optional ASUS Smart Fan or ASUS S-P2FAN is a CPU fan for a Pentium® II processor packaged in an SECC. Unlike other CPU thermal solutions, the ASUS S-P2FAN has

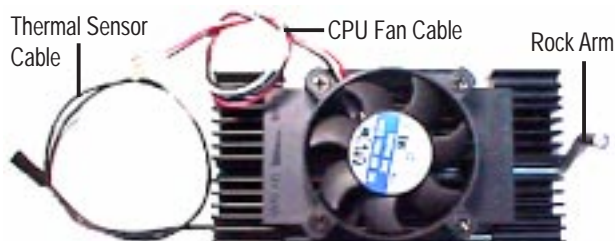

an integrated thermal sensor located near the center of the CPU heat source. The sensor is optimized by ASUS to give the most accurate reading of the CPU temperature, thus provides the best protection to your computer system.

To Use the ASUS S-P2FAN

See **2. Attach the Heatsink** on the preceding page for the relevant procedures. Note that the S-P2FAN comes with a rock arm design for easy FAN/CPU installation.

ASUS P2T-Cable

The optional ASUS P2T-Cable can be used for a Pentium® II processor packaged in an SECC/SECC2 or a Celeron™ processor packaged in an SEPP .

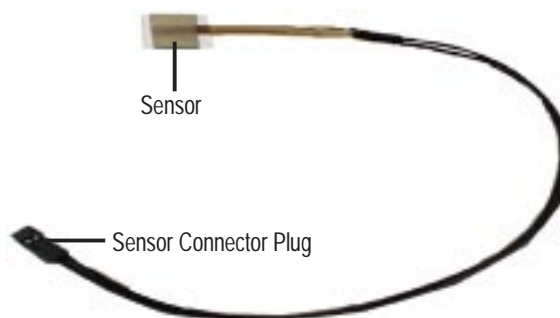

NOTE: The ASUS P2T-Cable can only be used in a Slot 1 motherboard with a 2-pin thermal sensor connector.

To Use the ASUS P2T-Cable

NOTE: The following procedures assume that you have properly attached a heatsink onto an SECC/SECC2/SEPP.

1. Simply peel off the tab from the sensor and then stick the sensor near the middle edge of the Intel boxed processor heatsink with fan (middle) or to either the upper or lower edge of the Celeron™ heatsink (right), as indicated.

III. INSTALLATION



WARNING! Do not insert the sensor between the processor and heatsink, otherwise, it will cause damage to the P2T-Cable.

IMPORTANT! ASUS guarantees accurate readings only for the ASUS Smart Fan and the Intel boxed processor heatsink with fan because both have similar heat distribution and heatsink material.

2. Connect the P2T-Cable to the CPU thermal sensor connector (JTCPU).

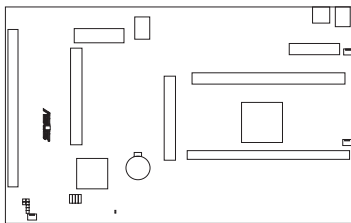

Recommended Heatsinks for Slot 1 Processors

The recommended heatsinks for the Slot 1 processors are those with three-pin fans, such as the ASUS Smart Fan, that can be connected to the motherboard’s CPU fan connector. These heatsinks, such as the Elan Vital Heatsink with Fan, dissipate heat more efficiently and with an optional hardware monitor, they can monitor the fan’s RPM and use the alert function with the Intel LANDesk Client Manager (LDCM) and the ASUS PC Probe software.

Elan Vital Heatsink with Fan

To install, simply follow the procedures for **Installing the Processor**. The Elan Vital heatsink, however, comes with a lever to clamp the heatsink into the SEC cartridge. Mount the heatsink in the orientation as shown then flip the lever from “Unlock” to “Lock.”



III. INSTALLATION

4. Expansion Cards

WARNING! Unplug your power supply when adding or removing expansion cards or other system components. Failure to do so may cause severe damage to both your motherboard and expansion cards.

Expansion Card Installation Procedure

1. Read the documentation for your expansion card and make any necessary hardware or software settings for your expansion card, such as jumpers.
2. Remove your computer system's cover and the bracket plate on the slot you intend to use. Keep the bracket for possible future use.
3. Carefully align the card's connectors and press firmly.
4. Secure the card on the slot with the screw you removed above.
5. Replace the computer system's cover.
6. Set up the BIOS if necessary
(such as *IRQ xx Used By ISA: Yes* in PNP AND PCI SETUP)
7. Install the necessary software drivers for your expansion card.

Assigning IRQs for Expansion Cards

Some expansion cards need to use an IRQ to operate. Generally, an IRQ must be exclusively assigned to one use. In a standard design, there are 16 IRQs available but most of them are already in use, leaving 6 IRQs free for expansion cards. If your motherboard has audio onboard, an extra 3 IRQs will be used, leaving 3 IRQs free.

Both ISA and PCI expansion cards may require to use IRQs. System IRQs are available to cards installed in the ISA expansion bus first, then any remaining IRQs are available to PCI cards. Currently, there are two types of ISA cards. The original ISA expansion card design, now referred to as legacy ISA cards, requires that you configure the card's jumpers manually and then install it in any available slot on the ISA bus. You may use the Microsoft Diagnostics (MSD.EXE) utility located in the Windows directory to see a map of your used and free IRQs. If you use Windows 95, the **Resources** tab under **Device Manager** displays the resource settings being used by a particular device (to gain access, double-click the **System** icon under the **Control Panel** program). Ensure that no two devices share the same IRQs or your computer will experience problems when those two devices are in use at the same time.

III. INSTALLATION

To simplify this process, this motherboard complies with the Plug and Play (PnP) specification, which was developed to allow automatic system configuration whenever a PnP-compliant card is added to the system. For PnP cards, IRQs are assigned automatically from those available.

If the system has both legacy and PnP ISA cards installed, IRQs are assigned to PnP cards from those not used by legacy cards. The PCI and PNP configuration section of the BIOS setup utility can be used to assign which IRQs are being used by legacy cards. For older legacy cards that do not work with the BIOS, you may contact your vendor for an ISA Configuration Utility.

An IRQ number is automatically assigned to PCI expansion cards after those used by legacy and PnP ISA cards. In the PCI bus design, the BIOS automatically assigns an IRQ to a PCI slot that contains a card requiring an IRQ. To install a PCI card, you need to set the INT (interrupt assignment). Since all the PCI slots on this motherboard use an INTA #, set the jumpers on your PCI cards to INT A.

Assigning DMA Channels for ISA Cards

Some ISA cards, both legacy and PnP, may also need to use a DMA (Direct Memory Access) channel. DMA assignments for this motherboard are handled the same way as the IRQ assignment process described earlier. You can select a DMA channel in the PCI and PnP configuration section of the BIOS Setup utility.

IMPORTANT: To avoid conflicts, reserve the necessary IRQs and DMAs for legacy ISA cards (under PNP AND PCI SETUP of the BIOS SOFTWARE, choose *Yes* in *IRQ xx Used By ISA* and *DMA x Used By ISA* for those IRQs and DMAs you want to reserve.

ISA Cards and Hardware Monitor

The onboard hardware monitor uses the address 290H-297H so legacy ISA cards must not use this address or else conflicts will occur.

Accelerated Graphics Port

This motherboard provides an accelerated graphics port (AGP) slot to support a new generation of graphics cards with ultra-high memory bandwidth, such as an ASUS 3D Hardware Accelerator.

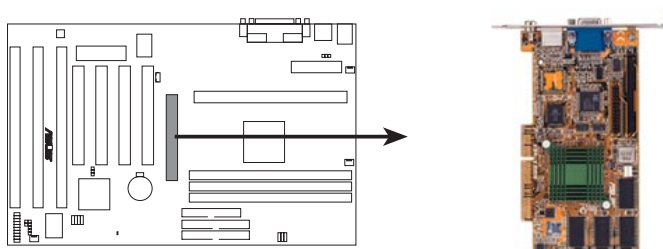

P2B Accelerated Graphics Port (AGP)

5. External Connectors

IMPORTANT: Ribbon cables should always be connected with the red stripe on the Pin 1 side of the connector. The four corners of the connectors are labeled on the motherboard. Pin 1 is the side closest to the power connector on hard drives and floppy drives. IDE ribbon cable must be less than 46cm (18in), with the second drive connector no more than 15cm (6in) from the first connector.

1. PS/2 Keyboard Connector (6-pin Female)

This connection is for a standard keyboard using an PS/2 plug (mini DIN). **This connector will not allow standard AT size (large DIN) keyboard plugs. You may use a DIN to mini DIN adapter on standard AT keyboards.**

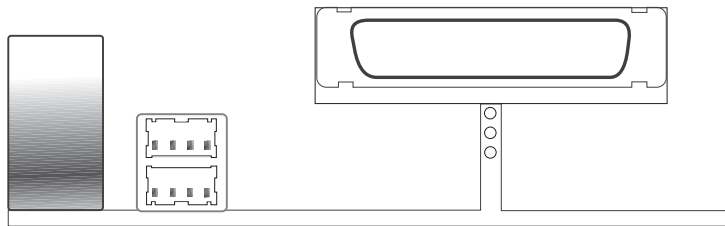

PS/2 Keyboard (6-pin Female)

III. INSTALLATION

3. Parallel Port Connector (25-pin Female)

You can enable the parallel port and choose the IRQ through “Onboard Parallel Port” in Chipset Features Setup of the BIOS SOFTWARE. **NOTE:** Serial printers must be connected to the serial port.

Parallel (Printer) Port (25-pin Female)

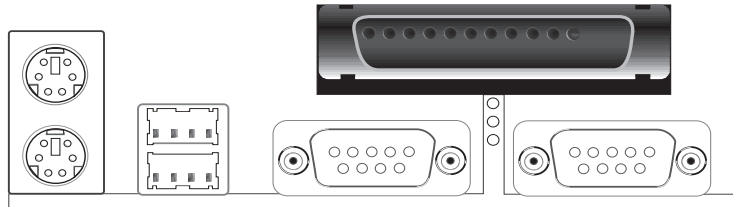

III. INSTALLATION

6. Universal Serial BUS Ports 1 & 2 (Two 4-pin Female)

Two USB ports are available for connecting USB devices.

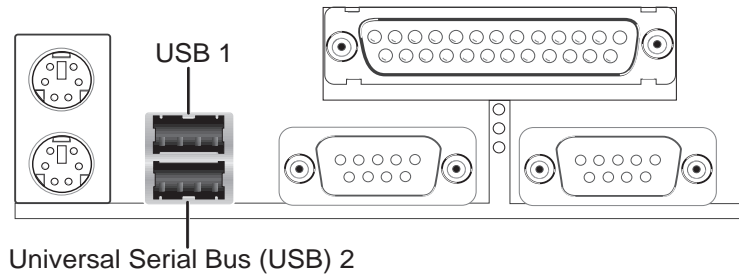

7. Primary / Secondary IDE Connectors (Two 40-1pin IDE)

These connectors support the provided IDE hard disk ribbon cable. After connecting the single end to the board, connect the two plugs at the other end to your hard disk(s). If you install two hard disks, you must configure the second drive to Slave mode by setting its jumper accordingly. Refer to the documentation of your hard disk for the jumper settings. BIOS now supports SCSI device or IDE CD-ROM bootup (see “HDD Sequence SCSI/IDE First” & “Boot Sequence” in the **BIOS Features Setup** of the BIOS SOFTWARE) **(Pin 20 is removed to prevent inserting in the wrong orientation when using ribbon cables with pin 20 plugged).**

TIP: You may configure two hard disks to be both Masters using one ribbon cable on the primary IDE connector and another ribbon cable on the secondary IDE connector. You may install one operating system on an IDE drive and another on a SCSI drive and select the boot disk through BIOS Features Setup.

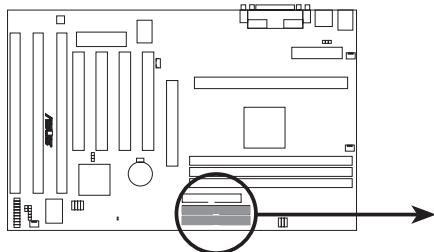

NOTE: Orient the red stripe to PIN 1

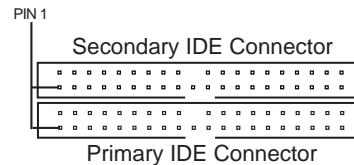

P2B IDE Connectors

8. IDE Device Activity LED (2-pin IDELED)

This connector supplies power to the cabinet's IDE device activity LED. Read and write activity by devices connected to the Primary or Secondary IDE connectors will cause the LED to light up.

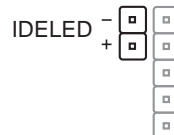
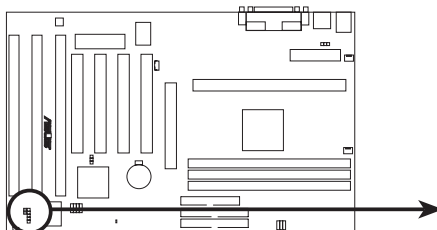

TIP: If the case-mounted LED does not light, try reversing the 2-pin plug.

P2B IDE Activity LED

III. INSTALLATION

9. Chassis / CPU / Power Supply Fan Connectors (3-pin FAN)

These connectors support cooling fans of 500mA (6W) or less. Orientate the fans so that the heat sink fins allow airflow to go across the onboard heat sink(s) instead of the expansion slots. Depending on the fan manufacturer, the wiring and plug may be different. The red wire should be positive, while the black should be ground. Connect the fan's plug to the board taking into consideration the polarity of the this connector.

NOTE: The "Rotation" signal is to be used only by a specially designed fan with rotation signal.

WARNING! The CPU and/or motherboard will overheat if there is no airflow across the CPU and onboard heatsinks. Damage may occur to the motherboard and/or the CPU fan if these pins are incorrectly used. **These are not jumpers, do not place jumper caps over these pins.**

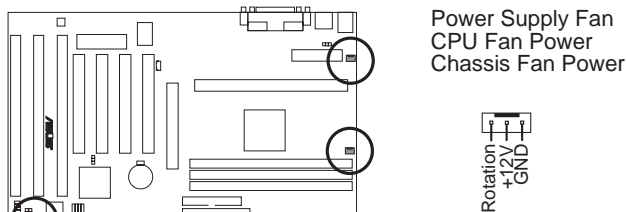

P2B 12Volt Cooling Fan Power

10. Chassis Intrusion Alarm Lead (4-1 pin CHASIS)

This requires an external detection mechanism such as a chassis intrusion monitor/sensor or microswitch. The sensor is triggered when a high level signal is sent to the CHASIS lead. This occurs when the side panel is opened or drive bay doors are opened.

NOTE: When the chassis is opened, connect/short the Chassis Signal pin to the +5VSB pin. When the chassis is closed, connect/short the Chassis Signal pin to the Ground pin.

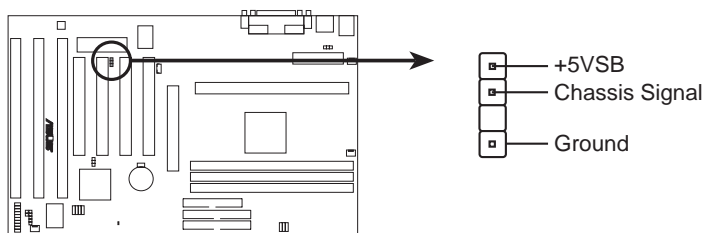

P2B Chassis Intrusion Alarm Lead

III. INSTALLATION

11. IrDA-Compliant Infrared Module Connector (5-pin IR)

This connector supports the optional wireless transmitting and receiving infrared module. This module mounts to a small opening on system cases that support this feature. You must also configure the setting through “UART2 Use Infrared” in **Chipset Features Setup** to select whether UART2 is directed for use with COM2 or IrDA. Use the five pins as shown on the Back View and connect a ribbon cable from the module to the motherboard according to the pin definitions.

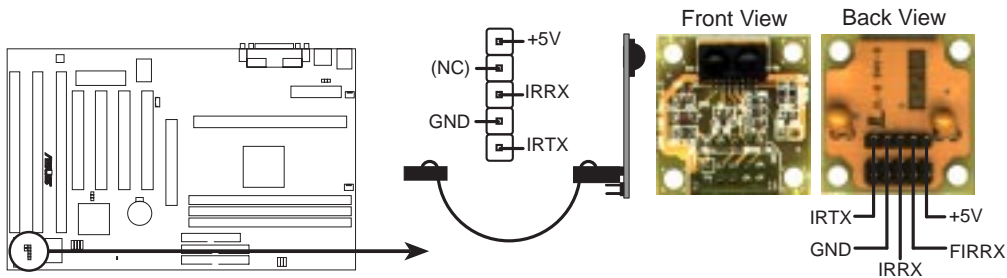

P2B Infrared Module Connector

For the infrared feature to be available, you must connect the optional Infrared (IrDA) module to the motherboard

12. ATX Power Supply Connector (20-pin ATXPWR)

This connector connects to a ATX power supply. The plug from the power supply will only insert in one orientation because of the different hole sizes. Find the proper orientation and push down firmly but gently making sure that the pins are aligned.

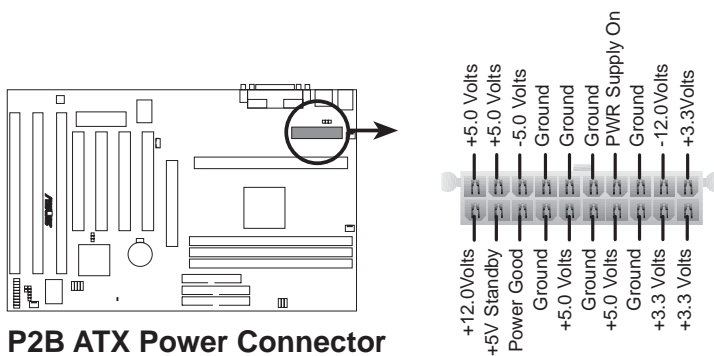

P2B ATX Power Connector

IMPORTANT: Make sure that your ATX power supply can supply at least 10mAmp on the 5-volt standby lead (5VSB). You may experience difficulty in powering on your system if your power supply cannot support the load. For Wake on LAN support, your ATX power supply must supply at least 720mA.

III. INSTALLATION

13. Wake-on-LAN Connector (3-pin WOL_CON)

The WOL_CON connector powers up the system when a wakeup packet or signal is received from the network through the ASUS PCI-L101 LAN card (see section **VII. ASUS LAN Card**).

IMPORTANT: This feature requires that the **WAKE On LAN Power Up Control** is set to *Enabled* (see “Power Management Setup” under **IV. BIOS SOFTWARE**) and that your system has an ATX power supply with at least 720mA +5V standby power.

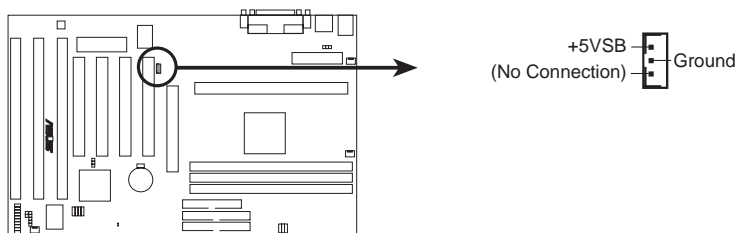

P2B Wake on LAN Connector

14. SB-Link™ Connector (6-1 pin SBLINK)

Using Intel’s PC-PCI DMA and serialized IRQ protocols found in this motherboard’s AGPset, this connector allows Sound Blaster 16 compatibility to AWE64D (Digital) or other PCI audio cards, enabling users to play Real-mode DOS games and multimedia applications. SB-Link acts as a bridge between the motherboard and the PCI audio card by providing the DMA and IRQ signals present in the ISA bus but not available on the PCI bus.

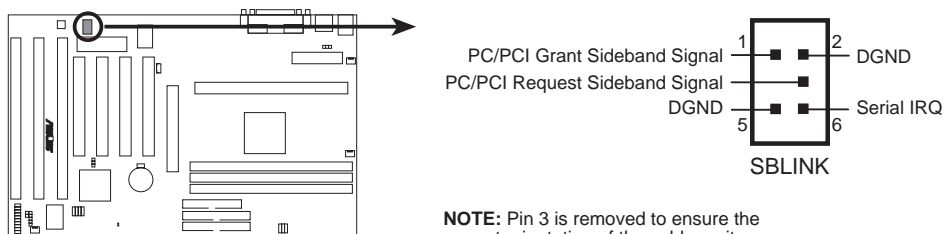

P2B SB-Link™ Connector

15. SMBus Connector (5-1 pin SMB)

This connector allows you to connect SMBus devices. SMBus devices communicate by means of the SMBus with an SMBus host and/or other SMBus devices. The SMBus or System Management Bus is a specific implementation of an I²C bus, which is a multi-master bus, that is, multiple chips can be connected to the same bus and each one can act as a master by initiating data transfer.

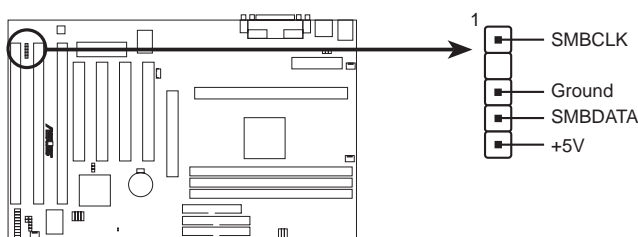

P2B SMBus Connector

III. INSTALLATION

16. Message LED Lead (MSG.LED)

This indicates whether a message has been received from a fax/modem. The LED will remain lit when there is no signal and blink when there is data transfer or waiting in the inbox. This function requires ACPI OS and driver support.

17. SMI Suspend Switch Lead (SMI)

This allows the user to manually place the system into a suspend mode or “Green” mode where system activity will be instantly decreased to save electricity and expand the life of certain components when the system is not in use. This 2-pin connector (see the figure below) connects to the case-mounted suspend switch. If you do not have a switch for the connector, you may use the “Turbo Switch” since it does not have a function. SMI is activated when it detects a *short to open* moment and therefore leaving it shorted will not cause any problems. This may require one or two pushes depending on the position of the switch.

18. ATX Power Switch / Soft Power Switch (PWR.SW)

The system power is controlled by a momentary switch connected to this lead. Pushing the button once will switch the system between ON and SLEEP. Pushing the switch while in the ON mode for more than 4 seconds will turn the system off. The system power LED shows the status of the system’s power.

19. Reset Switch Lead (RESET)

This 2-pin connector connects to the case-mounted reset switch for rebooting your computer without having to turn off your power switch. This is a preferred method of rebooting to prolong the life of the system’s power supply.

20. System Power LED (PWR LED)

This 3-pin connector connects the system power LED, which lights when the system is powered on and blinks when it is in sleep mode.

21. Keyboard Lock Switch Lead (KEYLOCK)

This 2-pin connector connects to the case-mounted key switch to allow keyboard locking.

22. Speaker Connector (SPEAKER)

This 4-pin connector connects to the case-mounted speaker.

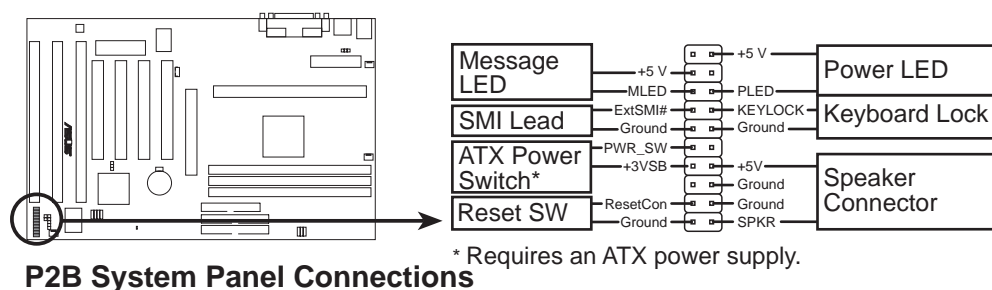

III. INSTALLATION

Power Connection Procedures

1. After all connections are made, close the system case cover.
 2. Be sure that all switches are off (in some systems, marked with ○).
 3. Connect the power supply cord into the power supply located on the back of your system case according to your system user's manual.
 4. Connect the power cord into a power outlet that is equipped with a surge protector.
 5. You may then turn on your devices in the following order:
 - a. Your monitor
 - b. External SCSI devices (starting with the last device on the chain)
 - c. Your system power. For ATX power supplies, you need to switch on the power supply as well as press the ATX power switch on the front of the case.
 6. The power LED on the front panel of the system case will light. For ATX power supplies, the system LED will light when the ATX power switch is pressed. The monitor LED may light up after the system's if it complies with "green" standards or if it has a power standby feature. The system will then run power-on tests. While the tests are running, additional messages will appear on the screen. If you do not see anything within 30 seconds from the time you turn on the power, the system may have failed a power-on test. Recheck your jumper settings and connections or call your retailer for assistance.
 7. During power-on, hold down <Delete> to enter BIOS setup. Follow the instructions in the next section, BIOS SOFTWARE.
- * **Powering Off your computer:** You must first exit or shut down your operating system before switching off the power switch. For ATX power supplies, you can press the ATX power switch after exiting or shutting down your operating system. If you use Windows 95, click the **Start** button, click **Shut Down**, and then click **Shut down the computer?**. The system will give three quick beeps after about 30 seconds and then power off after Windows shuts down.

NOTE: The message "You can now safely turn off your computer" will not appear when shutting down with ATX power supplies.

IV. BIOS SOFTWARE

Flash Memory Writer Utility

This motherboard has an onboard SCSI BIOS and boot virus protection and therefore, requires a 2Mbit flash ROM.

AFLASH.EXE: This is the Flash Memory Writer utility that updates the BIOS by uploading a new BIOS file to the 2Mbit programmable flash ROM chip on the motherboard. To determine the BIOS version of your motherboard, check the last four numbers of the code displayed on the upper left-hand corner of your screen during bootup. Larger numbers represent a newer BIOS file. This file works only in DOS mode.

NOTE: The following screen displays are provided as examples only and may not reflect the screen contents displayed on your system.

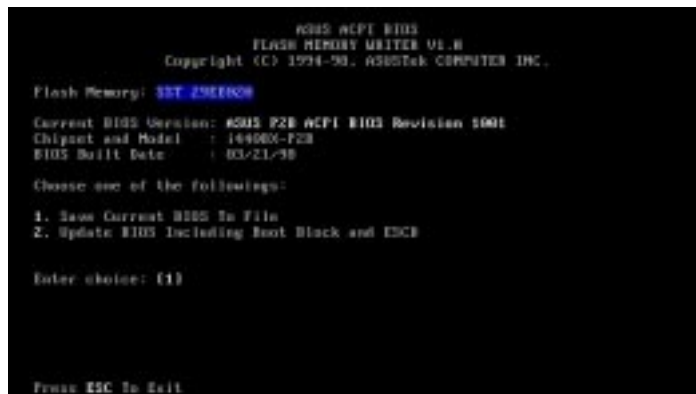

IMPORTANT! If “unknown” is displayed after **Flash Memory:**, the memory chip is either not programmable or is not supported by the ACPI BIOS and therefore, cannot be programmed by the Flash Memory Writer utility.

Main Menu

1. Save Current BIOS To File

This option allows you to save a copy of the original motherboard BIOS in case you need to reinstall it. It is recommended that you save **AFLASH.EXE** and the BIOS file to a bootable floppy disk.

To save your current BIOS, type [1] at the **Main Menu** and then press <Enter>. The **Save Current BIOS To File** screen appears.

Type a filename and the path, for example, **A:\440BX-1** and then press <Enter>.

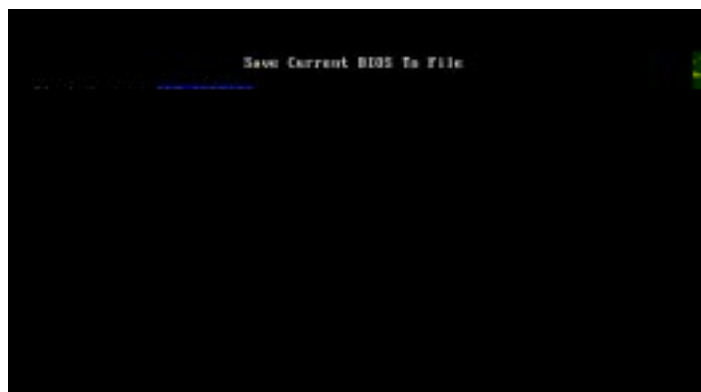

IV. BIOS SOFTWARE

2. Update BIOS Including Boot Block and ESCD

This option updates the boot block, the baseboard BIOS, and the ACPI extended system configuration data (ESCD) parameter block from a new BIOS file. See the next page for procedures on downloading an updated BIOS file.

To update your current BIOS, type **2** at the **Main Menu** and then press <Enter>. The **Update BIOS Including Boot Block and ESCD** screen appears. Type the filename of your new BIOS and the path, for example, **A:\BX2I1002.AWD**, and then press <Enter>.

When prompted to confirm the BIOS update, press **Y** to start the update.

The utility starts to program the new BIOS information into the flash ROM. When the programming is finished, *Flashed Successfully* will be displayed.

Follow the onscreen instructions to continue.

```
Update BIOS Including Boot Block and ESCD
Flash Memory: SST 25E000
Current BIOS Version: ASUS P2B ACPI BIOS Revision 1001
Chipset and Model : 159800-P2B
BIOS Build Date : 03/21/98
Please Enter File Name for NEW BIOS: A:\BX2I1002.AWD
```

```
Update BIOS Including Boot Block and ESCD
Flash Memory: SST 25E000
BIOS Version
1 CURRENT 1 ASUS P2B ACPI BIOS Revision 1001
BX2I1002.AWD 1 ASUS P2B ACPI BIOS Revision 1002
Chipset and Model
1 CURRENT 1 159800-<CF2B>-B
BX2I1002.AWD 1 159800-<CF2B>-B
Date of BIOS Build
1 CURRENT 1 03/21/98
BX2I1002.AWD 1 03/25/98
Are you sure (Y/N) ? [Y]
Press ESC To Return to Main Menu
```

```
Update BIOS Including Boot Block and ESCD
Flash Memory: SST 25E000
BIOS Version
1 CURRENT 1 ASUS P2B ACPI BIOS Revision 1001
BX2I1002.AWD 1 ASUS P2B ACPI BIOS Revision 1002
Chipset and Model
1 CURRENT 1 159800-<CF2B>-B
BX2I1002.AWD 1 159800-<CF2B>-B
Date of BIOS Build
1 CURRENT 1 03/21/98
BX2I1002.AWD 1 03/25/98
Are you sure (Y/N) ? [Y]
Programming -- 20FFF
Flashed Successfully
Press ESC To Return to Main Menu
```

```
ASUS ACPI BIOS
FLASH MEMORY WRITER V1.0
Copyright (C) 1994-99, ASUSTek COMPUTER INC.
Flash Memory: SST 25E000
Current BIOS Version: ASUS P2B ACPI BIOS Revision 1001
Chipset and Model : 159800-P2B
BIOS Build Date : 03/21/98
Choose one of the followings:
1, Save Current BIOS To File
2, Update BIOS Including Boot Block and ESCD
Enter choice: [1]
You have flashed the EPROM. It is recommended that you turn off
the power, enter SETUP and Load Setup Defaults to have CMOS
updated with new BIOS when exits.
Press ESC To Exit
```

IV. BIOS SOFTWARE

Managing and Updating Your Motherboard's BIOS

Upon First Use of the Computer System

1. Create a bootable system floppy disk by typing [FORMAT A:/S] from the DOS prompt without creating "AUTOEXEC.BAT" and "CONFIG.SYS" files.
2. Copy AFLASH.EXE to the just created boot disk.
3. Run AFLASH.EXE from this new disk and select option **1. Save Current BIOS to File**. See **1. Save Current BIOS To File** on the previous page for more details and the rest of the steps.

Updating BIOS Procedures (only when necessary)

1. Download an updated ASUS BIOS file from the Internet (WWW or FTP) or a BBS (Bulletin Board Service) (see ASUS CONTACT INFORMATION on page 3 for details) and save to the disk you created earlier.
2. Boot from the disk you created earlier.
3. At the "A:\>" prompt, type **AFLASH** and then press <Enter>.
4. At the **Main Menu**, type **2** and then press <Enter>. See **2. Update BIOS Including Boot Block and ESCD** on the previous page for more details and the rest of the steps.

WARNING! If you encounter problems while updating the new BIOS, DO NOT turn off your system since this might prevent your system from booting up. Just repeat the process, and if the problem still persists, update the original BIOS file you saved to disk above. If the Flash Memory Writer utility was not able to successfully update a complete BIOS file, your system may not be able to boot up. If this happens, your system will need service.

IV. BIOS SOFTWARE

6. BIOS Setup

The motherboard supports two programmable Flash ROM chips: 5 Volt and 12 Volt. Either of these memory chips can be updated when BIOS upgrades are released. Use the Flash Memory Writer utility to download the new BIOS file into the ROM chip as described in detail in this section.

All computer motherboards provide a Setup utility program for specifying the system configuration and settings. If your motherboard came in a computer system, the proper configuration entries may have already been made. If so, invoke the Setup utility, as described later, and take note of the configuration settings for future reference; in particular, the hard disk specifications.

If you are installing the motherboard, reconfiguring your system or you receive a Run Setup message, you will need to enter new setup information. This section describes how to configure your system using this utility.

The BIOS ROM of the system stores the Setup utility. When you turn on the computer, the system provides you with the opportunity to run this program. This appears during the Power-On Self Test (POST). Press <Delete> to call up the Setup utility. If you are a little bit late pressing the mentioned key(s), POST will continue with its test routines, thus preventing you from calling up Setup. If you still need to call Setup, reset the system by pressing <Ctrl> + <Alt> + <Delete>, or by pressing the Reset button on the system case. You can also restart by turning the system off and then back on again. But do so only if the first two methods fail.

When you invoke Setup, the CMOS SETUP UTILITY main program screen will appear with the following options:



IV. BIOS SOFTWARE

Load Defaults

The “Load BIOS Defaults” option loads the minimum settings for troubleshooting. “**Load Setup Defaults**”, on the other hand, is for loading optimized defaults for regular use. Choosing defaults at this level, will modify all applicable settings.

A section at the bottom of the above screen displays the control keys for this screen. Take note of these keys and their respective uses. Another section just below the control keys section displays information on the currently highlighted item in the list.

Standard CMOS Setup

This “Standard CMOS Setup” option allows you to record some basic system hardware configuration and set the system clock and error handling. If the motherboard is already installed in a working system, you will not need to select this option anymore. However, if the configuration stored in the CMOS memory on the board gets lost or damaged, or if you change your system hardware configuration, you will need to respecify the configuration values. The configuration values usually get lost or corrupted when the power of the onboard CMOS battery weakens.



The preceding screen provides you with a list of options. At the bottom of this screen are the control keys for this screen. Take note of these keys and their respective uses.

User-configurable fields appear in a different color. If you need information on the selected field, press <F1>. The help menu will then appear to provide you with the information you need. The memory display at the lower right-hand side of the screen is read-only and automatically adjusts accordingly.

Details of Standard CMOS Setup:

Date

To set the date, highlight the “Date” field and then press either <Page Up>/<Page Down> or <+>/<-> to set the current date. Follow the month, day and year format. Valid values for month, day and year are: **Month: (1 to 12), Day: (1 to 31), Year: (up to 2079)**

IV. BIOS SOFTWARE

Time

To set the time, highlight the “Time” field and then press either <Page Up>/<Page Down> or <+>/<-> to set the current time. Follow the hour, minute and second format. Valid values for hour, minute and second are: (**Hour: (00 to 23)**, **Minute: (00 to 59)**, **Second: (00 to 59)**). Press <Enter> twice if you do not want to modify the current time.

NOTE: You can bypass the date and time prompts by creating an AUTOEXEC.BAT file. For information on how to create this file, please refer to the MS-DOS manual.

Hard Disks

This field records the specifications for all non-SCSI hard disk drives installed in your system. The onboard PCI IDE connectors provide Primary and Secondary channels for connecting up to four IDE hard disks or other IDE devices. Each channel can support up to two hard disks; the first of which is the “master” and the second is the “slave”.

Specifications for SCSI hard disks need not to be entered here since they operate using device drivers and are not supported by any the BIOS. If you install either the optional PCI-SC200 or PCI-SC860 SCSI controller card into the motherboard, see section VI for instructions. If you install other vendor’s SCSI controller card, refer to their respective documentations on how to install the required SCSI drivers.

For IDE hard disk drive setup, you can:

- Use the *Auto* setting for detection during bootup.
- Use the IDE HDD AUTO DETECTION in the main menu to automatically enter the drive specifications.
- Enter the specifications yourself manually by using the “User” option.

The entries for specifying the hard disk type include **CYLS** (number of cylinders), **HEAD** (number of read/write heads), **PRECOMP** (write precompensation), **LANDZ** (landing zone), **SECTOR** (number of sectors) and **MODE**. The **SIZE** field automatically adjusts according to the configuration you specify. The documentation that comes with your hard disk should provide you with the information regarding the drive specifications.

The **MODE** entry is for IDE hard disks only, and can be ignored for MFM and ESDI drives. This entry provides three options: *Normal*, *Large*, *LBA*, or *Auto* (see below). Set **MODE** to the *Normal* for IDE hard disk drives smaller than 528MB; set it to *LBA* for drives over 528MB that support Logical Block Addressing (LBA) to allow larger IDE hard disks; set it to *Large* for drives over 528MB that do not support LBA. *Large* type of drive can only be used with MS-DOS and is very uncommon. Most IDE drives over 528MB support the *LBA* mode.

IV. BIOS SOFTWARE

Auto detection of hard disks on bootup

For each field: Primary Master, Primary Slave, Secondary Master, and Secondary Slave, you can select *Auto* under the TYPE and MODE fields. This will enable auto detection of your IDE hard disk during bootup. This will allow you to change your hard disks (with the power off) and then power on without having to reconfigure your hard disk type. If you use older hard disks that do not support this feature, then you must configure the hard disk in the standard method as described earlier by the “User” option.

NOTE: After the IDE hard disk drive information has been entered into BIOS, new IDE hard disk drives must be partitioned (such as with FDISK) and then formatted before data can be read from and write on. Primary IDE hard disk drives must have its partition set to *active* (also possible with FDISK).

NOTE: SETUP Defaults are noted in parenthesis next to each function heading.

Drive A / Drive B (None)

These fields record the types of floppy disk drives installed in your system. The available options for drives A and B are: *360KB, 5.25 in.; 1.2MB, 5.25 in.; 720KB, 3.5 in.; 1.44MB, 3.5 in.; 2.88MB, 3.5 in.; None*

To enter the configuration value for a particular drive, highlight its corresponding field and then select the drive type using the left- or right-arrow keys.

Floppy 3 Mode Support (Disabled)

This is the Japanese standard floppy drive. The standard stores 1.2MB in a 3.5inch diskette. This is normally disabled but you may choose from either: *Drive A, Drive B, Both, and Disabled*

Video (EGA/VGA)

Set this field to the type of video display card installed in your system. The options are *EGA/VGA, CGA 49, CGA 80, and Mono* (for Hercules or MDA).

If you are using a VGA or any higher resolution card, choose *EGA/VGA*.

Halt On (All Errors)

This field determines which types of errors will cause the system to halt. Choose from *All Errors; No Errors; All,But Keyboard, All,But Diskette; and All,But Disk/Key*.

IV. BIOS SOFTWARE

BIOS Features Setup

This “BIOS Features Setup” option consists of configuration entries that allow you to improve your system performance, or let you set up some system features according to your preference. Some entries are required by the motherboard’s design to remain in their default settings.



A section at the lower right of the screen displays the control keys you can use. Take note of these keys and their respective uses. If you need information on a particular entry, highlight it and then press <F1>. A pop-up help menu will appear to provide you with the information you need. <F5> loads the last set values, <F6> and <F7> loads the BIOS default values and Setup default values, respectively.

NOTE: SETUP Defaults are noted in parenthesis next to each function heading.

Details of BIOS Features Setup

CPU Internal Core Speed (350MHz)

This function is reserved for future use and is currently disabled.

Boot Virus Detection (Enabled)

This field allows you to set boot virus detection, ensuring a virus-free boot sector. This new antivirus solution is unlike native BIOS tools, which offer limited virus protection typically by write-protecting the partition table. With this new solution, your computer is protected against boot virus threats earlier in the boot cycle, that is, before they have a chance to load into your system. This ensures your computer boots to a clean operating system. The system halts and displays a warning message when it detects a virus. If this occurs, you can either allow the operation to continue or use a virus-free bootable floppy disk to restart and investigate your system. Because of conflicts with new operating systems, for example, during installation of new softwares, you may have to set this to *Disabled* to prevent write errors.

IV. BIOS SOFTWARE

CPU Level 1 Cache / CPU Level 2 Cache (Enabled)

These fields allow you to choose from the default of *Enabled* or choose *Disabled* to turn on or off the CPU's Level 1 and Level 2 built-in cache.

CPU Level 2 Cache ECC Check (Disabled)

This function controls the ECC check capability in the CPU level 2 cache.

BIOS Update (Enabled)

This functions as an update loader integrated into the BIOS to supply the processor with the required data. The BIOS will load the update on all processors during system bootup in the default position of *Enabled*.

Quick Power On Self Test (Enabled)

This field speeds up the Power-On Self Test (POST) routine by skipping retesting a second, third, and fourth time. Setup default setting for this field is *Enabled*. A complete test of the system is done on each test.

HDD Sequence SCSI/IDE First (IDE)

When using both SCSI and IDE hard disk drives, IDE is always the boot disk using drive letter C (default setting of *IDE*). This new feature allows a SCSI hard disk drive to be the boot disk when set to *SCSI*. This allows multiple operating systems to be used on both IDE and SCSI drives or the primary operating system to boot using a SCSI hard disk drive.

Boot Sequence (A,C)

This field determines where the system looks first for an operating system. Options are *A,C*; *A,CDROM,C*; *CDROM,C,A*; *D,A*; *E,A*; *F,A*; *C only*; *LS/ZIP, C*; and *C,A*. The setup default setting is to check first the floppy disk and then the hard disk drive, that is, *A, C*.

Boot Up Floppy Seek (Disabled)

When enabled, the BIOS will seek drive A once.

Floppy Disk Access Control (R/W)

This allows protection of files from the computer system to be copied to floppy disks by allowing the setting of *Read Only* to only allow reads from the floppy disk drive but not writes. The setup default *R/W* allows both reads and writes.

IDE HDD Block Mode Sectors (HDD MAX)

This field enhances hard disk performance by making multi-sector transfers instead of one sector per transfer. Most IDE drives, except older versions, can utilize this feature. Selections are *HDD MAX*, *Disabled*, *2*, *4*, *8*, *16*, and *32*.

IV. BIOS SOFTWARE

Security Option (System)

When you specify a *Supervisor Password* and/or *User Password* (explained later in this section), the Security Option field determines when the system prompts for the password. The default setting is *System*, where the system prompts for the User Password every time you start your system. The other option is *Setup*, where the system goes through its startup routine unless the Setup utility is called, when the system prompts for the Supervisor Password.

PS/2 Mouse Function Control (Auto)

The default of *Auto* allows the system to detect a PS/2 mouse on bootup. If detected, IRQ12 will be used for the PS/2 mouse. IRQ12 will be reserved for expansion cards if a PS/2 mouse is not detected. *Enabled* will always reserve IRQ12, whether on bootup a PS/2 mouse is detected or not.

PCI/VGA Palette Snoop (Disabled)

Some display cards that are nonstandard VGA such as graphics accelerators or MPEG Video Cards may not show colors properly. The setting *Enabled* should correct this problem. Otherwise leave this on the setup default setting of *Disabled*.

OS/2 Onboard Memory > 64M (Disabled)

When using OS/2 operating systems with installed DRAM of greater than 64MB, you need to set this option to *Enabled* otherwise leave this on *Disabled*.

.....

Video ROM BIOS Shadow (Enabled)

This field allows you to change the video BIOS location from ROM to RAM. Relocating to RAM enhances system performance, as information access is faster than the ROM.

C8000-CBFFF to DC000-DFFFF (Disabled)

These fields are used for shadowing other expansion card ROMs. If you install other expansion cards with ROMs on them, you will need to know which addresses the ROMs use to shadow them specifically. Shadowing a ROM reduces the memory available between 640K and 1024K by the amount used for this purpose.

Boot Up NumLock Status (On)

This field enables users to activate the Number Lock function upon system boot.

Typematic Rate Setting (Disabled)

When enabled, you can set the two typematic controls listed next. Setup default setting is *Disabled*.

Typematic Rate (Chars/Sec) (6)

This field controls the speed at which the system registers repeated keystrokes. Options range from 6 to 30 characters per second. Setup default setting is **6**; other settings are 8, 10, 12, 15, 20, 24, and 30.

Typematic Delay (Msec) (250)

This field sets the time interval for displaying the first and second characters. Four delay rate options are available: 250, 500, 750, and 1000.

IV. BIOS SOFTWARE

Chipset Features Setup

This “Chipset Features Setup” option controls the configuration of the board’s chipset. Control keys for this screen are the same as for the previous screen.



NOTE: SETUP Defaults are noted in parenthesis next to each function heading.

Details of Chipset Features Setup

SDRAM Configuration (By SPD)

This sets the optimal timings for items 2-5. Leave on default setting.

SDRAM CAS Latency (2T)

This controls the latency between SDRAM read command and the time that the data actually becomes available. Leave on default setting.

SDRAM RAS to CAS Delay (3T)

This controls the latency between SDRAM active command and the read/write command. Leave on default setting.

SDRAM RAS Precharge Time (3T)

This controls the idle clocks after issuing a precharge command to SDRAM. Leave on default setting.

DRAM Idle Timer (16T)

This controls the idle clocks before closing an opened SDRAM page. Leave on default setting.

SDRAM MA Wait State (Normal)

This controls the leadoff clocks for CPU read cycles. Leave on default setting.

Snoop Ahead (Enabled)

Enabled will allow PCI streaming. Leave on default setting.

Host Bus Fast Data Ready (Enabled)

Leave on default setting.

16-bit I/O Recovery Time (1 BUSCLK) / 8-bit I/O Recovery Time (1 BUSCLK)

Timing for 16-bit and 8-bit ISA cards, respectively. Leave on default setting.

IV. BIOS SOFTWARE

Graphics Aperture Size (64MB)

Memory-mapped, graphics data structures can reside in a Graphics Aperture. Leave on default setting.

Video Memory Cache Mode (UC)

USWC (uncacheable, speculative write combining) is a new cache technology for the video memory of the processor. It can greatly improve the display speed by caching the display data. You must leave this on the default setting of UC (uncacheable) if your display card cannot support this feature or else your system may not boot.

PCI 2.1 Support (Enabled)

This function allows you to enable or disable PCI 2.1 features including passive release and delayed transaction. Leave *Enabled* (default setting) for PCI 2.1 compliancy.

Memory Hole At 15M–16M (Disabled)

Enabling this feature reserves 15MB to 16MB memory address space to ISA expansion cards that specifically require this setting. This makes the memory from 15MB and up unavailable to the system. Expansion cards can only access memory up to 16MB. The default is *Disabled*.

DRAM are xx bits wide

If all your DRAM modules have ECC chips (e.g., 8 chips + 1 ECC chips), they are considered 72bits and the following will be displayed:

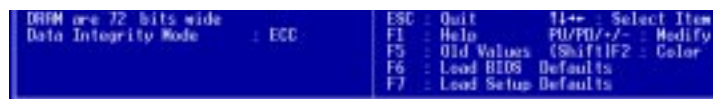

If your DRAM modules do not have ECC chips (e.g. 8 chips), they are considered 64 bits and the following will be displayed instead:

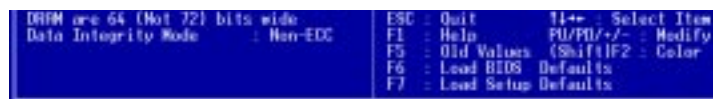

Data Integrity Mode (Non-ECC)

Non-ECC has byte-wise write capability but no provision for protecting data integrity in the DRAM array. *EC-Only* data errors are detected but not corrected. *ECC* with hardware scrubbing allows a detection of single-bit and multiple-bit errors and recovery of single-bit errors. (See section III for more information on DRAM memory modules.)

Onboard FDC Controller (Enabled)

When *Enabled*, this field allows you to connect your floppy disk drives to the onboard floppy disk drive connector instead of a separate controller card. If you want to use a different controller card to connect the floppy disk drives, set this field to *Disabled*.

IV. BIOS SOFTWARE

Onboard FDC Swap A & B (No Swap)

This field allows you to reverse the hardware drive letter assignments of your floppy disk drives. Two options are available: *No Swap* and *Swap AB*. If you want to switch drive letter assignments through the onboard chipset, set this field to *Swap AB*.

Onboard Serial Port 1 (3F8H/IRQ4)

Settings are *3F8H/IRQ4*, *2F8H/IRQ3*, *3E8H/IRQ4*, *2E8H/IRQ10*, and *Disabled* for the onboard serial connector.

Onboard Serial Port 2 (2F8H/IRQ3)

Settings are *3F8H/IRQ4*, *2F8H/IRQ3*, *3E8H/IRQ4*, *2E8H/IRQ10*, and *Disabled* for the onboard serial connector.

Onboard Parallel Port (378H/IRQ7)

This field sets the address of the onboard parallel port connector. You can select either: *3BCH/IRQ 7*, *378H/IRQ 7*, *278H/IRQ 5*, *Disabled*. If you install an I/O card with a parallel port, ensure that there is no conflict in the address assignments. The PC can support up to three parallel ports as long as there are no conflicts for each port.

Parallel Port Mode (ECP+EPP)

This field allows you to set the operation mode of the parallel port. The setting *Normal*, allows normal-speed operation but in one direction only; *EPP* allows bidirectional parallel port operation at maximum speed; *ECP* allows the parallel port to operate in bidirectional mode and at a speed faster than the maximum data transfer rate; *ECP+EPP* allows normal speed operation in a two-way mode.

ECP DMA Select (3)

This selection is available only if you select *ECP* or *ECP+EPP* in the **Parallel Port Mode**. Select either DMA Channel *1*, *3*, or *Disable*.

UART2 Use Infrared (Disabled)

When enabled, this field activates the onboard infrared feature and sets the second serial UART to support the infrared module connector on the motherboard. If your system already has a second serial port connected to the onboard COM2 connector, it will no longer work if you enable the infrared feature. By default, this field is set to *Disabled*, which leaves the second serial port UART to support the COM2 serial port connector. See **IrDA-compliant infrared module connector** under section III.

Onboard PCI IDE Enable (Both)

You can select to enable the *primary* IDE channel, *secondary* IDE channel, *both*, or *disable* both channels (for systems with only SCSI drives).

IDE Ultra DMA Mode (Auto)

This field autodetects Ultra DMA capability (for improved transfer speeds and data integrity) for compatible IDE devices. Set to *Disable* to suppress Ultra DMA capability.

IDE 0 Master/Slave PIO/DMA Mode, IDE 1 Master/Slave PIO/DMA Mode (Auto)

Each channel (0 and 1) has both a master and a slave making four IDE devices possible. Because each IDE device may have a different Mode timing (0, 1, 2, 3, 4), it is necessary for these to be independent. The default setting of *Auto* will allow autodetection to ensure optimal performance

IV. BIOS SOFTWARE

Power Management Setup

This “Power Management Setup” option allows you to reduce power consumption. This feature turns off the video display and shuts down the hard disk after a period of inactivity.



NOTE: SETUP Defaults are noted in parenthesis next to each function heading.

Details of Power Management Setup

Power Management (User Define)

This field acts as the master control for the power management modes. *Max Saving* puts the system into power saving mode after a brief period of system inactivity; *Min Saving* is almost the same as *Max Saving* except that this time the system inactivity period is longer; *Disable* disables the power saving features; *User Define* allows you to set power saving options according to your preference.

IMPORTANT: Advanced Power Management (APM) should be installed to keep the system time updated when the computer enters suspend mode activated by the BIOS Power Management. For DOS environments, you need to add the statement, `DEVICE=C:\DOS\POWER.EXE`, in your `CONFIG.SYS`. For Windows 3.x and Windows 95, you need to install Windows with the APM feature. A battery and power cord icon labeled “Power” will appear in the “Control Panel.” Choose “Advanced” in the Power Management Field.

Video Off Option (Suspend -> Off)

This field determines when to activate the video off feature for monitor power management. The settings are *Suspend -> Off* and *Always On*.

IV. BIOS SOFTWARE

Video Off Method (DPMS OFF)

This field defines the video off features. The following options are available: *DPMS OFF*, *DPMS Reduce ON*, *Blank Screen*, *V/H SYNC+Blank*, *DPMS Standby*, and *DPMS Suspend*. The DPMS (Display Power Management System) features allow the BIOS to control the video display card if it supports the DPMS feature. *Blank Screen* only blanks the screen (use this for monitors without power management or “green” features. If set up in your system, your screen saver will not display with *Blank Screen* selected). *V/H SYNC+Blank* blanks the screen and turns off vertical and horizontal scanning.

.....

PM Timers

This section controls the time-out settings for the Power Management scheme. The fields included in this section are “HDD Power Down”, which places the hard disk into its lowest power consumption mode, and the Doze, Standby and Suspend system inactivation modes.

The system automatically “wakes up” from any power saving mode when there is system activity such as when a key is pressed from the keyboard, or when there is activity detected from the enabled IRQ channels.

HDD Power Down (Disable)

Shuts down any IDE hard disk drives in the system after a period of inactivity. This time period is user-configurable to *1–15 Min* or *Disable*. This feature does not affect SCSI hard drives.

Suspend Mode (Disable)

Sets the period of time after which each of these modes activate: *30 sec*, *1 Min*, *2 Min*, *4 Min*, *8 Min*, *20 Min*, *30 Min*, *40 Min*, *1 Hour*, and *Disable*.

.....

Power Up Control

This section determines the ways the system can be controlled when it is started or restarted, when modem activity is detected, or when power to the computer is interrupted and reapplied. The Soft-Off mode refers to powering off the system through a momentary button switch (ATX switch) or through the software as opposed to disconnecting the AC power by way of a rocker switch or other means.

PWR Button < 4 Secs (Soft Off)

When set to *Soft Off*, the ATX switch can be used as a normal system power-off button when pressed for less than 4 seconds. *Suspend* allows the button to have a dual function where pressing less than 4 seconds will place the system in sleep mode. *No Function* disables the ATX switch function when the button is pressed under 4 seconds. Regardless of the setting, holding the ATX switch for more than 4 seconds will power off the system.

IV. BIOS SOFTWARE

PWR Up On Modem Act (Enabled)

This allows either settings of *Enabled* or *Disabled* for powering up the computer (turns the ATX power supply on) when the modem receives a call while the computer is *Soft Off*.

NOTE: The computer cannot receive or transmit data until the computer and applications are fully running, thus connection cannot be made on the first try. Turning an external modem off and then back on while the computer is off causes an initialization string that will also cause the system to power on.

AC PWR Loss Restart (Disabled)

This allows you to set whether you want your system to boot up after the power has been interrupted. *Disabled* leaves your system off after reapplying power and *Enabled* boots up your system after reapplying power.

Wake On LAN (Enabled)

This allows you to remotely power up your system through your network by sending a wake-up frame or signal. With this feature, you can remotely upload/download data to/from systems during off-peak hours. Set to *Enabled* to set this feature.

IMPORTANT: This feature requires the ASUS PCI-L101 LAN Card (see **VII. ASUS LAN Card**) and an ATX power supply with at least 720mA +5V standby power.

Automatic Power Up (Disabled)

This allows you to have an unattended or automatic power up of your system. You may configure your system to power up at a certain time of the day by selecting *Everyday*, which will allow you to set the time or at a certain time and day by selecting *By Date*.

.....

Fan Monitor (xxxxRPM)

The onboard hardware monitor is able to detect the Chassis Fan Speed, CPU Fan Speed, and the Power Supply Fan Speed in Rotations Per Minute (RPM). These values refresh upon any key entries in the BIOS setup screen. Set to *Ignore* if one of these are not used so that error messages will not be given.

.....

Thermal Monitor (xxxC/xxxF)

The onboard hardware monitor is able to detect the CPU and MB (motherboard) temperatures. These values refresh upon key entries. Set to *Ignore* only if necessary.

.....

Voltage Monitor (xx.xV)

The onboard hardware monitor is able to detect the voltages put out by the voltage regulators. These values refresh upon key entries. Set to *Ignore* only if necessary.

NOTE: If any of the monitored items are out of range, an error message will appear: "Hardware Monitor found an error, enter POWER MANAGEMENT SETUP for details". You will then be prompted to "Press **F1** to continue, **DEL** to enter SETUP".

IV. BIOS SOFTWARE

PNP and PCI Setup

This “PNP and PCI Setup” option configures the PCI bus slots. All PCI bus slots on the system use INTA#, thus all installed PCI cards must be set to this value.

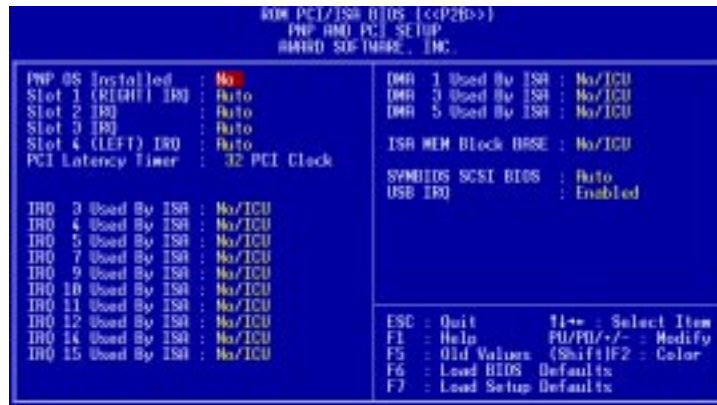

NOTE: SETUP Defaults are noted in parenthesis next to each function heading.

Details of PNP and PCI Setup

PNP OS Installed (No)

This field allows you to use a Plug-and-Play (PnP) operating system to configure the PCI bus slots instead of using the BIOS. Thus interrupts may be reassigned by the OS when *Yes* is selected. When a non-PnP OS is installed or to prevent reassigning of interrupt settings, select the default setting of *No*.

Slot 1 (RIGHT) IRQ to Slot 4/5 (LEFT) IRQ (Auto)

These fields set how IRQ use is determined for each PCI slot. The default setting for each field is *Auto*, which uses auto-routing to determine IRQ use. The other options are manual settings of *NA*, *5*, *7*, *9*, *10*, *11*, *12*, *14* or *15* for each slot.

PCI Latency Timer (32 PCI Clock)

The default setting of *32 PCI Clock* enables maximum PCI performance for this motherboard.

IRQ xx Used By ISA (No/ICU)

These fields indicate whether or not the displayed IRQ for each field is being used by a legacy (non-PnP) ISA card. Two options are available: *No/ICU* and *Yes*. The first option, the default value, indicates either that the displayed IRQ is not used or an ISA Configuration Utility (ICU) is being used to determine if an ISA card is using that IRQ. If you install a legacy ISA card that requires a unique IRQ, and you are not using an ICU, you must set the field for that IRQ to *Yes*. For example: If you install a legacy ISA card that requires IRQ 10, then set **IRQ10 Used By ISA** to *Yes*.

.....

IV. BIOS SOFTWARE

DMA x Used By ISA (No/ICU)

These fields indicate whether or not the displayed DMA channel for each field is being used by a legacy (non-PnP) ISA card. Available options include: *No/ICU* and *Yes*. The first option, the default setting, indicates either that the displayed DMA channel is not used or an ICU is being used to determine if an ISA card is using that channel. If you install a legacy ISA card that requires a unique DMA channel, and you are not using an ICU, you must set the field for that channel to *Yes*.

ISA MEM Block BASE (No/ICU)

This field allows you to set the base address and block size of a legacy ISA card that uses any memory segment within the C800H and DFFFH address range. If you have such a card, and you are not using an ICU to specify its address range, select a base address from the six available options; the **ISA MEM Block SIZE** field will then appear for selecting the block size. If you have more than one legacy ISA card in your system that requires to use this address range, you can increase the block size to either 8K, 16K, 36K, or 64K. If you are using an ICU to accomplish this task, leave **ISA MEM Block BASE** to its default setting of *No/ICU*.

SYMBIOS SCSI BIOS (Auto)

The default uses *Auto* settings for the onboard SCSI BIOS. If you do not want to use the onboard SCSI BIOS, choose *Disabled*

USB IRQ (Enabled)

Enabled reserves an IRQ# for the USB to work, *Disabled* does not allow the USB to have an IRQ# and therefore prevents the USB from functioning. If you are not using any USB devices, you may set this feature to *Disabled* to save an extra IRQ# for expansion cards.

IV. BIOS SOFTWARE

Load BIOS Defaults

This “Load BIOS Defaults” option allows you to load the troubleshooting default values permanently stored in the BIOS ROM. These default settings are non-optimal and disable all high performance features. To load these default settings, highlight “Load BIOS Defaults” on the main screen and then press <Enter>. The system displays a confirmation message on the screen. Press <Y> and then <Enter> to confirm. Press <N> and then <Enter> to abort. This feature does not affect the fields on the Standard CMOS Setup screen.

Load Setup Defaults

This “Load Setup Defaults” option allows you to load the default values to the system configuration fields. These default values are the optimized configuration settings for the system. To load these default values, highlight “Load Setup Defaults” on the main screen and then press <Enter>. The system displays a confirmation message on the screen. Press <Y> and then <Enter> to confirm. Press <N> and then <Enter> to abort. This feature does not affect the fields on the Standard CMOS Setup screen.

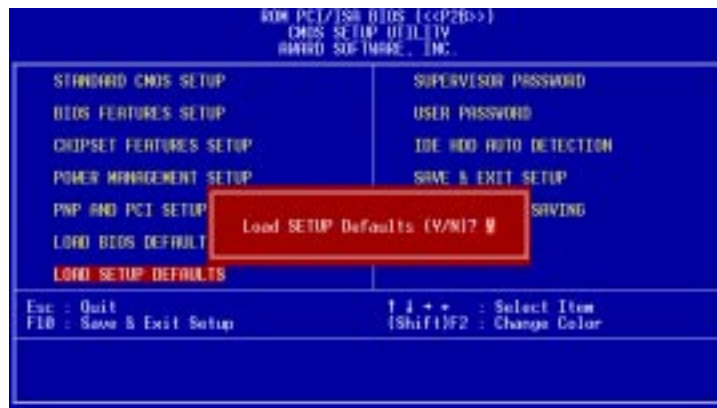

IV. BIOS SOFTWARE

Supervisor Password and User Password

These two options set the system passwords. “Supervisor Password” sets a password that will be used to protect the system and the Setup utility; “User Password” sets a password that will be used exclusively on the system. By default, the system comes without any passwords. To specify a password, highlight the type you want and then press <Enter>. A password prompt appears on the screen. Taking note that the password is case sensitive, and can be up to 8 alphanumeric characters long, type in your password and then press <Enter>. The system confirms your password by asking you to type it again. After setting a password, the screen automatically reverts to the main screen.



To implement password protection, specify in the “Security Option” field of the BIOS Features Setup screen when the system will prompt for the password. If you want to disable either password, press <Enter> instead of entering a new password when the “Enter Password” prompt appears. A message confirms the password has been disabled.

NOTE: If you forget the password, see CMOS RAM in section III for procedures on clearing the CMOS.

IV. BIOS SOFTWARE

IDE HDD Auto Detection

This “IDE HDD Auto Detection” option detects the parameters of an IDE hard disk drive, and automatically enters them into the Standard CMOS Setup screen.

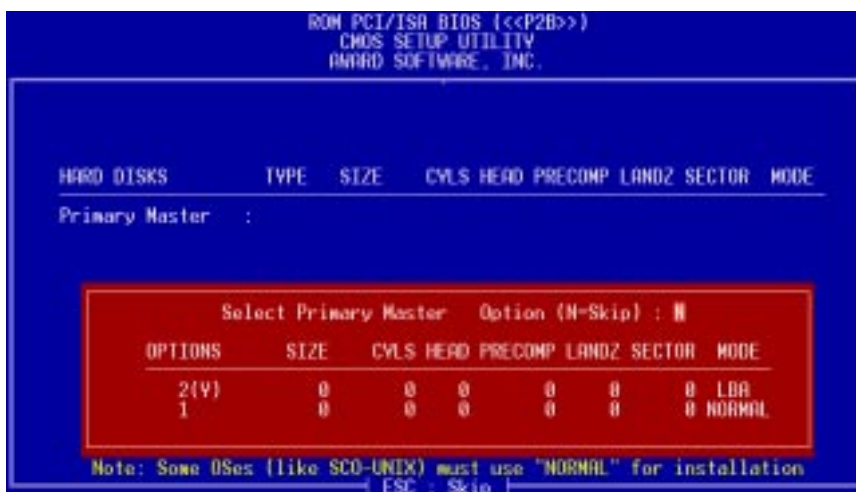

Up to four IDE drives can be detected, with parameters for each listed inside the box. To accept the optimal entries, press <Y> or else select from the numbers displayed under the OPTIONS field (2, 1, 3 in this case); to skip to the next drive, press <N>. If you accept the values, the parameters will appear listed beside the drive letter on the screen. The process then proceeds to the next drive letter. Pressing <N> to skip rather than to accept a set of parameters causes the program to enter zeros after that drive letter.

Remember that if you are using another IDE controller that does not feature Enhanced IDE support for four devices, you can only install two IDE hard disk drives. Your IDE controller must support the Enhanced IDE features in order to use Drive E and Drive F. The onboard PCI IDE controller supports Enhanced IDE, with two connectors for connecting up to four IDE devices. If you want to use another controller that supports four drives, you must disable the onboard IDE controller in the Chipset Features Setup screen.

When auto-detection is completed, the program automatically enters all entries you accepted on the field for that drive in the Standard CMOS Setup screen. Skipped entries are ignored and are not entered in the screen.

If you are auto-detecting a hard disk that supports the LBA mode, three lines will appear in the parameter box. Choose the line that lists LBA for an LBA drive. Do not select Large or Normal.

The auto-detection feature can only detect one set of parameters for a particular IDE hard drive. Some IDE drives can use more than one set. This is not a problem if the drive is new and empty.

IV. BIOS SOFTWARE

IMPORTANT: If your hard disk was already formatted on an older previous system, incorrect parameters may be detected. You will need to enter the correct parameters manually or use low-level format if you do not need the data stored on the hard disk.

If the parameters listed differ from the ones used when the disk was formatted, the disk will not be readable. If the auto-detected parameters do not match the ones that should be used for your disk, do not accept them. Press <N> to reject the presented settings and enter the correct ones manually from the Standard CMOS Setup screen.

Save & Exit Setup

Select this option to save into the CMOS memory all modifications you specified during the current session. To save the configuration changes, highlight the “Save & Exit Setup” option on the main screen, type “Y”, and then press <Enter>.



Exit Without Saving

Select this option to exit the Setup utility without saving the modifications you specify during the current session. To exit without saving, highlight the “Exit Without Saving” option on the main screen and then press <Enter>.

V. DESKTOP MANAGEMENT

Desktop Management Interface (DMI)

Introducing the ASUS DMI Configuration Utility

This motherboard supports DMI within the BIOS level and provides a DMI Configuration Utility to maintain the Management Information Format Database (MIFD). DMI is able to auto-detect and record information pertinent to a computer's system such as the CPU type, CPU speed, and internal/external frequencies, and memory size. The onboard BIOS will detect as many system information as possible and store those collected information in a 4KB block in the motherboard's Flash EPROM and allow the DMI to retrieve data from this database. Unlike other BIOS software, the BIOS on this motherboard uses the same technology implemented for Plug and Play to allow dynamic real-time updating of DMI information versus creating a new BIOS image file and requiring the user to update the whole BIOS. This DMI Configuration Utility also allows the system integrator or end user to add additional information into the MIFD such as serial numbers, housing configurations, and vendor information. Those information not detected by the motherboard BIOS and has to be manually entered through the DMI Configuration Utility and updated into the MIFD. This DMI Configuration Utility provides the same reliability as PnP updating and will prevent the refreshing failures associated with updating the entire BIOS.

System Requirements

The DMI Configuration Utility (DMICFG2.EXE) must be used in real mode in order for the program to run, the base memory must be at least 180K. Memory

V. DESKTOP MANAGEMENT

Using the ASUS DMI Configuration Utility

NOTE: The following screen displays are provided as examples only and may not reflect the screen contents on your system.

Edit DMI (or delete)

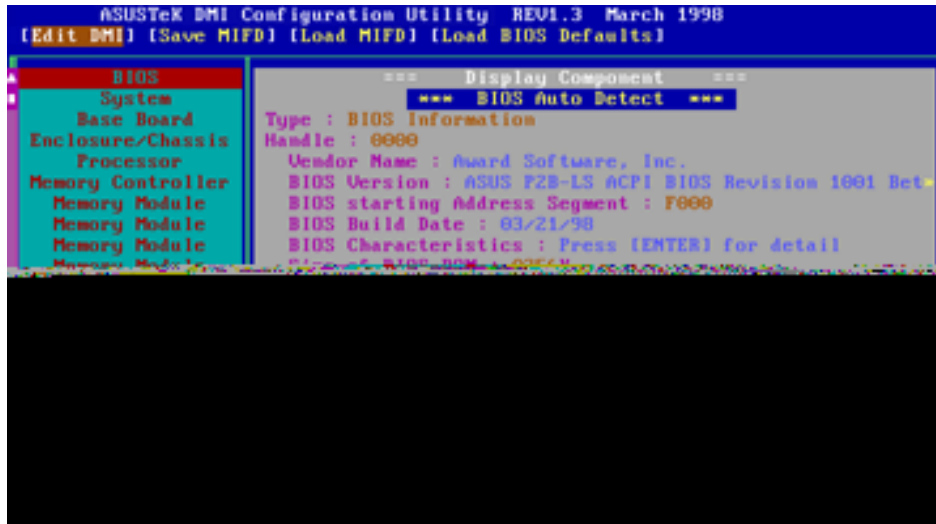

Use the ←→ (left-right) cursors to move the top menu items and the ↑↓ (up-down) cursor to move between the left hand menu items. The bottom of the screen will show the available keys for each screen. Press enter at the menu item to enter the right hand screen for editing. “Edit component” appears on top. The reversed color field is the current cursor position and the blue text are available for editing. The orange text shows auto-detected information and are not available for editing. The blue text “Press [ENTER] for detail” contains a second pop-up menu is available, use the + - (plus-minus) keys to change the settings. Enter to exit *and save*, ESC to exit *and not save*.

If the user has made changes, ESC will prompt you to answer Y or N. Enter Y to go back to the left-hand screen *and save*, enter N to go back to left-hand screen and *not save*. If editing has not been made, ESC will send you back to the left hand menu without any messages.

Notes

A heading, *** BIOS Auto Detect ***, appears on the right for each menu item on the left side that has been auto detected by the system BIOS.

A heading, *** User Modified ***, will appear on the right for menu items that have been modified by the user.



V. DESKTOP MANAGEMENT

Save MIFD

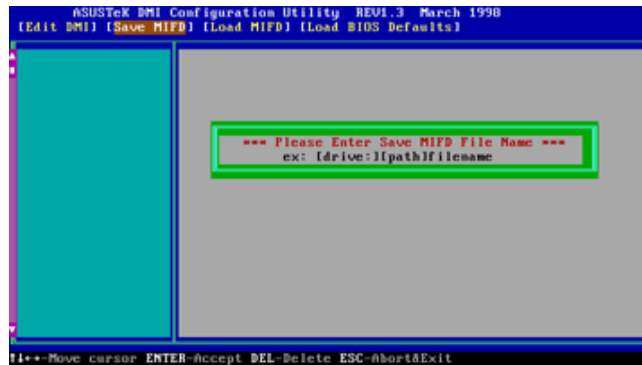

You can save the MIFD (normally only saved to flash ROM) to a file by entering the drive and path here. If you want to cancel save, you may press ESC and a message “Bad File Name” appears here to show it was not saved.

Load MIFD



You can load the disk file to memory by entering a drive and path and file name here.

Load BIOS Defaults

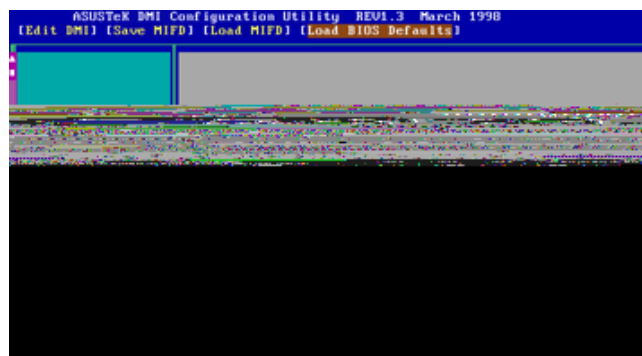

You can load the BIOS defaults from a MIFD file and can clear all user modified and added data. You must reboot your computer in order for the defaults to be saved back into the Flash BIOS.

VI. ASUS LAN Card

ASUS PCI-L101 Fast Ethernet Card

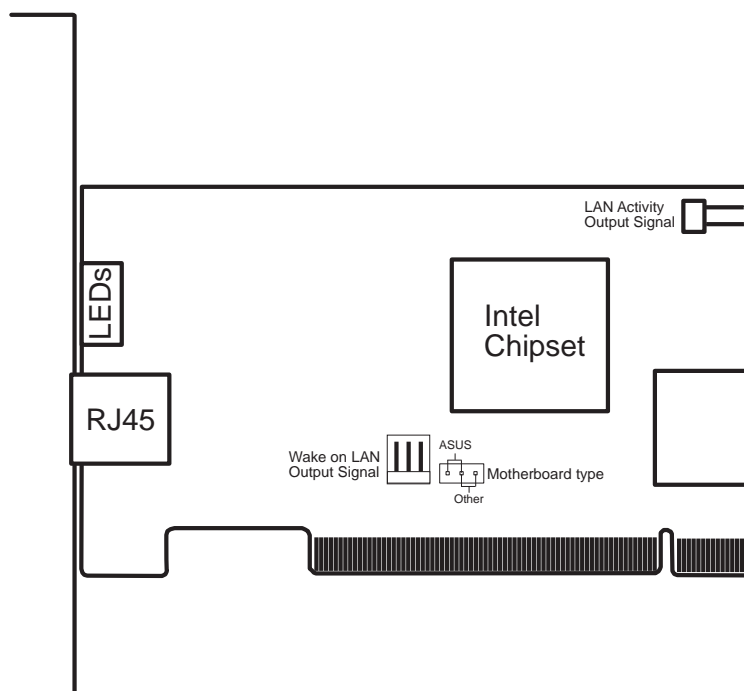
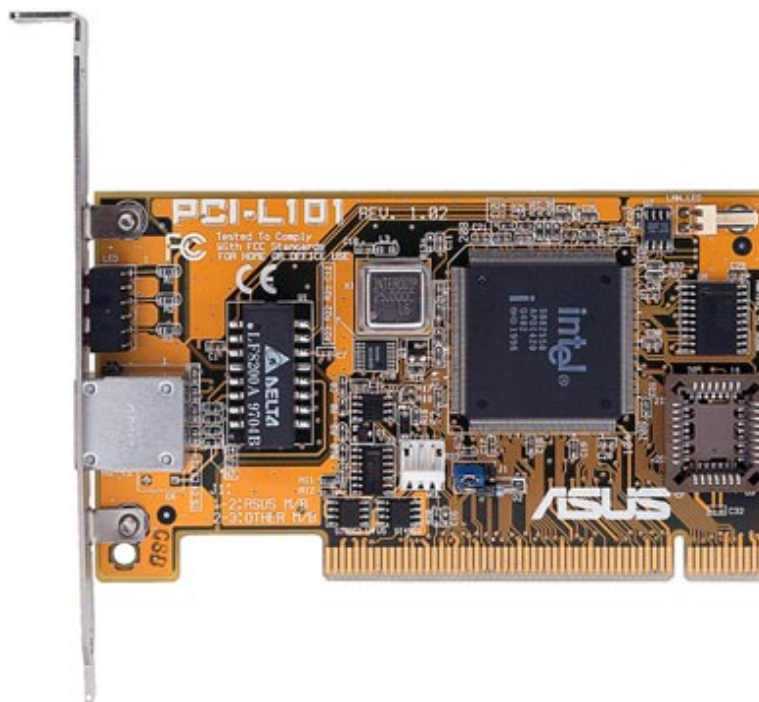

If you are using the ASUS PCI-L101 on an ASUS motherboard, leave the jumper on its default setting of “ASUS.” If you are using another brand of motherboard, set the jumper to “Other.” Connect the Wake on LAN (WOL) output signal to the motherboard’s WOL_CON in order to utilize the wake on LAN feature of the motherboard. Connect the LAN activity output signal (LAN_LED) to the system cabinet’s front panel LAN_LED in order to display the LAN data activity.

VI. ASUS LAN Card

Features

- Intel 82558 Ethernet LAN Controller (Fully integrated 10BASE-T/100BASE-TX)
- Wake-On-LAN Remote Control Function Supported
- PCI Bus Master Complies to PCI Local Bus Rev. 2.1 specifications
- Consists of MAC & PHY (10/100Mbps) interfaces
- Complies to IEEE 802.3 10BASE-T and IEEE 802.3u 100BASE-TX interfaces
- Fully supports 10BASE-T & 100BASE-TX operations through a single RJ45 port
- Supports 32-bit Bus Master Technology / PCI Rev. 2.1
- Enhancements on ACPI & APM
- Adheres to PCI Bus Power Management Interface Rev. 1.0, ACPI Rev. 1.0, and Device Class Power Management Rev. 1.0
- IEEE 802.3u auto-negotiation for 10Mbps/100Mbps Network Data Transfer Rates.
- Provides LED indicators for monitoring network conditions
- Plug and Play

Software Driver Support

- **NetWare ODI Drivers** - Novell Netware 3.x, 4.x, DOS, OS/2 Client
- **NDIS 2.01 Drivers** - Microsoft LAN Manager, Microsoft Windows 3.11, IBM LAN Server
- **NDIS 3.0 Drivers** - Microsoft Windows NT, Microsoft Windows 95, Microsoft Windows 3.11

Question and Answer

Q: What is Wake-On-LAN ?

A: The Wake-On-LAN feature provides the capability to remotely power on systems supporting Wake-On-LAN by simply sending a wake-up frame. With this feature, remotely uploading/downloading data to/from systems during off-peak hours will be feasible.

Q: What can Wake-On-LAN do for you ?

A: Wake-On-LAN is a remote management tool with advantages that can reduce system management workload, provide flexibility to the system administrator's job, and then of course save you time-consuming efforts and costs.

Q: What components does Wake-On-LAN require to be enable?

A: To enable Wake-On-LAN function, your system requires Ethernet LAN adapter card that can activate Wake-On-LAN function, a client with Wake-On-LAN capability, and software such as LDCM Rev. 3.10 or up that can trigger wake-up frame.

(This page was intentionally left blank.)

(This page was intentionally left blank.)

(This page was intentionally left blank.)

(This page was intentionally left blank.)

Free Manuals Download Website

<http://myh66.com>

<http://usermanuals.us>

<http://www.somanuals.com>

<http://www.4manuals.cc>

<http://www.manual-lib.com>

<http://www.404manual.com>

<http://www.luxmanual.com>

<http://aubethermostatmanual.com>

Golf course search by state

<http://golfingnear.com>

Email search by domain

<http://emailbydomain.com>

Auto manuals search

<http://auto.somanuals.com>

TV manuals search

<http://tv.somanuals.com>