

# M5A99FX PRO R2.0

**ASUS**<sup>®</sup>

# Motherboard

**Copyright © 2013 ASUSTeK COMPUTER INC. All Rights Reserved.**

No part of this manual, including the products and software described in it, may be reproduced, transmitted, transcribed, stored in a retrieval system, or translated into any language in any form or by any means, except documentation kept by the purchaser for backup purposes, without the express written permission of ASUSTeK COMPUTER INC. ("ASUS").

Product warranty or service will not be extended if: (1) the product is repaired, modified or altered, unless such repair, modification of alteration is authorized in writing by ASUS; or (2) the serial number of the product is defaced or missing.

ASUS PROVIDES THIS MANUAL "AS IS" WITHOUT WARRANTY OF ANY KIND, EITHER EXPRESS OR IMPLIED, INCLUDING BUT NOT LIMITED TO THE IMPLIED WARRANTIES OR CONDITIONS OF MERCHANTABILITY OR FITNESS FOR A PARTICULAR PURPOSE. IN NO EVENT SHALL ASUS, ITS DIRECTORS, OFFICERS, EMPLOYEES OR AGENTS BE LIABLE FOR ANY INDIRECT, SPECIAL, INCIDENTAL, OR CONSEQUENTIAL DAMAGES (INCLUDING DAMAGES FOR LOSS OF PROFITS, LOSS OF BUSINESS, LOSS OF USE OR DATA, INTERRUPTION OF BUSINESS AND THE LIKE), EVEN IF ASUS HAS BEEN ADVISED OF THE POSSIBILITY OF SUCH DAMAGES ARISING FROM ANY DEFECT OR ERROR IN THIS MANUAL OR PRODUCT.

SPECIFICATIONS AND INFORMATION CONTAINED IN THIS MANUAL ARE FURNISHED FOR INFORMATIONAL USE ONLY, AND ARE SUBJECT TO CHANGE AT ANY TIME WITHOUT NOTICE, AND SHOULD NOT BE CONSTRUED AS A COMMITMENT BY ASUS. ASUS ASSUMES NO RESPONSIBILITY OR LIABILITY FOR ANY ERRORS OR INACCURACIES THAT MAY APPEAR IN THIS MANUAL, INCLUDING THE PRODUCTS AND SOFTWARE DESCRIBED IN IT.

Products and corporate names appearing in this manual may or may not be registered trademarks or copyrights of their respective companies, and are used only for identification or explanation and to the owners' benefit, without intent to infringe.

**Offer to Provide Source Code of Certain Software**

This product contains copyrighted software that is licensed under the General Public License ("GPL"), under the Lesser General Public License Version ("LGPL") and/or other Free Open Source Software Licenses. Such software in this product is distributed without any warranty to the extent permitted by the applicable law. Copies of these licenses are included in this product.

Where the applicable license entitles you to the source code of such software and/or other additional data, you may obtain it for a period of three years after our last shipment of the product, either

(1) for free by downloading it from <http://support.asus.com/download>

or

(2) for the cost of reproduction and shipment, which is dependent on the preferred carrier and the location where you want to have it shipped to, by sending a request to:

ASUSTeK Computer Inc.  
Legal Compliance Dept.  
15 Li Te Rd.,  
Beitou, Taipei 112  
Taiwan

In your request please provide the name, model number and version, as stated in the About Box of the product for which you wish to obtain the corresponding source code and your contact details so that we can coordinate the terms and cost of shipment with you.

The source code will be distributed WITHOUT ANY WARRANTY and licensed under the same license as the corresponding binary/object code.

This offer is valid to anyone in receipt of this information.

ASUSTeK is eager to duly provide complete source code as required under various Free Open Source Software licenses. If however you encounter any problems in obtaining the full corresponding source code we would be much obliged if you give us a notification to the email address [gpl@asus.com](mailto:gpl@asus.com), stating the product and describing the problem (please DO NOT send large attachments such as source code archives, etc. to this email address).

# Contents

Safety information.....	vi
About this guide.....	vii
M5A99FX PRO R2.0 specifications summary.....	ix
Package contents.....	xiii
Installation tools and components.....	xiv
<b>Chapter 1: Product introduction</b>	
<b>1.1 Special features.....</b>	<b>1-1</b>
1.1.1 Product highlights.....	1-1
1.1.2 Dual Intelligent Processors 3 with New DIGI+ Power Control ....	1-2
1.1.3 ASUS Exclusive Features.....	1-3
1.1.4 ASUS Quiet Thermal Solution.....	1-3
1.1.5 ASUS EZ DIY.....	1-4
1.1.6 Other special features.....	1-5
<b>1.2 Motherboard overview.....</b>	<b>1-6</b>
1.2.1 Before you proceed.....	1-6
1.2.2 Motherboard layout.....	1-7
1.2.3 Central Processing Unit (CPU).....	1-9
1.2.4 System memory.....	1-10
1.2.5 Expansion slots.....	1-22
1.2.6 Onboard buttons and switches.....	1-24
1.2.7 Jumpers.....	1-26
1.2.8 Onboard LEDs.....	1-27
1.2.9 Internal connectors.....	1-28
<b>Chapter 2: Basic Installation</b>	
<b>2.1 Building your PC system.....</b>	<b>2-1</b>
2.1.1 Motherboard installation.....	2-1
2.1.2 CPU installation.....	2-4
2.1.3 CPU heatsink and fan assembly installation.....	2-5
2.1.4 DIMM installation.....	2-8
2.1.5 ATX Power connection.....	2-9
2.1.6 SATA device connection.....	2-10
2.1.7 Front I/O Connector.....	2-11
2.1.8 Expansion Card installation.....	2-12
<b>2.2 BIOS update utility.....</b>	<b>2-13</b>
2.2.1 USB BIOS Flashback.....	2-13
<b>2.3 Motherboard rear and audio connections.....</b>	<b>2-15</b>
2.3.1 Rear I/O connection.....	2-15
2.3.2 Audio I/O connections.....	2-17

2.4	Starting up for the first time.....	2-20
2.5	Turning off the computer.....	2-20

**Chapter 3: BIOS setup**

3.1	Knowing BIOS.....	3-1
3.2	BIOS setup program.....	3-2
	3.2.1 EZ Mode.....	3-3
	3.2.2 Advanced Mode.....	3-4
3.3	Main menu.....	3-6
3.4	Ai Tweaker menu.....	3-8
3.5	Advanced menu.....	3-15
	3.5.1 CPU Configuration.....	3-16
	3.5.2 North Bridge Configuration.....	3-17
	3.5.3 South Bridge Configuration.....	3-18
	3.5.4 SATA Configuration.....	3-19
	3.5.5 USB Configuration.....	3-21
	3.5.6 CPU Core On/Off Function.....	3-23
	3.5.7 Onboard Devices Configuration.....	3-23
	3.5.8 APM.....	3-25
	3.5.9 Network Stack.....	3-26
3.6	Monitor menu.....	3-27
3.7	Boot menu.....	3-29
3.8	Tools menu.....	3-32
	3.8.1 ASUS EZ Flash 2 Utility.....	3-32
	3.8.2 ASUS SPD Information.....	3-32
	3.8.3 ASUS O.C. Profile.....	3-33
3.9	Exit menu.....	3-34
3.10	Updating BIOS.....	3-35
	3.10.1 ASUS Update.....	3-35
	3.10.2 ASUS EZ Flash 2.....	3-38
	3.10.3 ASUS BIOS Updater.....	3-40

**Chapter 4: Software support**

4.1	Installing an operating system.....	4-1
4.2	Support DVD information.....	4-1
	4.2.1 Running the support DVD.....	4-1
	4.2.2 Obtaining the software manuals.....	4-2
4.3	Software information.....	4-3
	4.3.1 AI Suite II.....	4-3
	4.3.2 DIGI+ Power Control.....	4-4

4.3.3	TurboV EVO .....	4-8
4.3.4	EPU .....	4-12
4.3.5	Remote GO! .....	4-13
4.3.6	USB 3.0 Boost .....	4-24
4.3.7	Network iControl .....	4-25
4.3.8	USB BIOS Flashback Wizard.....	4-29
4.3.9	FAN Xpert.....	4-31
4.3.10	Ai Charger+ .....	4-32
4.3.11	Probe II.....	4-33
4.3.12	Sensor Recorder .....	4-34
4.3.13	ASUS Update.....	4-36
4.3.14	MyLogo2 .....	4-37
4.3.15	Audio configurations.....	4-39

## **Chapter 5: RAID support**

<b>5.1</b>	<b>RAID configurations .....</b>	<b>5-1</b>
5.1.1	RAID definitions .....	5-1
5.1.2	Installing Serial ATA hard disks .....	5-2
5.1.3	Setting the RAID item in BIOS .....	5-2
5.1.4	AMD® Option ROM utility .....	5-3
<b>5.2</b>	<b>Creating a RAID driver disk.....</b>	<b>5-6</b>
5.2.1	Creating a RAID driver disk without entering the OS.....	5-6
5.2.2	Creating a RAID driver disk in Windows®.....	5-6
5.2.3	Installing the RAID driver during Windows® OS installation .....	5-7
5.2.4	Using a USB floppy disk drive .....	5-8

## **Chapter 6: Multiple GPU support**

<b>6.1</b>	<b>AMD® CrossFireX™ technology .....</b>	<b>6-1</b>
6.1.1	Requirements.....	6-1
6.1.2	Before you begin .....	6-1
6.1.3	Installing two CrossFireX™ graphics cards .....	6-2
6.1.4	Installing the device drivers.....	6-3
6.1.5	Enabling the AMD® CrossFireX™ technology.....	6-3
<b>6.2</b>	<b>NVIDIA® SLI™ technology .....</b>	<b>6-5</b>
6.2.1	Requirements.....	6-5
6.2.2	Installing two SLI-ready graphics cards .....	6-5
6.2.3	Installing the device drivers.....	6-6
6.2.4	Enabling the NVIDIA® SLI™ technology .....	6-7

## **Appendices**

<b>Notices .....</b>	<b>A-1</b>
<b>ASUS contact information.....</b>	<b>A-4</b>

## **Safety information**

### **Electrical safety**

- To prevent electrical shock hazard, disconnect the power cable from the electrical outlet before relocating the system.
- When adding or removing devices to or from the system, ensure that the power cables for the devices are unplugged before the signal cables are connected. If possible, disconnect all power cables from the existing system before you add a device.
- Before connecting or removing signal cables from the motherboard, ensure that all power cables are unplugged.
- Seek professional assistance before using an adapter or extension cord. These devices could interrupt the grounding circuit.
- Ensure that your power supply is set to the correct voltage in your area. If you are not sure about the voltage of the electrical outlet you are using, contact your local power company.
- If the power supply is broken, do not try to fix it by yourself. Contact a qualified service technician or your retailer.

### **Operation safety**

- Before installing the motherboard and adding devices on it, carefully read all the manuals that came with the package.
- Before using the product, ensure all cables are correctly connected and the power cables are not damaged. If you detect any damage, contact your dealer immediately.
- To avoid short circuits, keep paper clips, screws, and staples away from connectors, slots, sockets and circuitry.
- Avoid dust, humidity, and temperature extremes. Do not place the product in any area where it may become wet.
- Place the product on a stable surface.
- If you encounter technical problems with the product, contact a qualified service technician or your retailer.

## About this guide

This user guide contains the information you need when installing and configuring the motherboard.

## How this guide is organized

This guide contains the following parts:

- **Chapter 1: Product introduction**  
This chapter describes the features of the motherboard and the new technology it supports. It includes description of the switches, jumpers, and connectors on the motherboard.
- **Chapter 2: Basic Installation**  
This chapter lists the hardware setup procedures that you have to perform when installing system components.
- **Chapter 3: BIOS setup**  
This chapter tells how to change system settings through the BIOS Setup menus. Detailed descriptions of the BIOS parameters are also provided.
- **Chapter 4: Software support**  
This chapter describes the contents of the support DVD that comes with the motherboard package and the software.
- **Chapter 5: RAID support**  
This chapter describes the RAID configurations.
- **Chapter 6: Multiple GPU technology support**  
This chapter describes how to install and configure multiple AMD® CrossFireX™ and NVIDIA® SLI™ graphics cards.

## Where to find more information

Refer to the following sources for additional information and for product and software updates.

1. **ASUS websites**  
The ASUS website provides updated information on ASUS hardware and software products. Refer to the ASUS contact information.
2. **Optional documentation**  
Your product package may include optional documentation, such as warranty flyers, that may have been added by your dealer. These documents are not part of the standard package.

## Conventions used in this guide

To ensure that you perform certain tasks properly, take note of the following symbols used throughout this manual.



**DANGER/WARNING:** Information to prevent injury to yourself when trying to complete a task.



**CAUTION:** Information to prevent damage to the components when trying to complete a task



**IMPORTANT:** Instructions that you **MUST** follow to complete a task..



**NOTE:** Tips and additional information to help you complete a task.

## Typography

**Bold text**

Indicates a menu or an item to select.

*Italics*

Used to emphasize a word or a phrase.

<Key>

Keys enclosed in the less-than and greater-than sign means that you must press the enclosed key.

Example: <Enter> means that you must press the Enter or Return key.

<Key1> + <Key2> + <Key3>

If you must press two or more keys simultaneously, the key names are linked with a plus sign (+).



## M5A99FX PRO R2.0 specifications summary

<b>CPU</b>	<p>AMD® Socket AM3+ for AMD® FX Series CPU up to 8-core</p> <p>Compatible with AMD® Socket AM3 for AMD® Phenom™II/Athlon™II/Sempron™ 100 Series Processors</p> <p>AMD 140W CPU Support</p> <p>AMD Cool 'n' Quiet™ Technology</p> <p>Supports AM3+ 32nm CPU</p>
<b>Chipset</b>	AMD® 990FX / SB950
<b>System Bus</b>	Up to 5200 MT/s; HyperTransport™ 3.0
<b>Memory</b>	<p>4 x DIMM, Max. 32GB, DDR3 2133(O.C)/1866/1600/1333/1066 MHz, ECC, Non-ECC, un-buffered Memory</p> <p>Dual channel memory architecture</p> <p><b>*Due to CPU spec., AMD 100 Series CPUs support up to DDR3 1066MHz. With ASUS design, this motherboard can support up to DDR3 1333MHz.</b></p> <p><b>**Due to OS limitation, when installing total memory of 4GB capacity or more, Windows® 32-bit operation system may only recognize less than 3GB. Hence, a total installed memory of less than 3GB is recommended.</b></p> <p><b>***Refer to <a href="http://www.asus.com">www.asus.com</a> or user manual for the Memory QVL(Qualified Vendors Lists) of AM3+/AM3 CPU.</b></p>
<b>Expansion slots</b>	<p>2 x PCIe 2.0 x16 slots (Dual@x16/x16 speed)</p> <p>2 x PCIe 2.0 x16 slots (Black@x4 speed)</p> <p>1 x PCIe 2.0 x1 slot</p> <p>1 x PCI slot</p>
<b>Multi-GPU support</b>	<p>Supports NVIDIA® Quad-GPU SLI™ Technology</p> <p>Supports AMD® Quad-GPU CrossFireX™ Technology</p>
<b>Storage</b>	<p>AMD® SB950 Chipset:</p> <ul style="list-style-type: none"> <li>- 5 x SATA 6Gb/s ports with RAID 0,1,5 and 10 support (gray)</li> <li>- 1 x eSATA port</li> </ul> <p>1 x ASMedia® PCIe SATA controller:</p> <ul style="list-style-type: none"> <li>- 2 x SATA 6Gb/s ports (navy blue)</li> </ul>
<b>LAN</b>	Realtek® 8111F Gigabit LAN controller
<b>Audio</b>	<p>Realtek® ALC 892 8-channel High Definition Audio CODEC</p> <ul style="list-style-type: none"> <li>- Supports Jack-Detection, Multi-Streaming, and Front Panel Jack-Retasking</li> <li>- Supports 192khz/ 24bit True BD Lossless Sound</li> <li>- Blu-ray audio layer Content Protection</li> <li>- DTS UltraPC II</li> <li>- DTS Connect</li> <li>- Optical S/PDIF Out port at back I/O</li> <li>- ASUS Noise Filter</li> </ul>

*(continued on the next page)*

## M5A99FX PRO R2.0 specifications summary

<b>USB</b>	<p>2 x ASMedia USB 3.0 controllers</p> <ul style="list-style-type: none"><li>- 2 x USB 3.0/2.0 ports at mid-board for front panel support</li><li>- 2 x USB 3.0/2.0 ports at back panel (blue)</li></ul> <p>AMD® SB950 chipset</p> <ul style="list-style-type: none"><li>- 14 x USB 2.0/1.1 ports (6 ports at mid-board, 8 ports at back panel)</li></ul>
<b>ASUS Unique Features</b>	<p>ASUS Dual Intelligent Processors 3:</p> <p>CPU Power</p> <ul style="list-style-type: none"><li>- Industry leading Digital 6+2 Phase Power Design</li><li>- ASUS CPU Power Utility</li></ul> <p>DRAM Power</p> <ul style="list-style-type: none"><li>- Industry leading Digital 2 Phase Power Design</li><li>- ASUS DRAM Power Utility</li></ul> <p>ASUS EPU</p> <ul style="list-style-type: none"><li>- EPU</li></ul> <p>ASUS TPU</p> <ul style="list-style-type: none"><li>- Auto Tuning, TurboV</li></ul> <p>ASUS Exclusive Features</p> <ul style="list-style-type: none"><li>- ASUS UEFI BIOS EZ Mode featuring friendly graphics user interface</li><li>- Remote GO!</li><li>- Front Panel USB 3.0 Support</li><li>- Network iControl</li><li>- USB 3.0 Boost</li><li>- MemOK!</li><li>- AI Suite II</li><li>- Ai Charger+</li></ul> <p>ASUS Quiet Thermal Solution</p> <ul style="list-style-type: none"><li>- ASUS Fanless Design: Heat pipe solution</li><li>- ASUS Fan Xpert</li></ul> <p>ASUS Q-Design</p> <ul style="list-style-type: none"><li>- ASUS Q-Slot</li><li>- ASUS Q-DIMM</li><li>- ASUS Q-LED (CPU, DRAM, VGA, Boot Device LED)</li><li>- ASUS Q-Connector</li></ul> <p>ASUS EZ DIY</p> <ul style="list-style-type: none"><li>- ASUS O.C. Profile</li><li>- DirectKey</li><li>- ASUS EZ Flash 2</li><li>- ASUS MyLogo 2</li><li>- Precision Tweaker 2</li><li>- Multi-language BIOS</li><li>- USB BIOS Flashback with USB BIOS Flashback Wizard for EZ BIOS download scheduling</li></ul>

*(continued on the next page)*

## M5A99FX PRO R2.0 specifications summary

<p><b>ASUS overclocking features</b></p>	<p>Precision Tweaker 2:</p> <ul style="list-style-type: none"> <li>- vCore: Adjustable CPU voltage at 0.00625V increment</li> <li>- vDDNB: Adjustable CPU/NB voltage at 0.00625V increment</li> <li>- vNB: Adjustable NB voltage at 0.00625V increment</li> <li>- vNB HT bus: Adjustable HT voltage at 0.00625V increment</li> <li>- vDRAM Bus: Adjustable DRAM voltage at 0.005V increment</li> <li>- vSB: Adjustable SB voltage at 0.005V increment</li> </ul> <p>SFS (Stepless Frequency Selection)</p> <ul style="list-style-type: none"> <li>- Internal Base Clock tuning from 100MHz up to 600MHz at 1MHz increment</li> <li>- PCI Express frequency tuning from 100MHz up to 150MHz at 1MHz increment</li> </ul> <p>Overclocking Protection:</p> <ul style="list-style-type: none"> <li>- ASUS C.P.R.(CPU Parameter Recall)</li> </ul>
<p><b>Back Panel I/O Ports</b></p>	<ul style="list-style-type: none"> <li>1 x PS/2 keyboard</li> <li>1 x PS/2 mouse</li> <li>1 x Optical S/PDIF Out port</li> <li>1 x LAN (RJ45) port</li> <li>1 x eSATA port (red)</li> <li>2 x USB 3.0/2.0 ports (blue)</li> <li>8 x USB 2.0/1.1 ports (One can be switched to USB BIOS Flashback)</li> <li>8-channel Audio I/O</li> </ul>
<p><b>Internal I/O Ports</b></p>	<ul style="list-style-type: none"> <li>1 x USB 3.0/2.0 connector supports additional 2 USB 3.0/2.0 ports (19-pin)</li> <li>3 x USB 2.0/1.1 connectors support additional 6 USB 2.0/1.1 ports</li> <li>7 x SATA 6Gb/s connectors</li> <li>1 x CPU Fan connector (4-pin)</li> <li>1 x CPU Optional Fan connector (4-pin)</li> <li>3 x Chassis Fan connectors (4-pin)</li> <li>1 x USB BIOS Flashback Button</li> <li>Front panel audio connector</li> <li>1 x S/PDIF Out header</li> <li>1 x Clear CMOS jumper</li> <li>24-pin EATX Power connector</li> <li>8-pin EATX 12V Power connector</li> <li>System Panel (Q-Connector)</li> <li>1 x MemOK! Button</li> <li>1 x DirectKey Button</li> <li>1 x DRCT header</li> <li>1 x TPM header</li> <li>1 x COM port</li> </ul>

*(continued on the next page)*

## M5A99FX PRO R2.0 specifications summary





<b>BIOS features</b>	64 Mb Flash ROM, UEFI BIOS, PnP, DMI2.0, WfM2.0, SM BIOS 2.7, ACPI 2.0a, Multi-language BIOS, ASUS EZ Flash 2, F12 PrintScreen, F3 Shortcut Function and ASUS DRAM SPD (Serial Presence Detect) memory information
<b>Manageability</b>	WfM 2.0, DMI 2.0, WOL by PME, WOR by PME, PXE
<b>Accessories</b>	4 x Serial ATA 6Gb/s cables 2 in 1 Q-connector 1 x ASUS SLI bridge connector I/O Shield User's manual
<b>Support DVD contents</b>	Drivers ASUS Utilities ASUS Update Anti-virus software (OEM version)
<b>Form factor</b>	ATX form factor: 12 in. x 9.6 in. (30.5 cm x 24.4 cm)

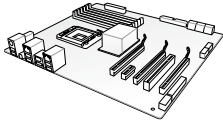

Specifications are subject to change without notice.

## Package contents

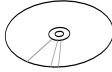
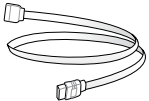
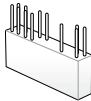
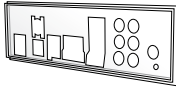



Check your motherboard package for the following items.

		
<b>ASUS M5A99FX PRO R2.0 motherboard</b>	<b>User guide</b>	<b>Support DVD</b>
		
<b>4 x Serial ATA 6.0 Gb/s cables</b>	<b>1 x 2-in-1 ASUS Q-Connector kit</b>	<b>1 x ASUS I/O Shield</b>
		
<b>1 x ASUS SLI™ bridge connector</b>		

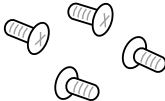

- If any of the above items is damaged or missing, contact your retailer.
- The illustrated items above are for reference only. Actual product specifications may vary with different models.

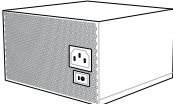
## Installation tools and components

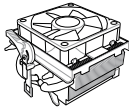
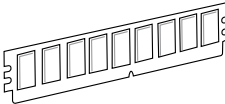
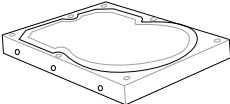
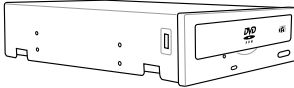
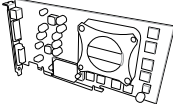
	
1 bag of screws	Phillips (cross) screwdriver
	
PC chassis	Power supply unit
	
AMD AM3+ CPU	AMD AM3+ compatible CPU Fan
	
DIMM	SATA hard disk drive
	
SATA optical disc drive (optional)	Graphics card (optional)



The tools and components in the table above are not included in the motherboard package.

# Product introduction

# 1

## 1.1 Special features

### 1.1.1 Product highlights

#### **AMD® FX™-Series/Phenom™ II/Athlon™ II/Sempron™ 100 Series Processors (socket AM3+/AM3)**

This motherboard supports AMD® AM3+/AM3 multi-core processors with unique L3 cache and delivers better overclocking capabilities with less power consumption. It features dual-channel DDR3 1866 memory support and accelerates data transfer rate up to 5200MT/s via HyperTransport™ 3.0 based system bus. This motherboard also supports AMD® CPUs in the new 32nm manufacturing process.

#### **AMD® 990FX Chipset**

AMD® 990FX Chipset is designed to support up to 5.2GT/s HyperTransport™ 3.0 (HT 3.0) interface speed and dual PCI Express™ 2.0 x16 graphics. It is optimized with AMD®'s latest AM3+ and multi-core CPUs to provide excellent system performance and overclocking capabilities.

#### **Dual-Channel DDR3 2133(O.C.)/ 1866/ 1600/ 1333/ 1066 MHz Support**

The motherboard supports the dual-channel DDR3 memory that features data transfer rates of DDR3 2133(O.C.)/ 1866/ 1600/ 1333/ 1066 MHz to boost the system's performance, and to meet the higher bandwidth requirements of 3D graphics, multimedia, and Internet applications.

#### **Quad-GPU SLI™ and Quad-GPU CrossFireX™ Support**

The motherboard's powerful AMD® 990FX platform optimizes PCIe allocation in multiple-GPU configurations of either SLI™ or CrossFireX™. This allows you to enjoy a never before-experienced brand new gaming style.

#### **AMD® SB950 Chipset**

The AMD® SB950 Southbridge natively supports the next generation SATA 6.0 Gb/s data transfer rate and PCI Express 2.0 interface.

#### **Complete USB 3.0 Integration**

ASUS facilitates strategic USB 3.0 accessibility for both the front and rear panel – 4 USB 3.0 ports in total. Experience the latest plug & play connectivity at speeds up to 10 times faster than USB 2.0. The M5A99FX PRO R2.0 affords greater convenience to high speed connectivity.

#### **Front Panel USB 3.0 Support**

ASUS provides standardized USB 3.0 front panel support which is compatible with any chassis. Enjoy faster throughput of USB 3.0 without relegating cables or hard-to-reach rear I/O.

## 1.1.2 Dual Intelligent Processors 3 with New DIGI+ Power Control

The world's first Dual Intelligent Processors from ASUS pioneered twin onboard chips - TPU (TurboV Processing Unit) and EPU (Energy Processing Unit). Third generation Dual Intelligent Processors with New DIGI+ Power Control provides a total CPU, memory and SMART DIGI+ Key profile tuning digital power solution, which includes two digital voltage controllers allowing ultra-precise DRAM tuning in addition to ultra-precise CPU voltage control - a first on the AMD platform. It's upgraded with one-click extreme performance optimization with the user-friendly AI Suite II utility. This evolution of innovative and industry-leading ASUS technology provides super-accurate voltage tuning for better efficiency, stability and performance.

### New DIGI+ Power Control

All-New Digital Power Control for both CPU and DRAM

The New DIGI+ Power Control design with two digital voltage controllers upgrades motherboard power delivery to an overall solution on AMD AM3+ motherboards, including all-new DRAM controllers that offers ultra-precise memory tuning in addition to ultra-precise CPU voltage control. This evolution of innovative, industry-leading ASUS technology provides the best in class control for better efficiency, stability and performance.

TPU with the All-New SMART DIGI+ Key for a Blazing Performance Boost

Always at the forefront of power design, ASUS propels you into the future standard of power management again by giving you a complete CPU, memory and new SMART DIGI+ Technology with profile tuning digital power solution, which works with the TPU to ramp up performance to its maximum. Enable the all-new SMART DIGI+ Key profile with a single click and adjust CPU ratios manually in the TPU to increase CPU frequency up to an incredible 100%!

Increased CPU and DRAM overclocking range

With programmable digital controllers onboard, users can adjust CPU and DRAM voltage and VRM switching frequencies for various overclocking scenarios. New DRAM tuning possibilities make the most of DDR3 memory for better performance with CPU/NB load line calibration and 30% more DRAM current capacity. Thanks to a slew of power options teamed with an extensive and intuitive UEFI BIOS, overclocking very large memory setups is no more difficult than mainstream motherboards.

### TPU

TPU (TurboV Processing Unit) offers precise voltage control and advanced monitoring mechanisms through the Auto Tuning and TurboV functions.

### EPU

EPU (Energy Processing Unit), the world's first real-time system power-saving chip, automatically detects the current system load and intelligently moderates power usage. It offers a total system-wide energy optimization, reduces fan noise, and extends the component's lifespan.



### 1.1.3 ASUS Exclusive Features

#### MemOK!

MemOK! quickly ensures memory boot compatibility. This remarkable memory rescue tool requires a mere push of a button to patch memory issues. MemOK! determines failsafe settings and dramatically improves your system boot success.

#### AI Suite II

With its user-friendly interface, ASUS AI Suite II consolidates all the exclusive ASUS features into one simple to use software package. It allows users to supervise overclocking, energy management, fan speed control, voltage and sensor readings. This all-in-one software offers diverse and ease to use functions, with no need to switch back and forth between different utilities.

#### USB 3.0 Boost

ASUS USB 3.0 Boost technology supports UASP (USB Attached SCSI Protocol), the latest USB 3.0 standard. With USB 3.0 Boost technology, a USB device's transmission speed is significantly increased up to 170%, adding to an already impressive fast USB 3.0 transfer speed. ASUS software automatically accelerates data speeds for compatible USB 3.0 peripherals without the need for any user interaction.

#### Network iControl

Network iControl is an intuitive one-step network control center that makes it easier for you to manage your bandwidth and allows you to set, monitor, and schedule the bandwidth priorities for your network programs. It allows you to automatically connect to a PPPoE network for a more convenient online experience.

### 1.1.4 ASUS Quiet Thermal Solution

#### ASUS Fanless Design—Heat-pipe solution

The ASUS heat-pipe features 0-dB thermal solution that offers you a noiseless PC environment. Its beautiful shape upgrades the visual enjoyment and the heat-pipe design lowers the temperature of the chipset and power phase area through high efficient heat-exchange. Combined with usability and aesthetics, the ASUS heat-pipe gives you an extremely silent and cooling experience with its elegant appearance.



---

DO NOT uninstall the heat-pipe by yourself. Doing so may bend the tubing and affect the heat dissipation performance.

---

#### ASUS Fan Xpert

ASUS Fan Xpert intelligently allows you to adjust both the CPU and chassis fan speeds according to different ambient temperatures caused by different climate conditions in different geographic regions and your PC's loading. The built-in variety of useful profiles offer flexible controls of fan speed to achieve a quiet and cool environment.

## 1.1.5 ASUS EZ DIY

### ASUS UEFI BIOS (EZ Mode)

ASUS UEFI BIOS, a UEFI compliant architecture, offers the first mouse-controlled intuitive graphical BIOS interface that goes beyond the traditional keyboard-only BIOS controls, providing you with more flexibility, convenience, and easy to navigate EFI BIOS than the traditional BIOS versions. It offers you with dual selectable modes and native support for hard drives larger than 2.2 TB.

ASUS UEFI BIOS includes the following new features:

- F12 BIOS snapshot hotkey
- F3 Shortcut for most accessed information
- ASUS DRAM SPD (Serial Presence Detect) information detecting faulty DIMMs, and helping with difficult POST situations.

### Direct Key

Designed for users requiring frequent BIOS access, you can easily enter the BIOS automatically when the PC is on standby power with a press of a button. It saves you time during boot-up from having to repeatedly press the DEL key. Convenience and ease at its best!

### USB BIOS Flashback

USB BIOS Flashback offers a hassle-free updating solution for your ultimate convenience. Install a USB storage device containing the BIOS file, press the BIOS Flashback button for about three seconds, and the UEFI BIOS is automatically updated even without entering the existing BIOS or operating system. It also allows you to regularly check for UEFI BIOS updates, and download the latest BIOS automatically.

### ASUS Q-Design

ASUS Q-Design enhances your DIY experience. All of Q-LED, Q-Slot, and Q-DIMM design speed up and simplify the DIY process!

### ASUS Q-Connector

ASUS Q-Connector allows you to easily connect or disconnect the chassis front panel cables to the motherboard. This unique module eliminates the trouble of connecting the system panel cables one at a time and avoiding wrong cable connections.

### ASUS EZ-Flash 2

ASUS EZ Flash 2 is a user-friendly utility that allows you to update the BIOS without using a bootable floppy disk or an OS-based utility.

## 1.1.6 Other special features

### External SATA

The external SATA port located at the back I/O provides smart setup and hot-plug functions. Easily backup photos, videos and other entertainment contents on external devices.

### DTS Connect

To get the most out of your audio entertainment across all formats and quality levels, DTS Connect combines two enabling technologies. DTS Neo:PC™ upmixes stereo sources (CDs, MP3s, WMAs, internet radio) into as many as 7.1 channels of incredible surround sound. Consumers can then connect their PC to a home theater system. DTS Interactive is capable of performing multi-channel encoding of DTS bitstreams on personal computers, and sending encoded bitstreams out of a digital audio connection (such as S/PDIF or HDMI) designed to deliver audio to an external decoder.

### DTS UltraPC II

DTS UltraPC II delivers exceptional 7.1 surround through the most popular PC audio setups - your existing stereo speakers or headphones. In addition to virtual surround, it upgrades original sound to new levels with Audio Restoration, recreating the dynamic range of audio files. Symmetry mode improves the balance of perceived loudness across different input sources and Enhance boosts audio quality through high and low frequency equalization. With these technologies, users experience better home theater audio with ease.

### ErP Ready

The motherboard is European Union's Energy-related Products (ErP) ready, and ErP requires products to meet certain energy efficiency requirement in regards to energy consumptions. This is in line with ASUS vision of creating environment-friendly and energy-efficient products through product design and innovation to reduce carbon footprint of the product and thus mitigate environmental impacts.

## 1.2 Motherboard overview

### 1.2.1 Before you proceed

Take note of the following precautions before you install motherboard components or change any motherboard settings.



- 
- Unplug the power cord from the wall socket before touching any component.
  - Before handling components, use a grounded wrist strap or touch a safely grounded object or a metal object, such as the power supply case, to avoid damaging them due to static electricity.
  - Hold components by the edges to avoid touching the ICs on them.
  - Whenever you uninstall any component, place it on a grounded antistatic pad or in the bag that came with the component.
  - Before you install or remove any component, ensure that the ATX power supply is switched off or the power cord is detached from the power supply. Failure to do so may cause severe damage to the motherboard, peripherals, or components.
-



## Layout contents

Connectors/Jumpers/Slots	Page
1. ATX power connectors (24-pin EATXPWR, 8-pin EATX12V)	1-35
2. AM3+/AM3 CPU Socket	1-9
3. CPU, CPU optional, and chassis fan connectors (4-pin CPU_FAN; CPU_OPT; CHA_FAN1/2/3)	1-33
4. DDR3 DIMM slots	1-10
5. MemOK! button	1-25
6. USB 3.0 connector (20-1 pin USB3_34)	1-30
7. AMD® Serial ATA 6.0 Gb/s connectors (7-pin SATA6G_1-5 [gray])	1-28
8. ASMedia® Serial ATA 6.0 Gb/s connectors (7-pin SATA6G_E12 [navy blue])	1-29
9. Clear RTC RAM (3-pin CLRTC)	1-26
10. Standby Power LED	1-27
11. Direct header (2-pin DRCT)	1-37
12. System panel connector (20-8 pin PANEL)	1-36
13. Direct Key button (DirectKey)	1-24
14. Serial port connector (10-1 pin COM1)	1-34
15. USB 2.0 connectors (10-1 pin USB910, USB1112, USB1314)	1-31
16. TPM header (20-1 pin TPM)	1-37
17. USB BIOS Flashback button	2-13
18. Front panel audio connector (10-1 pin AAFP)	1-34
19. Digital audio connector (4-1 pin SPDIF_OUT)	1-32

### 1.2.3 Central Processing Unit (CPU)

The motherboard comes with a surface mount AM3+/AM3 socket designed for the AMD® FX™-Series/Phenom™ II/Athlon™ II/Sempron™ 100 Series Processors.

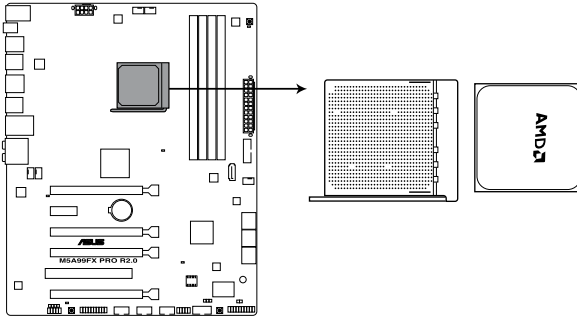

**M5A99FX PRO R2.0 CPU AM3+/AM3**



---

Ensure that all power cables are unplugged before installing the CPU.

---



---

The AM3+ socket has a different pinout from the 940-pin socket designed for the AMD Opteron processor. Ensure that you use a CPU designed for the AM3+ socket. The CPU fits in only one correct orientation. DO NOT force the CPU into the socket to prevent bending the connectors on the socket and damaging the CPU!

---

## 1.2.4 System memory

The motherboard comes with four Double Data Rate 3 (DDR3) Dual Inline Memory Modules (DIMM) slots.



A DDR3 module is notched differently from a DDR or DDR2 module. DO NOT install a DDR or DDR2 memory module to the DDR3 slot.

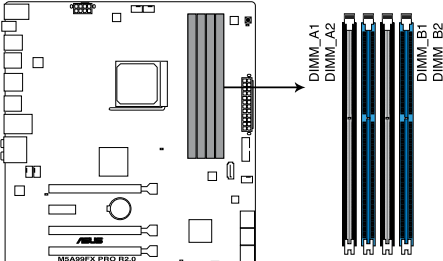

M5A99FX PRO R2.0 240-pin DDR3 DIMM socket

### Recommended memory configurations

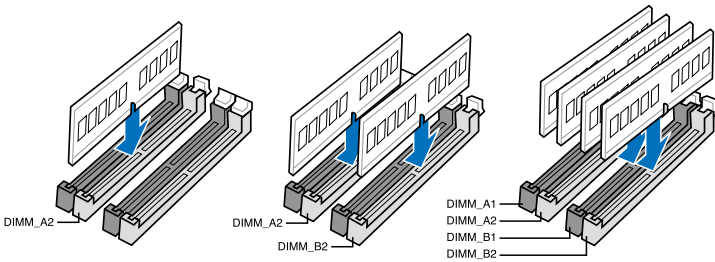



## Memory configurations

You may install 1GB, 2GB, 4GB, and 8GB unbuffered ECC and non-ECC DDR3 DIMMs into the DIMM sockets.



- 
- You may install varying memory sizes in Channel A and Channel B. The system maps the total size of the lower-sized channel for the dual-channel configuration. Any excess memory from the higher-sized channel is then mapped for single-channel operation.
  - Always install DIMMs with the same CAS latency. For optimal compatibility, we recommend that you install memory modules of the same version or date code (D/C) from the same vendor. Check with the retailer to get the correct memory modules.
  - Memory modules with memory frequency higher than 2133MHz and their corresponding timing or the loaded XMP profile is not the JEDEC memory standard. The stability and compatibility of the memory modules depend on the CPU's capabilities and other installed devices.
  - Due to the CPU spec., AMD AM3 100 series CPUs support up to DDR3 1066MHz. With ASUS design, this motherboard can support up to DDR3 1333MHz.
  - When overclocking, some AMD CPU models may not support DDR3 1600 or higher frequency DIMMs.
  - Due to the memory address limitation on 32-bit Windows OS, when you install 4GB or more memory on the motherboard, the actual usable memory for the OS can be about 3GB or less. For effective use of memory, we recommend that you do any of the following:
    - a) Use a maximum of 3GB system memory if you are using a 32-bit Windows OS.
    - b) Install a 64-bit Windows OS when you want to install 4GB or more on the motherboard.
    - c) For more details, refer to the Microsoft® support site at <http://support.microsoft.com/kb/929605/en-us>.
  - This motherboard does not support DIMMs made up of 512Mb (64MB) chips or less (Memory chip capacity counts in Megabit, 8 Megabit/Mb = 1 Megabyte/MB).



- 
- The default memory operation frequency is dependent on its Serial Presence Detect (SPD), which is the standard way of accessing information from a memory module. Under the default state, some memory modules for overclocking may operate at a lower frequency than the vendor-marked value. To operate at the vendor-marked or at a higher frequency, refer to section 3.4 Ai Tweaker menu for manual memory frequency adjustment.
  - For system stability, use a more efficient memory cooling system to support a full memory load (4 DIMMs) or overclocking condition.
-

## M5A99FX PRO R2.0 Motherboard Qualified Vendors Lists (QVL)

### DDR3 2400(O.C.) MHz capability

Vendors	Part No.	Size	SS/DS	Chip Brand	Chip No.	Timing	Voltage	DIMM socket support (Optional)		
								1	2	4
A-DATA	AX3U2400GC4G10(XMP)	4GB	DS	-	-	10-11-11-30	1.65	•	•	
G.SKILL	F3-19200CL11Q-16GBZHD(XMP)	16GB (4x 4GB)	DS	-	-	11-11-11-31	1.65		•	
G.SKILL	F3-19200CL11Q-16GBZHD(XMP)	16GB (4x 4GB)	DS	-	-	11-11-11-31	1.65	•	•	
G.SKILL	F3-19200CL9Q-16GBZMD(XMP)	16GB (4x 4GB)	DS	-	-	9-11-11-31	1.65		•	
G.SKILL	F3-19200CL10Q-32GBZHD(XMP)	32GB (4x 8GB)	DS	-	-	10-12-12-31	1.65	•	•	
G.SKILL	F3-19200CL9D-4GBPIS(XMP)	4G (2x 2G)	DS	-	-	9-11-9-28	1.65	•	•	
GEIL	GOC316GB2400C10QC(XMP)	16GB (4x 4GB)	DS	-	-	10-11-11-30	1.65	•	•	
GEIL	GOC316GB2400C11QC(XMP)	16GB (4x 4GB)	DS	-	-	11-11-11-30	1.65		•	
Kingston	KHX2400C11D3K4/8GX(XMP)	8GB (4x 2GB)	SS	-	-	11-13-11-30	1.65		•	
Transcend	TX2400KLU-4GK(381850)(XMP)	2GB	DS	-	-	-	1.65	•	•	
Transcend	TX2400KLU-4GK(374243)(XMP)	2GB	DS	-	-	-	1.65	•	•	

### DDR3 2200(O.C.) MHz capability

Vendors	Part No.	Size	SS/DS	Chip Brand	Chip No.	Timing	Voltage	DIMM socket support (Optional)		
								1	2	4
G.SKILL	F3-17600CL7D-4GBFLS(XMP)	4G (2x 2G)	DS	-	-	7-10-10-28	1.65	•	•	
GEIL	GET34GB2200C9DC(XMP)	4GB (2x 2GB)	DS	-	-	9-10-9-28	1.65	•	•	

### DDR3 2133(O.C.) MHz capability

Vendors	Part No.	Size	SS/DS	Chip Brand	Chip No.	Timing	Voltage	DIMM socket support (Optional)		
								1	2	4
Apacer	78.BAGE4.AFD0C(XMP)	8GB (2x 4GB)	DS	-	-	9-9-9-24	-		•	
CORSAIR	CMT4GX3M2A2133C9(XMP)	4GB (2x 2GB)	DS	-	-	9-10-9-24	1.65		•	
KINGSTON	KHX2133C11D3K4/16GX(XMP)	16GB (4x 4GB)	DS	-	-	11-12-11-30	1.65		•	
Patriot	PVV34G2133C9K(XMP)	4GB (2x 2GB)	DS	-	-	9-11-9-27	1.66		•	

## DDR3 2000(O.C.) MHz capability

Vendors	Part No.	Size	SS/ DS	Chip Brand	Chip No.	Timing	Voltage	DIMM socket support (Optional)		
								1	2	4
A-DATA	AX3U2000GB2G9B(XMP)	2GB	DS	-	-	9-11-9-27	1.55~1.75	•	•	
Apacer	78.AAGD5.9KD(XMP)	6GB (3x2GB)	DS	-	-	9-9-9-27	-	•	•	•
CORSAIR	CMZ4GX3M2A2000C10(Ver 5.12)(XMP)	4GB (2x2GB)	SS	-	-	10-10-10-27	1.5	•	•	
CORSAIR	CMT6GX3M3A2000C8(XMP)	6GB (3x2GB)	DS	-	-	8-9-8-24	1.65	•	•	•
G.SKILL	F3-16000CL9D-4GBRH(XMP)	4GB (2x2GB)	DS	-	-	9-9-9-24	1.65	•	•	
G.SKILL	F3-16000CL9D-4GBTD(XMP)	4GB (2x2GB)	DS	-	-	9-9-9-24	1.65			•
GEIL	GUP34GB2000C9DC(XMP)	4GB (2x2GB)	DS	-	-	9-9-9-28	1.65	•	•	
Transcend	TX2000KLN-8GK(388375)(XMP)	4GB	DS	-	-	-	1.6	•		
AEXEA	AXA3ES2G2000LG28V(XMP)	2GB	DS	-	-	-	1.65	•	•	•
AEXEA	AXA3ES4GK2000LG28V(XMP)	4GB (2x2GB)	DS	-	-	-	1.65	•	•	•
Asint	SLA302G08-ML2HB(XMP)	4GB	DS	Hynix	H5TQ2G83BF RH9C	9-9-9-27	-	•	•	
Patriot	PV736G2000ELK(XMP)	6GB (3x2GB)	DS	-	-	7-7-7-20	1.65	•	•	
Patriot	PVT36G2000LLK(XMP)	6GB (3x2GB)	DS	-	-	8-8-8-24	1.65	•	•	
Silicon Power	SP002GBLYU200S02(XMP)	2GB	DS	-	-	-	-	•		
Team	TXD32048M2000C9(XMP)	2GB	DS	Team	T3D1288RT-20	9-9-9-24	1.5	•		
Team	TXD32048M2000C9-L(XMP)	2GB	DS	Team	T3D1288LT-20	9-9-9-24	1.5			•
Team	TXD32048M2000C9-L(XMP)	2GB	DS	Team	T3D1288RT-20	9-9-9-24	1.6	•		

## DDR3 1866 MHz capability

Vendors	Part No.	Size	SS/ DS	Chip Brand	Chip No.	Timing	Voltage	DIMM socket support (Optional)		
								1	2	4
A-DATA	AX3U1866GC2G9B(XMP)	2GB	SS	-	-	9-11-9-27	1.55~1.75	•	•	
A-DATA	AX3U1866GC4G9B(XMP)	4GB	DS	-	-	9-11-9-27	1.55~1.75	•	•	•
CORSAIR	CMZ32GX3M4X1866 C10(Ver3.23)(XMP)	32GB (4x 8GB)	DS	-	-	10-11-10-27	1.5	•		
CORSAIR	CMZ8GX3M2A1866 C9(XMP)	8GB (2x 4GB)	DS	-	-	9-10-9-27	1.5	•	•	•
Crucial	BLE4G3D1869DE1XT 0.16FMD(XMP)	4GB	DS	-	-	9-9-9-27	1.5	•	•	
G.SKILL	F3-14900CL9Q-16GBXL(XMP)	16GB (4x 4GB)	DS	-	-	9-10-9-28	1.5	•	•	•
G.SKILL	F3-14900CL9Q-16GBZL(XMP)	16GB (4x 4GB)	DS	-	-	9-10-9-28	1.5	•	•	•
G.SKILL	F3-14900CL10Q2-64GBZLD(XMP)	64GB (8x 8GB)	DS	-	-	10-11-10-30	1.5	•	•	
G.SKILL	F3-14900CL9D-8GBSR(XMP)	8GB (2x 4GB)	DS	-	-	9-10-9-28	1.5	•	•	
G.SKILL	F3-14900CL9Q-8GBFLD(XMP)	8GB (2x 4GB)	DS	-	-	9-9-9-24	1.6	•	•	•
Patriot	PXD34G1866ELK(XMP)	4GB (2x 2GB)	SS	-	-	9-9-9-24	1.65	•		
Patriot	PXD38G1866ELK(XMP)	8GB (2x 4GB)	DS	-	-	9-11-9-27	1.65	•	•	•
Patriot	PXD38G1866ELK(XMP)	8GB (2x 4GB)	DS	-	-	9-9-9-24	1.65	•	•	•
Team	TXD34096M1866HC9K-L(XMP)	4GB	DS	Hynix	H5TC2G8 3BFRH9A	9-11-9-27	1.65	•		

## DDR3 1800 MHz capability

Vendors	Part No.	Size	SS/ DS	Chip Brand	Chip NO.	Timing	Voltage	DIMM socket support (Optional)		
								1	2	4
G.SKILL	F3-14400CL9D-4GBRL (XMP)	4GB(2x2GB)	DS	-	-	9-9-9-24	1.6	•	•	•

## DDR3 1600 MHz capability

Vendors	Part No.	Size	SS/DS	Chip Brand	Chip NO.	Timing	Voltage	DIMM socket support (Optional)		
								1	2	4
A-DATA	AM2U16BC2P1	2GB	SS	A-DATA	3CCD-1509A	-	-	*	*	*
A-DATA	AM2U16BC4P2	4GB	DS	A-DATA	3CCD-1509A	-	-	*	*	*
A-DATA	AX3U1600GC4G9(XMP)	4GB	DS	-	-	-	1.55-1.75	*	*	*
A-DATA	AX3U1600PC4G8(XMP)	4GB	DS	-	-	8-8-8-24	1.55-1.75	*	*	*
CORSAIR	CMZ8GX3M4X1600 C9(Ver 2.12)(XMP)	8GB (4x 2GB)	SS	-	-	9-9-9-24	1.5	*	*	*
CORSAIR	HX3X12G1600C9(XMP)	12GB (6x 2GB)	DS	-	-	9-9-9-24	1.6	*	*	*
CORSAIR	CML16GX3M4X1600 C8(Ver 2.12)(XMP)	16GB (4x 4GB)	DS	-	-	Heat-Sink Package	1.5	*	*	*
CORSAIR	CMZ16GX3M4A1600 C9(XMP)	16GB (4x 4GB)	DS	-	-	9-9-9-24	1.5	*	*	*
CORSAIR	CMZ32GX3M4X1600C10 (Ver2.2)(XMP)	32GB (4x 8GB)	DS	-	-	10-10-10-27	1.5	*	*	*
CORSAIR	CMG4GX3M2A1600C6	4GB (2x 2GB)	DS	-	-	6-6-6-18	1.65	*	*	*
CORSAIR	CMP6GX3M3A1600 C8(XMP)	6GB (3x 2GB)	DS	-	-	8-8-8-24	1.65	*	*	*
CORSAIR	CMP6GX3M3A1600 C8(XMP)	6GB (3x 2GB)	DS	-	-	8-8-8-24	1.65	*	*	*
CORSAIR	CMX6GX3M3C1600 C7(XMP)	6GB (3x 2GB)	DS	-	-	7-8-7-20	1.65	*	*	*
CORSAIR	CMZ8GX3M2A1600 C8(XMP)	8GB (2x 4GB)	DS	-	-	8-8-8-24	1.5	*	*	*
CORSAIR	CMZ8GX3M2A1600 C9(XMP)	8GB (2x 4GB)	DS	-	-	9-9-9-24	1.5	*	*	*
Crucial	BL12864BM1608.8FF(XMP)	2GB (2x 1GB)	SS	-	-	8-8-8-24	1.65	*	*	*
Crucial	BLT4G3D1608DT1TX0.16 FM(XMP)	4GB	DS	-	-	8-8-8-24	1.5	*	*	*
G.SKILL	F3-12800CL7Q-16GB XH(XMP)	16GB (4x 4GB)	DS	-	-	7-8-7-24	1.6	*	*	*
G.SKILL	F3-12800CL9Q-16GB XL(XMP)	16GB (4x 4GB)	DS	-	-	9-9-9-24	1.5	*	*	*
G.Skill	F3-12800CL9Q-16GB ZL(XMP)	16GB (4x 4GB)	DS	-	-	9-9-9-24	1.5	*	*	*
G.SKILL	F3-12800CL7D-8GB RH(XMP)	8GB (2x 4GB)	DS	-	-	7-8-7-24	1.6	*	*	*
G.SKILL	F3-12800CL9D-8GB RL(XMP)	8GB (2x 4GB)	DS	-	-	9-9-9-24	1.5	*	*	*
G.SKILL	F3-12800CL9D-8GB SR2(XMP)	8GB (2x 4GB)	DS	-	-	9-9-9-24	1.25	*	*	*
G.SKILL	F3-12800CL8D-8GB ECO(XMP)	8GB (2x4GB)	DS	-	-	8-8-8-24	1.35	*	*	*
GEIL	GET316GB1600C9 QC(XMP)	16GB (4x 4GB)	DS	-	-	9-9-9-28	1.6	*	*	*
GEIL	GUP34GB1600C7DC(XMP)	4GB (2x 2GB)	DS	-	-	7-7-7-24	1.6	*	*	*

(continued on the next page)

## DDR3 1600 MHz capability

Vendors	Part No.	Size	SS/ DS	Chip Brand	Chip No.	Timing	Voltage	DIMM socket support (Optional)		
								1	2	4
KINGMAX	FLGE85F- C8KL9A(XMP)	2GB	SS	KINGMAX	N/A	9-9-9-28	-	*	*	*
KINGSTON	KHX1600C9D3K3/ 12GX(XMP)	12GB (3x 4GB)	DS	-	-	9	1.65	*	*	*
KINGSTON	KHX1600C9D3T1BK3/ 12GX(XMP)	12GB (3x 4GB)	DS	-	-	9	1.65	*	*	*
KINGSTON	KHX1600C9D3K3/ 12GX(XMP)	12GB (3x 4GB)	DS	-	-	-	1.65	*	*	*
KINGSTON	KHX1600C9D3K6/ 24GX(XMP)	24GB (6x 4GB)	DS	-	-	9	1.65	*	*	*
Kingston	KHX1600C9D3K8/ 32GX(XMP)	32GB (8x 4GB)	DS	-	-	9-9-9-27	1.65	*	*	*
KINGSTON	KHX1600C9D3LK2/ 4GX(XMP)	4GB (2x 2GB)	DS	-	-	-	1.35	*	*	*
KINGSTON	KHX1600C9D3X2K2/ 4GX(XMP)	4GB (2x 2GB)	DS	-	-	9	1.65	*	*	*
KINGSTON	KHX1600C9D3K3/ 6GX(XMP)	6GB (3x 2GB)	DS	-	-	9	1.65	*	*	*
KINGSTON	KHX1600C9D3K3/ 6GX(XMP)	6GB (3x 2GB)	DS	-	-	9	1.65	*	*	*
KINGSTON	KHX1600C9D3T1K3/ 6GX(XMP)	6GB (3x 2GB)	DS	-	-	9	1.65	*	*	*
OCZ	OCZ3BE1600C8LV4GK	4GB (2x 2GB)	DS	-	-	8-8-8	1.65	*	*	*
Transcend	TS256MLK64V6N	2GB	SS	Transcend	K4B2G 0846C	-	-	*	*	*
Transcend	TS512MLK64V6N	4GB	DS	Transcend	K4B2G 0846C	-	-	*	*	*
Transcend	JM1600KLN-8GK	8GB (2x 4GB)	DS	Transcend	TK483P CW3	-	-	*	*	*
AEXEA	AXA3PS2G1600S18V (XMP)	2GB	DS	-	-	-	1.65	*	*	*
AEXEA	AXA3PS4GK1600S18V (XMP)	4GB (2x 2GB)	DS	-	-	-	1.65	*	*	*
Asint	SLZ3128M8-EGJ1D (XMP)	2GB	DS	Asint	3128M8- GJ1D	-	-	*	*	*
Asint	SLA302G08-EGG1C (XMP)	4GB	DS	Asint	302G08- GG1C	9-9-9-27	-	*	*	*
Asint	SLA302G08-EGJ1C (XMP)	4GB	DS	Asint	302G08- GJ1C	9-9-9-27	-	*	*	*
ATP	AQ12M64B8BK0S	4GB	DS	SAMSUNG	K4B2G0 8460	-	NO	*	*	*
EK Memory	EKM324L28BP8-116 (XMP)	4GB (2x 2GB)	DS	-	-	9	-	*	*	*
EK Memory	EKM324L28BP8-116 (XMP)	4GB (2x 2GB)	DS	-	-	9	-	*	*	*
Elixir	M2X2F64CB88G 7N-DG (XMP)	2GB	SS	Elixir	N2CB2G 80GN-DG	9-9-9-28	-	*	*	*
Elixir	M2X4G64CB88G 5N- DG (XMP)	4GB	DS	Elixir	N2CB2G 80GN-DG	9-9-9-28	-	*	*	*
KINGTIGER	KTG2G1600PG3 (XMP)	2GB	DS	-	-	-	-	*	*	*

(continued on the next page)

## DDR3 1600 MHz capability

Vendors	Part No.	Size	SS/ DS	Chip Brand	Chip No.	Timing	Voltage	DIMM socket support (Optional)		
								1	2	4
GoodRam	GR1600D364L9/2G	2GB	DS	GoodRam	GF1008 K C-JN	-	-	*	*	*
Mushkin	996805(XMP)	4GB (2x 2GB)	DS	-	-	6-8-6-24	1.65	*	*	*
Mushkin	998805(XMP)	6GB (3x 2GB)	DS	-	-	6-8-6-24	1.65	*	*	*
Patriot	AE32G1609U1-U	2GB	SS	AMD	23EY4587 MB6H	-	1.5	*	*	*
Patriot	PX7312G1600LLK(XMP)	12GB (3x 4GB)	DS	-	-	8-9-8-24	1.65	*	*	
Patriot	PGS34G1600LLKA2	4GB (2x 2GB)	DS	-	-	8-8-8-24	1.7	*	*	*
Patriot	PGS34G1600LLKA	4GB (2x 2GB)	DS	-	-	7-7-7-20	1.7	*	*	*
Patriot	PGD38G1600ELK(XMP)	8GB (2x 4GB)	DS	-	-	9-9-9-24	1.65	*	*	*
Patriot	PVV38G1600LLK(XMP)	8GB (2x 4GB)	DS	-	-	8-9-8-24	1.65	*	*	
SanMax	SMD-4G68HP-16KZ	4GB	DS	Hynix	H5TQ2G8 3BFRPBC	-	1.5	*	*	*
SanMax	SMD-4G68NG-16KK	4GB	DS	ELPIDA	J2108BDBG- GN-F	-	-	*	*	*
Silicon Power	SP002GBLTU160V02(XMP)	2GB	SS	S-POWER	20YT5NG	9-11- 11-28	1.5	*	*	*
Silicon Power	SP004GBLTU160V02(XMP)	4GB	DS	S-POWER	20YT5NG	9-9-9-24	1.5	*	*	
Team	TXD31024M1600C8- D(XMP)	1GB	SS	Team	T3D1288R T-16	8-8-8-24	1.65	*	*	*
Team	TXD32048M1600C7- L(XMP)	2GB	DS	Team	T3D1288L T-16	7-7-7-24	1.65	*		
Team	TXD32048M1600HC8- D(XMP)	2GB	DS	Team	T3D1288R T-16	8-8-8-24	1.65	*	*	*
Team	TED34096M1600HC11	4GB	DS	Team	T3D2568E T-16	-	-	*	*	*
Team	TXD34096M1600HC9- D(XMP)	4GB	DS	Hynix	H5TC2G83 BFRH9A	9-9-9-24	1.5	*	*	*

## DDR3 1333 MHz capability

Vendors	Part No.	Size	SS/ DS	Chip Brand	Chip No.	Timing	Voltage	DIMM socket support (Optional)		
								1	2	4
A-DATA	AD6311B0823EV	2GB	SS	A-DATA	3CCA-1509A	-	-	*	*	*
A-DATA	AXDU1333GC2G9 (XMP)	2GB	SS	-	-	9-9-9-24	1.25-1.35	*	*	*
A-DATA	AD6311C1624EV	4GB	DS	A-DATA	3CCA-1509A	-	-	*	*	*
A-DATA	SU3U1333W8G9 (XMP)	8GB	DS	ELPIDA	J4208BASE-D J-F	-	-	*	*	*
Apacer	78.A1GC6.9L1	2GB	DS	Apacer	AM5D5808FEQ SBG	9	-	*	*	*
Apacer	78.B1GDE.9L10C	4GB	DS	Apacer	AM5D5908CEH SBG	9	-	*	*	*
CORSAIR	TW3X4G1333C9A	4GB (2x 2GB)	DS	-	-	9-9-9-24	1.5	*	*	
CORSAIR	CMX8GX3M2A1333 C9(XMP)	8GB (2x 4GB)	DS	-	-	9-9-9-24	1.5	*	*	*
G.SKILL	F3-10800CL9D-4 GBNT	4GB (2x 2GB)	DS	G.SKILL	D3 128M8CE9 2GB	9-9-9-24	1.5	*	*	*
G.SKILL	F3-10666CL9D-8 GBRL	8GB (2x 4GB)	DS	-	-	9-9-9-24	1.5	*	*	*
G.SKILL	F3-10666CL9D-8 GBRL	8GB (2x 4GB)	DS	-	-	9-9-9-24	1.5	*	*	
G.SKILL	F3-10666CL9D-8 GBXL	8GB (2x 4GB)	DS	-	-	9-9-9-24	1.5	*	*	*
GEIL	GET316GB1333C 9QC	16GB (4x 4GB)	DS	-	-	9-9-9-24	1.5	*	*	
GEIL	GG34GB1333C9DC	4GB (2x 2GB)	DS	GEIL	GL1L128M88B A115FW	9-9-9-24	1.3	*	*	*
GEIL	GG34GB1333C9 DC	4GB (2x 2GB)	DS	GEIL	GL1L128M88B A15B	9-9-9-24	1.3	*	*	*
GEIL	GVP34GB1333C 9DC	4GB (2x 2GB)	DS	-	-	9-9-9-24	1.5	*	*	
GEIL	GB34GB1333C7 DC	4GB (2x 2GB)	DS	GEIL	GL1L128M88B A15FW	7-7-7-24	1.5	*	*	*
GEIL	GVP38GB1333C 9DC	8GB (2x 4GB)	DS	-	-	9-9-9-24	1.5	*	*	*
GEIL	GVP38GB1333C 7QC	8GB (2x 2GB)	DS	-	-	7-7-7-24	1.5	*	*	*
Hynix	HMT125U6TFR8 A-H9	2GB	DS	Hynix	H5TC1G83TFR	-	-	*	*	*
KINGMAX	FLFE85F-C8KL9	2GB	SS	KINGMAX	KFC8FNLB-F XX-12A	-	-	*	*	*
KINGMAX	FLFE85F-C8KL9	2GB	SS	KINGMAX	KFC8FNLXF-D XX-15A	-	-	*	*	*
KINGMAX	FLFE85F-C8KM9	2GB	SS	Kingmax	KFC8FNMXF-B XX-15A	-	-	*	*	*
KINGMAX	FLFF65F-C8KM9	4GB	DS	Kingmax	KFC8FNMXF-B XX-15A	-	-	*	*	*

(continued on the next page)



## DDR3 1333 MHz capability

Vendors	Part No.	Size	SS/ DS	Chip Brand	Chip No.	Timing	Voltage	DIMM socket support (Optional)		
								1	2	4
KINGMAX	FLFE85F-B8KL9	2GB	DS	KINGMAX	KFB8FNLXL-BN F-15A	-	-	*	*	*
KINGMAX	FLFF65F-C8KL9	4GB	DS	KINGMAX	KFC8FNLBF-G XX-12A	-	-	*	*	*
KINGMAX	FLFF65F-C8KL9	4GB	DS	KINGMAX	KFC8FNLXF-D XX-15A	-	-	*	*	*
KINGSTON	KVR1333D3S8N9/2G	2GB	SS	Micron	IFD77 D9LGK	-	1.5	*	*	*
KINGSTON	KVR1333D3N9/2G	2GB	DS	Kingston	D1288JPNDDL D9U	9	1.5	*	*	*
KINGSTON	KVR1333D3N9K2/4G	4GB (2x 2GB)	DS	KINGSTON	D1288JEMFP GD9U	-	1.5	*	*	*
KINGSTON	KVR1333D3E9S/4G	4GB	DS	Elpida	J2108ECSE-D J-F	9	1.5	*	*	*
KINGSTON	KVR1333D3N9H/8G	8GB	DS	ELPIDA	J4208EASE-DJ-F	9-9-9-24	1.5	*	*	*
MICRON	MT8JTF25664Z-1G4M1	2GB	SS	MICRON	D9PFJ	-	-	*	*	*
OCZ	OCZ3G1333LV4GK	4GB (2x 2GB)	DS	-	-	9-9-9	1.65	*	*	*
OCZ	OCZ3G1333LV8GK	8GB (2x 4GB)	DS	-	-	9-9-9	1.65	*	*	*
OCZ	OCZ3G1333LV8GK	8GB (2x 4GB)	DS	-	-	9-9-9	1.65	*	*	*
OCZ	OCZ3RPR1333C9 LV8GK	8GB (2x 4GB)	DS	-	-	9-9-9	1.65	*	*	*
SAMSUNG	M378B5673FH0-CH9	2GB	DS	SAMSUNG	K4B1G0846F	-	-	*	*	*
SAMSUNG	M378B5273CH0-CH9	4GB	DS	SAMSUNG	K4B2G0846C	K4B2G0846C	-	*	*	*
SAMSUNG	M378B1G73AH0-CH9	8GB	DS	SAMSUNG	K4B4G0846A-HCH9	-	-	*	*	*
Transcend	JM1333KLN-2G (582670)	2GB	SS	Micron	ICD77 C9LGK	-	-	*	*	*
Transcend	JM1333KLN-2G	2GB	SS	Transcend	TK483PCW3	-	-	*	*	*
Transcend	TS256MLK64V3N (585541)	2GB	SS	Micron	ICD77 D9LGK	9	-	*	*	*
Transcend	TS256MLK64V3N (566577)	2GB	SS	Hynix	H5TQ2G83BFR	9	-	*	*	*
Transcend	TS256MLK64V3N (574206)	2GB	SS	Micron	D9LGK	9	-	*	*	*
Transcend	JM1333KLN-4G (583782)	4GB	DS	Transcend	TK483PCW3	9	-	*	*	*
Transcend	JM1333KLN-4G	4GB	DS	Transcend	TK483PCW3	-	-	*	*	*
Transcend	TS512MLK64V3N (585538)	4GB	DS	Micron	IED27 D9LGK	9	-	*	*	*
Transcend	TS512MLK64V3N (574831)	4GB	DS	Micron	D9LGK	9	-	*	*	*
Transcend	TS1GLK64V3H	8GB	DS	MICRON	D9PBC	-	-	*	*	*

(continued on the next page)

## DDR3 1333 MHz capability

Vendors	Part No.	Size	SS/ DS	Chip Brand	Chip No.	Timing	Voltage	DIMM socket support (Optional)		
								1	2	4
ACTICA	ACT1GHU64B8F1333S	1GB	SS	SAMSUNG	K4B1G0846F	-	-	*	*	*
ACTICA	ACT1GHU72C8G1333S	1GB	SS	SAMSUNG	K4B1G0846F(ECC)	-	-	*	*	*
ACTICA	ACT2GHU64B8G1333M	2GB	DS	Micron	D9KPT	-	-	*	*	*
ACTICA	ACT2GHU64B8G1333S	2GB	DS	SAMSUNG	K4B1G0846F	-	-	*	*	*
ACTICA	ACT2GHU72D8G1333M	2GB	DS	Micron	D9KPT(ECC)	-	-	*	*	*
ACTICA	ACT2GHU72D8G1333S	2GB	DS	SAMSUNG	K4B1G0846F(ECC)	-	-	*	*	*
ACTICA	ACT4GHU64B8H1333H	4GB	DS	Hynix	H5TQ2G83AFR	-	-	*	*	*
ACTICA	ACT4GHU72D8H1333H	4GB	DS	Hynix	H5TQ2G83AFR(ECC)	-	-	*	*	*
ATP	AQ56M72E8BJH9S	2GB	DS	SAMSUNG	K4B1G0846F(ECC)	-	-	*	*	*
ATP	AQ12M72E8BKH9S	4GB	DS	SAMSUNG	K4B2G0846C(ECC)	-	-	*	*	*
BUFFALO	D3U1333-1G	1GB	SS	Elpida	J1108BFBG-D J-F	-	-	*	*	*
BUFFALO	D3U1333-2G	2GB	DS	Elpida	J1108BFBG-D J-F	-	-	*	*	*
BUFFALO	D3U1333-4G	4GB	DS	NANYA	NT5CB256M8 B N-CG	-	-	*	*	*
EK Memory	EKM324L28BP8-I13	4GB (2x 2GB)	DS	-	-	9	-	*	*	*
Elixir	M2F2G64CB88B7 N-CG	2GB	SS	Elixir	N2CB2G808N-CG	-	-	*	*	*
Elixir	M2F2G64CB88D7 N-CG	2GB	SS	Elixir	M2CB2G8BDN-CG	-	-	*	*	*
Elixir	M2F4G64CB8H85 N-CG	4GB	DS	Elixir	N2CB2G808N-CG	-	-	*	*	*
GoodRam	GR1333D364L9/2G	2GB	DS	Qimonda	IDSH1G-03A1F1C-13H	-	-	*	*	*
INNODISK	M3UN-2GHJBC09	2GB	SS	Hynix	H5TQ2G83CFRH9C	9-9-9-24	-	*	*	*
INNODISK	M3UN-4GHJAC09	4GB	DS	Hynix	H5TQ2G83CFRH9C	9-9-9-24	-	*	*	*
KINGTIGER	F10DA2T1680	2GB	DS	KINGTIGER	KTG1333PS1208 NST-C9	-	-	*	*	*
KINGTIGER	KTG2G1333PG3	2GB	DS	-	-	-	-	*	*	*
Mach Xtreme	MXD3V13332GS	2GB	SS	Mach Xtreme	C2S46D30-D313	-	-	*	*	*
Mach Xtreme	MXD3U133316GQ	16GB (4x 4GB)	DS	-	-	-	-	*	*	*
Patriot	AE32G1339U1-U	2GB	SS	AMD	23EY4587MB3H	-	1.5	*	*	*
Patriot	PGD316G1333ELK(XMP)	16GB (2x 8GB)	DS	-	-	9-9-9-24	1.5	*	*	*
Patriot	PSD32G13332	2GB	DS	Patriot	PM128M8D3BU-15	9	-	*	*	*

(continued on the next page)

## DDR3 1333 MHz capability

Vendors	Part No.	Size	SS/ DS	Chip Brand	Chip No.	Timing	Voltage	DIMM socket support (Optional)		
								1	2	4
Patriot	PGS34G1333LLKA	4GB (2 x 2GB)	DS	-	-	7-7-7-20	1.7	•	•	•
Patriot	AE34G1339U2-U	4GB	DS	AMD	23EY4587MB3H	-	1.5	•	•	•
Patriot	PG38G1333EL(XMP)	8GB	DS	-	-	-	1.5	•	•	•
RiDATA	C304627CB1AG22Fe	2GB	DS	RiDATA	C304627CB1AG22 Fe	9	-	•	•	•
RiDATA	E304459CB1AG32Cf	4GB	DS	RiDATA	E304459CB1AG3 2Cf	9	-	•	•	•
Silicon Power	SP001GBLTE133S01	1GB	SS	NANYA	NT5CB128M8AN-CG	-	-	•	•	•
Silicon Power	SP001GBLTU133S02	1GB	SS	S-POWER	10YT3E5	9	-	•	•	•
Silicon Power	SP002GBLTU133V02	2GB	SS	S-POWER	20YT3NG	9-9-9-24	-	•	•	•
Silicon Power	SP002GBLTE133S01	2GB	DS	NANYA	NT5CB128M8AN-CG	-	-	•	•	•
Silicon Power	SP004GBLTU133V02	4GB	DS	S-POWER	20YT3NG	9-9-9-24	-	•		
Team	TXD31024M1333C7(XMP)	1GB	SS	Team	T3D1288LT-13	7-7-7-21	1.75	•	•	•
Team	TXD31048M1333C7-D(XMP)	1GB	SS	Team	T3D1288LT-13	7-7-7-21	1.75			•
Team	TXD32048M1333C7-D(XMP)	2GB	DS	Team	T3D1288LT-13	7-7-7-21	1.5-1.6	•	•	•
Team	TED34096M1333HC9	4GB	DS	Team	T3D2568LT-13	-	-			•



Side(s): SS - Single-sided DS - Double-sided DIMM support:

- (1) Supports one (1) module inserted into any slot as Single-channel memory configuration. We suggest that you install the module into A2 slot.
- (2) Supports two (2) modules inserted into either the blue slots or the black slots as one pair of Dual-channel memory configuration. We suggest that you install the modules into slots A2 and B2 for better compatibility.
- (4) Supports four (4) modules inserted into both the blue and black slots as two pairs of Dual-channel memory configuration.



- When overclocking, some AMD CPU models may not support DDR3 1600 or higher frequency DIMMS.
- Visit the ASUS website for the latest QVL.

## 1.2.5 Expansion slots



Unplug the power cord before adding or removing expansion cards. Failure to do so may cause you physical injury and damage motherboard components.

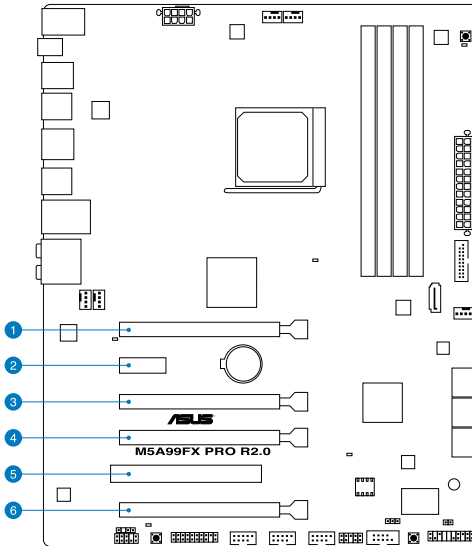

Slot No.	Slot Description
1	PCIe 2.0 x16_1 slot (dual at x16/x16 mode)
2	PCIe 2.0 x1_1 slot
3	PCIe 2.0 x16_2 slot [black] (at x4 mode, compatible with PCIe x1 and x4 devices)
4	PCIe 2.0 x16_3 slot (dual at x16/x16 mode)
5	PCI slot 1
6	PCIe 2.0 x16_4 slot [black] (at x4 mode, compatible with PCIe x1 and x4 devices)

VGA configuration	PCI Express operating mode			
	PCIe 2.0 x16_1	PCIe 2.0 x16_2	PCIe 2.0 x16_3	PCIe 2.0 x16_4
Single VGA/PCIe card	x16 (Recommend for single)	x4	x16	x4
Dual VGA/PCIe card	x16	x4	x16	x4



- In single VGA card mode, use the PCIe 2.0 x16\_1 slot (navy blue) for a PCI Express x16 graphics card to get better performance.
- In CrossFire™ or SLI™ mode, use the PCIe 2.0 x16\_1 and PCIe 2.0 x16\_3 slots for PCI Express x16 graphics cards to get better performance.
- We recommend that you provide sufficient power when running CrossFire™ or SLI™ mode. Refer to page 2-28 for details.
- Connect a chassis fan to the motherboard connector labeled CHA\_FAN1/2/3 when using multiple graphics cards for better thermal environment.

## IRQ assignments for this motherboard

	A	B	C	D	E	F	G	H
PCIe x16_1	shared	-	-	-	-	-	-	-
PCIe x16_2	shared	-	-	-	-	-	-	-
PCIe x16_3	shared	-	-	-	-	-	-	-
PCIe x16_4	-	-	-	-	shared	-	-	-
PCIe x1	-	-	-	-	-	-	-	shared
PCI	-	-	-	-	shared	-	-	-
ASM SATA	-	-	-	-	shared	-	-	-
USB 3.0_1	-	-	-	-	-	shared	-	-
USB 3.0_2	-	-	-	-	-	-	shared	-
Realtek 8111F (LAN)	-	-	-	-	-	-	-	shared
On Chip SATA	-	-	-	shared	-	-	-	-
On Chip USB_1	-	-	shared	-	-	-	-	-
On Chip USB_2	-	-	-	-	shared	-	-	-
On Chip USB_3	-	-	-	-	-	-	shared	-
HD Audio	shared	-	-	-	-	-	-	-

## 1.2.6 Onboard buttons and switches

Onboard switches and buttons allow you to fine-tune performance when working on a bare or open-case system. This is ideal for overclockers and gamers who continually change settings to enhance system performance.

### 1. Direct Key button (DirectKey)

This feature allows your system to go to the BIOS Setup program with the press of a button. With DirectKey, you can enter the BIOS anytime without having to press the <Del> key during POST. It also allows you to turn on or turn off your system and conveniently enter the BIOS during boot-up.

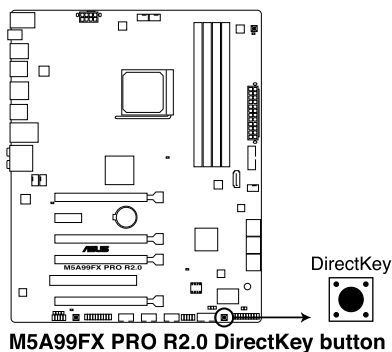

---

Ensure to save your data before using the DirectKey button.

---



- When the system is on and you press the DirectKey button, your system will shut down. Press the DirectKey button again or the Power-on button to reboot and enter the BIOS directly.
  - Turn off your system using the power-on button to allow your system to go through POST (without entering the BIOS) when you reboot your system.
  - Refer to section 3.7 **Boot Menu** for details about setting the DirectKey default function.
-

## 2. MemOK! button

Installing DIMMs that are not compatible with the motherboard may cause system boot failure, and the DRAM\_LED near the MemOK! switch lights continuously. Press and hold the MemOK! button until the DRAM\_LED starts blinking to begin automatic memory compatibility tuning for successful boot.

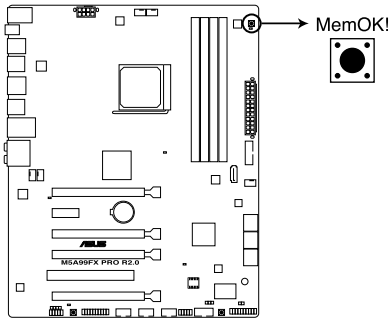

**M5A99FX PRO R2.0 MemOK! button**



- Refer to section 1.2.8 Onboard LEDs for the exact location of the DRAM\_LED.
- The DRAM\_LED also lights up when the DIMM is not properly installed. Turn off the system and reinstall the DIMM before using the MemOK! function.
- The MemOK! switch does not function under Windows™ OS environment.
- During the tuning process, the system loads and tests failsafe memory settings. It takes about 30 seconds for the system to test one set of failsafe settings. If the test fails, the system reboots and test the next set of failsafe settings. The blinking speed of the DRAM\_LED increases, indicating different test processes.
- Due to memory tuning requirement, the system automatically reboots when each timing set is tested. If the installed DIMMs still fail to boot after the whole tuning process, the DRAM\_LED lights continuously. Replace the DIMMs with ones recommended in the Memory QVL (Qualified Vendors Lists) in this user manual or on the ASUS website at [www.asus.com](http://www.asus.com).
- If you turn off the computer and replace DIMMs during the tuning process, the system continues memory tuning after turning on the computer. To stop memory tuning, turn off the computer and unplug the power cord for about 5–10 seconds.
- If your system fails to boot up due to BIOS overclocking, press the MemOK! switch to boot and load the BIOS default settings. A message will appear during POST reminding you that the BIOS has been restored to its default settings.
- We recommend that you download and update to the latest BIOS version from the ASUS website at [www.asus.com](http://www.asus.com) after using the MemOK! function.

## 1.2.7 Jumpers

### 1. Clear RTC RAM (3-pin CLRTC)

This jumper allows you to clear the Real Time Clock (RTC) RAM in CMOS. You can clear the CMOS memory of date, time, and system setup parameters by erasing the CMOS RTC RAM data. The onboard button cell battery powers the RAM data in CMOS, which include system setup information such as system passwords.

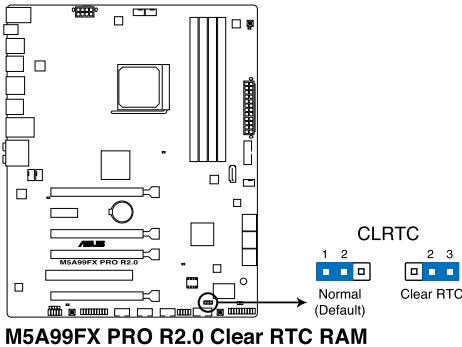

To erase the RTC RAM

1. Turn OFF the computer and unplug the power cord.
2. Move the jumper cap from pins 1-2 (default) to pins 2-3. Keep the cap on pins 2-3 for about 5–10 seconds, then move the cap back to pins 1-2.
3. Plug the power cord and turn ON the computer.
4. Hold down the <Del> key during the boot process and enter BIOS setup to re-enter data.



Except when clearing the RTC RAM, never remove the cap on CLRTC jumper default position. Removing the cap will cause system boot failure!



- If the steps above DO NOT help, remove the onboard battery and move the jumper again to clear the CMOS RTC RAM data. After the CMOS clearance, reinstall the battery.
- You DO NOT need to clear the RTC when the system hangs due to overclocking. For system failure due to overclocking, use the C.P.R. (CPU Parameter Recall) feature. Shut down and reboot the system so the BIOS can automatically reset parameter settings to default values.
- Due to the chipset behavior, AC power off is required to enable C.P.R. function. You must turn off and on the power supply or unplug and plug the power cord before rebooting the system.



## 1.2.8 Onboard LEDs

### 1. Standby Power LED

The motherboard comes with a standby power LED. The green LED lights up to indicate that the system is ON, in sleep mode, or in soft-off mode. This is a reminder that you should shut down the system and unplug the power cable before removing or plugging in any motherboard component. The illustration below shows the location of the onboard LED.

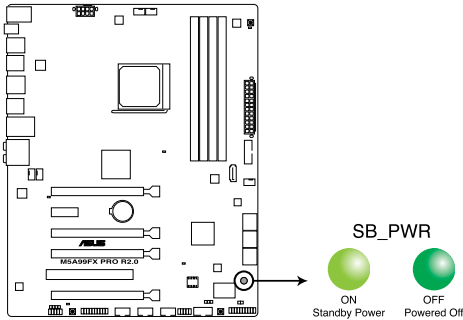

**M5A99FX PRO R2.0 Onboard LED**

### 2. POST State LEDs

The POST State LEDs provide the status of these key components during POST (Power-On-Self Test): CPU, memory modules, VGA card, and hard disk drive.s If an error is found, the critical component's LED stays lit up until the problem is solved.

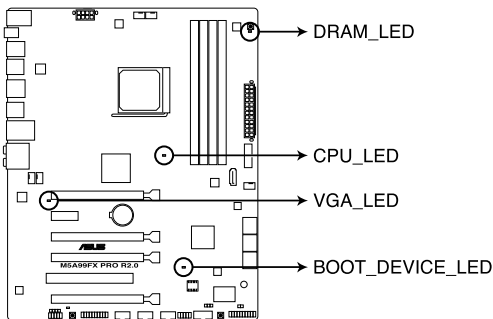

**M5A99FX PRO R2.0 CPU/ DRAM/ BOOT\_DEVICE/ VGA LED**

## 1.2.9 Internal connectors

### 1. AMD® Serial ATA 6.0 Gb/s connectors (7-pin SATA6G\_1-5 [gray])

These connectors are for the Serial ATA 6.0 Gb/s signal cables for Serial ATA hard disk drives and optical disc drives.

If you installed Serial ATA hard disk drives, you can create a RAID 0, RAID 1, RAID 5, or RAID 10 configuration through the onboard AMD® SB950 controller.

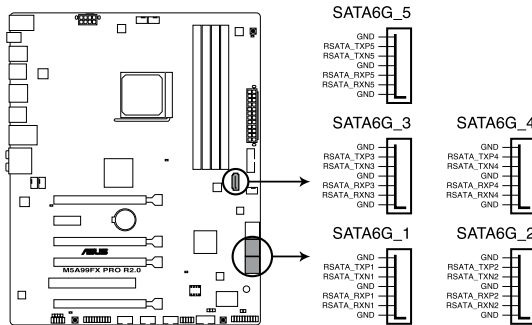

**M5A99FX PRO R2.0 SATA 6.0 Gb/s connectors**

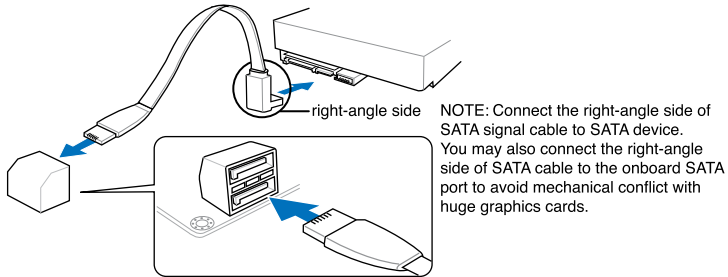

- These connectors are set to [AHCI Mode] by default. If you intend to create a Serial ATA RAID set using these connectors, set the SATA Mode item in the BIOS to [RAID Mode]. Refer to section **3.5.4 SATA Configuration** for details.
- Before creating a RAID set, refer to section **5.1 RAID configurations** or the manual bundled in the motherboard support DVD.
- When using NCQ, set the SATA Mode in the BIOS to [AHCI Mode]. Refer to section **3.5.4 SATA Configuration** for details.
- You must install Windows® XP Service Pack 3 or later versions before using Serial ATA hard disk drives. The Serial ATA RAID feature is available only if you are using Windows® XP SP3 or later versions.

## 2. ASMedia® Serial ATA 6.0 Gb/s connectors (7-pin SATA6G\_E12 [navy blue])

These connectors connect to Serial ATA 6.0 Gb/s hard disk drives via Serial ATA 6.0 Gb/s signal cables.

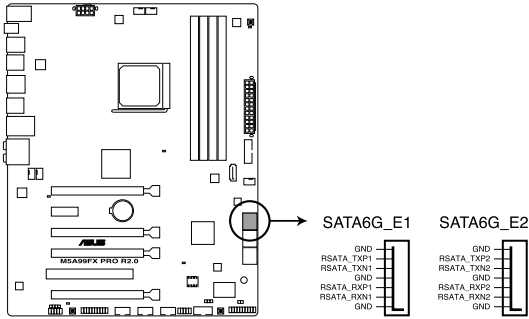

**M5A99FX PRO R2.0 ASMedia® SATA 6.0 Gb/s connectors**



- The SATA6G\_E1/E2 (navy blue) connectors are for data drives only. ATAPI device is not supported.
- You must install Windows® XP Service Pack 3 or later versions before using Serial ATA hard disk drives.
- When using NCQ, set the ASM1061 Storage Controller item in the BIOS to [Enabled]. Refer to section **3.5.6 Onboard Devices Configuration** for details.

### 3. USB 3.0 connector (20-1 pin USB3\_34)

This connector is for the additional USB 3.0 ports, and complies with the USB 3.0 specification that supports up to 5.0 Gbps connection speed. If the USB 3.0 front panel cable is available from your system chassis, with this USB 3.0 connector, you can have a front panel USB 3.0 solution.

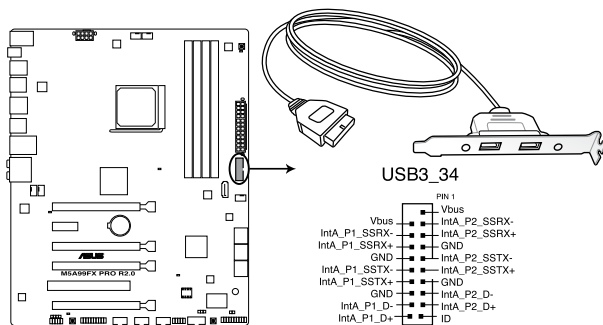

**M5A99FX PRO R2.0 USB3.0 connectors**



- You can connect the ASUS front panel USB 3.0 box to this connector to obtain the front panel USB 3.0 solution.
- The USB 3.0 module is purchased separately.

#### 4. USB 2.0 connectors (10-1 pin USB910; USB1112; USB1314)

These connectors are for USB 2.0 ports. Connect the USB module cable to any of these connectors, then install the module to a slot opening at the back of the system chassis. These USB connectors comply with USB 2.0 specification that supports up to 480 Mbps connection speed.

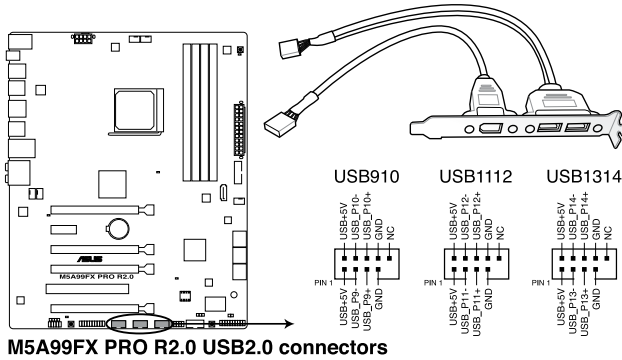

Never connect a 1394 cable to the USB connectors. Doing so will damage the motherboard!



You can connect the front panel USB cable to the ASUS Q-Connector (USB, blue) first, and then install the Q-Connector (USB) to the USB connector onboard if your chassis supports front panel USB ports.



The USB 2.0 module is purchased separately.

## 5. Digital audio connector (4-1 pin SPDIF\_OUT)

This connector is for an additional Sony/Philips Digital Interface (S/PDIF) port. Connect the S/PDIF Out module cable to this connector, then install the module to a slot opening at the back of the system chassis.

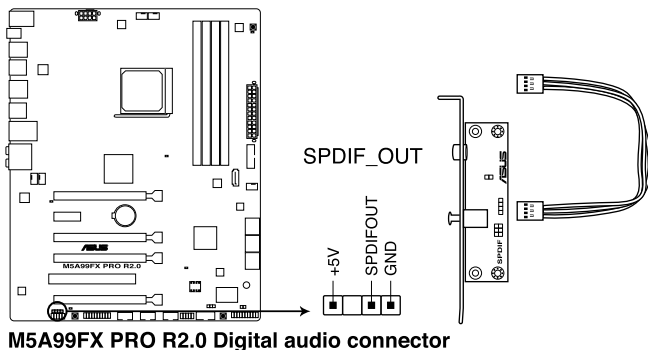

**M5A99FX PRO R2.0 Digital audio connector**



---

The S/PDIF module is purchased separately.

---

## 6. CPU, CPU optional, and chassis fan connectors

(4-pin CPU\_FAN; CPU\_OPT; CHA\_FAN1/2/3)

Connect the fan cables to the fan connectors on the motherboard, ensuring that the black wire of each cable matches the ground pin of the connector.

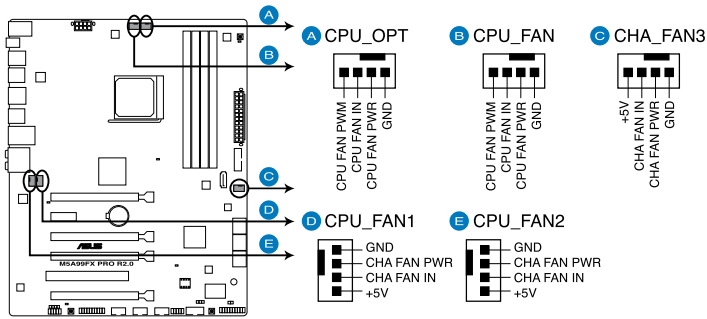

M5A99FX PRO R2.0 Fan connectors



DO NOT forget to connect the fan cables to the fan connectors. Insufficient air flow inside the system may damage the motherboard components. These are not jumpers! DO NOT place jumper caps on the fan connectors!



- The CPU\_FAN connector supports the CPU fan of maximum 1A (12 W) fan power.
- Only the CPU\_FAN, CHA\_FAN1, CHA\_FAN2 and CHA\_FAN3 connectors support the ASUS FAN Xpert feature.
- If you install two VGA cards, we recommend that you plug the rear chassis fan cable to the motherboard connector labeled CHA\_FAN1, CHA\_FAN2 or CHA\_FAN3 for better thermal environment.

## 7. Front panel audio connector (10-1 pin AAFP)

This connector is for a chassis-mounted front panel audio I/O module that supports either HD Audio or legacy AC '97 audio standard. Connect one end of the front panel audio I/O module cable to this connector.

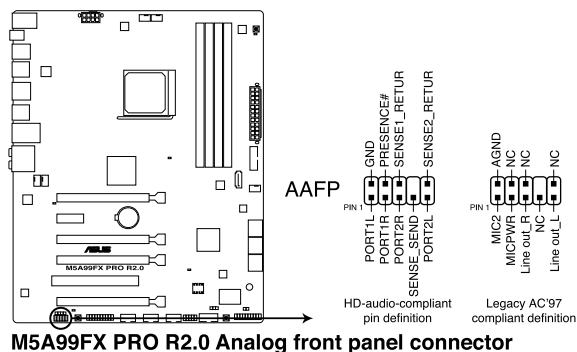

- We recommend that you connect a high-definition front panel audio module to this connector to avail of the motherboard's high-definition audio capability.
- If you want to connect a high-definition front panel audio module to this connector, set the **Azalia Front Panel** item in the BIOS setup to **[HD]**; if you want to connect an AC'97 front panel audio module to this connector, set the item to **[AC97]**. By default, this connector is set to **[HD]**.

## 8. Serial port connector (10-1 pin COM1)

This connector is for a serial (COM) port. Connect the serial port module cable to this connector, then install the module to a slot opening at the back of the system chassis.

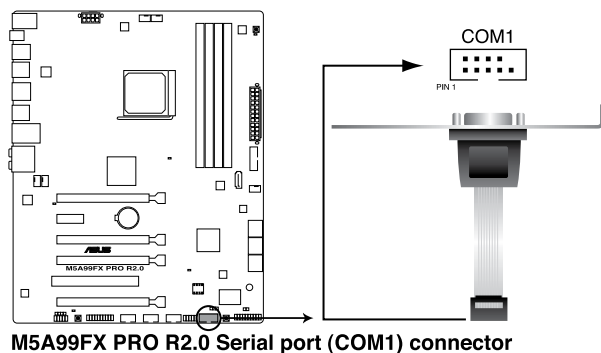

The COM module is purchased separately.



## 9. ATX power connectors (24-pin EATXPWR; 8-pin EATX12V)

These connectors are for ATX power supply plugs. The power supply plugs are designed to fit these connectors in only one orientation. Find the proper orientation and push down firmly until the connectors completely fit.

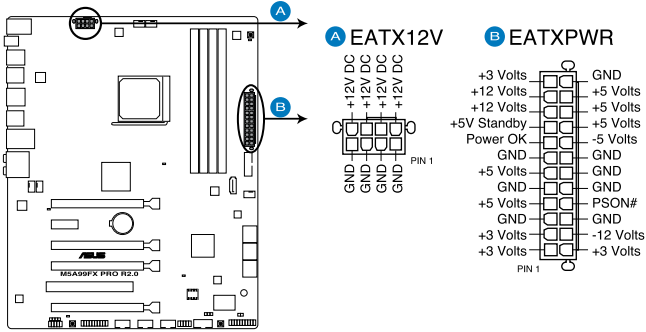

**M5A99FX PRO R2.0 ATX power connectors**



- For a fully configured system, we recommend that you use a power supply unit (PSU) that complies with ATX 12 V Specification 2.0 (or later version) and provides a minimum power of 450 W.
- DO NOT forget to connect the 8-pin EATX12 V power plug; otherwise, the system will not boot.
- We recommend that you use a PSU with higher power output when configuring a system with more power-consuming devices. The system may become unstable or may not boot up if the power is inadequate.
- If you are uncertain about the minimum power supply requirement for your system, refer to the **Recommended Power Supply Wattage Calculator** at <http://support.asus.com/PowerSupplyCalculator/PSCalculator.aspx?SLanguage=en-us> for details.
- If you want to use two high-end PCI Express x16 cards, use a PSU with 1000W power or above to ensure the system stability.

## 10. System panel connector (20-8 pin PANEL)

This connector supports several chassis-mounted functions.

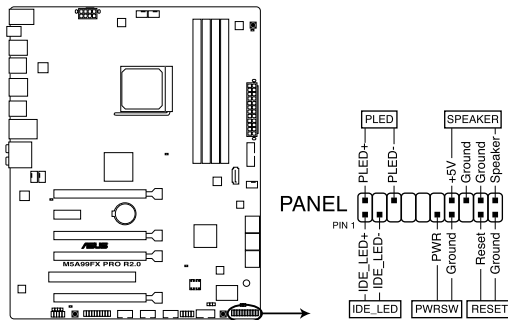

**M5A99FX PRO R2.0 System panel connector**

- **System power LED (2-pin PLED)**

This 2-pin connector is for the system power LED. Connect the chassis power LED cable to this connector. The system power LED lights up when you turn on the system power, and blinks when the system is in sleep mode.

- **Hard disk drive activity LED (2-pin IDE\_LED)**

This 2-pin connector is for the HDD Activity LED. Connect the HDD Activity LED cable to this connector. The IDE LED lights up or flashes when data is read from or written to the HDD.

- **System warning speaker (4-pin SPEAKER)**

This 4-pin connector is for the chassis-mounted system warning speaker. The speaker allows you to hear system beeps and warnings.

- **ATX power button/soft-off button (2-pin PWRSW)**

This connector is for the system power button. Pressing the power button turns the system on or puts the system in sleep or soft-off mode depending on the BIOS settings. Pressing the power switch for more than four seconds while the system is ON turns the system OFF.

- **Reset button (2-pin RESET)**

This 2-pin connector is for the chassis-mounted reset button for system reboot without turning off the system power.

## 11. TPM connector (20-pin TPM)

This connector supports a Trusted Platform Module (TPM) system, which securely store keys, digital certificates, passwords and data. A TPM system also helps enhance network security, protect digital identities, and ensures platform integrity.

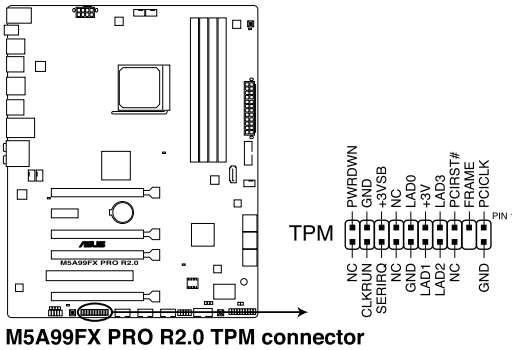

TPM module is purchased separately.

## 12. Direct connector (2-pin DRCT)

This connector is for the chassis-mounted button that supports the DirectKey function. Connect the button cable that supports DirectKey, from the chassis to this connector on the motherboard.

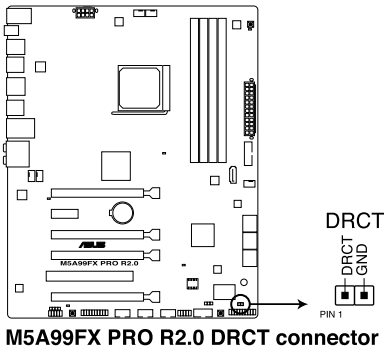

Ensure that your chassis comes with the button cable that supports the DirectKey feature. Refer to the technical documentation that came with the chassis for details.



# Basic Installation

# 2

## 2.1 Building your PC system

### 2.1.1 Motherboard installation



The diagrams in this section are for reference only. The motherboard layout may vary with models, but the installation steps are the same for all models.

1. Install the ASUS I/O Shield to the chassis rear I/O panel.

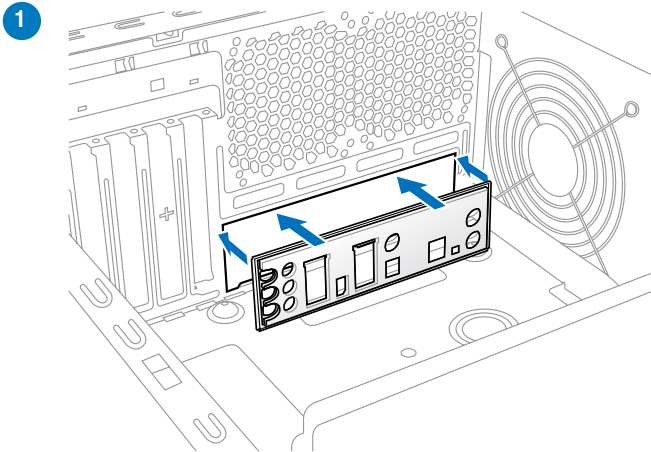

2. Place the motherboard into the chassis, ensuring that its rear I/O ports are aligned to the chassis' rear I/O panel.

2

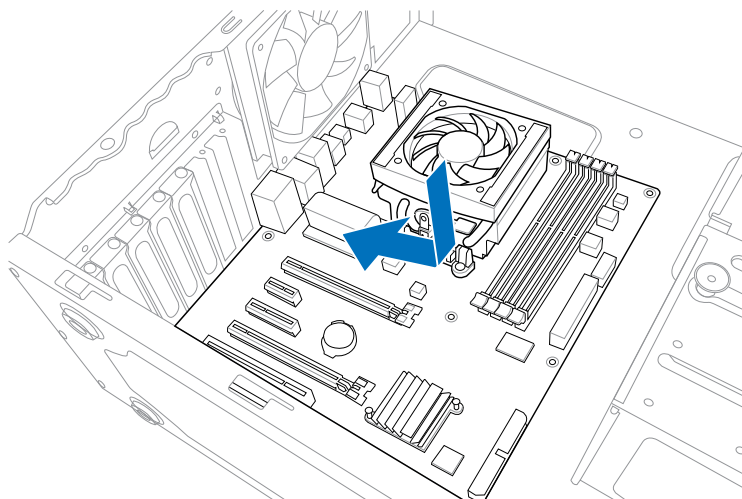

- Place nine screws into the holes indicated by circles to secure the motherboard to the chassis.

3

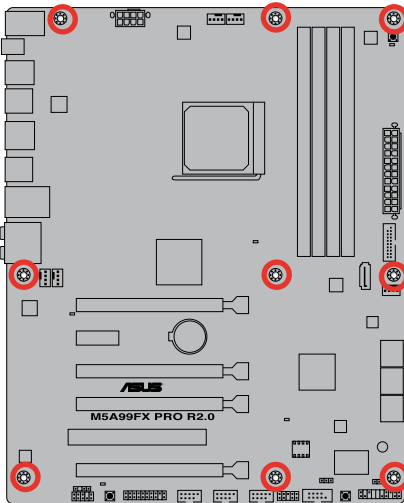
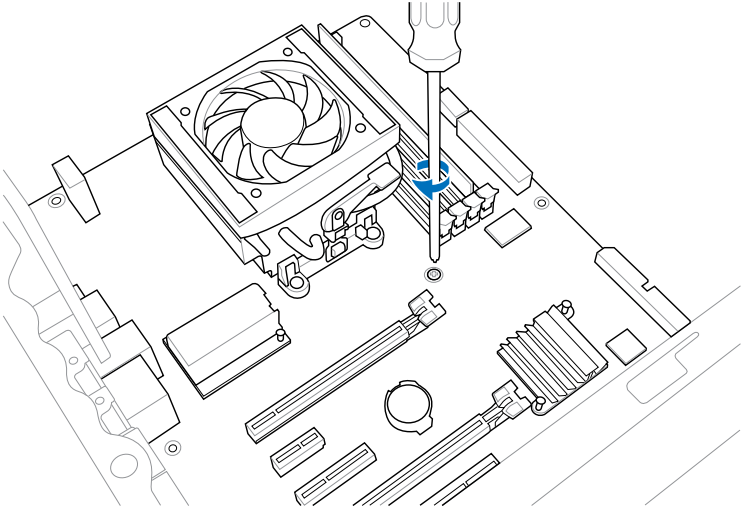

DO NOT overtighten the screws! Doing so can damage the motherboard.

## 2.1.2 CPU installation



The AMD AM3+ socket is compatible with AMD AM3+ and AM3 processors. Ensure you use a CPU designed for the AM3+ socket. The CPU fits in only one correct orientation. **DO NOT** force the CPU into the socket to prevent bending the connectors on the socket and damaging the CPU!

1

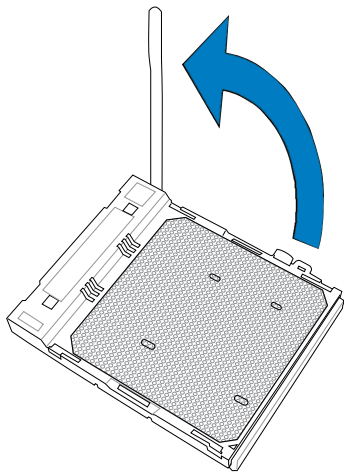

2

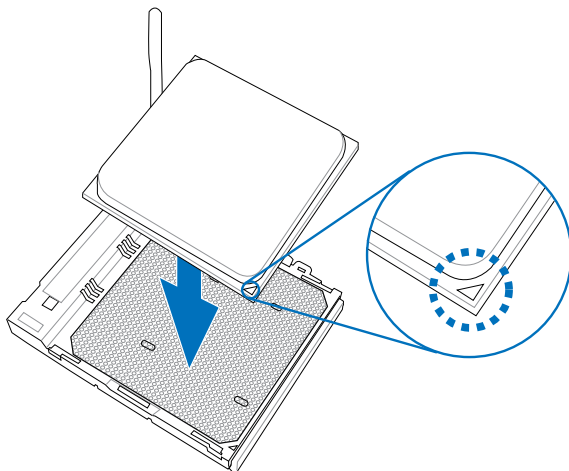



3

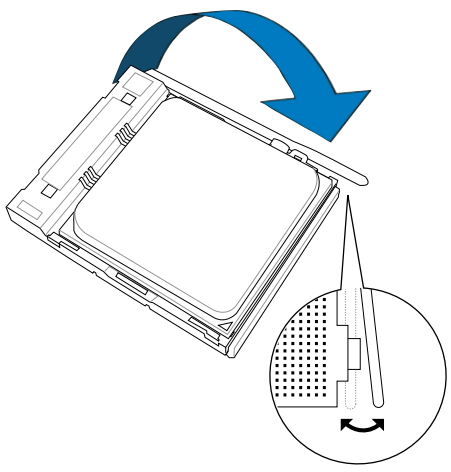

### 2.1.3 CPU heatsink and fan assembly installation

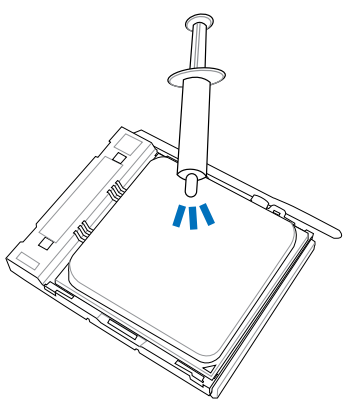

Apply the Thermal Interface Material to the CPU heatsink and CPU before you install the heatsink and fan if necessary.

## To install the CPU heatsink and fan assembly

1

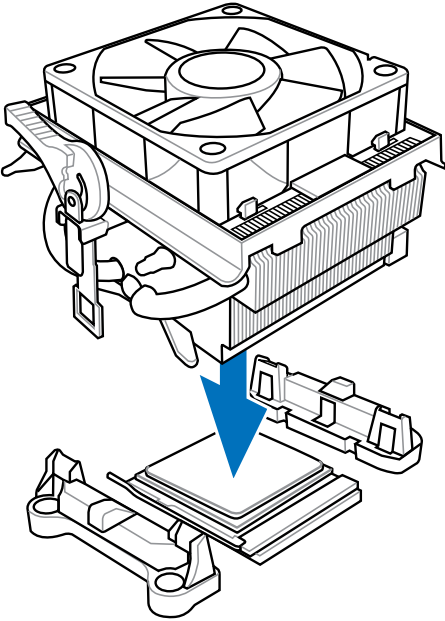

2

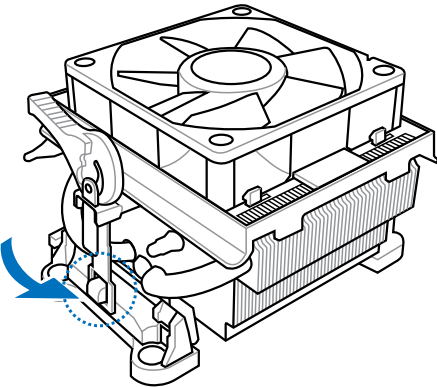

3

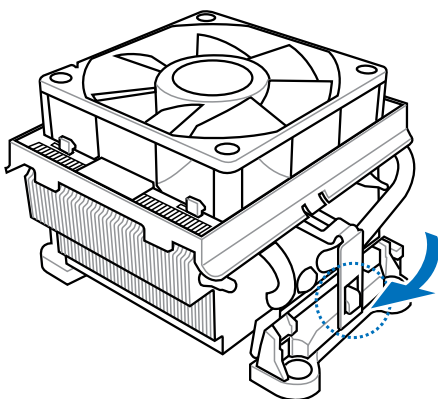

4

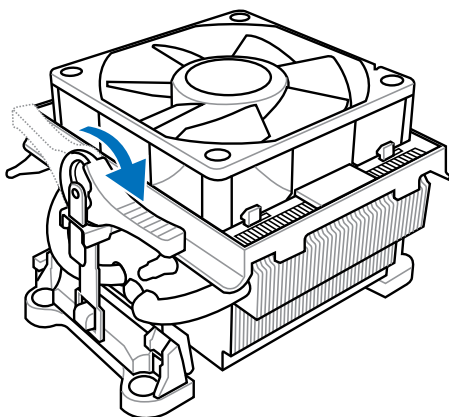

5

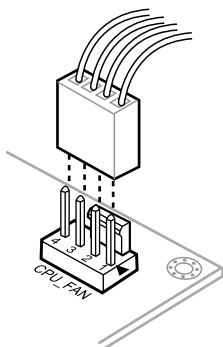

## 2.1.4 DIMM installation

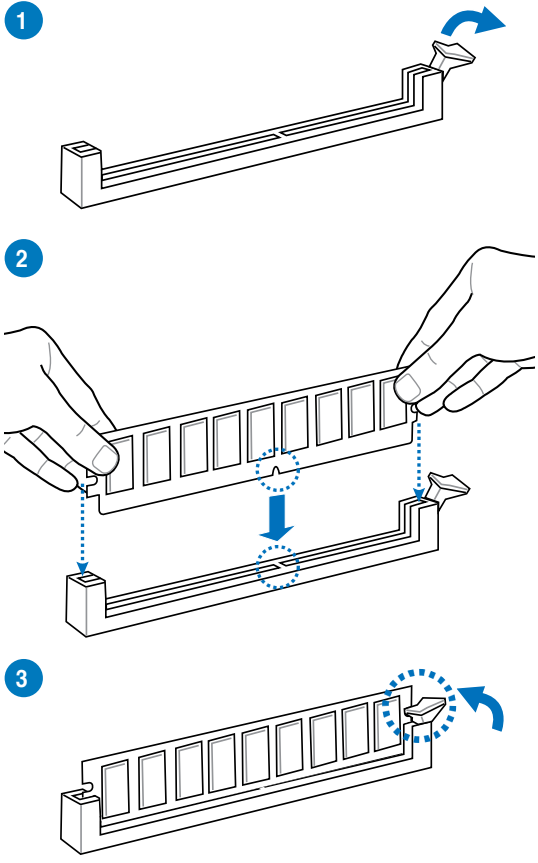

### To remove a DIMM

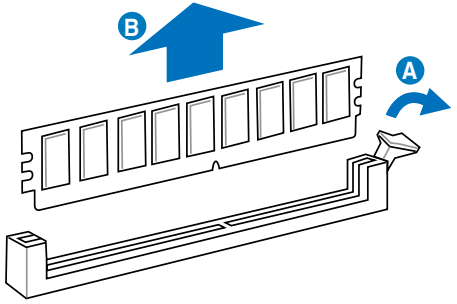

## 2.1.5 ATX Power connection

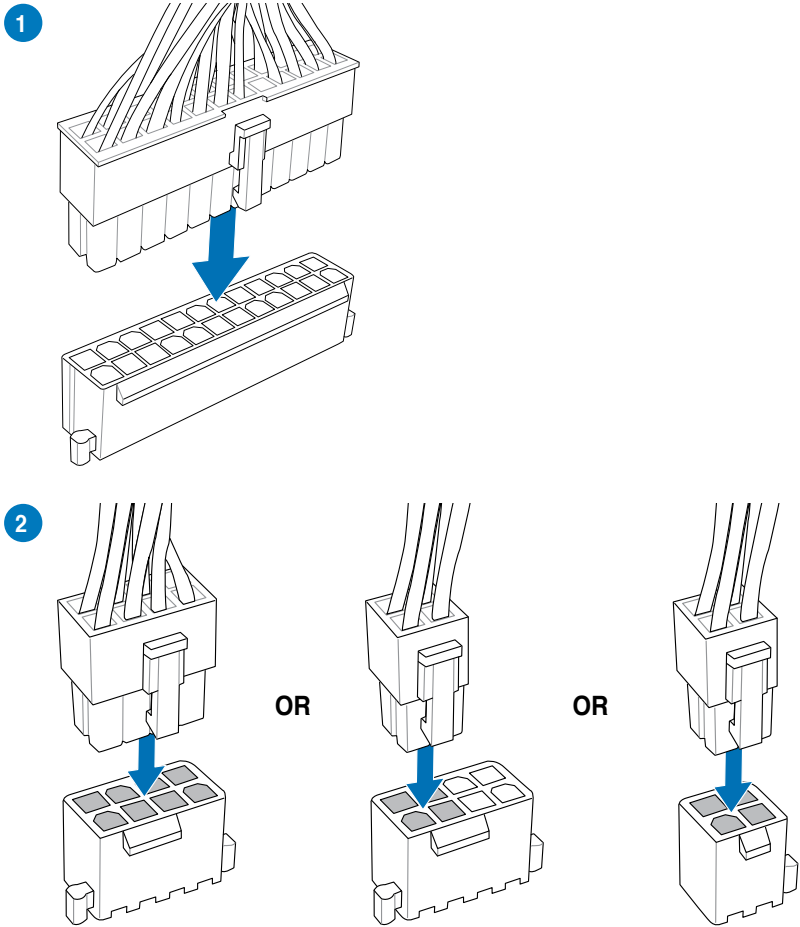

## 2.1.6 SATA device connection

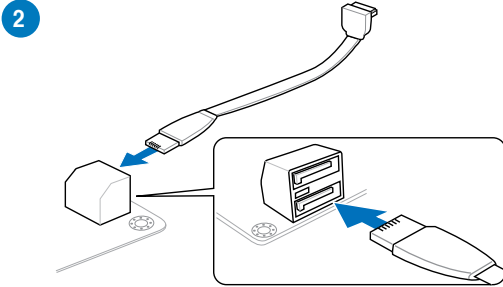
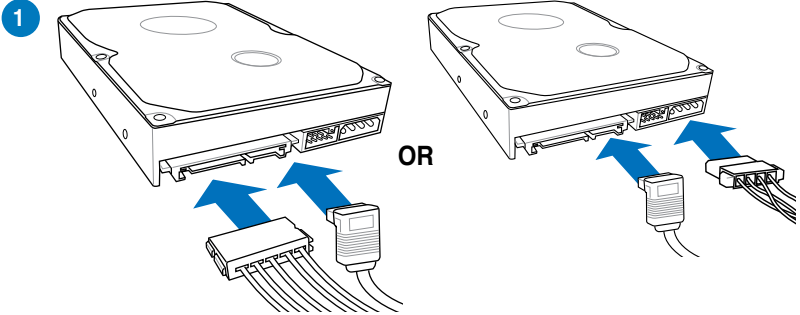

OR

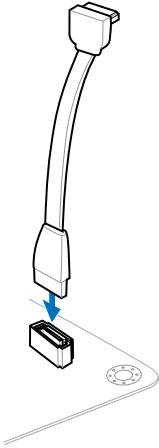

## 2.1.7 Front I/O Connector

### To install ASUS Q-Connector

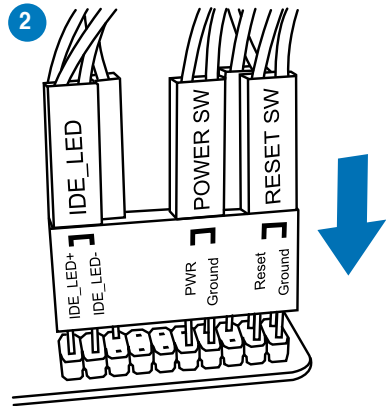
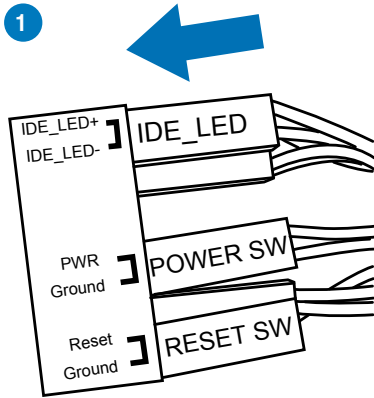

### To install USB 2.0 connector

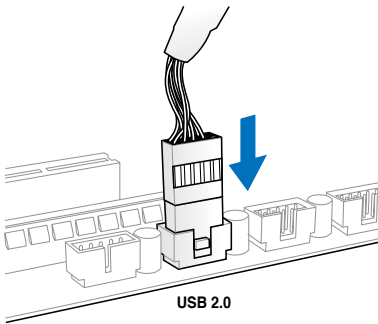

### To install front panel audio connector

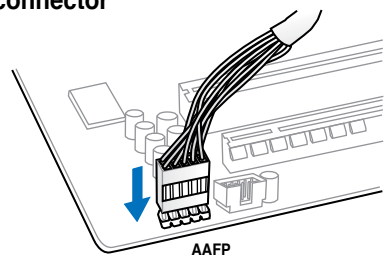

### To install USB 3.0 connector

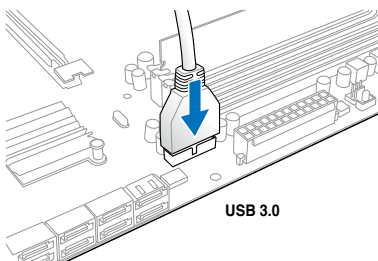

## 2.1.8 Expansion Card installation

To install PCIe x16 cards

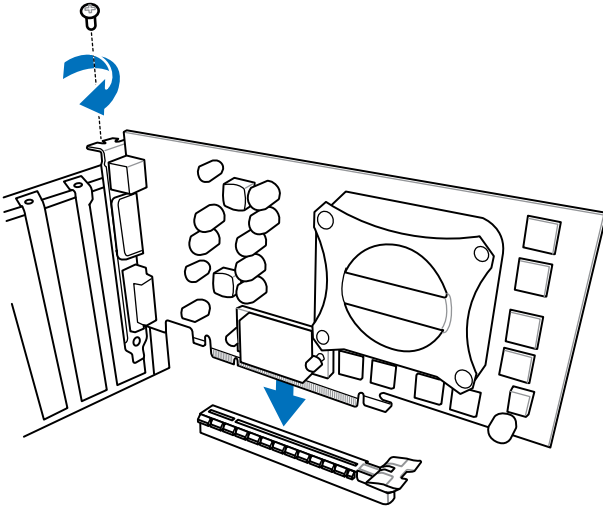

To install PCIe x1 cards

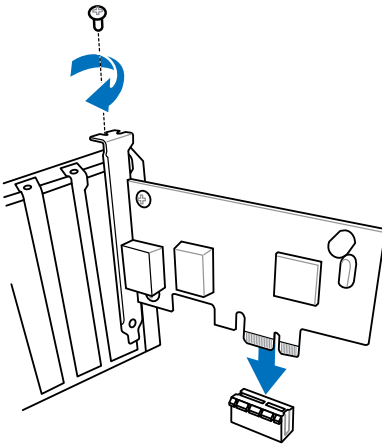

To install PCI cards

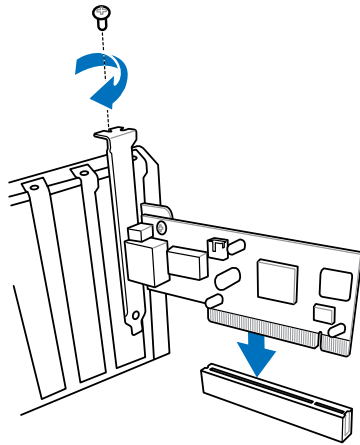



## 2.2 BIOS update utility

### 2.2.1 USB BIOS Flashback

USB BIOS Flashback allows you to easily update the BIOS without entering the existing BIOS or operating system. Simply insert a USB storage device to the USB port, press the USB BIOS Flashback button for three seconds, and the BIOS is updated automatically.

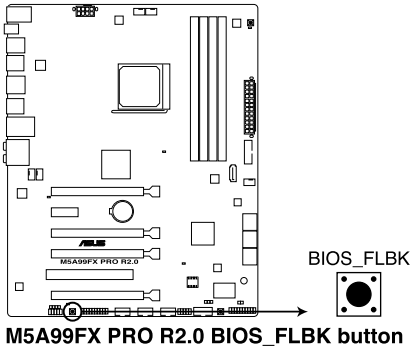

#### To use USB BIOS Flashback:

1. Place the bundled support DVD to the optical drive and install the USB BIOS Flashback Wizard. Follow the onscreen instructions to complete the installation.



You can also download the BIOS from the ASUS official website ([www.asus.com](http://www.asus.com)). Rename the file as M5A99FX.CAP, save it to a USB portable device, and place it in the root directory.

2. Insert the USB storage device to the USB Flashback port.
3. Launch the USB BIOS Flashback Wizard to automatically download the latest BIOS version.
4. Press the BIOS Flashback button for three seconds until a flashing light appears, which indicates that the BIOS Flashback function is enabled.
5. Wait until the light goes out, indicating that the BIOS updating process is completed.



This USB port can be switched to support USB BIOS Flashback (USB BIOS Flashback port).



---

For more BIOS update utilities in BIOS setup, refer to the section Updating BIOS in Chapter 3.

---



- Do not unplug portable disk, power system, or press the CLR\_CMOS button while BIOS update is ongoing, otherwise update will be interrupted. In case of interruption, please follow the steps again.
  - If the light flashes for five seconds and turns into a solid light, this means that the BIOS Flashback is not operating properly. This may be caused by improper installation of the USB storage device and filename/file format error. If this scenario happens, please restart the system to turn off the light.
  - Updating BIOS may have risks. If the BIOS program is damaged during the process and results to the system's failure to boot up, please contact your local ASUS Service Center.
-

## 2.3 Motherboard rear and audio connections

### 2.3.1 Rear I/O connection

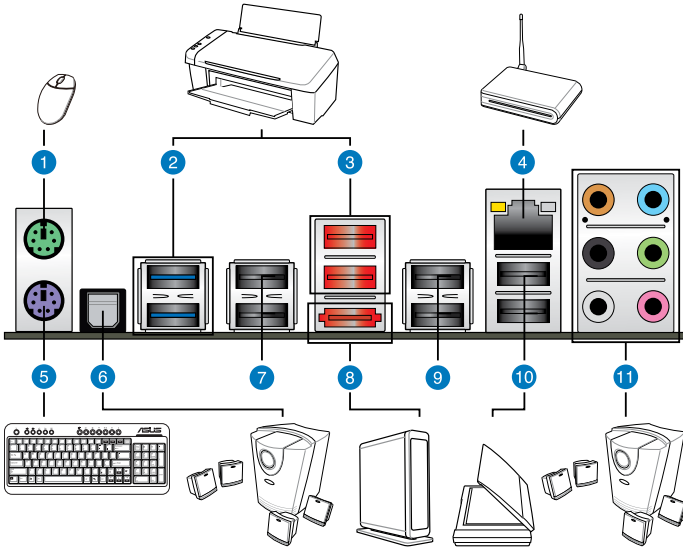

#### Rear panel connectors

1. PS/2 mouse port	7. USB 2.0 ports 1 and 2
2. USB 3.0 ports 1 and 2	8. External SATA port
3. USB 2.0 3 and 4	9. USB 2.0 ports 5 and 6
4. LAN (RJ-45) port	10. USB 2.0 ports 7 and 8
5. PS/2 keyboard port	11. Audio I/O ports*
6. Optical S/PDIF Out port	

\*: Refer to the tables on the next page for LAN port LEDs, and audio port definitions.



- Press the Clear CMOS switch to clear BIOS setup information only when the system hangs due to overlocking.
- DO NOT insert a different connector to the external SATA port.
- Due to USB 3.0 controller limitation, USB 3.0 devices can only be used under Windows® OS environment and after the USB 3.0 driver installation.
- USB 3.0 devices can only be used as data storage only.
- We strongly recommend that you connect USB 3.0 devices to USB 3.0 ports for faster and better performance for your USB 3.0 devices.

### \* LAN ports LED indications

Activity Link LED		Speed LED	
Status	Description	Status	Description
OFF	No link	OFF	10 Mbps connection
ORANGE	Linked	ORANGE	100 Mbps connection
BLINKING	Data activity	GREEN	1 Gbps connection

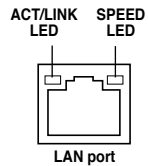

### \*\* Audio 2, 4, 6, or 8-channel configuration

Port	Headset 2-channel	4-channel	6-channel	8-channel
Light Blue	Line In	Line In	Line In	Line In
Lime	Line Out	Front Speaker Out	Front Speaker Out	Front Speaker Out
Pink	Mic In	Mic In	Mic In	Mic In
Orange	–	–	Center/Subwoofer	Center/Subwoofer
Black	–	Rear Speaker Out	Rear Speaker Out	Rear Speaker Out
Gray	–	–	–	Side Speaker Out

## 2.3.2 Audio I/O connections

### Audio I/O ports

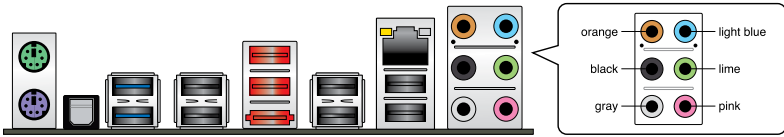

### Connect to Headphone and Mic

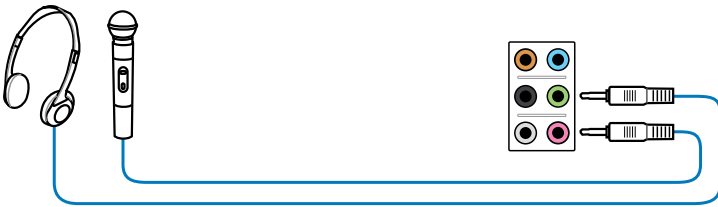

### Connect to Stereo Speakers

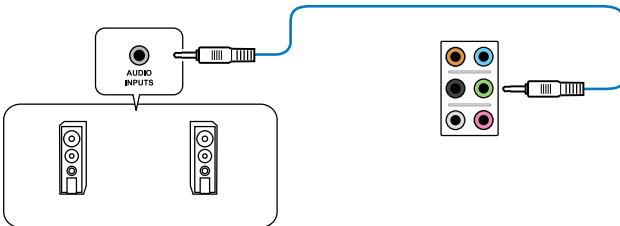

## Connect to 2.1 channel Speakers

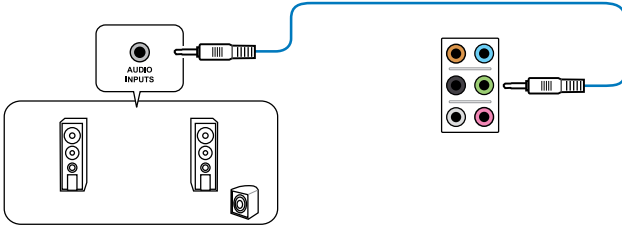

## Connect to 4.1 channel Speakers

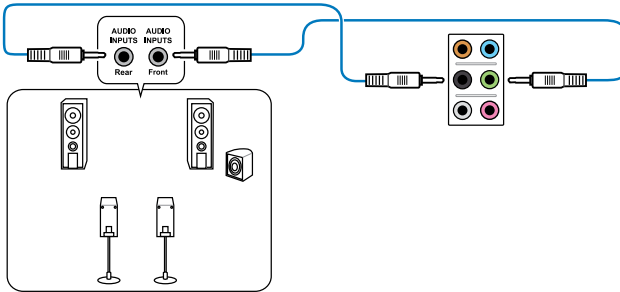

## Connect to 5.1 channel Speakers

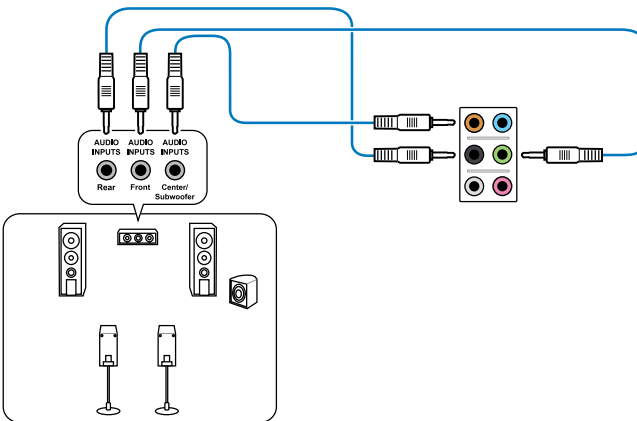

## Connect to 7.1 channel Speakers

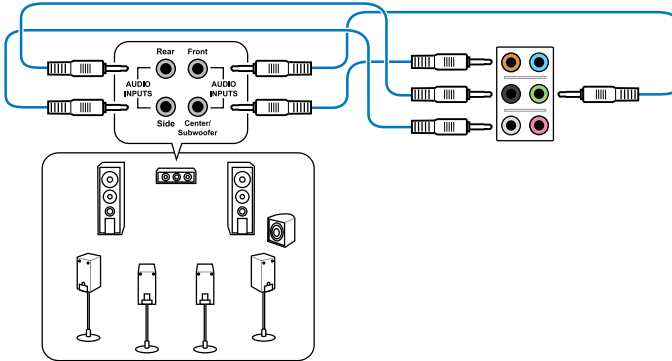

When the DTS UltraPC II and DTS Connect functions are enabled, ensure to connect the rear speaker to the gray port.

## 2.4 Starting up for the first time

1. After making all the connections, replace the system case cover.
2. Ensure that all switches are off.
3. Connect the power cord to the power connector at the back of the system chassis.
4. Connect the power cord to a power outlet that is equipped with a surge protector.
5. Turn on the devices in the following order:
  - a. Monitor
  - b. External SCSI devices (starting with the last device on the chain)
  - c. System power
6. After applying power, the system power LED on the system front panel case lights up. For systems with ATX power supplies, the system LED lights up when you press the ATX power button. If your monitor complies with the "green" standards or if it has a "power standby" feature, the monitor LED may light up or change from orange to green after the system LED turns on.

The system then runs the power-on self tests (POST). While the tests are running, the BIOS beeps (refer to the BIOS beep codes table) or additional messages appear on the screen. If you do not see anything within 30 seconds from the time you turned on the power, the system may have failed a power-on test. Check the jumper settings and connections or call your retailer for assistance.

BIOS Beep	Description
One short beep	VGA detected Quick boot set to disabled No keyboard detected
One continuous beep followed by two short beeps then a pause (repeated)	No memory detected
One continuous beep followed by three short beeps	No VGA detected
One continuous beep followed by four short beeps	Hardware component failure

7. At power on, hold down the <Delete> key to enter the BIOS Setup. Follow the instructions in Chapter 3.

## 2.5 Turning off the computer

While the system is ON, press the power button for less than four seconds to put the system on sleep mode or soft-off mode, depending on the BIOS setting. Press the power switch for more than four seconds to let the system enter the soft-off mode regardless of the BIOS setting.



# BIOS setup

# 3

## 3.1 Knowing BIOS



---

The new ASUS UEFI BIOS is a Unified Extensible Interface that complies with UEFI architecture, offering a user-friendly interface that goes beyond the traditional keyboard-only BIOS controls to enable a more flexible and convenient mouse input. You can easily navigate the new UEFI BIOS with the same smoothness as your operating system. The term "BIOS" in this user manual refers to "UEFI BIOS" unless otherwise specified.

---

BIOS (Basic Input and Output System) stores system hardware settings such as storage device configuration, overclocking settings, advanced power management, and boot device configuration that are needed for system startup in the motherboard CMOS. In normal circumstances, the default BIOS settings apply to most conditions to ensure optimal performance. **DO NOT change the default BIOS settings** except in the following circumstances:

- An error message appears on the screen during the system bootup and requests you to run the BIOS Setup.
- You have installed a new system component that requires further BIOS settings or update.



---

Inappropriate BIOS settings may result to instability or boot failure. **We strongly recommend that you change the BIOS settings only with the help of a trained service personnel.**

---



---

When downloading or updating the BIOS file, rename it as **M5A99FXPRO.CAP** for this motherboard.

---

## 3.2 BIOS setup program

Use the BIOS Setup to update the BIOS or configure its parameters. The BIOS screen include navigation keys and brief onscreen help to guide you in using the BIOS Setup program.

### Entering BIOS at startup

To enter BIOS Setup at startup:

- Press <Delete> during the Power-On Self Test (POST). If you DO NOT press <Delete>, POST continues with its routines.

### Entering BIOS Setup after POST

To enter BIOS Setup after POST:

- Press <Ctrl>+<Alt>+<Delete> simultaneously.
- Press the reset button on the system chassis.
- Press the power button to turn the system off then back on. Do this option only if you failed to enter BIOS Setup using the first two options.



- 
- The BIOS setup screens shown in this section are for reference purposes only, and may not exactly match what you see on your screen.
  - Ensure that a USB mouse is connected to your motherboard if you want to use the mouse to control the BIOS setup program.
  - If the system becomes unstable after changing any BIOS setting, load the default settings to ensure system compatibility and stability. Select the **Load Optimized Defaults** item under the **Exit** menu or press hotkey <F5>. See section 3.9 Exit Menu for details.
  - If the system fails to boot after changing any BIOS setting, try to clear the CMOS and reset the motherboard to the default value. See section 1.2.6 Onboard buttons and switches for information on how to erase the RTC RAM via the Clear CMOS button.
  - The BIOS setup program does not support the bluetooth devices.
- 

### BIOS menu screen

The BIOS Setup program can be used under two modes: **EZ Mode** and **Advanced Mode**. You can change modes from the **Exit** menu or from the **Exit/Advanced Mode** screen.

### 3.2.1 EZ Mode

By default, the EZ Mode screen appears when you enter the BIOS setup program. The EZ Mode provides you an overview of the basic system information, and allows you to select the display language, system performance mode and boot device priority. To access the Advanced Mode, click **Exit/Advanced Mode**, then select **Advanced Mode** or press <F7> hot key for the advanced BIOS settings.



The default screen for entering the BIOS setup program can be changed. Refer to the **Setup Mode** item in section 3.7 **Boot menu** for details.

The screenshot shows the ASUS UEFI BIOS Utility - EZ Mode interface. Key components and their functions are as follows:

- Language Selection:** A dropdown menu at the top right is set to "English".
- Exit/Advanced Mode:** A button at the top right for exiting the BIOS setup program.
- System Information:** Displays CPU/motherboard temperature, CPU/5V/3.3V/12V voltage output, CPU/CPU\_OPT/Chassis fan speed, BIOS Version (0304), CPU Type (AMD Phenom(tm) II X4 910e Processor), Speed (2600 MHz), and Total Memory (2048 MB DDR3 1066MHz).
- Temperature, Voltage, and Fan Speed:** Three sections showing real-time data for various components.
- System Performance:** A section with icons for Quiet, Performance, Energy Saving, Normal, and ASUS Optimal mode.
- Boot Priority:** A section showing boot device options (Hard Drive and CD/DVD) and a note to use mouse or keyboard to navigate.
- Navigation Buttons:** Shortcut (F3), Advanced Mode (F7), Boot Menu (F8), and Default (F5) buttons at the bottom.

Annotations and their corresponding functions:

- Selects the display language of the BIOS setup program:** Points to the Language dropdown.
- Click to display all fan speeds if available:** Points to the Fan Speed section.
- Displays the CPU/motherboard temperature, CPU/5V/3.3V/12V voltage output, CPU/CPU\_OPT/Chassis fan speed:** Points to the Temperature, Voltage, and Fan Speed sections.
- Exits the BIOS setup program without saving the changes, saves the changes and resets the system, or enters the Advanced Mode:** Points to the Exit/Advanced Mode button.
- Quick switch to frequently used menus:** Points to the System Performance section.
- Displays the system properties of the selected mode on the right hand side:** Points to the Normal mode gauge.
- Selects the boot device priority:** Points to the Boot Priority section.
- Displays the Advanced mode menus:** Points to the Performance and Energy Saving icons.
- Power Saving mode:** Points to the Energy Saving icon.
- Normal mode:** Points to the Normal mode gauge.
- ASUS Optimal mode:** Points to the ASUS Optimal mode icon.
- Loads optimized default settings:** Points to the Default (F5) button.
- Selects the boot device priority:** Points to the Boot Menu (F8) button.



- The boot device options vary depending on the devices you installed to the system.
- **The Boot Menu (F8)** button is available only when the boot device is installed to the system.

### 3.2.2 Advanced Mode

The Advanced Mode provides advanced options for experienced end-users to configure the BIOS settings. The figure below shows an example of the Advanced Mode. Refer to the following sections for the detailed configurations.



To access the Advanced Mode, click **Exit**, then select **Advanced Mode** or press **F7** hotkey.

The screenshot shows the ASUS UEFI BIOS Utility in Advanced Mode. The interface includes a menu bar at the top with items: Main, Ai Tweaker, Advanced, Monitor, Boot, and Tool. A 'Back' button is located on the left. The main area displays various configuration fields such as CPU Ratio, Memory Frequency, CPU/NB Frequency, HT Link Speed, CPU Spread Spectrum, PCIe Spread Spectrum, EPU Power Saving Mode, DRAM Timing Control, DRAM Driving Control, DIGI+ Power Control, CPU & NB Voltage, Offset Mode Sign, and CPU Offset Voltage. A 'CPU Spread Spectrum' pop-up window is open, showing options: Auto, Disabled, and Enabled. A scroll bar is visible on the right side of the main area. A 'General help' box is located on the right, containing a list of navigation keys: Select Screen, Select Item, Enter: Select, +/-: Change Opt., F1: General Help, F2: Previous Values, F3: Shortcut, F5: Optimized Defaults, F10: Save, ESC: Exit, and F12: Print Screen. Labels at the bottom identify: Submenu item, Pop-up window, Scroll bar, and Navigation keys.

#### Menu bar

The menu bar on top of the screen has the following main items:

<b>Main</b>	For changing the basic system configuration
<b>Ai Tweaker</b>	For changing the overclocking settings
<b>Advanced</b>	For changing the advanced system settings
<b>Monitor</b>	For displaying the system temperature, power status, and changing the fan settings.
<b>Boot</b>	For changing the system boot configuration
<b>Tool</b>	For configuring options for special functions
<b>Exit</b>	For selecting the exit options and loading default settings

## Menu items

The highlighted item on the menu bar displays the specific items for that menu. For example, selecting **Main** shows the Main menu items.

The other items (Ai Tweaker, Advanced, Monitor, Boot, Tool, and Exit) on the menu bar have their respective menu items.

## Back button

This button appears when entering a submenu. Press <Esc> or use the USB mouse to click this button to return to the previous menu screen.

## Submenu items

A greater than sign (>) before each item on any menu screen means that the item has a submenu. To display the submenu, select the item and press <Enter>.

## Pop-up window

Select a menu item and press <Enter> to display a pop-up window with the configuration options for that item.

## Scroll bar

A scroll bar appears on the right side of a menu screen when there are items that DO NOT fit on the screen. Press the Up/Down arrow keys or <Page Up> / <Page Down> keys to display the other items on the screen.

## Navigation keys

At the bottom right corner of the menu screen are the navigation keys for the BIOS setup program. Use the navigation keys to select items in the menu and change the settings.

## General help

At the top right corner of the menu screen is a brief description of the selected item. Use <F12> key to capture the BIOS screen and save it to the removable storage device.

## Configuration fields

These fields show the values for the menu items. If an item is user-configurable, you can change the value of the field opposite the item. You cannot select an item that is not user-configurable.

### 3.3 Main menu

The Main menu appears when you enter the Advanced Mode of the BIOS Setup program. The Main menu provides you an overview of the basic system information, and allows you to set the system date, time, language, and security settings.

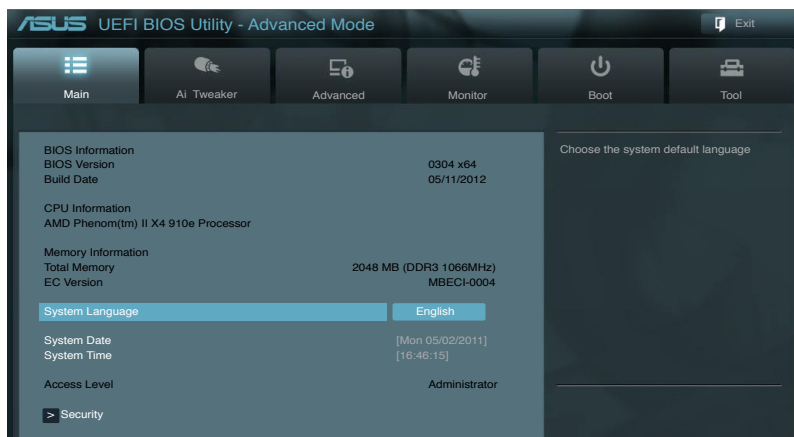

### Security

The Security menu items allow you to change the system security settings.

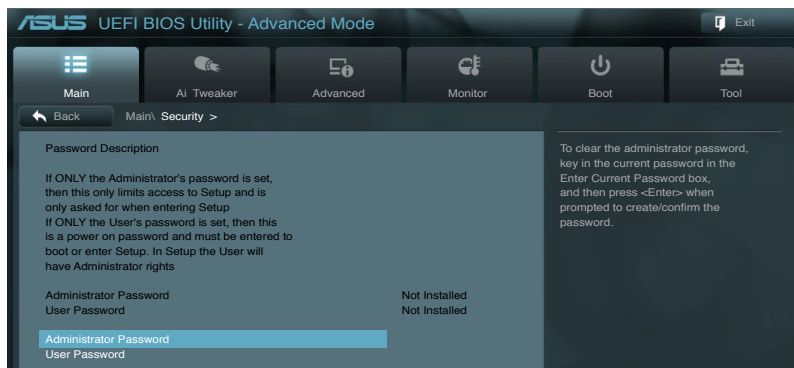

- If you have forgotten your BIOS password, erase the CMOS Real Time Clock (RTC) RAM to clear the BIOS password. See section 1.2.6 Onboard buttons and switches for information on how to erase the RTC RAM via the Clear CMOS button.
- The Administrator or User Password items on top of the screen show the default [Not Installed]. After you set a password, these items show [Installed].

## Administrator Password

If you have set an administrator password, we recommend that you enter the administrator password for accessing the system. Otherwise, you might be able to see or change only selected fields in the BIOS setup program.

### To set an administrator password:

1. Select the **Administrator Password** item and press <Enter>.
2. From the **Create New Password** box, key in a password, then press <Enter>.
3. Confirm the password when prompted.

### To change an administrator password:

1. Select the **Administrator Password** item and press <Enter>.
2. From the **Enter Current Password** box, key in the current password, then press <Enter>.
3. From the **Create New Password** box, key in a new password, then press <Enter>.
4. Confirm the password when prompted.

To clear the administrator password, follow the same steps as in changing an administrator password, but press <Enter> when prompted to create/confirm the password. After you clear the password, the **Administrator Password** item on top of the screen shows **Not Installed**.

## User Password

If you have set a user password, you must enter the user password for accessing the system. The User Password item on top of the screen shows the default Not Installed. After you set a password, this item shows Installed.

### To set a user password:

1. Select the **User Password** item and press <Enter>.
2. From the **Create New Password** box, key in a password, then press <Enter>.
3. Confirm the password when prompted.

### To change a user password:

1. Select the **User Password** item and press <Enter>.
2. From the **Enter Current Password** box, key in the current password, then press <Enter>.
3. From the **Create New Password** box, key in a new password, then press <Enter>.
4. Confirm the password when prompted.

To clear the user password, follow the same steps as in changing a user password, but press <Enter> when prompted to create/confirm the password. After you clear the password, the **User Password** item on top of the screen shows **Not Installed**.

## 3.4 Ai Tweaker menu

The Ai Tweaker menu items allow you to configure overclocking-related items.



Be cautious when changing the settings of the Ai Tweaker menu items. Incorrect field values can cause the system to malfunction.



The configuration options for this section vary depending on the CPU and DIMM model you installed on the motherboard.

Scroll down to display other BIOS items.





### **Ai Overclock Tuner [Auto]**

Allows you to select the CPU overclocking options to achieve the desired CPU internal frequency. Select any of these preset overclocking configuration options:

- [Auto] Loads the optimal settings for the system.
- [Manual] Allows you to individually set overclocking parameters.
- [D.O.C.P.] CPU Bus, CPU ratio and memory parameters will be auto optimized.

### **OC Tuner [CANCEL]**

OC Tuner automatically overclocks the frequency and voltage of CPU and DRAM for enhancing the system performance. Configuration options: [OK] [Cancel]

### **CPU Ratio [Auto]**

Allows user can manually adjust the maximum non-CPB mode CPU ratio. The value will be limit to CPU base or factory setting. Use the <+> and <-> keys to adjust the ratio. The valid value ranges vary according to your CPU model.

### **Memory Frequency [Auto]**

Allows you to set the memory operating frequency.

Configuration options: [Auto] [DDR3-800MHz] [DDR3-1066MHz] [DDR3-1333MHz] [DDR3-1600MHz]



---

Selecting a very high memory frequency may cause the system to become unstable! If this happens, revert to the default setting.

---

### **CPU/NB Frequency [Auto]**

Allows you to select the CPU/NB frequency.

Configuration options: [Auto] [1400MHz] [1600MHz] [1800MHz] [2000MHz]

### **HT Link Speed [Auto]**

Allows you to select the HyperTransport link speed.

Configuration options: [Auto] [800MHz] [1000MHz] [1200MHz] [1400MHz] [1600MHz] [1800MHz] [2000MHz]

### **CPU Spread Spectrum [Auto]**

- [Auto] Automatic configuration.
- [Disabled] Enhances CPU bus frequency overclocking ability.
- [Enabled] Sets to [Enabled] for EMI control.

### **PCIe Spread Spectrum [Auto]**

- [Auto] Automatic configuration.
- [Disabled] Enhances the PCIe overclocking ability.
- [Enabled] Sets to [Enabled] for EMI control.

### **EPU Power Saving Mode [Disabled]**

Allows you to enable or disable the EPU power saving function.

Configuration options: [Disabled] [Enabled]

## EPU Setting [Auto]

This item appears only when you set the EPU Power Saving Mode item to [Enabled] and allows you to select the EPU power saving mode.

Configuration options: [AUTO] [Light Power Saving Mode] [Medium Power Saving Mode] [Max Power Saving Mode]

## DRAM Timing Control

### DRAM CAS# Latency [Auto]

Configuration options: [Auto] [4 CLK] – [12 CLK]

### DRAM RAS# to CAS# Delay [Auto]

Configuration options: [Auto] [5 CLK] – [12 CLK]

### DRAM RAS# PRE Time [Auto]

Configuration options: [Auto] [5 CLK] – [12 CLK]

### DRAM RAS# ACT Time [Auto]

Configuration options: [Auto] [15 CLK] – [30 CLK]

### DRAM READ to PRE Time [Auto]

Configuration options: [Auto] [4 CLK] [5 CLK] [6 CLK] [7 CLK]

### DRAM RAS# to RAS# Delay [Auto]

Configuration options: [Auto] [4 CLK] [5 CLK] [6 CLK] [7 CLK]

### DRAM WRITE to READ Delay [Auto]

Configuration options: [Auto] [4 CLK] [5 CLK] [6 CLK] [7 CLK]

### DRAM CAS# write Latency [Auto]

Configuration options: [Auto] [5 CLK] – [12 CLK]

### DRAM WRITE Recovery Time [Auto]

Configuration options: [Auto] [5 CLK] [6 CLK] [7 CLK] [8 CLK] [10 CLK] [12 CLK]

### DRAM REF Cycle Time [Auto]

Configuration options: [Auto] [90ns] [110ns] [160ns] [300ns] [350ns]

### DRAM Row Cycle Time [Auto]

Configuration options: [Auto] [11 CLK] – [42 CLK]

### DRAM READ to WRITE Delay [Auto]

Configuration options: [Auto] [3 CLK] – [17 CLK]

### DRAM WRITE to READ Delay(DD) [Auto]

Configuration options: [Auto] [2 CLK] – [10 CLK]

### DRAM WRITE to WRITE Timing [Auto]

Configuration options: [Auto] [2 CLK] – [10 CLK]

### DRAM READ to READ Timing [Auto]

Configuration options: [Auto] [2 CLK] – [10 CLK]

### DRAM Refresh Rate [Auto]

Configuration options: [Auto] [Every 7.8ms] [Every 3.9ms]

### DRAM Command Rate [Auto]

Configuration options: [Auto] [1T] [2T]

## DRAM Driving Control

### DCT0 Information:

#### **CKE drive strength [Auto]**

Configuration options: [Auto] [1x] [1.25x] [1.5x] [2x]

#### **CS/ODT drive strength [Auto]**

Configuration options: [Auto] [1x] [1.25x] [1.5x] [2x]

#### **ADDR/CMD drive strength [Auto]**

Configuration options: [Auto] [1x] [1.25x] [1.5x] [2x]

#### **MEMCLK drive strength [Auto]**

Configuration options: [Auto] [0.75x] [1x] [1.25x] [1.5x]

#### **Data drive strength [Auto]**

Configuration options: [Auto] [0.75x] [1x] [1.25x] [1.5x]

#### **DQS drive strength [Auto]**

Configuration options: [Auto] [0.75x] [1x] [1.25x] [1.5x]

#### **Processor ODT [Auto]**

Configuration options: [Auto] [240 ohms +/- 20%] [120 ohms +/- 20%] [60 ohms +/- 20%]

### DCT1 Information:

#### **CKE drive strength [Auto]**

Configuration options: [Auto] [1x] [1.25x] [1.5x] [2x]

#### **CS/ODT drive strength [Auto]**

Configuration options: [Auto] [1x] [1.25x] [1.5x] [2x]

#### **ADDR/CMD drive strength [Auto]**

Configuration options: [Auto] [1x] [1.25x] [1.5x] [2x]

#### **MEMCLK drive strength [Auto]**

Configuration options: [Auto] [0.75x] [1x] [1.25x] [1.5x]

#### **Data drive strength [Auto]**

Configuration options: [Auto] [0.75x] [1x] [1.25x] [1.5x]

#### **DQS drive strength [Auto]**

Configuration options: [Auto] [0.75x] [1x] [1.25x] [1.5x]

#### **Processor ODT [Auto]**

Configuration options: [Auto] [240 ohms +/- 20%] [120 ohms +/- 20%] [60 ohms +/- 20%]

## DIGI+ Power Control

### CPU Load-Line Calibration [Auto]

Load-line is defined by AMD VRM spec and affects CPU voltage. The CPU working voltage will decrease proportionally to CPU loading. Higher load-line calibration would get higher voltage and better overclocking performance, but increase the CPU and VRM thermal. This item allows you to adjust the voltage range from the following percentages to boost the system performance: 0% (Regular), 25% (Medium), 50% (High), 75% (Ultra High) and 100% (Extreme).

Configuration options: [Auto] [Regular] [Medium] [High] [Ultra High] [Extreme]



---

The actual performance boost may vary depending on your CPU specification.

---

### CPU/NB Load-Line Calibration [Auto]

Allows you to select the CPU/NB Load-Line mode.

Configuration options: [Auto] [Regular] [High] [Extreme]

### CPU Current Capability [Auto]

This item provides wider total power range for overclocking. A higher value brings a wider total power range and extends the overclocking frequency range simultaneously.

Configuration options: [Auto] [100%] [110%] [120%] [130%] [140%]



---

DO NOT remove the thermal module while changing the DIGI+ Power Control related parameters. The thermal conditions should be monitored.

---



---

Some of the following items are adjusted by typing the desired values using the numeric keypad and press the <Enter> key. You can also use the <+> and <-> keys to adjust the value. To restore the default setting, type [auto] using the keyboard and press the <Enter> key.

---

### CPU/NB Current Capability [Auto]

This item provides wider total DRAM controller power range for overclocking. A higher value brings a wider total power range and extends the overclocking frequency range simultaneously.

Configuration options: [Auto] [100%] [110%] [120%] [130%]

### CPU Power Phase Control [Standard]

Phase number is the number of working VRM phase. Increasing phase number under heavy system loading to get more transient and better thermal performance. Reducing phase number under light system loading to increase VRM efficiency

[Standard] Proceeds phase control depending on the CPU loading.

[Optimized] Loads the ASUS optimized phase tuning profile.

[Extreme] Proceeds the full phase mode.

[Manual Adjustment] Allows manual adjustment.

### CPU Voltage Frequency [Auto]

Switching frequency will affects the VRM transient response and component thermal. Higher frequency gets quicker transient response. Configuration options: [Auto] [Manual]

### **VRM Spread Spectrum [Disabled]**

This item allows you to enable the spread spectrum to enhance system stability.

Configuration options: [Disabled] [Enabled]

### **CPU Power Duty Control [T.Probe]**

This item adjusts the current and thermal of every VRM phase component.

[T.Probe] Maintains the VRM thermal balance.

[Extreme] Maintains the VRM current balance.

### **CPU Power Response Control [Auto]**

Allows you to control the CPU Power Response.

Configuration options: [Auto] [Regular] [Medium] [Fast] [Ultra Fast]

### **CPU/NB Power Response Control [Auto]**

Allows you to control the CPU/NB Power Response.

Configuration options: [Auto] [Regular] [Medium] [Fast] [Ultra Fast]

### **CPU Power Thermal Control [130]**

Allows you to control the CPU Power thermal value.

Configuration options: [130] ~ [151]

### **DRAM Current Capability [Auto]**

Allows you to set the DRAM current capability.

Configuration options: [100%] [110%] [120%] [130%]

### **DRAM Voltage Frequency [300KHZ]**

Allows you to set the DRAM voltage frequency.

Configuration options: [300KHZ] [350KHZ] [400KHZ] [450KHZ] [500KHZ]

### **DRAM Power Phase Control [Optimized]**

Allows you to set the DRAM power phase control.

Configuration options: [Optimized] [Extreme]

### **CPU & NB Voltage [Offset Mode]**

[Manual Mode] Allows you to set a fixed CPU & NB voltage.

[Offset Mode] Allows you to set the Offset voltage.

### **Offset Mode Sign [+]**

This item appears only when you set the **CPU & NB Voltage** item to [Offset Mode].

[-] To offset the voltage by a negative value.

[+] To offset the voltage by a positive value.

### **CPU Offset Voltage [Auto]**

This item appears only when you set the **CPU & NB Voltage** item to [Offset Mode] and allows you to set the Offset voltage. The values range from 0.00625V to 0.70000V with a 0.00625V interval.

### **CPU/NB Offset Mode Sign [+]**

- [+] To offset the voltage by a positive value.
- [-] To offset the voltage by a negative value.

### **CPU/NB Offset Voltage [Auto]**

This item appears only when you set the **CPU & NB Voltage** item to [Offset Mode] and allows you to set the CPU/NB Offset voltage. The values range from 0.00625V to 0.70000V with a 0.00625V interval.

### **CPU Manual Voltage [Auto]**

This item appears only when you set the **CPU & NB Voltage** item to [Manual Mode] and allows you to set a fixed CPU voltage. The values range from 0.675V to 2.075V with a 0.00625V interval.



---

Refer to the CPU documentation before setting the CPU voltage. Setting a high voltage may damage the CPU permanently, and setting a low voltage may make the system unstable.

---

### **CPU/NB Manual Voltage [Auto]**

This item appears only when you set the **CPU & NB Voltage** item to [Manual Mode] and allows you to set a fixed CPU/NB voltage. The values range from 0.5V to 1.9V with a 0.00625V interval.

### **CPU VDDA Voltage [Auto]**

Allows you to set the CPU VDDA voltage. The values range from 2.20000V to 2.80000V with a 0.00625V interval.

### **DRAM Voltage [Auto]**

Allows you to set the DRAM voltage. The values range from 0.86V to 2.135V with a 0.005V interval.

### **NB Voltage [Auto]**

Allows you to set the Northbridge voltage. The values range from 1.10000V to 1.25V with a 0.00625V interval.

### **NB HT Voltage [Auto]**

Allows you to set the HyperTransport voltage. The values range from 1.2V to 1.4V with a 0.00625V interval.

### **NB 1.8V Voltage [Auto]**

The values range from 1.80V to 2.80V with a 0.005V interval.

### **SB Voltage [Auto]**

Allows you to set the Southbridge voltage. The values range from 1.10V to 1.80V with a 0.005V interval.

## 3.5 Advanced menu

The Advanced menu items allow you to change the settings for the CPU and other system devices.



Be cautious when changing the settings of the Advanced menu items. Incorrect field values can cause the system to malfunction.

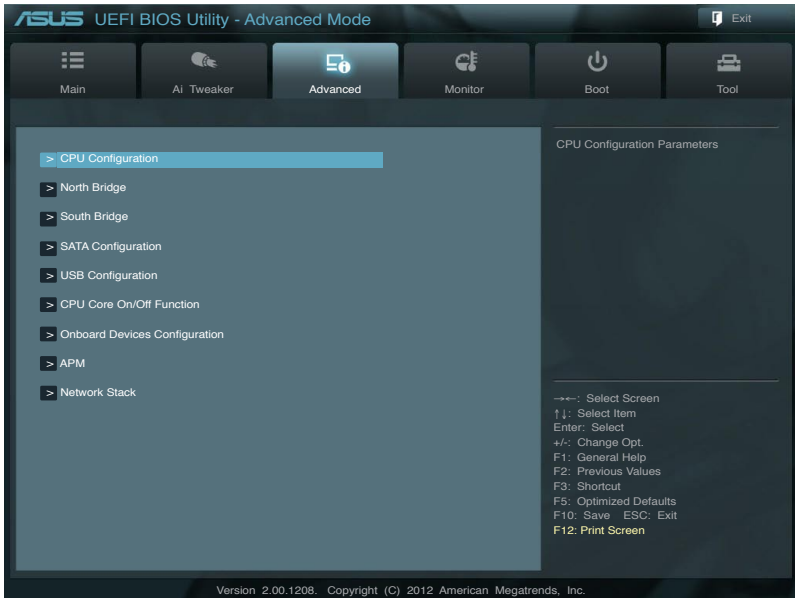

### 3.5.1 CPU Configuration

The items in this menu show the CPU-related information that the BIOS automatically detects.



The items shown in this screen may be different due to the CPU you installed.



#### Cool'n'Quiet [Enable]

Allows you to enable or disable AMD Cool'n'Quiet function.

Configuration options: [Enabled] [Disabled]

#### C1E [Enabled]

Enable this feature will let your system utilize the AMD specific ACPI states to save power consumption. Configuration options: [Enabled] [Disabled]

#### SVM [Enabled]

Enable AMD virtualization in CPU. This secure virtual mode will let you run multiple OS (guest) on the same physical hardware by decoupling OS and physical hardware with the hypervisor layer.

Configuration options: [Enabled] [Disabled]



## 3.5.2 North Bridge Configuration



### IOMMU [Disabled]

Set IOMMU to Enabled to show IOMMU Mode.

Configuration options: [Disabled] [Enabled]

### IOMMU Mode [Disabled]

IOMMU is supported on LINUX based systems to convert 32bit I/O to 64bit MMIO.

Configuration options: [Disabled] [64MB]

### Memory Configuration

#### Bank Interleaving [Auto]

Configuration options: [Auto] [Disabled]

#### Channel Interleaving [Auto]

Configuration options: [Auto] [Disabled]

#### ECC Mode [Enable]

Enables or disables the DRAM ECC mode that allows the hardware to report and correct memory errors.

[Disabled] Disables the DRAM ECC mode.

[Enable] Set to [Enable] to adjust ECC mode automatically.

**Power Down Enable [Disabled]**

Enables or disables the DDR power down mode.  
Configuration options: [Disabled] [Enabled]

**Memory Hole Remapping [Enabled]**

Configuration options: [Disabled] [Enabled]

**DCT Unganged Mode [Enabled]**

Configuration options: [Disabled] [Enabled]

**Initiate Graphic Adapter [PEG/PCI]**

Allows you to decide which graphics controller to use as the primary boot device.  
Configuration options: [PCI/PEG] [PEG/PCI]

**3.5.3 South Bridge Configuration**

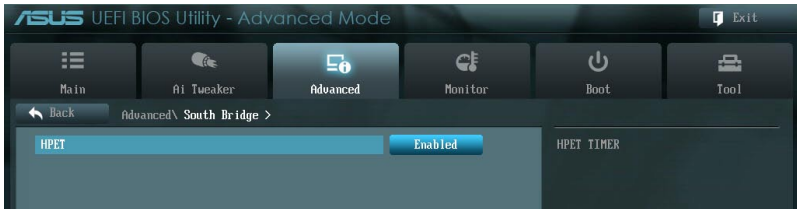

**HPET [Enabled]**

Allows you to set the HPET timer.  
Configuration options: [Disabled] [Enabled]

## 3.5.4 SATA Configuration

While entering Setup, the BIOS automatically detects the presence of SATA devices. The SATA Port items show **Not Present** if no SATA device is installed to the corresponding SATA port.

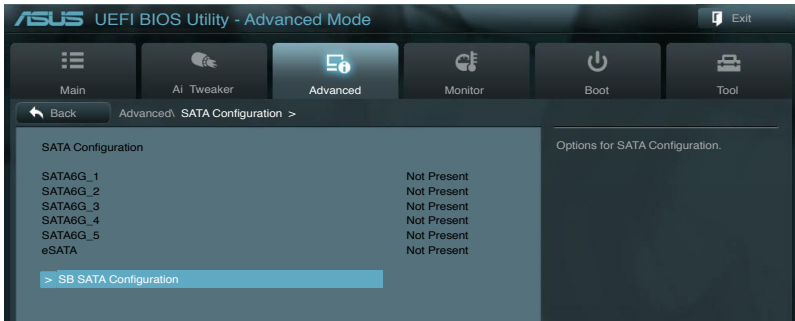

### SB SATA Configuration

Options for SATA Configuration.

#### OnChip SATA Channel [Enabled]

[Enabled] Enables the onboard channel SATA port.

[Disabled] Disables the onboard channel SATA port.



The following items appear only when you set the **OnChip SATA Channel** item to [Enabled].

#### SATA Port1–Port4 [AHCI]

Allows you to set the SATA configuration.

[IDE] Set to [IDE] when you want to use the Serial ATA hard disk drives as Parallel ATA physical storage devices.

[RAID] Set to [RAID] when you want to create a RAID configuration from the SATA hard disk drives.

[AHCI] Set to [AHCI] when you want the SATA hard disk drives to use the AHCI (Advanced Host Controller Interface). The AHCI allows the onboard storage driver to enable advanced Serial ATA features that increases storage performance on random workloads by allowing the drive to internally optimize the order of commands.

#### SATA Port5–eSATA [AHCI]

Setting this item to [IDE] instead of [RAID] or [AHCI] allows the system to recognize the optical drives connected to the SATA connectors 5 or eSATA when installing Windows OS.



- When the **SATA Port1–Port 4** and the **SATA Port5–eSATA** items are set to [AHCI], the information of the SATA connectors 1–5 & eSATA can be seen only under the OS environment or during POST.
- For Windows® XP OS, you have to install the AHCI driver, so that you could use the SATA connectors 1–5 & eSATA in AHCI mode under the OS environment.



If you use a SATA optical drive to run the Windows OS installation disk, we strongly recommend that you install the optical drive to the SATA connector 5 & eSATA and set them to [IDE] mode.

#### **S.M.A.R.T Status Check [Enabled]**

[Enabled]        Enables the S.M.A.R.T feature.

[Disabled]      Disables the S.M.A.R.T feature.

#### **SATA ESP on PORT1 [Disabled]**

Configuration options: [Enabled] [Disabled]

#### **SATA ESP on PORT2 [Disabled]**

Configuration options: [Enabled] [Disabled]

#### **SATA ESP on PORT3 [Disabled]**

Configuration options: [Enabled] [Disabled]

#### **SATA ESP on PORT4 [Disabled]**

Configuration options: [Enabled] [Disabled]

#### **SATA ESP on PORT5 [Disabled]**

Configuration options: [Enabled] [Disabled]

#### **SATA ESP on eSATA [Disabled]**

Configuration options: [Enabled] [Disabled]

## 3.5.5 USB Configuration

The items in this menu allow you to change the USB-related features.

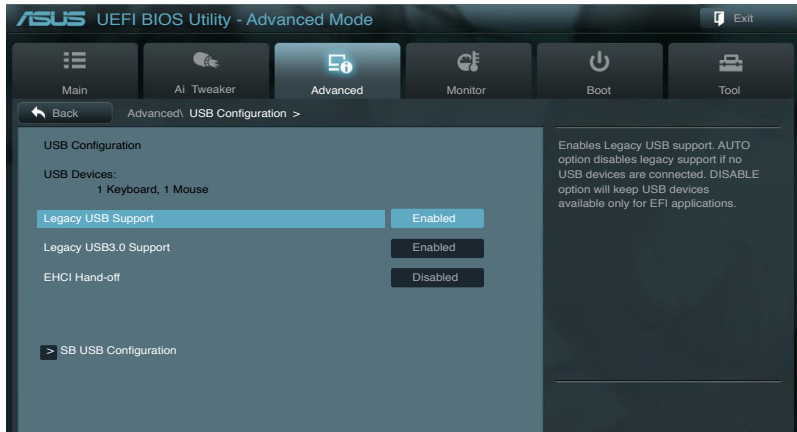

The **USB Devices** item shows the auto-detected values. If no USB device is detected, the item shows **None**.

### Legacy USB Support [Enabled]

- [Enabled] Enables the support for USB devices on legacy operating systems (OS).
- [Disabled] The USB devices can be used only for the BIOS setup program.
- [Auto] Allows the system to detect the presence of USB devices at startup. If detected, the USB controller legacy mode is enabled. If no USB device is detected, the legacy USB support is disabled.

### Legacy USB3.0 Support [Enabled]

- [Enabled] Enables the support for USB 3.0 devices on legacy operating systems (OS).
- [Disabled] Disables the function.

### EHCI Hand-off [Disabled]

- [Enabled] Enables the support for operating systems without an EHCI hand-off feature.
- [Disabled] Disables the function.

## SB USB Configuration

Options for SB USB Configuration.

### **OHCI HC (Bus 0 Dev 18 Fn 0) [Enabled]**

Configuration options: [Enabled] [Disabled]

### **OHCI HC (Bus 0 Dev 19 Fn 0) [Enabled]**

Configuration options: [Enabled] [Disabled]

### **OHCI HC (Bus 0 Dev 22Fn 0) [Enabled]**

Configuration options: [Enabled] [Disabled]

### **OHCI HC (Bus 0 Dev 20 Fn 5) [Enabled]**

Configuration options: [Enabled] [Disabled]

### **USB PORT 1-14 [Enabled]**

This item allows you to enable or disable individual USB ports.

Configuration options: [Enabled] [Disabled]

### 3.5.6 CPU Core On/Off Function

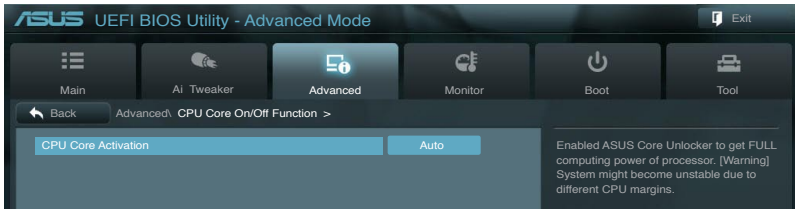

#### CPU Core Activation [Auto]

This item lets user turn off cores manually except core 1.

Configuration options: [Auto] [Manual]



The number of cores vary with CPU models.

### 3.5.7 Onboard Devices Configuration



#### ASM1061 Storage Controller [Enabled]

[Enabled] Enables the SATA6G\_E12 controller.

[Disabled] Disables the controller.

### **ASM1061 Storage OPROM [Enabled]**

This item appears only when you set the previous item to [Enabled] and allows you to enable or disable the ASM1061 Storage OptionRom.

Configuration options: [Enabled] [Disabled]

### **Asmedia USB 3.0 Controller (Rear) [Enabled]**

[Enabled] Enables the USB 3.0 controller.

[Disabled] Disables the controller.

### **Asmedia USB 3.0 Controller (Front) [Enabled]**

[Enabled] Enables the USB 3.0 controller.

[Disabled] Disables the controller.

### **Asmedia USB 3.0 Battery Charging Support [Disabled]**

This item appears only when you set the previous item to [Enabled] and allows you to enable or disable the Asmedia USB 3.0 Battery Charging Support.

Configuration options: [Enabled] [Disabled]

### **Realtek LAN Controller [Enabled]**

[Enabled] Enables the Realtek LAN controller.

[Disabled] Disables the controller.

### **Realtek PXE OPROM [Disabled]**

This item appears only when you set the previous item to [Enabled] and allows you to enable or disable the PXE OptionRom of the Realtek LAN controller.

Configuration options: [Enabled] [Disabled]

### **S3 Video Repost [Disabled]**

Allows you to set the S3 Video Repost.

Configuration options: [Disabled] [Enabled]

### **Serial Port Configuration**

The sub-items in this menu allow you to set the serial port configuration.



---

This item functions only if there is a serial port (COM1) connector on the motherboard.

---

#### **Serial Port [Enabled]**

Allows you to enable or disable the serial port (COM).

Configuration options: [Enabled] [Disabled]

#### **Change Settings [IO=3F8h; IRQ=4]**

Allows you to select the Serial Port base address.

Configuration options: [IO=3F8h; IRQ=4] [IO=2F8h; IRQ=3] [IO=3E8h; IRQ=4]  
[IO=2E8h; IRQ=3]



## SB HD Azalia Configuration

Options for SB HD Azalia.

### HD Audio Azalia Device [Enabled]

Allows you to enable or disable the HD Audio controller.

Configuration options: [Disabled] [Enabled]

### Azalia Front Panel [HD]

Allows you to set the front panel audio connector (AAFP) mode to legacy AC'97 or high-definition audio depending on the audio standard that the front panel audio module supports.

[AC 97] Sets the front panel audio connector (AAFP) mode to legacy AC'97

[HD] Sets the front panel audio connector (AAFP) mode to high definition audio.

### SPDIF Out Type [SPDIF]

[SPDIF] Sets to [SPDIF] for SPDIF audio output.

[HDMI] Sets to [HDMI] for HDMI audio output.

## 3.5.8 APM



### ErP Ready [Disabled]

- [Disabled] Disables the Energy Related Products (ErP) Ready function.
- [Enabled] Allows BIOS to switch off some power at S5 state to get system ready for the ErP requirement. When set to [Enabled], power for WOL, WO\_USB, audio and onboard LEDs will be switched off at S5 state.

### Restore AC Power Loss [Power Off]

When set to [Power Off], the system goes into off state after an AC power loss. When set to [Power On], the system will reboot after an AC power loss. When set to [Last State], the system goes into either off or on state, whatever the system state was before the AC power loss.

Configuration options: [Power Off] [Power On] [Last State]

### Power On By PS/2 Device [Enabled]

- [Disabled] Disables the PS/2 devices from generating a wake event.
- [Enabled] Enables the PS/2 devices to generate a wake event.

### Power On By PME Device [Enabled]

- [Disabled] Disables the PME devices from generating a wake event.
- [Enabled] Enables the PME devices to generate a wake event.

### Power On By Ring [Disabled]

- [Disabled] Disables the Ring devices from generating a wake event.
- [Enabled] Enables the Ring devices to generate a wake event.

### Power On By RTC [Disabled]

- [Disabled] Disables RTC from generating a wake event.
- [Enabled] When set to [Enabled], the items **RTC Alarm Date (Days) and Hour/Minute/Second** will become user-configurable with set values.

## 3.5.9 Network Stack

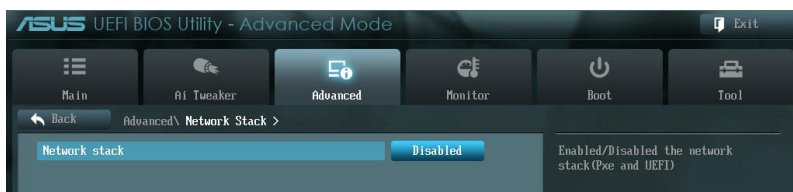

### Network stack [Disabled]

- This item allows user to enable/disable UEFI network stack function.
- Configuration options: [Disabled] [Enabled]

## 3.6 Monitor menu

The Monitor menu displays the system temperature/power status, and allows you to change the fan settings.

Scroll down to display the other BIOS items.



### CPU Temperature / MB Temperature [xxx°C/xxx°F]

The onboard hardware monitor automatically detects and displays the CPU and motherboard temperatures.

### VCORE Voltage, 3.3V Voltage, 5V Voltage, 12V Voltage, VDDA2.5V Voltage

The onboard hardware monitor automatically detects the voltage output through the onboard voltage regulators.

**CPU Fan Speed [xxxx RPM] / [N/A]**  
**Chassis Fan 1/2/3 Speed [xxxx RPM] / [N/A]**  
**CPU Opt Fan Speed [xxxx RPM] / [N/A]**

The onboard hardware monitor automatically detects and displays the CPU, chassis, and CPU optional fan speed in rotations per minute (RPM). If the fan is not connected to the motherboard, the field shows N/A.

**CPU Q-Fan Control [Enabled]**

[Disabled] Disables the CPU Q-Fan control feature.

[Enabled] Enables the CPU Q-Fan control feature.

**CPU Fan Profile [Standard]**

This item appears only when you enable the CPU Q-Fan Control feature and allows you to set the appropriate performance level of the CPU fan.

[Standard] Sets to [Standard] to make the CPU fan automatically adjust depending on the CPU temperature.

[Silent] Sets to [Silent] to minimize the fan speed for quiet CPU fan operation.

[Turbo] Sets to [Turbo] to achieve maximum CPU fan speed.

[Manual] Sets to [Manual] to assign detailed fan speed control parameters.



---

The following four items appear only when you set **CPU Fan Profile** to [Manual].

---

**CPU Upper Temperature [70]**

Use the <+> and <-> keys to adjust the upper limit of the CPU temperature. The values range from 20°C to 75°C.

**CPU Lower Temperature [20]**

Use the <+> and <-> keys to adjust the lower limit of the CPU temperature. The values range from 20°C to 75°C.

**CPU Fan Max. Duty Cycle(%) [20]**

Use the <+> and <-> keys to adjust the maximum CPU fan duty cycle. The values range from 20% to 100%. When the CPU temperature reaches the upper limit, the CPU fan will operate at the maximum duty cycle.

**CPU Fan Min. Duty Cycle(%) [20]**

Set the minimum CPU fan duty cycle when CPU temperature is lower the CPU Lower Temperature setting.

**CPU Fan Speed Low Limit [600 RPM]**

This item appears only when you enable the **CPU Q-Fan Control** feature and allows you to disable or set the CPU fan warning speed.

Configuration options: [Ignore] [100RPM] [200 RPM] [300 RPM] [400 RPM] [500 RPM] [600 RPM]

**Chassis Q-Fan Control [Disabled]**

[Disabled] Disables the Chassis Q-Fan control feature.

[Enabled] Enables the Chassis Q-Fan control feature.

## 3.7 Boot menu

The Boot menu items allow you to change the system boot options.



### Bootup NumLock State [On]

[On] Sets the power-on state of the NumLock to [On].

[Off] Sets the power-on state of the NumLock to [Off].

### Full Screen Logo [Enabled]

[Enabled] Enables the full screen logo display feature.

[Disabled] Disables the full screen logo display feature.



Set this item to [Enabled] to use the ASUS MyLogo 2™ feature.

### Wait For 'F1' If Error [Enabled]

[Disabled] Disables this function.

[Enabled] The system waits for the <F1> key to be pressed when error occurs.

## Fast Boot [Disabled]

Enable or disable boot with initialization of a minimal set of devices to launch active boot option.

Configuration options: [Disabled] [Enabled]



---

The following four items appear only when you set **Fast Boot** to [Enabled].

---

### Skip VGA [Disabled]

Configuration option: [Disabled] [Enabled]

### Skip USB [Disabled]

Configuration option: [Disabled] [Enabled]

### Skip PS2 [Disabled]

Configuration option: [Disabled] [Enabled]

## DirectKey [Go to BIOS...]

[Disabled] Disables the DirectKey function. The system will only power on or off when you press the DirectKey button.

[Go to BIOS Setup] Allows the system to power on and go to BIOS Setup directly when you press the DirectKey button.

## Option ROM Messages [Force BIOS]

[Force BIOS] The third-party ROM messages will be forced to display during the boot sequence.

[Keep Current] The third-party ROM messages will be displayed only if the third-party manufacturer had set the add-on device to do so.

## INT19 Trap Response [Immediate]

[Immediate] Executes the trap right away.

[Postponed] Executes the trap during legacy boot.

## CSM Support [Enabled]

Allows you to set CSM Support.

Configuration options: [Auto] [Disabled] [Enabled]

## Setup Mode [EZ Mode]

[Advanced Mode] Sets Advanced Mode as the default screen for entering the BIOS setup program.

[EZ Mode] Sets EZ Mode as the default screen for entering the BIOS setup program.

## Boot Option Priorities

These items specify the boot device priority sequence from the available devices. The number of device items that appears on the screen depends on the number of devices installed in the system.



- To access Windows OS in Safe Mode, do any of the following:
  - Press <F5> when ASUS Logo appears.
  - Press <F8> after POST.
- To select the boot device during system startup, press <F8> when ASUS Logo appears.

## Boot Override

These items display the available devices. The number of device items that appears on the screen depends on the number of devices installed in the system. Click an item to start booting from the selected device.

## CSM Parameters

This option controls whether or not CSM will be launched.

### Launch CSM [Always]

Configuration option: [Auto] [Always] [Never]

### Boot option filter [UEFI and L...]

Configuration option: [UEFI and Legacy] [Legacy only] [UEFI only]

### Launch PXE OpROM policy [DO NOT launch]

Configuration option: [DO NOT launch] [UEFI only] [Legacy only] [Legacy first] [UEFI first]

### Launch Storage OpROM policy [Legacy only]

Configuration option: [DO NOT launch] [UEFI only] [Legacy only] [Legacy first] [UEFI first]

### Launch Video OpROM policy [Legacy only]

Configuration option: [DO NOT launch] [UEFI only] [Legacy only] [Legacy first] [UEFI first]

### Other PCI device ROM priority [UEFI OpROM]

Configuration option: [UEFI OpROM] [Legacy OpROM]

### 3.8 Tools menu

The Tools menu items allow you to configure options for special functions. Select an item then press <Enter> to display the submenu.

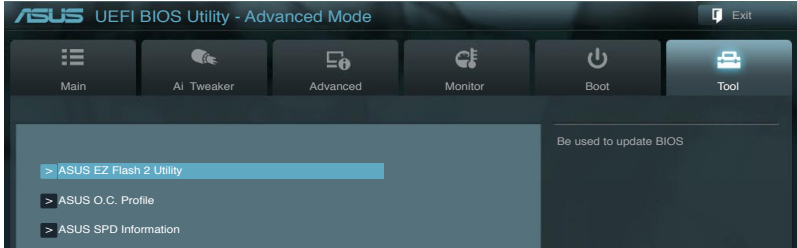

#### 3.8.1 ASUS EZ Flash 2 Utility

Allows you to run ASUS EZ Flash 2. When you press <Enter>, a confirmation message appears. Use the left/right arrow key to select between [Yes] or [No], then press <Enter> to confirm your choice.



For more details, refer to section 3.10.2 ASUS EZ Flash 2 utility.

#### 3.8.2 ASUS SPD Information

This item allows you to get DRAM SPD information.





### 3.8.3 ASUS O.C. Profile

This item allows you to store or load multiple BIOS settings.

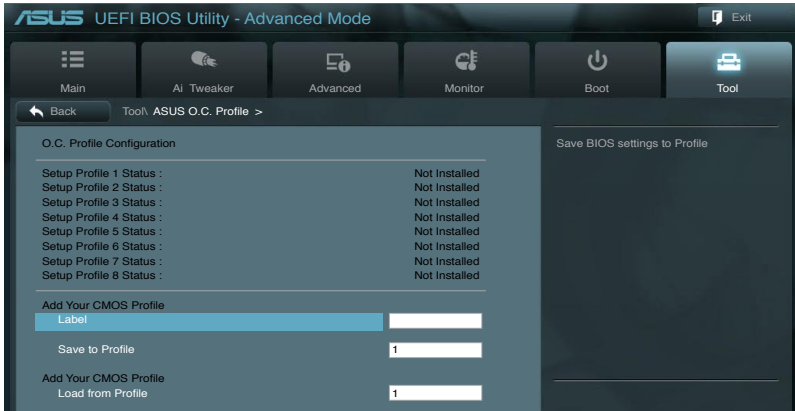

The Setup Profile Status items show Not Installed if no profile is created.

#### Label

Allows you to input the label of your setup profile.

#### Save to Profile

Allows you to save the current BIOS settings to the BIOS Flash, and create a profile. Key in a profile number from one to eight, press <Enter>, and then select **Yes**.

#### Load from Profile

Allows you to load the previous BIOS settings saved in the BIOS Flash. Key in the profile number that saved your BIOS settings, press <Enter>, and then select **Yes**.



- DO NOT shut down or reset the system while updating the BIOS to prevent the system boot failure!
- We recommend that you update the BIOS file only coming from the same memory/ CPU configuration and BIOS version.

## 3.9 Exit menu

The Exit menu items allow you to load the optimal default values for the BIOS items, and save or discard your changes to the BIOS items. You can access the EZ Mode from the Exit menu.

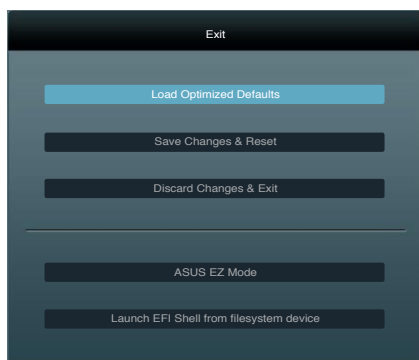

### Load Optimized Defaults

This option allows you to load the default values for each of the parameters on the Setup menus. When you select this option or if you press <F5>, a confirmation window appears. Select **Yes** to load the default values.

### Save Changes & Reset

Once you are finished making your selections, choose this option from the Exit menu to ensure the values you selected are saved. When you select this option or if you press <F10>, a confirmation window appears. Select **Yes** to save changes and exit.

### Discard Changes & Exit

This option allows you to exit the Setup program without saving your changes. When you select this option or if you press <Esc>, a confirmation window appears. Select **Yes** to discard changes and exit.

### ASUS EZ Mode

This option allows you to enter the EZ Mode screen.

### Launch EFI Shell from filesystem device

This option allows you to attempt to launch the EFI Shell application (shellx64.efi) from one of the available filesystem devices.

## 3.10 Updating BIOS

The ASUS website publishes the latest BIOS versions to provide enhancements on system stability, compatibility, or performance. However, BIOS updating is potentially risky. If there is no problem using the current version of BIOS, DO NOT manually update the BIOS. Inappropriate BIOS updating may result in the system's failure to boot. Carefully follow the instructions of this chapter to update your BIOS if necessary.



---

Visit the ASUS website ([www.asus.com](http://www.asus.com)) to download the latest BIOS file for this motherboard.

---

The following utilities allow you to manage and update the motherboard BIOS setup program.

1. **ASUS Update:** Updates the BIOS in Windows® environment.
2. **ASUS EZ Flash 2:** Updates the BIOS using a USB flash drive.
3. **ASUS BIOS Updater:** Updates and back ups the BIOS in DOS environment using the motherboard support DVD and a USB flash disk drive.



---

Save a copy of the original motherboard BIOS file to a USB flash disk in case you need to restore the BIOS in the future. Copy the original motherboard BIOS using the ASUS Update or BIOS Updater utilities.

---

### 3.10.1 ASUS Update

The ASUS Update is a utility that allows you to manage, save, and update the motherboard BIOS in Windows® environment.



- 
- **ASUS Update requires an Internet connection either through a network or an Internet Service Provider (ISP).**
  - **This utility is available in the support DVD that comes with the motherboard package.**
-

## Launching ASUS Update

To launch ASUS Update, click **Update > ASUS Update** on the AI Suite II main menu bar.



Quit all Windows® applications before you update the BIOS using this utility.

## Updating the BIOS through the Internet

To update the BIOS through the Internet:

1. From the ASUS Update screen, select **Update BIOS from Internet**, and then click **Next**.

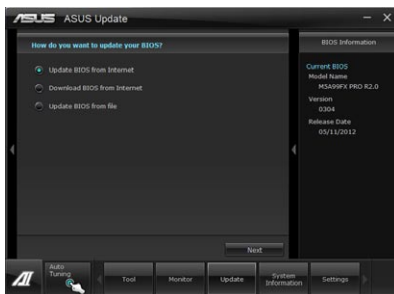

2. Select the ASUS FTP site nearest you to avoid network traffic.

If you want to enable the BIOS downgrade and auto backup functions, tick **Enable BIOS downgrade** and click **Next**.

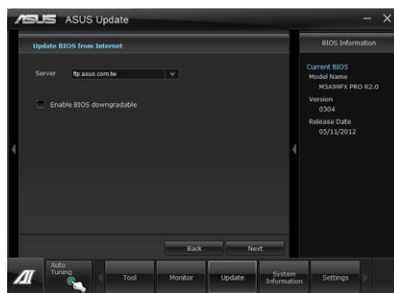

3. Select the BIOS version that you want to download. Click **Next**.

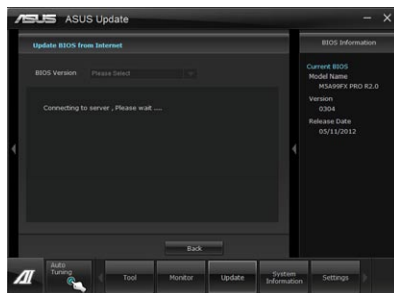

## Updating the BIOS through a BIOS file

To update the BIOS through a BIOS file:

1. From the ASUS Update screen, select **Update BIOS from file**, and then click **Next**.

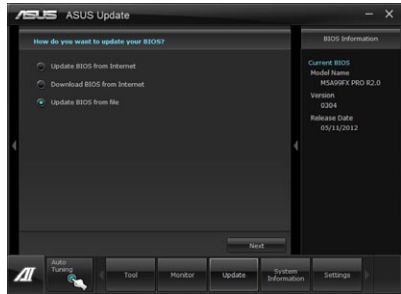

2. Locate the BIOS file and click **Next**.



3. You can decide whether to change the BIOS boot logo. Click **Yes** if you want to change the boot logo or **No** to continue.
4. Follow the onscreen instructions to complete the update process.



- The screenshots in this section are for reference only. The actual BIOS information vary by models.
- Refer to the software manual in the support DVD or visit the ASUS website at [www.asus.com](http://www.asus.com) for detailed software configuration.

## 3.10.2 ASUS EZ Flash 2

ASUS EZ Flash 2 allows you to update the BIOS without having to use a bootable floppy disk or an OS-based utility.



Before you start using this utility, download the latest BIOS from the ASUS website at [www.asus.com](http://www.asus.com).

### To update the BIOS using EZ Flash 2:

1. Insert the USB flash disk that contains the latest BIOS file to the USB port.
2. Enter the Advanced Mode of the BIOS setup program. Go to the Tool menu to select ASUS EZ Flash Utility and press <Enter> to enable it.

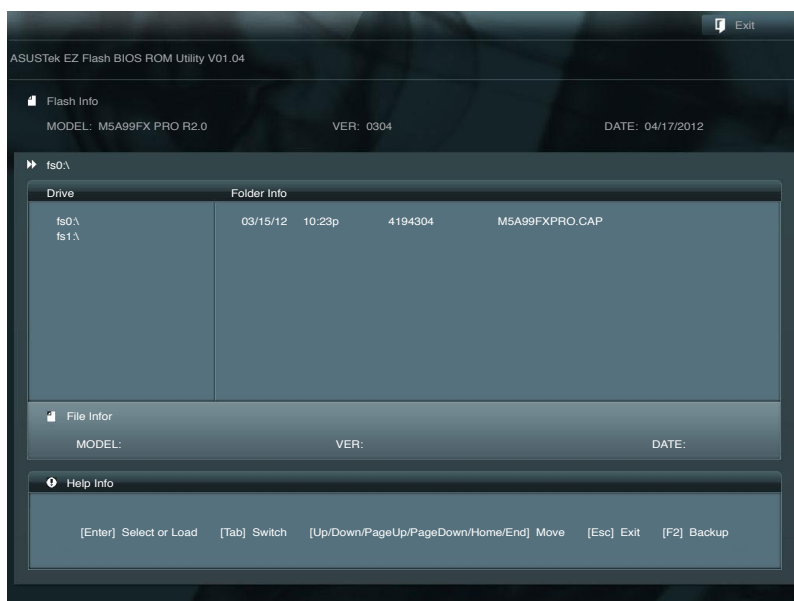

3. Press <Tab> to switch to the Drive field.
4. Press the Up/Down arrow keys to find the USB flash disk that contains the latest BIOS, and then press <Enter>.
5. Press <Tab> to switch to the Folder Info field.
6. Press the Up/Down arrow keys to find the BIOS file, and then press <Enter> to perform the BIOS update process. Reboot the system when the update process is done.



- 
- This function can support devices such as a USB flash disk with FAT 32/16 format and single partition only.
  - **DO NOT** shut down or reset the system while updating the BIOS to prevent system boot failure!
- 



Ensure to load the BIOS default settings to ensure system compatibility and stability. Select the Load Optimized Defaults item under the Exit menu. See section **3.9 Exit Menu** for details.

---

### 3.10.3 ASUS BIOS Updater

The ASUS BIOS Updater allows you to update the BIOS in DOS environment. This utility also allows you to copy the current BIOS file that you can use as a backup when the BIOS fails or gets corrupted during the updating process.



---

The succeeding utility screens are for reference only. The actual utility screen displays may not be same as shown.

---

#### Before updating BIOS

1. Prepare the motherboard support DVD and a USB flash drive in FAT32/16 format and single partition.
2. Download the latest BIOS file and BIOS Updater from the ASUS website at <http://support.asus.com> and save them on the USB flash drive.



- 
- NTFS is not supported under DOS environment. DO NOT save the BIOS file and BIOS Updater to a hard disk drive or USB flash drive in NTFS format.
  - DO NOT save the BIOS file to a floppy disk due to low disk capacity.
- 

3. Turn off the computer and disconnect all SATA hard disk drives (optional).

#### Booting the system in DOS environment

1. Insert the USB flash drive with the latest BIOS file and BIOS Updater to the USB port.
2. Boot your computer. When the ASUS Logo appears, press <F8> to show the BIOS Boot Device Select Menu. Insert the support DVD into the optical drive and select the optical drive as the boot device.

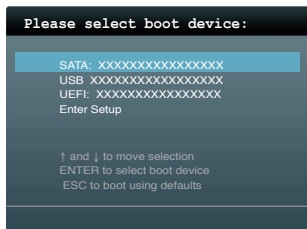



3. When the Make Disk menu appears, select the FreeDOS command prompt item by pressing the item number.
4. At the FreeDOS prompt, type `d:` and press `<Enter>` to switch the disk from Drive C (optical drive) to Drive D (USB flash drive).

```

Welcome to FreeDOS (http://www.freedos.org) !
C:\>d:
D:\>

```

### Backing up the current BIOS

To backup the current BIOS file using the BIOS Updater



Ensure that the USB flash drive is not write-protected and has enough free space to save the file.

1. At the FreeDOS prompt, type `bupdater /o[filename]` and press `<Enter>`.

```
D:\>bupdater /oOLDBIOS1 .rom
```

Filename Extension

The [filename] is any user-assigned filename with no more than eight alphanumeric characters for the filename and three alphanumeric characters for the extension.

2. The BIOS Updater backup screen appears indicating the BIOS backup process. When BIOS backup is done, press any key to return to the DOS prompt.

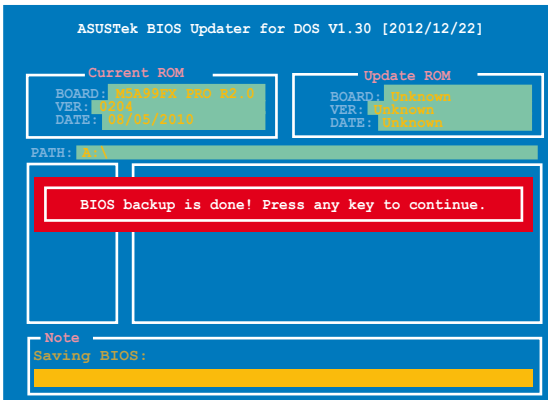

## Updating the BIOS file

### To update the BIOS file using BIOS Updater:

1. At the FreeDOS prompt, type `bupdater /pc /g` and press <Enter>.

```
D:\>bupdater /pc /g
```

2. The BIOS Updater screen appears as below.

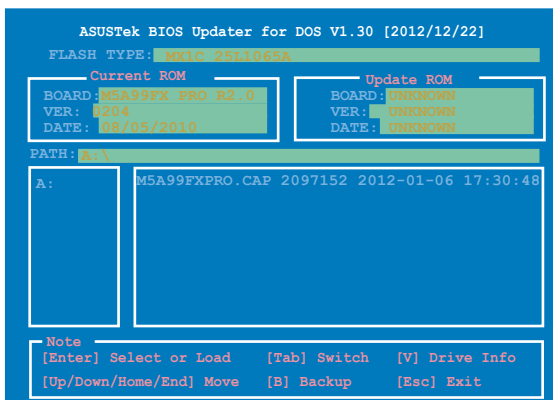

3. Press <Tab> to switch between screen fields and use the <Up/Down/Home/End> keys to select the BIOS file and press <Enter>. BIOS Updater checks the selected BIOS file and prompts you to confirm BIOS update.



4. Select Yes and press <Enter>. When BIOS update is done, press <ESC> to exit BIOS Updater. Restart your computer.



DO NOT shut down or reset the system while updating the BIOS to prevent system boot failure!



- For BIOS Updater version 1.04 or later, the utility automatically exits to the DOS prompt after updating BIOS.
- Ensure to load the BIOS default settings to ensure system compatibility and stability. Select the **Load Optimized Defaults** item under the **Exit BIOS** menu. See Chapter 3 of your motherboard user manual for details.
- Ensure to connect all SATA hard disk drives after updating the BIOS file if you have disconnected them.

# Software support

## 4.1 Installing an operating system

This motherboard supports Windows® XP/ 64-bit XP/ Vista / 64-bit Vista / 7 / 64-bit 7 operating systems (OS). Always install the latest OS version and corresponding updates to maximize the features of your hardware.



- Motherboard settings and hardware options vary. Use the setup procedures presented in this chapter for reference only. Refer to your OS documentation for detailed information.
- Ensure that you install the Windows® XP Service Pack 3 or later versions before installing the drivers for better compatibility and system stability.

## 4.2 Support DVD information



The contents of the support DVD are subject to change at any time without notice. Visit the ASUS website at [www.asus.com](http://www.asus.com) for updates.

### 4.2.1 Running the support DVD

Place the support DVD into the optical drive. The DVD automatically displays the Drivers menu if Autorun is enabled in your computer. Click each menu tab and select the items you want to install.

The Drivers menu shows the available device drivers if the system detects installed devices. Install the necessary drivers to use the devices.

The Make Disk menu contains items to create the RAID/AHCI driver disk.

The Manual menu contains the list of supplementary user manuals. Click an item to open the folder of the user manual.

The Utilities menu shows the applications and other software that the motherboard supports.

Click an item to install

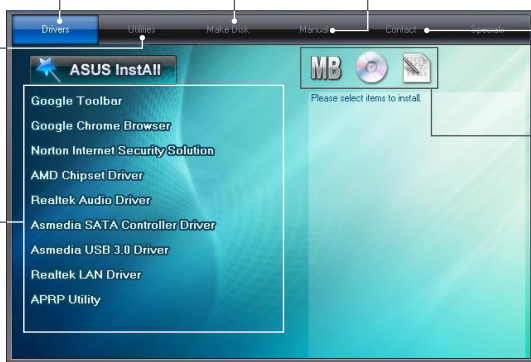

Click the Contact tab to display the ASUS contact information.

Click an icon to display DVD/motherboard information



If Autorun is NOT enabled in your computer, browse the contents of the support DVD to locate the file ASSETUP.EXE from the BIN folder. Double-click the ASSETUP.EXE to run the DVD.

## 4.2.2 Obtaining the software manuals

The software manuals are included in the support DVD. Follow the instructions below to get the necessary software manuals.



The software manual files are in Portable Document Format (PDF). Install the Adobe® Acrobat® Reader from the Utilities menu before opening the files.

1. Click the **Manual** tab. Click **ASUS Motherboard Utility Guide** from the manual list on the left.



2. The **Manual** folder of the support DVD appears. Double-click the folder of your selected software.

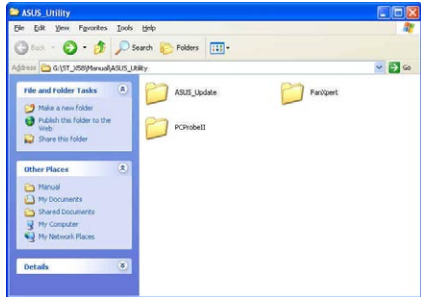

3. Some software manuals are provided in different languages. Double-click the language to show the software manual.

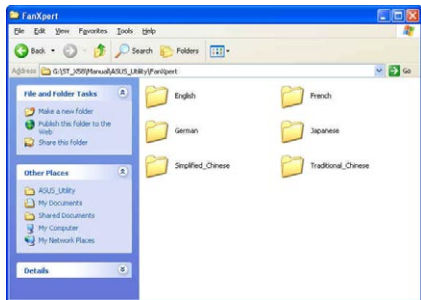

The screenshots in this section are for reference only. The actual software manuals containing in the support DVD vary by models.

## 4.3 Software information

Most of the applications in the support DVD have wizards that will conveniently guide you through the installation. View the online help or readme file that came with the software application for more information.

### 4.3.1 AI Suite II

AI Suite II is an all-in-one interface that integrates several ASUS utilities and allows users to launch and operate these utilities simultaneously.

#### Installing AI Suite II

To install AI Suite II on your computer:

1. Place the support DVD to the optical drive. The Drivers installation tab appears if your computer has enabled the Autorun feature.
2. Click **Utilities** tab > **AI Suite II**.
3. Follow the onscreen instructions to complete the installation.

#### Using AI Suite II

AI Suite II automatically starts when you enter the Windows® operating system (OS). The AI Suite II icon appears in the Windows® notification area. Click the icon to open the AI Suite II main menu bar.

Click each button to select and launch a utility, to monitor the system, to update the motherboard BIOS, to display the system information, and to customize the settings of AI Suite II.

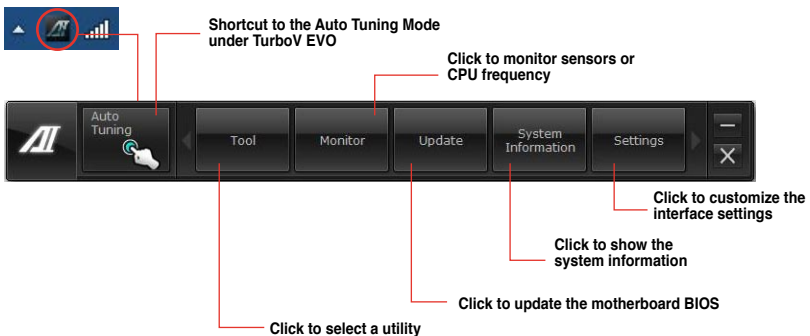

- The **Auto Tuning** button appears only on models with the TurboV EVO function.
- The applications in the Tool menu vary with motherboard models and CPUs installed.
- The screenshots of AI Suite II in this user manual are for reference only. The actual screenshots vary with models.
- Refer to the software manual in the support DVD or visit the ASUS website at [www.asus.com](http://www.asus.com) for detailed software configuration.

## 4.3.2 DIGI+ Power Control

ASUS DIGI+ Power Control allows you to adjust VRM voltage and frequency modulation to enhance reliability and stability. It also provides the highest power efficiency, generating less heat to prolong the component lifespan and minimize power loss.

To launch DIGI+ Power Control, click **Tool > Power Control** on the AI Suite II main menu bar.

### Smart DIGI+ Key



Function no.	Function description
1	<b>Smart DIGI+ Key</b> Quickly delivers an optimized VRM frequency, voltage, and current for superior CPU/DRAM overlocking performance with one click.
2	<b>OC Now!</b> Adjusts the ratio settings in TurboV.
3	<b>Default</b> Sets your CPU/DRAM power to default settings.

## CPU Power

CPU Power offers precise digital power control for CPU and CPU/NB to enhance efficiency, stability, and performance for overclocking scenarios.



Function no.	Function description
1	<b>CPU Load-line Calibration</b> It allows you to adjust the voltage settings and control the system temperature. Higher load-line calibration could get higher voltage and good overclocking performance but increases the CPU and VRM thermal.
2	<b>CPU Current Capability</b> CPU Current Capability provides wider total power range for overclocking. A higher value setting gets higher VRM power consumption delivery.
3	<b>CPU Voltage Frequency</b> Switching frequency will affect the VRM transient response and component thermal. Higher frequency gets quicker transient response.

Function no.	Function description
4	<b>CPU/NB Load-line Calibration</b> Set to a higher value for system performance, or to a lower value for better thermal solution.
5	<b>CPU/NB Current Capability</b> Setting CPU/NB Current Capability to a higher value increases the overclocking frequency range of the DRAM Controller.
6	<b>CPU Power Phase Control</b> Increase phase number under heavy system loading to get more transient and better thermal performance. Reduce phase number under light system loading to increase VRM efficiency.
7	<b>CPU Power Response Control</b> The VRM controller provides a faster and precise power response rate for CPU. Apply a higher value for an extreme overclocking.
8	<b>CPU Power Thermal Control</b> A higher temperature brings a wider CPU power thermal range, and extends the overclocking tolerance to enlarge overclocking potential.
9	<b>CPU Power Duty Control</b> CPU Power Duty Control adjusts the current of every VRM phase and the thermal of every phase component.
10	<b>CPU/NB Power Response Control</b> The CPU/NB controller provides a faster and precise power response rate for CPU&DRAM. Apply a higher value for an extreme overclocking.



## DRAM Power

DRAM Power offers precise digital power control for DRAM to enhance efficiency, stability, and performance for overclocking scenarios.

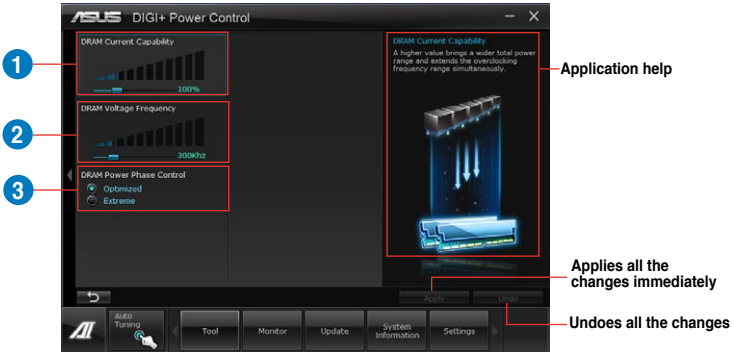

Function no.	Function description
1	<p><b>DRAM Current Capability</b></p> <p>A higher value brings a wider total power range and extends the overclocking frequency range simultaneously.</p>
2	<p><b>DRAM Voltage Frequency</b></p> <p>Allows you to adjust the DRAM switching frequency for system stability or to increase OC Range.</p>
3	<p><b>DRAM Power Phase Control</b></p> <p>Select <b>Extreme</b> for full phase mode to increase system performance or select <b>Optimized</b> for ASUS optimized phase tuning profile to increase DRAM power efficiency.</p>



- The actual performance boost may vary depending on your CPU specification.
- Do not remove the thermal module. The thermal conditions must be monitored.

### 4.3.3 TurboV EVO

ASUS TurboV EVO includes **TurboV** that allows you to manually adjust the CPU frequency and related voltages such as **CPU Level Up** that offers automatic and easy overclocking and system level up.

To launch AI Suite II, click **Tool > TurboV EVO** on the AI Suite II main menu bar.



Refer to the software manual in the support DVD or visit the ASUS website at [www.asus.com](http://www.asus.com) for detailed software configuration.

#### TurboV

TurboV allows you to overclock the CPU Bus/PEG frequency, CPU voltage, CPU/NB voltage and DRAM voltage in Windows® environment and takes effect in real-time without exiting and rebooting the OS.



Refer to the CPU documentation before adjusting CPU voltage settings. Setting a high voltage may damage the CPU permanently, and setting a low voltage may lead to an unstable system.



For system stability, all changes made in TurboV will not be saved to BIOS settings and will not be kept on the next system boot. Use the **Save Profile** function to save your customized overclocking settings and manually load the profile after Windows starts.

The screenshot shows the ASUS TurboV EVO interface with the following annotations:

- Click to select mode:** Points to the 'Manual Mode' and 'Auto Tuning' tabs.
- Load profile:** Points to the 'Profile' dropdown menu.
- Target values:** Points to the '200' values in the 'CPU Bus/PEG Freq' row.
- Current values:** Points to the '15000', '0.95000', and '1.550' values in the 'CPU Voltage', 'CPU/NB Voltage', and 'DRAM Voltage' rows.
- Click to show settings:** Points to the 'Advanced Mode' section.
- Save the current settings as a new profile:** Points to the 'Save Profile' button.
- Voltage Adjustment bars:** Points to the voltage adjustment sliders.
- Undoes all the changes:** Points to the 'Undo' button.
- Applies all the changes immediately:** Points to the 'Apply' button.
- Click to restore all startup settings:** Points to the 'OS Default Settings' button.

## Using Advanced Mode

Click on the **Advanced Mode** tab to adjust the advanced voltage settings.

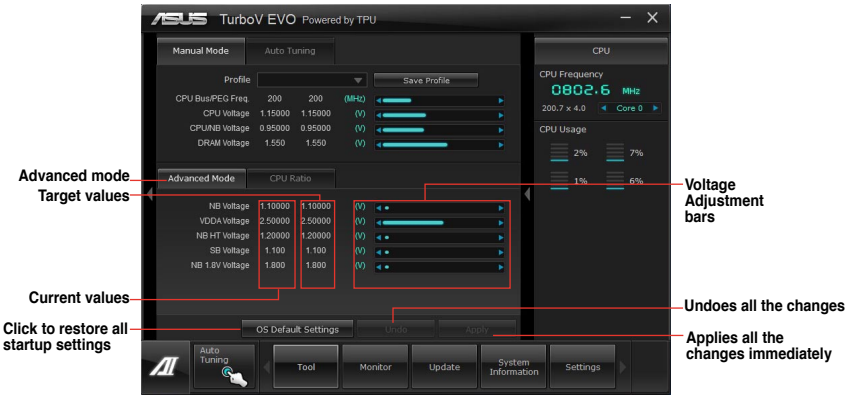

## CPU Ratio

Allows you to manually adjust the CPU ratio.

1. Click on the **CPU Ratio** tab.
2. Drag the adjustment bar upwards or downwards to the desired value.
3. Click **Apply** to save the changes made.



- Set the **CPU Ratio Setting** item in BIOS to [Auto] before using the CPU Ratio function in TurboV. Refer to the BIOS chapter of your motherboard user manual for details.
- The CPU Ratio bars show the status of the CPU cores, which vary with your CPU model.

## Auto Tuning

ASUS TurboV EVO provides you with these two auto-tuning modes for the most flexible auto-tuning options.



- The overclocking result varies with the CPU model and the system configuration.
- We recommend that you set up a better thermal environment to prevent overheating from damaging the motherboard.

- **Fast Tuning:** fast overclocking for the system
- **Extreme Tuning:** extreme overclocking for the system

### Using Fast Tuning

1. Click **Auto Tuning** tab > **Fast**.
2. Read the warning messages and click **Start** to start the auto-overclocking process.

TurboV automatically overclocks the CPU, saves the BIOS settings, and restarts the system.



3. After the system restarts, a message appears indicating that auto-tuning is successful. Click **OK** to exit.

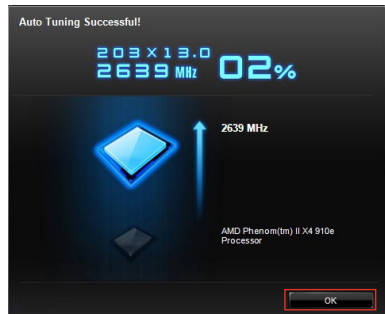

## Using Extreme Tuning

1. Click **Auto Tuning** tab > **Extreme**.
2. Read the warning messages and click **Start** to start the auto-overclocking process.

TurboV automatically overclocks the CPU and memory, and restarts the system.

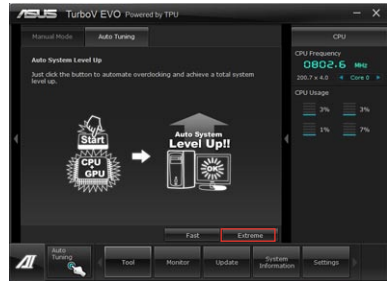

3. After the system has restarted, a message appears indicating the current overclocking result. To keep the result, click **Stop**.

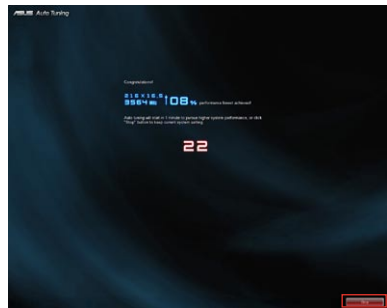

4. If you did not click **Stop** in the previous step, TurboV automatically starts further system overclocking and stability test. Click **Stop** if you want to cancel the overclocking process.

TurboV automatically adjusts and saves the BIOS settings and restarts the system.



5. After the system has restarted, a message appears indicating that the auto-tuning process is successful. Click **OK** to exit.

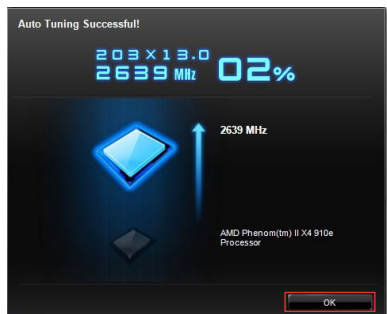

### 4.3.4 EPU

EPU is an energy-processing utility that provides several power-saving modes. When set to the Auto Mode, the system automatically changes its power-saving mode based on the current system condition.

You can also configure the system settings such as CPU frequency, GPU frequency, vCore Voltage, and Fan Control to customize a power-saving mode.

#### Launching EPU

To launch EPU, click **Tool > EPU** on the AI Suite II main menu bar.

The screenshot shows the ASUS EPU application window. At the top, there are three power-saving modes: **Auto**, **High performance**, and **Max. power saving**. The **Auto** mode is selected. Below these modes are several performance metrics: **Tranquility**, **Performance**, **Convenience**, **Reliability**, and **Energy Saved**. A central pentagon graphic is also present. At the bottom, there are navigation buttons: **Auto Tuning**, **Tool**, **Monitor**, **Update**, **System Information**, and **Settings**.

On the right side, there is an **EPU Status** panel. It includes a **Sensor** section with icons for **CPU**, **HDD**, **Fan**, **Chipset**, **Memory**, and **VGA**. Below this, it shows **Reduced CO2 Emission** (0.00 mg) and **Time Started** (Since: 2011/09/07 17:03). There are two radio buttons for selecting the CO2 reduction source: **From EPU Installation** (selected) and **From the Last Reset**. At the bottom of the status panel, it displays **Current CPU Power** (2.50 Watts).

Callouts from the image:

- Multiple system operating modes**: Points to the three power-saving mode buttons.
- Displays the following message if no VGA power saving engine is detected.**: Points to a warning dialog box that says: "Warning: No VGA driver. Please install a compatible VGA card or install and enable the VGA driver. For the list of compatible VGA cards, refer to: [http://www.asus.com/hk/hk\\_en/brand/](http://www.asus.com/hk/hk_en/brand/)".
- The items lighting up means power saving engine is activated**: Points to the glowing icons in the EPU Status panel.
- Displays the amount of CO2 reduced**: Points to the "Reduced CO2 Emission" value.
- \*Shifts between the display of Total and Current CO2 reduced**: Points to the radio buttons for CO2 reduction source.
- Displays the current CPU power**: Points to the "Current CPU Power" value.
- Advanced settings for each mode**: Points to the "Configurations" button.
- Displays the system properties of each mode**: Points to the "Auto Tuning" button.



- \*Select **From EPU Installation** to show the CO2 that has been reduced since you installed EPU.
- \*Select **From the Last Reset** to show the total CO2 that has been reduced since you click the Clear button **Clear**.
- Refer to the software manual in the support DVD or visit the ASUS website at [www.asus.com](http://www.asus.com) for detailed software configuration.

### 4.3.5 Remote GO!

Connect your computer to a wireless network and use Remote GO! to wirelessly stream media files to DLNA devices. It allows you to remotely control and access your computer using your mobile device, and easily transfer files between your computer and mobile device.



- Remote GO! is supported only on Windows® 7.
- All devices using the Remote GO! functions must be in the same network.

### Using Remote GO!

To launch Remote GO!, click **Tool > Remote GO!** on the AI Suite II menu bar.



### Remote GO! functions

- **DLNA Media Hub:** Provides support to the latest DLNA standard, and allows you to stream media files to a DLNA-supported device.
- **Remote Desktop:** Allows you to view your computer's desktop and remotely operate your computer in real-time from your mobile device.
- **File Transfer:** Allows you to transfer files between your computer and mobile device.



Launch W-Fi GO! Remote on your mobile device to use W-Fi GO! Remote control functions. For more details, refer to next section **W-Fi GO! Remote**.

## W-Fi GO! Remote

Install the W-Fi GO! Remote application on your mobile device to use Remote GO!'s remote control functions.



- W-Fi GO! Remote supports iOS 4.0/Android 2.3 mobile devices or later versions.
- For iOS devices, download the W-Fi GO! Remote from iTunes store. For Android devices, download the W-Fi GO! Remote from Google Play Store or from ASUS support DVD.

## Launching W-Fi GO! Remote

1. Turn on your mobile device's wireless connection. Ensure that your mobile device is within the same network as your computer.
2. On your mobile device, tap  and tap **Enter** on the W-Fi GO! Remote page.
3. Tap the computer you want to connect to your mobile device.
4. Tap the computer you want to connect to your mobile device.

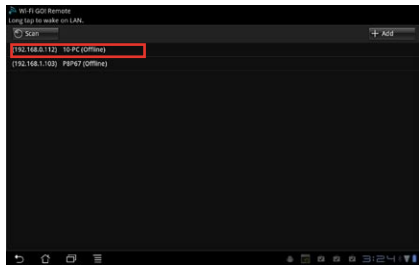



## W-Fi GO! Remote menu

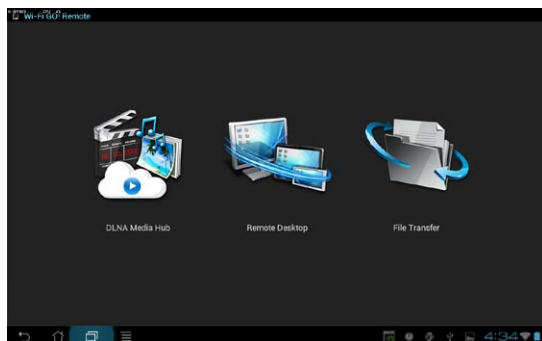

The W-Fi GO! Remote's user interface shown above is for reference only and may vary with the mobile device's operating system.

Below are the supported screen resolution of your mobile devices:

Screen type	Low Density (120, ldpi)	Medium Density (160, mdpi)	High Density (240, hdpi)	Extra high density (320, xhdpi)
Small creen	QVGA (240 x 320)		480 x 640	
Normal screen	WQVGA400 (240 x 400)	HVGA (320 x 480)	WVGA800 (480 x 800)	640 x 960
	WQVGA432 (240 x 432)		WVGA854 (480 x 854) 600 x 1024	
Large screen	WVGA800 (480 x 800)	WVGA800 (480 x 800)	600 x 1024	
	WVGA854 (480 x 854)	WVGA854 (480 x 854)		
Extra large screen	1024 x 600	WXGA (1280 x 800)	1536 x 1152	2048 x 1536
		1024 x 768	1920 x 1152	2560 x 1536
		1280 x 768	1920 x 1200	2560 x 1600

## DLNA Media Hub

DLNA Media Hub allows you to stream your multimedia files to your DLNA-supported device and remotely control playback using your mobile device or your computer.

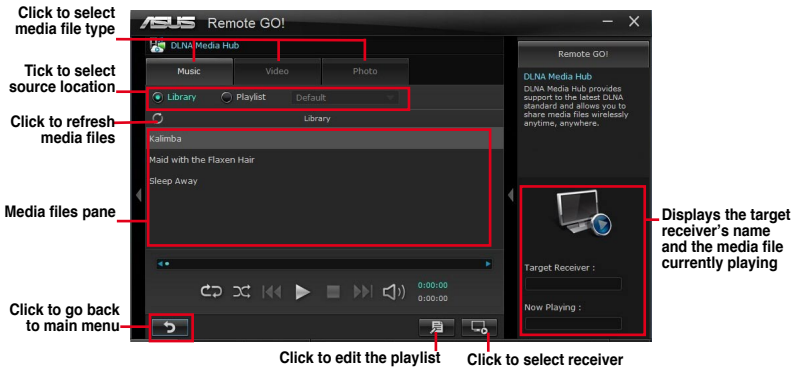

## Using the DLNA Media Hub

- From the main screen, click **DLNA Media Hub**.
- Click  to select a device as your receiver.
  - When using your DLNA display (such as DLNA TV) as the receiver, ensure that DLNA function is enabled.
  - When using another computer as the receiver, launch **Windows Media Player**, click **Stream > Allow remote control of my Player** to remotely control media playback.

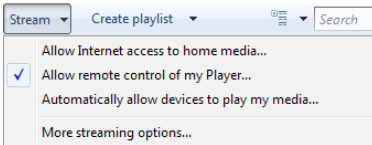

- When using the computer as sender and receiver, launch **Windows Media Player**, click **Stream > Allow remote control of my Player** and **Automatically allow devices to play my media**.

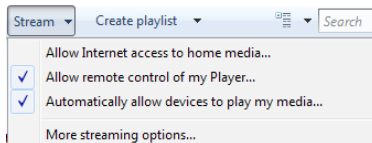

- Only computers under Windows® 7 support the DLNA Media Hub function.
- Keep the Windows Media Player open. Ensure that your media file formats supported on Windows Media Player and DLNA playback devices.

- Click any of the tabs to select your preferred media file type.

### To play music:

1. Click **Music** tab.
2. Tick **Library** to view or play files.

Tick **Playlist** and select an existing playlist from the dropdown list.

3. Click a music file, and click .

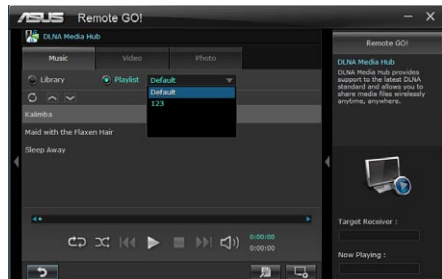

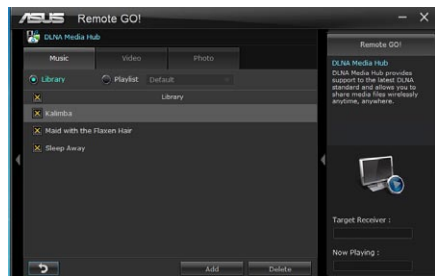

### To edit the library:

1. Tick **Library**.
2. Click  to add or delete music files.
3. Click **Add** and locate the file from the directory. To delete, tick the selected file and click **Delete**.
4. Click **OK**.



### To edit the music playlist:

1. Tick **Playlist**.
2. Click .
3. Tick to select or deselect the music file and click **Save Profile**.
4. Select the profile name and click **Save**. To add as a new playlist, key in your profile name and click **Save**.
5. To delete playlist, select the profile and click .

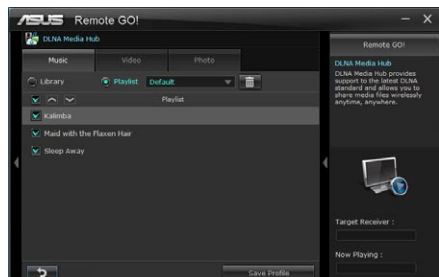

### To play a video file:

1. Click **Video** tab.
2. Tick **Library** to view the video files from your local computer. Tick **Playlist** to view the video files saved in your profile.
3. Click the video file you want to watch, and click 

Change the resolution from the **Quality** dropdown list.

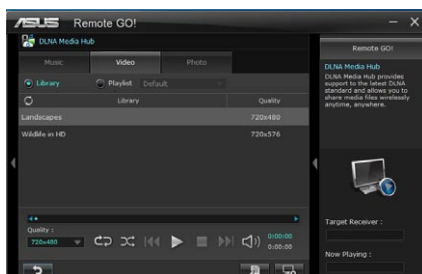

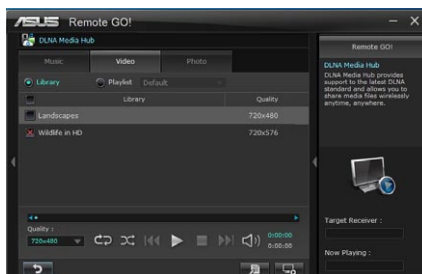

### To edit the video library:

1. Tick **Library**.
2. Click  to add or delete video files.
3. Click **Add** and locate the file from the directory. To delete, tick the selected file and click **Delete**.
4. Click **OK**.



### To edit the video playlist:

1. Tick **Playlist**.
2. Click .
3. Tick to select or deselect the video file and click **Save Profile**.
4. Select the profile name and click **Save**. To add as a new playlist, key in your profile name and click **Save**.
5. To delete playlist, select the profile and click .



## To view images:

1. Click **Photo** tab.
2. Tick **Library** to view the image files from your local computer. Tick **Playlist** to view the image files saved in your profile.

An image slideshow plays when pressing .

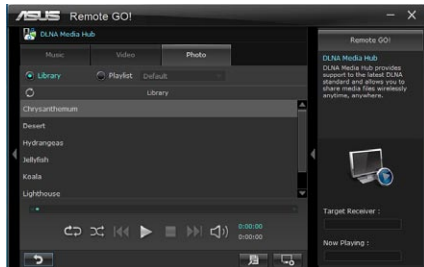

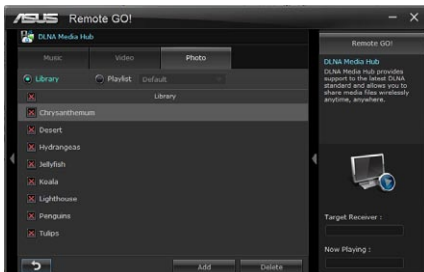

## To edit the image library:

1. Tick **Library**.
2. Click  to add or delete image files.
3. Click **Add** and locate the file from the directory. To delete, tick the selected file and click **Delete**.
4. Click **OK**.



## To edit the image playlist:

1. Tick **Playlist**.
2. Click .
3. Tick to select or deselect the image file and click **Save Profile**.
4. Select the profile name and click **Save**. To add as a new playlist, key in your profile name and click **Save**.
5. To delete playlist, select the profile and click .

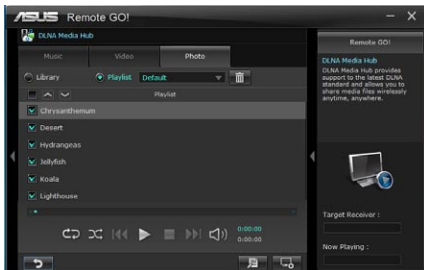

## Using the DLNA Media Hub via W-Fi GO! Remote

You can access the DLNA Media Hub on your mobile device via W-Fi GO! Remote.

1. Tap **DLNA Media Hub**.
2. Select and tap the receiver name.



3. The mobile device shows the information of the DLNA Media Hub function. Tap **Enter** to proceed to the Remote GO! function.
4. Tap **Music**, **Video** or **Photo**, to play.



Your mobile device's Wi-Fi GO! Remote interface may vary with the mobile device's operating system.

## Remote Desktop

Remote Desktop allows you to view your computer's desktop and remotely operate your computer in real-time from your mobile device.

### Using the Remote Desktop

1. From the main screen, click **Remote Desktop**.
2. Click **Setting**.



3. Select a suitable codec **Auto**, **Speed optimization**, or **Image optimization** for your mobile device.
4. Click **Apply**.



### Using the Remote Desktop via W-Fi GO! Remote

When the **Remote Desktop** is enabled, the mobile device shows the contents of your desktop.



The W-Fi GO! Remote's user interface shown above is for reference only and may vary with the mobile device's operating system.

## File Transfer

Allows you to transfer files wirelessly between your computer and mobile device.



Before using File Transfer, ensure that your computer is connected to your mobile device. For more details, refer to the section **Wi-Fi GO! Remote**.

The screenshot shows the ASUS Remote GO! File Transfer application window. It is divided into three main sections: 'Mobile Device to Desktop', 'Desktop to Mobile Device', and 'Remote GO!'. The 'Mobile Device to Desktop' section shows a path: 'C:\Users\X790LX\Documents\ASUS'. The 'Desktop to Mobile Device' section shows a path: 'Path: iSD Card: {Remote GO!}'. A red box highlights the 'Remote GO!' section, which contains an 'Application help' label. A red box highlights the 'Mobile Device to Desktop' section, with a label 'Destination path for the files transferred from mobile device to desktop'. A red box highlights the 'Desktop to Mobile Device' section, with a label 'Destination path for the files transferred from desktop to mobile device'. A red box highlights a 'Back' button, with a label 'Click to go back to main menu'. A red box highlights a 'Browse' button, with a label 'Click to select a destination path for your file transfer'.



- Android mobile devices can send and receive files.
- iOS mobile devices can only send files.

## Using File Transfer

1. Right-click the file and click **Send to > [Device name]**.
2. After the transfer is complete, click **OK**.

## Using File Transfer via W-Fi GO! Remote

1. On your mobile device, tap **File Transfer**.
2. Tap **Enable** to receive files from PC.
3. Tap **Enter** to send files to PC.





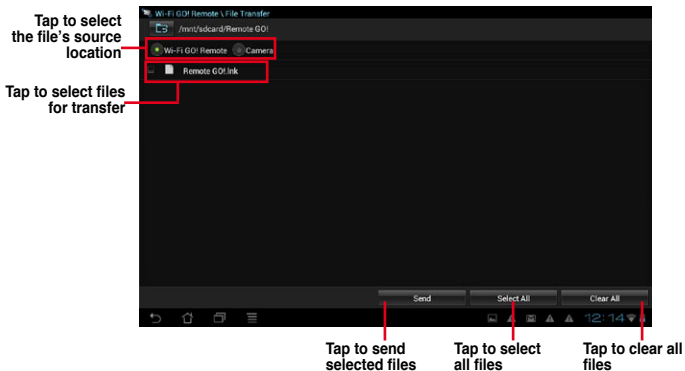

The Wi-Fi GO! Remote's user interface shown above is for reference only and may vary with the mobile device's operating system.

## Securing your computer for Wi-Fi GO! Remote functions

Remote GO! Settings allows you to create a password for your computer.

To create a password:

1. Click  in the main menu.
2. Tick **Use Password** and key in your password.
3. Click **Apply**.



- When you launch the Wi-Fi GO! Remote, the application prompts you to key in the computer's password.
- Your password must contain 6-12 letters or numbers.

## 4.3.6 USB 3.0 Boost

ASUS USB 3.0 Boost technology supports UASP (USB Attached SCSI Protocol) and automatically increases a USB 3.0 device's transfer speed up to 170%.

### Launching USB 3.0 Boost

To launch USB 3.0 Boost, click **Tool > USB 3.0 Boost** on the AI Suite II main menu bar.

### Configuring USB 3.0 Boost

1. Connect a USB 3.0 device to the USB 3.0 port.

USB 3.0 Boost automatically detects the property of the USB 3.0 device and switches to **Turbo** mode or **UASP** mode (if UASP is supported by the USB 3.0 device).

2. You can manually switch the USB 3.0 mode back to **Normal** mode at any time.

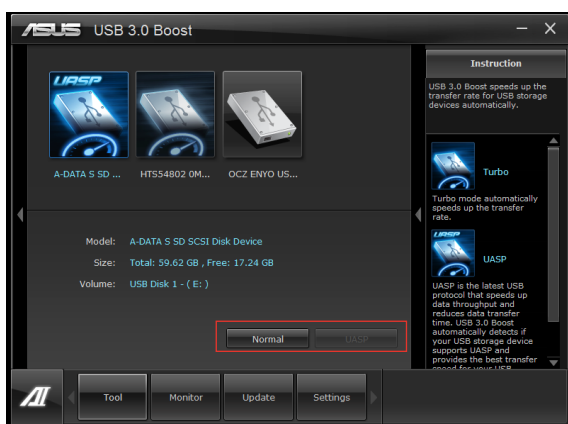

- Refer to the software manual in the support DVD or visit the ASUS website at [www.asus.com](http://www.asus.com) for detailed software configuration.
- Use the USB 3.0 devices for high performance. The data transfer speed varies with USB devices.

## 4.3.7 Network iControl

ASUS Network iControl is an intuitive one-stop network control center that makes it easier for you to manage your network bandwidth and allows you to set, monitor, and schedule the bandwidth priorities for your network programs. It also allows you to automatically connect to a PPPoE for a more convenient online experience.

To launch Network iControl, click **Tool > Network iControl** from AI Suite II main menu bar.



- Ensure to install the LAN drivers before using this function.
- Network iControl is only supported under Windows® 7 and can only support the onboard LAN.

### Using EZ Start

EZ Start allows you to quickly activate Network iControl, and set the highest bandwidth priority for your top currently running program.

**To use EZ Start:**

1. Click the EZ Start tab.
2. Click **ON/OFF** to enable/disable Network iControl.



- By default, Network iControl is set to **ON**.
- When switched off, the **Quick Connection**, **EZ Profile**, and **Info** are disabled.
- You may monitor the bandwidth priority from your desktop's taskbar.

3. Select a profile and click **Apply**.



Tick **Set current network program as the highest priority** to set the top network program as the highest priority.

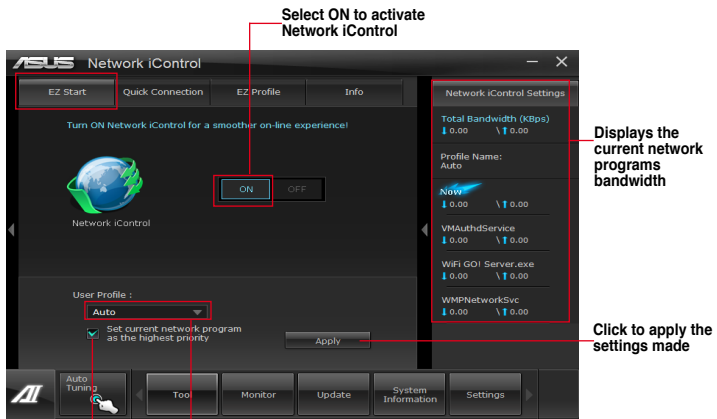

Tick to enable the current network program in use as the highest priority

Click to select a profile

Click to apply the settings made

Displays the current network programs bandwidth

Select ON to activate Network iControl

Click ON to activate Network iControl

## Using Quick Connection

### Configuring the PPPoE connection settings

Before enabling the Network iControl's **Quick Connection** functions, you must configure the PPPoE connection settings

To configure the PPPoE settings:

1. Right-click  in the taskbar, and select **Open Network and Sharing Center**.

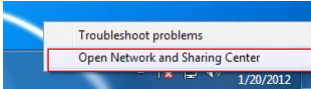

2. Right-click the PPPoE Connection, and select **Properties**.

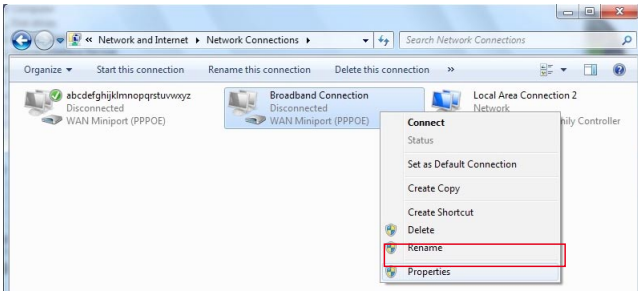

3. Click the **Options** tab, and deselect **Prompt for name and password, certificate, etc.** Click **OK** to complete the auto PPPoE connection settings.

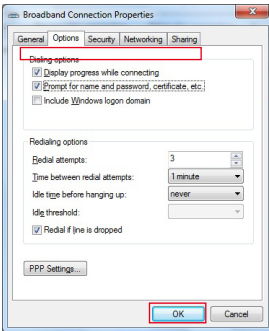

- You only need to configure the PPPoE connection settings once.
- Obtain the necessary information about your PPPoE connection from your network provider.

## Configuring the Quick Connection

To configure the auto-PPPoE connection:

1. Click the **Quick Connection** tab.
2. Tick **Automatically connect online anytime** option, then select the connection name in the **Connection Name** dropdown box.
3. Click **Apply** to enable the PPPoE automatic network connection.



Click to select Connection Name

Click to set the auto PPPoE connection





Click to apply settings

Click ON to improve network performance

## Using EZ Profile

### To use the EZ Profile:

EZ Profile allows you to load, edit, and save your own network program priority profile.

1. Click the **EZ Profile** tab. The programs are shown in the network program column.
2. Select the network program, and click  to create your profile.
3. Click  to save the changes and/or rename your profile.
4. Click , , or  to set the program priority as High, Normal, or Low.

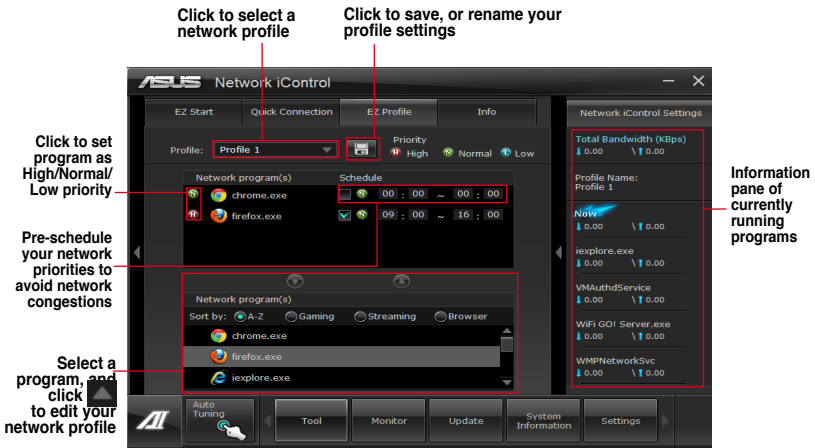

### 4.3.8 USB BIOS Flashback Wizard

USB BIOS Flashback allows you to easily update the BIOS without entering the BIOS or operating system. Just connect the USB storage device containing the BIOS file to the USB port, press the BIOS Flashback button, and the BIOS is updated automatically.

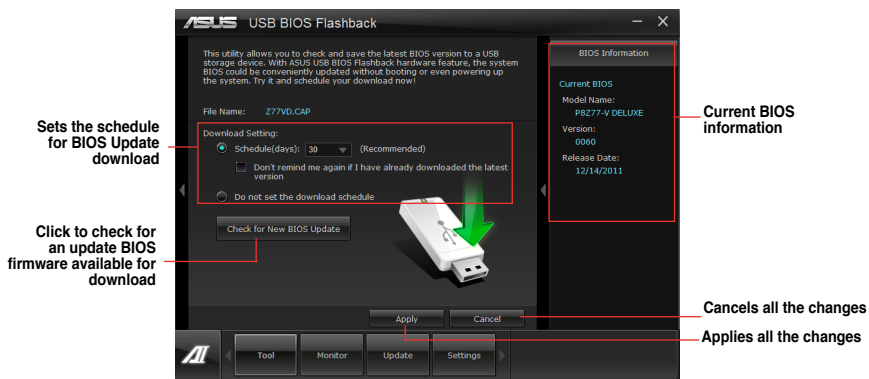

#### Scheduling the latest BIOS download

1. In the **Download Setting** field, tick **Schedule (days)** and select the number of days for your download schedule.
2. Click **Apply** to save the BIOS download schedule. Click **Cancel** to cancel the changes made.

#### Downloading the updated BIOS



Before you start downloading, ensure that you have installed the USB storage device to your computer's USB port.

1. Click **Check for New BIOS Update** to check for the latest BIOS version.

Wait for the system to check the latest BIOS firmware.

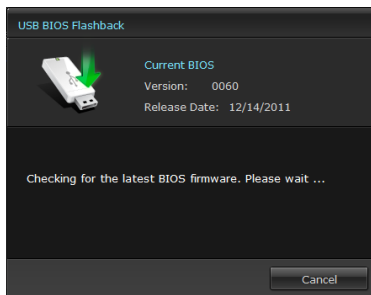

- From the **Save to** dropdown list, select the USB storage device that you want to save the BIOS file to, then click **Download**.

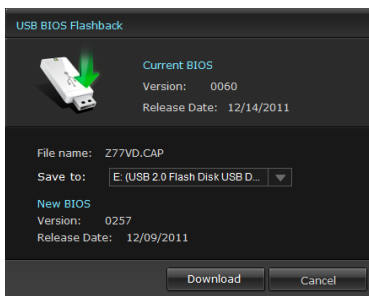

- When the download process is completed, click **OK** to exit.





### 4.3.9 FAN Xpert

Fan Xpert intelligently allows you to adjust both the CPU and chassis fan speeds according to different ambient temperatures caused by different climate conditions in different geographic regions and your PC's system loading. The built-in variety of useful profiles offer flexible controls of fan speed to achieve a quiet and cool environment.

#### Launching FAN Xpert

After installing AI Suite II from the motherboard support DVD, launch FAN Xpert by clicking **Tool > Fan Xpert** on the AI Suite II main menu bar.

#### Using FAN Xpert

Click **Fan Name** to select a fan and then click **Setting** to select a preset mode for your selected fan.

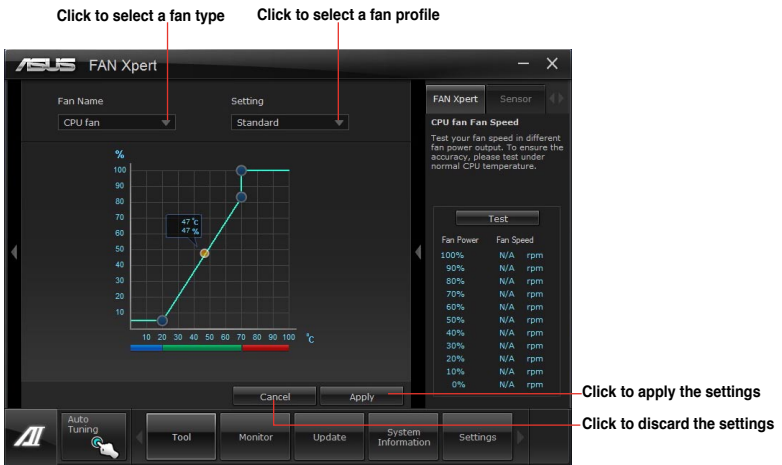

#### Fan setting

- **Disable:** disables the **Fan Xpert** function.
- **Standard:** adjusts fan speed in a moderate pattern.
- **Silent:** minimizes fan speed for quiet fan operation.
- **Turbo:** maximizes the fan speed for the best cooling effect.
- **User:** Allows you to configure the CPU fan profile under certain limitations.

## 4.3.10 Ai Charger+

This utility allows you to fast-charge your portable BC 1.1\* mobile devices on your computer's USB port three times faster than the standard USB devices\*\*.



- \* Check your manufacturer if your USB device is a Battery Charging Specification 1.1 (BC 1.1) compliant or compatible device.
- \*\* Actual charging speeds may vary depending on the charging rate and specifications of your USB device.
- To ensure normal charging function, disconnect and reconnect your USB device every time you enable or disable Ai Charger+.



### 4.3.11 Probe II

Probe II is a utility that monitors the computer's vital components, and detects and alerts you of any problem with these components. Probe II senses fan rotations, CPU temperature, and system voltages, among others. With this utility, you are assured that your computer is always at a healthy operating condition.

#### Launching Probe II

To launch Probe II, click **Tool > Probe II** on the AI Suite II main menu bar.

#### Configuring Probe II

Click the Voltage/Temperature/Fan Speed tabs to activate the sensors or to adjust the sensor threshold values. The Preference tab allows you to customize the time interval of sensor alerts, or change the temperature unit.

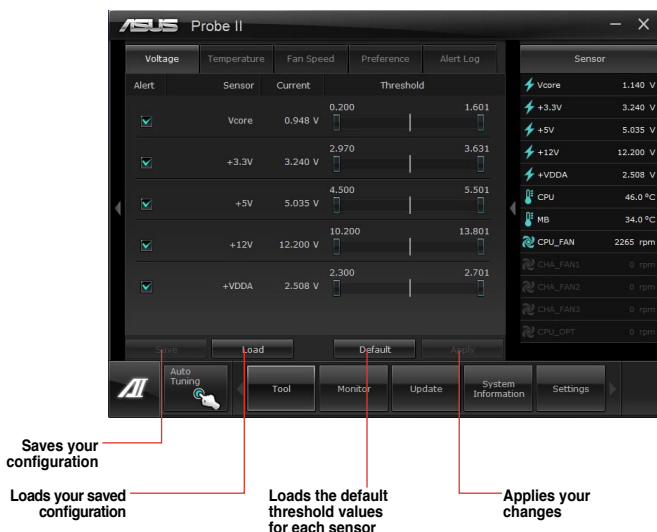

- Click Monitor > Sensor on the AI Suite II main menu bar and the system status will appear on the right panel.
- Refer to the software manual in the support DVD or visit the ASUS website at [www.asus.com](http://www.asus.com) for detailed software configuration.

## 4.3.12 Sensor Recorder

Sensor Recorder monitors the changes in the system voltage, temperature, and fan speed on a timeline. The History Record function allows you to designate specific time spans on record to keep track of the three system statuses for certain purposes.

### Launching Sensor Recorder

To launch Sensor Recorder, click **Tool > Sensor Recorder** on the AI Suite II main menu bar.

### Using Sensor Recorder

Click on Voltage/ Temperature/ Fan Speed tabs for the status you want to monitor. Colored lines will automatically appear on the diagram to indicate the immediate changes in the system status.

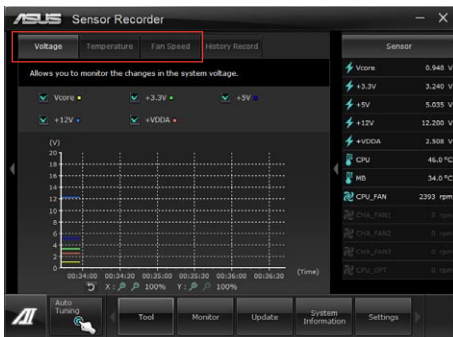

## Using History Record

1. Click the **History Record** tab and adjust the settings on the left for **Record Interval** and **Record Duration** according to need.
2. Click **Start Recording** to start measuring and recording each sensor.
3. To stop recording, click **Recording** again.
4. To track the recorded contents, set **Type/ Date/ Select display items** to display the history details.

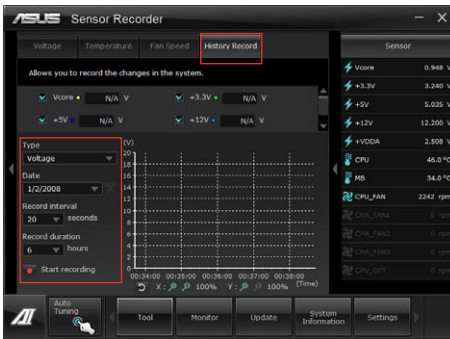

Click **Monitor > Sensor** on the AI Suite II main menu bar and the system status will appear on the right panel.

### 4.3.13 ASUS Update

ASUS Update is a utility that allows you to manage, save, and update the motherboard BIOS in Windows® environment.

#### Launching ASUS Update

To launch ASUS Update, click **Update > ASUS Update** on the AI Suite II main menu bar.

#### Using ASUS Update

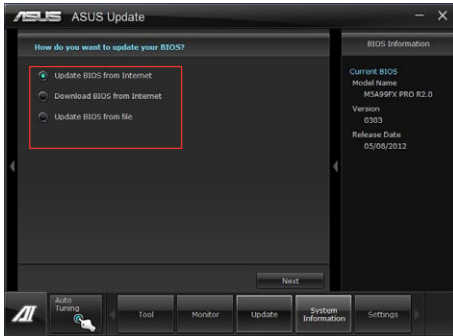

Select any of these options to update the BIOS:

- **Update BIOS from Internet**  
Allows you to download the latest BIOS version from the ASUS website at [www.asus.com](http://www.asus.com) and follow the onscreen instructions to update the BIOS.
- **Download BIOS from Internet**  
Download the latest BIOS version from the ASUS website at [www.asus.com](http://www.asus.com) and save it for later use.
- **Update BIOS from file**  
Use the BIOS file that you had downloaded and saved to update the system BIOS.
- **Save BIOS to file**  
Save the BIOS file to another file or a USB storage device for later use.



Updating the BIOS poses some risks such as system instability or failure to boot. Before updating the BIOS, ensure that you back up the original BIOS file.

## 4.3.14 MyLogo2

MyLogo2 allows you to customize the boot logo, which is the image that appears on the screen during the Power On Self Tests (POST).

### Launching MyLogo2

To launch MyLogo2, click **Update > MyLogo** on the AI Suite II main menu bar.

### Using MyLogo

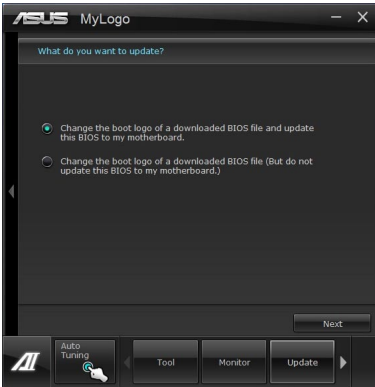

Select the option that you want to use to update your boot logo, click **Next** and follow the instructions below.

### Change the boot logo of a downloaded BIOS file and update (or do not update) this BIOS to the motherboard

1. From the **BIOS file** field, click **Browse** to locate the BIOS file.
2. From the **Picture File** field, click **Browse the image for your boot logo**, then click **Next**.

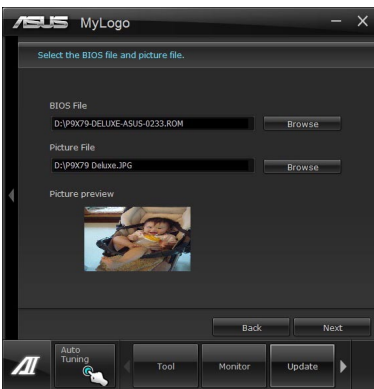

3. Do any of the following:
  - Click **Auto Tune** to adjust the image size or the image resolution.
  - Click **Booting Preview** to preview the boot image.
4. Click **Next**.

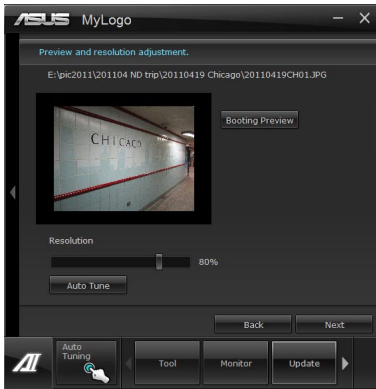

5. Click **Flash** to update the boot logo.
6. When prompted, click **Yes** to reboot the system. You will see the new boot logo the next time you start up the system.



---

Ensure to enable the **Full Screen Logo** in BIOS to use this feature.

---



### 4.3.15 Audio configurations

The Realtek® audio CODEC provides 8-channel audio capability to deliver the ultimate audio experience on your computer. The software provides Jack-Sensing function, S/PDIF Out support, and interrupt capability. The CODEC also includes the Realtek® proprietary UAJ® (Universal Audio Jack) technology for all audio ports, eliminating cable connection errors and giving users plug and play convenience.

Follow the installation wizard to install the Realtek® Audio Driver from the support DVD that came with the motherboard package.

If the Realtek audio software is correctly installed, you will find the **Realtek HD Audio Manager** icon on the taskbar. Double-click on the icon to display the Realtek HD Audio Manager.

#### A. Realtek HD Audio Manager with DTS UltraPC II for Windows® 7™ / Vista™



## B. Realtek HD Audio Manager for Windows XP



- DTS UltraPC II and DTS Connect only support Windows 7/Vista operating systems.
- Refer to the software manual in the support DVD or visit the ASUS website at [www.asus.com](http://www.asus.com) for detailed software configuration.

# RAID support

# 5

## 5.1 RAID configurations

The motherboard comes with the AMD® SB950 chipset that allows you to configure Serial ATA hard disk drives as RAID sets. The motherboard supports the following RAID configurations: RAID 0, RAID 1, RAID 5 and RAID 10.



- 
- You must install Windows® XP Service Pack 3 or later versions before using Serial ATA hard disk drives. The Serial ATA RAID feature is available only if you are using Windows® XP SP3 or later versions.
  - Due to Windows® XP limitation, a RAID array with the total capacity over 2TB cannot be set as a boot disk. A RAID array over 2TB can only be set as a data disk only.
  - If you want to install a Windows® operating system to a hard disk drive included in a RAID set, you have to create a RAID driver disk and load the RAID driver during OS installation. Refer to section 5.2 **Creating a RAID driver disk** for details.
- 

### 5.1.1 RAID definitions

**RAID 0 (Data striping)** optimizes two identical hard disk drives to read and write data in parallel, interleaved stacks. Two hard disks perform the same work as a single drive but at a sustained data transfer rate, double that of a single disk alone, thus improving data access and storage. Use of two new identical hard disk drives is required for this setup.

**RAID 1 (Data mirroring)** copies and maintains an identical image of data from one drive to a second drive. If one drive fails, the disk array management software directs all applications to the surviving drive as it contains a complete copy of the data in the other drive. This RAID configuration provides data protection and increases fault tolerance to the entire system. Use two new drives or use an existing drive and a new drive for this setup. The new drive must be of the same size or larger than the existing drive.

**RAID 5** stripes both data and parity information across three or more hard disk drives. Among the advantages of RAID 5 configuration include better HDD performance, fault tolerance, and higher storage capacity. The RAID 5 configuration is best suited for transaction processing, relational database applications, enterprise resource planning, and other business systems. Use a minimum of three identical hard disk drives for this setup.

**RAID 10** is data striping and data mirroring combined without parity (redundancy data) having to be calculated and written. With the RAID 10 configuration you get all the benefits of both RAID 0 and RAID 1 configurations. Use four new hard disk drives or use an existing drive and three new drives for this setup.

## 5.1.2 Installing Serial ATA hard disks

The motherboard supports Serial ATA hard disk drives. For optimal performance, install identical drives of the same model and capacity when creating a disk array.

### To install the SATA hard disks for a RAID configuration:

1. Install the SATA hard disks into the drive bays.
2. Connect the SATA signal cables.
3. Connect a SATA power cable to the power connector on each drive.

## 5.1.3 Setting the RAID item in BIOS

You must enable the RAID function in the BIOS Setup before creating RAID sets using SATA HDDs. To do this:

1. Enter the BIOS Setup during POST.
2. Go to the **Advanced** menu > **SATA Configuration**, and then press <Enter>.
3. Set the SATA Mode item to [RAID Mode].
4. Save your changes, and then exit the BIOS Setup.



---

Refer to Chapter 3 for details on entering and navigating through the BIOS Setup

---



---

Due to chipset limitation, when SATA ports are set to RAID mode, all SATA ports run at RAID mode together.

---

## 5.1.4 AMD® Option ROM utility

To enter the AMD® Option ROM utility:

1. Turn on the system.
2. During POST, press <Ctrl> + <F> to display the utility main menu.

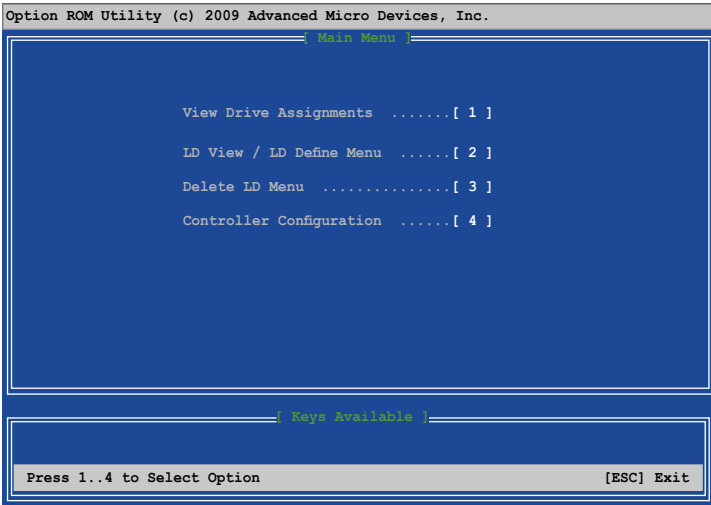

The Main Menu allows you to select an operation to perform. The Main Menu options include:

- **View Drive Assignments:** shows the status of the hard disk drives.
- **LD View / LD Define Menu:** displays the existing RAID set information / creates a RAID 0, RAID 1, RAID 5 or RAID 10 configuration.
- **Delete LD Menu:** deletes a selected RAID set and partition.
- **Controller Configuration:** shows the system resources configuration.

Press <1>, <2>, <3>, or <4> to enter the option you need; press <ESC> to exit the utility.



The RAID BIOS setup screens shown in this section are for reference only and may not exactly match the items on your screen.



The utility supports maximum four hard disk drives for RAID configuration.

## Creating a RAID volume

To create a RAID volume:

1. In the Main Menu, press <2> to enter the **LD View / LD Define Menu** function.
2. Press <Ctrl> + <C>, and the following screen appears.

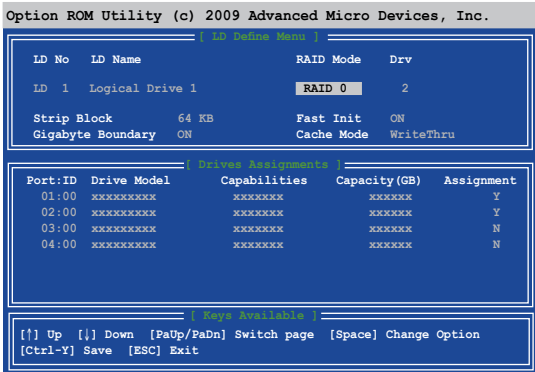

3. Move to the **RAID Mode** item and press <Space> to select a RAID mode to create.
4. Move to the **Assignment** item by using the down arrow key and set **Y** to select the hard disk drives you want to include in the RAID set.
5. Press <Ctrl> + <Y> to save the setting.
6. The utility prompts the following message. Press <Ctrl> + <Y> to input the LD name.

```
Please press Ctrl-Y key to input the LD Name
or press any key to exit.
If you do not input any LD name, the default LD
name will be used.
```

7. Enter an LD name, and then press any key to continue.

```
Enter the LD name here:
```

8. Press <Ctrl> + <Y> to erase the MBR, or you may press any key to abort the settings.

```
Fast Initialization Option has been selected
It will erase the MBR data of the disks.
<Press Ctrl-Y Key if you are sure to erase it>
<Press any other key to ignore this option>
```

9. Press <Ctrl> + <Y> to enter the screen to modify the array capacity, or press any key to use the maximum capacity.

## Deleting a RAID configuration



Take caution when deleting a RAID volume. You will lose all data on the hard disk drives when you delete a RAID volume.

To delete a RAID volume:

1. In the Main Menu, press <3> to enter the **Delete LD** function.
2. Select the RAID item you want to delete and press <Del> or <Alt> + <D>.

```
Option ROM Utility (c) 2009 Advanced Micro Devices, Inc.
[ Delete LD Menu ]
LD No      RAID Mode  Drv      Capacity(GB)  Status
LD 1       RAID 0      2        xxxxxx        Functional

[ Keys Available ]
[{} Up [{} Down [PaUp/PaDn] Switch page [Del/Alt+D] Delete LD
```

3. The utility prompts the following messages:

```
Press Ctrl-Y to delete the data in the disk!
or press any other key to abort...
```

Press <Ctrl> + <Y> to delete the RAID volume.

## Displaying a RAID set information

To display a RAID set information:

1. In the Main Menu, press <2> to enter the “LD View / LD Define Menu” function.
2. Select a RAID item and press <Enter> to display its information.

```
Option ROM Utility (c) 2009 Advanced Micro Devices, Inc.
[ View LD Definition Menu ]
LD No  LD Name      RAID Mode  Drv  Capacity(GB)
LD 1   xxxxxx      RAID 0     2    157.99
Strip Block      64 KB      Cache Mode  WriteThru

[ Drives Assignments ]
Port:ID  Drive Model  Capabilities  Capacity(GB)
01:00   xxxxxxxxxx  xxxxxxxx     xxxxxx
02:00   xxxxxxxxxx  xxxxxxxx     xxxxxx

Any Key To Continue.....
```

## 5.2 Creating a RAID driver disk

A floppy disk with the RAID driver is required when installing a Windows® operating system on a hard disk drive that is included in a RAID set.



- 
- The motherboard does not provide a floppy drive connector. You have to use a USB floppy disk drive when creating a SATA RAID driver disk.
  - Windows® XP may not recognize the USB floppy disk drive due to Windows® XP limitation. To work around this OS limitation, refer to section 5.2.4 Using a USB floppy disk drive.
- 

### 5.2.1 Creating a RAID driver disk without entering the OS

To create a RAID driver disk without entering the OS:

1. Boot your computer.
2. Press <Del> during POST to enter the BIOS setup utility.
3. Set the optical drive as the primary boot device.
4. Insert the support DVD into the optical drive.
5. Save changes and exit BIOS.
6. When the Make Disk menu appears, press <1> to create a RAID driver disk.
7. Insert a formatted floppy disk into the USB floppy disk drive, then press <Enter>.
8. Follow the succeeding screen instructions to complete the process.

### 5.2.2 Creating a RAID driver disk in Windows®

To create a RAID driver disk in Windows®:

1. Start Windows®.
2. Plug the USB floppy disk drive and insert a floppy disk.
3. Place the motherboard support DVD into the optical drive.
4. Go to the **Make Disk** menu, and then click **AMD AHCI/RAID 32/64bit xxxx Driver** to create a RAID driver disk.
5. Select **USB floppy disk drive** as the destination disk.
6. Follow the succeeding screen instructions to complete the process.



---

Write-protect the floppy disk to avoid a computer virus infection.

---



## 5.2.3 Installing the RAID driver during Windows® OS installation

### To install the RAID driver in Windows® XP:

1. During the OS installation, the system prompts you to press the <F6> key to install third-party SCSI or RAID driver.
2. Press <F6>, and then insert the floppy disk with RAID driver into the USB floppy disk drive.
3. When prompted to select the SCSI adapter to install, select the RAID driver for the corresponding OS version.
4. Follow the succeeding screen instructions to complete the installation.

### To install the RAID driver for Windows® Vista or later OS:

1. During the OS installation, click **Load Driver** to allow you to select the installation media containing the RAID driver.
2. Insert the USB flash drive with RAID driver into the USB port or the support DVD into the optical drive, and then click **Browse**.
3. Click the name of the device you've inserted, go to **Drivers > RAID**, and then select the RAID driver for the corresponding OS version. Click **OK**.
4. Follow the succeeding screen instructions to complete the installation.



---

Before loading the RAID driver from a USB flash drive, you have to use another computer to copy the RAID driver from the support DVD to the USB flash drive.

---

## 5.2.4 Using a USB floppy disk drive

Due to OS limitation, Windows® XP may not recognize the USB floppy disk drive when you install the RAID driver from a floppy disk during the OS installation.

To solve this issue, add the USB floppy disk drive's Vendor ID (VID) and Product ID (PID) to the floppy disk containing the RAID driver. Refer to the steps below:

- Using another computer, plug the USB floppy disk drive, and insert the floppy disk containing the RAID driver.

- Right-click **My Computer** on the Windows® desktop or start menu, and then select **Manage** from the pop-up window.

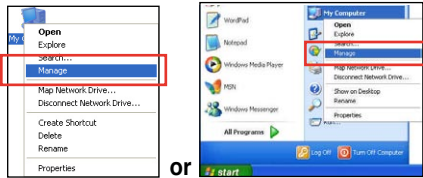

- Select **Device Manager**. From the **Universal Serial Bus controllers**, right-click **xxxxxx USB Floppy**, and then select **Properties** from the pop-up window.



The name of the USB floppy disk drive varies with different vendors.

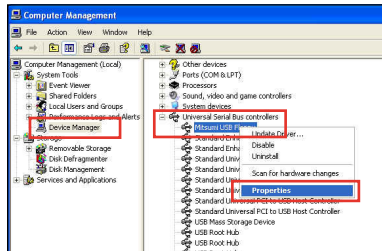

- Click **Details** tab. The Vendor ID (VID) and Product ID (PID) are displayed.

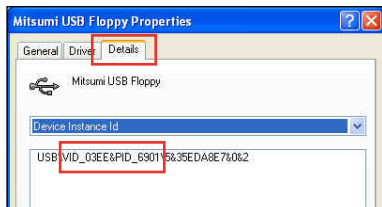

- Browse the contents of the RAID driver disk to locate the file **txtsetup.oem**.

- Double-click the file. A window appears, allowing you to select the program for opening the oem file.

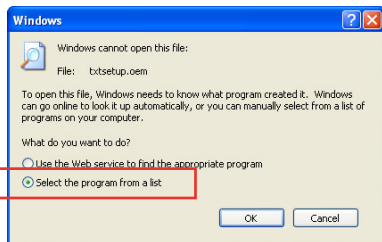

7. Use Notepad to open the file.

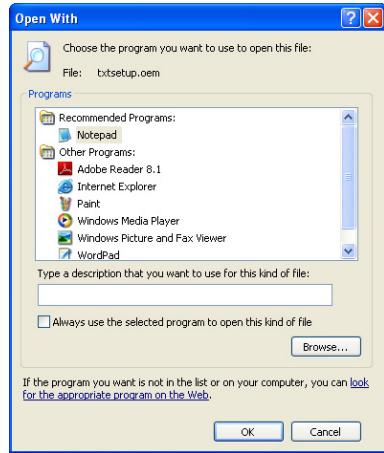

8. Find the [HardwareIds.SCSI.Napa\_i386\_ahci8086] and [HardwareIds.SCSI.Napa\_ amd64\_ahci] sections in the txtsetup.oem file.
9. Type the following line to the bottom of the two sections:

**id = "USB\VID\_xxxx&PID\_ xxxx", "usbstor"**

```
[HardwareIds.SCSI.Napa_i386_ahci8086]
id= "PCI\VEN_1002&DEV_4392&CC_0104", "ahci86"
id= "PCI\VEN_1002&DEV_4391&CC_0106", "ahci86"
id= "PCI\VEN_1002&DEV_4393&CC_0104", "ahci86"
id= "USB\VID_03EE&PID_6901", "usbstor"

[HardwareIds.SCSI.Napa_ amd64_ahci]
id= "PCI\VEN_1002&DEV_4392&CC_0104", "ahci64"
id= "PCI\VEN_1002&DEV_4391&CC_0106", "ahci64"
id= "PCI\VEN_1002&DEV_4393&CC_0104", "ahci64"
id= "USB\VID_03EE&PID_6901", "usbstor"
```



Add the same line to both sections.



The VID and PID vary with different vendors.

10. Save and exit the file.



# Multiple GPU support

# 6

## 6.1 AMD® CrossFireX™ technology

The motherboard supports the AMD® CrossFireX™ technology that allows you to install multi-graphics processing units (GPU) graphics cards. Follow the installation procedures in this section.

### 6.1.1 Requirements

- In Dual CrossFireX mode, you should have two identical CrossFireX-ready graphics cards or one CrossFireX-ready dual-GPU graphics card that are AMD® certified.
- Ensure that your graphics card driver supports the AMD CrossFireX technology. Download the latest driver from the AMD website ([www.amd.com](http://www.amd.com)).
- Ensure that your power supply unit (PSU) can provide at least the minimum power required by your system. See Chapter 1 for details.



- 
- We recommend that you install additional chassis fans for better thermal environment.
  - Visit the AMD Game website (<http://game.amd.com>) for the latest certified graphics card and the supported 3D application list.
- 

### 6.1.2 Before you begin

For AMD CrossFireX to work properly, you have to uninstall all existing graphics card drivers before installing AMD CrossFireX graphics cards to your system.

#### To uninstall existing graphics card drivers:

1. Close all current applications.
2. For Windows XP, go to **Control Panel > Add/Remove Programs**.  
For Windows 7, go to **Control Panel > Programs and Features**.
3. Select your current graphics card driver/s.
4. For Windows XP, select **Add/Remove**.  
For Windows 7, select **Uninstall**.
5. Turn off your computer.

## 6.1.3 Installing two CrossFire™ graphics cards



The following pictures are for reference only. The graphics cards and the motherboard layout may vary with models, but the installation steps remain the same.

1. Prepare two CrossFireX-ready graphics cards.

2. Insert the two graphics card into the PCIEX16 slots. If your motherboard has more than two PCIEX16 slots, refer to Chapter 1 in this user manual for the locations of the PCIEX16 slots recommended for multi-graphics card installation.

3. Ensure that the cards are properly seated on the slots.

4. Align and firmly insert the CrossFireX bridge connector to the goldfingers on each graphics card. Ensure that the connector is firmly in place.

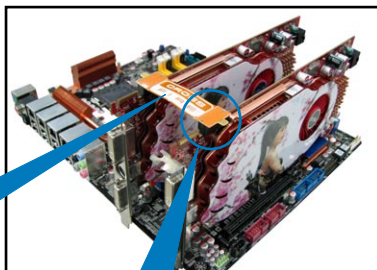
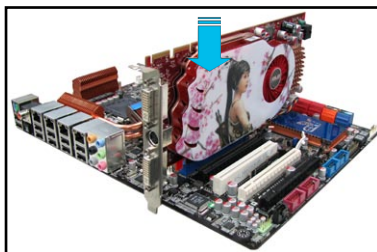

CrossFireX bridge  
(bundled with  
graphics cards)

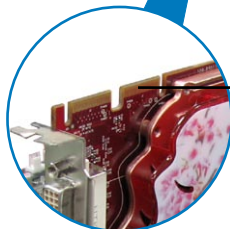

Goldfingers

5. Connect two independent auxiliary power sources from the power supply to the two graphics cards separately.
6. Connect a VGA or a DVI cable to the graphics card.

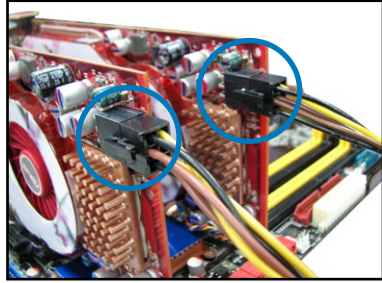

## 6.1.4 Installing the device drivers

Refer to the documentation that came with your graphics card package to install the device drivers.



---

Ensure that your PCI Express graphics card driver supports the AMD® CrossFireX™ technology. Download the latest driver from the AMD website ([www.amd.com](http://www.amd.com)).

---

## 6.1.5 Enabling the AMD® CrossFireX™ technology

After installing your graphics cards and the device drivers, enable the CrossFireX™ feature through the AMD VISION Engine Control Center in Windows environment.

### Launching the AMD VISION Engine Control Center

To launch the AMD VISION Engine Control Center:

1. Right-click on the Windows® desktop and select **AMD VISION Engine Control Center**.

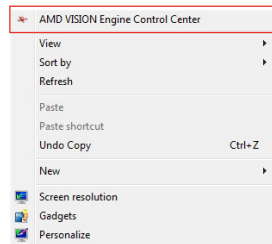

## Enabling Dual CrossFireX technology

1. In the AMD VISION Engine Control Center window, click **Performance > AMD CrossFireX™**.
2. Select **Enable CrossFireX™**.
3. Select a GPU combination from the drop-down list.
4. Click **Apply** to save and activate the GPU settings made.

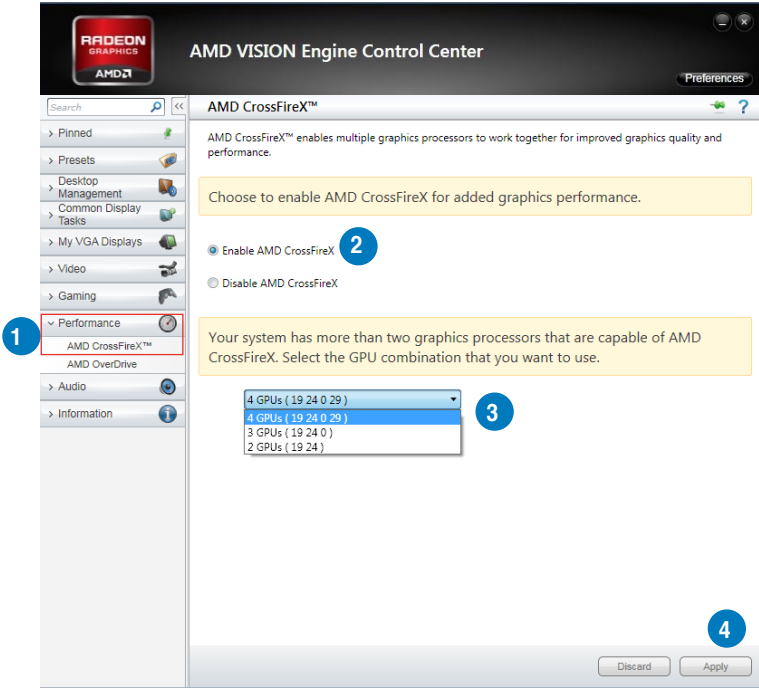



## 6.2 NVIDIA® SLI™ technology

The motherboard supports the NVIDIA® SLI™ (Scalable Link Interface) technology that allows you to install multi-graphics processing units (GPU) graphics cards. Follow the installation procedures in this section.

### 6.2.1 Requirements

- In SLI mode, you should have two identical SLI-ready graphics cards that are NVIDIA® certified.
- Ensure that your graphics card driver supports the NVIDIA SLI technology. Download the latest driver from the NVIDIA website at [www.nvidia.com](http://www.nvidia.com).
- Ensure that your power supply unit (PSU) can provide at least the minimum power required by your system.



- We recommend that you install additional chassis fans for better thermal environment.
- Visit the NVIDIA zone website (<http://www.nzone.com>) for the latest certified graphics card and supported 3D application list.

### 6.2.2 Installing two SLI-ready graphics cards



The following pictures are for reference only. The graphics cards and the motherboard layout may vary with models, but the installation steps remain the same.

1. Prepare two SLI-ready graphics cards.
2. Insert the two graphics card into the PCIEX16 slots. If your motherboard has more than two PCIEX16 slots, refer to Chapter 2 in this user manual for the locations of the PCIEX16 slots recommended for multi-graphics card installation.
3. Ensure that the cards are properly seated on the slots.

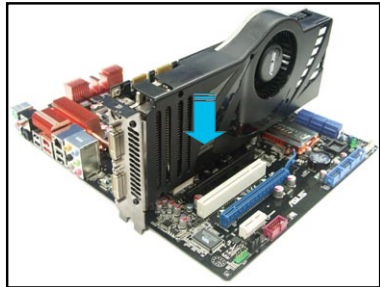

4. Align and firmly insert the SLI bridge connector to the goldfingers on each graphics card. Ensure that the connector is firmly in place.
5. Connect two independent auxiliary power sources from the power supply to the two graphics cards separately.
6. Connect a VGA or a DVI cable to the graphics card.

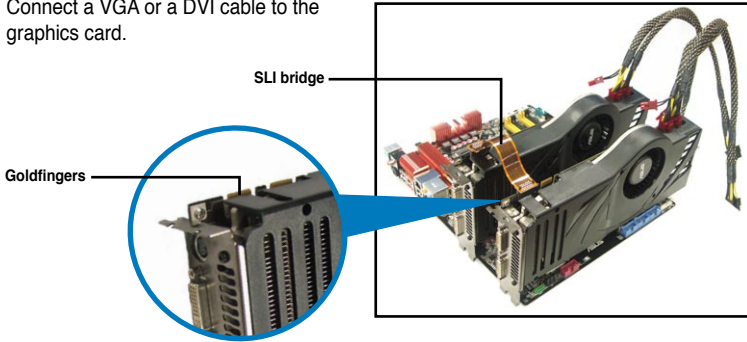

### 6.2.3 Installing the device drivers

Refer to the documentation that came with your graphics card package to install the device drivers.



---

Ensure that your PCI Express graphics card driver supports the NVIDIA® SLI™ technology. Download the latest driver from the NVIDIA website ([www.nvidia.com](http://www.nvidia.com)).

---

## 6.2.4 Enabling the NVIDIA® SLI™ technology

After installing your graphics cards and the device drivers, enable the SLI feature in NVIDIA® Control Panel under the Windows® 7 operating system.

### Launching the NVIDIA Control Panel

You can launch the NVIDIA Control Panel by the following two methods.

- A. Right click on the empty space of the Windows® desktop and select **NVIDIA Control Panel**.

The NVIDIA Control Panel window appears.

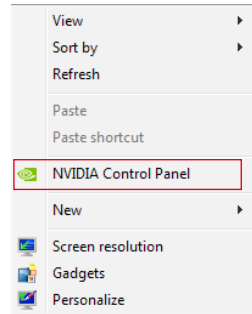

- B. The NVIDIA Control Panel window appears.

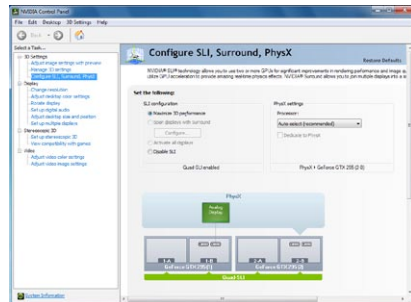

### Enabling SLI settings

From the NVIDIA Control Panel window, select **Configure SLI, Surround, PhysX**. In the **Quad-SLI enabled**, click **Maximize 3D Performance SLI** to set the display for viewing SLI rendered content. When done, click **Apply**.

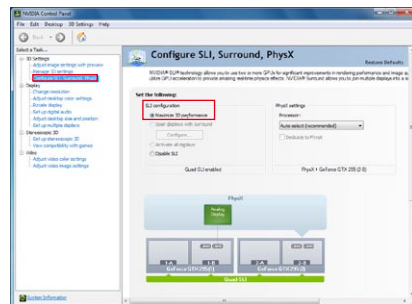



# Appendices

## Notices

### Federal Communications Commission Statement

This device complies with Part 15 of the FCC Rules. Operation is subject to the following two conditions:

- This device may not cause harmful interference.
- This device must accept any interference received including interference that may cause undesired operation.

This equipment has been tested and found to comply with the limits for a Class B digital device, pursuant to Part 15 of the FCC Rules. These limits are designed to provide reasonable protection against harmful interference in a residential installation. This equipment generates, uses and can radiate radio frequency energy and, if not installed and used in accordance with manufacturer's instructions, may cause harmful interference to radio communications. However, there is no guarantee that interference will not occur in a particular installation. If this equipment does cause harmful interference to radio or television reception, which can be determined by turning the equipment off and on, the user is encouraged to try to correct the interference by one or more of the following measures:

- Reorient or relocate the receiving antenna.
- Increase the separation between the equipment and receiver.
- Connect the equipment to an outlet on a circuit different from that to which the receiver is connected.
- Consult the dealer or an experienced radio/TV technician for help.



---

The use of shielded cables for connection of the monitor to the graphics card is required to assure compliance with FCC regulations. Changes or modifications to this unit not expressly approved by the party responsible for compliance could void the user's authority to operate this equipment.

---

## IC: Canadian Compliance Statement

Complies with the Canadian ICES-003 Class B specifications. This device complies with RSS 210 of Industry Canada. This Class B device meets all the requirements of the Canadian interference-causing equipment regulations.

This device complies with Industry Canada license exempt RSS standard(s). Operation is subject to the following two conditions: (1) this device may not cause interference, and (2) this device must accept any interference, including interference that may cause undesired operation of the device.

Cet appareil numérique de la Classe B est conforme à la norme NMB-003 du Canada. Cet appareil numérique de la Classe B respecte toutes les exigences du Règlement sur le matériel brouilleur du Canada.

Cet appareil est conforme aux normes CNR exemptes de licence d'Industrie Canada. Le fonctionnement est soumis aux deux conditions suivantes :

- (1) cet appareil ne doit pas provoquer d'interférences et
- (2) cet appareil doit accepter toute interférence, y compris celles susceptibles de provoquer un fonctionnement non souhaité de l'appareil.

## Canadian Department of Communications Statement

This digital apparatus does not exceed the Class B limits for radio noise emissions from digital apparatus set out in the Radio Interference Regulations of the Canadian Department of Communications.

This class B digital apparatus complies with Canadian ICES-003.

## VCCI: Japan Compliance Statement

### VCCI Class B Statement

情報処理装置等電波障害自主規制について

この装置は、情報処理装置等電波障害自主規制協議会（VCCI）の基準に基づくクラスB情報技術装置です。この装置は家庭環境で使用することを目的としていますが、この装置がラジオやテレビジョン受信機に近接して使用されると、受信障害を引き起こすことがあります。

取扱説明書に従って正しい取り扱いをして下さい。

## KC: Korea Warning Statement

B급 기기 (가정용 방송통신기자재)

이 기기는 가정용(B급) 전자파적합기기로서 주로 가정에서 사용하는 것을 목적으로 하며, 모든 지역에서 사용할 수 있습니다.

\*당해 무선설비는 전파통신 가능성이 있으므로 인명안전과 관련된 서비스는 할 수 없습니다.

## REACH

Complying with the REACH (Registration, Evaluation, Authorisation, and Restriction of Chemicals) regulatory framework, we published the chemical substances in our products at ASUS REACH website at <http://csr.asus.com/english/REACH.htm>.



---

DO NOT throw the motherboard in municipal waste. This product has been designed to enable proper reuse of parts and recycling. This symbol of the crossed out wheeled bin indicates that the product (electrical and electronic equipment) should not be placed in municipal waste. Check local regulations for disposal of electronic products.

---



---

DO NOT throw the mercury-containing button cell battery in municipal waste. This symbol of the crossed out wheeled bin indicates that the battery should not be placed in municipal waste.

---

## ASUS Recycling/Takeback Services

ASUS recycling and takeback programs come from our commitment to the highest standards for protecting our environment. We believe in providing solutions for you to be able to responsibly recycle our products, batteries, other components as well as the packaging materials. Please go to <http://csr.asus.com/english/Takeback.htm> for detailed recycling information in different regions.

## ASUS contact information

### ASUSTeK COMPUTER INC.

Address	15 Li-Te Road, Peitou, Taipei, Taiwan 11259
Telephone	+886-2-2894-3447
Fax	+886-2-2890-7798
E-mail	info@asus.com.tw
Web site	www.asus.com.tw

#### *Technical Support*

Telephone	+86-21-38429911
Online support	support.asus.com

### ASUS COMPUTER INTERNATIONAL (America)

Address	800 Corporate Way, Fremont, CA 94539, USA
Telephone	+1-812-282-3777
Fax	+1-510-608-4555
Web site	usa.asus.com

#### *Technical Support*

Telephone	+1-812-282-2787
Support fax	+1-812-284-0883
Online support	support.asus.com

### ASUS COMPUTER GmbH (Germany and Austria)

Address	Harkort Str. 21-23, D-40880 Ratingen, Germany
Fax	+49-2102-959911
Web site	www.asus.de
Online contact	www.asus.de/sales

#### *Technical Support*

Telephone	+49-1805-010923*
Support Fax	+49-2102-9599-11
Online support	support.asus.com

\* EUR 0.14/minute from a German fixed landline; EUR 0.42/minute from a mobile phone.



# DECLARATION OF CONFORMITY

Per FCC Part 2, Section 2.1077(e)



Responsible Party Name: **Asus Computer International**

Address: **800 Corporate Way, Fremont, CA 94539.**

Phone/Fax No: **(510)739-3777/(510)608-4555**

hereby declares that the product

**Product Name : Motherboard**

**Model Number : M5A99FX PRO R2.0**

Conforms to the following specifications:

- FCC Part 15, Subpart B, Unintentional Radiators
- FCC Part 15, Subpart C, Intentional Radiators
- FCC Part 15, Subpart E, Intentional Radiators

**Supplementary Information:**

This device complies with part 15 of the FCC Rules. Operation is subject to the following two conditions: (1) This device may not cause harmful interference, and (2) this device must accept any interference received, including interference that may cause undesired operation.

Representative Person's Name : Steve Chang / President

Signature : *Steve Chang*  
Date : May 11, 2012

Ver: 110101

# EC Declaration of Conformity



We, the undersigned,

ASUSTeK COMPUTER INC.  
Address: City: 4F No. 150, LITE Bldg., PEITOU, TAIPEI 112, TAIWAN  
Country: TAIWAN  
Authorized representative in Europe:  
ASUS COMPUTER GmbH  
Address: City: HARKORT STR. 21-23, 40880 RATINGEN  
Country: GERMANY

declare the following apparatus:

Product name : Motherboard  
Model name : M5A99FX PRO R2.0

conform with the essential requirements of the following directives:

2004/108/EC EMC Directive  
 EN 55022:2006/A1:2007  
 EN 55024:2006/A1:2007  
 EN 55035:2005/A1:2006  
 EN 55035:2005/A2:2006  
 1989/656/EEC LVD Directive  
 EN 300 328 V1.7 (12/06:10)  
 EN 300 440-1 V1.6 (12/01:04)  
 EN 300 440-2 V1.6 (12/01:04)  
 EN 300 440-3 V1.3 (12/05:05)  
 EN 300 440-4 V1.3 (12/05:05)  
 EN 301 988-1 V5.2 (12/01:05)  
 EN 301 988-2 V5.2 (12/01:07)  
 EN 301 988-3 V5.2 (12/01:07)  
 EN 301 988-4 V5.1 (12/05:08)  
 EN 302 444-2 V1.1 (12/08:01)  
 EN 302 623 V1.1 (12/08:01)  
 EN 302 623 V1.1 (12/08:02)  
 EN 302 623 V1.1 (12/01:02)  
 EN 50360:2001  
 EN 50360:2001  
 EN 62311:2008

2006/95/EC LVD Directive  
 EN 60950-1 A1:2009  
 EN 60950-1 A12:2011  
 2009/12/EC RoHS Directive  
 Regulation (EC) No. 1275/2008  
 Regulation (EC) No. 642/2009  
 2011/65/EU RoHS Directive  
 EN 55024:1986/A1:2001+A2:2003  
 EN 1000:2002  
 EN 55022:2007/A1:2011  
 EN 301 488-1 V1.9 (2/01:09)  
 EN 301 488-3 V1.4 (12/02:08)  
 EN 301 488-4 V1.3 (12/05:05)  
 EN 301 488-5 V1.3 (12/05:05)  
 EN 301 488-6 V1.4 (12/07:11)  
 EN 301 488-7 V1.5 (12/05:08)  
 EN 301 488-8 V1.5 (12/05:08)  
 EN 302 326-2 V1.2 (2/07:08)  
 EN 302 326-3 V1.3 (12/07:09)  
 EN 302 326-4 V1.4 (12/08:01)  
 EN 50385:2002  
 EN 62311:2008

2006/95/EC LVD Directive  
 EN 60950-1 A1:2009  
 EN 60950-1 A12:2011  
 2009/12/EC RoHS Directive  
 Regulation (EC) No. 1275/2008  
 Regulation (EC) No. 642/2009  
 2011/65/EU RoHS Directive  
 EN 55024:1986/A1:2001+A2:2003  
 EN 1000:2002  
 EN 55022:2007/A1:2011  
 EN 301 488-1 V1.9 (2/01:09)  
 EN 301 488-3 V1.4 (12/02:08)  
 EN 301 488-4 V1.3 (12/05:05)  
 EN 301 488-5 V1.3 (12/05:05)  
 EN 301 488-6 V1.4 (12/07:11)  
 EN 301 488-7 V1.5 (12/05:08)  
 EN 301 488-8 V1.5 (12/05:08)  
 EN 302 326-2 V1.2 (2/07:08)  
 EN 302 326-3 V1.3 (12/07:09)  
 EN 302 326-4 V1.4 (12/08:01)  
 EN 50385:2002  
 EN 62311:2008



(EC conformity marking)

Position : CEO  
Name : Jerry Shen

*Jerry Shen*

Signature :

Declaration Date: Jan. 04, 2013  
Year to begin affixing CE marking: 2013



## Free Manuals Download Website

<http://myh66.com>

<http://usermanuals.us>

<http://www.somanuals.com>

<http://www.4manuals.cc>

<http://www.manual-lib.com>

<http://www.404manual.com>

<http://www.luxmanual.com>

<http://aubethermostatmanual.com>

Golf course search by state

<http://golfingnear.com>

Email search by domain

<http://emailbydomain.com>

Auto manuals search

<http://auto.somanuals.com>

TV manuals search

<http://tv.somanuals.com>