



AT5NM10-I



Motherboard



E5179

First Edition V1
December 2009

Copyright © 2009 ASUSTeK Computer Inc. All Rights Reserved.

No part of this manual, including the products and software described in it, may be reproduced, transmitted, transcribed, stored in a retrieval system, or translated into any language in any form or by any means, except documentation kept by the purchaser for backup purposes, without the express written permission of ASUSTeK Computer Inc. ("ASUS").

Product warranty or service will not be extended if: (1) the product is repaired, modified or altered, unless such repair, modification or alteration is authorized in writing by ASUS; or (2) the serial number of the product is defaced or missing.

ASUS PROVIDES THIS MANUAL "AS IS" WITHOUT WARRANTY OF ANY KIND, EITHER EXPRESS OR IMPLIED, INCLUDING BUT NOT LIMITED TO THE IMPLIED WARRANTIES OR CONDITIONS OF MERCHANTABILITY OR FITNESS FOR A PARTICULAR PURPOSE. IN NO EVENT SHALL ASUS, ITS DIRECTORS, OFFICERS, EMPLOYEES OR AGENTS BE LIABLE FOR ANY INDIRECT, SPECIAL, INCIDENTAL, OR CONSEQUENTIAL DAMAGES (INCLUDING DAMAGES FOR LOSS OF PROFITS, LOSS OF BUSINESS, LOSS OF USE OR DATA, INTERRUPTION OF BUSINESS AND THE LIKE), EVEN IF ASUS HAS BEEN ADVISED OF THE POSSIBILITY OF SUCH DAMAGES ARISING FROM ANY DEFECT OR ERROR IN THIS MANUAL OR PRODUCT.

SPECIFICATIONS AND INFORMATION CONTAINED IN THIS MANUAL ARE FURNISHED FOR INFORMATIONAL USE ONLY, AND ARE SUBJECT TO CHANGE AT ANY TIME WITHOUT NOTICE, AND SHOULD NOT BE CONSTRUED AS A COMMITMENT BY ASUS. ASUS ASSUMES NO RESPONSIBILITY OR LIABILITY FOR ANY ERRORS OR INACCURACIES THAT MAY APPEAR IN THIS MANUAL, INCLUDING THE PRODUCTS AND SOFTWARE DESCRIBED IN IT.

Products and corporate names appearing in this manual may or may not be registered trademarks or copyrights of their respective companies, and are used only for identification or explanation and to the owners' benefit, without intent to infringe.

Offer to Provide Source Code of Certain Software

This product contains copyrighted software that is licensed under the General Public License ("GPL") and under the Lesser General Public License Version ("LGPL"). The GPL and LGPL licensed code in this product is distributed without any warranty. Copies of these licenses are included in this product.

You may obtain the complete corresponding source code (as defined in the GPL) for the GPL Software, and/or the complete corresponding source code of the LGPL Software (with the complete machine-readable "work that uses the Library") for a period of three years after our last shipment of the product including the GPL Software and/or LGPL Software, which will be no earlier than December 1, 2011, either (1) for free by downloading it from <http://support.asus.com/download>;

or
(2) for the cost of reproduction and shipment, which is dependent on the preferred carrier and the location where you want to have it shipped to, by sending a request to:

ASUSTeK Computer Inc.
Legal Compliance Dept.
15 Li Te Rd.,
Beitou, Taipei 112
Taiwan

In your request please provide the name, model number and version, as stated in the About Box of the product for which you wish to obtain the corresponding source code and your contact details so that we can coordinate the terms and cost of shipment with you.

The source code will be distributed WITHOUT ANY WARRANTY and licensed under the same license as the corresponding binary/object code.

This offer is valid to anyone in receipt of this information.

ASUSTeK is eager to duly provide complete source code as required under various Free Open Source Software licenses. If however you encounter any problems in obtaining the full corresponding source code we would be much obliged if you give us a notification to the email address gpl@asus.com, stating the product and describing the problem (please do NOT send large attachments such as source code archives etc to this email address).



Contents

Notices.....	v
Safety information	vi
About this guide	vi
AT5NM10-I specifications summary	viii

Chapter 1: Product introduction

1.1 Before you proceed	1-1
1.2 Motherboard overview.....	1-2
1.2.1 Motherboard layout.....	1-2
1.2.2 Layout contents.....	1-2
1.3 Central Processing Unit (CPU)	1-3
1.4 System memory	1-3
1.4.1 Overview	1-3
1.4.2 Memory configurations.....	1-4
1.5 Expansion slot.....	1-8
1.5.1 Installing an expansion card	1-8
1.5.2 Configuring an expansion card	1-8
1.5.3 PCI slot	1-8
1.6 Jumpers	1-9
1.7 Connectors	1-11
1.7.1 Rear panel connectors.....	1-11
1.7.2 Internal connectors	1-12
1.8 Software support.....	1-18
1.8.1 Installing an operating system	1-18
1.8.2 Support DVD information	1-18

Chapter 2: BIOS information

2.1 Managing and updating your BIOS	2-1
2.1.1 ASUS Update utility	2-1
2.1.2 ASUS EZ Flash 2.....	2-2
2.1.3 ASUS CrashFree BIOS.....	2-3
2.2 BIOS setup program	2-4



Contents

2.3	Main menu	2-4
2.3.1	System Time	2-5
2.3.2	System Date	2-5
2.3.3	SATA 1/2	2-5
2.3.4	Storage Configuration	2-6
2.3.5	System Information	2-6
2.4	Advanced menu	2-6
2.4.1	CPU Configuration	2-7
2.4.2	Chipset	2-7
2.4.3	Onboard Devices Configuration	2-8
2.4.4	USB Configuration	2-9
2.4.5	PCI PnP	2-10
2.5	Power menu	2-10
2.5.1	Suspend Mode	2-10
2.5.2	ACPI 2.0 Support	2-10
2.5.3	ACPI APIC Support	2-10
2.5.4	APM Configuration	2-11
2.5.5	Hardware Monitor	2-11
2.6	Boot menu	2-12
2.6.1	Boot Device Priority	2-12
2.6.2	Boot Settings Configuration	2-12
2.6.3	Security	2-13
2.7	Tools menu	2-15
2.7.1	ASUS EZ Flash 2	2-15
2.7.2	Express Gate	2-15
2.7.3	AI NET 2	2-16
2.8	Exit menu	2-16





Notices

Federal Communications Commission Statement

This device complies with Part 15 of the FCC Rules. Operation is subject to the following two conditions:

- This device may not cause harmful interference, and
- This device must accept any interference received including interference that may cause undesired operation.

This equipment has been tested and found to comply with the limits for a Class B digital device, pursuant to Part 15 of the FCC Rules. These limits are designed to provide reasonable protection against harmful interference in a residential installation. This equipment generates, uses and can radiate radio frequency energy and, if not installed and used in accordance with manufacturer's instructions, may cause harmful interference to radio communications. However, there is no guarantee that interference will not occur in a particular installation. If this equipment does cause harmful interference to radio or television reception, which can be determined by turning the equipment off and on, the user is encouraged to try to correct the interference by one or more of the following measures:

- Reorient or relocate the receiving antenna.
- Increase the separation between the equipment and receiver.
- Connect the equipment to an outlet on a circuit different from that to which the receiver is connected.
- Consult the dealer or an experienced radio/TV technician for help.



The use of shielded cables for connection of the monitor to the graphics card is required to assure compliance with FCC regulations. Changes or modifications to this unit not expressly approved by the party responsible for compliance could void the user's authority to operate this equipment.

Canadian Department of Communications Statement

This digital apparatus does not exceed the Class B limits for radio noise emissions from digital apparatus set out in the Radio Interference Regulations of the Canadian Department of Communications.

This class B digital apparatus complies with Canadian ICES-003.

REACH

Complying with the REACH (Registration, Evaluation, Authorisation, and Restriction of Chemicals) regulatory framework, we published the chemical substances in our products at ASUS REACH website at <http://green.asus.com/english/REACH.htm>.



DO NOT throw the motherboard in municipal waste. This product has been designed to enable proper reuse of parts and recycling. This symbol of the crossed out wheeled bin indicates that the product (electrical and electronic equipment) should not be placed in municipal waste. Check local regulations for disposal of electronic products.



DO NOT throw the mercury-containing button cell battery in municipal waste. This symbol of the crossed out wheeled bin indicates that the battery should not be placed in municipal waste.





Safety information

Electrical safety

- To prevent electric shock hazard, disconnect the power cable from the electric outlet before relocating the system.
- When adding or removing devices to or from the system, ensure that the power cables for the devices are unplugged before the signal cables are connected. If possible, disconnect all power cables from the existing system before you add a device.
- Before connecting or removing signal cables from the motherboard, ensure that all power cables are unplugged.
- Seek professional assistance before using an adapter or extension cord. These devices could interrupt the grounding circuit.
- Ensure that your power supply is set to the correct voltage in your area. If you are not sure about the voltage of the electrical outlet you are using, contact your local power company.
- If the power supply is broken, do not try to fix it by yourself. Contact a qualified service technician or your retailer.

Operation safety

- Before installing the motherboard and adding devices on it, carefully read all the manuals that came with the package.
- Before using the product, ensure that all cables are correctly connected and the power cables are not damaged. If you detect any damage, contact your dealer immediately.
- To avoid short circuits, keep paper clips, screws, and staples away from connectors, slots, sockets and circuitry.
- Avoid dust, humidity, and temperature extremes. Do not place the product in any area where it may become wet.
- Place the product on a stable surface.
- If you encounter technical problems with the product, contact a qualified service technician or your retailer.

About this guide

This user guide contains the information you need when installing and configuring the motherboard.

How this guide is organized

This guide contains the following parts:

- **Chapter 1: Product introduction**
This chapter describes the features of the motherboard and the new technology it supports.
- **Chapter 2: BIOS information**
This chapter tells how to change system settings through the BIOS Setup menus. Detailed descriptions of the BIOS parameters are also provided.



Conventions used in this guide

To ensure that you perform certain tasks properly, take note of the following symbols used throughout this manual.



DANGER/WARNING: Information to prevent injury to yourself when trying to complete a task.



CAUTION: Information to prevent damage to the components when trying to complete a task.



IMPORTANT: Instructions that you **MUST** follow to complete a task.



NOTE: Tips and additional information to help you complete a task.

Where to find more information

Refer to the following sources for additional information and for product and software updates.

1. ASUS websites

The ASUS website provides updated information on ASUS hardware and software products. Refer to the ASUS contact information.

2. Optional documentation

Your product package may include optional documentation, such as warranty flyers, that may have been added by your dealer. These documents are not part of the standard package.

Typography

Bold text

Indicates a menu or an item to select.

Italics

Used to emphasize a word or a phrase.

<Key>

Keys enclosed in the less-than and greater-than sign means that you must press the enclosed key.

Example: <Enter> means that you must press the Enter or Return key.

<Key1>+<Key2>+<Key3>

If you must press two or more keys simultaneously, the key names are linked with a plus sign (+).

Example: <Ctrl>+<Alt>+<D>



AT5NM10-I specifications summary

CPU	Integrated Dual-Core Intel® Atom™ D510 processor
Chipset	Intel® NM10
Memory	<p>Single channel memory architecture</p> <ul style="list-style-type: none"> - 2 x 240-pin DIMM sockets support maximum 4GB unbuffered non-ECC 800/667 MHz DDR2 memory modules <p>* Refer to www.asus.com or this user manual for the Memory QVL (Qualified Vendors Lists).</p> <p>** When you install a total memory of 4GB capacity or more, Windows® 32-bit operating system may only recognize less than 3GB. We recommend a maximum of 3GB system memory if you are using a Windows® 32-bit operating system.</p>
Graphics	<p>Integrated Atom™ D510</p> <p>Maximum shared memory of 256MB</p>
Expansion slot	1 x PCI slot
Storage	2 x Serial ATA 3Gb/s ports
Audio	IDT73C High Definition Audio 6-channel CODEC
LAN	Realtek® RTL8112L PCIe Gigabit LAN controller
USB	Supports up to 8 USB 2.0/1.1 ports (4 ports at mid-board, 4 ports at back panel)
ASUS special features	<p>ASUS CrashFree BIOS 3</p> <p>ASUS EZ Flash 2</p> <p>ASUS MyLogo 2™</p> <p>ASUS Express Gate</p>
Rear panel ports	<p>1 x PS/2 Keyboard port</p> <p>1 x PS/2 Mouse port</p> <p>1 x COM port</p> <p>1 x VGA port</p> <p>1 x LPT port</p> <p>1 x LAN (RJ-45) port</p> <p>4 x USB 2.0/1.1 ports</p> <p>6-channel audio I/O ports</p>

(continued on the next page)



AT5NM10-I specifications summary

Internal connectors	2 x USB 2.0/1.1 connector supports additional 4 USB 2.0/1.1 ports 1 x CPU fan connector 1 x Chassis fan connector 1 x Chassis intrusion connector 1 x Optical S/PDIF Out connector 1 x Speaker connector 1 x COM connector 1 x LVDS connector 2 x Serial ATA connectors 1 x System panel connector 1 x High definition front panel audio connector 1 x 24-pin EATX power connector 1 x 4-pin ATX 12V power connector
BIOS features	8 Mb Flash ROM, AMI BIOS, PnP, DMI2.0, WfM2.0, SMBIOS 2.5
Accessories	1 x Serial ATA cable 1 x I/O shield 1 x User Manual
Support DVD contents	Drivers ASUS PC Probe II ASUS Update Anti-virus software (OEM version)
Form Factor	Mini ITX form factor: 6.75 in x 6.75 in (17.1cm x 17.1cm)

*Specifications are subject to change without notice.





Chapter 1

Product introduction

Thank you for buying an ASUS® AT5NM10-I motherboard!

Before you start installing the motherboard, and hardware devices on it, check the items in your motherboard package. Refer to page ix for the list of accessories.



If any of the items is damaged or missing, contact your retailer.

1.1 Before you proceed

Take note of the following precautions before you install motherboard components or change any motherboard settings.



- Unplug the power cord from the wall socket before touching any component.
- Before handling components, use a grounded wrist strap or touch a safely grounded object or a metal object, such as the power supply case, to avoid damaging them due to static electricity.
- Hold components by the edges to avoid touching the ICs on them.
- Whenever you uninstall any component, place it on a grounded antistatic pad or in the bag that came with the component.
- Before you install or remove any component, ensure that the ATX power supply is switched off or the power cord is detached from the power supply. Failure to do so may cause severe damage to the motherboard, peripherals, or components.

Onboard LED

The motherboard comes with a standby power LED that lights up to indicate that the system is ON, in sleep mode, or in soft-off mode. This is a reminder that you must shut down the system and unplug the power cable before removing or plugging in any motherboard component. The illustration below shows the location of the onboard LED.

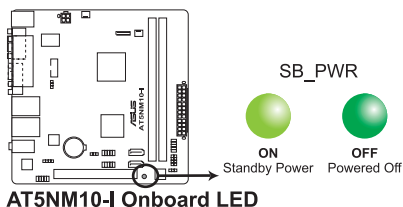



1.2 Motherboard overview

1.2.1 Motherboard layout



Ensure that you install the motherboard into the chassis in the correct orientation. The edge with external ports goes to the rear part of the chassis.

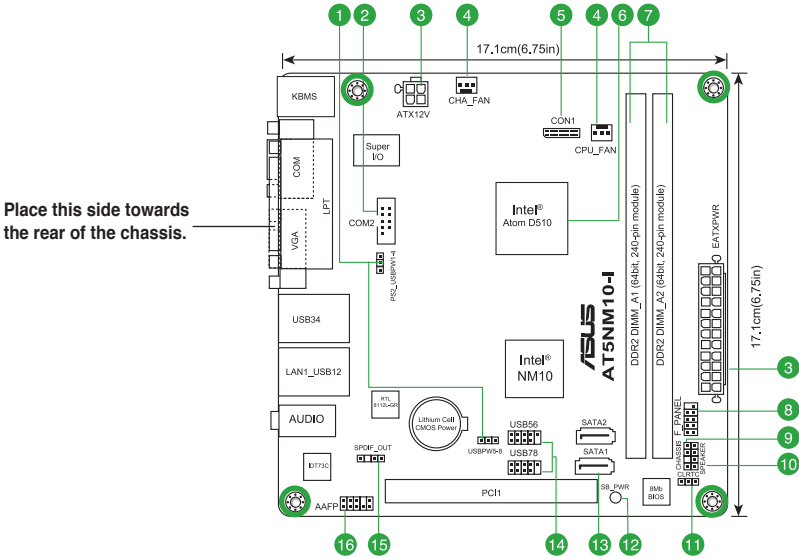

Place four screws into the holes indicated by circles to secure the motherboard to the chassis. DO NOT overtighten the screws! Doing so can damage the motherboard.

1.2.2 Layout contents

Connectors/Jumpers/Slots/LED	Page	Connectors/Jumpers/Slots/LED	Page
1. Keyboard/mouse power and USB device wake-up (3-pin PS2_USBPW1-4, 3-pin USBPW5-8)	1-10	9. Chassis intrusion connector (4-1 pin CHASSIS)	1-14
2. Serial port connectors (10-1 pin COM2)	1-17	10. Internal speaker connector (4-pin SPEAKER)	1-14
3. ATX power connectors (24-pin EATXPWR, 4-pin ATX12V)	1-12	11. Clear RTC RAM (3-pin CLRRTC)	1-9
4. CPU and chassis fan connectors (3-pin CPU_FAN, 3-pin CHA_FAN)	1-15	12. Onboard LED	1-1
5. LVDS connector (30-pin CON1)	1-16	13. Serial ATA connectors (7-pin SATA1, SATA2)	1-13
6. System panel connector (10-1 pin F_PANEL)	1-15	14. USB connector (10-1 pin USB56, USB78)	1-13
7. DIMM socket	1-3	15. Digital audio connector (4-1 pin SPDIF_OUT)	1-17
8. System panel connector (10-1 pin F_PANEL)	1-16	16. Front panel audio connector (10-1 pin AAFP)	1-15



1.3 Central Processing Unit (CPU)

The motherboard comes with an onboard Dual-Core Intel® Atom™ D510 processor and a specially designed CPU heatsink.

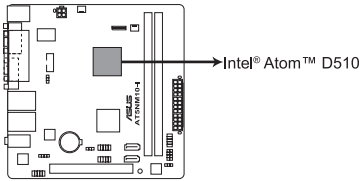

AT5NM10-I CPU - Atom D510



Ensure that the CPU fan cable is connected to the onboard CPU_FAN connector.

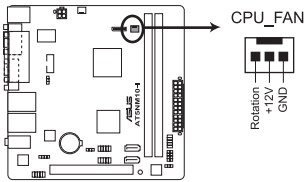

AT5NM10-I CPU fan connector

1.4 System memory

1.4.1 Overview

The motherboard comes with two Double Data Rate 2 (DDR2) Dual Inline Memory Modules (DIMM) sockets. The figure illustrates the location of the DDR2 DIMM sockets:

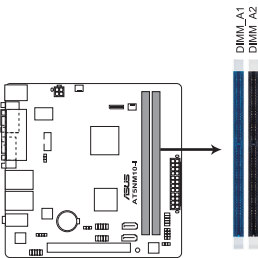

AT5NM10-I 240-pin DDR2 DIMM sockets

Channel	Sockets
Channel A	DIMM_A1 and DIMM_A2



1.4.2 Memory configurations

You may install 512MB, 1GB, and 2GB unbuffered non-ECC DDR2 DIMMs into the DIMM sockets.



- Always install DIMMs with the same CAS latency. For optimum compatibility, it is recommended that you obtain memory modules from the same vendor.
- Due to the memory address limitation on 32-bit Windows® OS, when you install 4GB or more memory on the motherboard, the actual usable memory for the OS can be about 3GB or less. For effective use of memory, we recommend that you do any of the following:
 - Use a maximum of 3GB system memory if you are using a 32-bit Windows® OS.
 - Install a 64-bit Windows® OS when you want to install 4GB memory on the motherboard.
- When you install 4GB memory on the motherboard, the memory that the system can detect is less than 4GB.
- This motherboard does not support DIMMs made up of 256 megabits (Mb) chips or less.

AT5NM10-I Motherboard Qualified Vendors Lists (QVL)

DDR2-667 MHz capability

Vendor	Part No.	Size	SS/ DS	Chip Brand	Chip NO.	Timing	Voltage	DIMM support	
								A*	B*
A-Data	M20AD5H3J417011C53	2048MB	DS	A-Data	AD20908A8A-3EG 30724	-	-	-	-
Corsair	VS1GB667D2	1024MB	DS	Corsair	MID095D62864M8CEC	-	-	-	-
G.SKILL	F2-5400PHU2-2GBNT	2048MB(Kit of 2)	DS	G.SKILL	D2 64M8CCF 0815 C7173S	5-5-5-15	-	-	-
G.SKILL	F2-5300CLS-4GBMQ	4096MB(Kit of 2)	DS	G.SKILL	Heat-Sink Package SN:8151030036559	5-5-5-15	-	-	-
GEIL	GX21GB5300SX	1024MB	DS	GEIL	-	3	-	-	-
GEIL	GX22GB5300LX	2048MB	DS	GEIL	-	5	-	-	-
GEIL	GX24GB5300LDC	2048MB	DS	GEIL	-	5	-	-	-
Kingston	KVR667D2N5/1G (low profile)	1024MB	SS	Elpida	E1108AFSE-8E-F	5	1.8V	-	-
Kingston	KVR667D2N5/2G (low profile)	2048MB	DS	Elpida	E1108AFBG-8E-F	5	1.8V	-	-
PSC	AL7E8F73C-6E1	1024MB	SS	PSC	A3R1GE3CFF734MAA0J	5	-	-	-
PSC	AL6E8E63J-6E1	512MB	SS	PSC	A3R12E3JFF717B9A00	5	-	-	-
PSC	AL6E8E63J-6E1	1024MB	DS	PSC	A3R12E3JFF717B9A01	5	-	-	-
PSC	AL8E8F73C-6E1	2048MB	DS	PSC	A3R1GE3CFF733MAA00	5	-	-	-
SAMSUNG	M378T5263AZ3-CE6	4096MB	DS		K4T2G084QA-HCE6	-	-	-	-
Transcend	JM667QLJ-1G	1024MB	DS	Elpida	E5108AJBG-6E-E	5	-	-	-
Transcend	JM667QLU-2G	2048MB	DS	Transced	TQ243PCF8T0834	5	-	-	-
Twinmos	8D-A3JK5MPETP	512MB	SS	PSC	A3R12E3GEF633ACA0Y	5	-	-	-
ASINT	SLY2128M8-J6E	1024MB	SS	ASINT	DDR11208-6E 8115	-	-	-	-
ASINT	SLX264M8-J6E	512MB	SS	ASINT	DDR16408-6E	-	-	-	-
Century	CENTURY 512MB	512MB	SS	Hynix	HY5PS12821AFP-Y5	-	-	-	-
Century	CENTURY 512MB	512MB	SS	Nanya	NT5TU64M8AE-3C	-	-	-	-

(continued on the next page)



DDR2-667 MHz capability

Vendor	Part No.	Size	SS/ DS	Chip Brand	Chip NO.	Timing	Voltage	DIMM support A* B*	
Century	CENTURY 1G	1024MB	DS	Hynix	HY5PS12821AFP-Y5	-	-	-	*
Century	CENTURY 1G	1024MB	DS	Nanya	NT5TU64M8AE-3C	-	-	-	*
KINGBOX	512MB 667MHz	512MB	SS		EPD264082200-4	-	-	-	*
KINGBOX	DDR11 1G 667MHz	1024MB	DS		EPD264082200-4	-	-	-	*
MDT	MDT 1024MB	1024MB	DS	MDT	18D51280D-30646E	4	-	-	*
MDT	DDR11 512 PC667	512MB	DS	MDT	18D51201D-30726E	4	-	-	*
TAKEMS	TMS51B264C081-665AP	512MB	SS	takeMS	MS18T51280-3S0627D	5	-	-	*
TAKEMS	TMS51B264C081-665QI	512MB	SS	takeMS	MS18T51280-3	5	-	-	*
TAKEMS	TMS1GB264C081-665AE	1024MB	DS	takeMS	MS18T51280-3SEA07100	5	-	-	*
TAKEMS	TMS1GB264C081-665AP	1024MB	DS	takeMS	MS18T51280-3SP0717A	5	-	-	*
TAKEMS	TMS1GB264C081-665QI	1024MB	DS	takeMS	MS18T51280-3	5	-	-	*
UMAX	D46701GP3-63BJU	1024MB	DS	UMAX	U2S12D30YP-6E	-	-	-	*
UMAX	D46702GP0-73BCU	2048MB	DS	UMAX	U2S24D30TP-6E	5	-	-	*

DDR2-800 MHz capability

Vendor	Part No.	Size	SS/ DS	Chip Brand	Chip NO.	Timing	Voltage	DIMM support A* B*	
A-Data	AD2800E001GOU	2048MB(Kit of 2)	SS	-	-	4-4-4-12	2.0~2.1V	-	*
A-Data	M2GVD6G314170Q1E58	1024MB	DS	V-Data	VD29608A6A-25EG80813	-	-	-	*
A-Data	AD2800002GMO	2048MB	DS	Hynix	-	-	-	-	*
A-Data	AD2800E002GOU	4096MB(Kit of 2)	DS	-	-	4-4-4-12	1.9~2.1V	-	*
Corsair	XMS2-6400	1024MB	DS	Corsair	-	4	-	-	*
Corsair	XMS2-6400	1024MB	DS	Corsair	-	5	-	-	*
Corsair	CM2X2048-6400C5DHX	4096MB(Kit of 2)	DS	-	-	5	-	-	*
Corsair	CM2X2048-6400C5	4096MB(Kit of 2)	DS	-	-	5	-	-	*
Crucial	BL12864AL80A.8FE5(EPP)	2048MB(kit of 2)	SS	-	-	4-4-4-12	-	-	*
Crucial	BL25664AL80A.16FE5(EPP)	4096MB(kit of 2)	DS	-	-	4-4-4-12	-	-	*
Crucial	BL25664AR80A.16FE5(EPP)	4096MB(kit of 2)	DS	-	-	4-4-4-12	-	-	*
G.SkiLL	F2-6400PHU2-2GBNR	1024MB	SS	-	-	5-5-5-15	1.9-2.0V	-	*
G.SKILL	F2-6400CL5D-1GBNQ	512MB	SS	G.SKILL	Heat-Sink Package SN:8151030036642	5-5-5-15	-	-	*
G.SKILL	F2-6400CL4D-2GBPK	1024MB	DS	G.SKILL	-	4	-	-	*
G.SKILL	F2-6400CL5D-2GBNQ	1024MB	DS	G.SKILL	-	5	-	-	*
G.SKILL	F2-6400CL4D-4GBPK	2048MB	DS	G.SKILL	-	4	-	-	*
G.SKILL	F2-6400CL5D-4GBPQ	2048MB	DS	G.SKILL	-	5	-	-	*
G.SkiLL	F2-6400CL6D-4GBMQ	4096MB(Kit of 2)	DS	-	-	6-6-6-18	1.8-1.9V	-	*
G.SKILL	F2-6400CL6Q-16GMQ	4096MB	DS	-	-	5	-	-	*
GEIL	GB22GB6400C4DC	1024MB	DS	GEIL	GL2L64M088BA30EB	5	-	-	*
GEIL	GB22GB6400C5DC	1024MB	DS	GEIL	GL2L64M088BA30EB	5	-	-	*
GEIL	GB24GB6400C4QC	1024MB	DS	GEIL	GL2L64M088BA30EB	4	-	-	*
GEIL	GB24GB6400C5QC	1024MB	DS	GEIL	GL2L64M088BA30EB	5	-	-	*
GEIL	GE22GB800C4DC	1024MB	DS	GEIL	-	4	-	-	*

(continued on the next page)



DDR2-800 MHz capability

Vendor	Part No.	Size	SS/ DS	Chip Brand	Chip NO.	Timing	Voltage	DIMM support	
								A*	B*
GEIL	GE22GB800C5DC	1024MB	DS	GEIL	-	5	-	*	*
GEIL	GE24GB800C4QC	1024MB	DS	GEIL	-	4	-	*	*
GEIL	GE24GB800C5QC	1024MB	DS	GEIL	-	5	-	*	*
GEIL	GX22GB6400DC	1024MB	DS	GEIL	-	5	1.8V	*	*
GEIL	GX22GB6400UDC	1024MB	DS	GEIL	-	4	-	*	*
GEIL	GB24GB6400C4DC	2048MB	DS	GEIL	-	5	-	*	*
GEIL	GB24GB6400C5DC	2048MB	DS	GEIL	GL2L128M88BA25AB	5	-	*	*
GEIL	GB28GB6400C4QC	2048MB	DS	GEIL	GL2L128M88BA25AB	4	-	*	*
GEIL	GB28GB6400C5QC	2048MB	DS	GEIL	GL2L128M88BA25AB	5	-	*	*
GEIL	GE24GB800C4DC	2048MB	DS	GEIL	-	4	-	*	*
GEIL	GE24GB800C5DC	2048MB	DS	GEIL	-	5	-	*	*
GEIL	GE28GB800C4QC	2048MB	DS	GEIL	-	4	-	*	*
GEIL	GE28GB800C5QC	2048MB	DS	GEIL	-	5	-	*	*
GEIL	GX22GB6400C4USC	2048MB	DS	GEIL	-	4	-	*	*
GEIL	GX22GB6400LX	2048MB	DS	GEIL	-	5	-	*	*
GEIL	GX24GB6400DC	2048MB	DS	GEIL	-	5	-	*	*
Kingmax	KLDD48F-B8KU5 NGES	1024MB	SS	Kingmax	KKB8FNUBF-DNX-25A	-	-	*	*
Kingmax	KLDE88F-B8KU5 NHES	2048MB	DS	Kingmax	KKB8FNUBF-DNX-25A	-	-	*	*
Kingston	KVR800D2N5/1G(DD)	1024MB	SS	Elpida	E1108AFSE-8E-F	5	1.8V	*	*
Kingston	KVR800D2N6/1G(DD)	1024MB	SS	Elpida	E1108AFBG-8E-F	6	1.8V	*	*
Kingston	KHX6400D2K2/2G	2048MB(Kit of 2)	DS	-	-	5-5-5-15	2.0V	*	*
Kingston	KVR800D2N5/2G(DD)	2048MB	DS	Kingston	D1288TEFCGL25U	5	1.8V	*	*
Kingston	KVR800D2N6/2G(DD)	2048MB	DS	Samsung	K4T1G084QE	6	1.8V	*	*
Kingston	KVR800D2N6/4G	4096MB	DS	Elpida	E2108ABSE-8G-E	6	1.8V	*	*
OCZ	OCZ2G800R22GK	1024MB	DS	OCZ	-	4-5-5-15	2.0V	*	*
OCZ	OCZ2P800R22GK	1024MB	DS	OCZ	-	4-4-4-15	1.9 -2.1 V	*	*
OCZ	OCZ2RPR8002GK	1024MB	DS	OCZ	-	4-4-4-15	2.1V	*	*
OCZ	OCZ2VU8004GK	1024MB	DS	OCZ	-	5-6-6-18	1.8V	*	*
OCZ	OCZ2SE8002GK	2048MB(Kit of 2)	DS	-	-	5-5-5-15	1.8V	*	*
OCZ	OCZ2F8004GK(EPP)	2048MB	DS	-	-	5-4-4-18	2.1V	*	*
OCZ	OCZ2P8004GK	4096MB(Kit of 2)	DS	-	-	5-4-4-15	2.1v	*	*
OCZ	OCZ2VU8004GK	4096MB(Kit of 2)	DS	-	-	5-6-6-18	1.8V	*	*
PSC	AL7E8F73C-8E1	1024MB	SS	PSC	A3R1GE3CFF734MAA0E	5	-	*	*
PSC	AL7E8G73F-8E1	1024MB	SS	PSC	P3R1GE3FGF850MAC19	-	-	*	*
PSC	AL8E8F73C-8E1	2048MB	DS	PSC	A3R1GE3CFF734MAA0E	5	-	*	*
PSC	AL8E8G73F-8E1	2048MB	DS	PSC	P3R1GE3FGF850MAC19	-	-	*	*
PSC	PL8E8F73C-8E1	2048MB	DS	PSC	SHG772-AA3G	5	-	*	*
PSC	PL8E8G73E-8E1	2048MB	DS	PSC	XCP271A3G-A	5	-	*	*
SAMSUNG	M378T2863EHS-CF7	1024MB	SS	Samsung	K4T1G084QE	-	-	*	*
SAMSUNG	M378T2863QZS-CF7	1024MB	SS	Qimonda	K4T1G084QQ-HCF7	6	-	*	*
SAMSUNG	M378T6553GZS-CF7	512MB	SS	Qimonda	K4T51083QG-HCF7	6	-	*	*
SAMSUNG	M378T2953GZ3-CF7	1024MB	DS	Samsung	K4T51083QG	-	-	*	*
SAMSUNG	M378T2953GZ3-CF7	1024MB	DS	Samsung	K4T51083QG-HCF7	6	-	*	*
SAMSUNG	M378T5663QZ3-CF7	2048MB	DS	Samsung	K4T1G084QQ-HCF7	6	-	*	*
SAMSUNG	M378T5263AZ3-CF7	4096MB	DS	Samsung	K4T2G084QA-HCF7	-	-	*	*
Super Talent	T800UB1GC4	1024MB	DS	Super Talent	-	4	1.8V	*	*

(continued on the next page)



DDR2-800 MHz capability

Vendor	Part No.	Size	SS/ DS	Chip Brand	Chip NO.	Timing	Voltage	DIMM support	
								A*	B*
Transcend	TS128MLQ64V8U	1024MB	SS	ELPIDA	E1108ACBG-8E-E	5	-	-	-
Transcend	TS64MLQ64V8J	512MB	SS	Micron	7HD22 D9GMH	5	-	-	-
Transcend	JM800QLJ-1G	1024MB	DS	Transced	TQ123PJF8F0801	5	-	-	-
Transcend	JM800QLJ-1G	1024MB	DS	Transcend	TQ123YBF8 T0747	5	-	-	-
Transcend	TS128MLQ64V8J	1024MB	DS	Mircon	7HD22D9GMH	5	-	-	-
Transcend	JM800QLU-2G	2048MB	DS	Transced	TQ243PCF8	5	-	-	-
Transcend	TS256MLQ64V8U	2048MB	DS	Elpida	E1108ACBG-8E-E	5	-	-	-
ASINT	SLY2128M8-JGE	1024MB	SS	ASINT	DDR11208-GE 8115	-	-	-	-
ASINT	SLZ2128M8-JGE	2048MB	DS	ASINT	DDR11208-GE 8115	-	-	-	-
Century	28V0H8	1024MB	DS	Hynix	HY5PS12821CFP-S5	5	-	-	-
Elixir	M2Y1G64TU88D5B-AC 0828.GS	1024MB	SS	Elixir	N2TU16800E-AC	-	-	-	-
Elixir	M2Y2G64TU88D5B-AC 0826.SG	2048MB	DS	Elixir	N2TUG80DE-AC	-	-	-	-
Kingtiger	M9CA0Y6109	1024MB	DS	Hynix	HY5PS12821C FP-S5	-	-	-	-
Kingtiger	KTG2G800PG2	2048MB	DS	-	-	-	-	-	-
Kingtiger	M9CA0X8793	2048MB	DS	Hynix	HY5PS1G831C FP-S6	-	-	-	-
Kingtiger	KTG2RX16P ST-01	4096MB(Kit of 2)	DS	-	-	5-5-5-15	1.9V	-	-
M&S	M2U800-2GBJ	1024MB	SS	X&S	MSD2128M8PT	-	-	-	-
M&S	M2U800-2GBJ	2048MB	DS	X&S	MSD2128M8PT	-	-	-	-
MDT	MDT 512MB	512MB	SS	MDT	18D51280D-2.50726F	5	-	-	-
MDT	MDT 1024MB	1024MB	DS	MDT	18D51280D-2.50726E	5	-	-	-
PATRIOT	PDC24G6400ELK	4096MB(Kit of 2)	DS	-	-	5-5-5-12	2.0V	-	-
TAKEMS	TMS1GB264D082-805EE	1024MB	SS	TAKEMS	WS18T1G80-205 E0905	5	-	-	-
TAKEMS	TMS51B264C081-805EP	512MB	SS	takeMS	MS18T51280-2.5P0710	5	-	-	-
TAKEMS	TMS1GB264C081-804EE	1024MB	DS	TAKEMS	-	4-4-4-12	-	-	-
TAKEMS	TMS1GB264C081-805EP	1024MB	DS	takeMS	MS18T51280-2.5P0716	5	-	-	-
TAKEMS	TMS2GB264D081-805KE	2048MB	DS	TAKEMS	MS18T1G80-205 E0907	5	-	-	-
UMAX	D48001GP3-63BJJ	1024MB	DS	UMAX	U2S12D30TP-8E	-	-	-	-
UMAX	D48002GP0-73BCU	2048MB	DS	UMAX	U2S24D30TP-8E	5	-	-	-
V-Data	M2GVD6G3H3160Q1E52	512MB	SS	V-Data	VD29608A8A-25EG20813	-	-	-	-
V-Data	M2XSSG3147C1L1C5Z	1024MB	DS	Samsung	K4T51083QE	-	-	-	-
V-Data	M2XHYKH3J47CC01E5Z	2048MB	DS	Hynix	H5PS1G83EFRS6C 852AK	-	-	-	-



SS: Single-sided / DS: Double-sided

DIMM support:

- **A***: Supports one module inserted into either slot.
- **B***: Supports one pair of modules inserted into both the slots.



Visit the ASUS website at www.asus.com for the latest QVL.





1.5 Expansion slot

In the future, you may need to install expansion cards. The following sub-sections describe the slot and the expansion cards that it supports.



Unplug the power cord before adding or removing expansion cards. Failure to do so may cause you physical injury and damage motherboard components.

1.5.1 Installing an expansion card

To install an expansion card:

1. Before installing the expansion card, read the documentation that came with it and make the necessary hardware settings for the card.
2. Remove the system unit cover (if your motherboard is already installed in a chassis).
3. Remove the bracket opposite the slot that you intend to use. Keep the screw for later use.
4. Align the card connector with the slot and press firmly until the card is completely seated on the slot.
5. Secure the card to the chassis with the screw you removed earlier.
6. Replace the system cover.

1.5.2 Configuring an expansion card

After installing the expansion card, configure it by adjusting the software settings.

1. Turn on the system and change the necessary BIOS settings, if any. See Chapter 2 for information on BIOS setup.
2. Assign an IRQ to the card.
3. Install the software drivers for the expansion card.

1.5.3 PCI slot

The PCI slot supports cards such as a LAN card, SCSI card, USB card, and other cards that comply with PCI specifications.





1.6 Jumpers

1. Clear RTC RAM (3-pin CLRRTC)

This jumper allows you to clear the Real Time Clock (RTC) RAM in CMOS. You can clear the CMOS memory of date, time, and system setup parameters by erasing the CMOS RTC RAM data. The onboard button cell battery powers the RAM data in CMOS, which include system setup information such as system passwords.

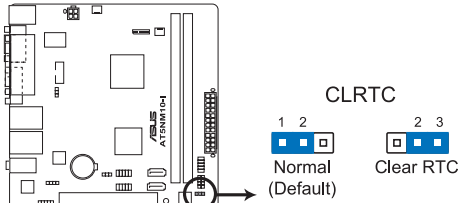

AT5NM10-I Clear RTC RAM

To erase the RTC RAM:

1. Turn OFF the computer and unplug the power cord.
2. Move the jumper cap from pins 1-2 (default) to pins 2-3. Keep the cap on pins 2-3 for about 5-10 seconds, then move the cap back to pins 1-2.
3. Plug the power cord and turn ON the computer.
4. Hold down the **** key during the boot process and enter BIOS setup to re-enter data.



Except when clearing the RTC RAM, never remove the cap on CLRRTC jumper default position. Removing the cap will cause system boot failure!



If the steps above do not help, remove the onboard battery and move the jumper again to clear the CMOS RTC RAM data. After clearing the CMOS, reinstall the battery.



2. Keyboard/mouse power (3-pin PS2_USBPW1-4)

This jumper allows you to enable or disable the keyboard/mouse and USB port 1-4 wake-up feature. When you set this jumper to pins 2-3 (+5VSB), you can wake up the computer by pressing a key on the keyboard (the default is the Space Bar), clicking the mouse or using a USB device. This feature requires an ATX power supply that can supply at least 1A on the +5VSB lead, and a corresponding setting in the BIOS. The USBPW1-4 jumper is for the rear USB ports.

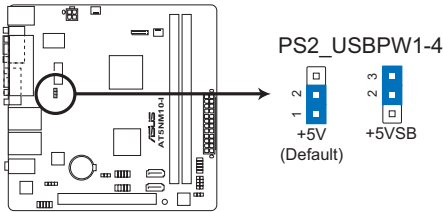

AT5NM10-I Keyboard Power Setting



The total current consumed must NOT exceed the power supply capability (+5VSB) whether under normal condition or in sleep mode.

3. USB device wake-up (3-pin USBPW5-8)

Set this jumper to +5V to wake up the computer from S1 sleep mode (CPU stopped, DRAM refreshed, system running in low power mode) using the connected USB devices. Set to +5VSB to wake up from S3 and S4 sleep modes (no power to CPU, DRAM in slow refresh, power supply in reduced power mode).

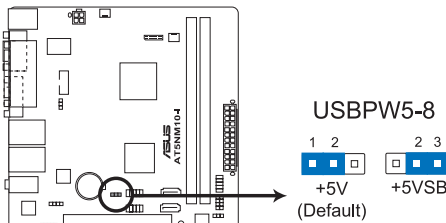

AT5NM10-I USB Device Wake Up



- The USB device wake-up feature requires a power supply that can provide 500mA on the +5VSB lead for each USB port; otherwise, the system would not power up.
- The total current consumed must NOT exceed the power supply capability (+5VSB) whether under normal condition or in sleep mode.





1.7 Connectors

1.7.1 Rear panel connectors

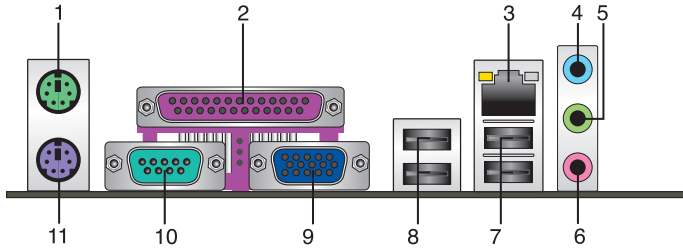

1. **PS/2 Mouse port (green).** This port is for a PS/2 mouse.
2. **Parallel port.** This 25-pin port connects a parallel printer, a scanner, or other devices.
3. **LAN (RJ-45) port.** This port allows Gigabit connection to a Local Area Network (LAN) through a network hub. Refer to the table below for the LAN port LED indications.

LAN port LED indications

ACT/LINK LED		SPEED LED	
Status	Description	Status	Description
OFF	No link	OFF	10 Mbps connection
ORANGE	Linked	ORANGE	100 Mbps connection
BLINKING	Data activity	GREEN	1 Gbps connection

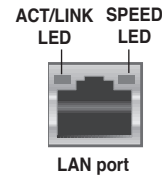

4. **Line In port (light blue).** This port connects to the tape, CD, DVD player, or other audio sources.
5. **Line Out port (lime).** This port connects to a headphone or a speaker. In the 4-channel and 6-channel configurations, the function of this port becomes Front Speaker Out.
6. **Microphone port (pink).** This port connects to a microphone.



Refer to the audio configuration table below for the function of the audio ports in 2, 4, or 6-channel configuration.

Port	Headset 2-channel	4-channel	6-channel
Light Blue	Line In	Rear Speaker Out	Rear Speaker Out
Lime	Line Out	Front Speaker Out	Front Speaker Out
Pink	Mic In	Mic In	Bass/Center

7. **USB 2.0 ports 1 and 2.** These two 4-pin Universal Serial Bus (USB) ports are for USB 2.0 devices.



8. **USB 2.0 ports 3 and 4.** These two 4-pin Universal Serial Bus (USB) ports are for USB 2.0 devices.
9. **Video Graphics Adapter (VGA) port.** This 15-pin port is for a VGA monitor or other VGA-compatible devices.



- This motherboard supports VGA and LVDS display devices. In Single Display mode, use the hot keys to switch between VGA to LVDS device or vice versa. By default, press **<Ctrl>+<Alt>+<F1>** to switch to VGA device and press **<Ctrl>+<Alt>+<F3>** to switch to LVDS device. To set your preferred hot keys, double-click  from the Windows notification area and select **Hot Keys**.
- Before removing the current display device, connect the display device that you want to use, then press the hot keys to switch to that device.

10. **COM port.** This 9-pin COM1 port is for pointing devices or other serial devices.
11. **PS/2 Keyboard port (purple).** This port is for a PS/2 keyboard.

1.7.2 Internal connectors

1. ATX power connectors (24-pin EATXPWR, 4-pin ATX12V)

These connectors are for ATX power supply plugs. The power supply plugs are designed to fit these connectors in only one orientation. Find the proper orientation and push down firmly until the connectors completely fit.

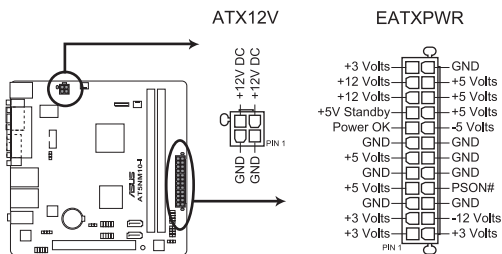

AT5NM10-I ATX power connectors



- We recommend that you use an ATX 12V Specification 2.0-compliant power supply unit (PSU) with a 450W or lower power rating. This PSU type has 24-pin and 4-pin power plugs.
- If you intend to use a PSU with 20-pin and 4-pin power plugs, ensure that the 20-pin power plug can provide at least 15 A on +12 V and that the PSU has a power rating of 450W or lower. The system may become unstable or may not boot up if the power is inadequate.
- DO NOT forget to connect the 4-pin ATX +12V power plug. Otherwise, the system will not boot up.
- If you are uncertain about the minimum power supply requirement for your system, refer to the Recommended Power Supply Wattage Calculator at <http://support.asus.com/PowerSupplyCalculator/PSCalculator.aspx?SLanguage=en-us> for details.



2. Serial ATA connectors (7-pin SATA1, SATA2)

These connectors are for the Serial ATA signal cables for Serial ATA 3Gb/s hard disk drives and optical disk drives. The Serial ATA 3Gb/s is backward compatible with the Serial ATA 1.5Gb/s specification. The data transfer rate of the Serial ATA 3Gb/s is faster than the standard parallel ATA (133 MB/s).

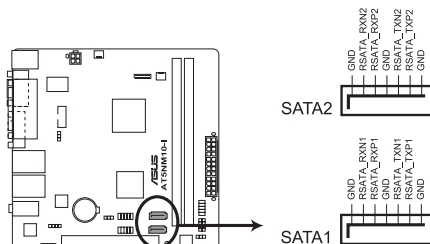

AT5NM10-I SATA connectors



Install the Windows® XP Service Pack 2 or later versions before using Serial ATA.

3. USB connector (10-1 pin USB56, USB78)

These connectors are for USB 2.0 ports. Connect the USB module cable to this connector, then install the module to a slot opening at the back of the system chassis. This USB connector complies with USB 2.0 specification that supports up to 480 Mbps connection speed.

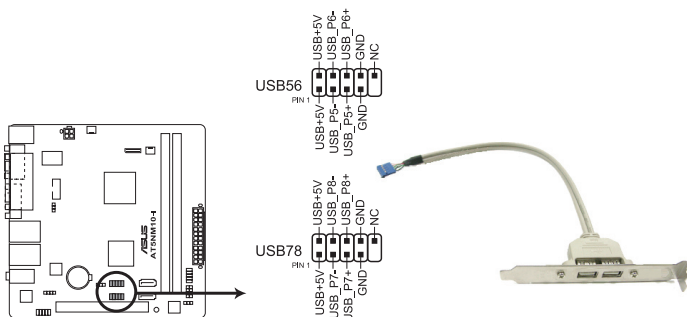

AT5NM10-I USB2.0 connectors



Never connect a 1394 cable to the USB connector. Doing so will damage the motherboard!



The USB module cable is purchased separately.



4. Chassis intrusion connector (4-1 pin CHASSIS)

This connector is for a chassis-mounted intrusion detection sensor or switch. Connect one end of the chassis intrusion sensor or switch cable to this connector. The chassis intrusion sensor or switch sends a high-level signal to this connector when a chassis component is removed or replaced. The signal is then generated as a chassis intrusion event.

By default, the pin labeled “Chassis Signal” and “Ground” are shorted with a jumper cap. Remove the jumper caps only when you intend to use the chassis intrusion detection feature.

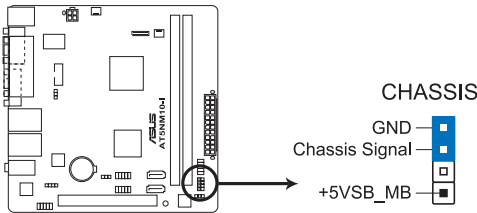

AT5NM10-I Chassis intrusion connector

5. Internal speaker connector (4-pin SPEAKER)

The 4-pin connector is for the chassis-mounted system warning speaker. The speaker allows you to hear system beeps and warnings.

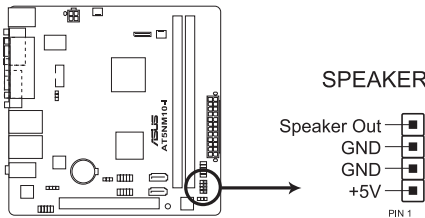

AT5NM10-I Internal speaker connector





6. CPU and chassis fan connectors (3-pin CPU_FAN, 3-pin CHA_FAN)

Connect the fan cables to the fan connectors on the motherboard, ensuring that the black wire of each cable matches the ground pin of the connector.



Do not forget to connect the fan cables to the fan connectors. Insufficient air flow inside the system may damage the motherboard components. These are not jumpers! Do not place jumper caps on the fan connectors!

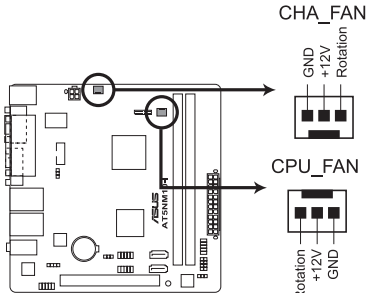

AT5NM10-I fan connectors

7. Front panel audio connector (10-1 pin AAFP)

This connector is for a chassis-mounted front panel audio I/O module that supports either HD Audio or legacy AC'97 audio standard. Connect one end of the front panel audio I/O module cable to this connector.

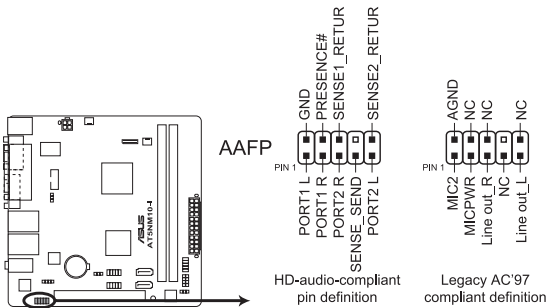

AT5NM10-I Analog front panel connector



We recommend that you connect a high-definition front panel audio module to this connector to avail of the motherboard's high-definition audio capability.



8. System panel connector (10-1 pin F_PANEL)

This connector supports several chassis-mounted functions.

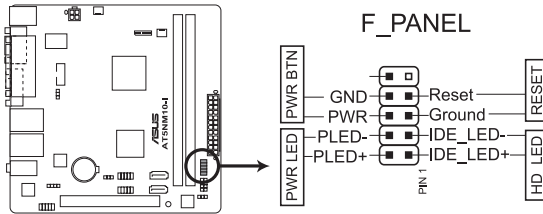

AT5NM10-I System panel connector

- **System power LED (2-pin PLED)**

This 2-pin connector is for the system power LED. Connect the chassis power LED cable to this connector. The system power LED lights up when you turn on the system power, and blinks when the system is in sleep mode.

- **Hard disk drive activity LED (2-pin HD_LED)**

This 2-pin connector is for the HDD Activity LED. Connect the HDD Activity LED cable to this connector. The HD LED lights up or flashes when data is read from or written to the HDD.

- **ATX power button/soft-off button (2-pin PWRBTN)**

This connector is for the system power button. Pressing the power button turns the system on or puts the system in sleep or soft-off mode depending on the BIOS settings. Pressing the power switch for more than four seconds while the system is ON turns the system OFF.

- **Reset button (2-pin RESET)**

This 2-pin connector is for the chassis-mounted reset button for system reboot without turning off the system power.

9. LVDS connector (30-pin CON1)

This connector is for a LCD monitor that supports Low-voltage differential signaling (LVDS) interface.

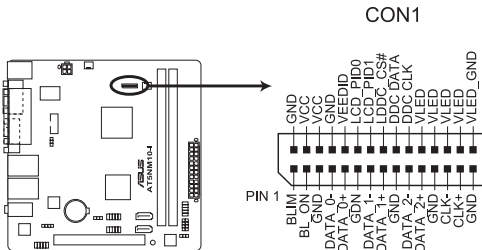

AT5NM10-I LVDS connector



10. Serial port connectors (10-1 pin COM2)

The connector is for a serial (COM) port. Connect the serial port module cable to the connector, then install the module to a slot opening at the back of the system chassis.



The serial port bracket (COM2) is purchased separately.

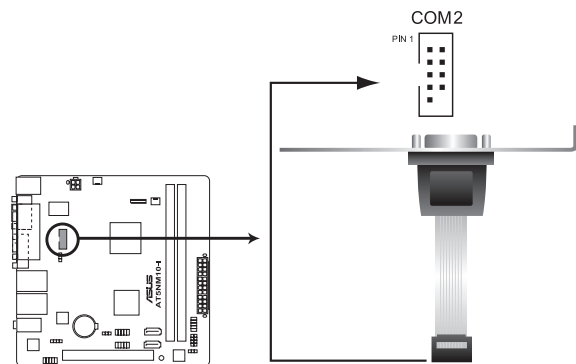

AT5NM10-I Serial port (COM2) connector

11. Digital audio connector (4-1 pin SPDIF_OUT)

This connector is for an additional Sony/Philips Digital Interface (S/PDIF) port. Connect the S/PDIF Out module cable to this connector, then install the module to a slot opening at the back of the system chassis.

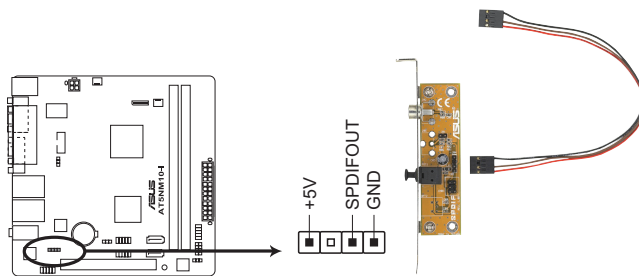

AT5NM10-I Digital audio connector



The S/PDIF module is purchased separately.





1.8 Software support

1.8.1 Installing an operating system

This motherboard supports Windows® XP/Vista/7 Operating Systems (OS). Always install the latest OS version and corresponding updates to maximize the features of your hardware.



- Motherboard settings and hardware options vary. Refer to your OS documentation for detailed information.
- Ensure that you install Windows® XP Service Pack 3 or later versions / Windows® Vista Service Pack 1 or later versions before installing the drivers for better compatibility and system stability.

1.8.2 Support DVD information

The Support DVD that comes with the motherboard package contains the drivers, software applications, and utilities that you can install to avail all motherboard features.



The contents of the Support DVD are subject to change at any time without notice. Visit the ASUS website at www.asus.com for updates.

To run the Support DVD

Place the Support DVD to the optical drive. The DVD automatically displays the Drivers menu if Autorun is enabled in your computer.



The following screen is for reference only.



Click an icon to display Support DVD/motherboard information

Click an item to install



If Autorun is NOT enabled in your computer, browse the contents of the Support DVD to locate the file ASSETUP.EXE from the BIN folder. Double-click the ASSETUP.EXE to run the DVD.





Chapter 2

BIOS information

2.1 Managing and updating your BIOS



Save a copy of the original motherboard BIOS file to a USB flash disk in case you need to restore the BIOS in the future. Copy the original motherboard BIOS using the ASUS Update utility.

2.1.1 ASUS Update utility

The ASUS Update is a utility that allows you to manage, save, and update the motherboard BIOS in Windows® environment.



- ASUS Update requires an Internet connection either through a network or an Internet Service Provider (ISP).
- This utility is available in the support DVD that comes with the motherboard package.

Installing ASUS Update

To install ASUS Update:

1. Place the support DVD in the optical drive. The **Drivers** menu appears.
2. Click the **Utilities** tab, then click **ASUS Update**.
3. Follow the onscreen instructions to complete the installation.



Quit all Windows® applications before you update the BIOS using this utility.

Updating the BIOS

To update the BIOS:

1. From the Windows® desktop, click **Start > Programs > ASUS > ASUSUpdate > ASUSUpdate** to launch the ASUS Update utility.
2. From the dropdown list, select any of the updating process:
 - Updating from the Internet*
 - a. Select **Update BIOS from the Internet**, then click **Next**.
 - b. Select the ASUS FTP site nearest you to avoid network traffic, or click **Auto Select** then click **Next**.
 - c. From the FTP site, select the BIOS version that you wish to download then click **Next**.



The ASUS Update utility is capable of updating itself through the Internet. Always update the utility to avail all its features.

Updating from a BIOS file

- a. Select **Update BIOS from a file**, then click **Next**.
 - b. Locate the BIOS file from the **Open** window, then click **Open**.
3. Follow the onscreen instructions to complete the updating process.

2.1.2 ASUS EZ Flash 2

The ASUS EZ Flash 2 feature allows you to update the BIOS without using an OS-based utility.



Before you start using this utility, download the latest BIOS file from the ASUS website at www.asus.com.

To update the BIOS using EZ Flash 2:

1. Insert the USB flash disk that contains the latest BIOS file to the USB port, then launch EZ Flash 2 in any of these two ways:
 - Press **<Alt> + <F2>** during POST.
 - Enter the BIOS setup program. Go to the **Tools** menu to select **EZ Flash 2** and press **<Enter>** to enable it.

Press **<Tab>** to switch between drives until the correct BIOS file is found.

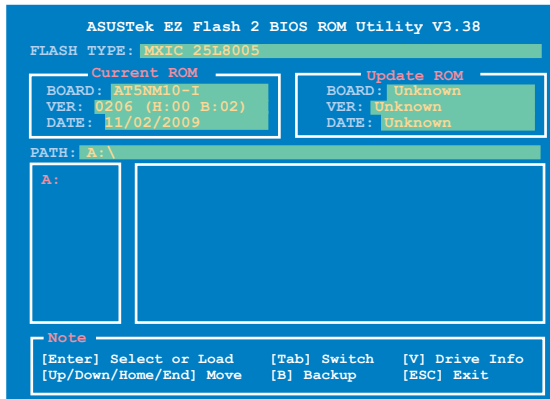

2. When the correct BIOS file is found, EZ Flash 2 performs the BIOS update process and automatically reboots the system when done.





-
- This function supports USB flash disks with **FAT 32/16** format and single partition only.
 - DO NOT shut down or reset the system while updating the BIOS to prevent system boot failure!
-

2.1.3 ASUS CrashFree BIOS

The ASUS CrashFree BIOS is an auto recovery tool that allows you to restore the BIOS file when it fails or gets corrupted during the updating process. You can restore a corrupted BIOS file using the motherboard support DVD or a removable device that contains the updated BIOS file.



-
- Before using this utility, rename the BIOS file in the removable device into AT5NM10I.ROM.
 - The BIOS file in the support DVD may not be the latest version. Download the latest BIOS file from the ASUS website at www.asus.com.
 - The removable device that ASUS CrashFree BIOS support vary with motherboard models. For motherboards without the floppy connector, prepare a USB flash disk before using this utility.
-

Recovering the BIOS

To recover the BIOS:

1. Turn on the system.
2. Insert the support DVD to the optical drive or the removable device that contains the BIOS file to the USB port or to the floppy disk drive, if supported.
3. The utility automatically checks the devices for the BIOS file. When found, the utility reads the BIOS file and starts flashing the corrupted BIOS file.
4. Turn off the system after the utility completes the updating process and turn on again.



DO NOT shut down or reset the system while updating the BIOS! Doing so can cause system boot failure!



Ensure to load the BIOS default settings to ensure system compatibility and stability. Select the **Load Setup Defaults** item under the Exit menu. Refer to section **2.8 Exit menu** for details.





2.2 BIOS setup program

Use the BIOS Setup program to update the BIOS or configure its parameters. The BIOS screens include navigation keys and brief online help to guide you in using the BIOS Setup program.

Entering BIOS Setup at startup

To enter BIOS Setup at startup:

- Press <Delete> during the Power-On Self Test (POST). If you do not press <Delete>, POST continues with its routines.

Entering BIOS Setup after POST

To enter BIOS Setup after POST:

- Press <Ctrl>+<Alt>+ simultaneously.
- Press the reset button on the system chassis.
- Press the power button to turn the system off then back on. Do this option only if you failed to enter BIOS Setup using the first two options.



Using the **power button**, **reset button**, or the <Ctrl>+<Alt>+ keys to force reset from a running operating system can cause damage to your data or system. We recommend to always shut down the system properly from the operating system.



- The default BIOS settings for this motherboard apply for most conditions to ensure optimum performance. If the system becomes unstable after changing any BIOS settings, load the default settings to ensure system compatibility and stability. Select the **Load Setup Defaults** item under the Exit Menu. See section 2.8 Exit Menu.
- The BIOS setup screens shown in this section are for reference purposes only, and may not exactly match what you see on your screen.
- Visit the ASUS website at www.asus.com to download the latest BIOS file for this motherboard.

2.3 Main menu

When you enter the BIOS Setup program, the **Main** menu screen appears, giving you an overview of the basic system information.

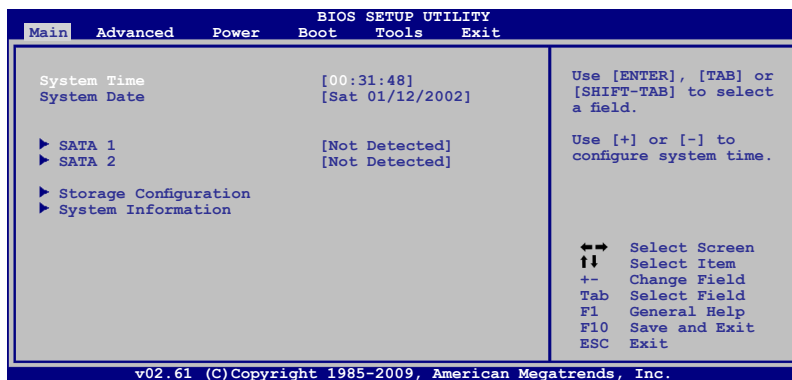



2.3.1 System Time [xx:xx:xx]

Allows you to set the system time.

2.3.2 System Date [Day xx/xx/xxxx]

Allows you to set the system date.

2.3.3 SATA 1/2

While entering Setup, the BIOS automatically detects the presence of SATA devices. There is a separate sub-menu for each SATA device. Select a device item then press <Enter> to display the SATA device information.

The BIOS automatically detects the values opposite the dimmed items (Device, Vendor, Size, LBA Mode, Block Mode, PIO Mode, Async DMA, Ultra DMA, and SMART Monitoring). These values are not user-configurable. These items show Not Detected if no Serial ATA device is installed in the system.

Type [Auto]

Selects the type of SATA drive. Setting to Auto allows automatic selection of the appropriate SATA device type. Select CDROM if you are specifically configuring a CD-ROM drive. Select ARMD (ATAPI Removable Media Device) if your device is either a ZIP, LS-120, or MO drive. Configuration options: [Not Installed] [Auto] [CDROM] [ARMD]

LBA/Large Mode [Auto]

Enables or disables the LBA mode. Setting to [Auto] enables the LBA mode if the device supports this mode, and if the device was not previously formatted with LBA mode disabled. Configuration options: [Disabled] [Auto]

Block (Multi-sector Transfer) Mode [Auto]

Enables or disables data multi-sectors transfers. When set to [Auto], the data transfer from and to the device occurs multiple sectors at a time if the device supports multi-sector transfer feature. When set to [Disabled], the data transfer from and to the device occurs one sector at a time. Configuration options: [Disabled] [Auto]

PIO Mode [Auto]

Selects the PIO mode. Configuration options: [Auto] [0] [1] [2] [3] [4]

DMA Mode [Auto]

Selects the DMA mode. Configuration options: [Auto]

SMART Monitoring [Auto]

Sets the Smart Monitoring, Analysis, and Reporting Technology. Configuration options: [Auto] [Disabled] [Enabled]

32Bit Data Transfer [Enabled]

Enables or disables 32-bit data transfer. Configuration options: [Disabled] [Enabled]





2.3.4 Storage Configuration

The items in this menu allow you to set or change the configurations for the SATA devices installed in the system. Select an item then press **<Enter>** if you want to configure the item.

Configure SATA as [IDE]

Sets the configuration for the Serial ATA connectors supported by the Southbridge chip. Configuration options: [IDE] [AHCI] [Disabled]

SATA Run Mode Configuration [Compatible]

Sets the SATA run mode configuration. Configuration options: [Compatible] [Enhanced]

2.3.5 System Information

This menu gives you an overview of the general system specifications. The BIOS automatically detects the items in this menu.

BIOS Information

Displays the auto-detected BIOS information.

Processor

Displays the auto-detected CPU specification.

System Memory

Displays the auto-detected system memory.

2.4 Advanced menu

The **Advanced** menu items allow you to change the settings for the CPU and other system devices.



Take caution when changing the settings of the Advanced menu items. Incorrect field values can cause the system to malfunction.

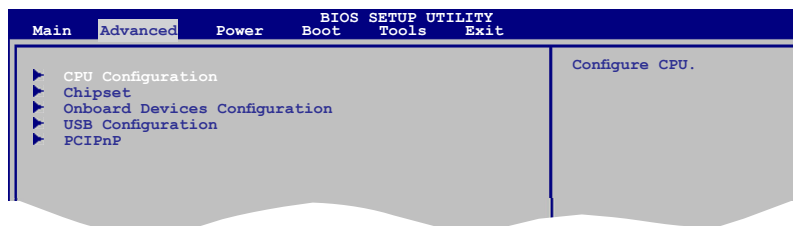



2.4.1 CPU Configuration

The items in this menu show the CPU-related information that the BIOS automatically detects.

Max CPUID Value Limit [Disabled]

Allows you to determine whether to limit CPUID maximum value. Set this item to [Disabled] for Windows XP operating system; set this item to [Enabled] for legacy operating system such as Windows NT4.0. Configuration options: [Disabled] [Enabled]

Execute-Disable Bit Capability [Enabled]

Allows you to enable or disable the No-Execution Page Protection Technology. Setting this item to [Disabled] forces the XD feature flag to always return to zero (0). Configuration options: [Disabled] [Enabled]

Hyper Threading Technology [Enabled]

Allows you to enable or disable the Intel® Hyper Threading technology. Configuration options: [Disabled] [Enabled]

2.4.2 Chipset

The **Chipset** menu allows you to change the advanced chipset settings. Select an item then press <Enter> to display the sub-menu.

North Bridge Configuration

DRAM Frequency [Auto]

Allows you to set the DDR2 operating frequency. Configuration options: [Auto] [667MHz] [800MHz]

Configure DRAM Timing by SPD [Enabled]

Allows you to enable or disable configuring the DRAM Timing by SPD. Configuration options: [Enabled] [Disabled]

Initiate Graphic Adapter [IGD]

Allows you to decide which graphics controller to use as the primary boot device. Configuration options: [IGD] [PCI/IGD]

Internal Graphics Mode Select [Enabled, 8MB]

Sets the IGD graphics mode. Configuration options: [Enabled, 4MB] [Enabled, 8MB]

Video Function Configuration

DVMT Mode Select [DVMT Mode]

Allows you to select the DVMT mode. Configuration options: [DVMT Mode]

DVMT/FIXED Memory [256MB]

Configuration options: [128MB] [256MB] [Maximum DVMT]

South Bridge Configuration

Audio Controller [Enabled]

Allows you to enable or disable the audio controller. Configuration options: [Disabled] [Enabled]





2.4.3 Onboard Devices Configuration

Onboard LAN [Enabled]

Allows you to enable or disable the onboard LAN controller.

Configuration options: [Enabled] [Disabled]

Onboard LAN Boot ROM [Disabled]

Allows you to enable or disable the boot ROM in the onboard LAN controller. This item appears only when the Onboard LAN item is set to Enabled. Configuration options: [Disabled] [Enabled]

Serial Port1 Address [3F8/IRQ4]

Allows you to select the Serial Port1 base address.

Configuration options: [Disabled] [3F8/IRQ4] [2E8/IRQ4] [2E8/IRQ3]

Serial Port1 Mode [Normal]

Allows you to set the Serial Port1 mode.

Configuration options: [Normal] [IrDA] [ASK IR]

Serial Port2 Address [2F8/IRQ3]

Allows you to select the Serial Port2 base address.

Configuration options: [Disabled] [2F8/IRQ3] [2E8/IRQ4] [2E8/IRQ3]

Serial Port2 Mode [Normal]

Allows you to set the Serial Port2 mode.

Configuration options: [Normal] [IrDA] [ASK IR]

Parallel Port Address [378]

Allows you to select the Parallel Port base addresses. Configuration options: [Disabled] [378] [278] [3BC]

Parallel Port Mode [SSP]

Allows you to select the Parallel Port mode.

Configuration options: [SSP] [EPP] [ECP] [EPP + ECP]

ECP Mode DMA Channel [DMA3]

Appears only when the Parallel Port Mode is set to [ECP]. This item allows you to set the Parallel Port ECP DMA. Configuration options: [DMA0] [DMA1] [DMA3]

Parallel Port IRQ [IRQ7]

Allows you to select parallel port IRQ. Configuration options: [IRQ5] [IRQ7]



2.4.4 USB Configuration

The items in this menu allows you to change the USB-related features. Select an item then press <Enter> to display the configuration options.



The Module Version and USB Devices Enabled items show the auto-detected values. If no USB device is detected, the item shows **None**.

USB Functions [Enabled]

Allows you to disable or enable the USB functions.

Configuration options: [Disabled] [Enabled]

USB 2.0 Controller [Enabled]

Allows you to enable or disable USB 2.0 controller.

Configuration options: [Enabled] [Disabled]

Legacy USB Support [Auto]

Allows you to enable or disable support for Legacy USB storage devices, including USB flash drives and USB hard drives. Setting to **[Auto]** allows the system to detect the presence of USB devices at startup. If detected, the USB controller legacy mode is enabled. If no USB device is detected, the legacy USB support is disabled.

Configuration options: [Disabled] [Enabled] [Auto]

USB 2.0 Controller Mode [HiSpeed]

Allows you to configure the USB 2.0 controller in HiSpeed (480Mbps) or Full Speed (12Mbps). Configuration options: [FullSpeed] [HiSpeed]



The following items may only appear when a USB storage device is plugged.

USB Mass Storage Device Configuration

USB Mass Storage Reset Delay [20 Sec]

Allows you to set the maximum time that the BIOS waits for the USB storage device to initialize. Configuration options: [10 Sec] [20 Sec] [30 Sec] [40 Sec]

Emulation Type [Auto]

Allows you to select the emulation type. Configuration options: [Auto] [Floppy] [Forced FDD] [Hard Disk] [CDROM]



2.4.5 PCI PnP

The PCI PnP menu items allow you to change the advanced settings for PCI/PnP devices. The menu includes setting IRQ and DMA channel resources for either PCI/PnP or legacy ISA devices, and setting the memory size block for legacy ISA devices.



Take caution when changing the settings of the PCI PnP menu items. Incorrect field values can cause the system to malfunction.

Plug and Play O/S [No]

When set to [No], BIOS configures all the devices in the system. When set to [Yes] and if you install a Plug and Play operating system, the operating system configures the Plug and Play devices not required for boot. Configuration options: [No] [Yes]

2.5 Power menu

The Power menu items allow you to change the settings for the Advanced Power Management (APM). Select an item then press <Enter> to display the configuration options.

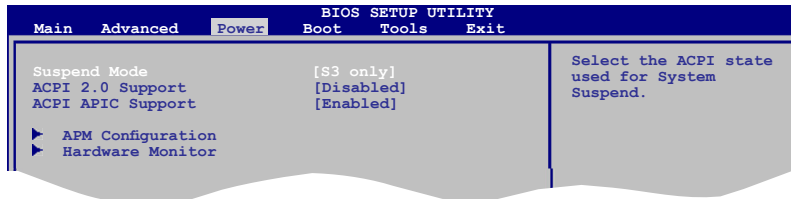

2.5.1 Suspend Mode [S3 Only]

Allows you to select the Advanced Configuration and Power Interface (ACPI) state to be used for system suspend. Configuration option: [S3 Only]

[S3 Only] - Enables the system to enter the ACPI S3 (Suspend to RAM) sleep state (default). In S3 sleep state, the system appears to be off and consumes less power than in the S1 state. When signaled by a wake-up device or event, the system resumes to its working state exactly where it was left off.

2.5.2 ACPI 2.0 Support [Enabled]

Allows you to add more tables for Advanced Configuration and Power Interface (ACPI) 2.0 specifications. Configuration options: [Disabled] [Enabled]

2.5.3 ACPI APIC Support [Enabled]

Allows you to enable or disable the Advanced Configuration and Power Interface (ACPI) support in the Application-Specific Integrated Circuit (ASIC). When set to Enabled, the ACPI APIC table pointer is included in the RSDT pointer list. Configuration options: [Disabled] [Enabled]



2.5.4 APM Configuration

Restore on AC Power Loss [Power Off]

When set to **[Power Off]**, the system goes into off state after an AC power loss. When set to **[Power On]**, the system goes on after an AC power loss. When set to **[Last State]**, the system goes into either off or on state, whatever the system state was before the AC power loss. Configuration options: [Power Off] [Power On] [Last State]

Power On By RTC Alarm [Disabled]

Allows you to enable or disable RTC to generate a wake event. When this item is set to Enabled, the items RTC Alarm Date, RTC Alarm Hour, RTC Alarm Minute, and RTC Alarm Second appear with set values. Configuration options: [Disabled] [Enabled]

Power On By Ring [Disabled]

Allows you to enable or disable RI to generate a wake event.
Configuration options: [Disabled] [Enabled]

Power On By PME [Disabled]

Enables or disables PME wake from sleep states. Configuration options: [Disabled] [Enabled]

Power On By PS/2 Keyboard [Disabled]

Allows you to use specific keys on the keyboard to turn on the system. This feature requires an ATX power supply that provides at least 1A on the +5VSB lead. Configuration options: [Disabled] [Space Bar] [Power Key] [Ctrl-Esc]

Power On By PS/2 Mouse [Disabled]

When set to [Enabled], this parameter allows you to use the PS/2 mouse to turn on the system. This feature requires an ATX power supply that provides at least 1A on the +5VSB lead. Configuration options: [Disabled] [Enabled]

2.5.5 Hardware Monitor

CPU/MB Temperature [xxx°C/xxx°F] or [Ignored]

The onboard hardware monitor automatically detects and displays the CPU/motherboard temperature. Select Ignored if you do not wish to display the detected temperatures.

CPU/Chassis Fan Speed [xxxxRPM] or [Ignored]

The onboard hardware monitor automatically detects and displays the CPU/chassis fan speeds in rotations per minute (RPM). If the fan is not connected to the motherboard, the field shows **N/A**. Select Ignored if you do not wish to display the detected speed.

VCORE Voltage, 3.3V Voltage, 5V Voltage, 12V Voltage [xxV] or [Ignored]

The onboard hardware monitor automatically detects the voltage output through the onboard voltage regulators.





2.6 Boot menu

The **Boot** menu items allow you to change the system boot options. Select an item then press **<Enter>** to display the sub-menu.

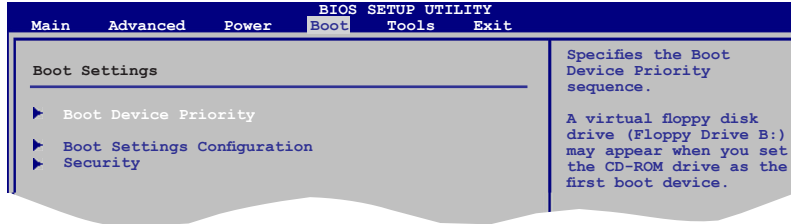

2.6.1 Boot Device Priority

1st ~ xxth Boot Device

These items specify the boot device priority sequence from the available devices. The number of device items that appears on the screen depends on the number of devices installed in the system. Configuration options: [Removable Dev.] [Hard Drive] [ATAPI CD-ROM] [Disabled]



- To select the boot device during system startup, press **<F8>** when ASUS Logo appears.
- To access Windows® OS in Safe Mode, do any of the following:
 - Press **<F5>** when ASUS Logo appears.
 - Press **<F8>** after POST.

2.6.2 Boot Settings Configuration

Quick Boot [Enabled]

Enabling this item allows the BIOS to skip some power on self tests (POST) while booting to decrease the time needed to boot the system. When set to **[Disabled]**, BIOS performs all the POST items. Configuration options: [Disabled] [Enabled]

Full Screen Logo [Enabled]

This allows you to enable or disable the full screen logo display feature. Configuration options: [Disabled] [Enabled]



Set this item to **[Enabled]** to use the ASUS MyLogo2™ feature.

AddOn ROM Display Mode [Force BIOS]

Sets the display mode for option ROM. Configuration options: [Force BIOS] [Keep Current]

Bootup Num-Lock [On]

Allows you to select the power-on state for the NumLock. Configuration options: [Off] [On]



Wait For 'F1' If Error [Enabled]

When set to **Enabled**, the system waits for the F1 key to be pressed when error occurs. Configuration options: [Disabled] [Enabled]

Hit 'DEL' Message Display [Enabled]

When set to **Enabled**, the system displays the message **Press DEL to run Setup** during POST. Configuration options: [Disabled] [Enabled]

2.6.3 Security

The **Security** menu items allow you to change the system security settings. Select an item then press **<Enter>** to display the configuration options.

Change Supervisor Password

Select this item to set or change the supervisor password. The **Supervisor Password** item on top of the screen shows the default **Not Installed**. After you set a password, this item shows **Installed**.

To set a Supervisor Password:

1. Select the **Change Supervisor Password** item and press **<Enter>**.
2. On the password box, key in a password containing up to six letters or numbers, or both, then press **<Enter>**.
3. Confirm the password when prompted.

The message **Password Installed** appears after you successfully set your password.

To change the supervisor password, follow the same steps in setting a supervisor password.

To clear the supervisor password, select the **Change Supervisor Password** then press **<Enter>** twice. The message **Password uninstalled** appears.



If you forget your BIOS password, you can clear it by erasing the CMOS Real Time Clock (RTC) RAM. See section 1.6 **Jumpers** for information on how to erase the RTC RAM.



After you have set a supervisor password, the other items appear to allow you to change other security settings.

User Access Level [Full Access]

This item allows you to select the access restriction to the Setup items.

Configuration options: [No Access] [View Only] [Limited] [Full Access]

[No Access] - prevents user access to the Setup utility.

[View Only] - allows access but does not allow change to any field.

[Limited] - allows changes only to selected fields, such as Date and Time.

[Full Access] - allows viewing and changing all the fields in the Setup utility.

Change User Password

Select this item to set or change the user password. The **User Password** item on top of the screen shows the default **Not Installed**. After you set a password, this item shows **Installed**.

To set a User Password:

1. Select the **Change User Password** item and press **<Enter>**.
2. On the password box, key in a password containing up to six letters or numbers, or both, then press **<Enter>**.
3. Confirm the password when prompted.

The message **Password Installed** appears after you set your password successfully.

To change the user password, follow the same steps in setting a user password.

Clear User Password

Select this item to clear the user password.

Password Check [Setup]

When set to **[Setup]**, BIOS checks for user password when accessing the Setup utility. When set to **[Always]**, BIOS checks for user password both when accessing Setup and booting the system. Configuration options: [Setup] [Always]



2.7 Tools menu

The Tools menu items allow you to configure options for special functions. Select an item then press **<Enter>** to display the sub-menu.

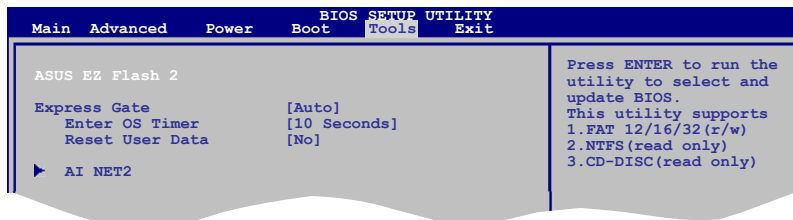

2.7.1 ASUS EZ Flash 2

Allows you to run ASUS EZ Flash 2. When you press **<Enter>**, a confirmation message appears. Use the left/right arrow key to select between **[Yes]** or **[No]**, then press **<Enter>** to confirm your choice. See section 2.1.2 **ASUS EZ Flash 2** for details.

2.7.2 Express Gate [Auto]

Allows you to enable or disable the ASUS Express Gate feature. ASUS Express Gate is a unique instant-on environment that provides quick access to the Internet and Skype. Configuration options: [Enabled] [Disabled] [Auto]

Enter OS Timer [10 Seconds]

Sets countdown duration that the system waits at the Express Gate's first screen before starting Windows or other installed OS. Choose **[Prompt User]** to stay at the first screen of Express Gate for user action. Configuration options: [Prompt User] [1 second] [3 seconds] [5 seconds] [10 seconds] [15 seconds] [20 seconds] [30 seconds]

Reset User Data [No]

Allows you to clear Express Gate's user data. Configuration options: [No] [Reset]
When setting this item to **[Reset]**, ensure to save the setting to the BIOS so that the user data will be cleared the next time you enter the Express Gate. User data includes the Express Gate's settings as well as any personal information stored by the web browser (bookmarks, cookies, browsing history, etc.). This is useful in the rare case where corrupt settings prevent the Express Gate environment from launching properly.



The first time wizard will run again when you enter the Express Gate environment after clearing its settings.



2.7.3 AI NET 2

Check Realtek LAN cable [Disabled]

Enables or disables checking of the Realtek LAN cable during the Power-On Self-Test (POST). Configuration options: [Disabled] [Enabled]

2.8 Exit menu

The Exit menu items allow you to load the optimal or failsafe default values for the BIOS items, and save or discard your changes to the BIOS items.

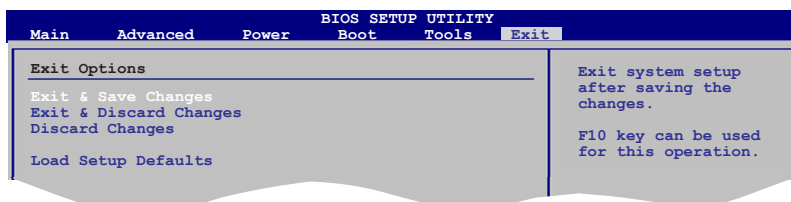

Pressing **<Esc>** does not immediately exit this menu. Select one of the options from this menu or **<F10>** from the legend bar to exit.



Free Manuals Download Website

<http://myh66.com>

<http://usermanuals.us>

<http://www.somanuals.com>

<http://www.4manuals.cc>

<http://www.manual-lib.com>

<http://www.404manual.com>

<http://www.luxmanual.com>

<http://aubethermostatmanual.com>

Golf course search by state

<http://golfingnear.com>

Email search by domain

<http://emailbydomain.com>

Auto manuals search

<http://auto.somanuals.com>

TV manuals search

<http://tv.somanuals.com>