

ASUS® A7N266

JumperFree™ DDR DRAM
266MHz FSB

NVIDIA® nForce 420™ Chipset
Socket A Motherboard

USER'S MANUAL

USER'S NOTICE

No part of this manual, including the products and software described in it, may be reproduced, transmitted, transcribed, stored in a retrieval system, or translated into any language in any form or by any means, except documentation kept by the purchaser for backup purposes, without the express written permission of ASUSTeK COMPUTER INC. ("ASUS").

ASUS PROVIDES THIS MANUAL "AS IS" WITHOUT WARRANTY OF ANY KIND, EITHER EXPRESS OR IMPLIED, INCLUDING BUT NOT LIMITED TO THE IMPLIED WARRANTIES OR CONDITIONS OF MERCHANTABILITY OR FITNESS FOR A PARTICULAR PURPOSE. IN NO EVENT SHALL ASUS, ITS DIRECTORS, OFFICERS, EMPLOYEES OR AGENTS BE LIABLE FOR ANY INDIRECT, SPECIAL, INCIDENTAL, OR CONSEQUENTIAL DAMAGES (INCLUDING DAMAGES FOR LOSS OF PROFITS, LOSS OF BUSINESS, LOSS OF USE OR DATA, INTERRUPTION OF BUSINESS AND THE LIKE), EVEN IF ASUS HAS BEEN ADVISED OF THE POSSIBILITY OF SUCH DAMAGES ARISING FROM ANY DEFECT OR ERROR IN THIS MANUAL OR PRODUCT.

Product warranty or service will not be extended if: (1) the product is repaired, modified or altered, unless such repair, modification or alteration is authorized in writing by ASUS; or (2) the serial number of the product is defaced or missing.

Products and corporate names appearing in this manual may or may not be registered trademarks or copyrights of their respective companies, and are used only for identification or explanation and to the owners' benefit, without intent to infringe.

- Intel and Pentium are registered trademarks of Intel Corporation.
- VIA is a registered trademark of VIA Technologies, Inc.
- 3Com is a registered trademark of 3Com Corporation.
- C-Media is a registered trademark of C-Media Electronics Inc.
- Windows and MS-DOS are registered trademarks of Microsoft Corporation.
- Adobe and Acrobat are registered trademarks of Adobe Systems Incorporated.
- Trend and ChipAwayVirus are trademarks of Trend Micro, Inc.
- Symbios is a registered trademark of Symbios Logic Corporation.
- nVidia is a registered trademark of NVIDIA Corporation.

The product name and revision number are both printed on the product itself. Manual revisions are released for each product design represented by the digit before and after the period of the manual revision number. Manual updates are represented by the third digit in the manual revision number.

For previous or updated manuals, BIOS, drivers, or product release information, contact ASUS at <http://www.asus.com.tw> or through any of the means indicated on the following page.

SPECIFICATIONS AND INFORMATION CONTAINED IN THIS MANUAL ARE FURNISHED FOR INFORMATIONAL USE ONLY, AND ARE SUBJECT TO CHANGE AT ANY TIME WITHOUT NOTICE, AND SHOULD NOT BE CONSTRUED AS A COMMITMENT BY ASUS. ASUS ASSUMES NO RESPONSIBILITY OR LIABILITY FOR ANY ERRORS OR INACCURACIES THAT MAY APPEAR IN THIS MANUAL, INCLUDING THE PRODUCTS AND SOFTWARE DESCRIBED IN IT.

Copyright © 2001 ASUSTeK COMPUTER INC. All Rights Reserved.

Product Name: **ASUS A7N266**
Manual Revision: **1.00 E853**
Release Date: **November 2001**

ASUS CONTACT INFORMATION

ASUSTeK COMPUTER INC. (Asia-Pacific)

Marketing

Address: 150 Li-Te Road, Peitou, Taipei, Taiwan 112
Telephone: +886-2-2894-3447
Fax: +886-2-2894-3449
Email: info@asus.com.tw

Technical Support

MB/Others (Tel): +886-2-2890-7121 (English)
Notebook (Tel): +886-2-2890-7122 (English)
Desktop/Server (Tel): +886-2-2890-7123 (English)
Fax: +886-2-2890-7698
Email: tsd@asus.com.tw
WWW: www.asus.com.tw
FTP: ftp.asus.com.tw/pub/ASUS

ASUS COMPUTER INTERNATIONAL (America)

Marketing

Address: 6737 Mowry Avenue, Mowry Business Center, Building 2
Newark, CA 94560, USA
Fax: +1-510-608-4555
Email: tmd1@asus.com

Technical Support

Fax: +1-510-608-4555
Email: tsd@asus.com
WWW: www.asus.com
FTP: ftp.asus.com/Pub/ASUS

ASUS COMPUTER GmbH (Europe)

Marketing

Address: Harkortstr. 25, 40880 Ratingen, BRD, Germany
Fax: +49-2102-442066
Email: sales@asuscom.de (for marketing requests only)

Technical Support

Hotline: MB/Others: +49-2102-9599-0 Notebook: +49-2102-9599-10
Fax: +49-2102-9599-11
Support (Email): www.asuscom.de/de/support (for online support)
WWW: www.asuscom.de
FTP: ftp.asuscom.de/pub/ASUSCOM

CONTENTS

1. INTRODUCTION	7
1.1 How This Manual Is Organized	7
1.2 Item Checklist	7
2. FEATURES	8
2.1 ASUS A7N266 Motherboard	8
2.1.1 Core Specifications	8
2.1.2 Connections	9
2.1.3 Performance and Intelligence	10
2.2 Motherboard Components	12
2.2.1 Component Locations	13
3. HARDWARE SETUP	14
3.1 Motherboard Layout	14
3.2 Layout Contents	15
3.3 Hardware Setup Procedure	16
3.4 Motherboard Settings	17
3.5 System Memory	23
3.5.1 DDR DIMM Support	23
3.5.2 Memory Installation	24
3.5.4 General DIMM Memo	25
3.6 Central Processing Unit (CPU)	26
3.7 Expansion Cards	27
3.7.1 Installing an Expansion Card	27
3.7.2 Assigning IRQs for Expansion Cards	28
3.7.3 Advanced Communication Riser (ACR) Slot	29
3.7.4 Accelerated Graphics Port (AGP) Pro Slot	30
3.8 Connectors	31
3.8.1 External Connectors	31
3.9 Starting Up the First Time	45
4. BIOS SETUP	47
4.1 Managing and Updating Your BIOS	47
4.1.1 Upon First Use of the Computer System	47
4.1.2 Updating BIOS Procedures	49
4.2 BIOS Setup Program	51
4.2.1 BIOS Menu Bar	52
4.2.2 Legend Bar	52

CONTENTS

4.3	Main Menu	54
4.3.1	Primary & Secondary Master/Slave	55
4.3.2	Keyboard Features	58
4.4	Advanced Menu	60
4.4.1	Chip Configuration	63
4.4.2	I/O Device Configuration	65
4.4.3	PCI Configuration	67
4.4.4	Shadow Configuration	69
4.5	Power Menu	70
4.5.1	Power Up Control	71
4.5.2	Hardware Monitor	72
4.6	Boot Menu	73
4.7	Exit Menu	75
5.	SOFTWARE SETUP	77
5.1	Install Operating System	77
5.2	Start Windows	77
5.3	A7N266 Series Motherboard Support CD	78
5.3.2	Installation Procedure	79
5.3.3	Manual Installation of Drivers for Windows 98	80
6.	SOFTWARE REFERENCE	82
6.1	ASUS Live Update	82
6.2	ASUS PC Probe	83
6.3	Multi-Channel Audio Feature Setup	88
6.4	3Deep Color Tuner	90
6.5	CyberLink PowerPlayer SE	92
6.6	CyberLink VideoLive Mail	93
7.	APPENDIX	95
7.1	Glossary	95
7.2	Modem Riser	99
7.2.1	56K Software Modem	99
7.2.2	Primary/Secondary MR	99
7.2.3	Hardware Installation Procedure	99
7.2.4	Software Setup in Windows 98	100
INDEX	101

FCC & DOC COMPLIANCE

Federal Communications Commission Statement

This device complies with FCC Rules Part 15. Operation is subject to the following two conditions:

- This device may not cause harmful interference, and
- This device must accept any interference received, including interference that may cause undesired operation.

This equipment has been tested and found to comply with the limits for a Class B digital device, pursuant to Part 15 of the FCC Rules. These limits are designed to provide reasonable protection against harmful interference in a residential installation. This equipment generates, uses and can radiate radio frequency energy and, if not installed and used in accordance with manufacturer's instructions, may cause harmful interference to radio communications. However, there is no guarantee that interference will not occur in a particular installation. If this equipment does cause harmful interference to radio or television reception, which can be determined by turning the equipment off and on, the user is encouraged to try to correct the interference by one or more of the following measures:

- Re-orient or relocate the receiving antenna.
- Increase the separation between the equipment and receiver.
- Connect the equipment to an outlet on a circuit different from that to which the receiver is connected.
- Consult the dealer or an experienced radio/TV technician for help.

WARNING! Any changes or modifications to this product not expressly approved by the manufacturer could void any assurances of safety or performance and could result in violation of Part 15 of the FCC Rules.

Reprinted from the Code of Federal Regulations #47, part 15.193, 1993. Washington DC: Office of the Federal Register, National Archives and Records Administration, U.S. Government Printing Office.

Canadian Department of Communications Statement

This digital apparatus does not exceed the Class B limits for radio noise emissions from digital apparatus set out in the Radio Interference Regulations of the Canadian Department of Communications.

This Class B digital apparatus complies with Canadian ICES-003.

Cet appareil numérique de la classe B est conforme à la norme NMB-003 du Canada.

1. INTRODUCTION

1.1 How This Manual Is Organized

This manual is divided into the following sections:

1. INTRODUCTION	Manual information and checklist
2. FEATURES	Production information and specifications
3. HARDWARE SETUP	Instructions on setting up the motherboard.
4. BIOS SETUP	Instructions on setting up the BIOS
5. SOFTWARE SETUP	Instructions on setting up the included software
6. SOFTWARE REFERENCE	Reference material for the included software
7. APPENDIX	Optional items and general reference

1.2 Item Checklist

Check that your package is complete. If you discover damaged or missing items, contact your retailer.

Package Contents

- (1) ASUS Motherboard
- (1) 40-pin 80-conductor ribbon cable for internal UltraDMA100/66/33 IDE drives
- (1) Extra 40-pin 80-conductor ribbon cable
- (1) Ribbon cable for two 3.5" floppy disk drives
- (1) ASUS Support CD with drivers and utilities
- (1) Bag of spare jumper caps
- (1) ASUS 2-port USB Connector Set
- (1) COM 2 Bracket
- (1) ASUS S/PDIF module (Audio Model Only)
- (1) Quick Set-up Guide and Reference Card (Retail Box only)
- (2) Games CD (Retail Box only)
- (1) User's Manual

Optional Items

- ASUS IrDA-compliant infrared module
- ASUS AGP-DVI/TV

2. FEATURES

2.1 ASUS A7N266 Motherboard

The ASUS A7N266 motherboard is a high-performance motherboard powered by AMD® Athlon™/Duron™ processors. It sports the new nVidia® Force 420™ chipset and features GeForce2™ MX GPU performance. The board offers users several advanced features to provide superlative performance. The A7N266 meets today's demand for a superior quality, fully integrated system.

2.1.1 Core Specifications

- **AMD® Athlon XP™ / Athlon™ / Duron™ Processor support:** Features the latest AMDs, 500MHz to 1.6 GHz and higher.
- **North Bridge System Chipset:** Features the brand new nVidia® nForce™ IGP-128 integrated GPU/North Bridge controller chipset. The controller supports a 64/128bit DDR memory controller integrated with a GeForce2 MX-class advanced Graphics Processing Unit (GPU) with a high performance dual pixel processing pipeline, a 256-bit 3D/2D graphics accelerator that supplies per pixel shading rasterization and a full AGP 4X interface, a digital video interface to DVI TV transmitters /TV encoders and an interface for up to 1.5 GB of 266/200MHz DDR SDRAM memory. The 128bit memory controller provides a phenomenal 4.2 GB/second system memory bandwidth.
- **South Bridge System Chipset:** Features the brand new nVidia® nForce™ MCP integrated peripheral South Bridge controller operates at 800MB/sec to communicate with the North Bridge for maximum bandwidth required for PCI, USB, AC'97 Audio/Modem and Fast Ethernet devices. The controller supports standard UltraDMA/100/66/33 for burst mode data transfer rates of up to 100MB/sec. Separate data paths for each IDE channel are built-in to support up to four IDE devices. The controller supports six USB ports and 5 PCI slots and is PCI rev 2.2 compliant. The MCH supplies an LPC 1.0 interface along with AT legacy functions, a clock synthesizer, and meets ACPI 1.0 and PCI Power Management 1.1 specifications.
- **PC2100 / PC1600 DDR Support:** Equipped with three Double Data Rate Dual Inline Memory Module (DDR DIMM) sockets to support up to 1.5GB of DDR DRAM. DDR DRAM supplies the highest bandwidth (64/128 bit) and offers the lowest latency currently available, improving the memory system's ability to service multimedia requirements.
- **Easy Frequency Changes:** Now, easily overclock all important frequency settings - simply and quickly through onboard BIOS firmware.
- **Smart BIOS:** 2Mb firmware enables Vcore and CPU/DDR SDRAM frequency adjustments, boot block write protection, and enhanced ACPI, DMI, Green, PnP Features Plus.

2. FEATURES

2.1.2 Connections

- **CPU socket:** Socket A (462) for Athlon XP™ / Athlon™ / Duron™ processors.
- **PCI Expansion Slots:** Provides five 32-bit PCI slots, (PCI 2.2 compliant) with no ISA. All PCI slots can support Bus Master PCI cards, such as SCSI or LAN cards. (PCI supports up to 133MB/s maximum throughput.) The MB supports Concurrent PCI, which allows multiple PCI transfers from PCI master bus to the memory and processor.
- **IDE connectors:** Dual-channel bus master IDE connectors support up to four Ultra DMA/100/66, PIO Modes 3 & 4 IDE devices like two HDDs, one DVD and an R/W CD.
- **AGP Pro Slot:** Comes with an Accelerated Graphics Port Pro slot that supports AGP cards for high performance, component level interconnect targeted at 3D graphical applications using a 4X mode bus. The slot is keyed to support only the latest 1.5 volt AGP cards.
- **Floppy disk connector:** Supports the floppy disk drive.
- **USB ports:** Six Universal Serial Bus (USB) ports are available for connecting USB devices such as a mouse and PDA.
- **Serial ports:** Two 9-pin COM1/COM2 ports are for all serial devices.
- **IrDA:** Supports an optional infrared port module for a wireless interface.
- **Microphone jack:** Pink jack connects a microphone. In 6-channel mode, the function of this jack enables Bass/Center audio output.
- **Line In jack:** Light blue jack connects a tape player or other audio sources. In 6-channel mode, this jack enables rear speaker audio output.
- **Line Out jack:** Lime jack connects a headphone or speakers. In 6-channel mode, this jack enables front speaker audio output.
- **Game/MIDI connector.** This connector supports a joystick or a game pad for playing games, and MIDI devices for playing or editing audio files.
- **Parallel port:** 25-pin port connects a parallel printer or other devices.
- **PS/2 mouse port:** Green 6-pin connector is for a PS/2 mouse.
- **PS/2 keyboard port:** Purple 6-pin connector is for a PS/2 keyboard.
- **Onboard Power LED:** Signals AC power is okay.
- **Onboard AGP Warning LED:** Signals AGP configuration problems.
- **ATX power connector.** Supplies the MB with ATX 12V power. The power supply must have at least 1A on the +5V standby lead (+5VSB).

2. FEATURES

2.1.3 Performance and Intelligence

- **UltraDMA/100 Support:** Comes with an onboard PCI Bus Master IDE controller with two connectors that support four IDE devices on two channels. Supports UltraDMA/100, UltraDMA/66, UltraDMA/33, PIO Modes 3 & 4, Bus Master IDE DMA Mode 2, and Enhanced IDE devices, such as DVD-ROM, CD-ROM, CD-R/RW, LS-120, and Tape Backup drives.
- **Super Multi-I/O:** The multi-I/O chipset offers complete support for a variety of I/O functions. Provides two high-speed UART compatible serial ports and one parallel port with EPP and ECP capabilities. UART2 can also be directed from COM2 to the Infrared Module for wireless connections. The Super I/O controller also supports a floppy disk drive, PS/2 keyboard, and PS/2 mouse.
- **DDR DRAM Optimized Performance:** Normal Double Data Rate Dynamic Random Access Memory (DDR DRAM) executes two actions per clock cycle and sets a new standard data transfer of up to 2.1 GB/s for 133MHz DDR DRAM and 1.6GB/s for 100MHz DDR DRAM. New **nVidia® TwinBank™** technology harnesses the DDR and “doubles the Double Data Rate:” The chipset further multiplies the bandwidth by 2 and offers a fabulously broad 4.2 GBs of memory bandwidth! (At least two of three DDR DIMM modules must be installed to activate this feature.)
- **Onboard Audio:** Audio models come with the six-channel C-Media CMI8738 PCI audio controller that supplies HRTF 3D positional audio functions. The chip supports software access to PC DVD 5.1/6.1 and AC-3/DTS via SPDIF. Other integrative features include: full DVD playback, PCtel 56K modem, and even Karaoke echo effects. A software package helps setup the multi-channel PC sound system.
- **C.O.P. Thermal Protection:** With AMD® Athlon XP™ installed, the motherboard offers users ASUS C.O.P. automatic CPU Overheating Protection to prolong the life of the entire system. If the CPU temperature becomes excessive, the PC shuts down automatically.
- **ACPI Ready:** Advanced Configuration Power Interface (ACPI) provides more Energy Saving Features for operating systems that support OS Direct Power Management (OSPM) functionality. With these features employed in the OS, PCs can be ready around the clock but comply with energy saving standards. To fully utilize the ACPI benefits, use an ACPI-supported OS like Windows XP.
- **PC'99 Compliant:** Both the BIOS and hardware levels of ASUS smart series motherboards are PC'99 compliant. The new PC'99 requirements for systems and components are based on the following high-level goals: Support for Plug-n-Play compatibility and power management to configure and manage all system components. in all major OS systems. Color-coded connectors and descriptive icons make identification easy as required by PC'99.

2. FEATURES

- **Two Onboard LEDs:** 1) A *green* LED lights up to indicate that power is available onboard. It reminds users that standby power is available. The LED also serves as a reminder to disconnect the power supply when making any change to the configuration. 2) A *red* onboard *warning* LED lights up only if the wrong type of AGP card is connected to the board.
- **Concurrent PCI:** Concurrent PCI allows multiple PCI transfers from PCI master busses to the memory and processor.
- **SMBus:** Features the System Management Bus interface used to physically transport commands and information between SMBus devices.
- **Desktop Management Interface (DMI):** Supports DMI through BIOS that allows hardware to communicate within a standard protocol and create a higher level of compatibility. (Requires DMI-enabled components.)
- **Enhanced ACPI and Anti-Boot Virus Protection:** Programmable BIOS (Flash EEPROM) that offers enhanced ACPI for Windows XP/2000/ME compatibility, built-in firmware-based virus protection, and autodetection of most devices for a virtual automatic setup.
- **Chassis Intrusion Detection:** Supports chassis-intrusion monitoring through the ASUS ASIC. A chassis intrusion event is kept in memory on battery power for more protection.
- **PC Health Monitoring:** Provides an easy way to test and manage system status information, such as CPU and system voltages, temperatures, and fan status through the onboard hardware ASUS ASIC and the bundled ASUS PC Probe.
- **Dual Function Power Button:** Pushing the power button for less than 4 seconds when the system is in the working state places the system into one of two states: sleep mode or soft-off mode, depending on the BIOS or OS setting (*See PWR Button < 4 Secs in 4.5 Power Menu*). When the power button is pressed for more than 4 seconds, the system enters the soft-off mode regardless of the BIOS setting.

2. FEATURES

2.2 Motherboard Components

See opposite page for locations.

	Location
Processor Support	Socket A for AMD® Athlon XP™, Athlon™ and Duron™ CPUs 1
Chipsets	nVidia® nForce™ IGP-128 North Bridge 2
	nVidia® nForce™ MCP South Bridge 12
	Multi-I/O controller 8
	2Mbit Programmable Flash EEPROM 9
Main Memory	Maximum 1.5GB support
	3 DDR DIMM Sockets 3
Expansion Slots	5 PCI Slots 18
	1 Accelerated Graphics Port (AGP) Pro/4X Slot 22
	1 Advanced Communication Riser slot 15
System I/O	1 Floppy Disk Drive Connector 7
	2 IDE Connectors (UltraDMA/100 Support) 6
	1 Parallel Port (Top) 25
	1 VGA Port (Bottom) 24
	1 Serial Port (COM1) (Bottom) 26
	1 Serial Header (COM2) 10
	USB Connectors (Port 0 & Port 1) (Bottom) 27
	USB Headers (Ports 2/3/4/5) 13
	Infrared Header (IrDA) 11
	1 PS/2 Mouse Connector (Top) 28
	1 PS/2 Keyboard Connector (Bottom) 28
Hardware Monitoring	System Voltage Monitor (with ASUS ASIC) 14
Network Feature	<i>(Network Models only)</i>
	Realtek® LAN Chip controller 17
	LAN (RJ-45) Connector (Top) 27
Audio Features	<i>(Audio Models only)</i>
	Cmedia® CMI8738 6-Channel Audio Controller 20
	Modem-Audio connector 16
	Onboard Aux and CD Audio Connectors 19
	1 Game/MIDI Port (Top) 23
	1 Line Out Connector (Bottom, left) 23
	1 Line In Connector (Bottom, center) 23
	1 Microphone Connector (Bottom, right) 23
Power	ATX Power Supply Connector 4
	Onboard Power LED (Green) 5
	Onboard AGP warning LED (Red) 21
Form Factor	ATX

2. FEATURES

2.2.1 Component Locations

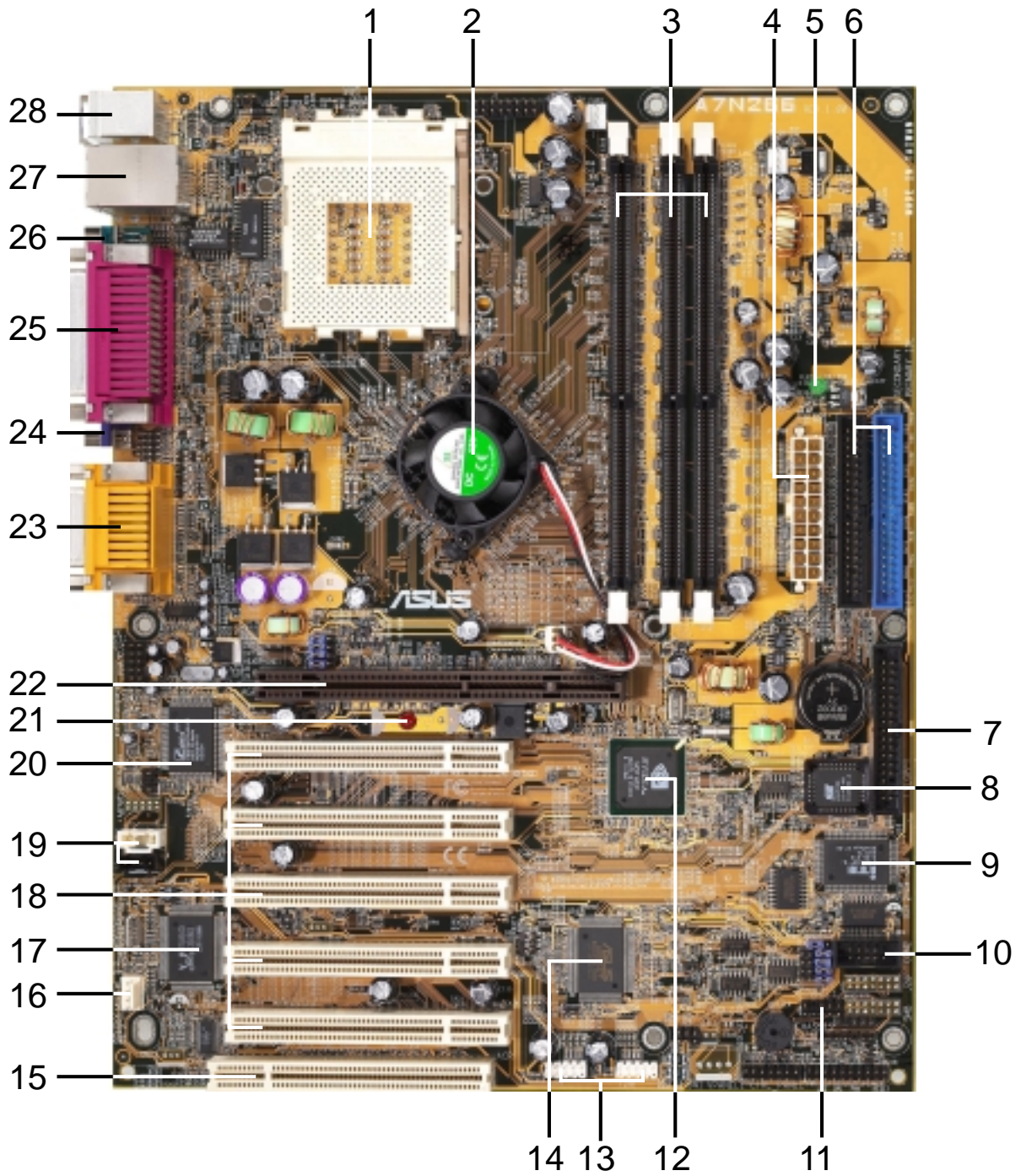

2. FEATURES
Motherboard Parts

3. HARDWARE SETUP

3.1 Motherboard Layout

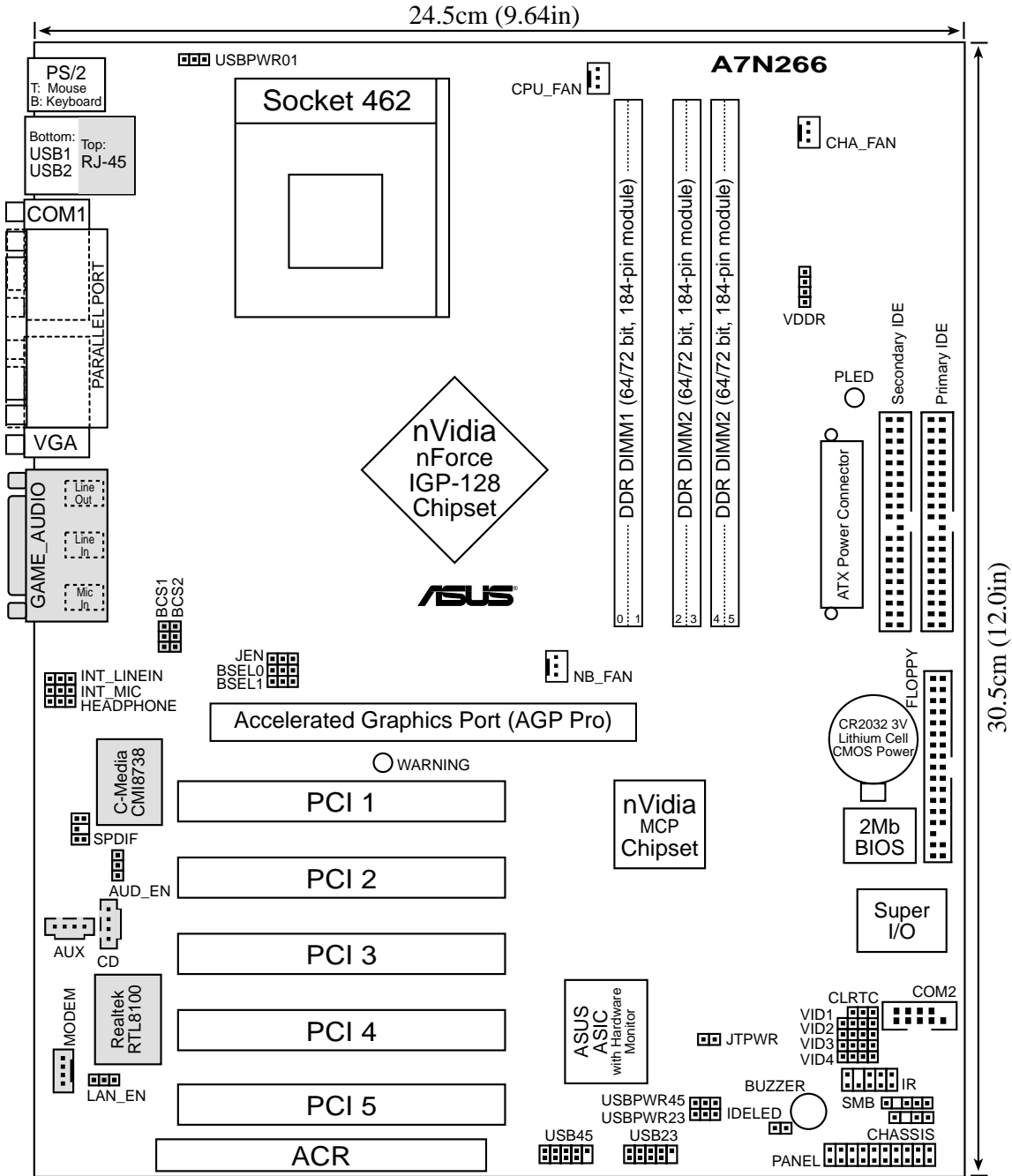

(Grayed components are optional at the time of purchase.)

3. HW SETUP
Motherboard Layout

3. HARDWARE SETUP

3.2 Layout Contents

Motherboard Settings

- | | |
|-----------------------------|---|
| 1) PLED, WARNING | p. 17 Onboard System Indicators |
| 2) JEN | p. 18 Jumperless Settings (Enable / Disable) |
| 3) BSEL0, BSEL1 | p. 18 CPU:DRAM Frequency Setting (100:100, 100:133, 133:100, 133:133) |
| 4) VID1, 2, 3, 4 | p. 19 Voltage Regulator Output Volt. Setting (1.675V-1.85 V) |
| 5) VDDR | p. 19 DDR Voltage Setting (2.7V, 2.6V, 2.5V) |
| 6) BCS1, BCS2 | p. 20 Bass / Center Setting (Center/Bass, Bass/Center) |
| 7) LAN_EN | p. 20 Onboard Network Setting (Enable / Disable) (<i>optional</i>) |
| 8) AUD_EN | p. 21 Onboard Network Setting (Enable / Disable) (<i>optional</i>) |
| 9) USB01 / USB23 / USB45PWR | p. 21 USB Device Wake-up (+5V / +5VSB) |
| 10) CLR_RTC | p. 22 Clear RTC RAM (2 pin contact) |

Expansion Slots/Sockets

- | | |
|------------------|---|
| 1) DIMM 1/2/3 | p. 23 System Memory Support |
| 2) Socket 462 | p. 26 CPU Support |
| 3) PCI 1/2/3/4/5 | p. 27 32-bit PCI Bus Expansion Slots |
| 4) AGP Pro | p. 29 Accelerated Graphics Port Slot |
| 5) ACR Slot | p. 30 Advanced Communication Riser Slot |

Connectors

- | | |
|------------------------|---|
| 1) PS2KBMS | p. 31 PS/2 Mouse Port (6 pin female) |
| 2) PS2KBMS | p. 31 PS/2 Keyboard Port (6 pin female) |
| 3) USB | p. 32 Universal Serial Bus Ports 1 & 2 (Two 4 pin female) |
| 4) PRINTER | p. 32 Parallel Port (25 pin female) |
| 5) RJ-45 | p. 32 Fast Ethernet Port Connector (9 pin male) |
| 6) COM 1 / 2 | p. 33 Serial Port / Header (9 pin male, 10-1 pin male) |
| 7) VGA | p. 33 VGA Port (15 pin female) |
| 8) GAME_AUDIO | p. 34 Game/MIDI Port (15 pin female) (<i>optional</i>) |
| 9) AUDIO | p. 34 Audio Connectors (Three 1/8") (<i>optional</i>) |
| 10) IDELED | p. 35 IDE Activity LED (2 pin) |
| 11) FLOPPY | p. 35 Floppy Disk Drive Connector (34 pin) |
| 12) PRIMARY / SEC. IDE | p. 36 IDE Connectors (Two 40-1 pin) |
| 13) CPU, NB, CHA_FAN | p. 37 CPU, NB, and Chassis Fan Connectors (Three 3 pin) |
| 14) USB_23 / USB_45 | p. 37 USB Headers (10-1 pin) |
| 15) IrDA | p. 38 Infrared Connector (10-1 pin) |
| 16) ATXPWR | p. 39 Power Supply Connectors (20 pin block) |

3. HARDWARE SETUP

17) SMB	p. 39 SMBus Connector (5-1 pin)
18) CD, AUX, MODEM	p. 40 Internal Audio Connectors (4-1 pin) (<i>optional</i>)
19) INT_MIC	p. 40 Internal Microphone Connector (3 pin) (<i>optional</i>)
20) HPHONE	p. 41 Headphone True-level Line Out Header (3-pin) (<i>optional</i>)
21) INT_LINEIN	p. 41 Line In Header (3 pin) (<i>optional</i>)
22) S/PDIF	p. 42 Digital Audio Interfaces (2 pin) (<i>optional</i>)
23) CHASSIS	p. 42 Chassis Open Alarm Lead (4 pin)
24) JTPWR	p. 43 Power Supply Thermal Sensor Connector (2 pin)
25) PWR.LED	p. 44 System Power LED Lead (3 pin)
26) KEYLOCK	p. 44 System Keyboard Lock Switch Lead (2 pin)
27) SPEAKER	p. 44 System Warning Speaker Lead (4 pin)
28) LED	p. 44 System Message LED Lead (2 pin)
29) SMI	p. 44 System Management Interrupt Lead (2 pin)
30) PWR	p. 44 ATX / Soft-Off Switch Lead (2 pin)
31) RESET	p. 44 Reset Switch Lead (2 pin)

3.3 Hardware Setup Procedure

Complete these procedures before powering up the computer:

1. **Check motherboard settings**
2. **Install memory modules**
3. **Install the Central Processing Unit (CPU)**
4. **Install Expansion Cards**
5. **Connect ribbon cables, panel wires, and power supply cables**
6. **Configure the BIOS parameter settings**

All pertinent information to configure settings and power up the computer for the first time appears in the following pages.

3. HARDWARE SETUP

3.4 Motherboard Settings

This section tells you how to change motherboard function settings through the switches and/or jumpers.

WARNING! Computer motherboards and expansion cards contain very delicate Integrated Circuit (IC) chips. To avoid damaging them due to static electricity, follow these precautions whenever you work on your computer.

1. Unplug the computer when working on the internal components.
2. Use a grounded wrist strap or touch a safely grounded object or to a metal object, such as the power supply case, before handling computer components.
3. Hold components by the edges and try not to touch the IC chips on them.
4. Whenever you uninstall any component, place the components on a grounded antistatic pad or in the bag that came with the components.
5. **Before you install or remove any component, ensure that the ATX power supply is switched off or the power cord is detached from the power supply.** Failure to do so may cause severe damage to the motherboard, peripherals, and/or components.

1) Onboard System Indicators (LED - Light Emitting Diodes)

The GREEN onboard LED indicates that the system power is okay. This light also lights when the PC is in suspend or soft-off mode. The RED onboard LED lights up only if the wrong type of AGP card is connected to the board: (See *AGP Pro*, p. 32)

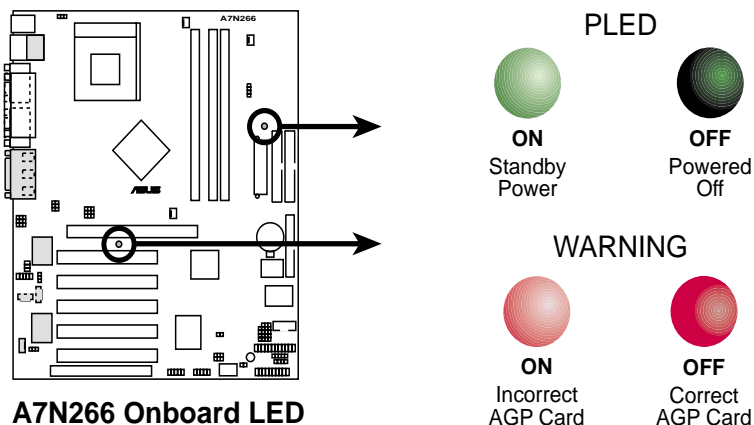

3. HARDWARE SETUP

2) Jumperless Setting (JEN)

Normally, all changes to frequency settings can be made through BIOS immediately upon starting up the computer. Therefore, the default setting for this jumper, [2-3] enables easy BIOS adjustments. If the BSEL jumpers are used, it is necessary to set this JEN jumper to [1-2].

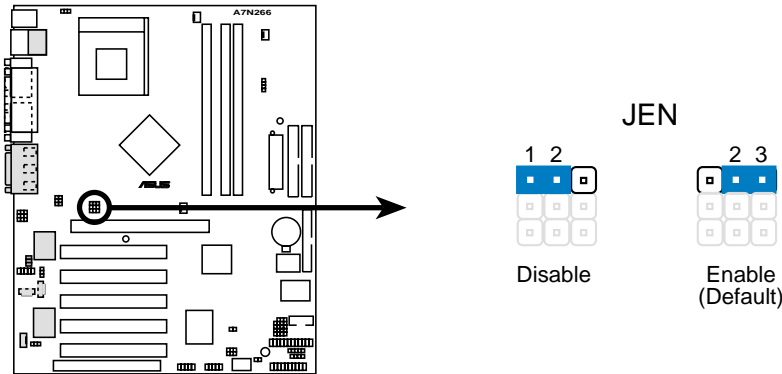

A7N266 Jumper Mode Setting

3) CPU:DRAM Frequency Setting (BSEL0, BSEL1)

This jumper sets the external CPU:DRAM frequency ratio for normal operation. The default operates at 100:100 Mhz. *Note:* To make any changes to jumper speed settings, the JEN jumper must be set to [1-2].

CPU	DRAM	BSEL0	BSEL1	JEN
133	133	[1-2]	[1-2]	[1-2]
133	100	[2-3]	[1-2]	[1-2]
100	133	[2-3]	[2-3]	[1-2]
100	100	[1-2] (Default)	[2-3] (Default)	[1-2]

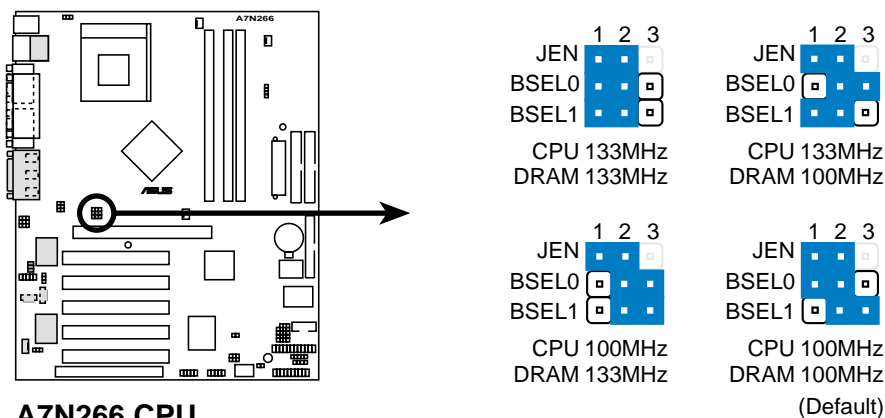

A7N266 CPU External Frequency Selection

3. HARDWARE SETUP

4) Voltage Regulator Output Setting (VID1, VID2, VID3, VID4)

This jumpers allow you to manually adjust the CPU core voltage. It is recommended to use **CPU Default** as the CPU core voltage. **CPU Default** means the Vcore is generated according to the CPU VID configuration. For each jumper setting, there are two voltage options, depending on the CPU used.

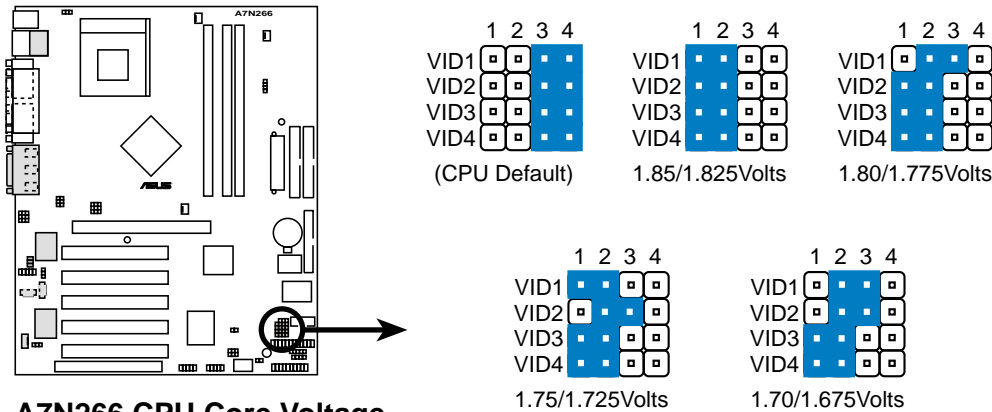

A7N266 CPU Core Voltage Selection

5) DDR Voltage Setting (VDDR)

This jumper controls the voltage output to the DDR memory DRAMS. Less strain is placed on components at lower voltage settings.

Setting	VDDR
2.7V	[1-2]
2.6V	[2-3] (default)
2.5V	[3-4]

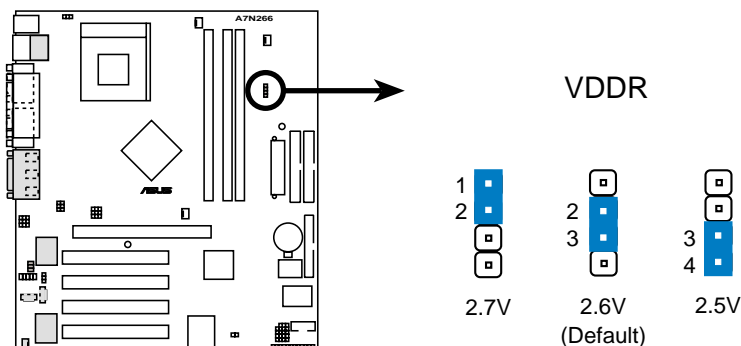

A7N266 VDDR Setting

3. HARDWARE SETUP

6) Bass / Center Setting (BCS1, BCS2)

Use these jumpers in conjunction with the C-Media PCI Audio Driver to adjust output for 4 or 6 speaker audio. Since no audio standard exists for the three pick-up surfaces on male audio jacks, it may be necessary to switch jumpers from the default position, Center/Bass, to Bass /Center in order to reroute signals to the *Line-In*, *Line-Out* and *Mic* sockets. Make a test using the C-Media Audio Driver software setup available on the Support CD.

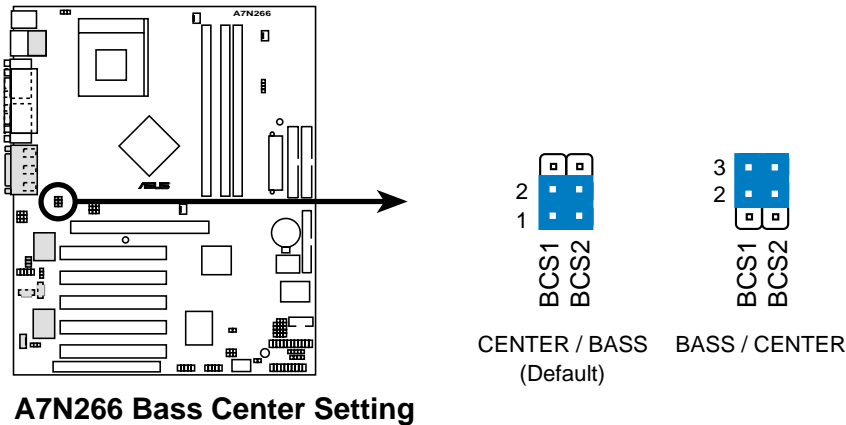

7) Onboard Network Setting (LAN_EN) (LAN Models only)

The onboard LAN network chip (RTL8100) may be activated or deactivated. The operational default, [1-2], already enables the network function. Reset to [2-3] to disable the onboard ethernet.

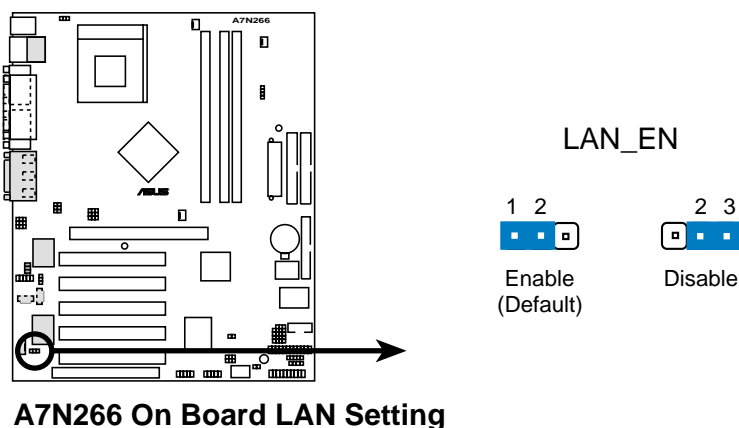

3. HARDWARE SETUP

8) Onboard Audio Setting (AUD-EN) (Audio Models only)

The onboard 6 channel audio chip functions as the primary audio circuit, and may be enabled or disabled with this jumper. The default setting, [1-2], enables the onboard audio chip. Reset the jumper to [2-3], disabling the onboard Audio chip, if using a PCI audio card, or if a *primary* audio Advanced Communications Riser card is used in the ACR slot. (See page 29, 3.7.3, ACR Slot)

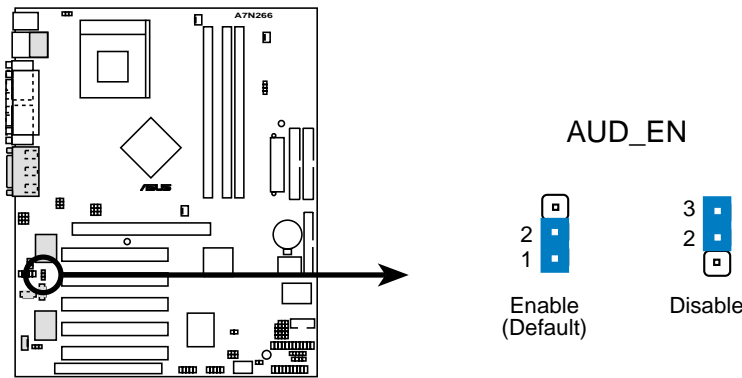

A7N266 Audio Codec Setting

9) USB Device Wake-up (USB01PWR / USB23PWR / USB45PWR)

Set these jumpers to +5V to allow wake up from the S1 sleep state (CPU stopped; RAM refreshed; system running in low power mode). Set to +5VSB to allow wake up from other sleep states. The default setting for the three jumpers is [1-2] to select +5V, since not all computers have the appropriate power supply.

NOTE: This feature requires an ATX power supply that can supply at least 2A on the +5VSB lead when these jumpers are set to +5VSB. Otherwise, the system does not power up. The total current consumed must NOT exceed the power supply capability (+5VSB) for normal working conditions or in sleep mode.

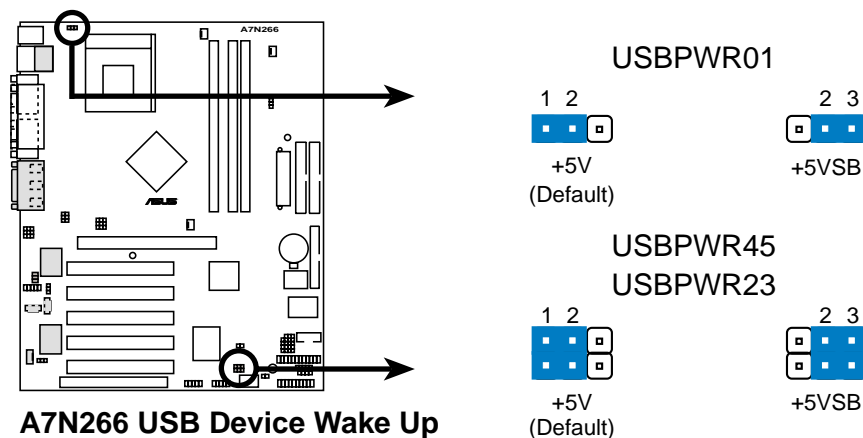

A7N266 USB Device Wake Up

3. HARDWARE SETUP

10) Clear RTC RAM (2-pin CLR_RTC)

This jumper allows you to reset the Real Time Clock (RTC) RAM in CMOS. The RAM data in CMOS, that include system setup information such as system passwords, is powered by the onboard button cell battery. Erase the RTC RAM:

1. Turn OFF the computer and unplug the power cord.
2. Remove the battery.
3. Change the jumper from “normal” to “clear CMOS” for a few seconds then replace the jumper cap to the “normal” position.
4. Re-install the battery.
5. Plug the power cord and turn ON the computer.
6. Hold down the key during boot-up to enter BIOS setup.

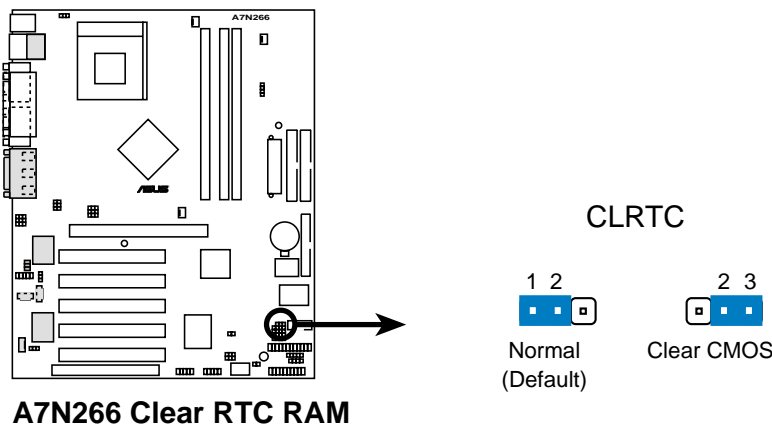

3. HARDWARE SETUP

3.5 System Memory

3.5.1 DDR DIMM Support

The three DDR DIMM sockets support **2.5Volt** (power level) Double Data Rate Synchronous Dynamic Random Access Memory (DDR SDRAM) of 64MB, 128MB, 256MB and 512MB to form a memory size between 64MB to 1.5GB. One side (with memory chips) of the DIMM takes up one row on the motherboard.

TwinBank™ Technology: to function at 128-bit, 4.2 GB/second “Dual channel DDR mode”, *at least 2 or more* DIMM modules must be installed; with only one DIMM installed, the memory functions at only 64-bit, normal mode.

~ DDR DIMMs on this motherboard support only 184-pin, unbuffered, non-ECC memory. DDR DIMMs with CAS Latency of 2.0 (PC2100A) or 2.5 (PC2100B) are both supported. (See the General DIMM memo on page 27 for details.)

Configuration Rules:

1. DIMMs must be populated consecutively, in order, starting with DIMM Socket 1, then 2 and 3.
2. The total number of banks must not exceed five: ie.: two dual load modules and one single load module. **Note:** Do not populate DIMM Socket 3 with any dual load modules.

Memory Population:

Memory loads must be distributed according to the various possible combinations shown in the following table:

Capacity	DIMM 1 (A0)	DIMM2 (B0)	DIMM3 (B1)
128 MB	64MB - 1B or 2B	64MB - 1B or 2B	X
192 MB	128MB - 1B or 2B	64MB - 1B or 2B	X
256 MB	128MB - 1B or 2B	128MB - 1B or 2B	X
	128MB - 1B or 2B	64MB - 1B or 2B	64MB - 1B
384 MB	256MB - 1B or 2B	128MB - 1B or 2B	X
	128MB - 1B or 2B	128MB - 1B or 2B	128MB - 1B
512 MB	256MB - 1B or 2B	256MB - 1B or 2B	X
	256MB - 1B or 2B	128MB - 1B or 2B	128MB - 1B
786 MB	512MB - 1B or 2B	256MB - 1B or 2B	X
	256MB - 1B or 2B	256MB - 1B or 2B	256MB - 1B
1 GB	512MB - 1B or 2B	512MB - 1B or 2B	X
	512MB - 1B or 2B	256MB - 1B or 2B	256MB - 1B
1.25 GB	512MB - 1B or 2B	512MB - 1B or 2B	256MB - 1B
1.5 GB	512MB - 1B or 2B	512MB - 1B or 2B	512MB - 1B

Table Legend:

1B = 1 bank: a single load module. 2B = 2 bank: a dual load module.

3. HARDWARE SETUP

3.5.2 Memory Installation

WARNING! Make sure that you unplug your power supply when adding or removing memory modules or other system components. Failure to do so may cause severe damage to both your motherboard and expansion cards (see **3.3 Hardware Setup Procedure** for more information).

Insert the module(s) as shown. Because the number of pins are different on either side of the breaks, the module will only fit in the orientation shown. A 184-pin DDR DRAM DIMM has a single notch slightly to the right of center.

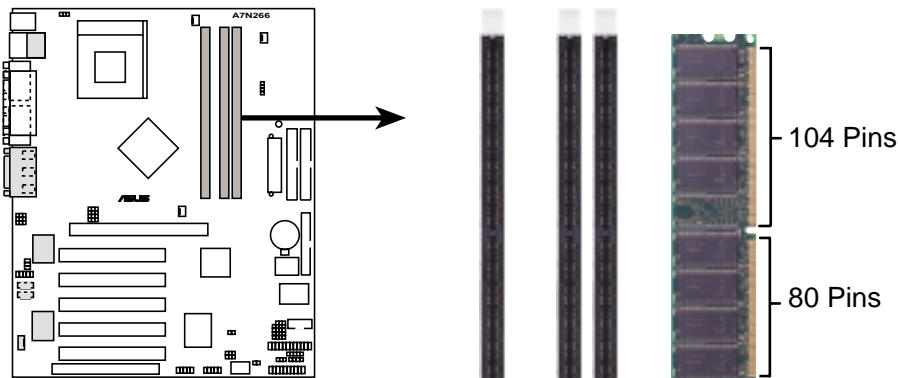

A7N266 184-Pin DDR DIMM Sockets

Installing a DIMM:

1. Unlock a DIMM socket by pressing the retaining clips outward.
2. Align a DIMM on the socket such that the notches on the DIMM exactly match the notches in the socket.
3. Firmly insert the DIMM into the socket until the retaining clips snap back in place.

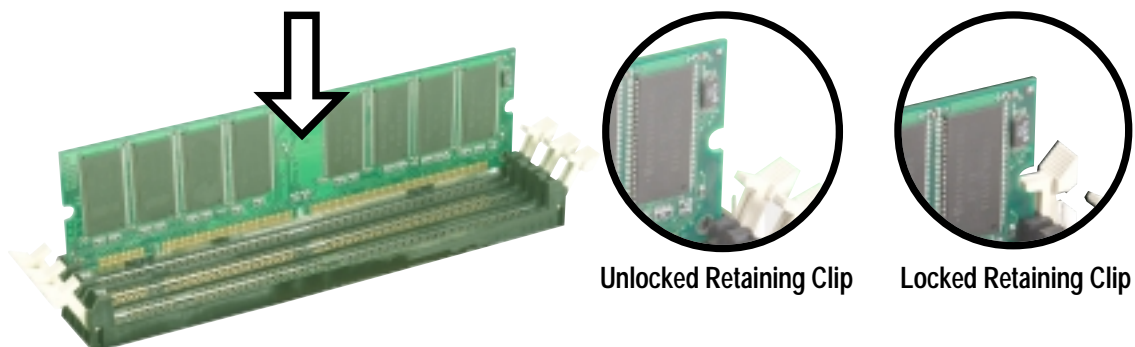

3. HARDWARE SETUP

Removing a DIMM:

1. Simultaneously press the retaining clips outward to unlock the DIMM.
2. Carefully remove the DIMM from the socket.

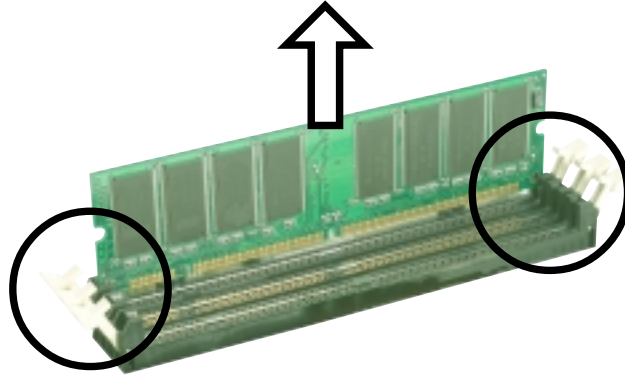

3.5.4 General DIMM Memo

- See the *Configuration Rules* on page 23 for essential installation parameters.
- **DIMMs that have more than 18 chips are not supported on this motherboard.**
- ASUS motherboards support SPD (Serial Presence Detect) DIMMs. This is the memory of choice for best performance vs. stability.
- BIOS shows DDR RAM memory on bootup screen.
- This motherboard supports three pairs of differential clock signals per DIMM.
- Single load DDR DIMMs are available in 64, 128, and 256MB; dual load modules are available in 128, 256, and 512MB.

3. HARDWARE SETUP

3.6 Central Processing Unit (CPU)

The motherboard provides a Socket A (462) for CPU installation. A fan and heatsink should be attached to the CPU to prevent overheating.

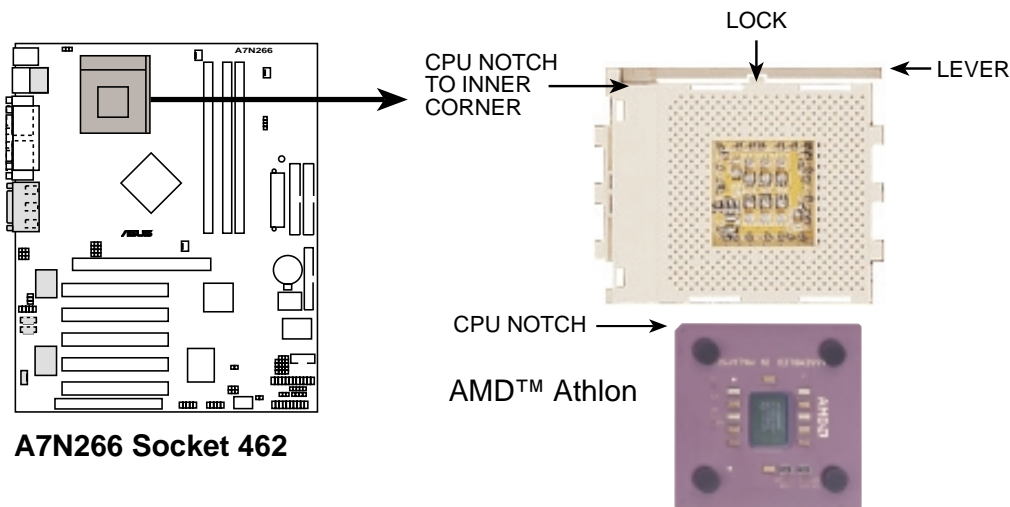

1. Locate the Socket 462 and open it by pulling the lever gently sideways away from the socket. Then lift the lever upwards. The socket lever must be fully opened (90 to 100 degrees).
2. Insert the CPU with the correct orientation. The **notched corner** of the CPU must be oriented toward the inner corner of the socket base nearest to the lever hinge.

CAUTION! The CPU should drop easily into place. **Do not force the CPU** into the socket to avoid bending the pins. If the CPU does not fit, check its alignment and look for bent pins.

3. Once completely inserted, press the CPU firmly and close the socket lever until it snaps shut.
4. Place the CPU fan and heatsink on the CPU. The heatsink should entirely cover the CPU. Carefully attach the heatsink locking brace to the plastic clips on the socket base. With the added weight of the CPU fan and heatsink locking brace, no extra force is required to keep the CPU in place.

CAUTION! Take care not to scrape the motherboard surface when mounting a clamp-style processor fan, or else damage may occur. When mounting a heatsink onto your CPU, make sure that exposed CPU capacitors do not touch the heatsink, or damage may occur!

NOTE! Do not neglect to set the correct Bus Frequency and leave the CPU Multiple setting at default to avoid start-up problems.

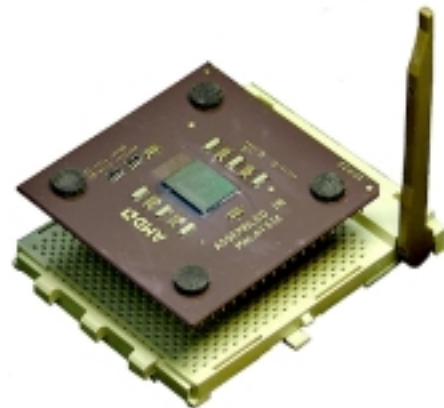

3. HARDWARE SETUP

3.7 Expansion Cards

In the future, you may need to install expansion cards. The motherboard has five PCI expansion slots to support these cards. Follow the steps in the next section when installing expansion cards.

WARNING! Unplug the system power cord when adding or removing expansion cards or other system components. Failure to do so may cause severe damage to both the motherboard and expansion cards.

3.7.1 Installing an Expansion Card

1. Read the documentation that comes with the expansion card and make any necessary hardware settings for the card before installing it.
2. Remove the system unit cover and the bracket plate on the slot you intend to use. Keep the screw for later use.
3. Align the card connectors with the slot and press firmly until the card fits in place.
4. Secure the card to the slot with the screw you removed earlier.
5. Replace the system cover.
6. Change the necessary BIOS settings, if any.
(see section **4.4.3 PCI Configuration** to change the settings.)
7. Install the necessary software drivers for the expansion card.

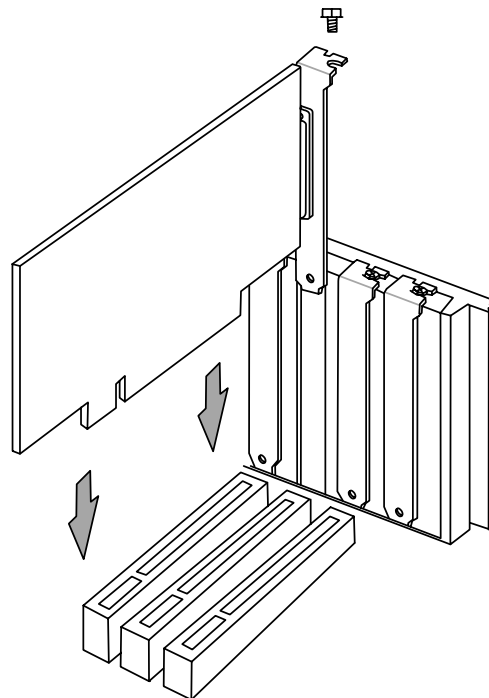

3. HARDWARE SETUP

3.7.2 Assigning IRQs for Expansion Cards

Some expansion cards need an IRQ to operate. Generally, an IRQ must be exclusively assigned to one use. In a standard design, there are 16 IRQs available but most of them are already in use, leaving 6 IRQs free for expansion cards. If your motherboard has **PCI** audio onboard, an additional IRQ will be used. If your motherboard also has **MIDI** enabled, another IRQ will be used, leaving 4 IRQs free.

IMPORTANT: If using PCI cards on shared slots, make sure that the drivers support “Share IRQ” or that the cards do not need IRQ assignments. Conflicts arise between the two PCI groups that will make the system unstable or cards inoperable.

The following table lists the default IRQ assignments for standard PC devices. Use this table when configuring your system and for resolving IRQ conflicts.

Standard Interrupt Assignments

IRQ	Priority	Standard Function
0	1	System Timer
1	2	Keyboard Controller
2	N/A	Programmable Interrupt
3*	11	Communications Port (COM2)
4*	12	Communications Port (COM1)
5*	13	Sound Card (sometimes LPT2)
6	14	Floppy Disk Controller
7*	15	Printer Port (LPT1)
8	3	System CMOS/Real Time Clock
9*	4	ACPI Mode when used
10*	5	IRQ Holder for PCI Steering
11*	6	IRQ Holder for PCI Steering
12*	7	PS/2 Compatible Mouse Port
13	8	Numeric Data Processor
14*	9	Primary IDE Channel
15*	10	Secondary IDE Channel

*These IRQs are usually available for ISA or PCI devices.

3. HARDWARE SETUP

Interrupt Request Table for this Motherboard

	INT-A	INT-B	INT-C	INT-D	INT-E
PCI slot 1	shared	—	—	—	—
PCI slot 2	—	—	—	shared	—
PCI slot 3	—	—	used	—	—
PCI slot 4	—	shared	—	—	—
PCI slot 5	shared	—	—	—	—
AGP	—	—	—	—	used
ACR slot	shared	—	—	—	—
Audio controller	—	shared	—	—	—
USB controller	—	—	—	shared	—

3.7.3 Advanced Communication Riser (ACR) Slot

This motherboard has an Advanced Communication Riser (ACR) slot for communications and audio subsystems. The slot supports modem, audio, LAN, and Home Phonenumber Networking Alliance (HPNA) or Home Networking cards. This ACR slot is backward compatible with ISA-side AMR cards only.

IMPORTANT: Only the ASUS **ACR-A6CH** Audio Communications Riser card is recommended for use with this motherboard in the ACR slot. It is impossible to install another card in the adjacent PCI slot since they are using the same space.

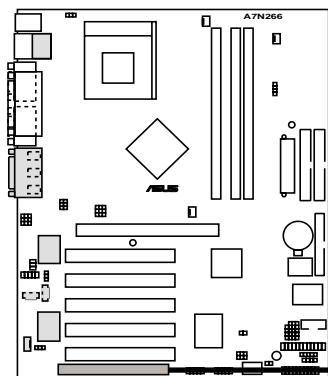

A7N266 Advanced Communication Riser (ACR)

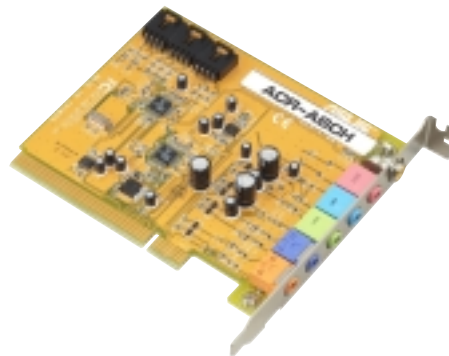

3. HARDWARE SETUP

3.7.4 Accelerated Graphics Port (AGP) Pro Slot

This motherboard has an Accelerated Graphics Port (AGP) Pro slot to support the new generation graphics cards with ultra-high memory bandwidth.

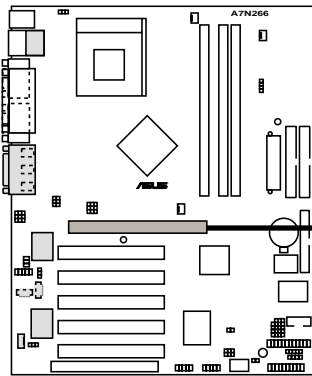

A7N266 Accelerated Graphics Port (AGP PRO)

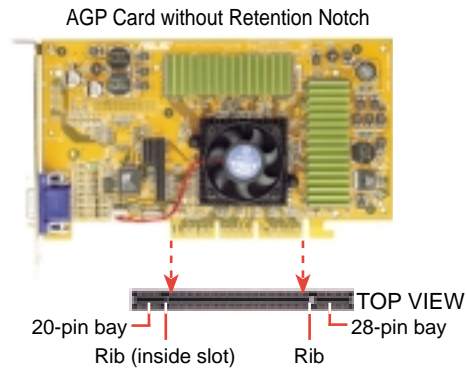

CAUTION! The AGP Pro slot is shipped with a warning label over the 20-pin bay. DO NOT remove this label and the safety tab underneath it if you are using an AGP card *without* a retention notch. Removing may cause the card to shift and may cause damage to the card, slot, and motherboard. Remove the label and tab **ONLY** if you are using an *AGP Pro* card. Use a rigid tip, such as a pen tip, to dislodge the white tab.

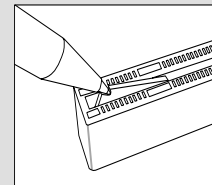

Removing the tab

An early 3.3V AGP card:
Do not use.

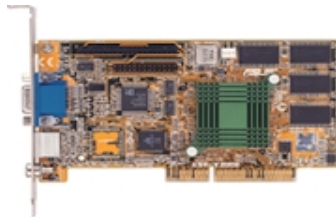

A new 1.5 / 3.3V AGP card:
OKAY to use.



IMPORTANT: Only 1.5V AGP cards are supported. ASUS® AGP 4X cards are rated for both 1.5 and 3.3 Volts. Early AGP cards only operate at 3.3 volts and will not fit properly into the new AGP 4X slots. See examples of both types above. If the wrong type of AGP card is installed, such as an SiS305, or any other 3.3V AGP card, the onboard RED LED lights up immediately. So long as the LED is illuminated and the wrong card remains installed, the system power will not turn on, an automatic safety precaution to prevent damage to the motherboard.

3. HARDWARE SETUP

3.8 Connectors

3.8.1 External Connectors

WARNING! Some pins are used for connectors or power sources. These are clearly distinguished from jumpers in the Motherboard Layout. Placing jumper caps over these connector pins will cause damage to your motherboard.

IMPORTANT: Ribbon cables should always be connected with the red stripe to Pin 1 on the connectors. Pin 1 is usually on the side closest to the power connector on hard drives and CD-ROM drives, but may be on the opposite side on floppy disk drives. Check the connectors before installation because there may be exceptions. IDE ribbon cable must be less than 46 cm (18 in.), with the second drive connector no more than 15 cm (6 in.) from the first connector.

1) PS/2 Mouse Port (Green 6-pin PS2KBMS)

The system automatically directs IRQ12 to the PS/2 mouse if one is detected. If no mouse is detected, IRQ12 become available to expansion cards. See **PS/2 Mouse Function Control** in *4.4 Advanced Menu*.

PS/2 Mouse (6-pin female)

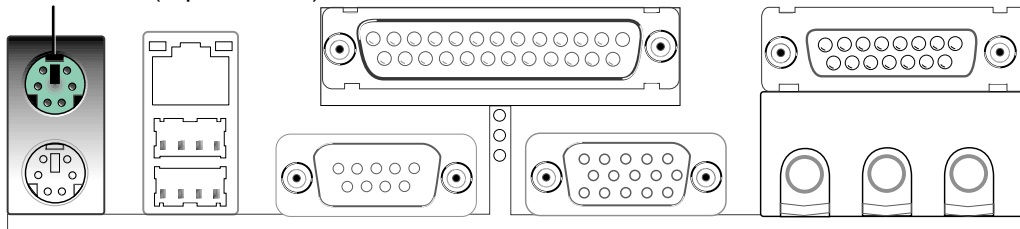

2) PS/2 Keyboard Port (Purple 6-pin PS2KBMS)

This connection is for a standard keyboard using an PS/2 plug (mini DIN). **This connector does not allow standard AT size (large DIN) keyboard plugs. You may use a DIN to mini DIN adapter on standard AT keyboards.**

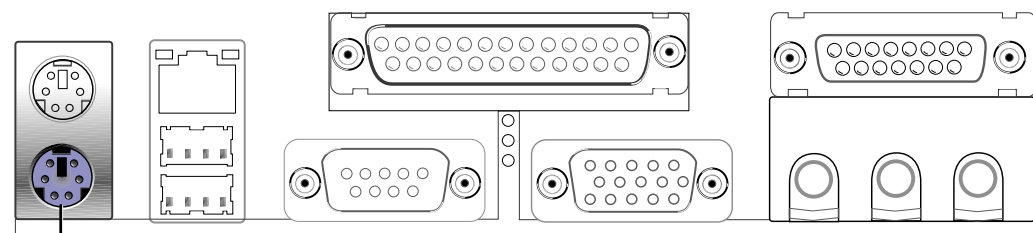

PS/2 Keyboard (6-pin female)

3. HARDWARE SETUP

3) Universal Serial Bus Ports 1 & 2 (Black two 4-pin USB)

Two USB ports are available for connecting USB devices.

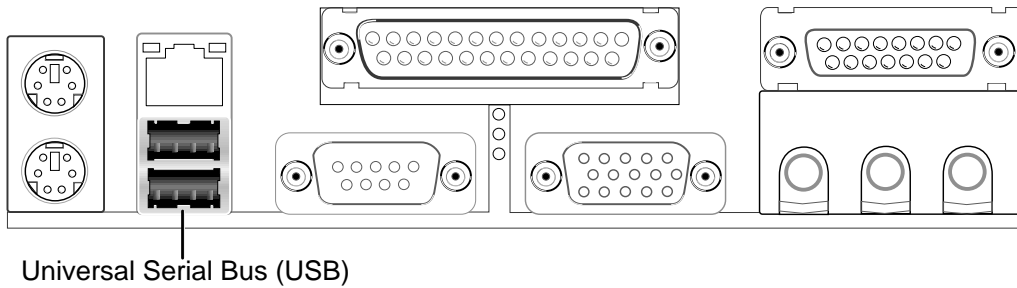

4) Parallel Port (Burgundy 25-pin PRINTER)

You can enable the parallel port and choose the IRQ through **Onboard Parallel Port** (see **4.4.2 I/O Device Configuration**).

NOTE: Serial printers must be connected to the serial port.

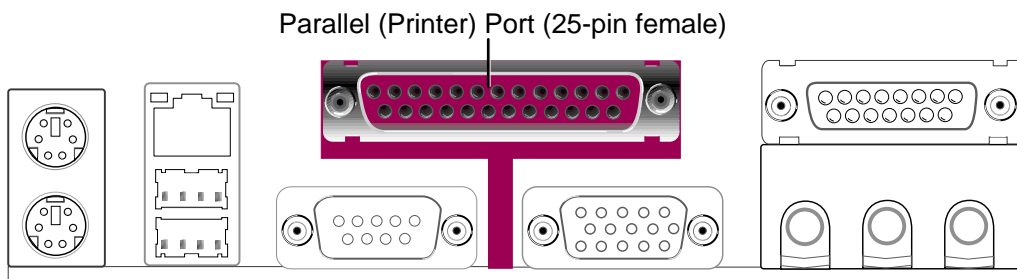

5) Fast Ethernet Port (RJ-45) (Optional)

The RJ-45 connector is located on top of the USB connectors. The USB connector supplies a direct connection to a local area network (LAN) and is supported by the onboard LAN controller chipset.

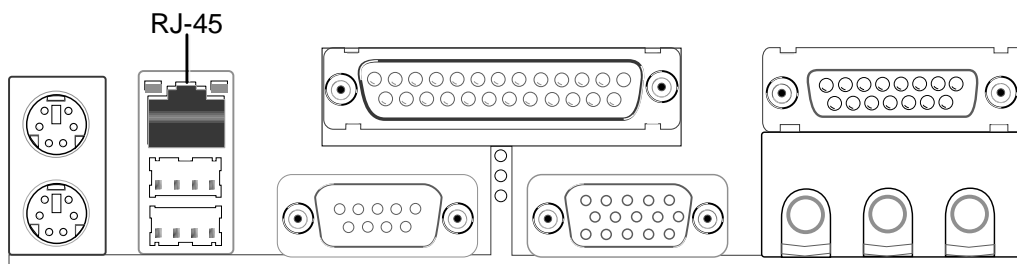

3. HARDWARE SETUP

6) Serial Port Connectors (Teal/Turquoise 9-pin COM1, 10-1 pin COM2)

One serial port is ready for a mouse or other serial devices. A second serial port is available using a serial port bracket connected from the motherboard to an expansion slot opening. See **Onboard Serial Port 1/2** in *4.4.2 I/O Device Configuration* for settings.

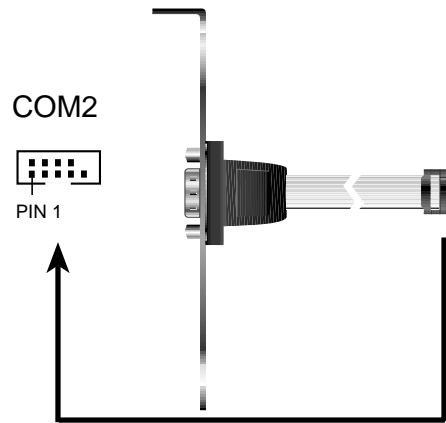
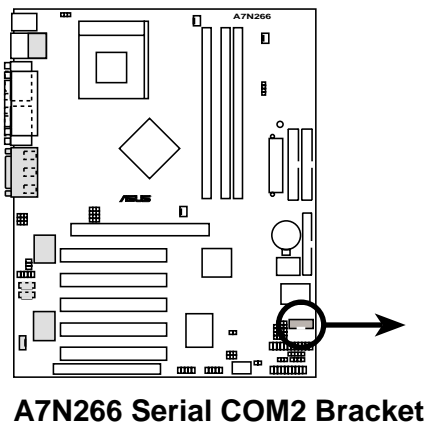
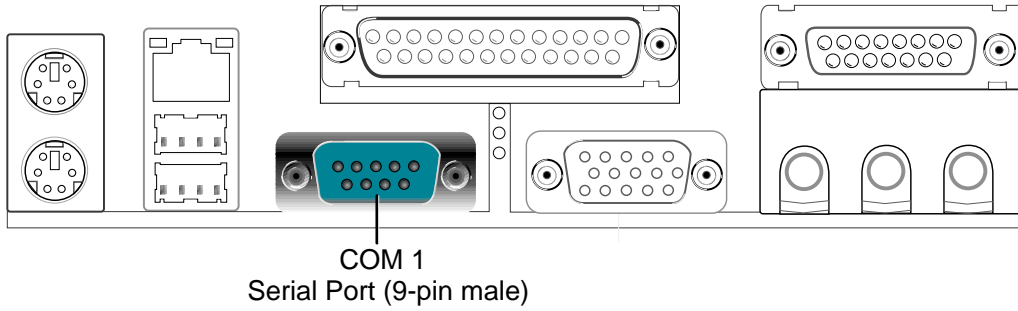

7) Monitor Output Connector (Blue 15-pin VGA)

This connector supports output to a VGA compatible screen device.

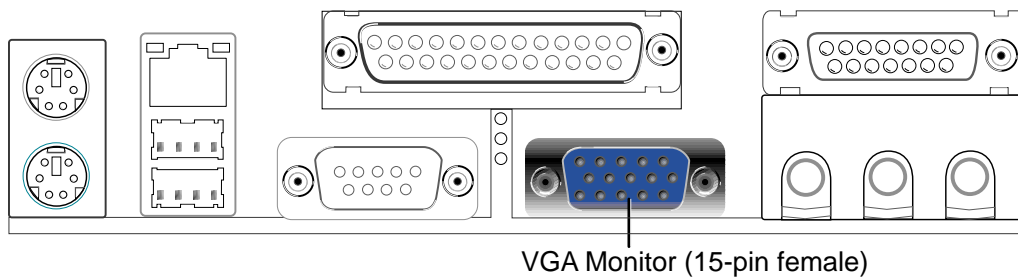

3. HARDWARE SETUP

8) Game/MIDI Ports (Gold 15-pin GAME_AUDIO) (optional)

This connector supports a joystick or a game pad for playing games, and MIDI devices for playing or editing audio files.

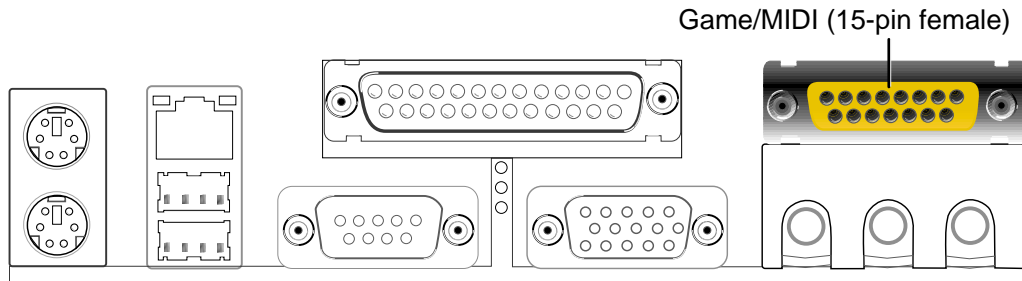

9) Audio Connectors (Three 1/8" AUDIO) (optional)

The **Line Out** (lime) connects headphone or speakers. **Line In** (light blue) connects a tape players or other input sources. The **Mic** (pink) connects microphones. **NOTE:** Refer to page 91 for more information about configuring these connectors to 6-channel mode.

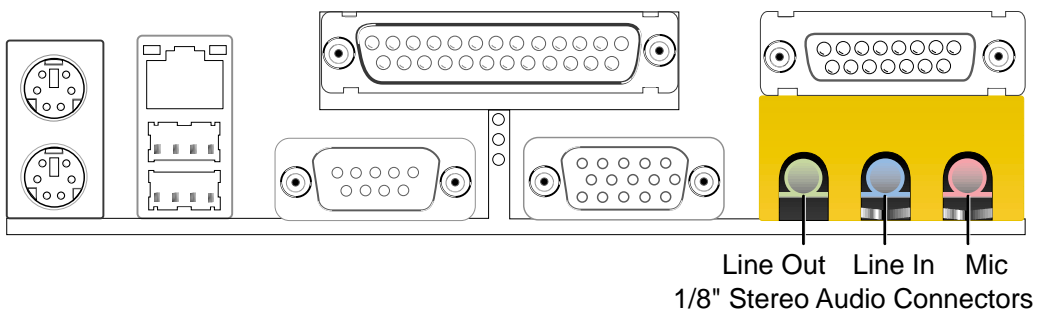

3. HARDWARE SETUP

10) IDE Activity LED (2-pin IDELED)

This connector supplies power to the cabinet's IDE activity LED. Read and write activity by devices connected to the Primary or Secondary IDE connectors cause the IDE LED to light up.

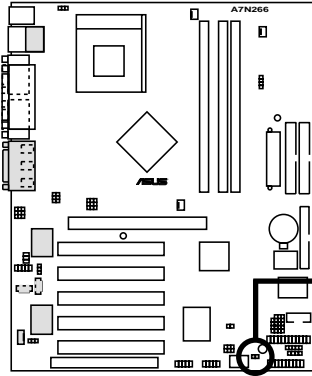

A7N266 IDE Activity LED

IDELED



TIP: If the case-mounted LED does not light, try reversing the 2-pin plug.

11) Floppy Disk Drive Connector (34-1 pin FLOPPY)

This connector supports the provided floppy drive ribbon cable. After connecting the single end to the board, connect the two plugs on the other end to the floppy drives. (**Pin 5 is removed to prevent inserting in the wrong orientation when using ribbon cables with pin 5 plugged**).

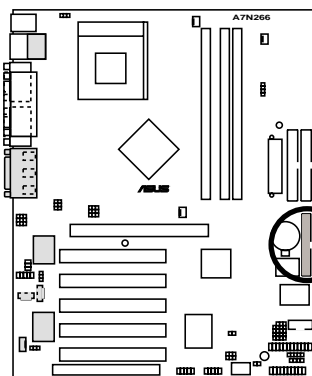

A7N266 Floppy Disk Drive Connector

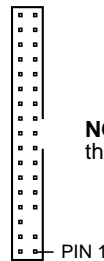

NOTE: Orient the red markings on the floppy ribbon cable to PIN 1

3. HARDWARE SETUP

12) Primary (Blue) / Secondary IDE Connectors (40-1 pin IDE1/IDE2)

These connectors support the UltraDMA/100/66 IDE hard disk ribbon cable supplied with the motherboard. Connect the cable's blue connector to the primary (recommended) or secondary IDE connector, then connect the gray connector to the UltraDMA/100/66 slave device (hard disk drive) and the black connector to the UltraDMA/100/66 master device. It is recommended that non-UltraDMA/100/66 devices be connected to the secondary IDE connector. If you install two hard disks, you must configure the second drive as a slave device by setting its jumper accordingly. Refer to the hard disk documentation for the jumper settings. BIOS supports specific device bootup (see **4.6 Boot Menu**). If you have more than two UltraDMA/100/66 devices, purchase another UltraDMA/100/66 cable.

NOTES:

1. Pin 20 on each IDE connector is removed to match the covered hole on the UltraDMA cable connector. This prevents incorrect orientation when you connect the cables.
2. The hole near the blue connector on the UltraDMA/100/66 cable is intentional.

TIP: You may configure two hard disks to be both Masters with two ribbon cables: one for the primary IDE connector and another for the secondary IDE connector.

IMPORTANT: For UltraDMA/100/66 IDE devices, use a 40-pin 80-conductor IDE cable. The UltraDMA/66 cable included in the motherboard package also supports UltraDMA/100.

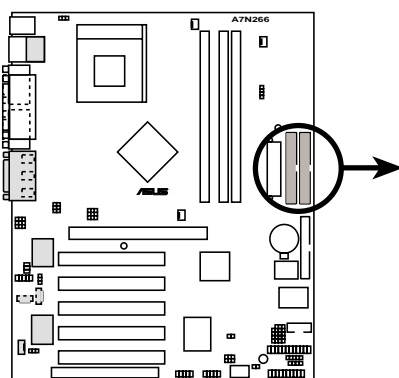

A7N266 IDE Connectors

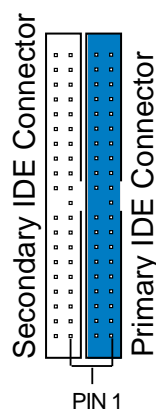

NOTE: Orient the red markings (usually zigzag) on the IDE ribbon cable to PIN 1.

3. HARDWARE SETUP

13) CPU Fan, North Bridge Fan, and Chassis Fan Connectors (CPU, NB, CHA_FAN)

The three fan connectors support cooling fans of 350mA (4.2 Watts) or less. Orient the fans so that the heat sink fins allow airflow to go across the onboard heat sinks instead of the expansion slots. The fan wiring and plug may vary. Connect the fan cable to the connector making sure that the black wire matches the ground pin. **NOTE:** Use the “Rotation” signal only with a specially designed fan with a rotation signal. Monitor *Rotations Per Minute* (RPM) using ASUS PC Probe (see 6. **SOFTWARE REFERENCE**).

WARNING! Make sure to connect the fan cables to the fan connectors. Lack of sufficient airflow within the system could cause damage to the motherboard. **These are not jumpers, do not place jumper caps over these connectors!**

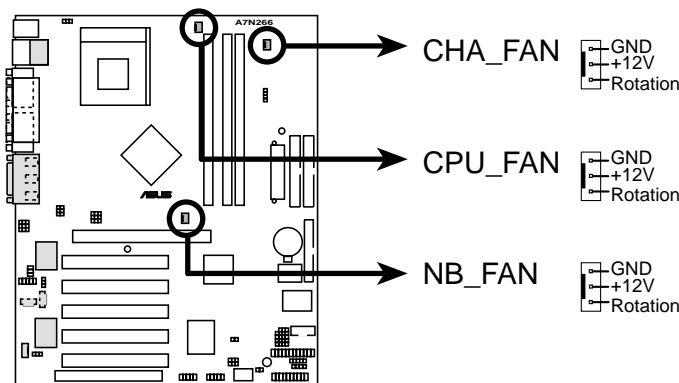

A7N266 12-Volt Cooling Fan Power

14) USB Headers (10-1 pin USB2_3, USB4_5)

If the USB port connectors on the back panel are inadequate, two USB headers are available for four additional USB port connectors. Connect a 2-port USB connector set to a USB header and mount the USB bracket to an open slot in the chassis. (The USB connector set is optional and does not come with the motherboard package.)

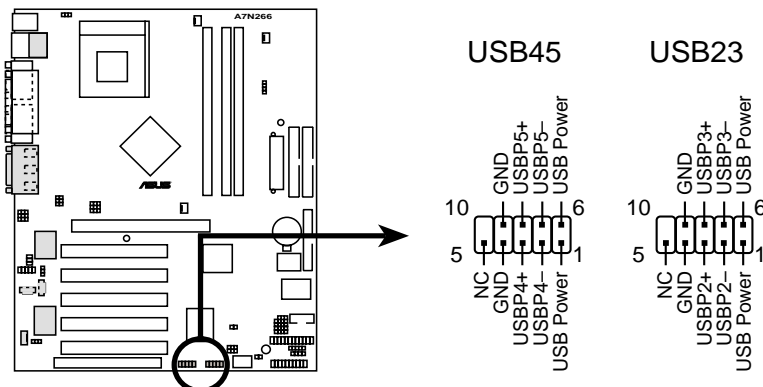

A7N266 Front Panel USB Headers



3. HARDWARE SETUP

15) Infrared Connector (10-1 pin IrDA)

This connector supports an optional wireless transmitting and receiving infrared module to the CIR and SIR connectors for both wireless transmitting and remote control functions through an external infrared module. This connector supports an optional wireless transmitting and receiving infrared module. This module mounts to a small opening on system cases that support this feature. You must also configure the setting through **UART2 Use Infrared** (see *4.4.2 I/O Device Configuration*) to select whether UART2 is directed for use with COM2 or IrDA. Use the five pins as shown in Back View and connect a ribbon cable from the module to the motherboard SIR connector according to the pin definitions. (NOTE: The SIR module does not come with the motherboard package.)

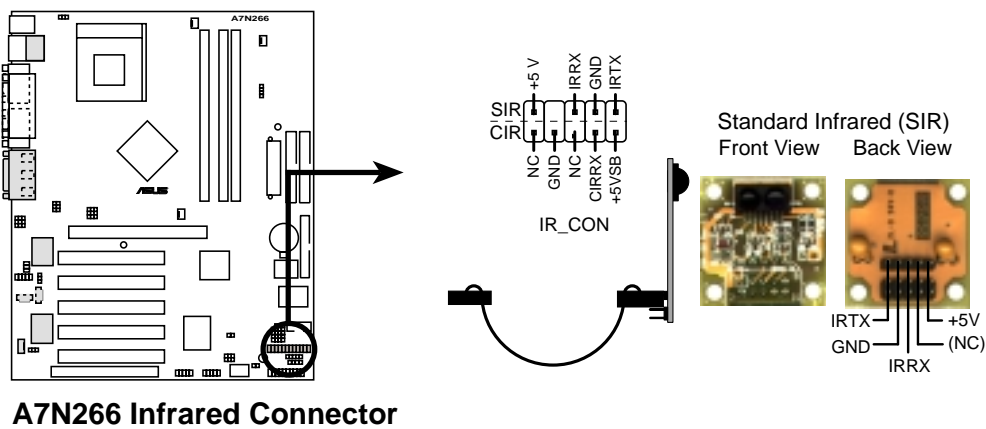

3. HARDWARE SETUP

16) Power Supply Connectors (20-pin block ATXPWR)

This connector supplies to an ATX power supply. The plug from the power supply fits in only one orientation because of the different hole sizes. Find the proper orientation and push down firmly making sure that the pins are aligned.

IMPORTANT: Make sure that the ATX power supply (minimum recommended wattage: 230W) can supply at least 10mA on the +5-volt standby lead (+5VSB). The system may become unstable and may experience difficulty powering up if the power supply is inadequate. For Wake-On-LAN support, the ATX power supply must supply at least 720mA +5VSB.

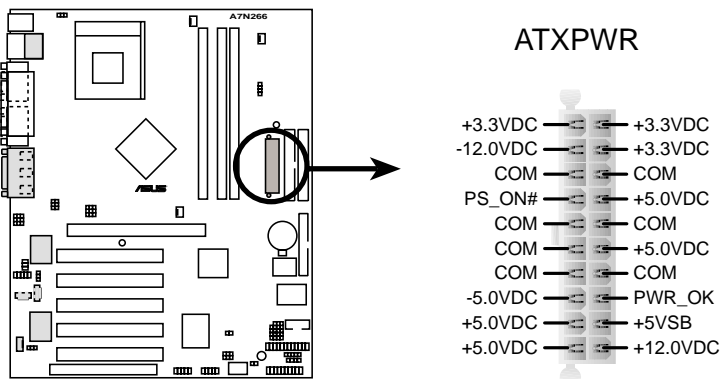

A7N266 ATX Power Connector

17) SMBus Connector (5-1 pin SMB)

This connector allows you to connect SMBus (System Management Bus) devices. SMBus devices communicate by means of the SMBus with an SMBus host and/or other SMBus devices. SMBus is a specific implementation of an I²C bus, a multi-device bus that allows multiple chips to connect to the same bus and enabling each one to act as a master by initiating data transfer.

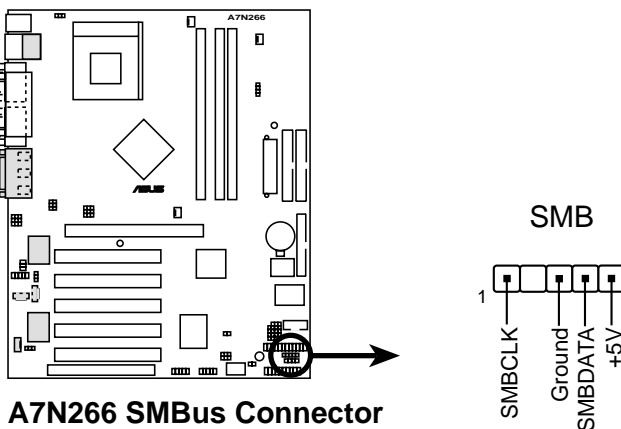

A7N266 SMBus Connector

3. HARDWARE SETUP

18) Internal Audio Connectors (4-1 pin CD, AUX, MODEM) (*optional*)

These connector receives stereo audio input from sound sources as a CD-ROM, TV tuner, or MPEG card. The MODEM connector allows the onboard audio to interface with a voice modem card with a similar connector. It also allows the sharing of mono_in (such as a phone) and a mono_out (such as a speaker) between the audio and a voice modem card.

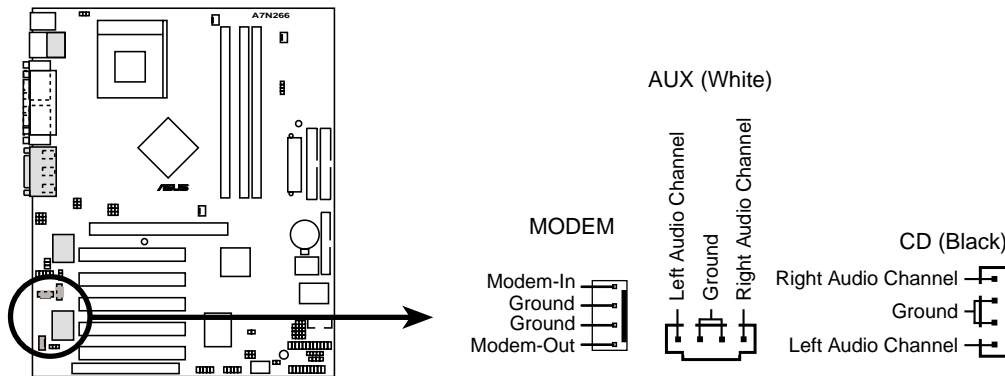

A7N266 Internal Audio Connectors

19) Internal Microphone Connector (3-pin INT_MIC) (*optional*)

This connector supports a chassis-mounted microphone instead of connecting an external microphone to the audio Line-in jack.

NOTE: The internal microphone does not work if there is an external microphone connected to the external Mic (pink) jack. You may only use one microphone at a time.

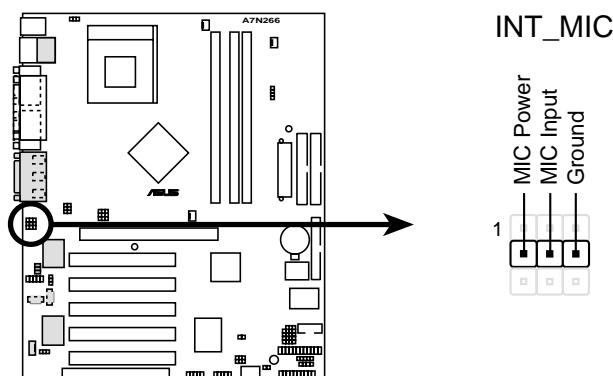

A7N266 Internal Microphone Connector

3. HARDWARE SETUP

20) Headphone True-level Line Out Header (3-pin HPHONE) *(optional)*

This connector supports a chassis-mounted headphone to the motherboard instead of connecting an external headphone to the audio Line-out jack.

NOTE: The internal microphone does not work if there is an external microphone connected to the external Mic (pink) jack. You may only use one microphone at a time.

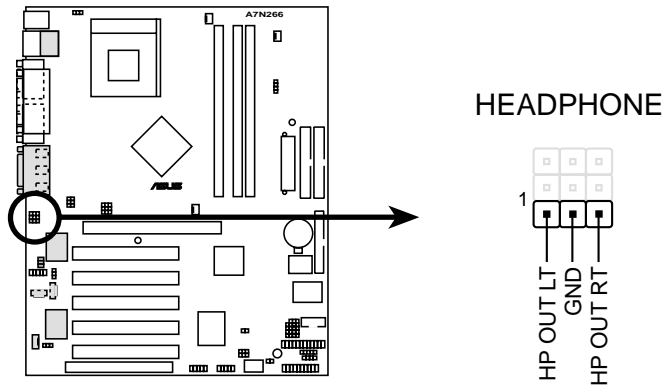

A7N266 True-Level Line Out Header

21) Line In Header (3-pin INT_LINEIN) *(optional)*

This connector supports an additional line in to the motherboard.

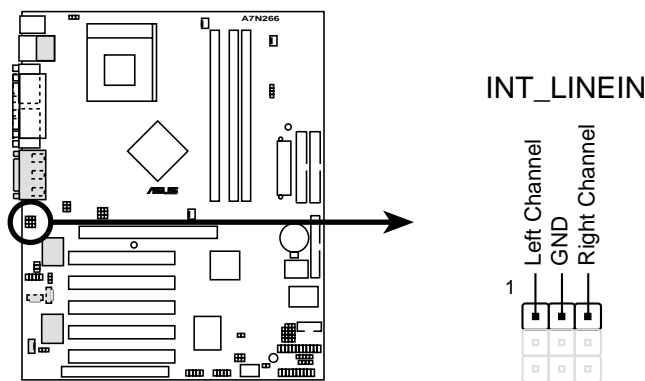

A7N266 Line In Connector

3. HARDWARE SETUP

22) Digital Audio Interfaces (2-pin S/PDIF) (optional)

These connectors support an S/PDIF audio bracket for digital audio input and output functions. The connector and bracket support a variety of digital resources: CD-ROM, DVD-ROM, CD-RW and advanced sound cards like SoundBlaster Live™.

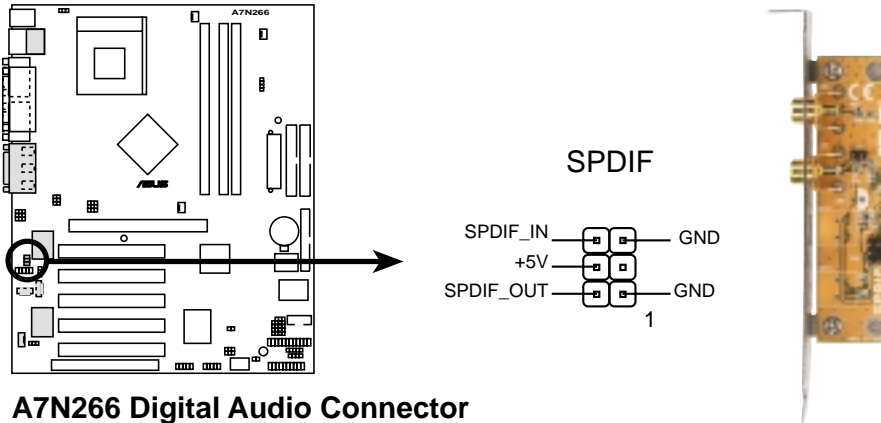

23) Chassis Open Alarm Lead (4-pin CHASSIS)

This lead is designed for chassis intrusion detection. It requires an external detection mechanism such as a chassis intrusion monitor/sensor or microswitch. When the chassis is opened, the sensor is triggered and a high-level signal is sent to this lead to record a chassis intrusion event. The event is then be processed by software such as LDCM. When not using the chassis intrusion lead, place a jumper cap over the pins to close the circuit.

NOTE: Removing the chassis intrusion jumper cap without attaching any detectors prevents boot-up of the PC.

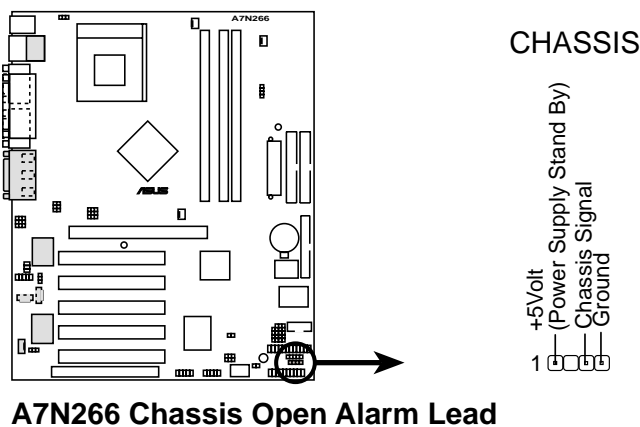

3. HARDWARE SETUP

24) Power Supply Thermal Sensor Connector (2-pin JTPWR)

Power supplies that offer thermal monitoring may connect the thermal sensor cable to this lead.

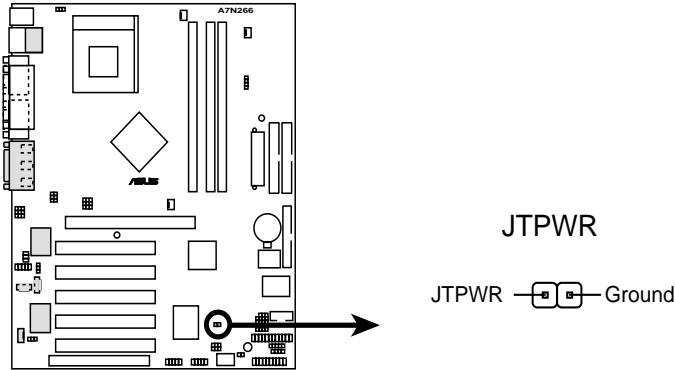

A7N266 Power Supply Thermal Connector

3. HARDWARE SETUP

The following 20-pin PANEL illustration is for items 25-31.

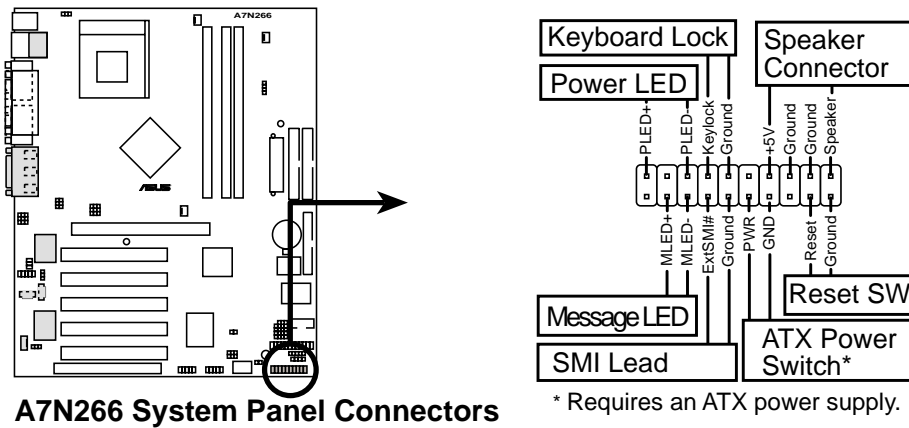

25) System Power LED Lead (3-1 pin PWR.LED)

This 3-1 pin connector connects to the system power LED. The LED lights up when you turn on the system power, and blinks when the system is in sleep or soft-off mode.

26) Keyboard Lock Switch Lead (2-pin KEYLOCK)

This 2-pin connector connects to the case-mounted key switch to allow keyboard locking.

27) System Warning Speaker Lead (4-pin SPEAKER)

This 4-pin connector connects to the case-mounted speaker and allows you to hear system beeps and warnings.

28) System Message LED Lead (2-pin MSG.LED)

This 2-pin connector is for the system message LED that indicates receipt of messages from a fax/modem. The normal status for this LED is ON, when there is no incoming data signal. The LED blinks when data is received. The system message LED feature requires an ACPI OS and driver support.

29) System Management Interrupt Lead (2-pin SMI)

This 2-pin connector allows you to manually place the system into a suspend mode, or “Green” mode, where system activity is instantly decreased to save power and to expand the life of certain system components. Attach the case-mounted suspend switch this 2-pin connector.

30) ATX Power Switch / Soft-Off Switch Lead (2-pin PWR.SW)

The system power is controlled by a momentary switch attached to this connector. Pressing the button switches the system between ON and SLEEP, or ON and SOFT OFF, depending on the BIOS or OS settings. Pressing the button while in the ON mode for more than 4 seconds turns the system off.

31) Reset Switch Lead (2-pin RESET)

This 2-pin connector connects to the case-mounted reset switch for rebooting the system without turning off the power switch. This is a preferred method.

3. HARDWARE SETUP

3.9 Starting Up the First Time

1. After all connections are made, close the system case cover.
2. Be sure that all switches are off (in some systems, marked with ○).
3. Connect the power supply cord into the power supply located on the back of your system case according to your system user's manual.
4. Connect the power cord into a power outlet that is equipped with a surge protector.
5. You may then turn on your devices in the following order:
 - a. Your monitor
 - b. External SCSI devices (starting with the last device on the chain)
 - c. Your system power. For ATX power supplies, you need to switch on the power supply as well as press the ATX power switch on the front of the case.
6. The power LED on the front panel of the system case will light. For ATX power supplies, the system LED will light when the ATX power switch is pressed. The LED on the monitor may light up or switch between orange and green after the system's if it complies with "green" standards or if it has a power standby feature. The system will then run power-on tests. While the tests are running, the BIOS will alarm beeps or additional messages will appear on the screen. If you do not see anything within 30 seconds from the time you turn on the power, the system may have failed a power-on test. Recheck your jumper settings and connections or call your retailer for assistance.

Award BIOS Beep Codes

Beep	Meaning
One short beep when displaying logo	No error during POST
Long beeps in an endless loop	No DRAM installed or detected
One long beep followed by three short beeps	Video card not found or video card memory bad
High frequency beeps when system is working	CPU overheated System running at a lower frequency

3. HARDWARE SETUP

7. During power-on, hold down <Delete> to enter BIOS setup. Follow the instructions in *4. BIOS SETUP*.

* **Powering Off your computer:** You must first exit or shut down your operating system before switching off the power switch. For ATX power supplies, you can press the ATX power switch after exiting or shutting down your operating system. If you use Windows 9X, click the **Start** button, click **Shut Down**, and then click **Shut down the computer?** The power supply should turn off after Windows shuts down.

NOTE: The message “You can now safely turn off your computer” will not appear when shutting down with ATX power supplies.

4. BIOS SETUP

4.1 Managing and Updating Your BIOS

4.1.1 Upon First Use of the Computer System

It is recommended that you save a copy of the original motherboard BIOS along with a Flash Memory Writer utility (AFLASH.EXE) to a bootable floppy disk in case you need to reinstall the BIOS later. **AFLASH.EXE** is a Flash Memory Writer utility that updates the BIOS by uploading a new BIOS file to the programmable flash ROM on the motherboard. This file works only in DOS mode. To determine the BIOS version of your motherboard, check the last four numbers of the code displayed on the upper left-hand corner of your screen during bootup. Larger numbers represent a newer BIOS file.

1. Type **FORMAT A:/S** at the DOS prompt to create a bootable system disk. **DO NOT** copy AUTOEXEC.BAT and CONFIG.SYS to the disk.
2. Type **COPY D:\AFLASH\AFLASH.EXE A:** (assuming D is your CD-ROM drive) to copy AFLASH.EXE to the boot disk you created.
NOTE: AFLASH works only in DOS mode. It does not work in the DOS prompt within Windows and does not work with certain memory drivers that may be loaded when you boot from the hard drive. It is recommended that you reboot using a floppy disk.
3. Reboot the computer from the floppy disk.

NOTE: BIOS setup must specify “Floppy” as the first item in the boot sequence.

4. In DOS mode, type **A:\AFLASH <Enter>** to run AFLASH.



```
ASUS ACPI BIOS
FLASH MEMORY WRITER V1.29
Copyright (C) 1994-99, ASUSTeK COMPUTER INC.

Flash Memory: Winbond W29C020 or SST 29EE020 or Intel B28H20E

Current BIOS Version: ASUS XXX-XX ACPI BIOS Revision 1BBX
BIOS Model      : XXX-XX
BIOS Built Date   : 00/25/98

Choose one of the followings:
1. Save Current BIOS To File
2. Update BIOS Including Boot Block and ESCD

Enter choice: [1]

Press ESC To Exit
```

IMPORTANT! If the word “unknown” appears after **Flash Memory:**, the memory chip is either not programmable or is not supported by the ACPI BIOS and therefore, cannot be programmed by the Flash Memory Writer utility.

4. BIOS SETUP

5. Select **1. Save Current BIOS to File** from the Main menu and press <Enter>. The **Save Current BIOS To File** screen appears.

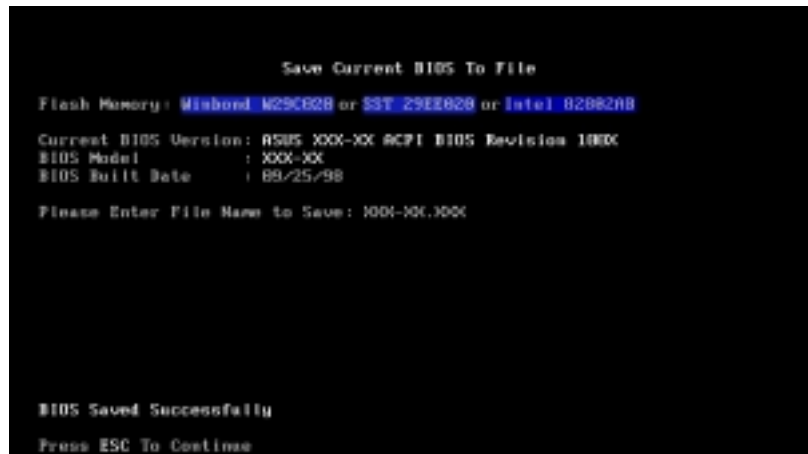

6. Type a filename and the path, for example, **A:\XXX-XX.XXX** and then press <Enter>.

4. BIOS SETUP

4.1.2 Updating BIOS Procedures

WARNING! Update the BIOS only if you have problems with the motherboard and you know that the new BIOS revision will solve your problems. Careless updating can result in your motherboard having more problems!

1. Download an updated ASUS BIOS file from the Internet (WWW or FTP) (see ASUS CONTACT INFORMATION on page 3 for details) and save to the boot floppy disk you created earlier.
2. Boot from the floppy disk.
3. At the “A:\” prompt, type **AFLASH** and then press <Enter>.
4. At the **Main Menu**, type **2** then press <Enter>. The **Update BIOS Including Boot Block and ESCD** screen appears.
5. Type the filename of your new BIOS and the path, for example, **A:\XXX-XX.XXX**, then press <Enter>.

NOTE: To cancel this operation, press <Enter>.

```
Update BIOS Including Boot Block and ESCD
Flash Memory: Winbond W29C020 or SST 29EE020 or Intel B28H20E
Current BIOS Version: ASUS XXX-XX ACPI BIOS Revision 100X
BIOS Model          : XXX-XX
BIOS Built Date     : 09/25/99
Please Enter File Name for NEW BIOS: A:\XXX-XX.XXX
```

6. When prompted to confirm the BIOS update, press **Y** to start the update.

```
Update BIOS Including Boot Block and ESCD
Flash Memory: Winbond W29C020 or SST 29EE020 or Intel B28H20E
BIOS Version
(CURRENT) ASUS XXX-XX ACPI BIOS Revision 100X
(test.ewd) ASUS XXX-XX ACPI BIOS Revision 100X
BIOS Model
(CURRENT) XXX-XX
(test.ewd) XXX-XX
Date of BIOS Built
(CURRENT) 09/25/99
(XXXX, XXXX) 05/29/99
Check sum of 1001,010 is F266.
Are you sure (Y/N) ? [Y]
Press ESC To Return to Main Menu
```

4. BIOS SETUP

- The utility starts to program the new BIOS information into the Flash ROM. The boot block is updated automatically only when necessary. This minimizes the possibilities of boot problems in case of update failures. When the programming is done, *Flashed Successfully* appears.

```
Update BIOS Including Boot Block and ESCD
Flash Memory: Winbond W29C020 or SST 29EE020 or Intel B28020B
BIOS Version
(CURRENT) ASUS XXX-XX ACPI BIOS Revision 100X
(Next.umd) ASUS XXX-XX ACPI BIOS Revision 100X
BIOS Model
(CURRENT) XXX-XX
(Next.umd) XXX-XX
Date of BIOS Built
(CURRENT) 05/25/99
(Next.umd) 05/25/99
Check sum of 1001,010 is F266.
Are you sure (Y/N) ? [Y]
Block Erasing -- Done
Programming -- 3FFFF
Flashed Successfully
Press ESC To Continue
```

- Follow the onscreen instructions to continue.

```
ASUS ACPI BIOS
FLASH MEMORY WRITER V1.29
Copyright (C) 1994-99, ASUSTek COMPUTER INC.
Flash Memory: Winbond W29C020 or SST 29EE020 or Intel B28020B
Current BIOS Version: ASUS XXX-XX ACPI BIOS Revision 100X
BIOS Model : XXX-XX
BIOS Built Date : 05/25/99
Choose one of the followings:
1. Save Current BIOS To File
2. Update BIOS Including Boot Block and ESCD
Enter choice: [1]
You have flashed the EPROM;it is recommended that you turn off
the power, enter SETUP and Load Setup Defaults to have CMOS
updated with new BIOS when exits.
Press ESC To Exit
```

WARNING! If you encounter problems while updating the new BIOS, DO NOT turn off the system because this may cause boot problems. Just repeat the process, and if the problem still persists, load the original BIOS file you saved to the boot disk. If the Flash Memory Writer utility is not able to successfully update a complete BIOS file, the system may not boot. If this happens, call the ASUS service center for support.

4. BIOS SETUP

4.2 BIOS Setup Program

This motherboard supports a programmable EEPROM that you can update using the provided utility described in *4.1 Managing and Updating Your BIOS*.

The utility is used if you are installing a motherboard, reconfiguring your system, or prompted to “**Run Setup**”. This section describes how to configure your system using this utility.

Even if you are not prompted to use the Setup program, at some time in the future you may want to change the configuration of your computer. For example, you may want to enable the Security Password Feature or make changes to the power management settings. It will then be necessary to reconfigure your system using the BIOS Setup program so that the computer can recognize these changes and record them in the CMOS RAM of the EEPROM.

The EEPROM on the motherboard stores the Setup utility. When you start up the computer, the system provides you with the opportunity to run this program. This appears during the Power-On Self Test (POST). Press <Delete> to call up the Setup utility. If you are a little bit late in pressing the mentioned key, POST will continue with its test routines, thus preventing you from calling up Setup. If you still need to call Setup, restart the system by pressing <Ctrl> + <Alt> + <Delete>, or by pressing the Reset button on the system chassis. You can also restart by turning the system off and then back on again. But do so only if the first two methods fail.

The Setup program has been designed to make it as easy to use as possible. It is a menu-driven program, which means you can scroll through the various sub-menus and make your selections among the predetermined choices.

To access the BIOS Setup program, press the <Delete> key after the computer has run through its POST.

NOTE: Because the BIOS software is constantly being updated, the following BIOS setup screens and descriptions are for reference purposes only, and may not exactly match what you see on your screen.

4. BIOS SETUP

4.2.1 BIOS Menu Bar

The top of the screen has a menu bar with the following selections:

- MAIN** Use this menu to make changes to the basic system configuration.
- ADVANCED** Use this menu to enable and make changes to the advanced features.
- POWER** Use this menu to configure and enable Power Management features.
- BOOT** Use this menu to configure the default system device used to locate and load the Operating System.
- EXIT** Use this menu to exit the current menu or specify how to exit the Setup program.

To access the menu bar items, press the right or left arrow key on the keyboard until the desired item is highlighted.

4.2.2 Legend Bar

At the bottom of the Setup screen is a legend bar. The keys in the legend bar allow you to navigate through the various setup menus. The following table lists the keys found in the legend bar with their corresponding functions.

Navigation Key(s)	Function Description
<F1> or <Alt + H>	Displays the General Help screen from anywhere in the BIOS Setup
<Esc>	Jumps to the Exit menu or returns to the main menu from a sub-menu
← or → (keypad arrow)	Selects the menu item to the left or right
↑ or ↓ (keypad arrow)	Moves the highlight up or down between fields
- (minus key)	Scrolls backward through the values for the highlighted field
+ (plus key) or spacebar	Scrolls forward through the values for the highlighted field
<Enter>	Brings up a selection menu for the highlighted field
<Home> or <PgUp>	Moves the cursor to the first field
<End> or <PgDn>	Moves the cursor to the last field
<F5>	Resets the current screen to its Setup Defaults
<F10>	Saves changes and exits Setup

4. BIOS SETUP

General Help

In addition to the Item Specific Help window, the BIOS setup program also provides a General Help screen. You may launch this screen from any menu by simply pressing <F1> or the <Alt> + <H> combination. The General Help screen lists the legend keys with their corresponding functions.

Saving Changes and Exiting the Setup Program

See *4.7 Exit Menu* for detailed information on saving changes and exiting the setup program.

Scroll Bar

When a scroll bar appears to the right of a help window, it indicates that there is more information to be displayed that will not fit in the window. Use <PgUp> and <PgDn> or the up and down arrow keys to scroll through the entire help document. Press <Home> to display the first page, press <End> to go to the last page. To exit the help window, press <Enter> or <Esc>.

Sub-Menu

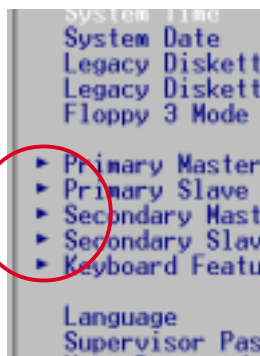

Note that a right pointer symbol (as shown in the left view) appears to the left of certain fields. This pointer indicates that you can display a sub-menu from this field. A sub-menu contains additional options for a field parameter. To display a sub-menu, move the highlight to the field and press <Enter>. The sub-menu appears. Use the legend keys to enter values and move from field to field within a sub-menu as you would within a menu. Use the <Esc> key to return to the main menu.

Take some time to familiarize yourself with the legend keys and their corresponding functions. Practice navigating through the various menus and sub-menus. If you accidentally make unwanted changes to any of the fields, use the set default hot key <F5> to load the Setup default values. While moving around through the Setup program, note that explanations appear in the Item Specific Help window located to the right of each menu. This window displays the help text for the currently highlighted field.

NOTE: The item heading in square brackets represents the default setting for that field.

4. BIOS SETUP

4.3 Main Menu

When you enter the Setup program, the following screen appears:

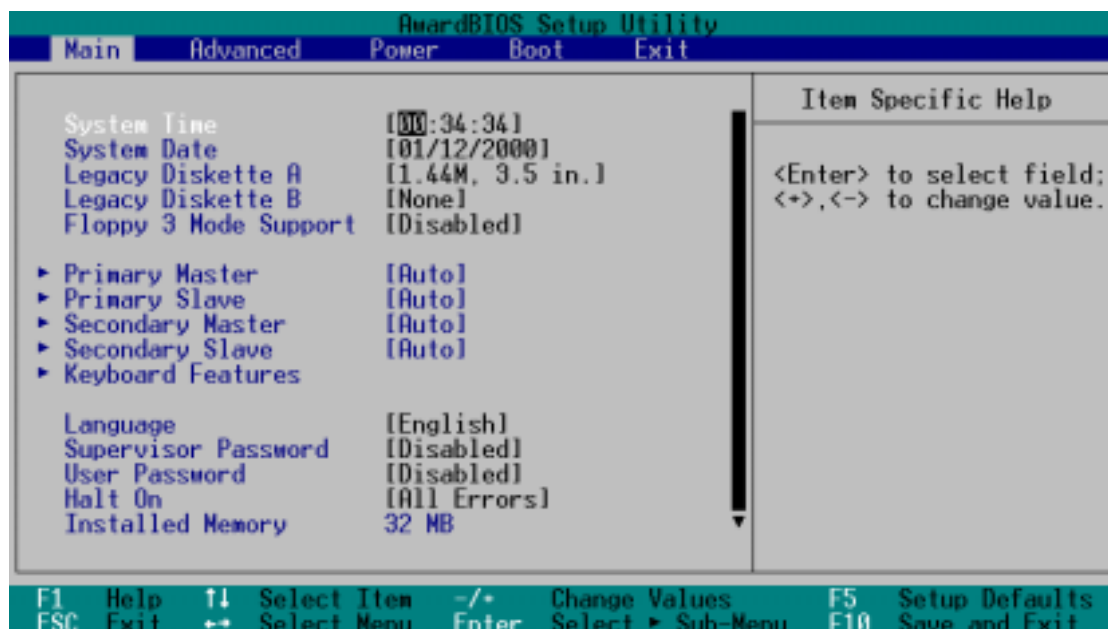

System Time [XX:XX:XX]

Sets the system to the time that you specify (usually the current time). The format is hour, minute, second. Valid values for hour, minute and second are **Hour: (00 to 23)**, **Minute: (00 to 59)**, **Second: (00 to 59)**. Use the <Tab> or <Shift> + <Tab> keys to move between the hour, minute, and second fields.

System Date [XX/XX/XXXX]

Sets the system to the date that you specify (usually the current date). The format is month, day, year. Valid values for month, day, and year are **Month: (1 to 12)**, **Day: (1 to 31)**, **Year: (100 year range)**. Use the <Tab> or <Shift> + <Tab> keys to move between the month, day, and year fields.

Legacy Diskette A [1.44M, 3.5 in.], Legacy Diskette B [None]

Sets the type of floppy drives installed. Configuration options: [None] [360K, 5.25 in.] [1.2M , 5.25 in.] [720K , 3.5 in.] [1.44M, 3.5 in.] [2.88M, 3.5 in.]

Floppy 3 Mode Support [Disabled]

This is required to support older Japanese floppy drives. The Floppy 3 Mode feature allows reading and writing of 1.2MB (as opposed to 1.44MB) on a 3.5-inch diskette. Configuration options: [Disabled] [Enabled]

4. BIOS SETUP

4.3.1 Primary & Secondary Master/Slave

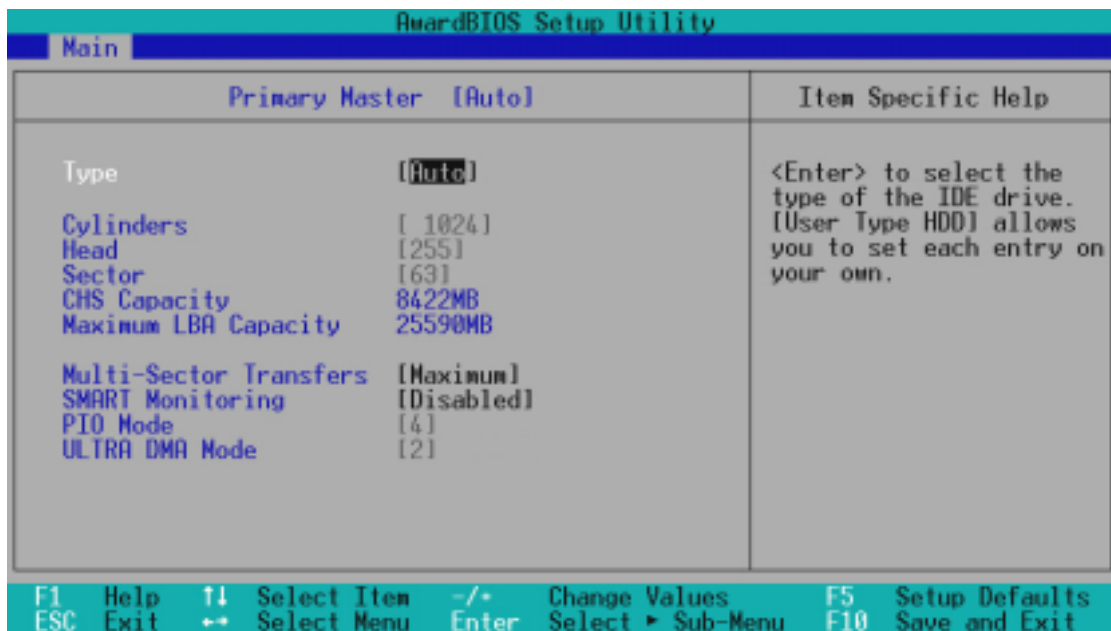

Type [Auto]

Select [Auto] to automatically detect an IDE hard disk drive. If automatic detection is successful, Setup automatically fills in the correct values for the remaining fields on this sub-menu. If automatic detection fails, this may be because the hard disk drive is too old or too new. If the hard disk was already formatted on an older system, Setup may detect incorrect parameters. In these cases, select [User Type HDD] to manually enter the IDE hard disk drive parameters. Refer to the next section for details.

NOTE: After entering the IDE hard disk drive information into BIOS, use a disk utility, such as FDISK, to partition and format new IDE hard disk drives. This is necessary so that you can write or read data from the hard disk. Make sure to set the partition of the Primary IDE hard disk drives to active.

CAUTION! Before attempting to configure a hard disk drive, make sure you have the configuration information supplied by the drive manufacturer. Incorrect settings may cause the system to fail to recognize the installed hard disk.

4. BIOS SETUP

[User Type HDD]

AwardBIOS Setup Utility		Item Specific Help
Main		
Primary Master [User Type HDD]		
Type	[User Type HDD]	<Enter> to select the type of the IDE drive. [User Type HDD] allows you to set each entry on your own. WARNING: Ultra DMA mode 3/4/5 can be enabled only when BIOS detects shielded 80-pin cable.
Translation Method	[LBA]	
Cylinders	[1024]	
Head	[255]	
Sector	[63]	
CHS Capacity	8422MB	
Maximum LBA Capacity	25590MB	
Multi-Sector Transfers	[Maximum]	
SMART Monitoring	[Disabled]	
PIO Mode	[4]	
ULTRA DMA Mode	[Disabled]	
F1 Help ↑↓ Select Item +/- Change Values F5 Setup Defaults		
ESC Exit ++ Select Menu Enter Select Sub-Menu F10 Save and Exit		

Manually enter the number of cylinders, heads and sectors per track for the drive. Refer to the drive documentation or on the drive label for this information. If no drive is installed or if you are removing a drive and not replacing it, select [None].

Translation Method [LBA]

Select the hard disk drive type in this field. When Logical Block Addressing (LBA) is enabled, 28-bit addressing of the hard drive disregarding cylinders, heads, or sectors. Note that LBA Mode is necessary for drives with more than 504MB storage capacity. Configuration options: [LBA] [LARGE] [Normal] [Match Partition Table] [Manual]

Cylinders

This field configures the number of cylinders. Refer to the drive documentation to determine the correct value to enter into this field. **NOTE:** To make changes to this field, set the **Type** field to [User Type HDD] and the **Translation Method** field to [Manual].

Head

This field configures the number of read/write heads. Refer to the drive documentation to determine the correct value to enter into this field. **NOTE:** To make changes to this field, set the **Type** field to [User Type HDD] and the **Translation Method** field to [Manual].

Sector

This field configures the number of sectors per track. Refer to the drive documentation to determine the correct value to enter into this field. **NOTE:** To make changes to this field, set the **Type** field to [User Type HDD] and the **Translation Method** field to [Manual].

4. BIOS SETUP

CHS Capacity

This field shows the drive's maximum CHS capacity as calculated by the BIOS based on the drive information you entered.

Maximum LBA Capacity

This field shows the drive's maximum LBA capacity as calculated by the BIOS based on the drive information you entered.

Multi-Sector Transfers [Maximum]

This option automatically sets the number of sectors per block to the highest number that the drive supports. Note that when this field is automatically configured, the set value may not always be the fastest value for the drive. You may also manually configure this field. Refer to the documentation that came with the hard drive to determine the optimum value and set it manually. **NOTE:** To make changes to this field, set the **Type** field to [User Type HDD]. Configuration options: [Disabled] [2 Sectors] [4 Sectors] [8 Sectors] [16 Sectors] [32 Sectors] [Maximum]

SMART Monitoring [Disabled]

This field allows you to enable or disable the S.M.A.R.T. (Self-Monitoring, Analysis and Reporting Technology) system that utilizes internal hard disk drive monitoring technology. This parameter is normally disabled because the resources used in the SMART monitoring feature may decrease system performance. Configuration options: [Disabled] [Enabled]

PIO Mode [4]

This option lets you set a PIO (Programmed Input/Output) mode for the IDE device. Modes 0 through 4 provide successively increased performance. Configuration options: [0] [1] [2] [3] [4]

Ultra DMA Mode [Disabled]

Ultra DMA capability allows improved transfer speeds and data integrity for compatible IDE devices. Set to [Disabled] to suppress Ultra DMA capability.

NOTE: To make changes to this field, set the **Type** field to [User Type HDD]. Configuration options: [0] [1] [2] [3] [4] [5] [Disabled]

Other options for the **Type** field are:

[CD-ROM] - for IDE CD-ROM drives

[LS-120] - for LS-120 compatible floppy disk drives

[ZIP] - for ZIP compatible disk drives

[MO] - for IDE magneto optical disk drives

[Other ATAPI Device] - for IDE devices not listed here

After making your selections on this sub-menu, press the <Esc> key to return to the Main menu. When the Main menu appears, the hard disk drive field displays the size for the hard disk drive that you configured.

4. BIOS SETUP

4.3.2 Keyboard Features

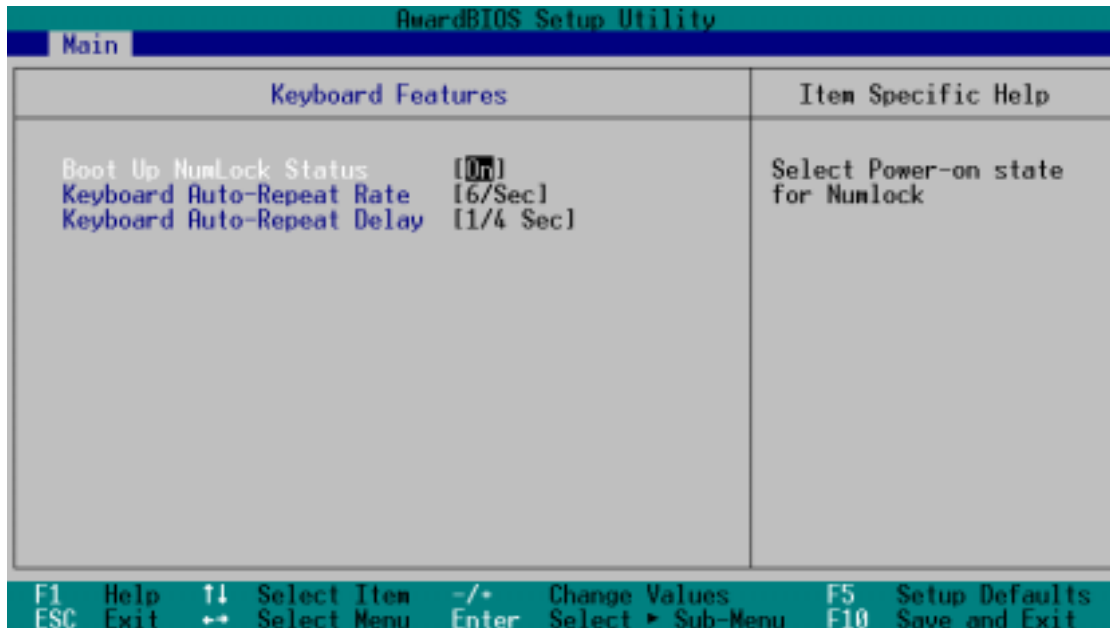

Boot Up NumLock Status [On]

This field enables users to activate the Number Lock function upon system boot. Configuration options: [Off] [On]

Keyboard Auto-Repeat Rate [6/Sec]

This controls the speed at which the system registers repeated keystrokes. Options range from 6 to 30 characters per second. Configuration options: [6/Sec] [8/Sec] [10/Sec] [12/Sec] [15/Sec] [20/Sec] [24/Sec] [30/Sec]

Keyboard Auto-Repeat Delay [1/4 Sec]

This field sets the time interval for displaying the first and second characters. Configuration options: [1/4 Sec] [1/2 Sec] [3/4 Sec] [1 Sec]

4. BIOS SETUP

Language [English]

This field displays the BIOS language version.

Supervisor Password [Disabled] / User Password [Disabled]

These fields allow you to set passwords. To set a password, highlight the appropriate field and press <Enter>. Type in a password then press <Enter>. You can type up to eight alphanumeric characters. Symbols and other characters are ignored. To confirm the password, type the password again and press <Enter>. The password is now set to [Enabled]. This password allows full access to the BIOS Setup menus. To clear the password, highlight this field and press <Enter>. The same dialog box as above appears. Press <Enter>. The password is set to [Disabled].

A Note about Passwords

The BIOS Setup program allows you to specify passwords in the Main menu. The passwords control access to the BIOS during system startup. Passwords are not case sensitive, meaning, it makes no difference whether you the password using uppercase or lowercase letters. The BIOS Setup program allows you to specify two different passwords: a Supervisor password and a User password. If you did not set a Supervisor password, anyone can access the BIOS Setup program. If you did, the Supervisor password is required to enter the BIOS Setup program and to gain full access to the configuration fields.

Forgot the Password?

If you forget your password, you can clear it by erasing the CMOS Real Time Clock (RTC) RAM. The RAM data containing the password information is powered by the onboard button cell battery. (See *Motherboard Settings* for a diagram of the *jumper location*.)

To erase the RTC RAM:

1. Turn OFF the computer and unplug the power cord.
2. Remove the battery.
3. Short the jumper.
4. Re-install the battery.
5. Plug the power cord and turn ON the computer.
6. Hold down the key during the boot process and enter BIOS setup to re-enter data.

Halt On [All Errors]

This field specifies the types of errors that will cause the system to halt. Configuration options: [All Errors] [No Error] [All but Keyboard] [All but Disk] [All but Disk/Keyboard]

Installed Memory [XXX MB]

This field automatically displays the amount of conventional memory detected by the system during the boot process.

4. BIOS SETUP

4.4 Advanced Menu

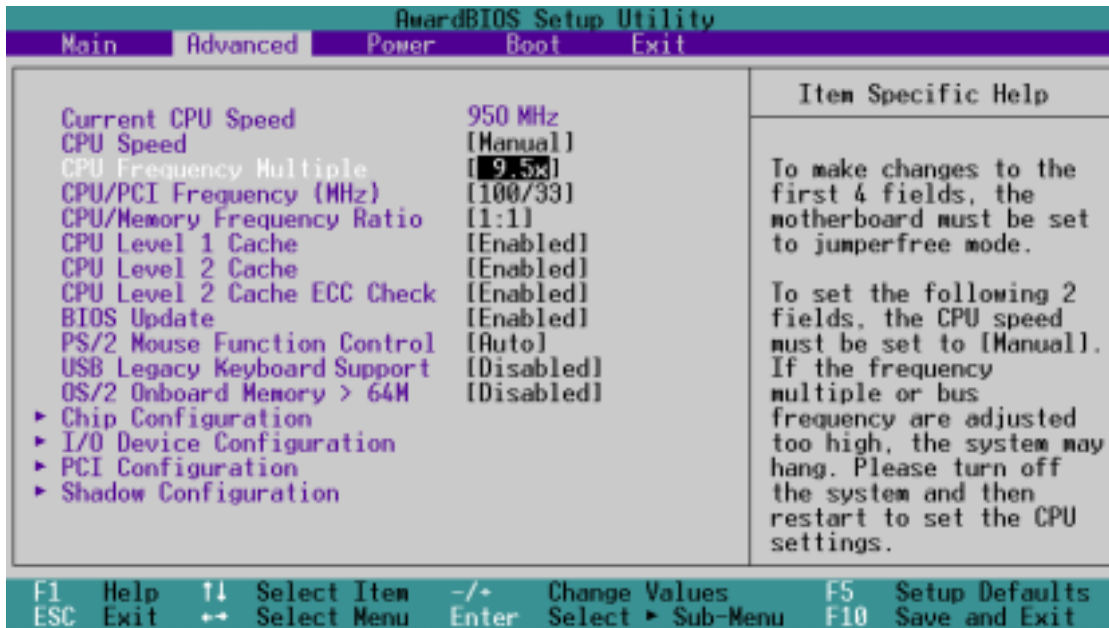

Current CPU Speed

This field displays the internal frequency of your CPU. In JumperFree mode, it is possible to change the speed of processors by adjusting the CPU/PCI multiple.

CPU Speed [Manual]

When the motherboard is set to JumperFree™ mode, this field sets the internal frequency of your CPU. Select [Manual] if you want to make changes to the next two fields. Note that selecting a frequency higher than the CPU manufacturer recommends may cause the system to hang or crash. Configuration options: [Manual] [Various frequencies]

CPU Frequency Multiple [9.5x]

This field is for unlocked processors only and will not be available to standard AMD processors. For unlocked processors, this field sets the frequency multiple between the CPU's *internal* frequency (CPU speed) and the *external* frequency. (Set this field in conjunction with the **CPU/PCI Frequency (MHz)** to match the speed of the CPU.) Configuration options: [5x] [5.5x] [6.0x]...[12.0x] [12.5x]

CPU/PCI Frequency (MHz) [100/33]

This feature tells the clock generator which frequency to send to the system bus and PCI bus. The bus frequency (external frequency) multiplied by the bus multiple equals the **CPU speed**. Increasing the ratio will increase the CPU Speed; the user must reboot the computer after making adjustments to this field. Configuration options: [103/33] ... [158/33].

4. BIOS SETUP

CPU/Memory Frequency Ratio [Auto]

This field determines whether the memory clock frequency is set to be in synchronous or asynchronous mode with respect to the memory frequency. The options that appear in the popup menu vary according to the status of the **CPU/PCI Frequency (MHz)** field. Configuration options: [1:1] [3:4]

CPU Level 1 Cache, CPU Level 2 Cache [Enabled]

These fields allow you to choose from the default of [Enabled] or choose [Disabled] to turn on or off the CPU Level 1 and Level 2 built-in cache. Configuration options: [Disabled] [Enabled]

CPU Level 2 Cache ECC Check [Enabled]

This function controls the ECC capability in the CPU level 2 cache. Configuration options: [Disabled] [Enabled]

BIOS Update [Enabled]

This field functions as an update loader integrated into the BIOS to supply the processor with the required data. When set to [Enabled], the BIOS loads the update on all processors during system bootup. Configuration options: [Disabled] [Enabled]

PS/2 Mouse Function Control [Auto]

The default setting [Auto] allows the system to detect a PS/2 mouse at startup. If a mouse is detected, the BIOS assigns IRQ12 to the PS/2 mouse. Otherwise, IRQ12 can be used for expansion cards. When you set this field to [Enabled], BIOS always reserves IRQ12, whether or not a PS/2 mouse is detected at startup. Configuration options: [Enabled] [Auto]

USB Legacy Keyboard Support [Disabled]

This motherboard supports Universal Serial Bus (USB) devices. The default of [Disabled] allows the system to detect a USB device at startup. The other two fields [Primary] and [Secondary] are used for selecting which of two sets of ports: USB01 and USB23 or USB45. Users should select [Disabled] or [Primary] to activate a USB-type keyboard connection to a new system. Configuration options: [Disabled] [Primary] [Secondary]

OS/2 Onboard Memory > 64M [Disabled]

When using OS/2 operating systems with installed DRAM of greater than 64MB, you need to set this option to [Enabled]. Otherwise, leave to the default setting [Disabled]. Configuration options: [Disabled] [Enabled]

4. BIOS SETUP

Summary of Warning Messages

The system may crash or hang up due to conflicts between settings and CPU compatibility: checksum errors, improper frequency settings, change of CPU and improper CPU speed settings. The system starts up in safe mode running at a bus speed of 100MHz and enters the BIOS Setup. Each time a system hangup occurs, BIOS interrupts the bootup process with a specific warning message. These messages always appear on the right side of the BIOS screen in *red print*:

1. Cause for Hangup: *Checksum Error Warning*

“The CMOS checksum is incorrect. Please reload the cmos default value.” *To solve this problem, clear the CMOS RTC memory (see pages 22 and 59) and then reenter the default values in the Exit menu and restart the system.*

2. Cause for Hangup: *Improper System Frequency*

“Last time you failed to change the frequency of the system. It may place the system into an unstable state. Now the system is in safe mode at the slowest CPU speed. Please set the system frequency again.” *To solve this problem, a slower frequency is more likely to obtain stable start-ups.*

CPU Upgrade/Reinstallation

To ensure that the system can enter BIOS Setup after replacing the processor, the system starts up running at a bus speed of 100MHz and a fail-safe CPU internal frequency. Then it automatically enters the Advanced menu with a popup display of all the possible CPU internal frequencies for the particular CPU presently installed:

3. Cause for Hangup: *Improper CPU Speed 1*

“During the last bootup, your system hung for an improper CPU Speed setting. Your system is now working in safe mode. To optimize the system performance and stability, make sure the CPU speed conforms to the specifications of your CPU.”

4. Cause for Hangup: *Improper CPU Speed 2*

“Since you are using a new CPU or have reinstalled your CPU, the system boots up at the slowest CPU bus frequency to make sure the system can enter setup menu. Now, you can adjust the CPU speed as you wish. If the speed is adjusted too high, the system may hang. Please turn off the system and then restart to set the CPU speed.”

4. BIOS SETUP

4.4.1 Chip Configuration

AwardBIOS Setup Utility		
Advanced		
Chip Configuration	Item Specific Help	
SDRAM Configuration	[By SPD]	<Enter> to choose Spread Spectrum Mode
SDRAM CAS Latency	[Auto (Normal)]	
Clock Spread Spectrum Mode	[Center Spread]	
VGA Shared Memory Size	[32MB]	
Graphics Aperture Size	[64MB]	
Internal Graphic Over-clocking	[Disabled]	
VGA LCD TV Display Type	[Auto]	
Video Memory Cache Mode	[UC]	
Onboard VGA BIOS Update	[Enabled]	
MCP IDE Controller	[Both]	
MCP USB Controller	[Enabled]	
MCP Audio Controller	[Auto]	
MCP DOLBY DIGITAL Controller	[Auto]	
PCI 2.1 Support	[Enabled]	

F1 Help ↑↓ Select Item -/+ Change Values F5 Setup Defaults
ESC Exit ↔ Select Menu Enter Select ► Sub-Menu F10 Save and Exit

SDRAM Configuration [By SPD]

This sets the optimal timing. The default setting is [By SPD], which automatically configures the timing by reading the contents in the SPD (Serial Presence Detect) device. The EEPROM on the memory module stores critical parameter information about the module, such as memory type, size, speed, voltage interface, and module banks. Configuration options: [User Defined] [By SPD]

NOTE: The subfield below only be used if the **SDRAM Configuration** can be changed to [User Defined].

SDRAM CAS Delay [Auto (Normal)]

Sets the latency between the SDRAM active command and the read/write command. Configuration options: [Auto (Normal)] [2.0T (Normal)] [2.5T (Normal)] [Auto (TURBO)] [2.0T (TURBO)] [2.5T (TURBO)]

Clock Spread Spectrum Mode [Center Spread]

Not available in this model. Configuration options: [Center Spread] [Spread Down] [Disabled]

VGA Shared Memory Size [32MB]

This feature sets the size of mapped memory for VGA monitor data. Configuration options: [8MB] [16MB] [32MB]

Graphics Aperture Size [64MB]

This feature sets the size of mapped memory for AGP graphic data. Configuration options: [32MB] [64MB] [128MB] [256MB] [512MB]

4. BIOS SETUP

Internal Graphic Over-clocking [Disable]

This feature permits the graphical processor to participate in over-clocking.
Configuration options: [Disable] [Enable]

VGA LCD TV Display Type [Auto]

The system automatically detects and sets up screen-type compatibility.
Configuration options: [Auto]

Video Memory Cache Mode [UC]

USWC (uncacheable, speculative write combining) is a new cache technology for the processor's video memory. It can greatly improve the display speed by caching the display data. Set this to UC (uncacheable) if the display card cannot support this feature; otherwise, the system may not boot up.
Configuration options: [UC] [USWC]

Onboard VGA BIOS Update [Enabled]

Configuration options: [Enabled] [Disabled]

MCP IDE Controller [Both]

Configuration options: [Both] [Primary] [Secondary] [Disabled]

MCP USB Controller [Enabled]

Both USB controllers are enabled by default. Refer to USB Legacy Keyboard support for specifying which ports are used to enable USB keyboard support. Configuration options: [Enabled] [Disabled]

MCP Audio Controller [Auto]

Configuration options: [Disabled] [Auto]

MCP DOLBY DIGITAL Controller [Auto]

Only available on the A7N266-E. Configuration options: [Disabled] [Auto]

PCI 2.1 Support [Enabled]

Configuration options: [Disabled] [Enabled]

4. BIOS SETUP

4.4.2 I/O Device Configuration

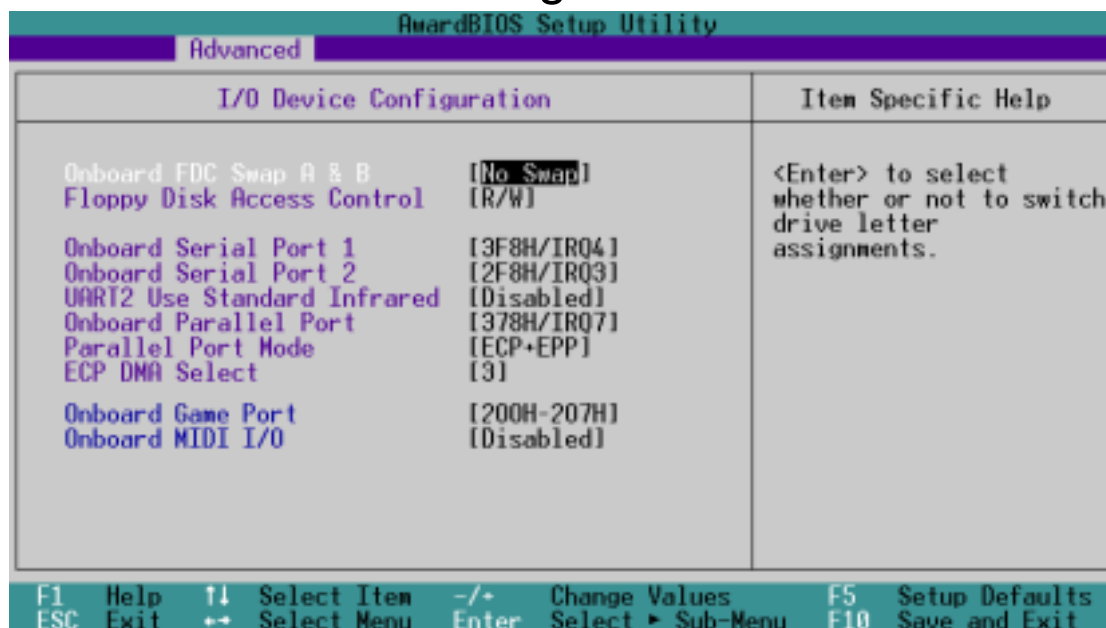

Onboard FDC Swap A & B [No Swap]

This field allows you to reverse the hardware drive letter assignments of your floppy disk drives. Configuration options: [No Swap] [Swap AB]

Floppy Disk Access Control [R/W]

Set this field to read and write the floppy disk (R/W). Change to [Read Only] for reading disks.

Onboard Serial Port 1 [3F8H/IRQ4]

Onboard Serial Port 2 [2F8H/IRQ3]

These fields allow you to set the addresses for the onboard serial connectors. Serial Port 1 and Serial Port 2 must have different addresses. Configuration options: [3F8H/IRQ4] [2F8H/IRQ3] [3E8H/IRQ4] [2E8H/IRQ10] [Disabled]

UART2 Use Standard Infrared [Disabled]

This field can activate the onboard standard infrared feature and sets the second serial UART to support the infrared module connector on the motherboard. See **IrDA-Compliant Infrared Module Connector** in *3.8 Connectors*. Configuration options: [Disabled] [Enabled]

Onboard Parallel Port [378H/IRQ7]

This field sets the address of the onboard parallel port connector. If you disable this field, the **Parallel Port Mode** and **ECP DMA Select** configurations are not available. Configuration options: [Disabled] [378H/IRQ7] [278H/IRQ5]

4. BIOS SETUP

Parallel Port Mode [ECP+EPP]

This field allows you to set the operation mode of the parallel port. [Normal] allows normal-speed operation but in one direction only; [EPP] allows bidirectional parallel port operation; [ECP] allows the parallel port to operate in bidirectional DMA mode; [ECP+EPP] allows normal speed operation in a two-way mode. Configuration options: [Normal] [EPP] [ECP] [ECP+EPP]

ECP DMA Select [3]

This field allows you to configure the parallel port DMA channel for the selected **ECP** mode. This selection is available only if you select [ECP] or [ECP+EPP] in **Parallel Port Mode** above. Configuration options: [1] [3] [Disabled]

Onboard Game Port [200H-207H]

This field sets the I/O address to the game port. Configuration options: [200H-207H] [208H-20FH] [Disabled]

Onboard MIDI [Disabled]

This field sets the I/O address for MIDI. Configuration options: [330H-331H] [300H-301H] [Disabled]

4. BIOS SETUP

4.4.3 PCI Configuration

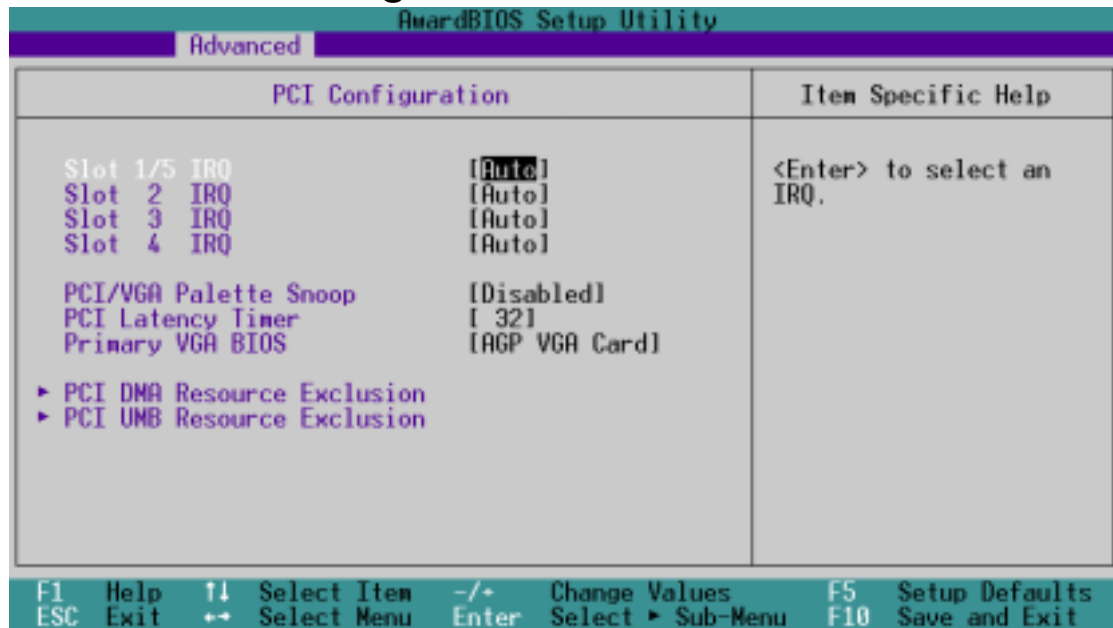

Slot 1/5, Slot 2, Slot 3, Slot 4 IRQ [Auto]

These fields automatically assign the IRQ for each PCI slot. The default setting for each field is [Auto], which utilizes auto-routing to determine IRQ assignments. Configuration options: [Auto] [NA] [3] [4] [5] [7] [9] [10] [11] [12] [14] [15]

PCI/VGA Palette Snoop [Disabled]

Some non-standard VGA cards, such as graphics accelerators or MPEG video cards, may not show colors properly. Setting this field to [Enabled] corrects this problem. If you are using standard VGA cards, leave this field to the default setting [Disabled]. Configuration options: [Disabled] [Enabled]

PCI Latency Timer [32]

Leave this field to the default setting [32] for best performance and stability.

Primary VGA BIOS [AGP VGA Card]

This field allows you to select the primary graphics card. Select the [Onboard VGA Card] option for optimal graphical support. Configuration options: [AGP VGA Card] [Onboard VGA]

4. BIOS SETUP

PCI DMA Resource Exclusion

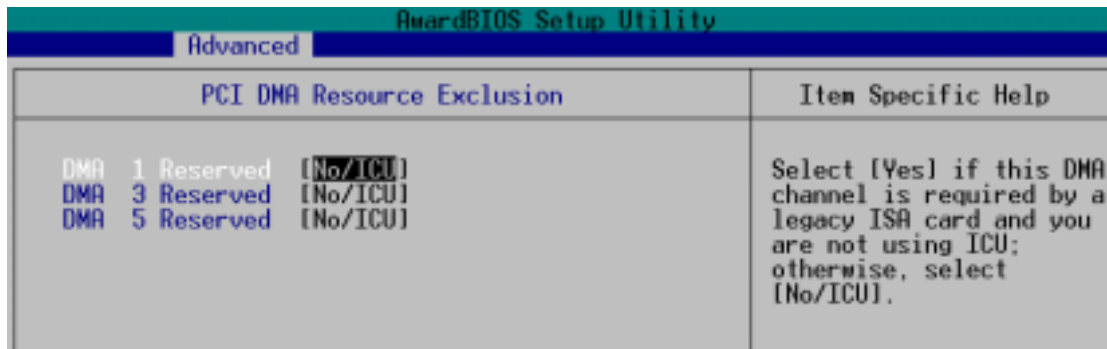

DMA x Reserved for Legacy Drive [No/ICU]

These fields indicate whether or not the DMA channel displayed for each field is being used by a legacy (non-PnP) ISA card. The default setting indicates either that the DMA channel displayed is not used or an ICU is being used to determine if an ISA device is using the channel instead. Configuration options: [No/ICU] [Yes]

PCI UMB Resource Exclusion

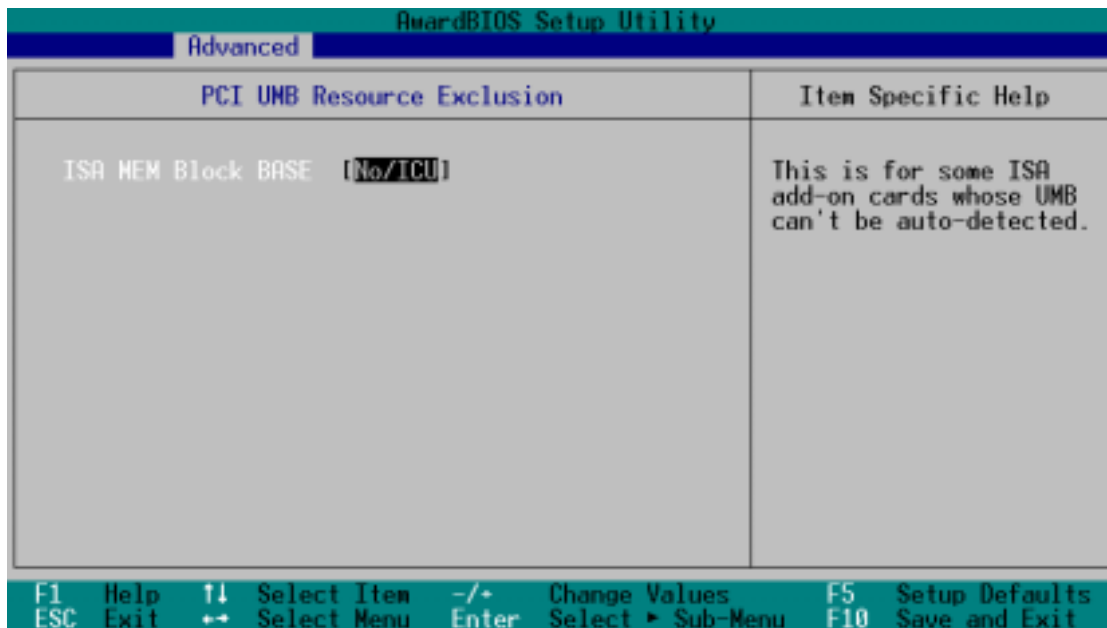

TSM MEM Block BASE [No/ICU]

This field allows you to set the base address and block size of an onboard legacy ISA device that uses any memory segment within the C800 and DFFF address range. With such a device, select a base address from the options. If an ICU is already in use, then leave the TSM MEM Block BASE to its default setting of [No/ICU]. Configuration options: [No/ICU] [C800] [CC00] [D000] [D400] [D800] [DC00]

4. BIOS SETUP

4.4.4 Shadow Configuration

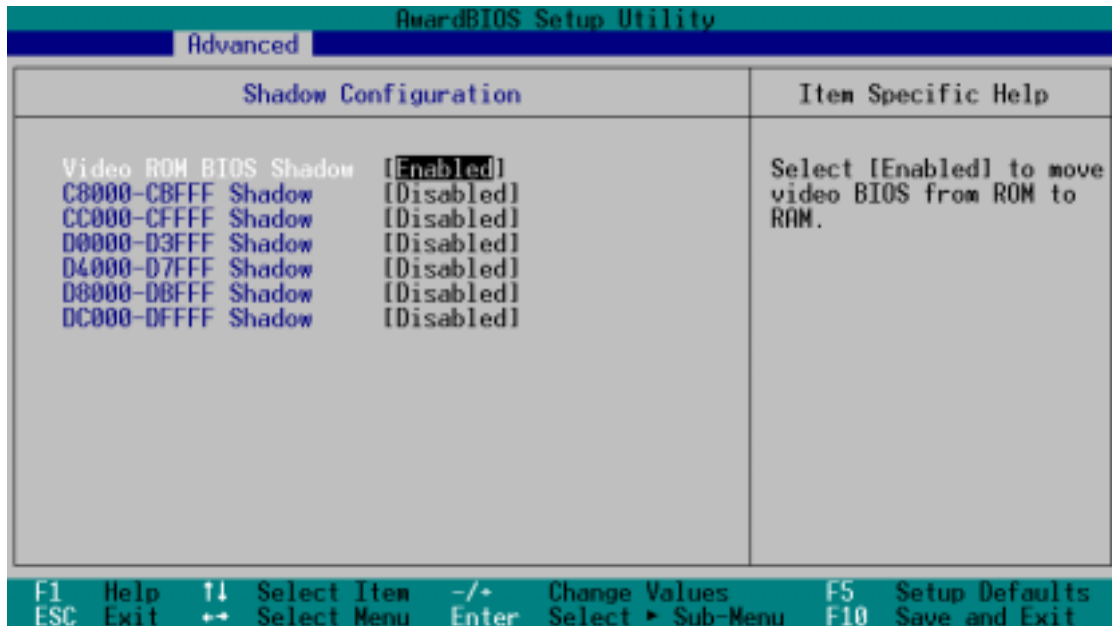

Video ROM BIOS Shadow [Enabled]

This field allows you to change the video BIOS location from ROM to RAM. Relocating to RAM enhances system performance, as information access is faster than the ROM. Configuration options: [Disabled] [Enabled]

C8000-DFFFF Shadow [Disabled]

These fields are used for shadowing other expansion card ROMs. If you install other expansion cards with ROMs on them, you will need to know which addresses the ROMs use to shadow them specifically. Shadowing a ROM reduces the memory available between 640K and 1024K by the amount used for this purpose. Configuration options: [Disabled] [Enabled]

4. BIOS SETUP

4.5 Power Menu

The Power menu allows you to reduce power consumption. This feature turns off the video display and shuts down the hard disk after a period of inactivity.

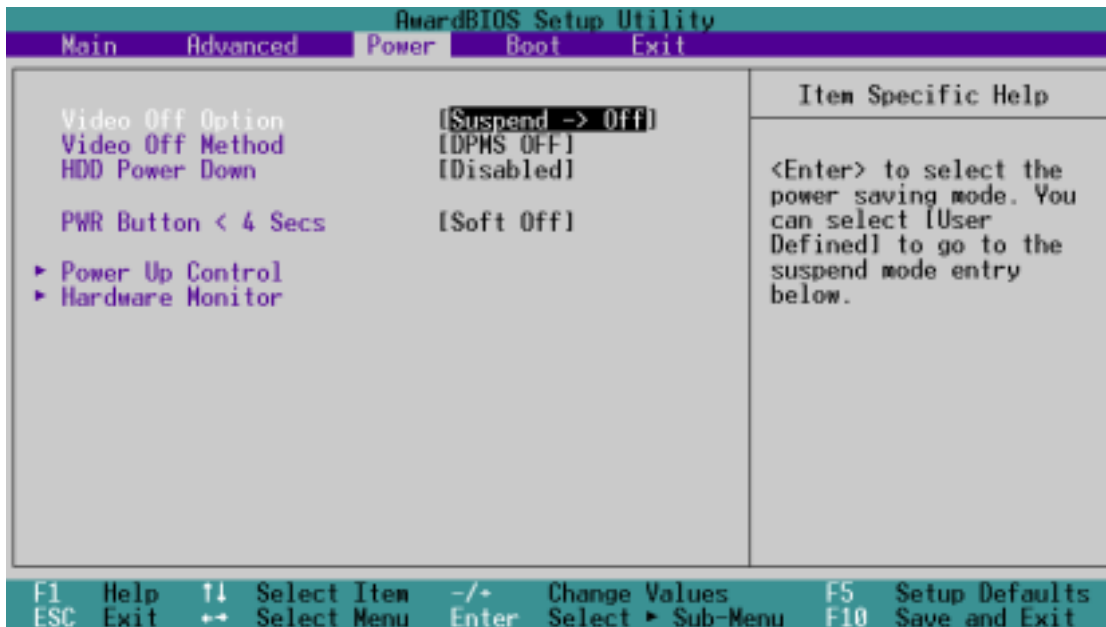

Video Off Option [Suspend -> Off]

This field determines when to activate the video off feature for monitor power management. Configuration options: [Always On] [Suspend -> Off]

Video Off Method [DPMS OFF]

This field defines the video off features. The DPMS (Display Power Management System) feature allows the BIOS to control the video display card if it supports the DPMS feature. [Blank Screen] only blanks the screen (use this for monitors without power management or “green” features. If set up in your system, your screen saver will not display with [Blank Screen] selected). [V/H SYNC+Blank] blanks the screen and turns off vertical and horizontal scanning. Configuration options: [Blank Screen] [V/H SYNC+Blank] [DPMS Standby] [DPMS Suspend] [DPMS OFF] [DPMS Reduce ON]

HDD Power Down [Disabled]

Shuts down any IDE hard disk drives in the system after a period of inactivity as set in this user-configurable field. This feature does not affect SCSI hard drives. Configuration options: [Disabled] [1 Min] [2 Min] [3 Min]...[15 Min]

4. BIOS SETUP

PWR Button < 4 Secs [Soft Off]

When set to [Soft off], the ATX switch can be used as a normal system power-off button when pressed for less than 4 seconds. [Suspend] allows the button to have a dual function where pressing less than 4 seconds will place the system in sleep mode. Regardless of the setting, holding the ATX switch for more than 4 seconds will power off the system. Configuration options: [Soft off] [Suspend]

4.5.1 Power Up Control

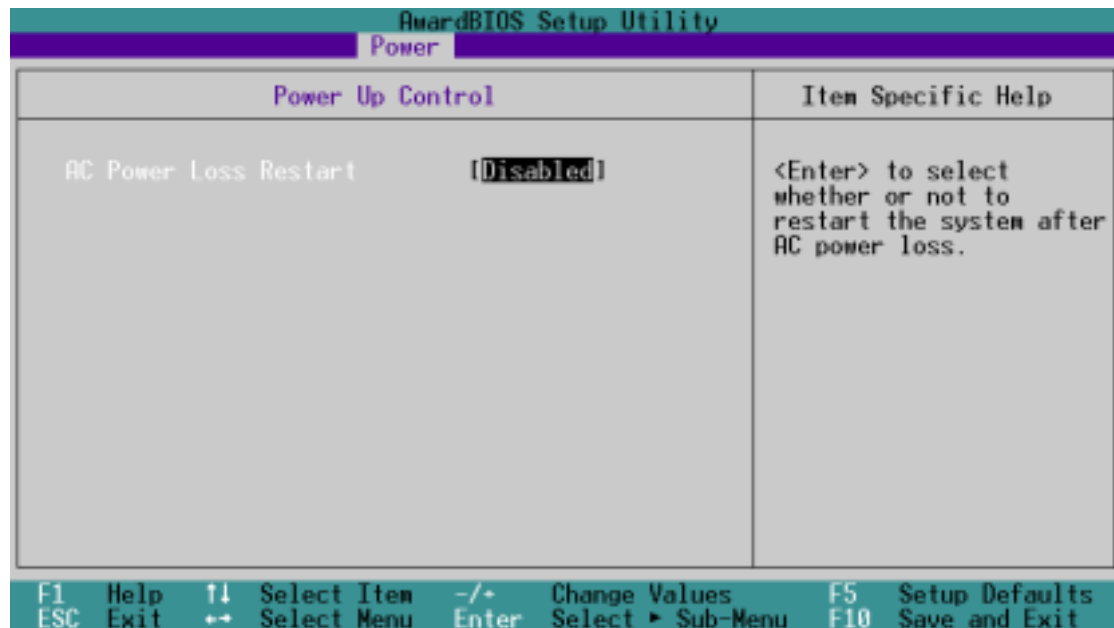

AC PWR Loss Restart [Disabled]

This allows you to set whether you want your system to reboot after the power has been interrupted. [Disabled] leaves your system off and [Enabled] reboots your system. [Previous State] sets your system back to the state it is before the power interruption. Configuration options: [Disabled] [Enabled] [Previous State]

4. BIOS SETUP

4.5.2 Hardware Monitor

Hardware Monitor		Item Specific Help
MB Temperature	33°C/91°F	<Enter> to switch between Monitoring or Ignore.
CPU Temperature	46°C/114°F	
Power Temperature	N/A	
CPU Fan Speed	7500RPM	
CHIP Fan Speed	7670RPM	
PWR Fan Speed	N/A	
VCORE Voltage	1.52V	
+3.3V Voltage	3.33V	
+5V Voltage	5.00V	
+12V Voltage	12.00V	
F1 Help ↑↓ Select Item -/+ Change Values F5 Setup Defaults		
ESC Exit → Select Menu Enter Select ► Sub-Menu F10 Save and Exit		

MB Temperature [xxxC/xxxF]

CPU Temperature [xxxC/xxxF]

POWER Temperature N/A

The onboard hardware monitor automatically detects the MB (motherboard), CPU, and JTPWR (power supply) temperatures.

CPU Fan Speed [xxxxRPM]

CHIP Fan Speed [xxxxRPM]

PWR Fan Speed N/A

The onboard hardware monitor automatically detects the speeds of the CPU fan, chassis fan, and chassis fan measured in rotations per minute (RPM).

VCORE1/VCORE2 Voltage

+3.3V Voltage, +5V Voltage, +12V Voltage

The onboard hardware monitor automatically detects the voltage output through the onboard voltage regulators.

NOTE: If any of the monitored items is out of range, the following error message appears: “Hardware Monitor found an error. Enter Power setup menu for details”. You will then be prompted to “Press **F1** to continue or **DEL** to enter SETUP”.

4. BIOS SETUP

4.6 Boot Menu

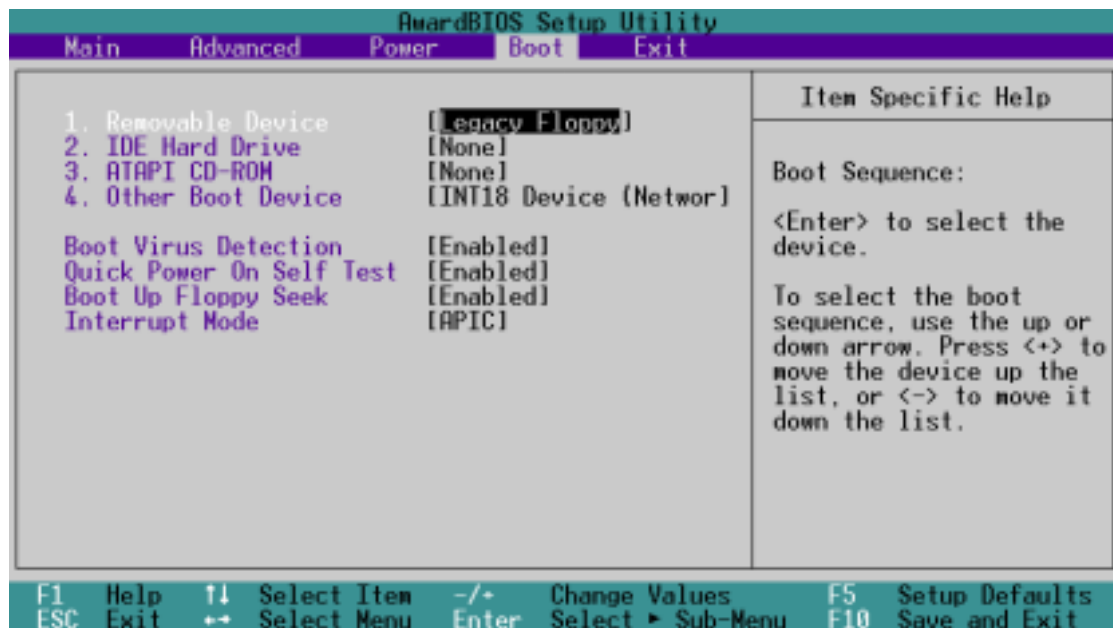

Boot Sequence

The Boot menu allows you to select among the four possible types of boot devices listed using the up and down arrow keys. By using the <+> or <Space> key, you can promote devices and by using the <-> key, you can demote devices. Promotion or demotion of devices alters the priority which the system uses to search for a boot device on system power up. Configuration fields include **Removable Devices**, **IDE Hard Drive**, **ATAPI CD-ROM**, and **Other Boot Device**.

Removable Device [Legacy Floppy]

Configuration options: [Disabled] [Legacy Floppy] [LS120] [ZIP] [ATAPI MO]

IDE Hard Drive

This field allows you to select which IDE hard disk drive to use in the boot sequence. Pressing [Enter] will show the product IDs of all connected IDE hard disk drives.

ATAPI CD-ROM

This field allows you to select which ATAPI CD-ROM drive to use in the boot sequence. Pressing [Enter] will show the product IDs of all your connected ATAPI CD-ROM drives.

Other Boot Device Select [INT18 Device (Network)]

Configuration options: [Disabled] [SCSI Boot Device] [INT18 Device (Network)]

4. BIOS SETUP

Boot Virus Detection [Enabled]

This field allows you to set boot virus detection, ensuring a virus-free boot sector. The system halts and displays a warning message when it detects a virus. If this occurs, you can either allow the operation to continue or use a virus-free bootable floppy disk to restart and investigate your system. Configuration options: [Disabled] [Enabled]

Quick Power On Self Test [Enabled]

This field speeds up the Power-On-Self Test (POST) routine by skipping retesting a second, third, and fourth time. Configuration options: [Disabled] [Enabled]

Boot Up Floppy Seek [Enabled]

When enabled, the BIOS will seek the floppy disk drive to determine whether the drive has 40 or 80 tracks. Configuration options: [Disabled] [Enabled]

Interrupt Mode [APIC]

Configuration options: [APIC] [PIC]

4. BIOS SETUP

4.7 Exit Menu

When you have made all of your selections from the various menus in the Setup program, save your changes and exit Setup. Select **Exit** from the menu bar to display the following menu:

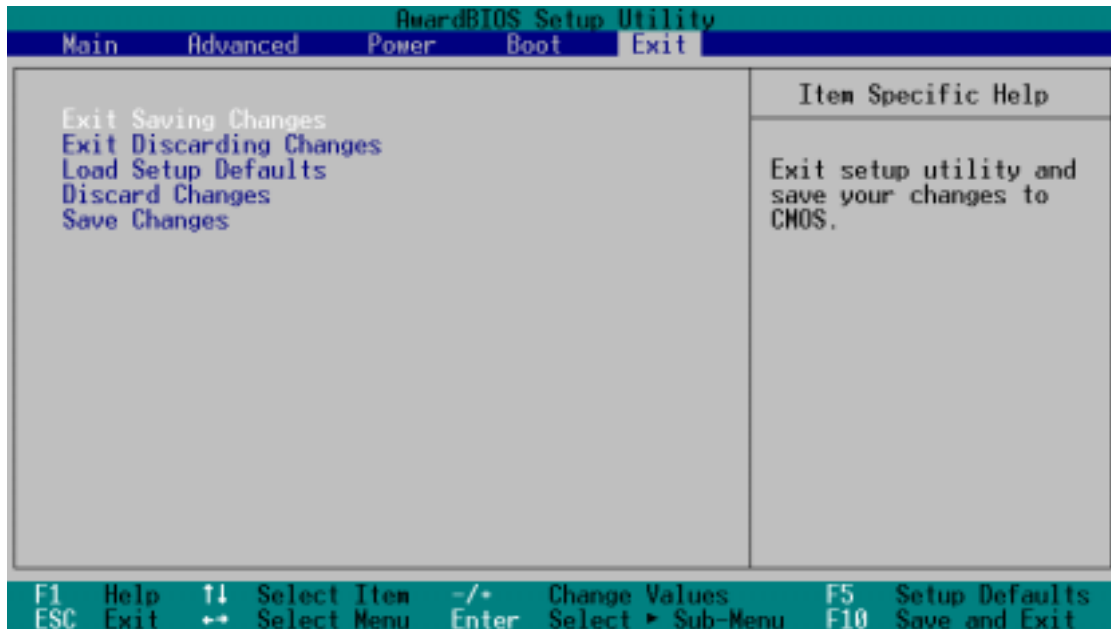

NOTE: Pressing <Esc> does not immediately exit this menu. Select one of the options from this menu or <F10> from the legend bar to exit this menu.

Exit Saving Changes

Once you are finished making your selections, choose this option from the Exit menu to ensure the values you selected are saved to the CMOS RAM. The CMOS RAM is sustained by an onboard backup battery and stays on even when the PC is turned off. When selecting this option, a confirmation window appears. Select [Yes] to save changes and exit. Normally, as the system exits, a single beep confirms that the changes were saved. If three beeps sound consecutively, the system will restart with a pertinent warning message.

NOTE: If you attempt to exit the Setup program without saving your changes, the program prompts with a message asking to save changes before exiting. Pressing <Enter> saves the changes while exiting.

Exit Discarding Changes

Select this option only if you do not want to save the changes to the Setup program. If you made changes to fields other than system date, system time, and password, BIOS asks for a confirmation before exiting.

4. BIOS SETUP

Load Setup Defaults

This option allows you to load the default values for each of the parameters on the Setup menus. When you select this option or if you press <F5>, a confirmation window appears. Select [Yes] to load default values. Select **Exit Saving Changes** or make other changes before saving the values to the non-volatile RAM.

Discard Changes

This option allows you to discard the selections you made and restore the previously saved values. After selecting this option, a confirmation appears. Select [Yes] to discard any changes and load the previously saved values.

Save Changes

This option saves your selections without exiting the Setup program. You can then return to other menus and make further changes. After you select this option, a confirmation window appears. Select [Yes] to save any changes to the non-volatile RAM.

5. SOFTWARE SETUP

5.1 Install Operating System

You should always use the latest operating system and updates when using new hardware to ensure full compliancy. You may use any version of Windows 98/2000/Millennium, but for Windows 95, you must use OSR 2.0 or later. For Windows NT 4.0, you must use Service Pack 3.0 or later.

5.2 Start Windows

When you start Windows for the first time after installing your motherboard, Windows will detect all plug-and play devices. Follow the Add New Hardware Wizard to install all necessary device drivers. When prompted to restart, select **No** and then follow the setup procedures in this section.

NOTE: Because there are various motherboard settings, options, and expansion cards, the following can only be used as a general reference and may not reflect exactly the screen contents displayed on your screen.

5. SOFTWARE SETUP

5.3 A7N266 Series Motherboard Support CD

NOTE: The support CD contents are subject to change at any time without notice.

To begin using your support CD disc, just insert it into your CD-ROM drive and the support CD installation menu should appear. If the menu does not appear, double-click or run **D:\ASSETUP.EXE** (assuming that your CD-ROM drive is drive **D:**).

NOTE: The nVidia nForce System drivers must be manually installed if using the the Windows 98 OS. See 5.3.3 on page 80 for more information.

5.3.1 Installation Menu



- **NVIDIA nForce Drivers:** Installs the video drivers. The Windows ME™ OS must be used with these drivers. The nVidia drivers do not support Windows NT OS. (*Remember* to uninstall all other INF drivers before installing nVidia drivers on a previously used system.) If using Win98, it is necessary to install three system drivers manually; see page 80.
- **NVIDIA Display Driver:** Installs the drivers for NVIDIA's integrated VGA displays. Turn off all anti-virus software before installation. The nVidia drivers do not support Windows NT OS. (*Remember* to uninstall all other INF drivers before installing nVidia drivers on a previously used system.)
- **C-Media Audio Driver and Application:** Installs the drivers for the C-Media Audio Driver and its program applications to set-up multi-channel audio features.
- **Realtek RTL8139 Family PCI Fast Ethernet NIC Driver:** Installs a fast ethernet driver for the onboard Realtek NIC.
- **ASUS PC Probe Vx.xx:** Installs a smart utility to monitor your computer's fan, temperature, and voltages.
- **Install ASUS Update Vx.xx:** Installs a program that can help you update BIOS or download a BIOS image file.
- **Microsoft DirectX Driver:** Installs basic drivers to enable compatibility with audio and other special functions.
- **PC-CILLIN 2000:** Installs the latest anti-virus protection application.

5. SOFTWARE SETUP

- **Adobe Acrobat Reader Vx.xx:** Installs the Adobe Acrobat Reader software necessary to view user's manuals saved in PDF format. Updated or other language versions of this motherboard's manual is available in PDF format at any of our web sites.
- **Cyberlink Video and Audio Applications:** Installs Cyberlink PowerPlayer SE and Cyberlink VideoLive Mail.

(CLICK RIGHT ARROW TO ACCESS NEXT PAGE)

- **ASUS Screen Saver:** Installs a nifty ASUS screen saver.
- **E-Color 3Deep:** Installs graphical driver and an application for tuning the quality of color output from CRT and LCD monitors.
- **Show Motherboard Information:** Allows you to view information about your motherboard, such as product name, BIOS version, and CPU.
- **Browse Support CD:** Allows you to view the contents of the CD.
- **ReadMe:** Allows you to view the support CD file list and contact information.
- **Exit:** Exits the CD installation menu.

(CLICK LEFT ARROW TO RETURN)

5.3.2 Installation Procedure

On the **Installation Items Menu**, click on the name of the driver or program group to begin installation. Follow the instructions that appear on the setup screens. All drivers and programs install automatically. Refer to the Software Reference section for software operating instructions.

5. SOFTWARE SETUP

5.3.3 Manual Installation of Drivers for Windows 98

Use the Device Manager to uninstall all previously installed system drivers that may conflict with the installation and operation of the nVidia® system drivers .

Three nVidia® drivers need to be installed to operate with the Win98 system:

1. PCI System Management Bus.
2. PCI Standard Host CPU Bridge.
3. PCI Standard RAM Controller.

ITEM 1: PCI System Management Bus

1. Go to the Device Manager.
2. Select “PCI System Management Bus” in “Other Devices.”
3. Click on “Properties.”
4. Click on “Driver.”
5. Select “Update Driver.”
6. Select “Search for a better driver than the one your device is using now” option.
7. Click on “Specify the location” and then type or browse for the path on the CD ROM Drive:\Drivers\Chipset\Nvidia\win9x\SMbus. This installs the driver.
8. Click “Next.”
9. You should see that the “PCI System Management” is detected.
10. You do not need to restart if you need to install more drivers.
11. Continue to install more drivers.

ITEM 2: PCI Standard Host CPU Bridge (GART driver)

1. Go to the “Device Manager.”
2. Select “PCI standard Host CPU Bridge” in “System Devices”
3. Click on “Properties.”
4. Click on “Driver.”
5. Select “Update Driver.”
6. Select “Search for a better driver than the one your device is using now” option.
7. Click on “Specify the location” and then type or browse for the path on the CD ROM Drive:\Drivers\Chipset\Nvidia\win9x\Gart. This installs the driver.
8. Click “Next.”
9. You should see that the “AGP Host to the PCI Bridge” is detected.
10. There is no need to restart if you need to install more drivers.
11. Continue to install the next driver.

5. SOFTWARE SETUP

ITEM 3: PCI Standard Ram Controller

1. Go to the Device Manager
2. Select PCI standard RAM Controller in “System Devices”
3. Click on “Properties.”
4. Click on “Driver.”
5. Select “update driver”
6. Select “Search for a better driver than the one your device is using now” option.
7. Click on “Specify the location” and then type or browse for the path on the CD-ROM Drive:\Drivers\Chipset\Nvidia\win9x\MemoryController. This installs the driver.
8. Click “Next.”
9. You should see two “NVIDIA nForce 220/420 Memory Controller” and one “NVIDIA nForce 420 Memory Controller (DDR)” detected.
10. There is no need to restart if you need to install more drivers.

6. SOFTWARE REFERENCE

6.1 ASUS Live Update

ASUS LiveUpdate is a utility that allows you to update your motherboard's BIOS and drivers. The use of this utility requires that you are properly connected to the Internet through an Internet Service Provider (ISP).

1. Start ASUS Update

Launch the utility from your Windows Start menu: **Programs/AsusUpdate**

2. Select an update method.



3. If you selected updating/downloading from the Internet, you will need to select an Internet site. Choose the site that is closest to you or click **Auto Select**.



4. From the FTP site, select the BIOS version that you wish to download. Click **Next**.



5. Follow the instructions on the succeeding screens to complete the update process. If you selected the option to update the BIOS from a file, a window pops up prompting you to locate the file. Select the file, click **Save**, then follow the screen instructions to complete the update process.



6. SOFTWARE REFERENCE

6.2 ASUS PC Probe

ASUS PC Probe is a convenient utility to continuously monitor your computer system's vital components, such as fan rotations, Voltages, and temperatures. It also has a utility that lets you review useful information about your computer, such as hard disk space, memory usage, and CPU type, CPU speed, and internal/external frequencies through the DMI Explorer.

6.2.1 Starting ASUS PC Probe

When ASUS PC Probe starts, a splash screen appears allowing you to select whether or not to show the screen the next time you open PC Probe. To bypass this startup screen, clear the **Show up in next execution** check box.

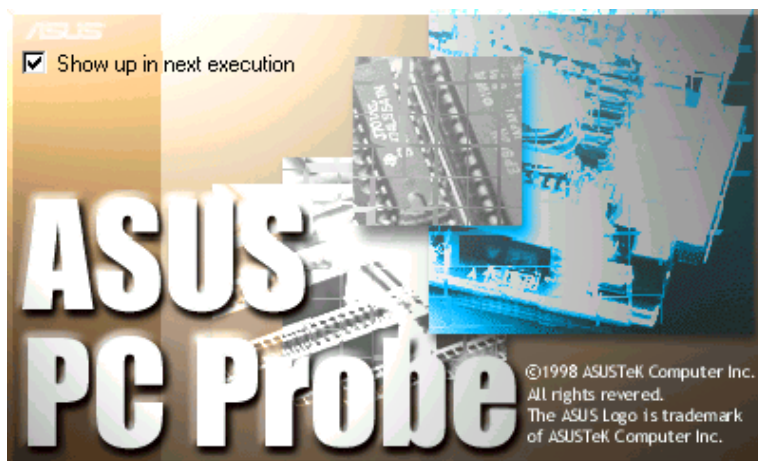

To start **ASUS PC Probe**, click the Windows **Start** button, point to **Programs**, and then **ASUS Utility**, and then click **Probe Vx.xx**.

The PC Probe icon  will appear on the taskbar's system tray indicating that ASUS PC Probe is running. Clicking the icon will allow you to see the status of your PC.

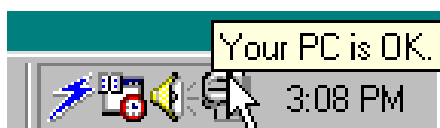

6. SOFTWARE REFERENCE

6.2.2 Using ASUS PC Probe Monitoring

Monitor Summary

Shows a summary of the items being monitored.



Temperature Monitor

Shows the PC's temperature.

Temperature Warning threshold adjustment
(Move the slider up to increase the threshold level or down to decrease the threshold level)



Fan Monitor

Shows the PC's fan rotation.

Fan Warning threshold adjustment
(Move the slider up to increase the threshold level or down to decrease the threshold level)

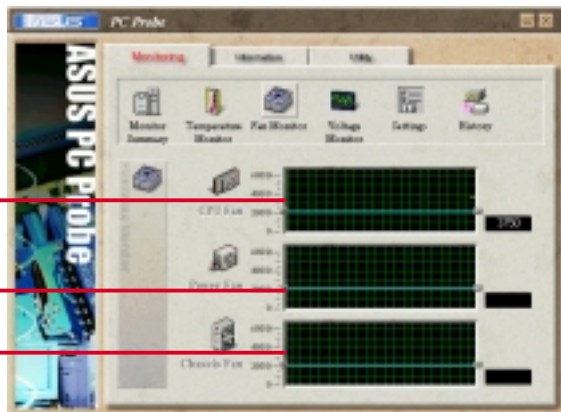

Voltage Monitor

Shows the PC's voltages.

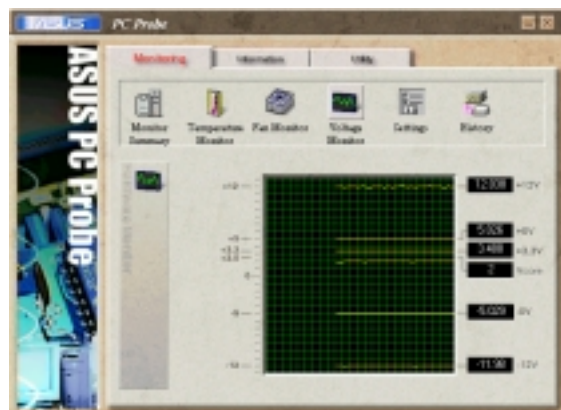

6. SOFTWARE REFERENCE

Settings

Lets you set threshold levels and polling intervals or refresh times of the PC's temperature, fan rotation, and voltages.



CPU Cooling System Setup

Lets you select when to enable software CPU cooling. When **When CPU Overheated** is selected, the CPU cooling system is enabled whenever the CPU temperature reaches the threshold value.

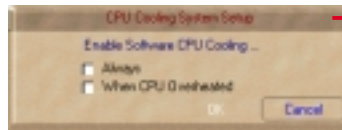

History

Lets you record the current monitoring activity of a certain component of your PC for future reference.

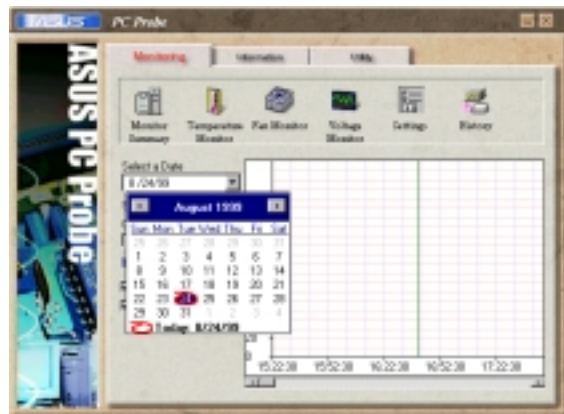

Information

Hard Drives

Shows the used and free space of the PC's hard disk drives and the file allocation table or file system used.

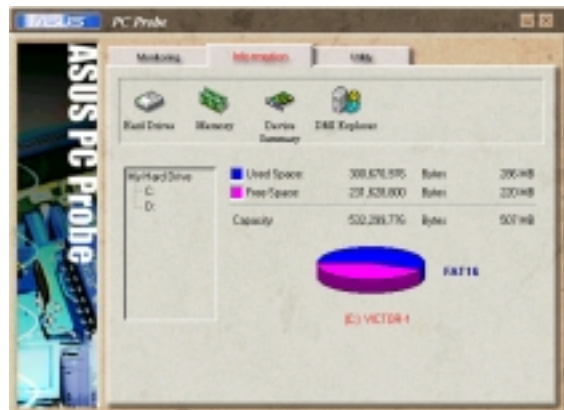

6. SOFTWARE REFERENCE

Memory

Shows the PC's memory load, memory usage, and paging file usage.



Device Summary

Shows a summary of devices in your PC.



DMI Explorer

Shows information pertinent to the PC, such as CPU type, CPU speed, and internal/external frequencies, and memory size.



Utility

Lets you run programs outside of the ASUS Probe modules. To run a program, click **Execute Program**.



6. SOFTWARE REFERENCE

6.2.3 ASUS PC Probe Task Bar Icon

Right-clicking the PC Probe icon will bring up a menu to open or exit ASUS PC Probe and pause or resume all system monitoring.



When the ASUS PC Probe senses a problem with your PC, portions of the ASUS PC Probe icon changes to red, the PC speaker beeps, and the ASUS PC Probe monitor is displayed.

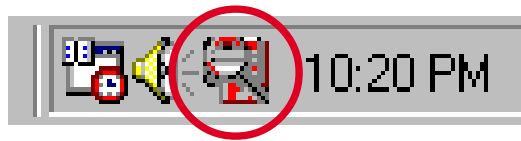

6. SOFTWARE REFERENCE

6.3 Multi-Channel Audio Feature Setup

The C-Media PCI Audio Driver and Applications are located on the Support CD. Installing the programs enables the multi-channel audio feature. **Note:** You must use 4 or 6 channel speakers for this setup.

6.3.1 The C-Media Audio Mixer

1. The C-Media Mixer

Icon appears on the bottom right of the screen, or the **Mixer** may be turned on from the **PCI Audio Applications & Audio Rack** groups on the **Main Program** menu using the Windows **Start** button:  Click on the **icon** to display the C-Media **Audio Mixer**:

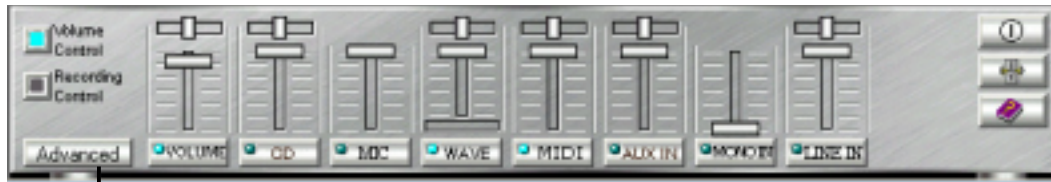

2. The **Advanced** button activates the **Speaker, Volume, Sound Effects** and **Options** menus. The **Speaker** menu offers various configurations for your speaker system. This menu enables the **Line-In** and **Mic-In** audio jacks on the back panel to setup additional speakers for 4 and 6-Channel Audio.



6.3.2 The C-Media Audio Demo Program

1. The Audio Demo program offers an easy way to test and tune your new speaker system. Activate the **Multi-Channel Audio Demo** program from the **PCI Audio Applications** group on the **Main Program** menu using the Windows **Start** button:

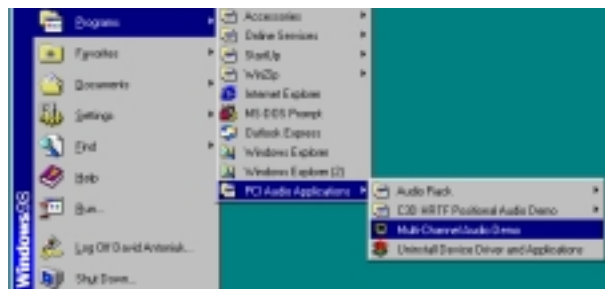

6. SOFTWARE REFERENCE

2. The **PCI Multi-Channel Audio Demo** has several **Demos** to help fine tune your PC speaker system. The **Help** menu features several pages of instructions and hardware diagrams to help configure and test the system. To activate the **Speaker Channel Configuration Menu**, point your mouse arrow and click on the **TV box**.



3. The **Speaker Channel Configuration Menu** displays all the options available to help tune the multi-channel audio system even more precisely.

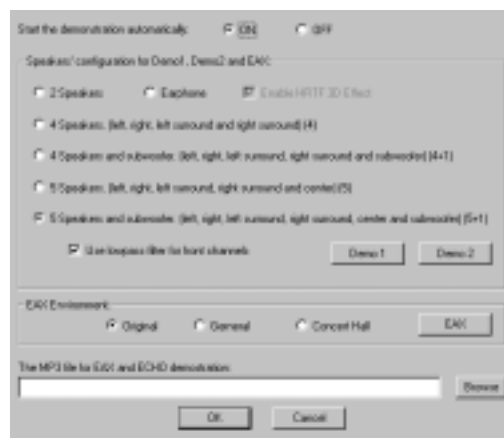

6.3.3 Connector Configuration

The **chart** below displays the configurations for the line connectors on the yellow MIDI/Game/Audio connector port located on the back panel. The three female connectors are available for use in the 6-Channel audio system.

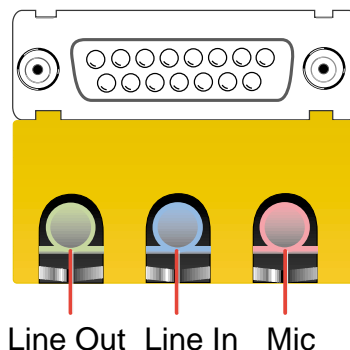

Connector Settings and Functions

	Headphone/ 2-Speaker	4-Speaker	6-Speaker
Line	Line Out/ Front Spkr Out	Line Out/ Front Spkr Out	Line Out/ Front Spkr Out
Light Blue	Line In	Rear Speaker Out	Rear Speaker Out
Pink	Mic In	Mic In	Center Speaker Out, Sub-woofer

Note: See 7 in Section 3, *Motherboard settings* for the Bass/Center Jumper settings to fine tune the output signals.

6. SOFTWARE REFERENCE

6.4 3Deep Color Tuner

The 3-Deep color tuner is designed to match your CRT or LCD color monitor to maximize the color quality of all graphical applications. Users may also tune their internet applications to match “true” internet source colors with the color displayed on the monitor.

Simply run the setup program from the start menu and follow the instructions on the various setup/test screens.

6.4.1 3Deep Color Tuning

1. Select the type of monitor connected to the computer, either **CRT** or **LCD**.



2. Follow the instructions to manually adjust the **brightness** level of the monitor.



3. Select the faintest of the three colors: **blue**, **red** and **green**.

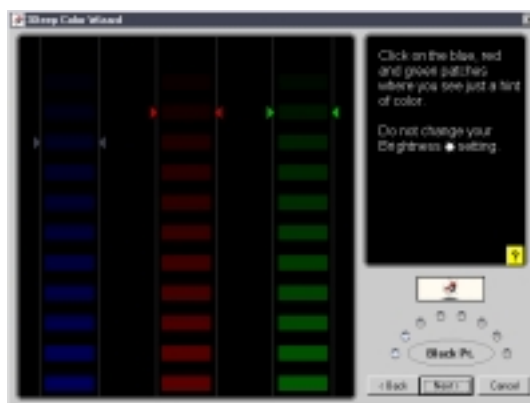

6. SOFTWARE REFERENCE

4. Select the color squares which most closely blend and match with the background.
5. The next step repeats the color matching process to achieve full color quality.

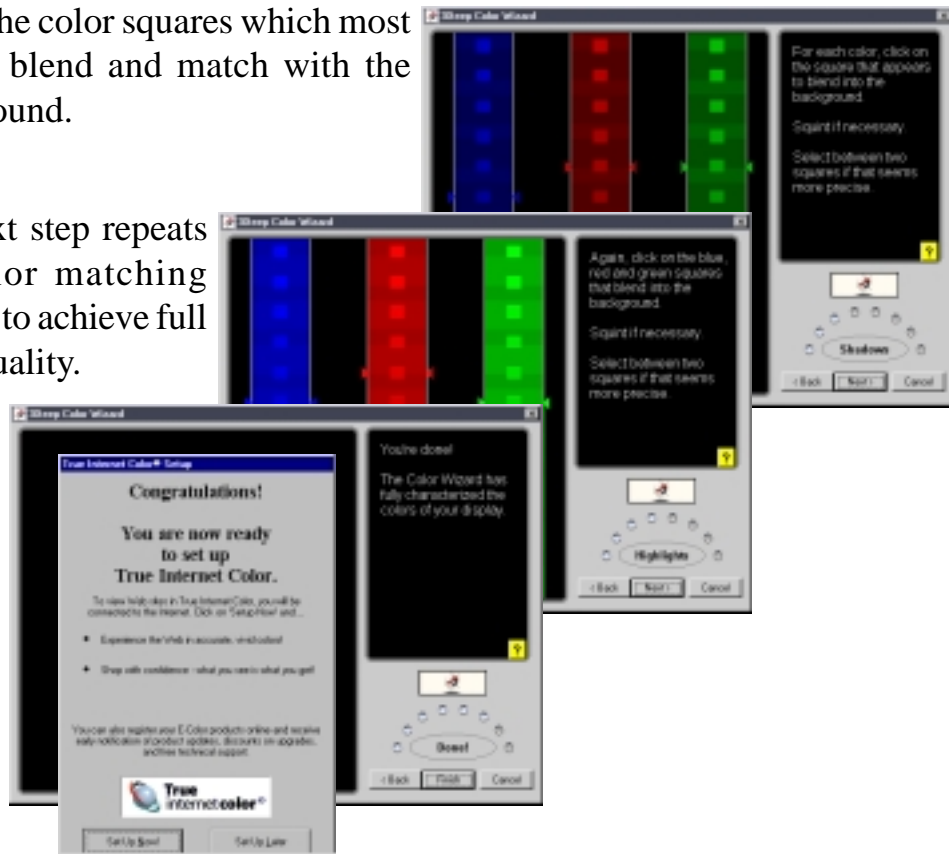

6. SAW REFERENCE
3Deep Color

6. The tuning process is complete. Click on the bottom left button to connect to the internet and follow the instructions.

6.4.2 The 3Deep Control Panel

Using the Windows **Start button**, activate the **3Deep Control Panel** program from the **3Deep Applications** group on the **Main Program** menu. The control panel offers access to the **Color Wizard** tuning program, a **Game Gamma** setting and a **Tweak** slider for brightness adjustment.

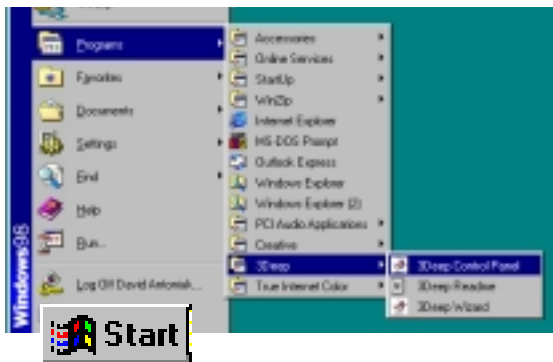

6. SOFTWARE REFERENCE

6.5 CyberLink PowerPlayer SE

CyberLink PowerPlayer SE is an intelligent software player that can automatically detect and playback all kinds of video/audio files, CD and MP3 files as well. This is the only software you need for all types of video and audio files. No need to waste time identifying your file types.

6.5.1 Starting CyberLink PowerPlayer SE

To start **CyberLink Power Player**, click the Windows **Start** button, point to **Programs**, and then **CyberLink PowerPlayer SE**, and then click **PowerPlayer**.

6.5.2 CyberLink PowerPlayer Control Panel

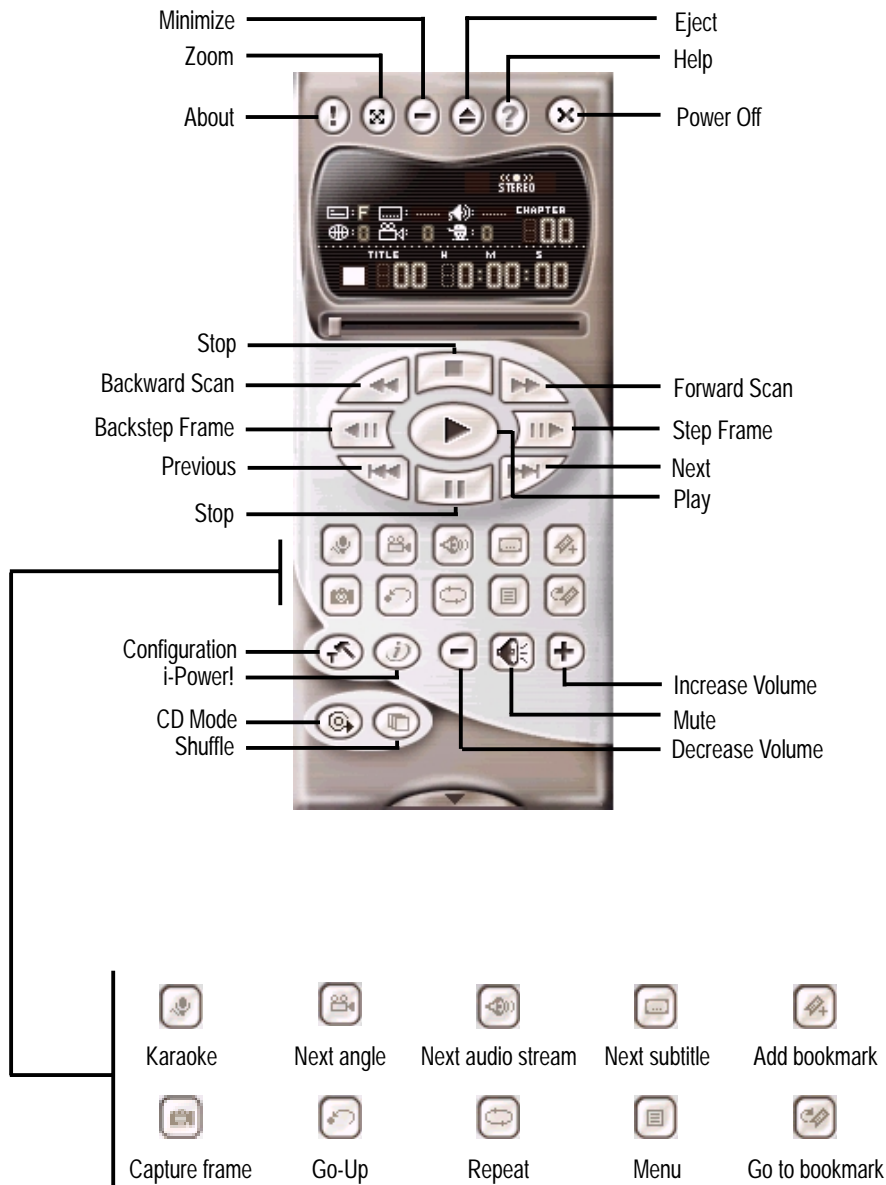

6. SOFTWARE REFERENCE

6.6 CyberLink VideoLive Mail

CyberLink's VideoLive Mail Plus Ver 3.0 (a.k.a. VLM 3) is a convenient and excellent way to create professional quality video mails from PC video/audio input devices and to send the mails to any recipients via VLM 3's built-in e-mail system through the Internet. VLM 3's mails comprise video, sound, or snapshot information; and thus may convey the most profound information to target audiences. It is very convenient for mail recipients who do not need to install additional software component in order to view VLM 3 mails.

VLM 3 works as a very applicant sales tool. It efficiently delivers profound and live product information to your target customers without costing a fortune. VLM 3 also helps corporate managers easily give vivid speeches and broadcast through corporate E-mail system. For personal or home users, VLM 3 easily records live video clips allowing users to send them to friends or family members across the Internet.

VLM 3 loads video messages from PC cameras, digital camcorders, analog camcorder via video capture cards, or from an existing AVI video clips, and captures audio messages from PC microphones. Video and audio messages are encoded at a very high compressed rate in a real-time mode. From data input, data conversion, to sending video mails via Internet, or saving data to disks, the whole procedure is done in an easy and continuous process.

VLM 3's video clip compression rate is up to 1:900, and its playback rate is up to 30 frame per second. VLM 3 provides CIF (352 x 288 pixel) display resolution, and support true color configuration. A one-minute video mail with QCIF (176 x 144) resolution takes up less than 500KB of memory, making it easy to transmit and save mail. Users may always adjust resolution and recording parameters for different purpose.

VLM 3 supports all the hardware devices that are compliant with Video for Windows standard. Video for Windows is a well-accepted and well-tested standard. Thus, users do not have to worry about compatibility issues.

6. SOFTWARE REFERENCE

6.6.1 Starting VideoLive Mail

To start **VideoLive Mail**, click the Windows **Start** button, point to **Programs**, and then **CyberLink VideoLive Mail**, and then click **VideoLive Mail x.x**. VLM 3's Setup Wizard will start and guide you through configuring the video and audio input peripherals and to setup the e-mail environment.

1. Setup Wizard first will prompt a dialog to confirm that you want to configure the hardware and E-mail setting. Click **Yes** to continue the system parameter configuration.
2. The e-mail configuration screen appears. You will need to enter your name and the e-mail address. Click **Next** to continue.
3. The Internet e-mail configuration screen appears. You may choose to use the VLM 3 built-in E-mail functionality (SMTP mail), or use MAPI compliant e-mail system. Consult your ISP or MIS staff for the E-mail server IP address if you are not sure. Click **Next** to continue.
4. Then the Video Configuration screen shows up. You may have to specify the video driver for VLM 3, if there are several video-input devices installed. Then configure the number of video frames to be captured per second. Note that the more frames you choose, the bigger the file size will be. Click **Next** to continue.
5. Then the Setup Wizard will then search for the GSM CODECS module for audio compression, and prompt you with the result. Click **Next** to continue.
6. Setup Wizard then tests the audio volume during playing and recording. Click **Next** when ready.
7. Configuration done. Click **Finish** to complete the environmental setting procedure.

6.6.2 CyberLink VideoLive Mail User Interface



7. APPENDIX

7.1 Glossary

1394

1394 is the IEEE designation for a high performance serial bus that offers data transfers at 100/200/400 Mbps. This serial bus defines both a back plane physical layer and a point-to-point cable-connected virtual bus. The primary application of the cable version is the integration of I/O connectivity at the back panel of personal computers using a low-cost, scalable, high-speed serial interface. The 1394 standard also provides new services such as live connect/disconnect capability for external devices including disk drives, printers and hand-held peripherals such as scanners and cameras. This is a new standard to complement the slower USB interface and to compete with the more expensive SCSI interface.

AC97 (Audio Codec '97)

AC '97 is the next step in enabling PCs with audio quality comparable to consumer electronics devices. The specification defines new cost-effective options to help integrate the components necessary to support next-generation audio-intensive PC applications such as DVD, 3-D multiplayer gaming and interactive music. The specification also defines new extensions supporting modem and docking to help both desktop and mobile manufacturers adopt these new technologies more quickly and cost-effectively. This specification uses software emulation to compete with the PCI SoundBlaster specification.

ACPI (Advanced Configuration and Power Interface)

The ACPI specification defines a cross-platform interface designed to support many operating systems. ACPI defines a flexible and abstract hardware interface that provides a standard way to integrate power management features throughout a PC system, including hardware, operating system and application software. This enables the system to automatically turn ON and OFF peripherals such as CD-ROMs, network cards, hard disk drives, and printers, as well as consumer devices connected to the PC such as VCRs, TVs, phones, and stereos. With this technology, peripherals will also be able to activate the PC. For example, inserting a tape into a VCR can turn on the PC, which could then activate a large-screen TV and high-fidelity sound system.

AGP (Accelerated Graphics Port)

An interface specification that enables high-performance 3D graphics on mainstream PCs. AGP was designed to offer the necessary bandwidth and latency to perform texture mapping directly from system memory.

Bus	Bus Frequency	Bandwidth	Data Transfer Rate
PCI	33MHz	33MHz	133MByte/sec
AGP 1X	66MHz	66MHz	266MByte/sec
AGP 2X	66MHz	133MHz	512MByte/sec
AGP 4X	66MHz	266MHz	1024MByte/sec

Backup. A copy of a file, directory, or volume on a separate storage device from the original. This copy is for the purpose of data retrieval in case the original is accidentally erased, damaged, or destroyed.

BIOS (Basic Input/Output System)

BIOS is a set of routines that affect how the computer transfers data between computer components, such as memory, disks, and the display adapter. The BIOS instructions are built into the computer's read-only memory. BIOS parameters can be configured by the user through the BIOS Setup program. The BIOS can be updated using the provided utility to copy a new BIOS file into the EEPROM.

Bit (Binary Digit)

Represents the smallest unit of data used by the computer. A bit can have one of two values: 0 or 1.

7. APPENDIX

Boot

Boot means to start the computer operating system by loading it into system memory. When the manual instructs you to “boot” your system (or computer), it means to turn ON your computer. “Reboot” means to restart your computer. When using Windows 95 or later, selecting “Restart” from “Start | Shut Down...” will reboot your computer.

Bus Master IDE

PIO (Programmable I/O) IDE requires that the CPU be involved in IDE access and waiting for mechanical events. Bus master IDE transfers data to/from the memory without interrupting the CPU. Bus master IDE driver and bus master IDE hard disk drives are required to support bus master IDE mode.

Byte (Binary Term)

One byte is a group of eight contiguous bits. A byte is used to represent a single alphanumeric character, punctuation mark, or other symbol.

Cache Memory. A type of RAM that allows a faster from the CPU than a regular RAM. The cache memory eliminates the CPU wait state. When the CPU reads data from the main memory, a copy of this data is stored in the cache memory. The next time the same address, the data is transferred from the cache memory instead of from the main memory.

CODEC (Compressor/Decompressor). A software component that translates video or audio between its uncompressed form and the compressed form in which it is stored.

COM Port

COM is a logical device name used by to designate the computer serial ports. Pointing devices, modems, and infrared modules can be connected to COM ports. Each COM port is configured to use a different IRQ and address assignment.

Concurrent PCI

Concurrent PCI maximizes system performance with simultaneous CPU, PCI and ISA bus activities. It includes multi-transaction timing, enhanced write performance, a passive release mechanism and support for PCI 2.1 compliant delayed transactions. Concurrent PCI provides increased bandwidth, reduced system latencies, improves video and audio performance, and improves processing of host based applications.

CPU (Central Processing Unit)

The CPU, sometimes called “Processor,” actually functions as the “brain” of the computer. It interprets and executes program commands and processes data stored in memory. Currently, there are socket 370 (for Pentium III FC-PGA and Celeron-PPGA), socket 7 (for Pentium, AMD, Cyrix, IBM), slot 1 (for Pentium II and III), slot 2 (for Xeon), and slot A (for AMD) processors.

Device Driver

A device driver is a special set of instructions that allows the computer’s operating system to communicate with devices such as VGA, audio, printer, or modem.

DOS (Disk Operating System)

DOS is the foundation on which all other programs and software applications operate, including Windows. DOS is responsible for allocating system resources such as memory, CPU time, disk space, and access to peripheral devices. For this reason, DOS constitutes the basic interface between you and your computer.

DRAM (Dynamic Random Access Memory)

A type of RAM that requires refresh cycles to prevent the loss of the data stored in it. There are several different types of DRAM such as, EDO DRAM (Extended Data Output DRAM), SDRAM (Synchronous DRAM), and RDRAM (Rambus DRAM) and DDR DRAM, (Double-Data Rate DRAM).

Flash ROM

non-volatile memory device that retains its data even when power is removed. This device is similar to EPROM, but unlike EPROM which can be erased only using an ultra-violet light, flash ROM can be electrically erased. Flash ROM is normally used for system BIOS, which initiates hardware devices and sets up necessary parameters for the OS. Since the flash ROM contents can be modified, users can easily update the BIOS..

7. APPENDIX

IDE (Integrated Drive Electronics)

IDE devices integrate the drive control circuitry directly on the drive itself, eliminating the need for a separate adapter card (in the case for SCSI devices). UltraDMA/33 IDE devices can achieve up to 33MB/Sec transfer.

I/O (Input/Output)

The data transfers from the input devices like a keyboard, mouse, or scanner, to the output devices like a printer or the monitor screen.

I/O Address

The specific memory location for a particular device. Two devices cannot share the same I/O address space.

IrDA (Infrared Data Association)

An international organization that creates and promotes inter-operable, low cost, infrared data interconnection standards that support a walk-up, point-to-point model. The IrDA protocol is designed to support transmission of data between two devices over short-range point-to-point infrared at speeds between 9.6Kbps and 4Mbps.

ISP (Internet Service Provider)

A company that provides customer access to the Internet and the World Wide Web for a fee. The ISP also provides Internet utilities and services like e-mail, newsgroup, weather reports, and a host of others. The user can connect to the ISP using a modem installed in the computer and connected to a phone line.

LPT Port (Line Printer Port)

Logical device name reserved by DOS for the computer parallel ports. Each LPT port is configured to use a different IRQ and address assignment.

MMX

A set of 57 new instructions designed to accelerate multimedia and communications applications, such as 3D video, 3D sound, video conference.

Modem

A device that allows a computer to talk to another computer through the phone system.

Network

An interconnected computer system linked by telephone wires, or other means.

OnNow

The OnNow design initiative is a comprehensive, system-wide approach to system and device power control. OnNow is a term for PC that is always ON but appears OFF and responds immediately to user or other requests. The OnNow design initiative involves changes that will occur in the Microsoft Windows operating system, device drivers, hardware, and applications, and also relies on the changes defined in the Advanced Configuration and Power Interface (ACPI) specification.

PC100/133

This is an industry-standard designation for memory capacity as a measure of the speed of the memory bus. New platform requirements ensure that memory does not become a bottleneck to system performance.

PCI Bus (Peripheral Component Interconnect Local Bus)

PCI bus is a standard specification that defines a 32-bit data bus interface.

PCI Bus Master

The PCI Bus Master can perform data transfer without local CPU help and the CPU can be treated as one of the Bus Masters. PCI 2.1 supports concurrent PCI operation to allow the local CPU and bus master to work simultaneously.

POST (Power On Self Test)

Powering on the computer initiates the POST, a series of software-controlled diagnostic tests. The POST checks system memory, the motherboard circuitry, the display, the keyboard, the diskette drive, and other I/O devices

7. APPENDIX

PS/2 Port

PS/2 ports are based on IBM Micro Channel Architecture. This type of architecture transfers data through a 16-bit or 32-bit bus. A PS/2 mouse and/or keyboard may be used on ATX motherboards.

RDRAM (Rambus DRAM)

Developed by Rambus, Inc., this type of memory can deliver up to 1.6GB of data per second. RDRAM is the first interface standard that can be directly implemented on high performance VLSI components such as, CMOS DRAMs, memory controllers, and graphics/video ICs.

RAM (Random Access Memory). The computer's primary storage area used to write, store, and retrieve information and program instructions which are passed to the CPU for processing. The information in RAM can be repeatedly re-written with new data. Compared to other storage media like magnetic tape, floppy disk, and hard disk, RAM has an extraordinarily fast access rate. RAM, however, is volatile, which means that the data stored in it are lost when the system power is turned off, or if power glitches occur. See also DRAM and SDRAM.

ROM (Read Only Memory)

ROM is nonvolatile memory used to store permanent programs (called firmware) used in certain computer components. Flash ROM (or EEPROM) can be reprogrammed with new programs (or BIOS).

SCSI (Small Computer System Interface)

High speed multi-threaded I/O interface defined by the X3T9.2 committee of the American National Standards Institute (ANSI) for connecting many peripheral devices. The standard started from 10MBytes/sec to 160MBytes/sec available today.

SDRAM (Synchronous DRAM)

A type of DRAM with access signals that are synchronized with the CPU clock, eliminating the delay associated with data transfers between the CPU and memory. SDRAM takes memory access away from the CPU control; internal registers in the memory accept the request, and lets the CPU do something else while the data requested is assembled for the next time the CPU talks to the memory.

SPD for SDRAM module

Serial Presence Detect (SPD) is most like an ID detect for SDRAM module, it using a EEPROM component on DIMM module for storing module configuration information inside. The Serial Presence Detect function is implemented using a 2048 bit EEPROM component. This nonvolatile storage device contains data programmed by the DIMM manufacturer that identifies the module type and various SDRAM organization and timing parameters.

System Disk

A system disk contains the core file of an operating system that boots up the operating system.

TCP/IP (Transmission Control Protocol/Internet Protocol). The communications protocol used by the UNIX system and the Internet. TCP checks for lost packets, puts the data from multiple packets into the correct order, and requests that missing or damaged packets be resent.

USB (Universal Serial Bus)

A 4-pin serial cable bus that allows up to 127 plug and play computer peripherals such as keyboard, mouse, joystick, scanner, printer, modem, and monitor to share a bandwidth through a host scheduled token based protocol. This allows attaching or detaching while the host and other peripherals are in operation. Supports synchronous and asynchronous transfer types over the same set of wires up to 12Mbit/sec. USB 2.0 provides twice the transfer rate compared to USB 1.0 and competes with the 1394 standard.

Wake-On-LAN

Computer will automatically wake-up upon receiving a wake-up packet through a Network interface when it is under power soft-off, suspend or sleep mode.

7. APPENDIX

7.2 Modem Riser

7.2.1 56K Software Modem

The Modem Riser (MR) is a high-speed PC communication peripheral which works with AMC'97/MC'97 compliant codecs. With this software modem, you can connect your computer to a remote location, receiving data at up to 56 Kbps in V.90 or K56flex modes.

7.2.2 Primary/Secondary MR

There are two types of modem risers: primary MR and secondary MR. In appearance, the primary MR has a crystal onboard but the secondary MR does not. If your motherboard has an audio codec and no PCI audio chipset onboard, you may use the secondary MR; otherwise, you should use the primary MR.

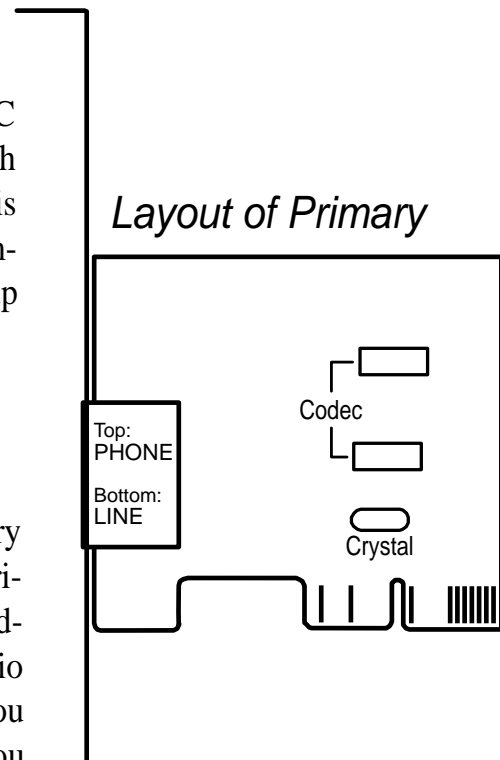

7. APPENDIX
Modem Riser

7.2.3 Hardware Installation Procedure



1. Power OFF your computer.
2. Open the computer chassis and remove the metal plate on the AMR expansion slot.
3. Carefully align the MR card's connector to the AMR slot and press firmly.
4. Secure the MR card onto the chassis with the screw removed in step 2.
5. Connect the MR card's **LINE** connector to a telephone wall jack. Connect the **PHONE** connector to a telephone (optional).
6. Replace the computer chassis.

7. APPENDIX

7.2.4 Software Setup in Windows 98

The Modem Riser supports the Plug and Play feature. It allows your computer to automatically set the optimal configurations for the MR and communication software. Follow the procedure below to install the modem driver.

1. Power ON the computer after the hardware installation is completed.
2. Windows 98 will automatically detect the modem and display a “PCI Card” message under “Add New Hardware Found”.
3. Select **Search for the best driver for your device** and click **Next**.
4. Insert the Support CD that came with your motherboard into your CD-ROM drive. Enter the path **E:\Modem\Win98** (assuming that your CD-ROM drive is drive E:) for the MR driver.
5. After the driver is located, click **Next** and then click **Finish**.
6. Restart your computer. Double click the modem icon at the bottom-right corner of the window. 
7. Click the **Settings** tab. Select your country and language. Click **OK**.
8. Click **Start**, point to **Settings**, click **Control Panel**, double click **Modems**, click the **General** tab, and click **Motorola SM56 AC-L Modem**.
9. Click **Diagnostic** and then click the designated COM port as shown.
10. Click **More Info...**. If the computer system successfully communicates with the modem, responses will be displayed as shown.

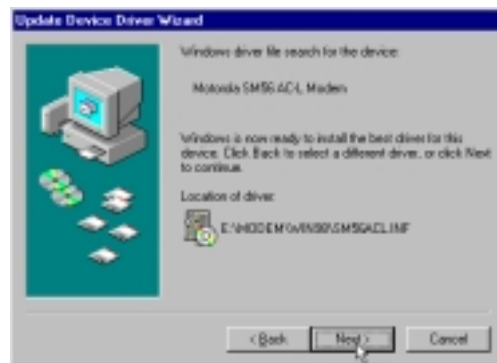
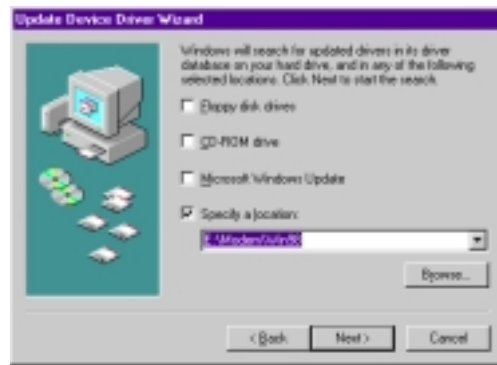

INDEX

A

Accelerated Graphics Port

AGP Capability 64

AGP Pro Slot 30

Accessories

Modem Riser 99

ASUS PC Probe 83

ASUS Update 82

ATAPI CD-ROM 73

B

Bass Center Audio Jumper 20

BIOS

Advanced Menu 60

Beep Code 45

Boot Menu 73

Boot Sequence 73

Exit Menu 75

Language 59

Legend Bar 52

Main Menu 54

Menu Bar 52

Power Menu 70

Setup Defaults, loading 76

Setup Program 51

Smart BIOS 8

Sub-menu launching 53

Updating 47

BIOS Beep Codes 45

Boot Device

Selection 73

Boot Up NumLock Status 58

Boot Virus Detection 74

C

C-Media Audio Setup 88

Central Processing Unit 26

Central Processing Unit (CPU)

Level 1/Level 2 Cache 61

Speed 60

Upgrade/Reinstallation 62

Chassis Intrusion 42

Chip Configuration 63

Clear RTC RAM Jumper 22

Connectors

Audio 34

Chassis Fan 37

CPU Fan 37

Digital Audio 42

External 31

Floppy Disk Drive 35

Game/MIDI 34

Headphone Out 41

IDE 36

IDE Activity LED 35

Infrared 38

Internal Audio 40

Internal Line-in 41

Internal Microphone 40

Panel 44

Parallel Port 32

Power Supply Thermal Sensor 43

PS/2 Keyboard 31

PS/2 Mouse 31

Serial Port 33

SMBus 39

USB 32

CPU. *See* Central Processing Unit

CPU : DRAM Freq. Jumper 18

CyberLink

PowerPlayer SE 92

VideoLive Mail 93

D

DDR Voltage Setting 19

Digital Audio Interface 42

DIMM Memory 23

E

Expansion Cards

ACR 29

AGP 30

Assigning IRQs 28

Installing 27

INDEX

F

- Floppy 3 Mode 54
- Floppy Disk Drive Connector 35

G

- Glossary 95

H

- Hard Disk Drives (HDDs)
 - CHS Capacity 57
 - Cylinders 56
 - Heads 57
 - LBA Capacity 57
 - Primary/Secondary Master 55
 - Primary/Secondary Slave 55
 - Sectors 56
 - Translation Method 56
 - Types 55
- Hardware Monitor 72
- Hardware Setup
 - CPU Installation 26
 - Memory Installation 24
 - Procedure 16
- Headers
 - USB 37

I

- IDE Activity LED 35
- IDE Connectors 36
- IDE Hard Disks. *See* Hard Disk Drives (HDDs)
- Infrared Connector 38
- Installation
 - CPU 26
- Interrupt Request (IRQ)
 - Standard Assignments 28

J

- Jumperless Setting 18
- Jumpers
 - Bass Center Audio 20

- Clear RTC RAM 22
- CPU : DRAM Frequency 18
- DDR Voltage 19
- JEN Jumpers 18
- Network LAN 20
- Onboard Audio 21
- USB Device Wake-up 21
- Voltage Regulator 19

K

- Keyboard
 - Auto-Repeat Rate 58
 - Connector 31
 - Features 58
- Keyboard Lock Switch Lead 44

L

- LED indicators 17
- Legacy Diskette 54

M

- Memory Installation 24
- Modem Riser 99
- Motherboard
 - Components 12, 13
 - IRQ Table 29
 - Layout 14
 - Settings 17
 - Specifications 8, 9
- Mouse
 - Connector 31
- Multi-Channel Audio 88
- Multi-Sector Transfers 57

N

- Network LAN Jumper 20

O

- Onboard Audio Jumper 21
- Onboard System Indicator 17

INDEX

P

- Parallel Port 65
 - Modes 66
- Parallel Port Connector 32
- Password
 - If You Forget 59
 - Notes 59
 - Supervisor 59
 - User 59
- PC Probe 83
- PCI Configuration 67
- PCI Latency Timer 67
- PCI/VGA Palette Snoop 67
- PIO Mode 57
- Ports. *See* Connectors
- Power On Self Test 74
- PowerPlayer SE
 - Using 92
- Procedure
 - CPU Installation 26
 - Hardware Setup 16
 - Memory Installation 24
- Procedures
 - Modem Riser Installation 99
- PS/2 Keyboard 31
- PS/2 Keyboard Port 9
- PS/2 Mouse 31
 - Function Control 61
- PS/2 Mouse Port 9

R

- RTC RAM
 - Clearing 22

S

- SDRAM
 - Configuration 63
- Serial Ports 65
 - Connectors 33
- Serial ports 9

- SMART Monitoring 57
- SMBus Connector 39
- Starting Up 45
- System Chipset 8
- System Date 54
- System Time 54

T

- Thermal Sensor Connector 43

U

- UART2 65
- Ultra DMA Mode 57
- Universal Serial Bus (USB) 32
 - Headers 37
 - Ports 32
- USB Device Jumper 21
- USB Legacy Support 61
- USB ports 9
- Using
 - 3Deep Color Tuner 90
 - ASUS Update 82
 - Multi-Channel Audio Feature 88
 - PC Probe 83
 - PowerPlayer SE 92

V

- Video ROM BIOS Shadow 69
- VideoLive Mail 93
- Voltage Regulator Jumper 19

NOTES

Free Manuals Download Website

<http://myh66.com>

<http://usermanuals.us>

<http://www.somanuals.com>

<http://www.4manuals.cc>

<http://www.manual-lib.com>

<http://www.404manual.com>

<http://www.luxmanual.com>

<http://aubethermostatmanual.com>

Golf course search by state

<http://golfingnear.com>

Email search by domain

<http://emailbydomain.com>

Auto manuals search

<http://auto.somanuals.com>

TV manuals search

<http://tv.somanuals.com>