

**ASUS<sup>®</sup> MEB-VM**  
Socket 370 AGP Motherboard

**USER'S MANUAL**

# USER'S NOTICE

---

No part of this manual, including the products and software described in it, may be reproduced, transmitted, transcribed, stored in a retrieval system, or translated into any language in any form or by any means, except documentation kept by the purchaser for backup purposes, without the express written permission of ASUSTeK COMPUTER INC. ("ASUS").

ASUS PROVIDES THIS MANUAL "AS IS" WITHOUT WARRANTY OF ANY KIND, EITHER EXPRESS OR IMPLIED, INCLUDING BUT NOT LIMITED TO THE IMPLIED WARRANTIES OR CONDITIONS OF MERCHANTABILITY OR FITNESS FOR A PARTICULAR PURPOSE. IN NO EVENT SHALL ASUS, ITS DIRECTORS, OFFICERS, EMPLOYEES OR AGENTS BE LIABLE FOR ANY INDIRECT, SPECIAL, INCIDENTAL, OR CONSEQUENTIAL DAMAGES (INCLUDING DAMAGES FOR LOSS OF PROFITS, LOSS OF BUSINESS, LOSS OF USE OR DATA, INTERRUPTION OF BUSINESS AND THE LIKE), EVEN IF ASUS HAS BEEN ADVISED OF THE POSSIBILITY OF SUCH DAMAGES ARISING FROM ANY DEFECT OR ERROR IN THIS MANUAL OR PRODUCT.

Product warranty or service will not be extended if: (1) the product is repaired, modified or altered, unless such repair, modification or alteration is authorized in writing by ASUS; or (2) the serial number of the product is defaced or missing.

Products and corporate names appearing in this manual may or may not be registered trademarks or copyrights of their respective companies, and are used only for identification or explanation and to the owners' benefit, without intent to infringe.

- Intel, LANDesk, and Pentium are registered trademarks of Intel Corporation.
- IBM and OS/2 are registered trademarks of International Business Machines.
- Symbios is a registered trademark of Symbios Logic Corporation.
- Windows and MS-DOS are registered trademarks of Microsoft Corporation.
- XGstudio and Soft Synthesizer is a trademark of the Yamaha Corporation.
- Adobe and Acrobat are registered trademarks of Adobe Systems Incorporated.

The product name and revision number are both printed on the product itself. Manual revisions are released for each product design represented by the digit before and after the period of the manual revision number. Manual updates are represented by the third digit in the manual revision number.

For previous or updated manuals, BIOS, drivers, or product release information, contact ASUS at <http://www.asus.com.tw> or through any of the means indicated on the following page.

SPECIFICATIONS AND INFORMATION CONTAINED IN THIS MANUAL ARE FURNISHED FOR INFORMATIONAL USE ONLY, AND ARE SUBJECT TO CHANGE AT ANY TIME WITHOUT NOTICE, AND SHOULD NOT BE CONSTRUED AS A COMMITMENT BY ASUS. ASUS ASSUMES NO RESPONSIBILITY OR LIABILITY FOR ANY ERRORS OR INACCURACIES THAT MAY APPEAR IN THIS MANUAL, INCLUDING THE PRODUCTS AND SOFTWARE DESCRIBED IN IT.

**Copyright © 1998 ASUSTeK COMPUTER INC. All Rights Reserved.**

Product Name:	<b>ASUS MEB-VM</b>
Manual Revision:	<b>1.01 E325</b>
Release Date:	<b>January 1999</b>

# ASUS CONTACT INFORMATION

---

## ASUSTeK COMPUTER INC. (Asia-Pacific)

### *Marketing*

Address: 150 Li-Te Road, Peitou, Taipei, Taiwan 112  
Telephone: +886-2-2894-3447  
Fax: +886-2-2894-3449  
Email: info@asus.com.tw

### *Technical Support*

Tel (English): +886-2-2894-3447 ext. 706  
Tel (Chinese): +886-2-2894-3447 ext. 701  
Fax: +886-2-2895-9254  
Email: tsd@asus.com.tw  
Newsgroup: news2.asus.com.tw  
WWW: www.asus.com.tw  
FTP: ftp.asus.com.tw/pub/ASUS

## ASUS COMPUTER INTERNATIONAL (America)

### *Marketing*

Address: 6737 Mowry Avenue, Mowry Business Center, Building 2  
Newark, CA 94560, USA  
Fax: +1-510-608-4555  
Email: info-usa@asus.com.tw

### *Technical Support*

Fax: +1-510-608-4555  
BBS: +1-510-739-3774  
Email: tsd-usa@asus.com.tw  
WWW: www.asus.com  
FTP: ftp.asus.com.tw/pub/ASUS

## ASUS COMPUTER GmbH (Europe)

### *Marketing*

Address: Harkort Str. 25, 40880 Ratingen, BRD, Germany  
Telephone: 49-2102-445011  
Fax: 49-2102-442066  
Email: info-ger@asus.com.tw

### *Technical Support*

Hotline: 49-2102-499712  
BBS: 49-2102-448690  
Email: tsd-ger@asus.com.tw  
WWW: www.asuscom.de  
FTP: ftp.asuscom.de/pub/ASUSCOM

# CONTENTS

---

<b>I. INTRODUCTION .....</b>	<b>7</b>
How this manual is organized .....	7
Item Checklist .....	7
<b>II. FEATURES .....</b>	<b>8</b>
The ASUS MEB-VM Motherboard .....	8
Introduction to ASUS Smart Series Motherboards .....	9
Parts of the ASUS MEB-VM Motherboard .....	11
<b>III. HARDWARE SETUP .....</b>	<b>12</b>
ASUS MEB-VM Motherboard Layout .....	12
1. Jumpers .....	14
HARDWARE SETUP Steps .....	14
2. System Memory (DIMM) .....	17
SPD Support .....	17
DIMM Memory Installation .....	18
3. Central Processing Unit (CPU) .....	19
4. Expansion Cards .....	20
Expansion Card Installation Procedure: .....	20
Assigning IRQs for Expansion Cards .....	20
Assigning DMA Channels for ISA Cards .....	21
5. External Connectors .....	22
Power Connection Procedures .....	33
Flash Memory Writer Utility .....	34
<b>IV. BIOS SETUP .....</b>	<b>34</b>
Main Menu .....	34
Managing and Updating Your Motherboard's BIOS .....	36
6. BIOS Setup .....	37
Load Defaults .....	38
Standard CMOS Setup .....	38
Details of Standard CMOS Setup: .....	38
BIOS Features Setup .....	41
Details of BIOS Features Setup .....	41
Chipset Features Setup .....	44
Details of Chipset Features Setup .....	44
Power Management Setup .....	47
Details of Power Management Setup .....	47
PNP and PCI Setup .....	50
Details of PNP and PCI Setup .....	50
Load BIOS Defaults .....	52
Load Setup Defaults .....	52

# CONTENTS

---

Supervisor Password and User Password .....	53
IDE HDD Auto Detection .....	54
Save & Exit Setup .....	55
Exit Without Saving .....	55
<b>V. Software Setup .....</b>	<b>57</b>
<b>VI. Software Reference .....</b>	<b>67</b>
<b>Appendix .....</b>	<b>81</b>

# FCC & DOC COMPLIANCE

---

## ***Federal Communications Commission Statement***

This device complies with FCC Rules Part 15. Operation is subject to the following two conditions:

- This device may not cause harmful interference, and
- This device must accept any interference received, including interference that may cause undesired operation.

This equipment has been tested and found to comply with the limits for a Class B digital device, pursuant to Part 15 of the FCC Rules. These limits are designed to provide reasonable protection against harmful interference in a residential installation. This equipment generates, uses and can radiate radio frequency energy and, if not installed and used in accordance with manufacturer's instructions, may cause harmful interference to radio communications. However, there is no guarantee that interference will not occur in a particular installation. If this equipment does cause harmful interference to radio or television reception, which can be determined by turning the equipment off and on, the user is encouraged to try to correct the interference by one or more of the following measures:

- Re-orient or relocate the receiving antenna.
- Increase the separation between the equipment and receiver.
- Connect the equipment to an outlet on a circuit different from that to which the receiver is connected.
- Consult the dealer or an experienced radio/TV technician for help.

**WARNING!** Be sure that there is sufficient air circulation across the processor's heatsink by regularly checking that your CPU fan is working. Without sufficient circulation, the processor could overheat and damage both the processor and the motherboard. You may install an auxiliary fan, if necessary.

## ***Canadian Department of Communications Statement***

This digital apparatus does not exceed the Class B limits for radio noise emissions from digital apparatus set out in the Radio Interference Regulations of the Canadian Department of Communications.

# I. INTRODUCTION

---

## How this manual is organized

This manual is divided into the following sections:

- |                               |   |
|-------------------------------|---|
| <b>I. Introduction</b>        | Manual information and checklist                        |
| <b>II. Features</b>           | Information and specifications concerning this product  |
| <b>III. Hardware Setup</b>    | Instructions on setting up the motherboard              |
| <b>IV. BIOS Setup</b>         | Instructions on setting up the BIOS software            |
| <b>V. Software Setup</b>      | Information on setting up the included support software |
| <b>VI. Software Reference</b> | Reference material for the included support software    |

## Item Checklist

Check that your package is complete. If you discover damaged or missing items, please contact your retailer.

- (1) ASUS Motherboard
- (1) IDE ribbon cable for master and slave drives
- (1) Floppy ribbon cable for (1) 5.25" floppy and (2) 3.5" floppies
- (1) COM2 connector with bracket
- (1) Bag of spare jumper caps
- (1) Support CD with drivers and utilities
- (1) This Motherboard User's Manual
  
- ASUS PC100-compliant SDRAM (optional)
- IrDA-compliant infrared module (optional)
- ASUS PCI-L101 Wake-On-LAN 10/100 Fast Ethernet Card (optional)

## II. FEATURES

---

### The ASUS MEB-VM Motherboard

The ASUS MEB-VM motherboard is carefully designed for the demanding PC user who wants many intelligent features in a small package.

- **Intel Processor Support:** Supports Intel's Celeron processor designed for the Socket 370 and packaged in a Plastic Pin Grid Array (PPGA).
- **Intel AGPset:** Features Intel's 440BX AGPset with I/O subsystems and front side bus (FSB) platform which boosts the traditional 66MHz internal bus speed to 100MHz.
- **AGP 3D AGP VGA:** Features onboard ATI 3D Rage Pro AGP 2X (8MB SDRAM) or Rage IIC AGP (4MB SDRAM) for 3D hardware acceleration.
- **Onboard Audio (optional):** Provides Creative ES1373 PCI audio chipset with 3D surround and positioning capability. Includes complete online help to guide you through the audio software.
- **Audio Codec (optional):** Features an 18-bit stereo, full duplex, audio codec that conforms to AC'97 analog component specifications.
- **Enhanced ACPI & Anti-Boot Virus BIOS:** Programmable BIOS (Flash EEPROM), offering enhanced ACPI for Windows 98 compatibility, built-in hardware-based virus protection, and autodetection of most devices for virtually automatic setup.
- **Versatile Memory:** Equipped with two DIMM sockets to support Intel PC100-compliant SDRAMs (8, 16, 32, 64, 128, or 256MB) up to 512MB.
- **AGP Slot:** Supports an Accelerated Graphics Port card for high performance, component level interconnect targeted at 3D graphical display applications using a 66MHz bus.
- **PCI & ISA Expansion:** Provides two 32-bit PCI expansion slots and one 16-bit ISA expansion slot .
- **Wake-On-LAN Header:** Supports Wake-On-LAN activity through an optional ASUS PCI-L101 Fast Ethernet card or a similar ethernet card.
- **SB-Link™:** Features Creative's SB-Link™, allowing SB16 compatibility using Intel's PC-PCI and serialized IRQ protocols to AWE64D or compatible PCI audio cards.
- **Super Multi-I/O:** Provides two high-speed UART compatible serial ports and one parallel port with EPP and ECP capabilities.
- **Desktop Management Interface (DMI):** Supports DMI through BIOS, which allows hardware to communicate within a standard protocol creating a higher level of compatibility. (Requires DMI-enabled components.)
- **Ultra DMA/33 BM IDE:** Comes with an onboard PCI Bus Master IDE controller with two connectors that support four IDE devices in two channels, supports Ultra DMA/33, PIO Modes 3 and 4 and Bus Master IDE DMA Mode 2, and supports Enhanced IDE devices, such as Tape Backup, CD-ROM, and LS-120 drives.
- **Easy Installation:** Equipped with BIOS that supports autodetection of hard drives, PS/2 mouse, and Plug and Play devices to make setup of hard drives, expansion cards, and other devices virtually automatic.
- **IrDA:** Supports an optional infrared port module for wireless interface.



## II. FEATURES

---

### *Introduction to ASUS Smart Series Motherboards*

#### **Performance**

- **ACPI Ready:** ACPI (Advanced Configuration and Power Interface) is also implemented on all ASUS smart series motherboards. ACPI provides more Energy Saving Features for future operating systems (OS) supporting OS Direct Power Management (OSPM) functionality. With these features implemented in the OS, PCs can be ready around the clock, yet satisfy all the energy saving standards. To fully utilize the benefits of ACPI, an ACPI-supported OS such as the successor of Windows 95 must be used.
- **Double the IDE Transfer Speed:** IDE transfers using UltraDMA/33 Bus Master IDE can handle rates up to 33MB/sec. The best of all is that this new technology is compatible with existing ATA-2 IDE specifications so there is no need to upgrade current hard drives or cables.
- **Concurrent PCI:** Concurrent PCI allows multiple PCI transfers from PCI master buses to memory to CPU.
- **PC'98 Compliant:** Both the BIOS and hardware levels of the motherboard meet PC'98 compliancy. The new PC'98 requirements for systems and components are based on the following high-level goals: Support for Plug and Play compatibility and power management for configuring and managing all system components, and 32-bit device drivers and setup procedures for Windows 95/98/NT.
- **SDRAM Optimized Performance:** ASUS smart series motherboards support the new generation memory, Synchronous Dynamic Random Access Memory (SDRAM), which increases the data transfer rate from 264MB/s max using EDO memory to 528MB/s max using SDRAM.

## II. FEATURES

---

### Power Management

- **System Resources Alert:** Today's operating systems such as Windows 95, Windows NT, and OS/2, require much more memory and hard drive space to present enormous user interfaces and run large applications. The system resource monitor will warn the user before the system resources are used up to prevent possible application crashes. Suggestions will give the user information on managing their limited resources more efficiently.
- **Auto Fan Off:** The system fans will power off automatically **even in sleep mode**. This function reduces both energy consumption *and* **system noise**, and is a important feature to implement silent PC systems.
- **Dual Function Power Button:** The system can be in one of two states, one is Sleep mode and the other is the Soft-Off mode. Pushing the power button for less than 4 seconds places the system into Sleep mode. When the power button is pressed for more than 4 seconds, it enters the Soft-Off mode.
- **Remote Ring On (requires modem):** This allows a computer to be turned on remotely through an internal or external modem. With this benefit on-hand, any user can access vital information from their computer from anywhere in the world!
- **Message LED (requires ACPI OS support):** Chassis LEDs now act as information providers. Through the way a particular LED illuminates, the user can determine the stage the computer is in. A simple glimpse provides useful information to the user.

# II. FEATURES

## Parts of the ASUS MEB-VM Motherboard

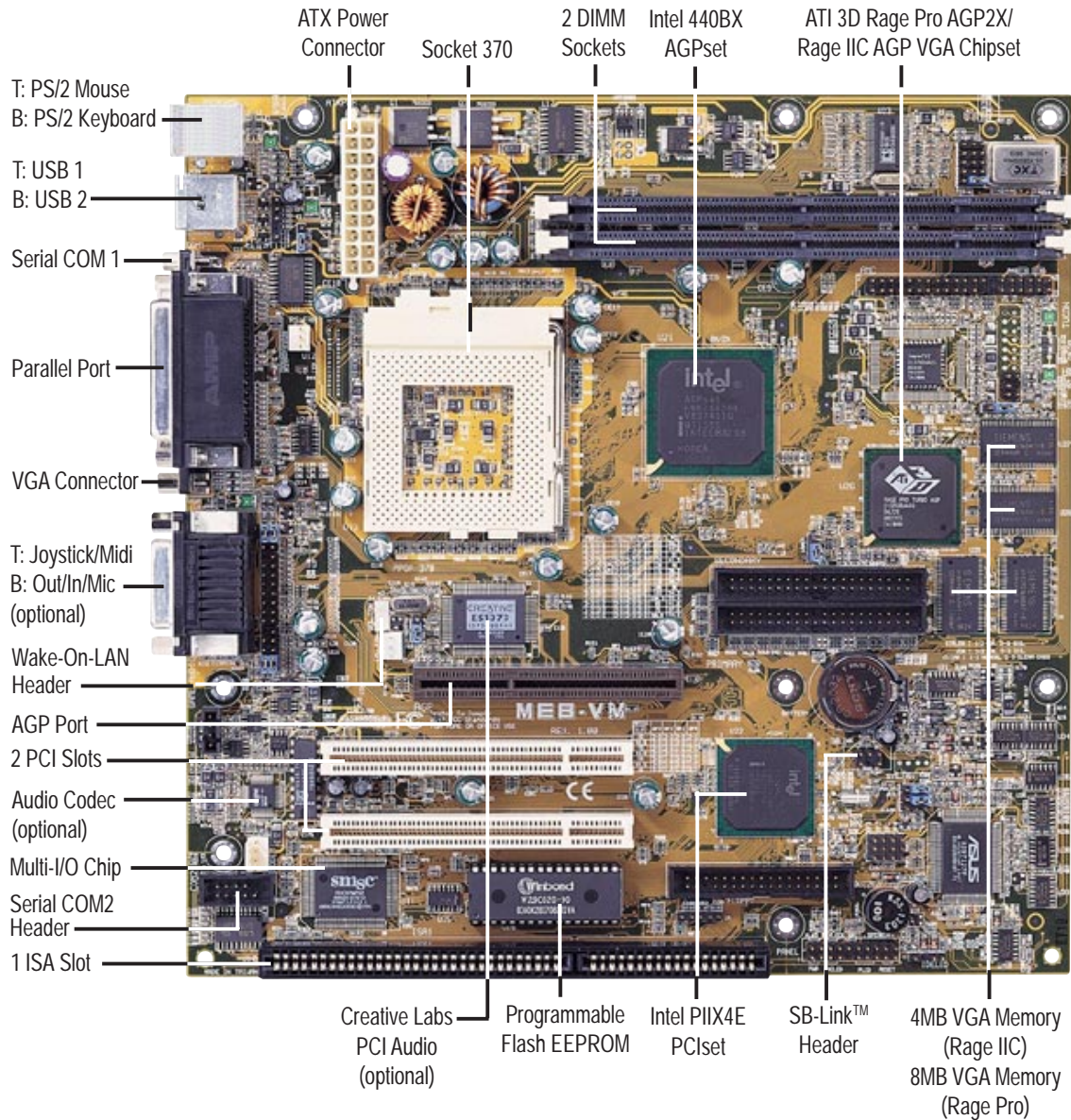

**II. FEATURES**  
Motherboard Parts

# III. HARDWARE SETUP

## ASUS MEB-VM Motherboard Layout

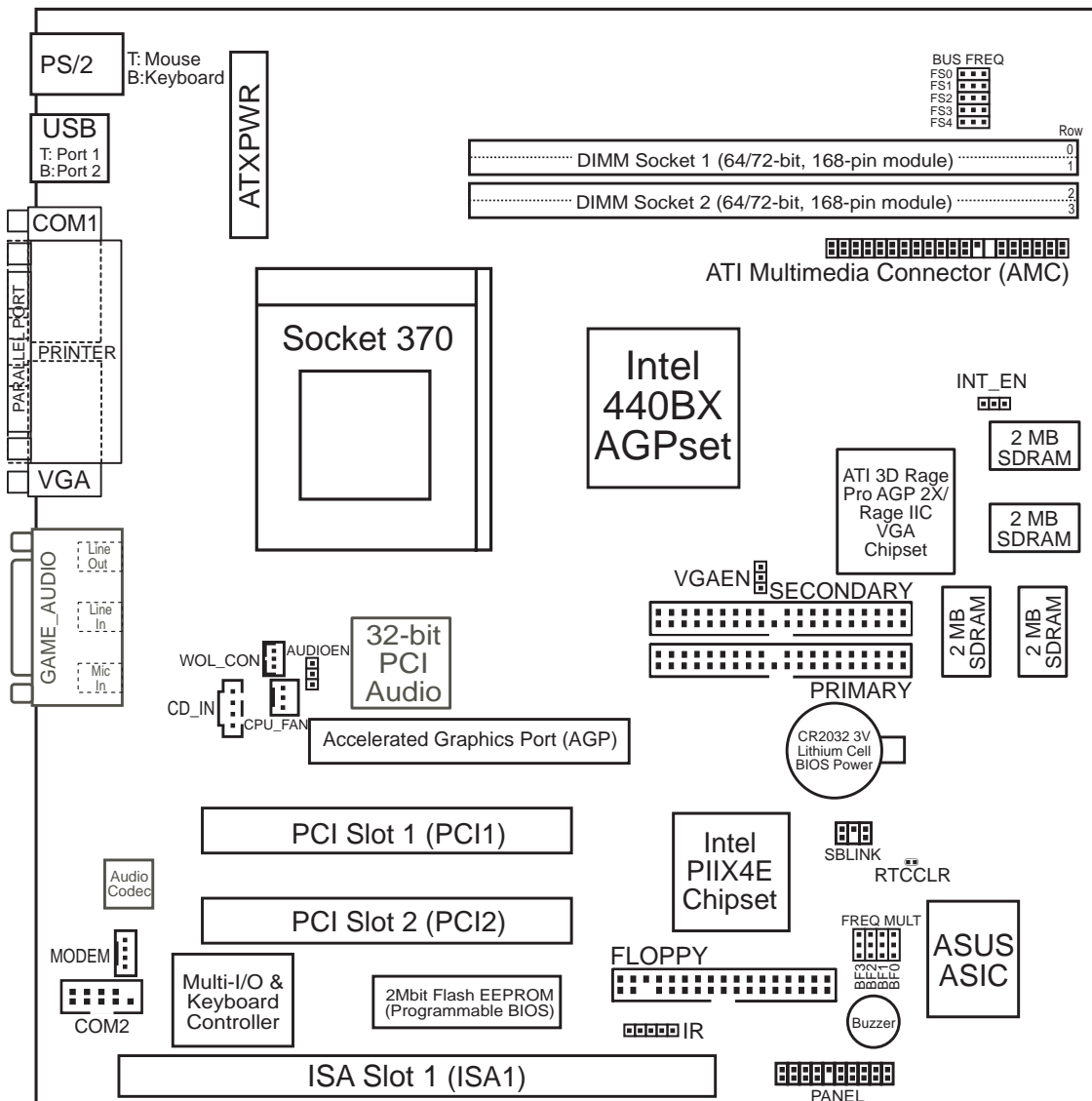

(Grayed items are optional at the time of purchase.)

# III. HARDWARE SETUP

---

## Jumpers

- |                            |  |
|----------------------------|--|
| 1) INT_EN                  | p. 15 VGA Interrupt Setting (Enable/Disable)       |
| 2) VGAEN                   | p. 15 VGA Setting (Enable/Disable)                 |
| 3) AUDIOEN                 | p. 15 Audio Setting (Enable/Disable)               |
| 4) FS0, FS1, FS2, FS3, FS4 | p. 16 CPU External Clock (BUS) Frequency Selection |
| 5) BF0, BF1, BF2, BF3      | p. 16 CPU:BUS Frequency Multiple                   |

## Expansion Slots

- |                 |   |
|-----------------|---|
| 1) DIMM1, DIMM2 | p. 17 168-Pin DIMM Memory Support           |
| 2) Socket 370   | p. 19 Central Processing Unit (CPU) Support |
| 3) PCI1, PCI2   | p. 20 32-bit PCI Bus Expansion Slots        |
| 4) ISA1         | p. 20 16-bit ISA Bus Expansion Slot         |

## Connectors

- |                          |  |
|--------------------------|--|
| 1) PS2KBMS               | P. 22 PS/2 Mouse Connector (6-pin female)                  |
| 2) PS2KBMS               | p. 22 PS/2 Keyboard Connector (6-pin female)               |
| 3) USB                   | p. 23 Universal Serial BUS Ports 1 & 2 (Two 4-pin female)  |
| 4) PRINTER               | p. 23 Parallel Port Connector (25-pin female)              |
| 5) COM1                  | p. 23 Serial Port COM1 Connector (9-pin male)              |
| 6) VGA                   | p. 24 Monitor (VGA) Output Connector (15-pin female)       |
| 7) GAME_AUDIO (optional) | p. 24 Joystick/Midi Connector (15-pin female) (optional)   |
| 8) GAME_AUDIO (optional) | p. 24 Audio Port Connectors (Three 1/8" female) (optional) |
| 9) PRIMARY/SECONDARY IDE | p. 25 Primary/Secondary IDE Connectors (Two 40-1pins)      |
| 10) FLOPPY               | p. 25 Floppy Disk Drive Connector (34-1pins)               |
| 11) IR                   | p. 26 IrDA-Compliant Infrared Module Connector (5 pins)    |
| 12) WOL_CON              | p. 26 Wake-On-LAN Connector (3 pins)                       |
| 13) SBLINK               | p. 27 SB-Link™ Connector (6-1 pins)                        |
| 14) CD_IN                | p. 27 Stereo Audio In Connector (4 pins)                   |
| 15) MODEM                | p. 28 Modem In Audio Connector (4 pins)                    |
| 16) COM2                 | p. 28 Serial Port COM2 Header (10-1 pins)                  |
| 17) AMC                  | p. 29 ATI Multimedia Channel (40-3 pins)                   |
| 18) CPU_FAN              | p. 29 CPU Fan Connector (3 pins)                           |
| 19) MLED (PANEL)         | p. 30 System Message LED (2 pins)                          |
| 20) KEYLOCK (PANEL)      | p. 30 Keyboard Lock Switch Lead (2 pins)                   |
| 21) SMI (PANEL)          | p. 30 SMI Switch Lead (2 pins)                             |
| 22) SPEAKER (PANEL)      | p. 30 System Warning Speaker Connector (4 pins)            |
| 23) PWR (PANEL)          | p. 30 ATX Power & Soft-Off Switch Lead (2 pins)            |
| 24) IDELED (PANEL)       | p. 30 IDE Activity LED (2 pins)                            |
| 25) PLED (PANEL)         | p. 31 System Power LED Lead (3-1 pins)                     |
| 26) RESET (PANEL)        | p. 31 Reset Switch Lead (2 pins)                           |
| 27) ATXPWR               | p. 32 ATX Power Supply Connector (20 pins)                 |

# III. HARDWARE SETUP

---

## Hardware Setup Steps

Before using your computer, you must complete the following steps:

1. **Set Jumpers on the Motherboard**
2. **Install System Memory Modules**
3. **Install the Central Processing Unit (CPU)**
4. **Install Expansion Cards**
5. **Connect Ribbon Cables, Cabinet Wires, and Power Supply**
6. **Setup the BIOS Software**

**WARNING!** Computer motherboards, baseboards and components, such as SCSI cards, contain very delicate Integrated Circuit (IC) chips. To protect them against damage from static electricity, you should follow some precautions whenever you work on your computer.

1. Unplug your computer when working on the inside.
2. Use a grounded wrist strap before handling computer components. If you do not have one, touch both of your hands to a safely grounded object or to a metal object, such as the power supply case.
3. Hold components by the edges and try not to touch the IC chips, leads or connectors, or other components.
4. Place components on a grounded antistatic pad or on the bag that came with the component whenever the components are separated from the system.

# III. HARDWARE SETUP

---

## 1. Jumpers

### 1. VGA Interrupt Selection (INT\_EN) / 2. VGA Setting (VGAEN)

INT\_EN allows you to set the VGA interrupt method. The default disables the chipset's internal interrupt routing. Some TV tuners or MPEG cards may require the interrupt be assigned by the onboard chipset, in which case INT\_EN must be enabled. VGAEN allows you to enable or disable the onboard VGA. Disable the onboard VGA if you are using a VGA card on the expansion slot.

### 3. Audio Setting (AUDIOEN)

The onboard 32-bit PCI audio may be enabled or disabled using this jumper.

<b>Setting</b>	<b>AUDIOEN</b>
Enable	[1-2] (default)
Disable	[2-3]

# III. HARDWARE SETUP

## 4. CPU Bus Frequency Selector (FS0, FS1, FS2, FS3, FS4)

This option tells the clock generator what frequency to send to the CPU, DRAM, and 440BX AGPset. This allows the selection of the CPU's *External* frequency (or *BUS Clock*). The BUS Clock multiplied by the BUS Ratio equals the CPU's *Internal* frequency (the advertised CPU speed).

## 5. CPU Core:BUS Frequency Multiple (BF0, BF1, BF2, BF3)

This option sets the frequency multiple between the *Internal* frequency of the CPU and the CPU's *External* frequency. These must be set in conjunction with the *CPU Bus Frequency*.

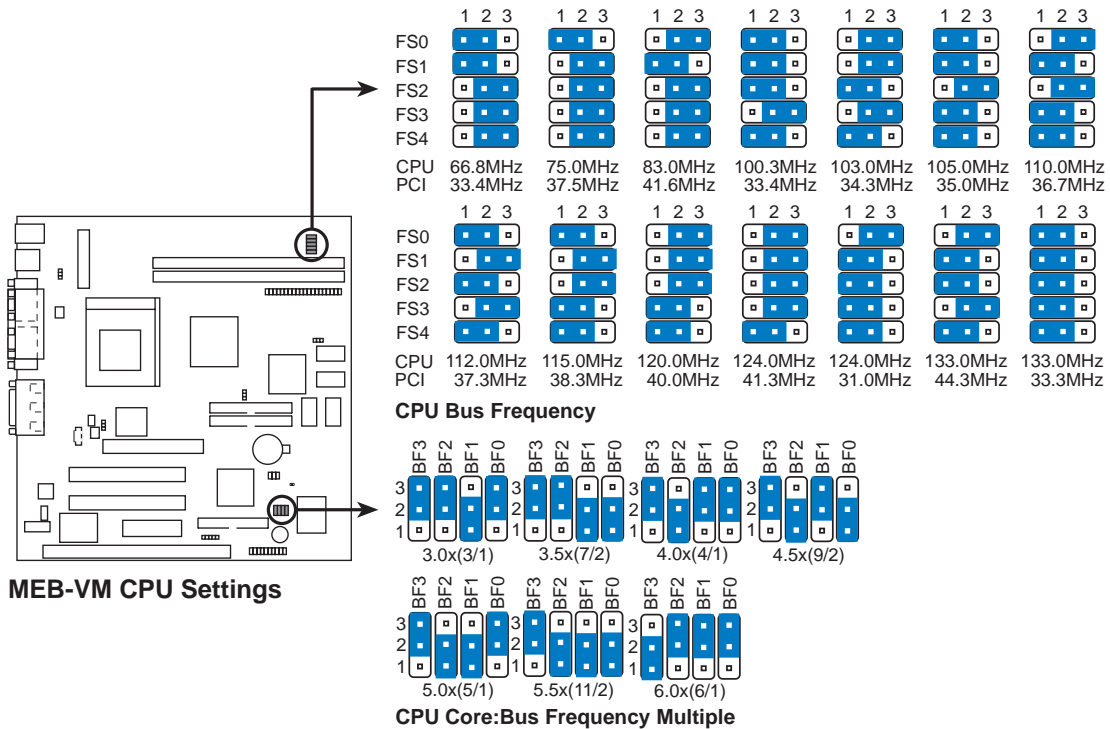

**WARNING!** Frequencies above 100MHz exceed the specifications for the on-board Intel Chipset and are not guaranteed to be stable. PCI frequencies above 33MHz exceed the specifications for PCI cards and are not guaranteed to be stable.

Set the jumpers by the Internal speed of your processor as follows:

Intel CPU Model	Freq.	Ratio	BUS F.	(CPU BUS Freq.)					(Freq. Multiple)			
				FS0	FS1	FS2	FS3	FS4	BF3	BF2	BF1	BF0
Celeron (PPGA)	366MHz	5.5x	66MHz	[1-2]	[1-2]	[2-3]	[2-3]	[2-3]	[2-3]	[1-2]	[1-2]	[1-2]
Celeron (PPGA)	333MHz	5.0x	66MHz	[1-2]	[1-2]	[2-3]	[2-3]	[2-3]	[2-3]	[1-2]	[1-2]	[2-3]
Celeron (PPGA)	300MHz	4.5x	66MHz	[1-2]	[1-2]	[2-3]	[2-3]	[2-3]	[2-3]	[1-2]	[2-3]	[1-2]

**NOTES:** Overclocking your processor is not recommended. It may result in a slower speed. Voltage Regulator Output Selection (VID) is not needed for the Pentium II/Celeron processor because it sends a VID signal directly to the onboard power controller.



# III. HARDWARE SETUP

## 2. System Memory (DIMM)

**NOTE:** No hardware or BIOS setup is required after adding or removing memory.

This motherboard uses only Dual Inline Memory Modules (DIMMs). Sockets are available for **3.3Volt** (power level) unbuffered Synchronous Dynamic Random Access Memory (SDRAM) of either 8, 16, 32, 64, 128MB, or 256MB. One side (with memory chips) of the DIMM takes up one row on the motherboard.

The Intel 440BX AGPset does not support ECC function. ECC memory modules may be used but the ECC function will not be available.

Memory speed setup is recommended through *SDRAM Configuration* under “Chipset Features Setup” in BIOS SETUP.

*Install memory in any combination as follows:*

DIMM Location	168-pin DIMM Memory Modules		Total Memory
Socket 1 (Rows 0&1)	SDRAM 8, 16, 32, 64, 128, 256MB	x1	
Socket 2 (Rows 2&3)	SDRAM 8, 16, 32, 64, 128, 256MB	x1	
	Total System Memory (Max 512MB)	=	

### *SPD Support*

This motherboard supports SPD DIMMs. If non-SPD DIMMs are used, you will be warned during boot-up to set the timings manually.

### **General DIMM Notes**

- **For the system CPU bus to operate above 100MHz, use only PC100-compliant DIMMs.** When this motherboard operates at 100MHz, most system will not even boot if non-compliant modules are used because of the strict timing issues involved under this speed. If your DIMMs are not PC100-compliant, set the CPU bus frequency to 66MHz for system stability.
- Two possible memory chips are supported: SDRAM with and without ECC.
- SDRAM chips are generally thinner with higher pin density than EDO (Extended Data Output) chips.
- BIOS shows SDRAM memory on bootup screen.
- 8 chips/side modules do not support ECC, only 9 chips/side modules support ECC.
- Single-sided DIMMs come in 16, 32, 64,128MB; double-sided come in 32, 64, 128, 256MB.

# III. HARDWARE SETUP

## *DIMM Memory Installation*

Insert the module(s) as shown. Because the number of pins are different on either side of the breaks, the module will only fit in the orientation as shown. DIMM modules are longer and have different pin contact on each side and therefore have a higher pin density. SIMM modules have the same pin contact on both sides.

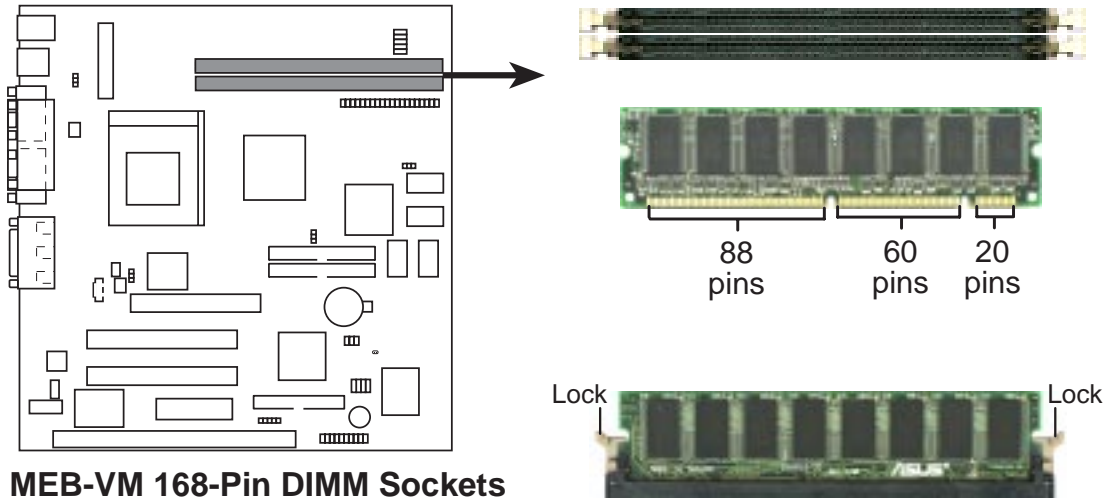

**MEB-VM 168-Pin DIMM Sockets**

The DIMMs must be **3.3V Unbuffered** for this motherboard. To determine the DIMM type, check the notches on the DIMMs (see figure below).

### 168-Pin DIMM Notch Key Definitions (3.3V)

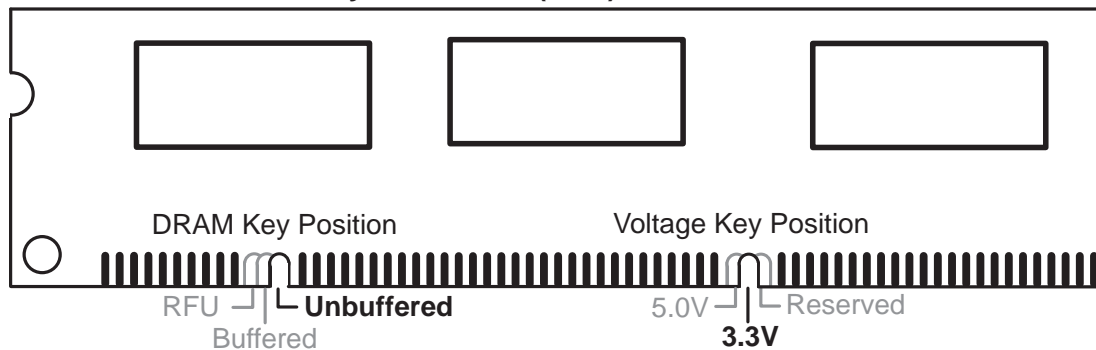

The notches on the DIMM module will shift between left, center, or right to identify the type and also to prevent the wrong type from being inserted into the DIMM slot on the motherboard. You must tell your retailer the correct DIMM type before purchasing. This motherboard supports four clock signals.

# III. HARDWARE SETUP

## 3. Central Processing Unit (CPU)

The motherboard provides a ZIF Socket 370. The CPU that came with the motherboard should have a fan attached to it to prevent overheating. If this is not the case then purchase a fan before you turn on your system.

**WARNING!** Without a fan circulating air on the CPU, the CPU can overheat and cause damage to both the CPU and the motherboard.

To install a CPU, first turn off your system and remove its cover. Locate the ZIF socket and open it by first pulling the lever sideways away from the socket then upwards to a 90-degree right angle. Insert the CPU with the correct orientation as shown. The notched corner should point towards the end the of the lever. Because the CPU has a corner pin for two of the four corners, the CPU will only fit in the one orientation as shown. The picture is for reference only; you should have a CPU fan that will cover the face of the CPU. With the added weight of the CPU fan, no force is required to insert the CPU. Once completely inserted, close the socket's lever while holding down the CPU.

**NOTE:** Set the bus frequency and multiple for your Socket 370 processor.

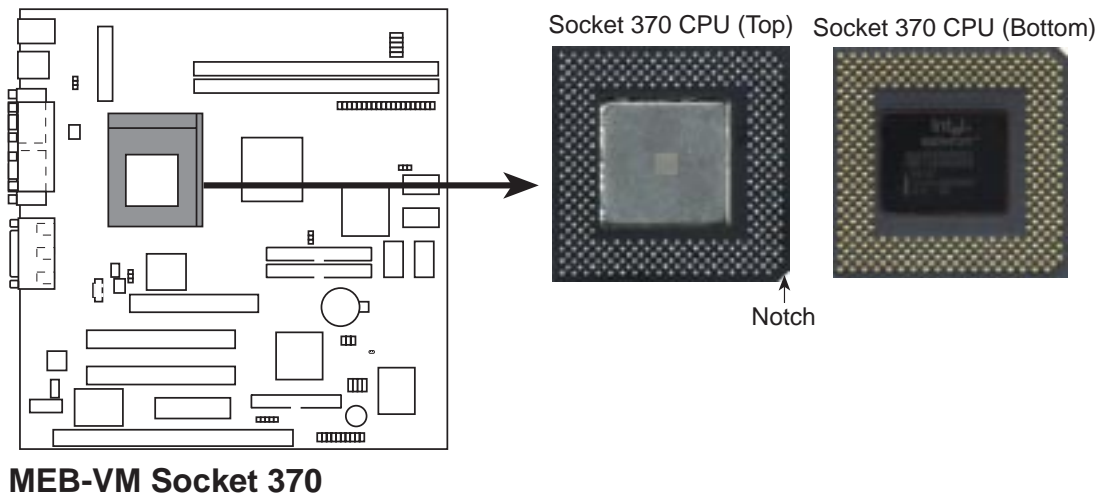

# III. HARDWARE SETUP

---

## 4. Expansion Cards

**WARNING!** Make sure that you unplug your power supply when adding or removing expansion cards or other system components. Failure to do so may cause severe damage to both your motherboard and expansion cards.

### *Expansion Card Installation Procedure:*

1. Read your expansion card documentation on any hardware and software settings that may be required to setup your specific card.
2. Set any necessary jumpers on your expansion card.
3. Remove your computer system's cover.
4. Remove the bracket on the slot you intend to use.  
Keep the bracket for possible future use.
5. Carefully align the card's connectors and press firmly.
6. Secure the card on the slot with the screw you removed in step 4.
7. Replace the computer system's cover.
8. Setup the BIOS if necessary
9. Install the necessary software drivers for your expansion card.

### *Assigning IRQs for Expansion Cards*

Some expansion cards need to use an IRQ (Interrupt Request) to operate. Generally an IRQ must be exclusively assigned to one use. In a standard design there are 16 IRQs available but most of them are already in use by parts of the system which leaves 6 free for expansion cards. If your motherboard has PCI audio onboard, an extra IRQ will be used, leaving 5 IRQs free. If your motherboard has ISA audio onboard, an extra 3 IRQs will be used, leaving 3 IRQs free.

Both ISA and PCI expansion cards may need to use IRQs. System IRQs are available to cards installed in the ISA expansion bus first, and any remaining IRQs are then used by PCI cards. Currently, there are two types of ISA cards.

The original ISA expansion card design, now referred to as "Legacy" ISA cards, requires that you configure the card's jumpers manually and then install it in any available slot on the ISA bus. You may use Microsoft's Diagnostic (MSD.EXE) utility included in the Windows directory to see a map of your used and free IRQs. For Windows 95/98 users, the "Control Panel" icon in "My Computer," contains a "System" icon, which gives you a "Device Manager" tab. Double-clicking on a specific device give you "Resources" tab which shows the Interrupt number and address. Make sure that no two devices use the same IRQs or your computer will experience problems when those two devices are in use at the same time.

# III. HARDWARE SETUP

To simplify this process, this motherboard complies with the Plug and Play (PNP) specification which was developed to allow automatic system configuration whenever a PNP-compliant card is added to the system. For PNP cards, IRQs are assigned automatically from those available.

If the system has both Legacy and PNP ISA cards installed, IRQs are assigned to PNP cards from those not used by Legacy cards. The PCI and PNP configuration of the BIOS setup utility can be used to indicate which IRQs are being used by Legacy cards. For older Legacy cards that do not work with the BIOS, you can contact your vendor for an ISA Configuration Utility.

An IRQ number is automatically assigned to PCI expansion cards after those used by Legacy and PNP ISA cards. In the PCI bus design, the BIOS automatically assigns an IRQ to a PCI slot that has a card in it that requires an IRQ. To install a PCI card, you need to set something called the INT (interrupt) assignment. Since all the PCI slots on this motherboard use an INTA #, be sure that the jumpers on your PCI cards are set to INT A.

## Assigning DMA Channels for ISA Cards

Some ISA cards, both legacy and PnP, may also need to use a DMA (Direct Memory Access) channel. DMA assignments for this motherboard are handled the same way as the IRQ assignment process described earlier. You can select a DMA channel in the PCI and PnP configuration section of the BIOS Setup utility.

**IMPORTANT:** To avoid conflicts, reserve the necessary IRQs and DMAs for legacy ISA cards (under PNP AND PCI SETUP of the BIOS SOFTWARE, choose *Yes* in *IRQ xx Used By ISA* and *DMA x Used By ISA* for those IRQs and DMAs you want to reserve).

## Accelerated Graphics Port

This motherboard provides an accelerated graphics port (AGP) slot to support a new generation of graphics cards with ultra-high memory bandwidth, such as an ASUS 3D hardware accelerator.

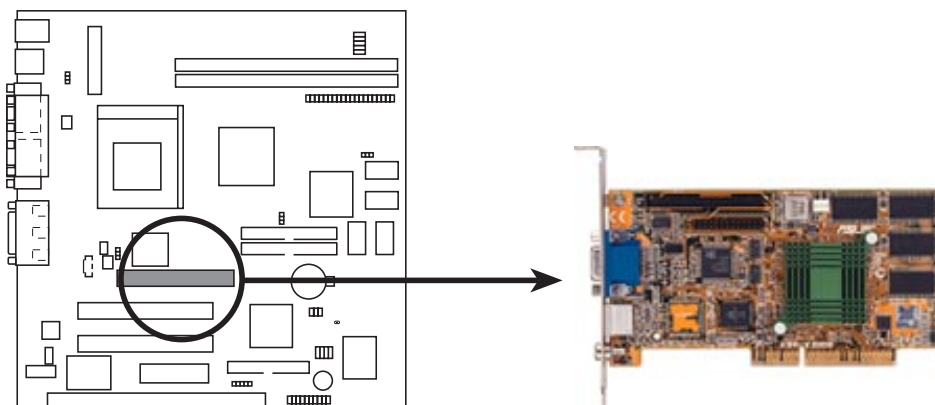

**MEB-VM Accelerated Graphics Port (AGP)**

# III. HARDWARE SETUP

## 5. External Connectors

**WARNING!** Some pins are used for connectors or power sources. These are clearly separated from jumpers in “Motherboard Layout.” Placing jumper caps over these will cause damage to your motherboard.

**IMPORTANT:** Ribbon cables should always be connected with the red stripe on the Pin 1 side of the connector. The four corners of the connectors are labeled on the motherboard. Pin 1 is the side closest to the power connector on hard drives and some floppy drives. IDE ribbon cable must be less than 18 inches (46 cm), with the second drive connector no more than 6 inches (15 cm) from the first connector.

### 1. PS/2 Mouse Connector (6-pin PS2KBMS)

The system will direct IRQ12 to the PS/2 mouse if one is detected. If not detected, expansion cards can use IRQ12. See “PS/2 Mouse Control” in *BIOS Features Setup* of BIOS SETUP.

PS/2 Mouse (6-pin Female)

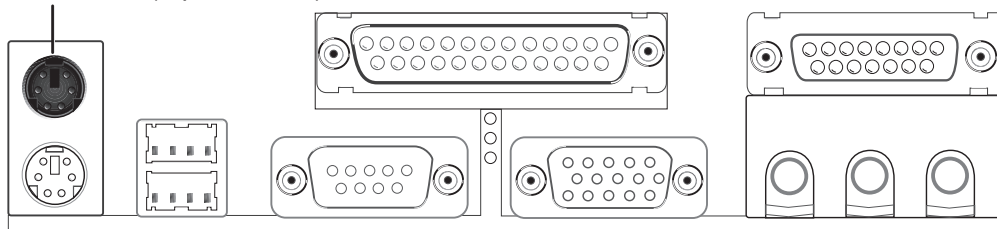

### 2. PS/2 Keyboard Connector (6-pin PS2KBMS)

This connection is for a standard keyboard using a PS/2 plug (mini DIN). **This connector will not allow standard AT size (large DIN) keyboard plugs. You may use a DIN to mini DIN adapter on standard AT keyboards.**

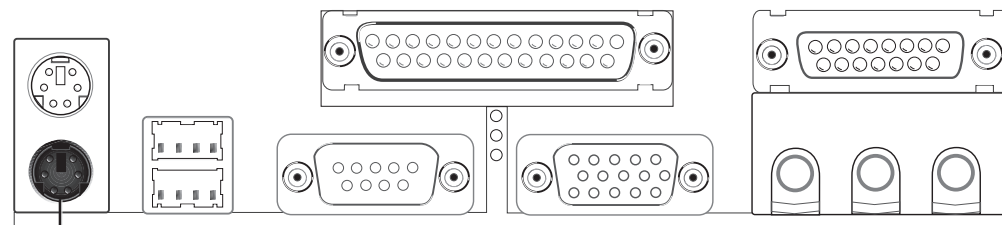

PS/2 Keyboard (6-pin Female)

# III. HARDWARE SETUP

## 3. Universal Serial BUS Ports 1 & 2 (Two 4-pin USB)

Two USB ports are available for connecting USB devices.

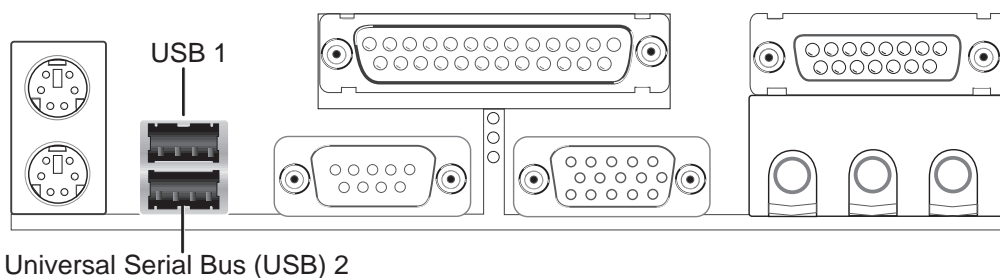

## 4. Parallel Port Connector (25-pin PRINTER)

You can enable the parallel port and choose the IRQ through “Onboard Parallel Port” in *Chipset Features Setup* of BIOS SETUP.

**NOTE:** Serial printers must be connected to the serial port.

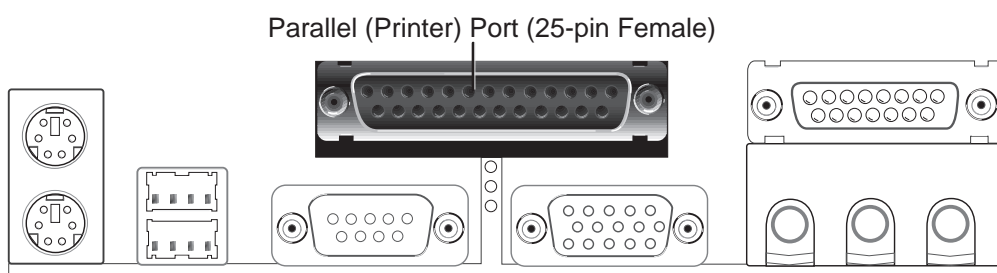

## 5. Serial Port COM1 Connector (9-pin COM1)

One serial port is ready for a mouse or other serial devices. A second serial port is available using a serial port bracket connected from the motherboard to an expansion slot opening. See “Onboard Serial Port” in *Chipset Features Setup* of BIOS SETUP for settings.

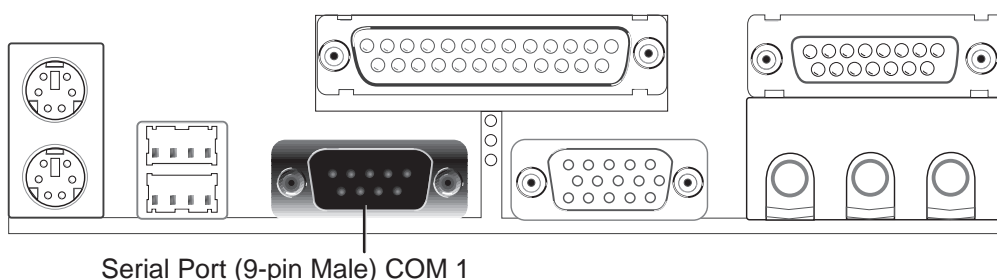

# III. HARDWARE SETUP

## 6. Monitor Output Connector (15-pin VGA)

This connector is for output to a VGA-compatible device.

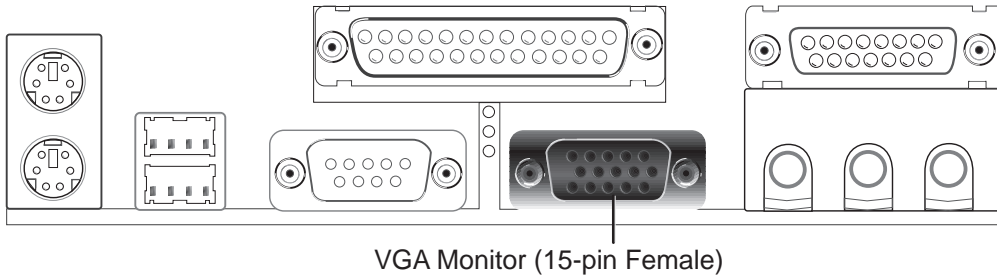

## 7. Joystick/MIDI Connector (15-pin GAME\_AUDIO)

You may connect game joysticks or game pads to this connector for playing games. Connect MIDI devices for playing or editing audio.

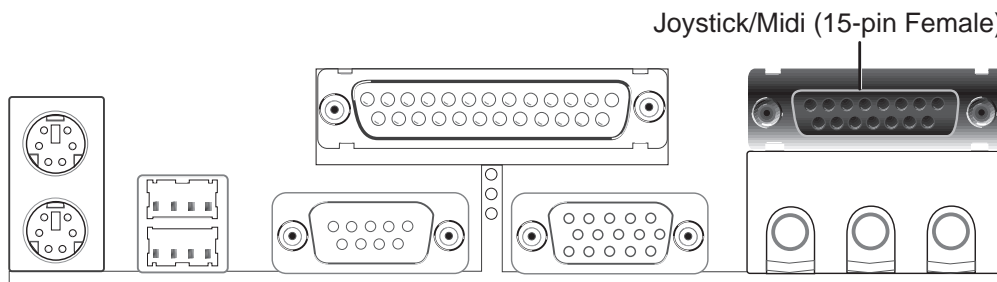

## 8. Audio Port Connectors (Three 1/8" GAME\_AUDIO)

**Line Out** can be connected to headphones or preferably powered speakers. **Line In** allows tape players or other audio sources to be recorded by your computer or played through the **Line Out**. **Mic** allows microphones to be connected for inputting voice.

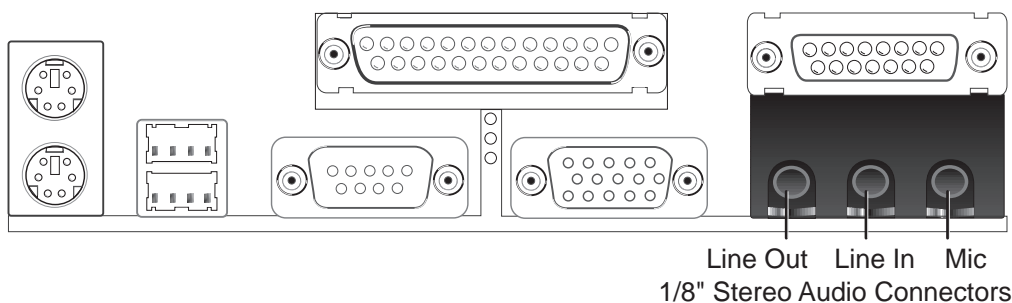



# III. HARDWARE SETUP

## 9. Primary / Secondary IDE connectors (Two 40-1pin IDE)

These connectors support the provided IDE hard disk ribbon cable. After connecting the single end to the board, connect the two plugs at the other end to your hard disk(s). If you install two hard disks, you must configure the second drive to Slave mode by setting its jumper accordingly. Please refer to the documentation of your hard disk for the jumper settings. BIOS now supports SCSI device or IDE CD-ROM bootup (see “HDD Sequence SCSI/IDE First” & “Boot Sequence” in *BIOS Features Setup* of BIOS SETUP) (**Pin 20 is removed to prevent inserting in the wrong orientation when using ribbon cables with pin 20 plugged**).

**TIP:** You may configure two hard disks to be both Masters using one ribbon cable on the primary IDE connector and another ribbon cable on the secondary IDE connector. You may install one operating system on an IDE drive and another on a SCSI drive and select the boot disk through *BIOS Features Setup*.

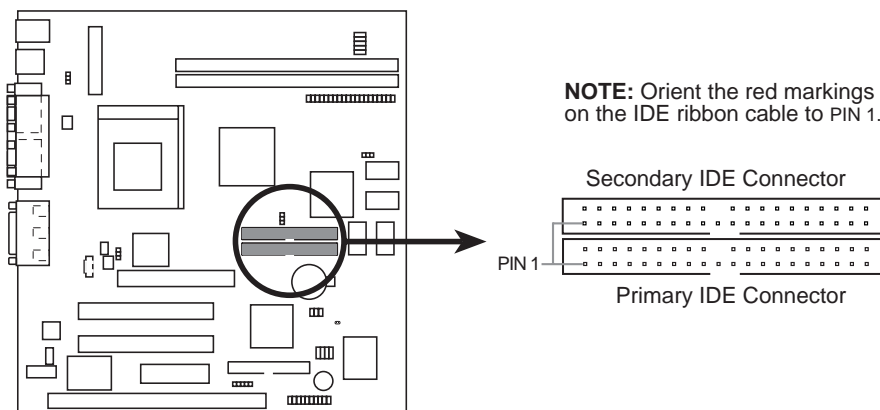

**MEB-VM IDE Connectors**

## 10. Floppy Disk Drive Connector (34-1pin FLOPPY)

This connector supports the provided floppy drive ribbon cable. After connecting the single end to the board, connect the two plugs on the other end to the floppy drives. (**Pin 5 is removed to prevent inserting in the wrong orientation when using ribbon cables with pin 5 plugged**).

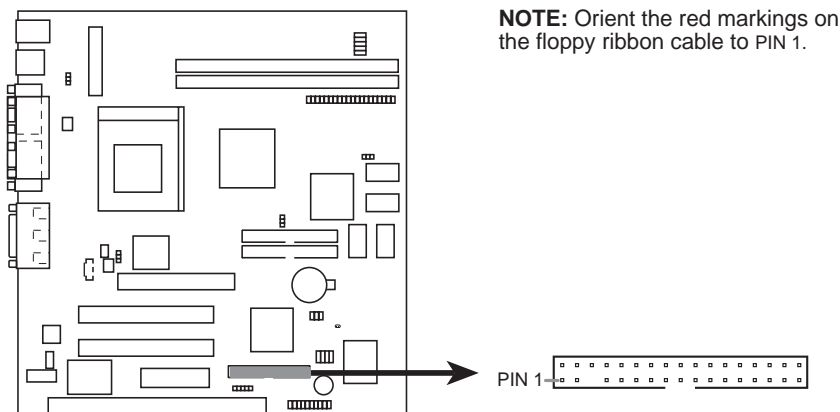

**MEB-VM Floppy Disk Drive Connector**

# III. HARDWARE SETUP

## 11. IrDA-Compliant Infrared Module Connector (5-pin IR)

This connector supports the optional wireless transmitting and receiving infrared module. This module mounts to a small opening on system cases that support this feature. You must also configure the setting through “UART2 Use Infrared” in **Chipset Features Setup** to select whether UART2 is directed for use with COM2 or IrDA. Use the five pins as shown on the Back View and connect a ribbon cable from the module to the motherboard according to the pin definitions.

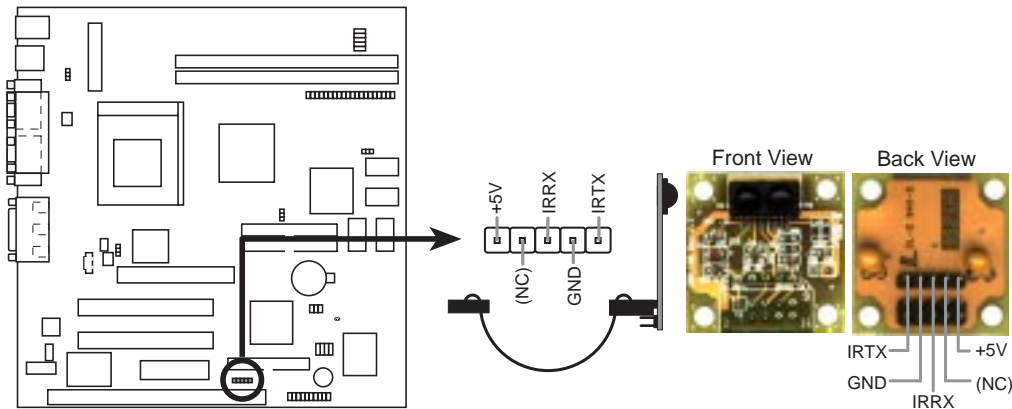

**MEB-VM Infrared Module Connector**

## 12. Wake-On-LAN Connector (3-pin WOL\_CON)

This connector connects to LAN cards with a Wake On LAN output, such as the ASUS PCI-L101. The connector powers up the system when a wakeup packet or signal is received through the LAN card.

**IMPORTANT:** This feature requires that the **WAKE On LAN Power Up Control** is set to *Enabled* (see “Power Management Setup” under **BIOS SOFTWARE** section) and that your system has an ATX power supply with at least 720mA +5V standby power.

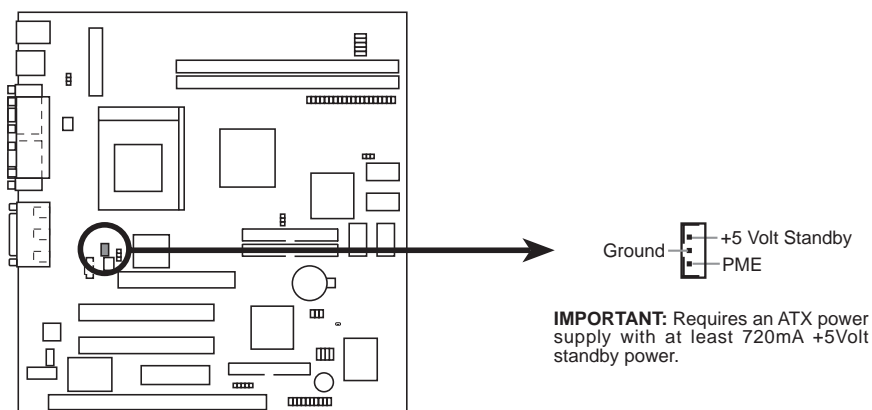

**MEB-VM Wake-On-LAN Connector**

**IMPORTANT:** Requires an ATX power supply with at least 720mA +5V standby power.

# III. HARDWARE SETUP

## 13. SB-Link™ Connector (6-1 pin SBLINK)

If you have a Sound Blaster compatible PCI audio card, you must link it to this connector. Otherwise, you will have compatibility issues under DOS environment.

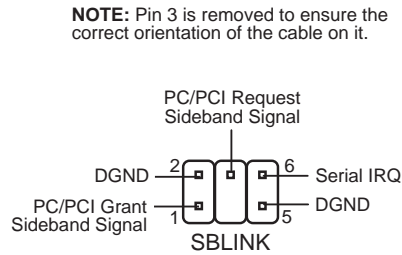
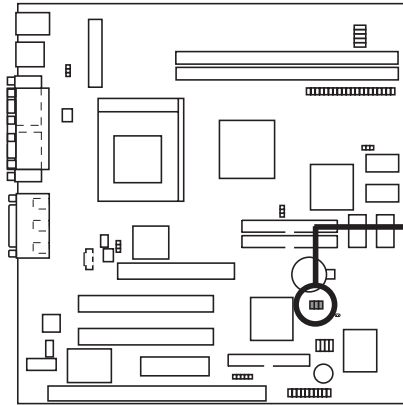

**MEB-VM SB-Link™ Header**

## 14. Stereo Audio In Connector (4-pin CD\_IN)

The CD\_IN connector can be used to receive stereo audio input from an internal CD-ROM drive or other sound sources such as a TV tuner or MPEG card.

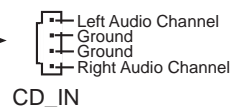
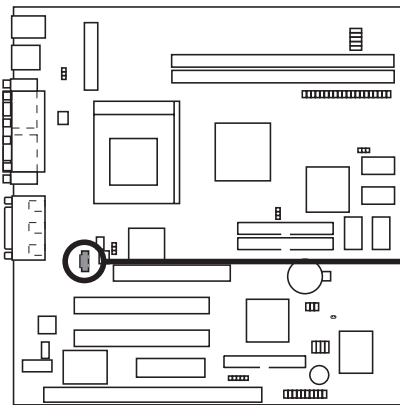

**MEB-VM Stereo Audio In Connector**

# III. HARDWARE SETUP

## 15. Voice Modem In Connector (4-pin MODEM)

The MODEM connector allows mono input and output for a voice modem microphone and speaker interface.

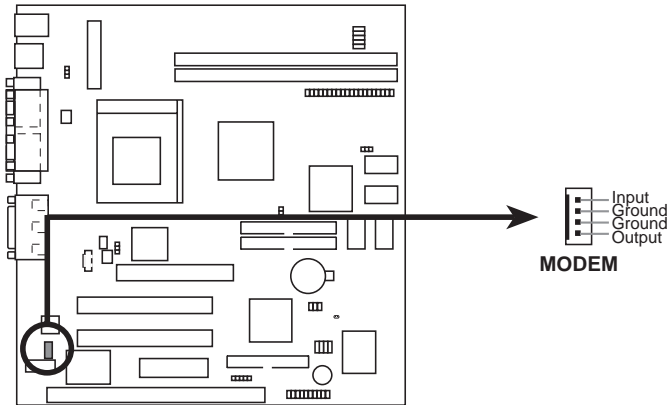

**MEB-VM Voice Modem In Connector**

## 16. Serial Port COM 2 Header (10-1 pin COM2)

The optional serial port connector and bracket can be used to add an additional serial port for additional serial devices.

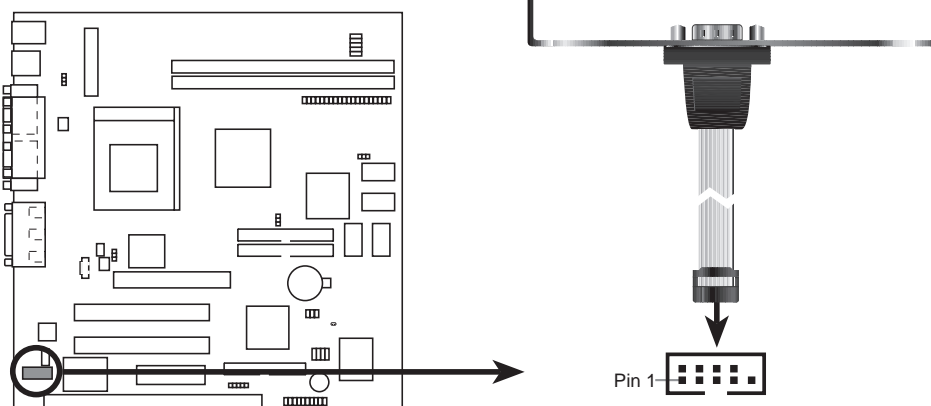

**MEB-VM Serial COM 2 Header**

# III. HARDWARE SETUP

## 17. ATI Multimedia Channel Connector (40-3 pin AMC)

This connector is used for video accessories such as video capture cards or television tuners.

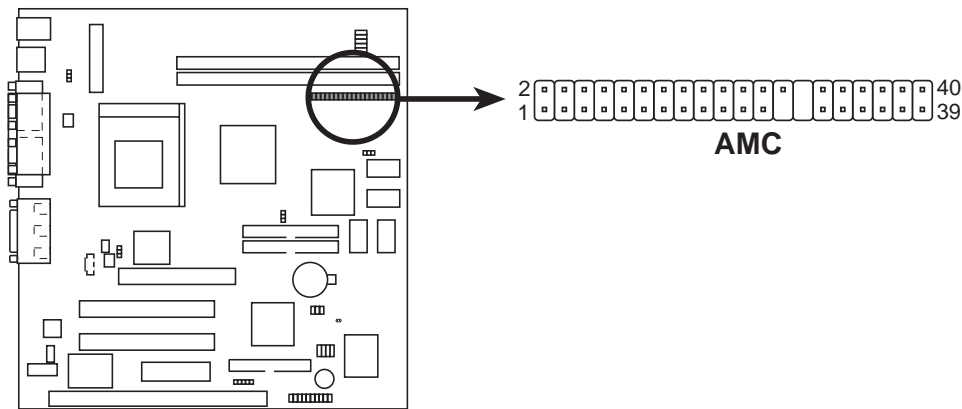

MEB-VM ATI Multimedia Channel Connector

## 18. CPU Fan Connectors (3-pin CPU\_FAN)

This connector supports cooling fans of 500mA (6 Watts) or less. Orientate the fans so that the heat sink fins allow airflow to go across the onboard heat sink(s) instead of the expansion slots. Depending on the fan manufacturer, the wiring and plug may be different. The red wire should be positive, while the black should be ground. Connect the fan's plug to the board taking into consideration the polarity of the this connector. **NOTE: The "Rotation" signal is to be used only by a specially designed fan with rotation signal.**

**WARNING!** The CPU and/or motherboard will overheat if there is no airflow across the CPU and onboard heatsinks. Damage may occur to the motherboard and/or the CPU fan if these pins are incorrectly used. **These are not jumpers, do not place jumper caps over these pins.**

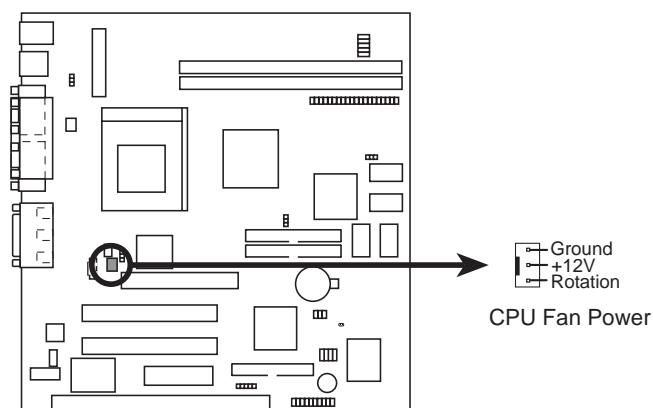

MEB-VM Cooling Fan Connector

# III. HARDWARE SETUP

For Items 19-26

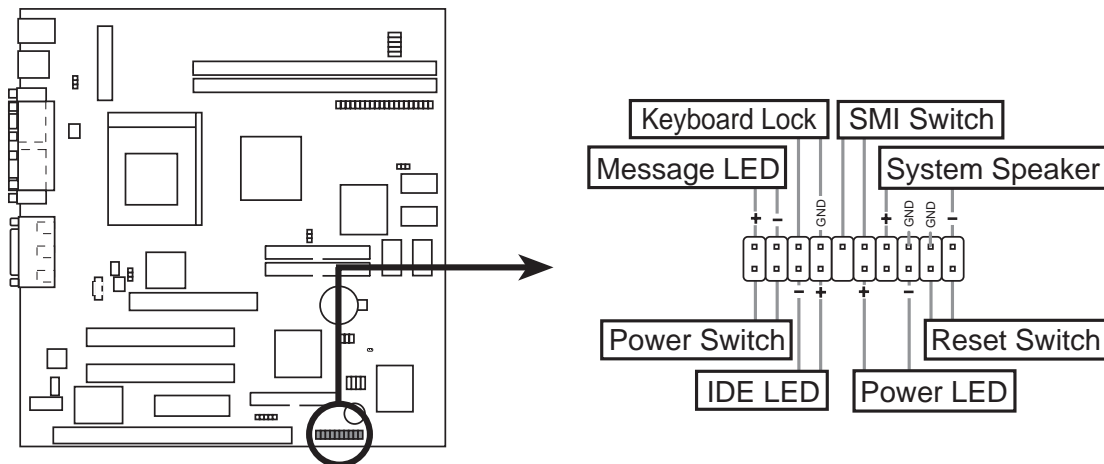

**MEB-VM System Panel Connectors**

## 19. ATX Power Switch/Soft Power Switch Lead (2-pin PWR)

The system power can be controlled by a momentary switch connected to this lead. Pushing the button once will switch the system between ON and OFF. Pushing the switch while in the ON mode for more than 4 seconds will turn the system off. The system power LED shows the status of the system's power.

## 20. IDE Activity LED (2-pin IDELED)

This 2-pin connector supplies power to the cabinet's IDE activity LED. Read and write activity by devices connected to the Primary or Secondary IDE connectors will cause the LED to light up.

## 21. System Power LED Lead (3-1 pin PLED)

This 3-1 pin connector connects the system power LED, which lights when the system is powered on and blinks when it is in sleep mode.

## 22. Reset Switch Lead (2-pin RESET)

This 2-pin connector connects to the case-mounted reset switch for rebooting your computer without having to turn off your power switch. This is a preferred method of rebooting in order to prolong the life of the system's power supply.

## 23. Message LED Lead (2-pin MLED)

This indicates whether a message has been received from a fax/modem. The LED will remain lit when there is no signal and blink when there is data transfer or messages waiting in the inbox. This function requires ACPI OS support.

## 24. Keyboard Lock Switch Lead (2-pin KEYLOCK)

This 2-pin connector connects to the case-mounted key switch to allow keyboard locking.

# III. HARDWARE SETUP

---

## 25. System Management Interrupt (SMI) Lead (2-pin SMI)

This allows the user to manually place the system into a suspend mode or “Green” mode where system activity will be instantly decreased to save electricity and expand the life of certain components when the system is not in use. This 2-pin connector (see the figure below) connects to the case-mounted suspend switch. If you do not have a switch for the connector, you may use the “Turbo Switch” since it does not have a function. SMI is activated when it detects a *short to open* moment and therefore leaving it shorted will not cause any problems. May require one or two pushes depending on the position of the switch. The keyboard will always allow wake-up (the SMI lead cannot wake-up the system).

## 26. System Warning Speaker Connector (4-pin SPEAKER)

This 4-pin connector connects to the case-mounted speaker. You may leave this disconnect as this motherboard has an onboard buzzer which can replace the chassis speaker. When connected, you will hear system warnings though both sources.

**NOTE:** Some sound cards allow you to connect to the system speaker signal so that the warnings can be heard and adjusted through your multimedia system.

# III. HARDWARE SETUP

## 27. ATX Power Supply Connector (20-pin block ATXPWR)

This connector connects to an ATX power supply. The plug from the power supply will only insert in one orientation because of the different hole sizes. Find the proper orientation and push down firmly making sure that the pins are aligned.

**IMPORTANT:** Make sure that your ATX power supply can supply at least 10mA on the 5-volt standby lead (+5VSB). You may experience difficulty in powering on your system if your power supply cannot support the load. For Wake-On-LAN support, your ATX power supply must supply at least 720mA +5VSB.

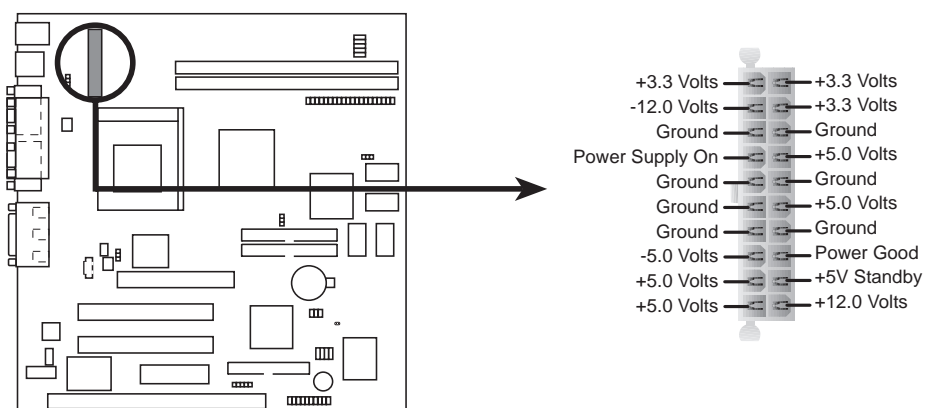

MEB-VM ATX Power Connector



# III. HARDWARE SETUP

---

## Power Connection Procedures

1. After all connections are made, close the system case cover.
  2. Be sure that all switches are off (in some systems, marked with ○).
  3. Connect the power supply cord into the power supply located on the back of your system case according to your system user's manual.
  4. Connect the power cord into a power outlet that is equipped with a surge protector.
  5. You may then turn on your devices in the following order:
    - a. Your monitor
    - b. External SCSI devices (starting with the last device on the chain)
    - c. Your system power. For ATX power supplies, you need to switch on the power supply if a switch is provided as well as press the ATX power switch on the front of the case.
  6. The power LED on the front panel of the system case will light. For ATX power supplies, the system LED will light when the ATX power switch is pressed. The LED on the monitor may light up or switch between orange and green after the system's if it complies with "green" standards or if it has a power standby feature. The system will then run power-on tests. While the tests are running, additional messages will appear on the screen. If you do not see anything within 30 seconds from the time you turn on the power, the system may have failed a power-on test. Recheck your jumper settings and connections or call your retailer for assistance.
  7. During power-on, hold down <Delete> to enter BIOS setup. Follow the instructions in the next section, BIOS SETUP.
- \* **Powering Off your computer:** You must first exit or shut down your operating system before switching off the power switch. For ATX power supplies, you can press the ATX power switch after exiting or shutting down your operating system. If you are using Windows 95/98, click the **Start** button, click **Shut Down**, and then click **Shut down the computer?**. The power supply should turn off after Windows shuts down.

**NOTE:** The message "You can now safely turn off your computer" will not appear when shutting down with ATX power supplies.

# IV. BIOS SETUP

## Flash Memory Writer Utility

**AFLASH.EXE:** This is the Flash Memory Writer utility that updates the BIOS by uploading a new BIOS file to the programmable flash ROM chip on the motherboard. To determine the BIOS version of your motherboard, check the last four numbers of the code displayed on the upper left-hand corner of your screen during bootup. Larger numbers represent a newer BIOS file. This file works only in DOS mode.

**NOTE:** The following screen displays are provided as examples only and may not reflect the screen contents displayed on your system.

```
          ACPI BIOS
    FLASH MEMORY WRITER V1.0
    Copyright (C) 1994-99, ASUSTeK COMPUTER INC.

Flash Memory: 32T 256K09

Current BIOS Version: 6015      ACPI BIOS Revision 1001
Chipset and Model    : 16400X-P2B
BIOS Built Date     : 03/21/98

Choose one of the followings:
1. Save Current BIOS To File
2. Update BIOS Including Boot Block and ESCD

Enter choice: [1]

Press ESC To Exit
```

**IMPORTANT!** If “unknown” is displayed after **Flash Memory:**, the memory chip is either not programmable or is not supported by the ACPI BIOS and therefore, cannot be programmed by the Flash Memory Writer utility.

## Main Menu

### 1. Save Current BIOS To File

This option allows you to save a copy of the original motherboard BIOS in case you need to reinstall it. It is recommended that you save **AFLASH.EXE** and the BIOS file to a bootable floppy disk.

To save your current BIOS, type [1] at the **Main Menu** and then press <Enter>. The **Save Current BIOS To File** screen appears.

Type a filename and the path, for example, **A:\XXX-X** and then press <Enter>.

```
          Save Current BIOS To File

Flash Memory: 32T 256K09

Current BIOS Version: 6015      ACPI BIOS Revision 1001
Chipset and Model    : 16400X-P2B
BIOS Built Date     : 03/21/98

Please Enter File Name to Save: A:\44881-1
```

# IV. BIOS SETUP

## 2. Update BIOS Including Boot Block and ESCD

This option updates the boot block, the baseboard BIOS, and the ACPI extended system configuration data (ESCD) parameter block from a new BIOS file. See the next page for procedures on downloading an updated BIOS file.

To update your current BIOS, type [2] at the **Main Menu** and then press <Enter>. The **Update BIOS Including Boot Block and ESCD** screen appears. Type the filename of your new BIOS and the path, for example, **A:\XXXXXXXX.AWD**, and then press <Enter>.

When prompted to confirm the BIOS update, press **Y** to start the update.

The utility starts to program the new BIOS information into the flash ROM. When the programming is finished, *Flashed Successfully* will be displayed.

Follow the onscreen instructions to continue.

```
Update BIOS Including Boot Block and ESCD
Flash Memory: SST 25CE009
Current BIOS Version: 6015      ACPI BIOS Revision 1001
Chipset and Model : 154800-P2B
BIOS Built Date : 03/21/98
Please Enter File Name for NEW BIOS: A:\XXXXXXXX.AWD
```

```
Update BIOS Including Boot Block and ESCD
Flash Memory: SST 25CE009
BIOS Version
| CURRENT | 6015      ACPI BIOS Revision 1001
|XXXXXXXX.AWD| 6015      ACPI BIOS Revision 1002
Chipset and Model
| CURRENT | 154800-<CP2B>-B
|XXXXXXXX.AWD| 154800-<CP2B>-B
Date of BIOS Built
| CURRENT | 03/21/98
|XXXXXXXX.AWD| 03/25/98
Are you sure (Y/N) ? (Y)
Please ESC To Return to Main Menu
```

```
Update BIOS Including Boot Block and ESCD
Flash Memory: SST 25CE009
BIOS Version
| CURRENT | 6015      ACPI BIOS Revision 1001
|XXXXXXXX.AWD| 6015      ACPI BIOS Revision 1002
Chipset and Model
| CURRENT | 154800-<CP2B>-B
|XXXXXXXX.AWD| 154800-<CP2B>-B
Date of BIOS Built
| CURRENT | 03/21/98
|XXXXXXXX.AWD| 03/25/98
Are you sure (Y/N) ? (Y)
Programming -- 20FFF
Flashed Successfully
Please ESC To Return to Main Menu
```

```
6015 ACPI BIOS
FLASH MEMORY WRITER V1.0
Copyright (C) 1994-98, ASUS/tek COMPUTER INC.
Flash Memory: SST 25CE009
Current BIOS Version: 6015      ACPI BIOS Revision 1001
Chipset and Model : 154800-P2B
BIOS Built Date : 03/21/98
Choose one of the followings:
1. Save Current BIOS To File
2. Update BIOS Including Boot Block and ESCD
Enter choice: [1]
You have flashed the EPROM! It is recommended that you turn off
the power, enter SETUP and Load Setup Defaults to have CMOS
updated with new BIOS when exits.
Please ESC To Exit
```

# IV. BIOS SETUP

---

## Managing and Updating Your Motherboard's BIOS

### Upon First Use of the Computer System

1. Create a bootable system floppy disk by typing [FORMAT A:/S] from the DOS prompt without creating "AUTOEXEC.BAT" and "CONFIG.SYS" files.
2. Copy AFLASH.EXE to the just created boot disk.
3. Run AFLASH.EXE from this new disk and select option **1. Save Current BIOS to File**. See **1. Save Current BIOS To File** on the previous page for more details and the rest of the steps.

### Updating BIOS Procedures (only when necessary)

1. Download an updated ASUS BIOS file from the Internet (WWW or FTP) or a BBS (Bulletin Board Service) (see ASUS CONTACT INFORMATION on page 3 for details) and save to the disk you created earlier.
2. Boot from the disk you created earlier.
3. At the "A:\>" prompt, type **AFLASH** and then press <Enter>.
4. At the **Main Menu**, type **2** and then press <Enter>. See **2. Update BIOS Including Boot Block and ESCD** on the previous page for more details and the rest of the steps.

**WARNING!** If you encounter problems while updating the new BIOS, DO NOT turn off your system since this might prevent your system from booting up. Just repeat the process, and if the problem still persists, update the original BIOS file you saved to disk above. If the Flash Memory Writer utility was not able to successfully update a complete BIOS file, your system may not be able to boot up. If this happens, your system will need service.

# IV. BIOS SETUP

## 6. BIOS Setup

The motherboard supports two programmable Flash ROM chips: 5-Volt and 12-Volt. Either of these memory chips can be updated when BIOS upgrades are released. Use the Flash Memory Writer utility to download the new BIOS file into the ROM chip as described in detail in this section.

All computer motherboards provide a Setup utility program for specifying the system configuration and settings. If your motherboard came in a computer system, the proper configuration entries may have already been made. If so, invoke the Setup utility, as described later, and take note of the configuration settings for future reference; in particular, the hard disk specifications.

If you are installing the motherboard, reconfiguring your system or you receive a Run Setup message, you will need to enter new setup information. This section describes how to configure your system using this utility.

The BIOS ROM of the system stores the Setup utility. When you turn on the computer, the system provides you with the opportunity to run this program. This appears during the Power-On Self Test (POST). Press <Delete> to call up the Setup utility. If you are a little bit late pressing the mentioned key(s), POST will continue with its test routines, thus preventing you from calling up Setup. If you still need to call Setup, reset the system by pressing <Ctrl> + <Alt> + <Delete>, or by pressing the Reset button on the system case. You can also restart by turning the system off and then back on again. But do so only if the first two methods fail.

When you invoke Setup, the CMOS SETUP UTILITY main program screen will appear with the following options:



# IV. BIOS SETUP

## Load Defaults

The “Load BIOS Defaults” option loads the minimum settings for troubleshooting. “**Load Setup Defaults**”, on the other hand, is for loading optimized defaults for regular use. Choosing defaults at this level, will modify all applicable settings.

A section at the bottom of the above screen displays the control keys for this screen. Take note of these keys and their respective uses. Another section just below the control keys section displays information on the currently highlighted item in the list.

## Standard CMOS Setup

The “Standard CMOS Setup” option allows you to record some basic system hardware configuration and set the system clock and error handling. If the motherboard is already installed in a working system, you will not need to select this option anymore. However, if the configuration stored in the CMOS memory on the board gets lost or damaged, or if you change your system hardware configuration, you will need to respecify the configuration values. The configuration values usually get lost or corrupted when the power of the onboard CMOS battery weakens.



The preceding screen provides you with a list of options. At the bottom of this screen are the control keys for this screen. Take note of these keys and their respective uses.

User-configurable fields appear in a different color. If you need information on the selected field, press <F1>. The help menu will then appear to provide you with the information you need. The memory display at the lower right-hand side of the screen is read-only and automatically adjusts accordingly.

### Details of Standard CMOS Setup:

#### Date

To set the date, highlight the “Date” field and then press either <Page Up>/<Page Down> or <+>/<-> to set the current date. Follow the month, day and year format. Valid values for month, day and year are: **Month: (1 to 12), Day: (1 to 31), Year: (up to 2079)**

# IV. BIOS SETUP

---

## Time

To set the time, highlight the “Time” field and then press either <Page Up>/<Page Down> or <+>/<-> to set the current time. Follow the hour, minute and second format. Valid values for hour, minute and second are: (**Hour: (00 to 23)**, **Minute: (00 to 59)**, **Second: (00 to 59)**).

**NOTE:** You can bypass the date and time prompts by creating an AUTOEXEC.BAT file. For information on how to create this file, please refer to the MS-DOS manual.

## Hard Disks

This field records the specifications for all non-SCSI hard disk drives installed in your system. The onboard PCI IDE connectors provide Primary and Secondary channels for connecting up to four IDE hard disks or other IDE devices. Each channel can support up to two hard disks; the first of which is the “master” and the second is the “slave”.

Specifications for SCSI hard disks need not to be entered here since they operate using device drivers and are not supported by the BIOS. If you install other SCSI controller cards, refer to their respective documentations on how to install the required SCSI drivers.

### For IDE hard disk drive setup, you can:

- Use the *Auto* setting for detection during bootup.
- Use the IDE HDD AUTO DETECTION in the main menu to automatically enter the drive specifications.
- Enter the specifications yourself manually by using the “User” option.

The entries for specifying the hard disk type include **CYLS** (number of cylinders), **HEAD** (number of read/write heads), **PRECOMP** (write precompensation), **LANDZ** (landing zone), **SECTOR** (number of sectors) and **MODE**. The **SIZE** field automatically adjusts according to the configuration you specify. The documentation that comes with your hard disk should provide you with the information regarding the drive specifications.

The **MODE** entry is for IDE hard disks only, and can be ignored for MFM and ESDI drives. This entry provides three options: *Normal*, *Large*, *LBA*, or *Auto* (see below). Set **MODE** to the *Normal* for IDE hard disk drives smaller than 528MB; set it to *LBA* for drives over 528MB that support Logical Block Addressing (LBA) to allow larger IDE hard disks; set it to *Large* for drives over 528MB that do not support LBA. *Large* type of drive can only be used with MS-DOS and is very uncommon. Most IDE drives over 528MB support the *LBA* mode.

# IV. BIOS SETUP

---

## **Auto detection of hard disks on bootup**

For each field: Primary Master, Primary Slave, Secondary Master, and Secondary Slave, you can select *Auto* under the TYPE and MODE fields. This will enable auto detection of your IDE hard disk during bootup. This will allow you to change your hard disks (with the power off) and then power on without having to reconfigure your hard disk type. If you use older hard disks that do not support this feature, then you must configure the hard disk in the standard method as described earlier by the “User” option.

**NOTE:** After the IDE hard disk drive information has been entered into BIOS, new IDE hard disk drives must be partitioned (such as with FDISK) and then formatted before data can be read from and write on. Primary IDE hard disk drives must have its partition set to *active* (also possible with FDISK).

**NOTE:** SETUP Defaults are noted in parenthesis next to each function heading.

## **Drive A (None)**

This field records the type of floppy disk drive installed in your system. The available options are: *360K, 5.25 in.; 1.2M, 5.25 in.; 720K, 3.5 in.; 1.44M, 3.5 in.; 2.88M, 3.5 in.; None*

## **Floppy 3 Mode Support (Disabled)**

This is the Japanese standard floppy drive. The standard stores 1.2MB in a 3.5inch diskette. This is normally disabled but you may choose from either: *Drive A* or *Disabled*

## **Video (EGA/VGA)**

Set this field to the type of video display card installed in your system. The options are *EGA/VGA, CGA 40, CGA 80, and MONO* (for Hercules or MDA).

If you are using a VGA or any higher resolution card, choose *EGA/VGA*.

## **Halt On (All Errors)**

This field determines which types of errors will cause the system to halt. Choose from *All Errors; No Errors; All,But Keyboard, All,But Diskette; and All,But Disk/Key*.



# IV. BIOS SETUP

## BIOS Features Setup

The “BIOS Features Setup” option consists of configuration entries that allow you to improve your system performance, or let you set up some system features according to your preference. Some entries are required by the motherboard’s design to remain in their default settings.



A section at the lower right of the screen displays the control keys you can use. Take note of these keys and their respective uses. If you need information on a particular entry, highlight it and then press <F1>. A pop-up help menu will appear to provide you with the information you need. <F5> loads the last set values, <F6> and <F7> loads the BIOS default values and Setup default values, respectively.

**NOTE:** SETUP Defaults are noted in parenthesis next to each function heading.

### Details of BIOS Features Setup

#### CPU Internal Core Speed

This function is reserved for future use and is currently disabled.

#### Boot Virus Detection (Enabled)

This field allows you to set boot virus detection, ensuring a virus-free boot sector. This new antivirus solution is unlike native BIOS tools, which offer limited virus protection typically by write-protecting the partition table. With this new solution, your computer is protected against boot virus threats earlier in the boot cycle, that is, before they have a chance to load into your system. This ensures your computer boots to a clean operating system. The system halts and displays a warning message when it detects a virus. If this occurs, you can either allow the operation to continue or use a virus-free bootable floppy disk to restart and investigate your system. Because of conflicts with new operating systems, for example, during installation of new software, you may have to set this to *Disabled* to prevent write errors.

# IV. BIOS SETUP

---

## **CPU Level 1 Cache / CPU Level 2 Cache (Enabled)**

These fields allow you to choose from the default of *Enabled* or choose *Disabled* to turn on or off the CPU's Level 1 and Level 2 built-in cache.

## **CPU Level 2 Cache ECC Check (Disabled)**

This function controls the ECC check capability in the CPU level 2 cache.

## **BIOS Update (Enabled)**

This functions as an update loader integrated into the BIOS to supply the processor with the required data. The BIOS will load the update on all processors during system bootup in the default position of *Enabled*.

## **Turbo Mode (Disabled)**

Leave on default setting.

## **Quick Power On Self Test (Enabled)**

This field speeds up the Power-On Self Test (POST) routine by skipping retesting a second, third, and fourth time. Setup default setting for this field is *Enabled*. A complete test of the system is done on each test.

## **HDD Sequence SCSI/IDE First (IDE)**

When using both SCSI and IDE hard disk drives, IDE is always the boot disk using drive letter C (default setting of *IDE*). This new feature allows a SCSI hard disk drive to be the boot disk when set to *SCSI*. This allows multiple operating systems to be used on both IDE and SCSI drives or the primary operating system to boot using a SCSI hard disk drive.

## **Boot Sequence (A,C)**

This field determines where the system looks first for an operating system. Options are *A,C*; *C,A*; *A,CDROM,C*; *CDROM,C,A*; *D,A*; *E,A*; *F,A*; *C only*; *LS/ZIP, C*; *LAN,A,C*; and *LAN,C,A*. The setup default setting, *A, C*, is to check first the floppy disk and then the hard disk drive.

## **Boot Up Floppy Seek (Disabled)**

When enabled, the BIOS will seek drive A once.

## **Floppy Disk Access Control (R/W)**

This allows protection of files from the computer system to be copied to floppy disks by allowing the setting of *Read Only* to only allow reads from the floppy disk drive but not writes. The setup default *R/W* allows both reads and writes.

## **IDE HDD Block Mode Sectors (HDD MAX)**

This field enhances hard disk performance by making multi-sector transfers instead of one sector per transfer. Most IDE drives, except older versions, can utilize this feature. Selections are *HDD MAX*, *Disabled*, *2*, *4*, *8*, *16*, and *32*.

## **HDD S.M.A.R.T. capability (Disabled)**

This allows the enabling or disabling of the S.M.A.R.T. (Self-Monitoring, Analysis and Reporting Technology) system which utilizes internal hard disk drive monitoring technology. This feature is normally disabled because system resources used in this feature may decrease system performance.

# IV. BIOS SETUP

---

## **PS/2 Mouse Function Control (Auto)**

The default of *Auto* allows the system to detect a PS/2 mouse on bootup. If detected, IRQ12 will be used for the PS/2 mouse. IRQ12 will be reserved for expansion cards if a PS/2 mouse is not detected. *Enabled* will always reserve IRQ12, whether on bootup a PS/2 mouse is detected or not.

## **OS/2 Onboard Memory > 64M (Disabled)**

When using OS/2 operating systems with installed DRAM of greater than 64MB, you need to set this option to *Enabled* otherwise leave this on *Disabled*.

.....

## **PCI/VGA Palette Snoop (Disabled)**

Some display cards that are nonstandard VGA such as graphics accelerators or MPEG Video Cards may not show colors properly. The setting *Enabled* should correct this problem. Otherwise leave this on the setup default setting of *Disabled*.

## **Video ROM BIOS Shadow (Enabled)**

This field allows you to change the video BIOS location from ROM to RAM. Relocating to RAM enhances system performance, as information access is faster than the ROM.

## **C8000-CBFFF to DC000-DFFFF (Disabled)**

These fields are used for shadowing other expansion card ROMs. If you install other expansion cards with ROMs on them, you will need to know which addresses the ROMs use to shadow them specifically. Shadowing a ROM reduces the memory available between 640K and 1024K by the amount used for this purpose.

## **Boot Up NumLock Status (On)**

This field enables users to activate the Number Lock function upon system boot.

## **Typematic Rate Setting (Disabled)**

When enabled, you can set the two typematic controls listed next. Setup default setting is *Disabled*.

## **Typematic Rate (Chars/Sec) (6)**

This field controls the speed at which the system registers repeated keystrokes. Options range from 6 to 30 characters per second. Setup default setting is **6**; other settings are 8, 10, 12, 15, 20, 24, and 30.

## **Typematic Delay (Msec) (250)**

This field sets the time interval for displaying the first and second characters. Four delay rate options are available: 250, 500, 750, and 1000.

## **Security Option (System)**

When you specify a *Supervisor Password* and/or *User Password* (explained later in this section), the Security Option field determines when the system prompts for the password. The default setting is *System*, where the system prompts for the User Password every time you start your system. The other option is *Setup*, where the system goes through its startup routine unless the Setup utility is called, when the system prompts for the Supervisor Password.

# IV. BIOS SETUP

## Chipset Features Setup

The “Chipset Features Setup” option controls the configuration of the board’s chipset.



**NOTE:** SETUP Defaults are noted in parenthesis next to each function heading.

### Details of Chipset Features Setup

#### SDRAM Configuration (By SPD)

This sets the optimal timings of settings for items 2–5, depending on the memory modules that you are using. Default setting is *By SPD*, which configures items 2–5 by reading the contents in the SPD (Serial Presence Detect) device. This 8-pin serial EEPROM device stores critical parameter information about the module, such as memory type, size, speed, voltage interface, and module banks.

#### SDRAM CAS Latency

This controls the latency between SDRAM read command and the time that the data actually becomes available. Leave on default setting.

#### SDRAM RAS to CAS Delay

This controls the latency between SDRAM active command and the read/write command. Leave on default setting.

#### SDRAM RAS Precharge Time

This controls the idle clocks after issuing a precharge command to SDRAM. Leave on default setting.

#### DRAM Idle Timer

This controls the idle clocks before closing an opened SDRAM page. Leave on default setting.

#### SDRAM MA Wait State (Normal)

This controls the leadoff clocks for CPU read cycles. Leave on default setting.

#### Snoop Ahead (Enabled)

*Enabled* will allow PCI streaming. Leave on default setting.

#### Host Bus Fast Data Ready (Disabled)

Leave on default setting.

# IV. BIOS SETUP

**16-bit I/O Recovery Time (1 BUSCLK) / 8-bit I/O Recovery Time (1 BUSCLK)**  
Timing for 16-bit and 8-bit ISA cards, respectively. Leave on default setting.

## **Graphics Aperture Size (64MB)**

Memory-mapped, graphics data structures can reside in a Graphics Aperture. Leave on default setting.

## **Video Memory Cache Mode (UC)**

*USWC* (uncacheable, speculative write combining) is a new cache technology for the video memory of the processor. It can greatly improve the display speed by caching the display data. You must leave this on the default setting of *UC* (uncacheable) if your display card cannot support this feature, otherwise your system may not boot.

## **PCI 2.1 Support (Enabled)**

This function allows you to enable or disable PCI 2.1 features including passive release and delayed transaction. Leave *Enabled* (default setting) for PCI 2.1 compliancy.

## **Memory Hole At 15M–16M (Disabled)**

Enabling this feature reserves 15MB to 16MB memory address space to ISA expansion cards that specifically require this setting. This makes the memory from 15MB and up unavailable to the system. Expansion cards can only access memory up to 16MB. The default is *Disabled*.

## **DRAM are xx bits wide**

If all your DIMMs have ECC (e.g., 8 chips + 1 ECC chip), they are considered 72bits and the following will be displayed:

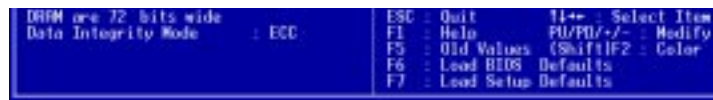

If your DIMMs do not have ECC (e.g., 8 chips), they are considered 64 bits and the following will be displayed instead:

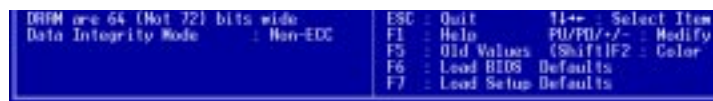

## **Data Integrity Mode (Non-ECC)**

*Non-ECC* has byte-wise write capability but no provision for protecting data integrity in the memory module array. *EC-Only* data errors are detected but not corrected. *ECC* with hardware scrubbing allows a detection of single-bit and multiple-bit errors and recovery of single-bit errors. (See **2. System Memory**, section III for more information on memory modules.)

## **Onboard FDC Controller (Enabled)**

When *Enabled*, this field allows you to connect your floppy disk drives to the onboard floppy disk drive connector instead of a separate controller card. If you want to use a different controller card to connect the floppy disk drives, set this field to *Disabled*.

## IV. BIOS SETUP

---

### Onboard Serial Port 1 (3F8H/IRQ4)

Settings are *3F8H/IRQ4*, *2F8H/IRQ3*, *3E8H/IRQ4*, *2E8H/IRQ10*, and *Disabled* for the onboard serial connector.

### Onboard Serial Port 2 (2F8H/IRQ3)

Settings are *3F8H/IRQ4*, *2F8H/IRQ3*, *3E8H/IRQ4*, *2E8H/IRQ10*, and *Disabled* for the onboard serial connector.

### Onboard Parallel Port (378H/IRQ7)

This field sets the address of the onboard parallel port connector. You can select either: *3BCH/IRQ7*, *378H/IRQ7*, *278H/IRQ5*, *Disabled*. If you install an I/O card with a parallel port, ensure that there is no conflict in the address assignments. The PC can support up to three parallel ports as long as there are no conflicts for each port.

### Parallel Port Mode (ECP+EPP)

This field allows you to set the operation mode of the parallel port. The setting *Normal*, allows normal-speed operation but in one direction only; *EPP* allows bidirectional parallel port operation at maximum speed; *ECP* allows the parallel port to operate in bidirectional mode and at a speed faster than the maximum unidirectional data transfer rate; *ECP+EPP* allows normal speed operation in a two-way mode.

### ECP DMA Select (3)

This selection is available only if you select *ECP* or *ECP+EPP* in the **Parallel Port Mode**. Select either DMA Channel *1*, *3*, or *Disable*.

### UART2 Use Infrared (Disabled)

When enabled, this field activates the onboard infrared feature and sets the second serial UART to support the infrared module connector on the motherboard. If your system already has a second serial port connected to the onboard COM2 connector, it will no longer work if you enable the infrared feature. By default, this field is set to *Disabled*, which leaves the second serial port UART to support the COM2 serial port connector. See **IrDA-compliant infrared module connector** under section III.

### Onboard PCI IDE Enable (Both)

You can select to enable the *primary* IDE channel, *secondary* IDE channel, *both*, or *disable* both channels (for systems with only SCSI drives).

### IDE Ultra DMA Mode (Auto)

This field autodetects Ultra DMA capability (for improved transfer speeds and data integrity) for compatible IDE devices. Set to *Disable* to suppress Ultra DMA capability.

### IDE 0 Master/Slave PIO/DMA Mode, IDE 1 Master/Slave PIO/DMA Mode (Auto)

Each channel (0 and 1) has both a master and a slave making four IDE devices possible. Because each IDE device may have a different Mode timing (0, 1, 2, 3, 4), it is necessary for these to be independent. The default setting of *Auto* will allow autodetection to ensure optimal performance

# IV. BIOS SETUP

## Power Management Setup

The “Power Management Setup” option allows you to reduce power consumption. This feature turns off the video display and shuts down the hard disk after a period of inactivity.



**NOTE:** SETUP Defaults are noted in parenthesis next to each function heading.

### Details of Power Management Setup

#### Power Management (User Define)

This field acts as the master control for the power management modes. *Max Saving* puts the system into power saving mode after a brief period of system inactivity; *Min Saving* is almost the same as *Max Saving* except that this time the system inactivity period is longer; *Disable* disables the power saving features; *User Define* allows you to set power saving options according to your preference.

**IMPORTANT:** Advanced Power Management (APM) should be installed to keep the system time updated when the computer enters suspend mode activated by the BIOS Power Management. For DOS environments, you need to add the statement, `DEVICE=C:\DOS\POWER.EXE`, in you `CONFIG.SYS`. For Windows 3.x and Windows 95, you need to install Windows with the APM feature. A battery and power cord icon labeled “Power” will appear in the “Control Panel.” Choose “Advanced” in the Power Management Field.

#### Video Off Option (Suspend -> Off)

This field determines when to activate the video off feature for monitor power management. The settings are *Always On* and *Suspend -> Off*.

# IV. BIOS SETUP

---

## **Video Off Method (DPMS OFF)**

This field defines the video off features. The following options are available: *DPMS OFF*, *DPMS Reduce ON*, *Blank Screen*, *V/H SYNC+Blank*, *DPMS Standby*, and *DPMS Suspend*. The DPMS (Display Power Management System) features allow the BIOS to control the video display card if it supports the DPMS feature. *Blank Screen* only blanks the screen (use this for monitors without power management or “green” features. If set up in your system, your screen saver will not display with *Blank Screen* selected). *V/H SYNC+Blank* blanks the screen and turns off vertical and horizontal scanning.

.....

## **PM Timers**

This section controls the time-out settings for the Power Management scheme. The fields included in this section are “HDD Power Down”, which places the hard disk into its lowest power consumption mode, and the “Suspend Mode” which suspends the CPU.

The system automatically “wakes up” from any power saving mode when there is system activity such as when a key is pressed from the keyboard, or when there is activity detected from the enabled IRQ channels.

## **HDD Power Down (Disable)**

Shuts down any IDE hard disk drives in the system after a period of inactivity. This time period is user-configurable to *1–15 Min* or *Disable*. This feature does not affect SCSI hard drives.

## **Suspend Mode (Disable)**

Sets the period of time after which each of these modes activate: *30 sec*, *1 Min*, *2 Min*, *4 Min*, *8 Min*, *20 Min*, *30 Min*, *40 Min*, *1 Hour*, and *Disable*.

.....

## **Power Up Control**

This section determines the ways the system can be controlled when it is started or restarted, when modem activity is detected, or when power to the computer is interrupted and reapplied. The Soft-Off mode refers to powering off the system through a momentary button switch (ATX switch) or through the software as opposed to disconnecting the AC power by way of a rocker switch or other means.

## **PWR Button < 4 Secs (Soft Off)**

When set to *Soft Off*, the ATX switch can be used as a normal system power-off button when pressed for less than 4 seconds. *Suspend* allows the button to have a dual function where pressing less than 4 seconds will place the system in sleep mode. Regardless of the setting, holding the ATX switch for more than 4 seconds will power off the system.



# IV. BIOS SETUP

---

## **PWR Up On Modem Act (Enabled)**

This allows either settings of *Enabled* or *Disabled* for powering up the computer (turns the ATX power supply on) when the modem receives a call while the computer is Soft-off.

**NOTE:** The computer cannot receive or transmit data until the computer and applications are fully running, thus connection cannot be made on the first try. Turning an external modem off and then back on while the computer is off causes an initialization string that will also cause the system to power on.

## **AC PWR Loss Restart (Disabled)**

This allows you to set whether you want your system to boot up after the power has been interrupted. *Disabled* leaves your system off after reapplying power and *Enabled* boots up your system after reapplying power.

## **Power Up By Keyboard (Disabled)**

This allows the computer to be powered on by pressing any key on the keyboard. Set of *Enabled* to set this feature. **WARNING!** This setting must coincide with the keyboard power (wake) up jumper setting or else conflicts will occur.

## **Wake On LAN (Enabled)**

This allows you to remotely power up your system through your network by sending a wake-up frame or signal. With this feature, you can remotely upload/download data to/from systems during off-peak hours. *Enabled* sets this feature.

**IMPORTANT:** This feature requires the optional network interface and an ATX power supply with at least 720mA +5V standby power.

## **Automatic Power Up (Disabled)**

This allows you to have an unattended or automatic power up of your system. You may configure your system to power up at a certain time of the day by selecting *Everyday*, which will allow you to set the time or at a certain time and day by selecting *By Date*.

# IV. BIOS SETUP

## PNP and PCI Setup

The “PNP and PCI Setup” option configures the PCI bus slots. All PCI bus slots on the system use INTA#, thus all installed PCI cards must be set to this value.



**NOTE:** SETUP Defaults are noted in parenthesis next to each function heading.

### Details of PNP and PCI Setup

#### PNP OS Installed (No)

This field allows you to use a Plug-and-Play (PnP) operating system to configure the PCI bus slots instead of using the BIOS. Thus interrupts may be reassigned by the OS when *Yes* is selected. When a non-PnP OS is installed or to prevent reassigning of interrupt settings, select the default setting of *No*.

#### Slot 1 IRQ / Slot 2 IRQ (Auto)

These fields set how IRQ use is determined for each PCI slot. The default setting for each field is *Auto*, which uses auto-routing to determine IRQ use. The other options are manual settings of *NA*, *3*, *4*, *5*, *7*, *9*, *10*, *11*, *12*, *14* or *15* for each slot.

#### PCI Latency Timer (32 PCI Clock)

The default setting of *32 PCI Clock* enables maximum PCI performance for this motherboard.

#### IRQ xx Used By ISA (No/ICU)

These fields indicate whether or not the displayed IRQ for each field is being used by a legacy (non-PnP) ISA card. Two options are available: *No/ICU* and *Yes*. The first option, the default value, indicates either that the displayed IRQ is not used or an ISA Configuration Utility (ICU) is being used to determine if an ISA card is using that IRQ. If you install a legacy ISA card that requires a unique IRQ, and you are not using an ICU, you must set the field for that IRQ to *Yes*. For example: If you install a legacy ISA card that requires IRQ 10, then set **IRQ10 Used By ISA** to *Yes*.

.....

# IV. BIOS SETUP

---

## **DMA x Used By ISA (No/ICU)**

These fields indicate whether or not the displayed DMA channel for each field is being used by a legacy (non-PnP) ISA card. Available options include: *No/ICU* and *Yes*. The first option, the default setting, indicates either that the displayed DMA channel is not used or an ICU is being used to determine if an ISA card is using that channel. If you install a legacy ISA card that requires a unique DMA channel, and you are not using an ICU, you must set the field for that channel to *Yes*.

## **ISA MEM Block BASE (No/ICU)**

This field allows you to set the base address and block size of a legacy ISA card that uses any memory segment within the C800H and DFFFH address range. If you have such a card, and you are not using an ICU to specify its address range, select a base address from the six available options; the **ISA MEM Block SIZE** field will then appear for selecting the block size. If you have more than one legacy ISA card in your system that requires to use this address range, you can increase the block size to either 8K, 16K, 36K, or 64K. If you are using an ICU to accomplish this task, leave **ISA MEM Block BASE** to its default setting of *No/ICU*.

## **Symbios SCSI BIOS (Auto)**

*Auto* allows the BIOS to detect whether you have a Symbios SCSI card, if detected the onboard Symbios BIOS will be enabled, if not then it will be disabled. *Disabled* prevents the onboard Symbios BIOS to be enabled so that the external Symbios SCSI card's own BIOS can be used instead. **Note:** If your Symbios SCSI card does not have a BIOS, the Symbios SCSI card will not function.

## **USB IRQ (Enabled)**

*Enabled* reserves an IRQ# for the USB to work, *Disabled* does not allow the USB to have an IRQ# and therefore prevents the USB from functioning. If you are not using any USB devices, you may set this feature to *Disabled* to save an extra IRQ# for expansion cards.

## **ONB VGA BIOS First (No)**

This allows you to select whether you want to use the onboard VGA BIOS as the primary BIOS. *No* allows external VGA cards to take precedent when detected. *Yes* always uses the onboard VGA card's BIOS, even when an external VGA card is installed.

# IV. BIOS SETUP

## Load BIOS Defaults

The “Load BIOS Defaults” option allows you to load the troubleshooting default values permanently stored in the BIOS ROM. These default settings are non-optimal and disable all high performance features. To load these default settings, highlight “Load BIOS Defaults” on the main screen and then press <Enter>. The system displays a confirmation message on the screen. Press <Y> and then <Enter> to confirm. Press <N> and then <Enter> to abort. This feature does not affect the fields on the Standard CMOS Setup screen.

## Load Setup Defaults

The “Load Setup Defaults” option allows you to load the default values to the system configuration fields. These default values are the optimized configuration settings for the system. To load these default values, highlight “Load Setup Defaults” on the main screen and then press <Enter>. The system displays a confirmation message on the screen. Press <Y> and then <Enter> to confirm. Press <N> and then <Enter> to abort. This feature does not affect the fields on the Standard CMOS Setup screen.



# IV. BIOS SETUP

## Supervisor Password and User Password

These two options set the system passwords. “Supervisor Password” sets a password that will be used to protect the system and the Setup utility; “User Password” sets a password that will be used exclusively on the system. By default, the system comes without any passwords. To specify a password, highlight the type you want and then press <Enter>. A password prompt appears on the screen. Taking note that the password is case sensitive, and can be up to 8 alphanumeric characters long, type in your password and then press <Enter>. The system confirms your password by asking you to type it again. After setting a password, the screen automatically reverts to the main screen.



To implement password protection, specify in the “Security Option” field of the BIOS SETUP Features Setup screen when the system will prompt for the password. If you want to disable either password, press <Enter> instead of entering a new password when the “Enter Password” prompt appears. A message confirms the password has been disabled.

### Forgot the password?

If you forgot the password, you can clear the password by erasing the CMOS Real Time Clock (RTC) RAM. The RAM data containing the password information is powered by the onboard button cell battery. To erase the RTC RAM: (1) Unplug your computer, (2) Short the solder points, (3) Turn ON your computer, (4) Hold down <Delete> during bootup and enter BIOS setup to re-enter user preferences.

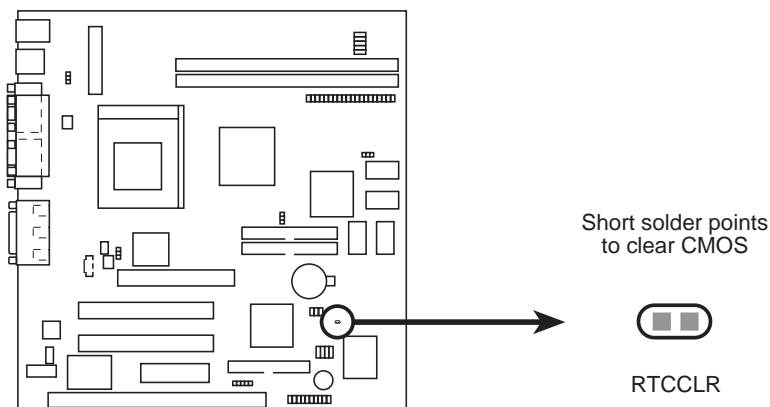

MEB-VM Clear RTC RAM

# IV. BIOS SETUP

## IDE HDD Auto Detection

The “IDE HDD Auto Detection” option detects the parameters of an IDE hard disk drive, and automatically enters them into the Standard CMOS Setup screen.

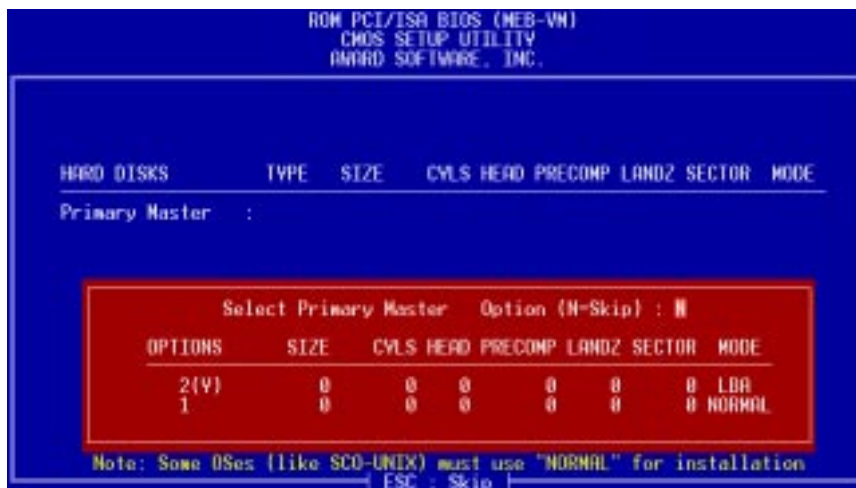

Up to four IDE drives can be detected, with parameters for each listed inside the box. To accept the optimal entries, press <Y> or else select from the numbers displayed under the OPTIONS field (2, 1, 3 in this case); to skip to the next drive, press <N>. If you accept the values, the parameters will appear listed beside the drive letter on the screen. The process then proceeds to the next drive letter. Pressing <N> to skip rather than to accept a set of parameters causes the program to enter zeros after that drive letter.

Remember that if you are using another IDE controller that does not feature Enhanced IDE support for four devices, you can only install two IDE hard disk drives. Your IDE controller must support the Enhanced IDE features in order to use Drive E and Drive F. The onboard PCI IDE controller supports Enhanced IDE, with two connectors for connecting up to four IDE devices. If you want to use another controller that supports four drives, you must disable the onboard IDE controller in the Chipset Features Setup screen.

When auto-detection is completed, the program automatically enters all entries you accepted on the field for that drive in the Standard CMOS Setup screen. Skipped entries are ignored and are not entered in the screen.

If you are auto-detecting a hard disk that supports the LBA mode, three lines will appear in the parameter box. Choose the line that lists LBA for an LBA drive. Do not select Large or Normal.

The auto-detection feature can only detect one set of parameters for a particular IDE hard drive. Some IDE drives can use more than one set. This is not a problem if the drive is new and empty.

# IV. BIOS SETUP

**IMPORTANT:** If your hard disk was already formatted on an older previous system, incorrect parameters may be detected. You will need to enter the correct parameters manually or use low-level format if you do not need the data stored on the hard disk.

If the parameters listed differ from the ones used when the disk was formatted, the disk will not be readable. If the auto-detected parameters do not match the ones that should be used for your disk, do not accept them. Press <N> to reject the presented settings and enter the correct ones manually from the Standard CMOS Setup screen.

## Save & Exit Setup

Select this option to save into the CMOS memory all modifications you specified during the current session. To save the configuration changes, highlight the “Save & Exit Setup” option on the main screen, type “Y”, and then press <Enter>.



IV. BIOS SETUP  
Save & Exit

## Exit Without Saving

Select this option to exit the Setup utility without saving the modifications you specify during the current session. To exit without saving, highlight the “Exit Without Saving” option on the main screen and then press <Enter>.

# IV. BIOS SETUP

---

(This page was intentionally left blank.)



# V. SOFTWARE SETUP

---



V. SW SETUP

# V. SOFTWARE SETUP

---

<b>V. SOFTWARE SETUP .....</b>	<b>57</b>
Operating Systems .....	59
Windows 98 First Time Installation .....	59
MEB-VM Support CD .....	60
Support CD Autorun Menu .....	60
Installing the Video Driver and Utility .....	61
Installing the Audio Driver .....	62
Installing PCCillin .....	63
Installing Adobe Acrobat Reader .....	64

# V. SOFTWARE SETUP

---

## Operating Systems

You should always use the latest operating system and updates when using new hardware in order to ensure full compliancy. For Windows 95, you must use OSR 2.0 or later. For Windows NT 4.0, you must use Service Pack 3.0 or later.

### Windows 98 First Time Installation

When you start Windows for the first time after the installation of your motherboard, Windows 98 will detect the onboard audio and video chips and may attempt to install a driver from its system registry. When prompted to restart, select **No** and then follow the normal setup procedures later in this section.

**IMPORTANT:** Selecting **No** for the initial restart prompt is a necessary step because Windows may load an older display driver that is incompatible with the onboard ATI 3D Rage chip. Always use the driver available on the ASUS Support CD or an applicable driver update from your ASUS vendor or from the ASUS web site.

**NOTE:** The screen displays in this section may not reflect exactly the screen contents displayed on your screen.

# V. SOFTWARE SETUP

## MEB-VM Support CD

Insert the support CD or double-click your CD drive icon in “My Computer” to bring up the autorun menu or run **Setup.exe** in the root directory of the Support CD.

**NOTE:** The Support CD contents are constantly updated without notice.

## Support CD Autorun Menu



- **LDCM Local Setup:** Installs software to monitor the local system. The LANdesk Client Manager must be installed in order to use the hardware manager features.
- **LDCM Administrator Setup:** Installs software to monitor PC systems on the network within the same bridge address with the Local software installed. The administrator should install both Local and Administrator Software.
- **Adobe Acrobat Reader:** Installs the Adobe Acrobat Reader software necessary to view the LDCM manual in the LDCM directory.
- **Install Video Driver and Utility:** Installs the video driver and utilities for the onboard VGA chipset.
- **Install Audio Driver:** Audio driver installation instructions for the onboard audio.
- **Install PCCillin:** Installs “PC-cillin” virus protection software. View the online help if you have any questions.
- **Browse this CD:** Allows you to see the contents of the ASUS support CD.
- **Read Me:** View additional notes with Notepad.
- **LDCM Introduce (MPEG VCD):** View a video on the LDCM features.
- **Exit:** Exit the selection menu.

**Additional CD Contents:** DMI Configuration Utility in the **DMI** directory and Flash BIOS writer in the **AFLASH** directory.

# V. SOFTWARE SETUP

## Installing the Video Driver and Utility

Insert the Support CD that came with your motherboard into your CD-ROM drive or double-click the CD drive icon in **My Computer** to bring up the autorun screen.

**Install Video Driver and Utility** installs the video driver necessary for your card to have higher performance, resolutions, and special features. You can also install the ATI Player—a software multimedia player which provides full-screen MPEG video playback with excellent color quality, plus a host of advanced multimedia features.

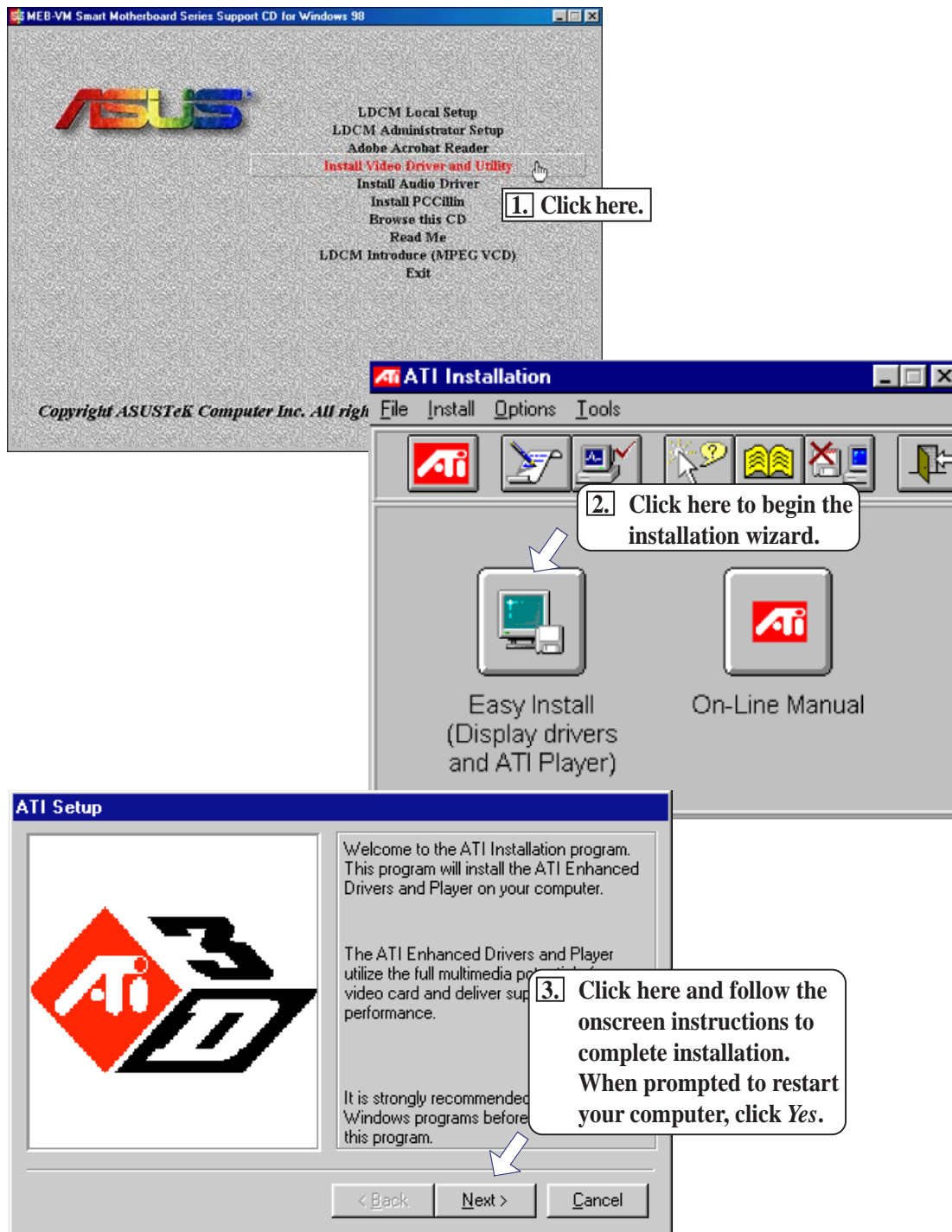

# V. SOFTWARE SETUP

## Installing the Audio Driver **CREATIVE SB AudioPCI 64V**

Insert the Support CD that came with your motherboard into your CD-ROM drive or double-click the CD drive icon in **My Computer** to bring up the autorun screen.

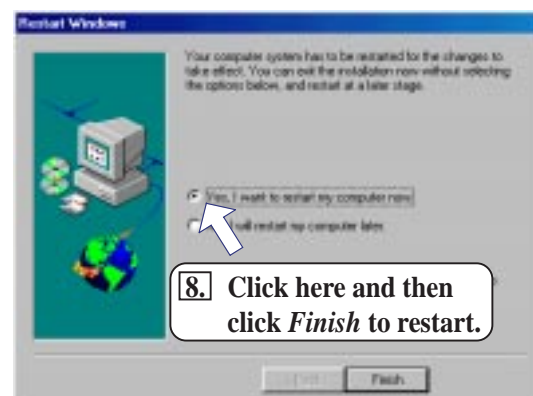
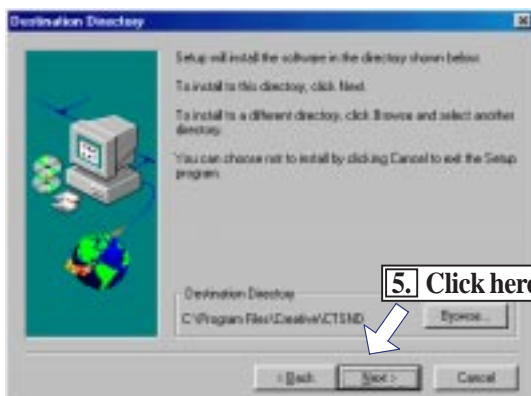

# V. SOFTWARE SETUP

## Installing PCCillin

Insert the Support CD that came with your motherboard into your CD-ROM drive or double-click the CD drive icon in **My Computer** to bring up the autorun screen.

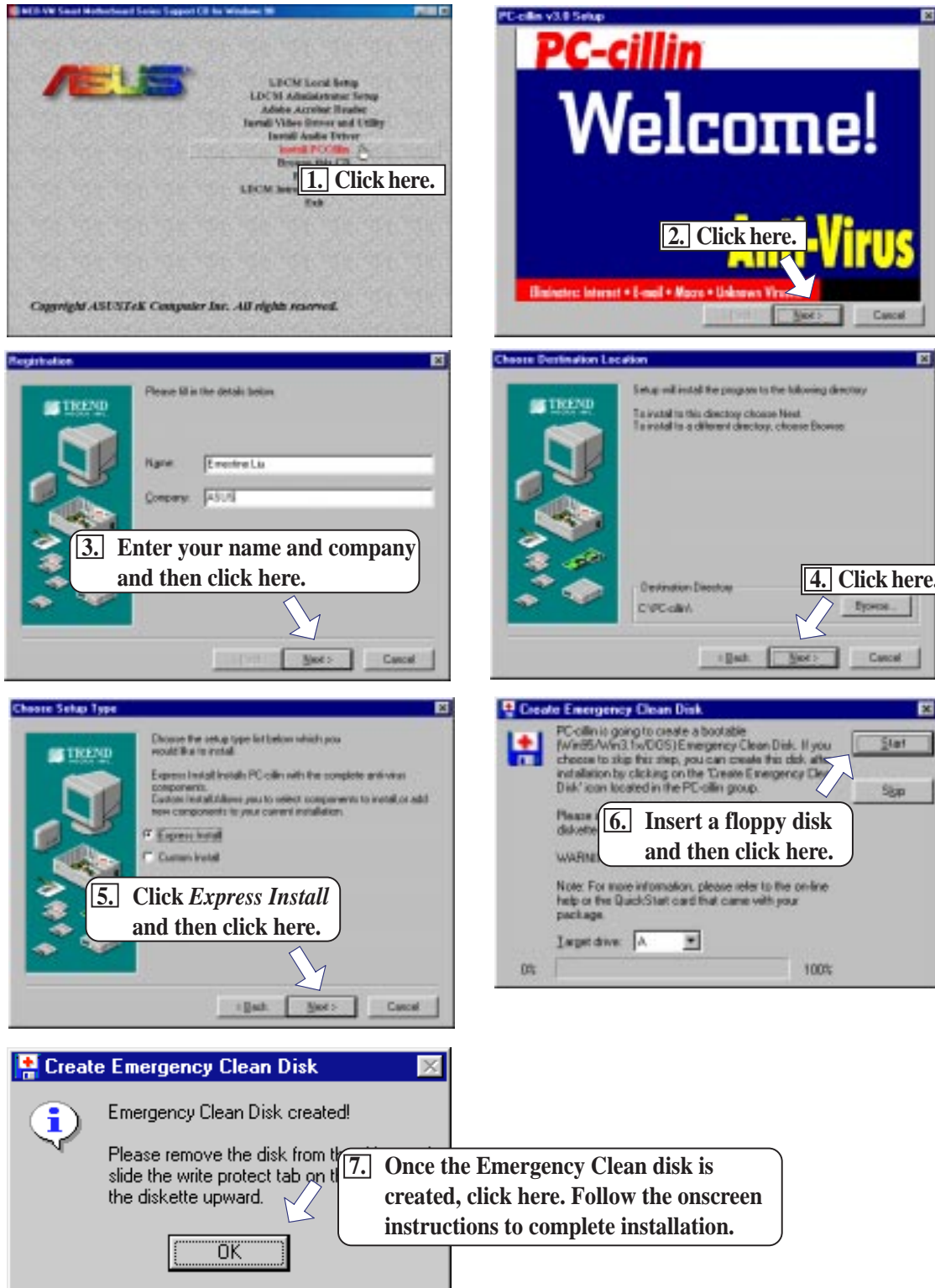

# V. SOFTWARE SETUP

## Installing Adobe Acrobat Reader

Insert the Support CD that came with your motherboard into your CD-ROM drive or double-click the CD drive icon in **My Computer** to bring up the autorun screen.

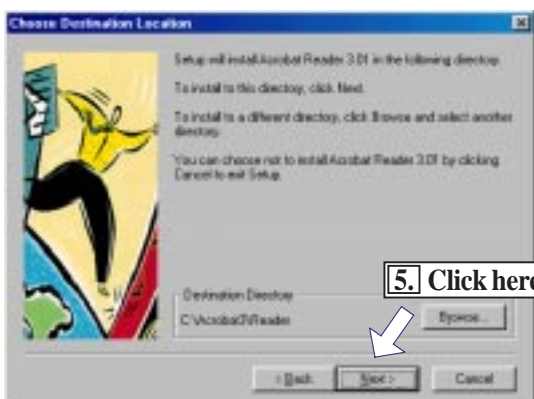
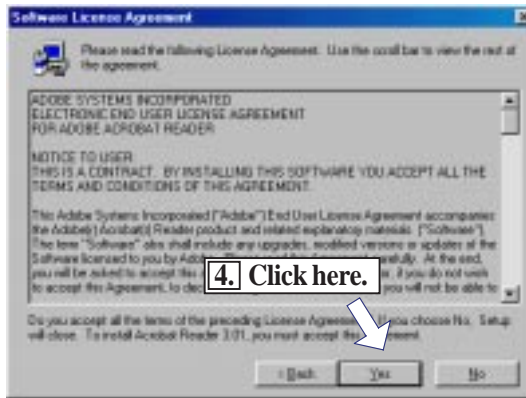
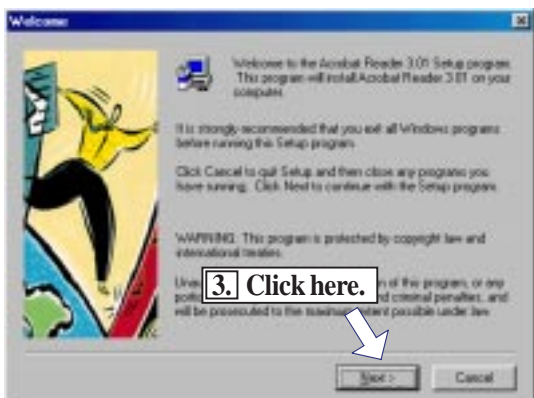
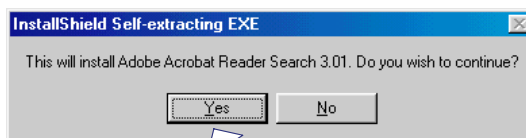



# VI. SOFTWARE REFERENCE

---

Creative Multimedia Decks .....	68
Common operations .....	68
Creative CD Player .....	69
Using the CD Playlist .....	69
Creative MIDI Player .....	70
Using the MIDI Playlist .....	70
Creative Remote .....	71
Creative Wave Player .....	72
SB AudioPCI 64V Mixer .....	73
Real-Time Effects .....	73
Creative WaveStudio .....	74
ATI Player .....	75
Features .....	75
Playing Audio CDs (Only in window 95) .....	76
Playing Media Files .....	77
Playing Interactive Discs (Video CD 2.0) .....	77
Desktop Management Interface (DMI) .....	78
Introducing the ASUS DMI Configuration Utility .....	78
Starting the ASUS DMI Configuration Utility .....	78
Using the ASUS DMI Configuration Utility .....	79
ASUS PCI-L101 Fast Ethernet Card .....	81
Features .....	82
Software Driver Support .....	82
Question and Answer .....	82

# VI. SOFTWARE REFERENCE

## Creative Multimedia Decks

Creative Multimedia Decks is a collection of players that allows you to independently or concurrently control multimedia devices such as your CD-ROM drive and MIDI device. It consists of Creative Remote and other players such as Creative CD, Creative Wave, and Creative MIDI.



### Common operations

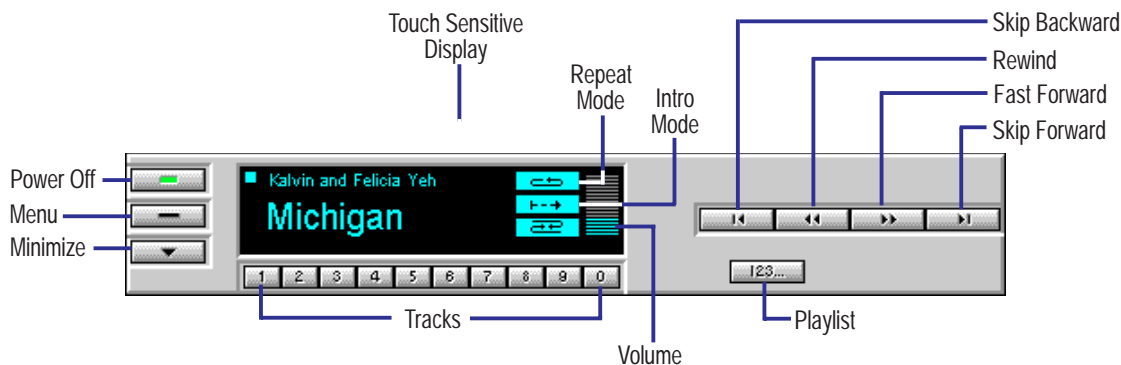

**NOTE:** The terms "track" and "file" are used interchangeably throughout this section.

# VI. SOFTWARE REFERENCE

## Creative CD Player

Creative CD operates like a home CD player, letting you play audio CDs from CD-ROM drives on your PC. In addition, it has some advanced features which include:

- Ability to be controlled by the Creative Remote
- OLE Automation support
- Plug and Play support
- Power management support
- "Touch-sensitive" display
- Multiple display forms
- Fine control of track's playing position
- Introduction Mode, Repeat Playlist Mode, Repeat Track Mode and Shuffle Mode for playback
- Playlist compilation of CD tracks into a collection
- Fast track selection
- Direct volume control for multiple sound cards

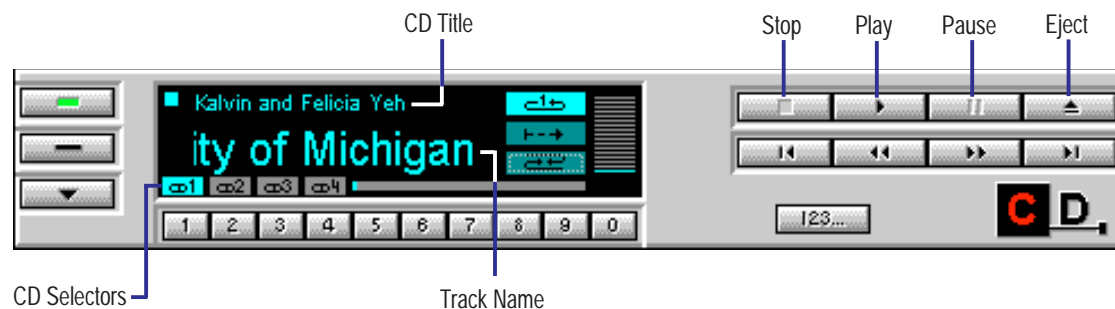

## Using the CD Playlist

To access the Playlist dialog box, click **123...** on the CD player.

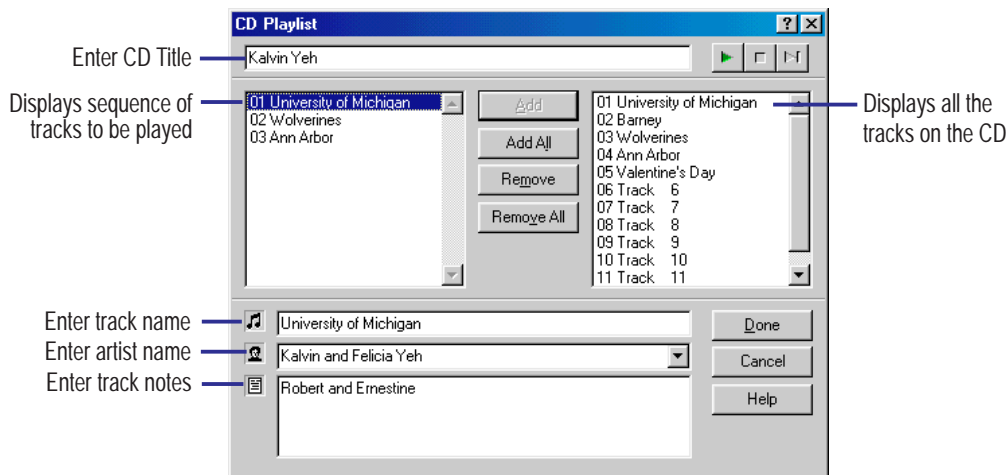

# VI. SOFTWARE REFERENCE

## Creative MIDI Player

Creative MIDI is the player in the Multimedia Decks suite of players that lets you play MIDI files. It also has some advanced features which include:

- Ability to be controlled by the Creative Remote
- OLE Automation support
- Plug and Play support
- Power management support
- "Touch-sensitive" display
- Multiple display forms
- Fine control of a track's playing position
- Introduction Mode, Repeat Playlist Mode, Repeat Track Mode and Shuffle Mode for playback
- Playlist compilation of different MIDI files
- Fast track selection
- Direct volume control for multiple sound cards



### Using the MIDI Playlist

To access the Playlist dialog box, click **123...** on the MIDI player.

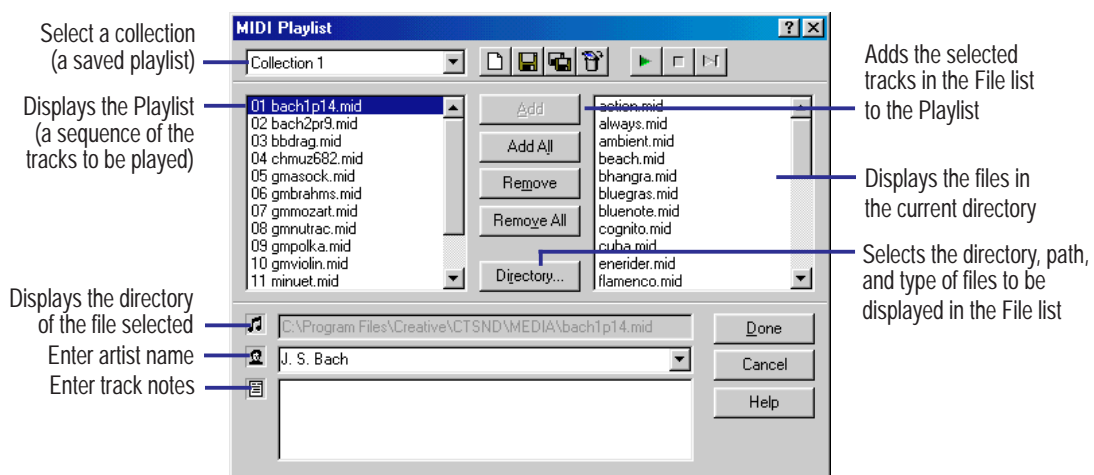

# VI. SOFTWARE REFERENCE

## Creative Remote

Creative Remote is the main component of the Creative Multimedia Decks group of players. Like a home remote control, it lets you control different Creative Multimedia Decks players from a single control interface. If you require more control over a player, you can also invoke the player from Creative Remote.

In addition, it consists of several advanced features like:

- Ability to launch any of the available Creative Multimedia Decks players for more direct control over a device
- "Touch-sensitive" display
- Multiple display forms
- Fast track selection
- Color scheme selection

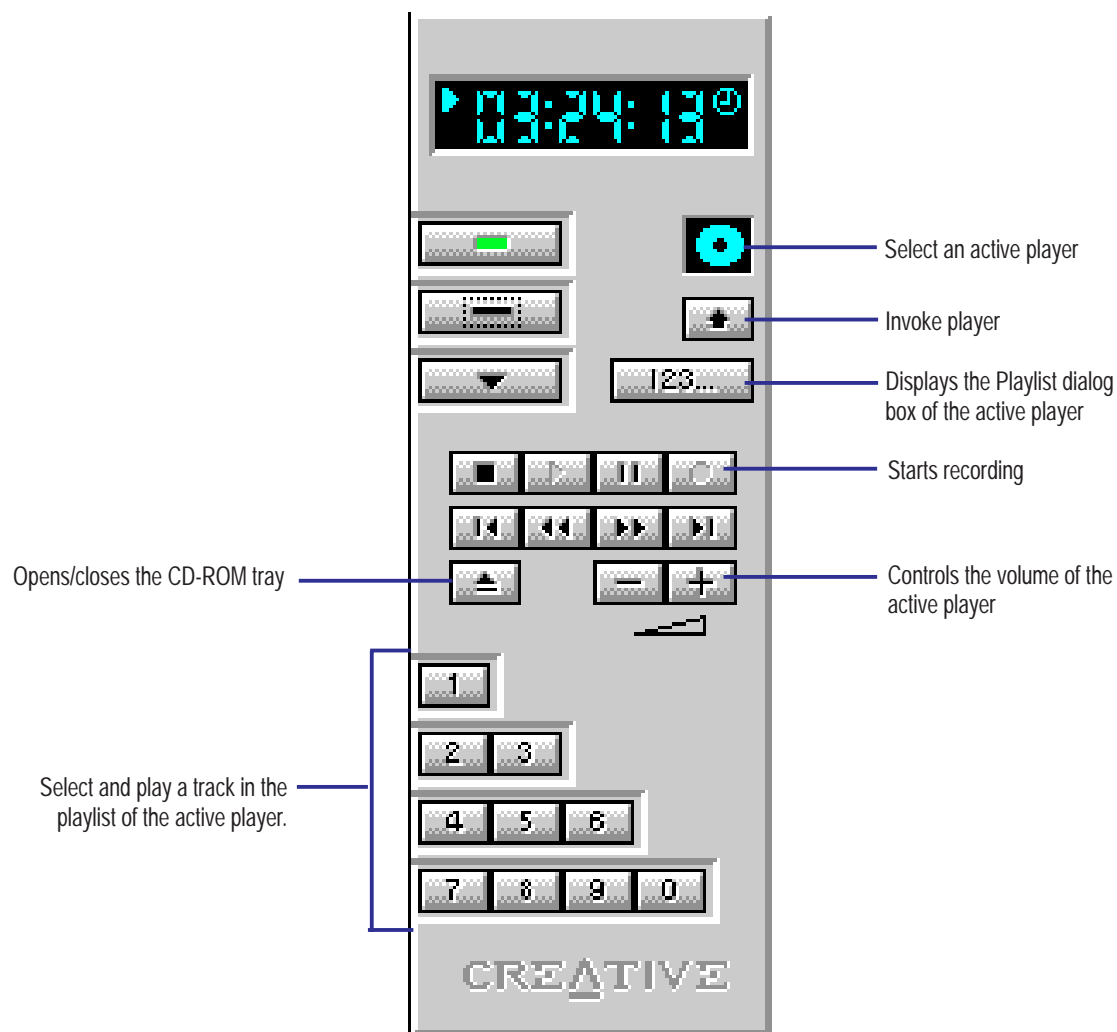

# VI. SOFTWARE REFERENCE

## Creative Wave Player

Creative Wave is the player in the Creative Multimedia Decks suite of players that lets you play wave files. It also has some advanced features which include:

- Ability to be controlled by the Creative Remote
- OLE Automation support
- Plug and Play support
- Power management support
- "Touch-sensitive" display
- Multiple display forms
- Fine control of a track's playing position
- Introduction Mode, Repeat Playlist Mode, Repeat Track Mode and Shuffle Mode for playback
- Playlist compilation of different wave files
- Fast track selection
- Direct volume control for multiple sound cards



Activates the Record Setting dialog box which allows you to select the format of the wave file to record.

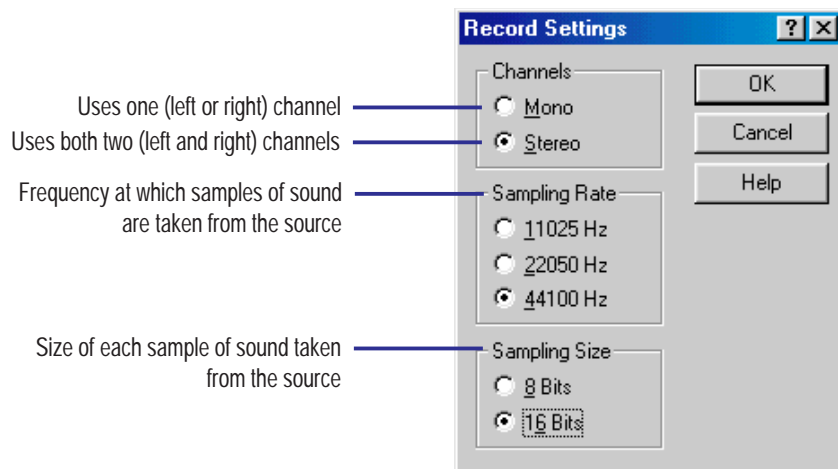

# VI. SOFTWARE REFERENCE

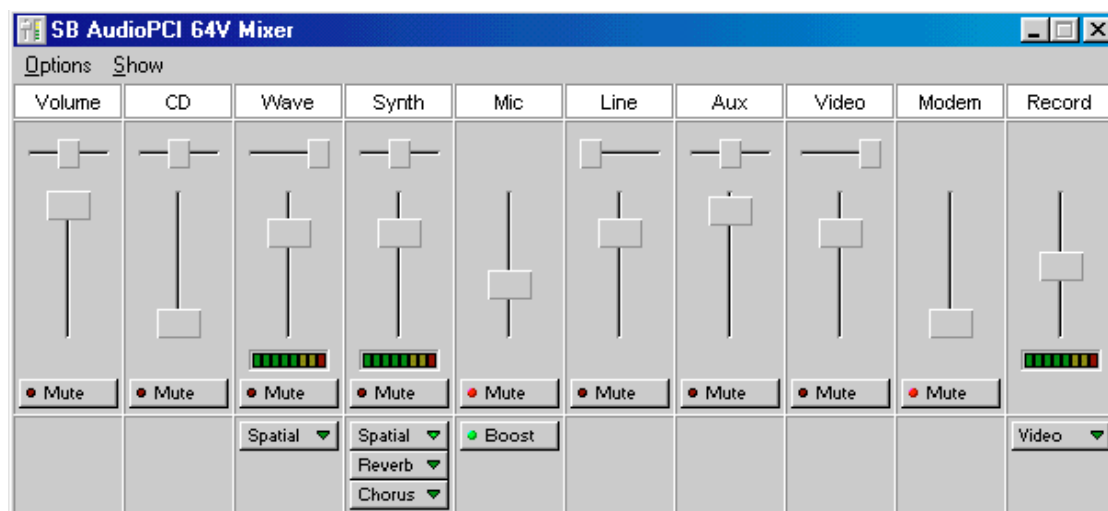

## SB AudioPCI 64V Mixer

A mixer has been included for Sound Blaster AudioPCI 64V. This mixer accommodates some features found on the AudioPCI card. These features are unavailable through the Windows 95/98 mixer.



### Real-Time Effects

AudioPCI supports real-time effects. In addition to the effects described below, more effects may be available in the future.

-  This effect provides a surround-sound effect. There is a drop-down box on the device panel that will allow you to switch between the three different spatial presets: Off, On, and Wide. By default this switch is set to Off.
-  The reverb effect will make the MIDI instruments on the card sound as if they were playing in a large concert hall or stadium. The three degrees of reverb provided are Off, On, and Full. This effect can be applied to the Synthesizer device.
-  The chorus effect will add depth to the card's synthesizer sounds. The three settings for chorus are Off, On, and Full. This effect can be applied to the Synthesizer device. **NOTE:** Chorus is a special effect, which should be used with discretion; it is generally not recommended to leave the chorus effect enabled at all times.

# VI. SOFTWARE REFERENCE

## Creative WaveStudio

WaveStudio is a Windows-based application that allows you to perform the following sound editing functions easily:

- Play, edit, and record 8-bit (tape quality) and 16-bit (CD quality) wave data.
- Enhance your wave data or create unique sounds with various special effects and editing operations such as rap, reverse, echo, mute, pan, cut, copy, and paste.
- Open and edit several wave files at the same time.
- Import and export raw (.RAW) data files.

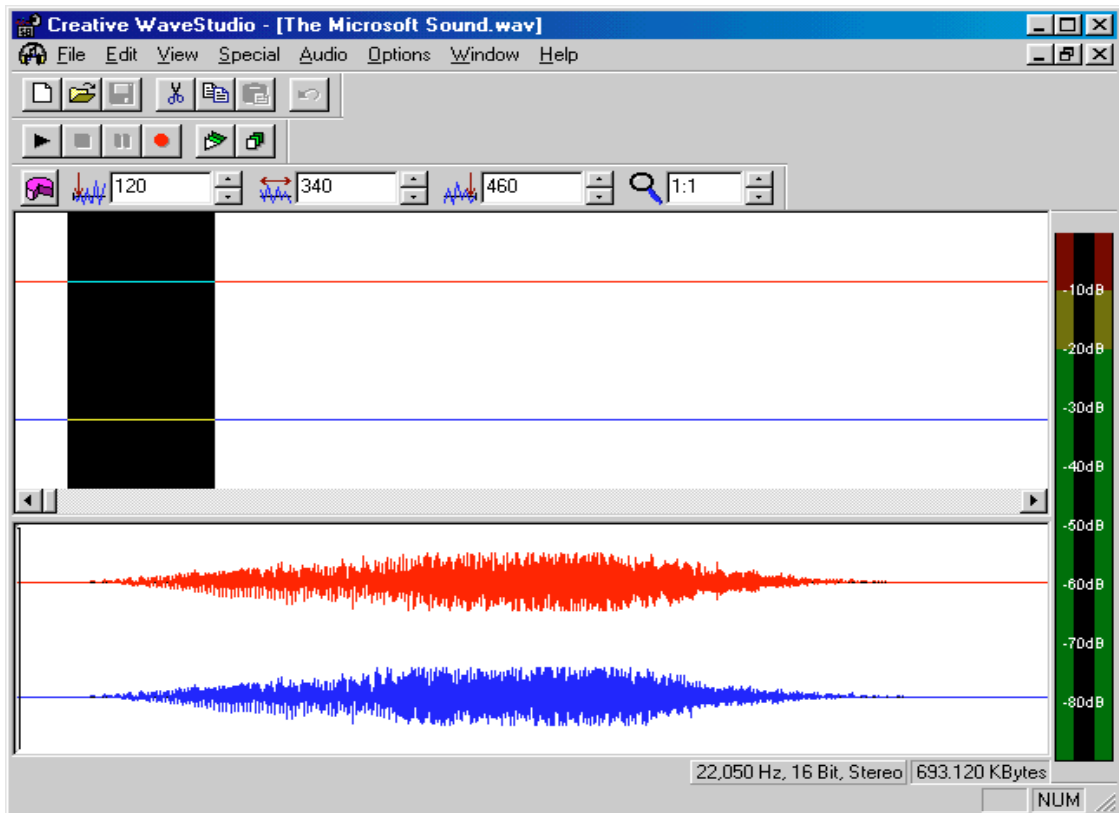



# VI. SOFTWARE REFERENCE

## ATI Player

### ATI Player and control panel (Windows 95/98)

If VIDEO drivers are installed, for playing video clips, the ATI Player icon will appear in the DeskTop. Double click on this icon to bring up the Video Screen as shown here: (Detailed button definitions are shown when holding the cursor over the individual buttons for a few seconds.)

### The Task Control Panel

The Task control panel indicates what mode the player is in and what it's doing. (Your Task control panel may not look exactly like the illustration-only installed or available features will have controls.)

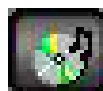
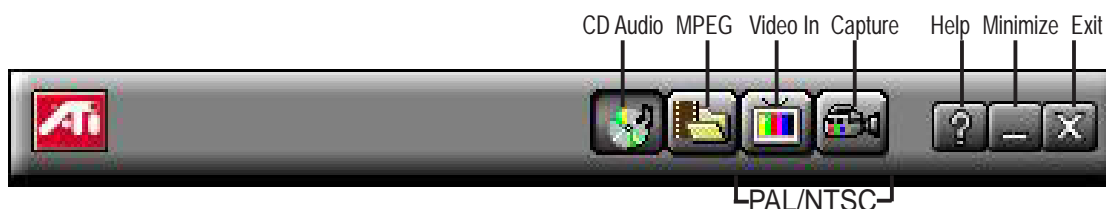

**CD Audio**—Play standard audio CDs (only in Windows 95/98)



**MPEG Playback**—Play MPEG and AVI video files



**Video In** (Tuner button)—Display live video sources (available only on video model)



**Capture**—Capture still images, video sequences, or audio-only (available only on video model)

## Features

The question mark on top right of the Video Screen allows inspection into each button on the control panel. Click on the “?” then on a button that you would like to know about.

# VI. SOFTWARE REFERENCE

## Playing Audio CDs (Only in window 95)



Click the Audio CD button in the Task control panel to switch to Audio CD mode



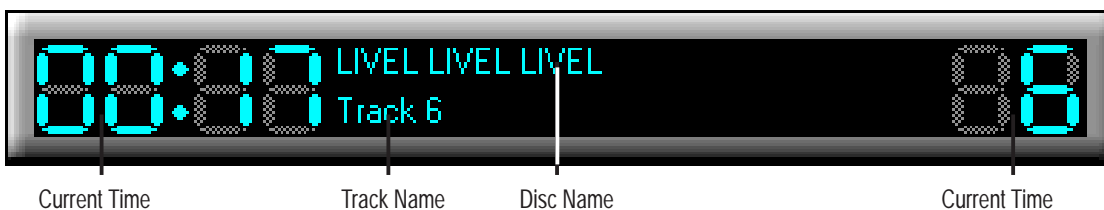

The Audio CD player has its own control panel for controlling the audio CD playback. You can use the Audio CD panel to play standard audio CDs. Advanced features such as Random play, Intro play, which plays the first ten seconds of each track, and Loop play are available.



The Audio CD player has its own display.

### To play an audio CD

1. Insert the audio CD into your CD-ROM drive.
2. In the Audio CD panel, click the **Setup Dialogs** button .
3. Click the **Disc Info** tab.
4. From the *Available Tracks* list, add or remove tracks as desired. The Play List displays your current selections.
5. Click **OK**.
6. In the Audio CD panel, click the **Play** button .

The Audio CD player uses Windows 95 standard INI file to store disc names, track names, and the play list. You can use the Setup dialog to enter the name of the artist and the disc.

# VI. SOFTWARE REFERENCE

## Playing Media Files



Click the MPEG Playback button in the Task control panel to switch to playback mode.



The Control panel changes to the Playback panel.

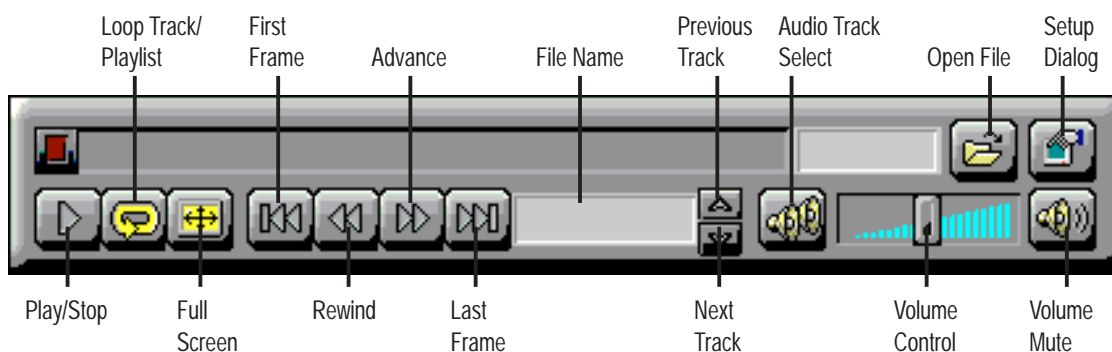

To view/hide the Playback panel in Full Screen mode, press F2.



You can use the Media Playback panel to play the following media files:

- MPEG-1 digital audio and video, including Karaoke?including dual-channel audio, CDi, Games, and reference application titles
- \*.AVI video files

### To play a file

1. In the Playback panel, click the **File Open** button .
2. Select a file from the list.
3. Click **Add**, then click **OK**.
4. Click the **Play** button .
5. The file plays in the Display panel.

### Playing Interactive Discs (Video CD 2.0)

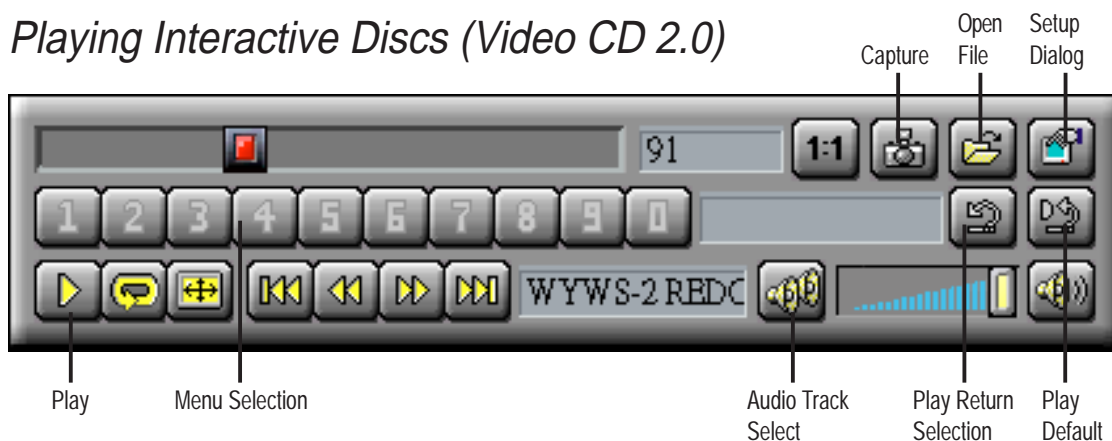

When playing Video CD 2.0 discs, the Control panel changes to this interactive panel.

# VI. SOFTWARE REFERENCE

---

## Desktop Management Interface (DMI)

### *Introducing the ASUS DMI Configuration Utility*

This motherboard supports DMI within the BIOS level and provides a DMI Configuration Utility to maintain the Management Information Format Database (MIFD). DMI is able to auto-detect and record information pertinent to a computer's system such as the CPU type, CPU speed, and internal/external frequencies, and memory size. The onboard BIOS will detect as many system information as possible and store those collected information in a 4KB block in the motherboard's Flash EPROM and allow the DMI to retrieve data from this database. Unlike other BIOS software, the BIOS on this motherboard uses the same technology implemented for Plug and Play to allow dynamic real-time updating of DMI information versus creating a new BIOS image file and requiring the user to update the whole BIOS. This DMI Configuration Utility also allows the system integrator or end user to add additional information into the MIFD such as serial numbers, housing configurations, and vendor information. Those information not detected by the motherboard BIOS and has to be manually entered through the DMI Configuration Utility and updated into the MIFD. This DMI Configuration Utility provides the same reliability as PnP updating and will prevent the refreshing failures associated with updating the entire BIOS.

### *Starting the ASUS DMI Configuration Utility*

The DMI Configuration Utility (DMICFG2.EXE) must be used in real mode in order for the program to run, the base memory must be at least 180K. Memory managers like HIMEM.SYS (required by windows) must not be installed. You can boot up from a system diskette without AUTOEXEC.BAT and CONFIG.SYS files, "REM" HIMEM.SYS in the CONFIG.SYS, or press <Shift>+<F5> during bootup to bypass your AUTOEXEC.BAT and CONFIG.SYS files.

1. In Windows, copy DMICFG.EXE to your hard disk drive.
2. Restart your computer and press <Shift>+<F5> during bootup to enter safe mode command prompt.
3. Go to the directory containing DMICFG.EXE.
4. Type DMICFG and press <Enter> to run.

# VI. SOFTWARE REFERENCE

## Using the ASUS DMI Configuration Utility

**NOTE:** The following screen displays are provided as examples only and may not reflect the screen contents on your system.

### Edit DMI (or delete)



Use the ←→ (left-right) cursors to move the top menu items and the ↑↓ (up-down) cursor to move between the left hand menu items. The bottom of the screen will show the available keys for each screen. Press enter at the menu item to enter the right hand screen for editing. “Edit component” appears on top. The reversed color field is the current cursor position and the blue text are available for editing. The orange text shows auto-detected information and are not available for editing. The blue text “Press [ENTER] for detail” contains a second pop-up menu is available, use the + - (plus-minus) keys to change the settings. Enter to exit *and save*, ESC to exit *and not save*.

If the user has made changes, ESC will prompt you to answer Y or N. Enter Y to go back to the left-hand screen *and save*, enter N to go back to left-hand screen and *not save*. If editing has not been made, ESC will send you back to the left hand menu without any messages.

### Notes

A heading, \*\*\* BIOS Auto Detect \*\*\*, appears on the right for each menu item on the left side that has been auto detected by the system BIOS.

A heading, \*\*\* User Modified \*\*\*, will appear on the right for menu items that have been modified by the user.



# VI. SOFTWARE REFERENCE

## Save MIFD



You can save the MIFD (normally only saved to flash ROM) to a file by entering the drive and path here. If you want to cancel save, you may press ESC and a message “Bad File Name” appears here to show it was not saved.

## Load MIFD



You can load the disk file to memory by entering a drive and path and file name here.

## Load BIOS Defaults



You can load the BIOS defaults from a MIFD file and can clear all user modified and added data. You must reboot your computer in order for the defaults to be saved back into the Flash BIOS.

# APPENDIX

## ASUS PCI-L101 Fast Ethernet Card

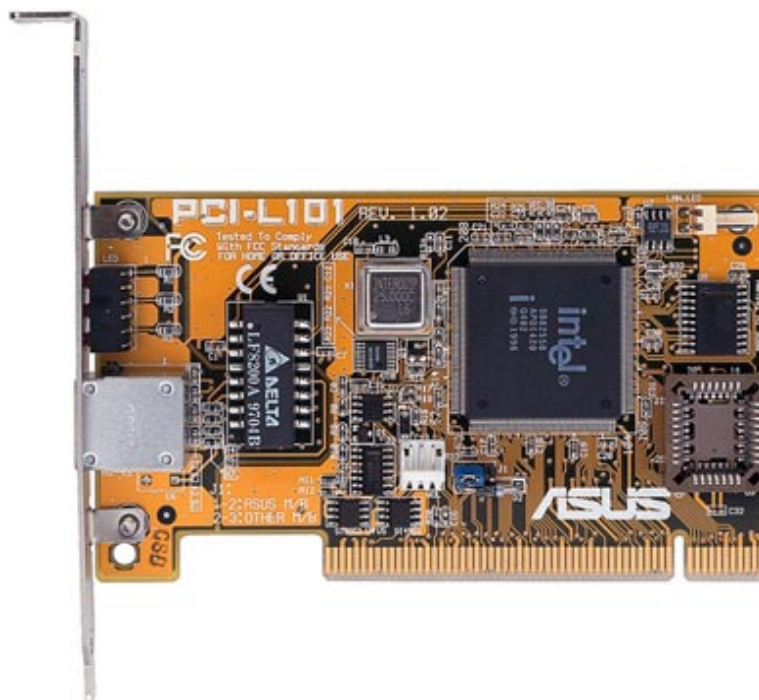

APPENDIX  
ASUS LAN Card

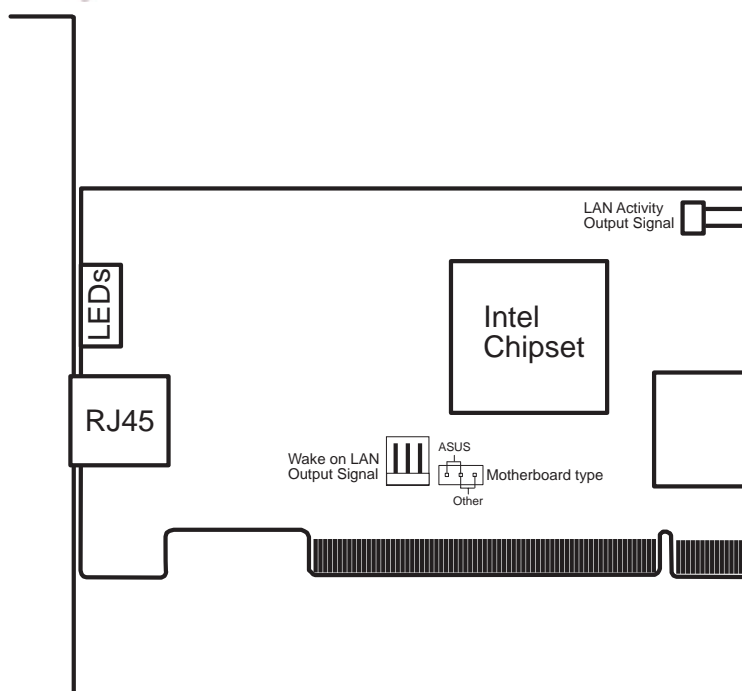

If you are using the ASUS PCI-L101 on an ASUS motherboard, leave the jumper on its default setting of “ASUS.” If you are using another brand of motherboard, set the jumper to “Other.” Connect the Wake on LAN (WOL) output signal to the motherboard’s WOL\_CON in order to utilize the wake on LAN feature of the motherboard. Connect the LAN activity output signal (LAN\_LED) to the system cabinet’s front panel LAN\_LED in order to display the LAN data activity.

# APPENDIX

---

## Features

- Intel 82558 Ethernet LAN Controller (Fully integrated 10BASE-T/100BASE-TX)
- Wake-On-LAN Remote Control Function Supported
- PCI Bus Master Complies to PCI Local Bus Rev. 2.1 specifications
- Consists of MAC & PHY (10/100Mbps) interfaces
- Complies to IEEE 802.3 10BASE-T and IEEE 802.3u 100BASE-TX interfaces
- Fully supports 10BASE-T & 100BASE-TX operations through a single RJ45 port
- Supports 32-bit Bus Master Technology / PCI Rev. 2.1
- Enhancements on ACPI & APM
- Adheres to PCI Bus Power Management Interface Rev. 1.0, ACPI Rev. 1.0, and Device Class Power Management Rev. 1.0
- IEEE 802.3u auto-negotiation for 10Mbps/100Mbps Network Data Transfer Rates.
- Provides LED indicators for monitoring network conditions
- Plug and Play

## Software Driver Support

- **NetWare ODI Drivers** - Novell Netware 3.x, 4.x, DOS, OS/2 Client
- **NDIS 2.01 Drivers** - Microsoft LAN Manager, Microsoft Windows 3.11, IBM LAN Server
- **NDIS 3.0 Drivers** - Microsoft Windows NT, Microsoft Windows 95, Microsoft Windows 3.11

## Question and Answer

Q: What is Wake-On-LAN ?

A: The Wake-On-LAN feature provides the capability to remotely power on systems supporting Wake-On-LAN by simply sending a wake-up frame. With this feature, remotely uploading/downloading data to/from systems during off-peak hours will be feasible.

Q: What can Wake-On-LAN do for you ?

A: Wake-On-LAN is a remote management tool with advantages that can reduce system management workload, provide flexibility to the system administrator's job, and then of course save you time-consuming efforts and costs.

Q: What components does Wake-On-LAN require to be enable?

A: To enable Wake-On-LAN function, your system requires Ethernet LAN adapter card that can activate Wake-On-LAN function, a client with Wake-On-LAN capability, and software such as LDCM Rev. 3.10 or up that can trigger wake-up frame.



## Free Manuals Download Website

<http://myh66.com>

<http://usermanuals.us>

<http://www.somanuals.com>

<http://www.4manuals.cc>

<http://www.manual-lib.com>

<http://www.404manual.com>

<http://www.luxmanual.com>

<http://aubethermostatmanual.com>

Golf course search by state

<http://golfingnear.com>

Email search by domain

<http://emailbydomain.com>

Auto manuals search

<http://auto.somanuals.com>

TV manuals search

<http://tv.somanuals.com>