

American DJ®

Color 150/RG™



User Instructions

American DJ
4295 Charter Street
Los Angeles Ca. 90058
www.americandj.com

Revised 8/01

Color 150/RG™

General Information

Unpacking: Thank you for purchasing the Color 150/RG™ by American DJ®. Every Color 150/RG™ has been thoroughly tested and has been shipped in perfect operating condition. Carefully check the shipping carton for damage that may have occurred during shipping. If the carton appears to be damaged, carefully inspect your fixture for any damage and be sure all accessories necessary to operate the unit have arrived intact. In the event damage has been found or parts are missing, please contact our toll free customer support number for further instructions. Please, do not return this unit to your dealer without first contacting customer support.

Introduction: The Color 150/RG™ is an intelligent fixture that can run in DMX mode, as a stand alone sound active piece, or in a Master/Slave configuration. The Color 150/RG™ comes with several built-in programs and is best used in multiples of four. This unit uses a separate color and gobo wheel. This piece is best used with a fog or haze machine to enhance the beam output. The Color 150/RG™ comes with two changeable gobos. This unit will take custom gobos (26mm - 22mm viewable). An optional *MINI/C* blackout controller may be purchased separately.

Customer Support: American DJ® provides a toll free customer support line, to provide set up help and to answer any question should you encounter problems during your set up or initial operation. You may also visit us on the web at www.americandj.com for any comments or suggestions. Service Hours are Monday through Friday 9:00 a.m. to 5:00 p.m. Pacific Standard Time.

Voice: (800) 322-6337

Fax: (323) 582-2610

E-mail: support@americandj.com

Warning! To prevent or reduce the risk of electrical shock or fire, do not expose this unit to rain or moisture.

Caution! There are no user serviceable parts inside this unit. Do not attempt any repairs yourself, doing so will void your manufacturer's warranty. In the unlikely event your unit may require service please contact American DJ® customer support.

Please do not discard the shipping carton in the trash, recycle whenever possible.

©American DJ Supply® - www.americandj.com - Color 150/RG™ Instruction Manual Page 2

Color 150/RG™**General Instructions**

To optimize the performance of this product, please read these operating instructions carefully to familiarize yourself with the basic operations of this unit. These instructions contain important safety information regarding the use and maintenance of this unit. Please keep this manual with the unit, for future reference.

Color 150/RG™**Safety Precautions**

- This unit may blow a fuse if the maximum allotted load of 3 amps is reached. If the fuse needs replacement, always replace the fuse with same exact type that was removed. Use of a different type fuse from that which is recommended may cause fire or electric shock and will void the manufacturer's warranty
- To reduce the risk of electrical shock or fire, do not expose this unit to rain or moisture
- Do not spill water or other liquids into or on to your unit
- Be sure that the local power outlet matches that of the required voltage for your unit
- Do not attempt to operate this unit if the power cord has been frayed or broken
- Do not attempt to remove or break off the ground prong from the electrical cord. This prong is used to reduce the risk of electrical shock and fire in case of an internal short
- Disconnect from main power before making any type of connection
- Do not remove the cover under any conditions. There are no user serviceable parts inside
- Never operate this unit when its cover is removed
- Never plug this unit into a dimmer pack
- Always be sure to mount this unit in an area that will allow proper ventilation. Allow about 6" (15cm) between this device and a wall
- Do not attempt to operate this unit, if it becomes damaged
- This unit is intended for indoor use only, use of this product outdoors voids all warranties
- During long periods of non-use, disconnect the unit's main power
- Always mount this unit in a safe and stable manner
- Power cords should be routed so they are not likely to be walked on, pinched by items placed upon or against them.
- Cleaning -The fixture should be cleaned only as recommended by the manufacturer. See page 7 for cleaning details

Color 150/RG™**Safety Precautions**

- Heat -The appliance should be situated away from heat sources such as radiators, heat registers, stoves, or other appliances (including amplifiers) that produce heat.
- The fixture should be serviced by qualified service personnel when:
 - A. The power-supply cord or the plug has been damaged.
 - B. Objects have fallen, or liquid has been spilled into the unit.
 - C. The unit has been exposed to rain or water.
 - D. The unit does not appear to operate normally or exhibits a marked change in performance.

Color 150/RG™**Features**

- Micro-Stepping Motors for Smooth Color and Gobo Transitions
- 100% Dimmable
- DMX-512 Protocol Compatible
- Uses Three DMX Channels
- Full Focusing
- Fan Cooled
- Continuous Rotating Gobos
- 2 Changeable Gobos Plus Spot - (26mm Gobos - 20mm viewable)
- Seven Colors, plus White
- Master/Slave Operation
- Sound-Active
- Quick Change Gobo Slot
- Internal Microphone
- Volume Sensitivity Knob
- Easy Lamp Replacement
- Long Life ZB-JCR H5 (15v/150w) Lamp - 500 Hours
- Optional MINI/C Blackout Controller

Color 150/RG™**Product Registration**

The Color 150/RG™ carries a one year (365 days) limited warranty. Please fill out the enclosed warranty card to validate your purchase. All returned service items whether under warranty or not, must be freight pre-paid and accompany a return authorization (R.A.) number. If the unit is under warranty, you must provide a copy of your proof of purchase invoice. Please contact American DJ® customer support for a R.A. number.

REAR PANEL

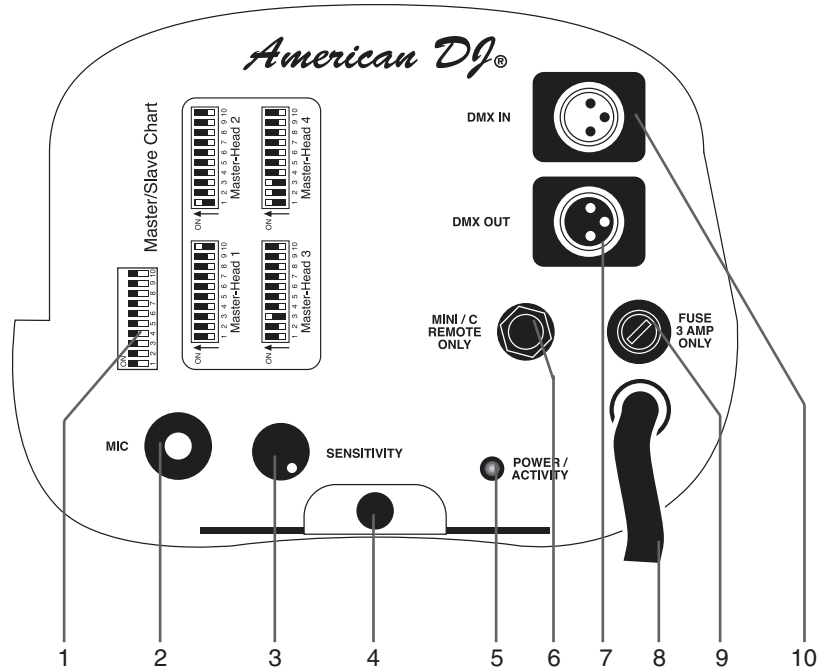

BOTTOM PANEL

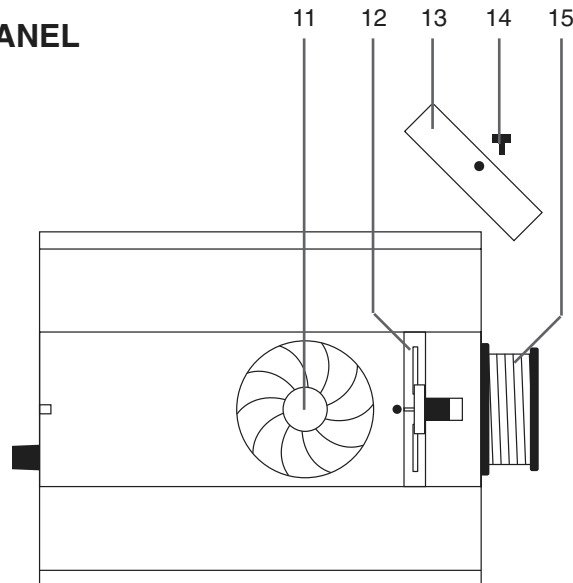

1. Dip Switches - These switches serve two functions. In master slave mode these switches are used to assign a specific head address. In DMX mode these switches are used to assign a DMX address to the unit. In DMX mode each switch corresponds to a specific value based on binary code. See page 7 for a detailed explanation of DMX binary code.

2. Microphone - This microphone receives external low frequencies to trigger the unit in Sound-Active and Master/Slave mode.

3. Audio Sensitivity Knob - This adjust audio sensitivity of the internal microphone (5). Turning the sensitivity knob in the clockwise direction will increase the sensitivity to sound. Turning the knob in the counter clockwise direction will decrease the fixture's sensitivity to sound.

4. Gobo Replacement Thumb Screw - See page 14 for Gobo replacement.

5. Power Indicator - This LED will flash when it receives either an audio or DMX signal.

6. MINI/C Controller Jack - This jack is for use with the optional MINI/C Blackout controller only. *Do not attempt to connect an audio signal this jack, this will damage the PC board and void your manufactures warranty!*

7. XLR Output Jack - This jack is used to transmit the incoming DMX signal to another DMX fixture, or transmit a Master/Slave signal to the next Color 150/RG™ in the chain. For best results in DMX or Master/Slave mode terminate this jack if it is the last unit in the chain. See "Terminator" on page 7.

8. Power Cord - Connect only to a matching power outlet. Never use this fixture is the ground prong has been removed or broken off.

9. Fuse Holder - This housing stores the 3 amp GMA protective fuse. Always replace with the exact same type fuse, unless other wise instructed, by an authorized American DJ® service technician.

10. XLR Input Jack - This jack is used to accept an incoming DMX signal or Master/Slave signal.

11. Cooling Fan - This fan is used to keep the unit operating at a cooler temperature. Keep the fan grill clean. Never block the grill, improper cooling may result in premature lamp failure.

12. Gobo Wheel - This wheel holds the two replaceable rotating gobos. The gobos are 26mm (20mm viewable). For list of stock replaceable gobos contact customer support or visit us on the web. Custom gobos may be order through customer support. Please contact customer support for a quote on all custom gobos.

13. Gobo Wheel Cover - This protective cover shields the gobo wheel. To access and change the gobos remove this cover.

14. Gobo Wheel Cover Retaining Thumb Screw - This thumb screw retains the gobo wheel cover. To access the gobo wheel remove this screw and the gobo wheel cover.

15. Fully Focusing Lens - This is high quality lens that is fully focusing. To focus this lens, turn the lens in clockwise and counter-clockwise direction until you achieve proper focus.

Note: Stand-Alone and Master-Slave operation require sound to activate! The units will blackout in this mode to conserve bulb life when there is no sound present.

Stand-Alone Operation (Sound Active): This function allows a single unit to run to the beat of the music. Only use this function when running a single unit, or when running several units as individuals.

1. To activate the Sound-Active mode, set dip switch 10, on the rear of unit to the ON position (See “Master Unit” on the DIP SWITCH chart on page 15).
2. The unit will now react to the low frequencies of music via the internal microphone.
3. Adjust the audio sensitivity knob on the rear of the unit to make the unit more or less sensitive to sound. Turning the sensitivity knob in the clockwise direction will increase the sensitivity, turning the knob in the counter-clockwise direction will decrease the fixture’s sensitivity to sound.
4. The optional *MINI/C Blackout Controller* may be used with this function. This controller is used for blackout function only.

Master-Slave Operation (Sound Active): This function will allow

you to link up to 16 units together and operate without a controller. The units will be sound activated. In Master-Slave operation one unit will act as the controlling unit and the others will react to the controlling units programs. Any unit can act as a Master or as a Slave.

1. Using standard XLR microphone cables, daisy chain your units together via the XLR connectors on the rear of the units. Remember the Male XLR connector is the input and the Female XLR is the output. The first unit in the chain (master) will use the female XLR connector only. For longer cable runs we suggest a terminator at the last fixture. Refer to the set-up procedures beginning on page 10.
2. Follow the Master-Slave dip-switch chart on page 16 for proper dip-switch settings.
3. The optional *MINI/C Blackout Controller* may be used in this operation mode to control the blackout.
4. After all the units settings have been set and are plugged in, adjust the sensitivity knob on the rear of the master unit to make them react to sound.
5. Several unit may share the same slave setting as long as there are no more than 16 units in a Master-Slave configuration, however only one unit may have the “Master - Head 1” dip switch setting.

Linking: Your fixture comes with several built-in programs. These programs are designed to work with up to 16 units when daisy-chained together in a master-slave configuration. Any unit can function as either a “Master Unit” or a “Slave Unit.” Link the units together using standard DMX cable.

Master/Slave Linking:

For a more dramatic effect, link several Color units together.

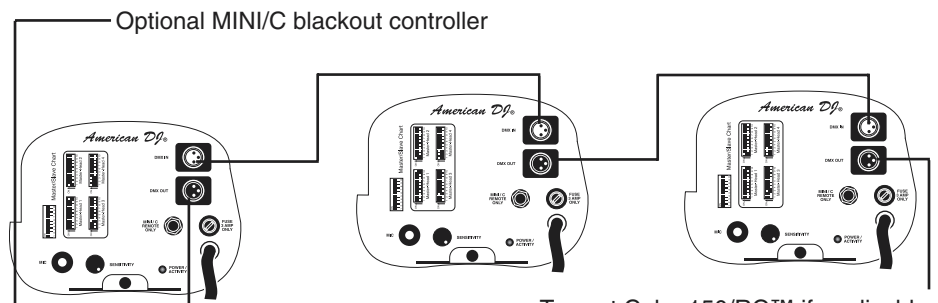

Universal DMX Control: This function allows you to use a universal DMX 512 controller such as the American DJ® DMX Operator™ or Show Designer™ to control lamp intensity, color, and gobo. Operating through a DMX controller allows the freedom to create unique programs tailored to one’s individual needs.

1. The Color 150/RG™ uses three DMX channels. Channel one controls the lamp intensity (dimmer), channel two controls the color selection, and channel three control the gobo wheel. Please refer to page 15 for a detailed description of the DMX traits.
2. To control your fixture in DMX mode, follow the unit set-up procedures beginning on page 10 as well as the set-up specifications that are included with your DMX controller.
3. Use the controller’s faders to control the various DMX fixture traits.
4. This will allow you to create custom programs.
5. When using a DMX controller and setting up for DMX operation follow the dip switch settings on page 15.
6. For help operating in DMX operation consult the manual included with your DMX controller.
7. For longer cable runs (more than a 100 feet) use a terminator on the last fixture in you DMX chain.

DMX Linking:

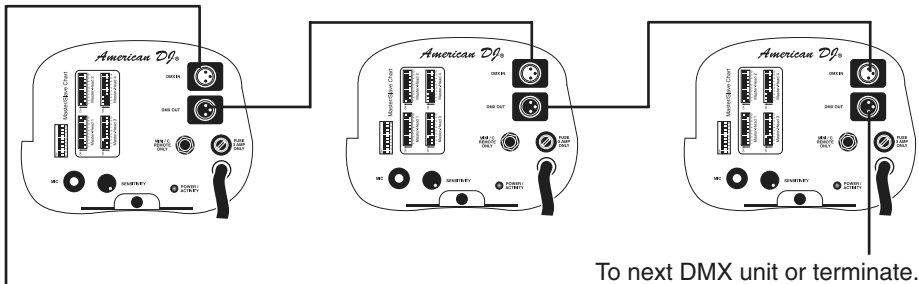

Power Supply: Before plugging your unit in, be sure the source voltage in your area matches the required voltage for your American DJ® Color 150/RG.™ Because line voltage may vary from venue to venue, you should be sure your unit voltage matches the wall outlet voltage before attempting to operate you fixture.

DMX-512: DMX is short for Digital Multiplex. This is a universal protocol used as a form of communication between intelligent fixtures and controllers. A DMX controller sends DMX data instructions from the controller to the fixture. DMX data is sent as serial data that travels from fixture to fixture via the DATA “IN” and DATA “OUT” XLR terminals located on all DMX fixtures (most controllers only have a DATA “OUT” terminal).

DMX Linking: DMX is a language allowing all makes and models of different manufactures to be linked together and operate from a single controller, as long as all fixtures and the controller are DMX compliant. To ensure proper DMX data transmission, when using several DMX fixtures try to use the shortest cable path possible. The order in which fixtures are connected in a DMX line does not influence the DMX addressing. For example; a fixture assigned a DMX address of 1 may be placed anywhere in a DMX line, at the beginning, at the end, or anywhere in the middle. When a fixture is assigned a DMX address of 1, the DMX controller knows to send DATA assigned to address 1 to that unit, no matter where it is located in the DMX chain.

Dip-switches in DMX mode: This unit uses dip switches to assign a DMX address. Each dip switch represents a binary value.

- Dip Switch 1 address equals 1
- Dip Switch 2 address equals 2
- Dip Switch 3 address equals 4
- Dip Switch 4 address equals 8
- Dip Switch 5 address equals 16
- Dip Switch 6 address equals 32
- Dip Switch 7 address equals 64
- Dip Switch 8 address equals 128
- Dip Switch 9 address equals 256

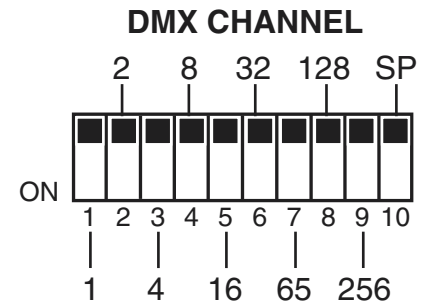

Each dip switch has a preset value. A specific DMX address is set by combining the dip switches that sum your desired value. For example:

To achieve a DMX address of 21, combine dip switches 1, 3, and 5. Sense dip switch 1 has a value of 1, dip switch 3 has a value of 4, and dip switch 5 has a value of 16, the combination of the create a DMX value of 21.

Set DMX address 21:
 Dip-switches # 1 = 1
 3 = 4
 5 = 16
 = 21

Set DMX address 201:
 Dip-switches # 1 = 1
 4 = 8
 7 = 64
 8 = 128
 = 201

Data Cable Requirements (For DMX and Master/Slave Operation):

The Color 150/RG™ can be controlled via DMX-512 protocol. The DMX address is set using the dip-switches on the rear panel of the Color 150/RG™. Your unit excepts 3-pin XLR connector for data input and data output (Figure 5). When using a DMX controller with 5-Pin XLR output jacks or when linking from a DMX fixture with 5-Pin XLR jack to the Color 150/RG™, be sure to follow the pin conversion chart on page 12. If you are making your own cables, be sure to use standard two conductor shielded cable (This cable may be purchased at almost all pro sound and lighting stores). Your cables should be made with a male and female XLR connector on either end of the cable. Also remember that DMX cable must be daisy chained and can not be split.



Figure 5

Notice: Be sure to follow figures 6 and 7 when making your own cables. Do not use the ground lug on the XLR connector. Do not connect the cable’s shield conductor to the ground lug or allow the shield conductor to come in contact with the XLR’s outer casing. Grounding the shield could cause a short circuit and erratic behavior.

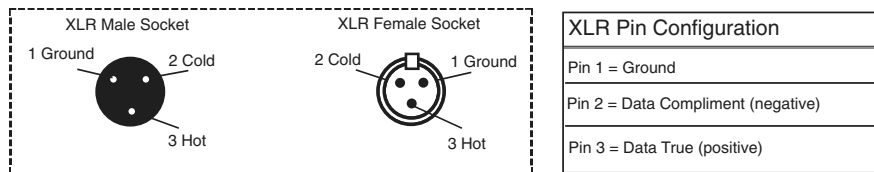

Figure 6

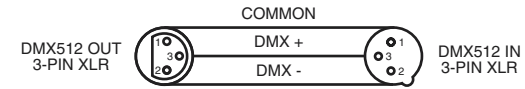

Figure 7

Special Note: Line Termination. When longer runs of cable are used, you may need to use a terminator on the last unit to avoid erratic behavior. A terminator is a 90-120 ohm 1/4 watt resistor which is connected between pins 2 and 3 of a male XLR connector (DATA + and DATA -). This unit is inserted in the female XLR connector of the last unit in your daisy chain to terminate the line. Using a cable terminator (ADJ part number ZDMX/T) will decrease the possibilities of erratic behavior.



Termination reduces signal errors and avoids signal transmission problems and interference. It is always advisable to connect a DMX terminal, (Resistance 120 Ohm 1/4 W) between PIN 2 (DMX-) and PIN 3 (DMX +) of the last fixture.

Figure 8

5-Pin XLR DMX Connectors. Some manufactures use 5-pin XLR connectors for DATA transmission in place of 3-pin. 5-pin XLR fixtures may be implemented in a 3-pin XLR DMX line. When inserting standard 5-pin XLR connectors in to a 3-pin line a cable adaptor must be used, these adaptors are readily available at most electric stores. The chart below details a proper cable conversion.

3-Pin XLR to 5-Pin XLR Conversion		
Conductor	3-Pin XLR Female (Out)	5-Pin XLR Male (In)
Ground/Shield	Pin 1	Pin 1
Data Compliment (- signal)	Pin 2	Pin 2
Data True (+ signal)	Pin 3	Pin 3
Not Used		Do Not Use
Not Used		Do Not Use

Caution: Always replace with the exact same type lamp and fuse, unless otherwise specified by an authorized American DJ® technician. Replacing with anything other than the specified part can damage the unit and will void the manufactures warranty.

Warning: If, after replacing the lamp or fuse either one continues to blow, STOP using the unit. Contact customer support for further instructions, you may have to return the unit for servicing. Continuing to use the unit may cause serious damage.

Fuse Replacement: Disconnect the unit's main power supply. Insert a standard flat head screw driver in to the fuse holder housing. Turn the screwdriver in counter-clockwise direction to remove the fuse holder. Remove the fuse holder to expose the fuse. Remove the old fuse and discard it. Replace the fuse with the same type. Insert the fuse holder back into it's housing and turn it in clockwise direction to lock the holder in place.

Lamp Replacement: Caution! Never attempt to change the lamp while the fixture is plugged in. Always disconnect the main power and allow the unit ample time to cool before attempting to replace the lamp. Lamp replacement has been made simple by incorporating the use of a flip-up top cover that is retained by a single thumb screw.

1. Be sure to follow the proper handling procedures that deal with halogen lamps. **Never touch the new lamp with your bare fingers.**
2. Remove the single thumb screw located on top of the unit. This screw holds the flip-up lamp socket assembly cover in place.
3. Flip-up the cover. The cover is on hinges and will not fall off.
4. Carefully remove the old lamp and discard it in the trash.
5. Replace the lamp with an exact match and reassemble.

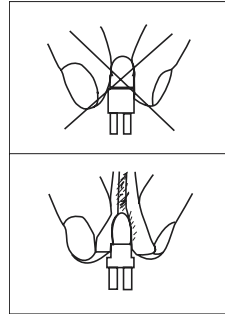
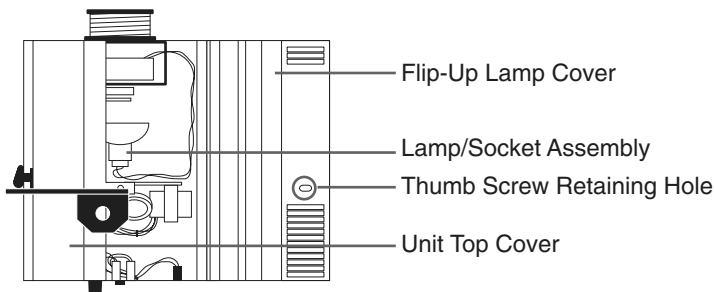

Halogen Lamp Warning:

This fixture is fitted with a halogen lamp which is highly susceptible to damage if improperly handled. Never touch the lamp with your bare fingers as the oil from your hands will shorten lamp life. Also, never move the fixture until the lamp has had ample time to cool. Remember, lamps are not covered under warranty conditions.

This unit includes two interchangeable gobos. These gobo may substituted with any 26mm gobo (20mm viewable). A detailed list of available gobo for this unit may be found on the American DJ® web site, if you do not have access to the internet please contact customer support and request a catalog. *To change the gobos;*

1. Flip unit over so the bottom is facing up.
2. Remove the thumb screw on the rear panel of the unit and slide out the protective fan grill plate.
3. Removing the fan grill plate will expose an addition thumb screw that retains the gobo wheel protective cover. Remove this thumb screw and cover.
4. Once the gobo wheel is exposed, use a small flat head screw drive to gently push one end of the gobo wheel down. This will expose the opposite end of the gobo wheel, allowing you to remove a gobo and replace it with another.
5. Use a small flat head screwdriver to remove the gobo retaining ring, this will allow you to pop out the gobo.
6. Insert a new gobo and reassemble in reverse order.

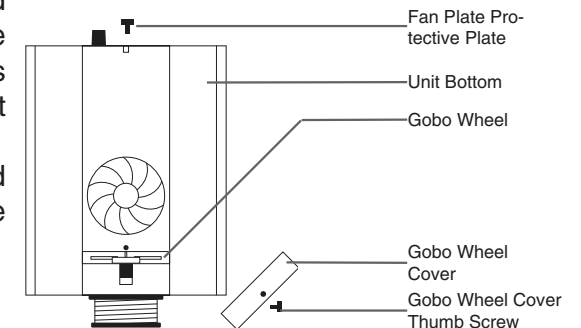

Color 150/RG™

Cleaning

Fixture Cleaning:

Due to fog residue, smoke, and dust cleaning the internal and external optical lenses and mirror should be carried out periodically to optimize light output. Cleaning frequency depends on the environment in which the fixture operates (i.e. smoke, fog residue, dust, dew). In heavy club use we recommend cleaning on a monthly basis. Periodic cleaning will ensure longevity, and crisp output.

1. Use normal glass cleaner and a soft cloth to wipe down the outside casing.
2. Use a brush to wipe down the cooling vents and fan grill.
3. Clean the external lens with glass cleaner and a soft cloth every 20 days.
4. Clean the internal lens with glass cleaner and a soft cloth every 30-60 days.
5. Always be sure to dry all parts completely before plugging the unit back in.

Color 150/RG™

Trouble Shooting

Trouble Shooting:

Listed below are a few common problems that you may encounter, with solutions.

No light output from the unit;

1. Be sure you have connected your unit into a standard 120V wall outlet.
2. Be sure the external fuse has not blown. The fuse is located on the rear panel of the unit.
3. Remove the lamp cover and be sure the lamp is seated in its socket properly. Occasionally lamps become loose during shipping be sure the lamp is push in to its socket all the way.
4. Be sure the fuse holder is completely and properly seated.

Unit does not respond to sound;

1. Low frequencies (bass) should cause the unit to react to sound. Tapping on the microphone, quiet or high pitched sounds may not activate the unit.
2. Be sure the *SENSITIVITY KNOB (3)* is not set to the maximum position.
3. Be sure the dip-switches are set for Stand-Alone mode.

Color 150/RG™

DMX Traits

This chart below details the DMX traits of the fixture. The individual trait can only be accessed an universal DMX controller. Note: The Color 150/RG™ has a special DMX function

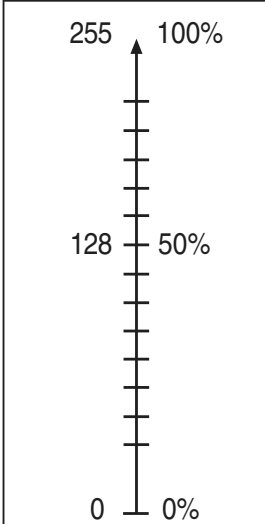
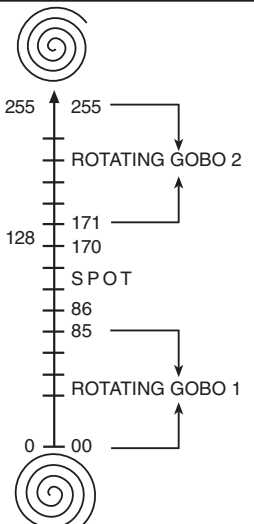
DMX CHANNEL																								
1	2	3																						
DIMMER	COLOR	GOBO																						
	<table border="1"><tr><td>CLR SCROLL FST</td><td>213-255</td></tr><tr><td>CLR SCROLL MED</td><td>181-212</td></tr><tr><td>CLR SCROLL SLW</td><td>170-180</td></tr><tr><td>PURPLE</td><td>149-169</td></tr><tr><td>PINK</td><td>128-148</td></tr><tr><td>ORANGE</td><td>107-127</td></tr><tr><td>YELLOW</td><td>86-106</td></tr><tr><td>GREEN</td><td>65-85</td></tr><tr><td>BLUE</td><td>44-64</td></tr><tr><td>RED</td><td>23-43</td></tr><tr><td>WHITE</td><td>01-22</td></tr></table>	CLR SCROLL FST	213-255	CLR SCROLL MED	181-212	CLR SCROLL SLW	170-180	PURPLE	149-169	PINK	128-148	ORANGE	107-127	YELLOW	86-106	GREEN	65-85	BLUE	44-64	RED	23-43	WHITE	01-22	
CLR SCROLL FST	213-255																							
CLR SCROLL MED	181-212																							
CLR SCROLL SLW	170-180																							
PURPLE	149-169																							
PINK	128-148																							
ORANGE	107-127																							
YELLOW	86-106																							
GREEN	65-85																							
BLUE	44-64																							
RED	23-43																							
WHITE	01-22																							

Color 150/RG™

Master/Slave Settings

This chart details the Master/Slave dip switch setting for Master/Slave configuration for four units. Use these dip switch setting when you will be using two or more fixtures in a Master/Slave configuration. The "Master - Head 1" settings should only be used once.

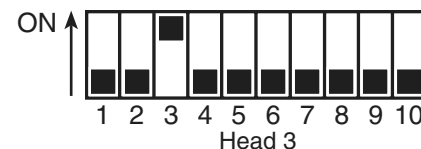
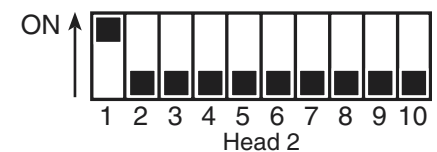

Special function dip-switch settings: The following dip-switch settings detail several special functions. These function included locking the unit on one color, locking the unit on a single gobo, or scrolling through colors.

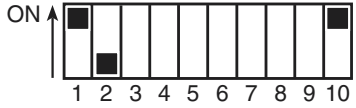

Locked on Gobo 1
Switches 3-9 only apply to color options



Locked on White
Switches 1 & 2 only apply to gobo options



Locked on Red
Switches 1 & 2 only apply to gobo options



Locked on Blue
Switches 1 & 2 only apply to gobo options



Locked on Green
Switches 1 & 2 only apply to gobo options

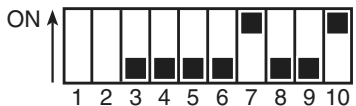

Rotating Color Sequence 1
Switches 1 & 2 only apply to gobo options

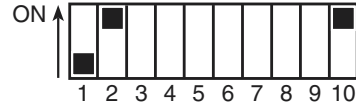

Locked on Gobo 2
Switches 3-9 only apply to color options

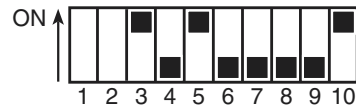

Locked on Yellow
Switches 1 & 2 only apply to gobo options

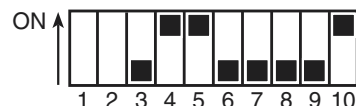

Locked on Orange
Switches 1 & 2 only apply to gobo options



Locked on Pink
Switches 1 & 2 only apply to gobo options



Locked on Purple
Switches 1 & 2 only apply to gobo options



Rotating Color Sequence 2
Switches 1 & 2 only apply to gobo options

This chart list the DMX dip switch setting for DMX address 1 through 511. Follow the instructions below to configure fixture dip switches with your desired DMX address.

DMX Address Quick Reference Chart

DIP SWITCHES					Dip Switch Position																		
DMX DIP Switch Settings					#9	X	X	X	X	X	X	X	X	O	O	O	O	O	O	O	O	O	O
X = OFF					#8	X	X	X	X	O	O	O	O	X	X	X	X	O	O	O	O	O	
O = ON					#7	X	X	O	O	X	X	O	O	X	X	O	O	X	X	O	O	O	
#1	#2	#3	#4	#5	#6	X	O	X	O	X	O	X	O	X	O	X	O	X	O	X	O		
X	X	X	X	X	3	64	96	128	160	192	224	256	288	320	352	384	416	448	480				
O	X	X	X	X	1	33	65	97	129	161	193	225	257	289	321	353	385	417	449	481			
X	O	X	X	X	2	34	66	98	130	162	194	226	258	290	322	354	386	418	450	482			
O	O	X	X	X	3	35	67	99	131	163	195	227	259	291	323	355	387	419	451	483			
X	X	O	X	X	4	36	68	100	132	164	196	228	260	292	324	356	388	420	452	484			
O	X	O	X	X	5	37	69	101	133	165	197	229	261	293	325	357	389	421	453	485			
X	O	O	X	X	6	38	70	102	134	166	198	230	262	294	326	358	390	422	454	486			
O	O	O	X	X	7	39	71	103	135	167	199	231	263	295	327	359	391	423	455	487			
X	X	X	O	X	8	40	72	104	136	168	200	232	264	296	328	360	392	424	456	488			
O	X	X	O	X	9	41	73	105	137	169	201	233	265	297	329	361	393	425	457	489			
X	O	X	O	X	10	42	74	106	138	170	202	234	266	298	330	362	394	426	458	490			
O	O	X	O	X	11	43	75	107	139	171	203	235	267	299	331	363	395	427	459	491			
X	X	O	O	X	12	44	76	108	140	172	204	236	268	300	332	364	396	428	460	492			
O	X	O	O	X	13	45	77	109	141	173	205	237	269	301	333	365	397	429	461	493			
X	O	O	O	X	14	46	78	110	142	174	206	238	270	302	334	366	398	430	462	494			
O	O	O	O	X	15	47	79	111	143	175	207	239	271	303	335	367	399	431	463	495			
X	X	X	X	O	16	48	80	112	144	176	208	240	272	304	336	368	400	432	464	496			
O	X	X	X	O	17	49	81	113	145	177	209	241	273	305	337	369	401	433	465	497			
X	O	X	X	O	18	50	82	114	146	178	210	242	274	306	338	370	402	434	466	498			
O	O	X	X	O	19	51	83	115	147	179	211	243	275	307	339	371	403	435	467	499			
X	X	O	X	O	20	52	84	116	148	180	212	244	276	308	340	372	404	436	468	500			
O	X	O	X	O	21	53	85	117	149	181	213	245	277	309	341	373	405	437	469	501			
X	O	O	X	O	22	54	86	118	150	182	214	246	278	310	342	374	406	438	470	502			
O	O	O	X	O	23	55	87	119	151	183	215	247	279	311	343	375	407	439	471	503			
X	X	X	O	O	24	56	88	120	152	184	216	248	280	312	344	376	408	440	472	504			
O	X	X	O	O	25	57	89	121	153	185	217	249	281	313	345	377	409	441	473	505			
X	O	X	O	O	26	58	90	122	154	186	218	250	282	314	346	378	410	442	474	506			
O	O	X	O	O	27	59	91	123	155	187	219	251	283	315	347	379	411	443	475	507			
X	X	O	O	O	28	60	92	124	156	188	220	252	284	316	348	380	412	444	476	508			
O	X	O	O	O	29	61	93	125	157	189	221	253	285	317	349	381	413	445	477	509			
X	O	O	O	O	30	62	94	126	158	190	222	254	286	318	350	382	414	446	478	510			
O	O	O	O	O	31	63	95	127	159	191	223	255	287	319	351	383	415	447	479	511			

The center numbers of this chart (1-511) represent a DMX address. The "X"s and "O"s along the top and side of the chart represent dip switch position ("X" for off and "O" for on). Find your desired DMX address from the center chart. Identify the position for dip switches 1-5 from the chart on the left and dip switches 6-9 from the chart on the top. Adjust the dip switches on your fixture to match the position settings of the chart. For fixtures with 10 dip switches; dip switch 10 is reserved for special functions.

1-YEAR LIMITED WARRANTY

A. American DJ® hereby warrants, to the original purchaser, American DJ® products to be free of manufacturing defects in material and workmanship for a period of 1 Year (365 days) from the date of purchase. This warranty shall be valid only if the product is purchased within the United States of America, including possessions and territories. It is the owner's responsibility to establish the date and place of purchase by acceptable evidence, at the time service is sought.

B. For warranty service, send the product only to the American DJ® factory. All shipping charges must be pre-paid. If the requested repairs or service (including parts replacement) are within the terms of this warranty, American DJ® will pay return shipping charges only to a designated point within the United States. If the entire instrument is sent, it must be shipped in its original package. No accessories should be shipped with the product. If any accessories are shipped with the product, American DJ® shall have no liability whatsoever for loss of or damage to any such accessories, nor for the safe return thereof.

C. This warranty is void if the serial number has been altered or removed; if the product is modified in any manner which American DJ® concludes, after inspection, affects the reliability of the product; if the product has been repaired or serviced by anyone other than the American DJ® factory unless prior written authorization was issued to purchaser by American DJ®; if the product is damaged because not properly maintained as set forth in the instruction manual.

D. This is not a service contract, and this warranty does not include maintenance, cleaning or periodic check-up. During the period specified above, American DJ® will replace defective parts at its expense, and will absorb all expenses for warranty service and repair labor by reason of defects in material or workmanship. The sole responsibility of American DJ® under this warranty shall be limited to the repair of the product, or replacement thereof, including parts, at the sole discretion of American DJ®. All products covered by this warranty were manufactured after January 1, 1990, and bear identifying marks to that effect.

E. American DJ® reserves the right to make changes in design and/or improvements upon its products without any obligation to include these changes in any products theretofore manufactured.

F. No warranty, whether expressed or implied, is given or made with respect to any accessory supplied with products described above. Except to the extent prohibited by applicable law, all implied warranties made by American DJ® in connection with this product, including warranties of merchantability or fitness, are limited in duration to the warranty period set forth above. And no warranties, whether expressed or implied, including warranties of merchantability or fitness, shall apply to this product after said period has expired. The consumer's and or Dealer's sole remedy shall be such repair or replacement as is expressly provided above; and under no circumstances shall American DJ® be liable for any loss or damage, direct or consequential, arising out of the use of, or inability to use, this product.

G. This warranty is the only written warranty applicable to American DJ® Products and supersedes all prior warranties and written descriptions of warranty terms and conditions heretofore published.

H. Lamps are not covered under this or any other warranty, either written or implied.

©American DJ Supply® - www.americandj.com - Color 150/RG™ Instruction Manual Page 19

Technical Specifications:**Model: Color 150/RG™**

Lamps:	ZB-JCR H5 15v/150w
Voltage:	120v/60Hz
Dimensions:	14.25"(H) x 6.75"(W) x 9.75"(D) with yoke extended
Colors	7 colors gobo, plus white spots
Gobos:	2 interchangeable, plus spot
Weight:	12 Lbs.
Fuse:	3 Amp GMA
Duty Cycle:	15 min on/off
DMX:	3 Channels
Sound Active:	Yes, Master/Slave mode
Working Position:	Any Safe, Secure Position
Warranty:	1 Year (365 days)

Please Note: Specifications and improvements in the design of this unit and this manual are subject to change without any prior written notice.

©American DJ Supply
 American DJ Supply Group of Companies World Headquarters:
 4295 Charter Street Los Angeles, CA 90058 USA
 Tel: 323-582-2650 Fax: 323-582-2610
 Web: www.americandj.com E-mail: info@americandj.com

Free Manuals Download Website

<http://myh66.com>

<http://usermanuals.us>

<http://www.somanuals.com>

<http://www.4manuals.cc>

<http://www.manual-lib.com>

<http://www.404manual.com>

<http://www.luxmanual.com>

<http://aubethermostatmanual.com>

Golf course search by state

<http://golfingnear.com>

Email search by domain

<http://emailbydomain.com>

Auto manuals search

<http://auto.somanuals.com>

TV manuals search

<http://tv.somanuals.com>