

ALTO-SHAAM®

Cook, Hold, Smoke Oven

Deluxe Control



Model:

767-SK/III

1767-SK/III

1000-SK/III

1200-SK/III



1767-SK/III

1200-SK/III



767-SK/III

1000-SK/III

HALO HEAT®

- **INSTALLATION**
- **OPERATION**
- **MAINTENANCE**

24•7
Your Service Hotline
1-800-558-8744

W164 N9221 Water Street • P.O. Box 450 • Menomonee Falls, Wisconsin 53052-0450 USA
PHONE: 262.251.3800 • 800.558.8744 USA/CANADA FAX: 262.251.7067 • 800.329.8744 U.S.A. ONLY
www.alto-shaam.com

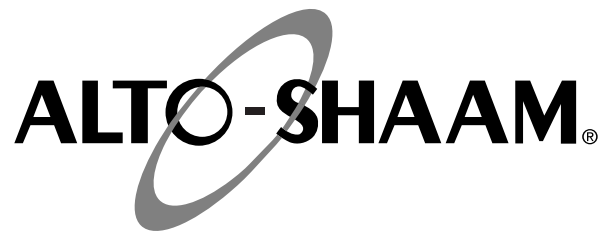

Delivery	1
Unpacking	1
Safety Procedures and Precautions	2

Installation

Installation Requirements	3
Clearance Requirements	3
Dimension Drawings, weights & capacities	4-5
Options and Accessories	6
Stacking Instructions	7
Leveling	8
Restraint Requirements - Mobile Equipment	8
Drip Tray Installation	9
Electrical Specifications	10

Operating Instructions

User Safety Information	11
Before Initial Use	11
Audible Signals	11
Control Features	12
Operating Features and Functions	13
Operating Instructions	14-16
User Options	17
General Holding Guidelines	18

Care and Cleaning

Cleaning and Preventative Maintenance	19
Protecting Stainless Steel Surfaces	19
Cleaning Agents	19
Cleaning Materials	19
Daily Prong Cleaning	19
Equipment Care	20
Daily Cleaning	20

Sanitation

Sanitation/Food Safety	21
Internal Food Product Temperatures	21

Service

Troubleshooting	22-23
-----------------------	-------

Service Views and Parts

Exterior View - 767-SK/III, 1000-SK/III	24
Exterior Parts List - 767-SK/III, 1000-SK/III	25
Exterior View - 1767-SK/III, 1200-SK/III	26
Exterior Parts List -1767-SK/III, 1200-SK/III	27
Electronic Components View	28
Electronic Components Parts List	29
Cable Heating Kits	29

Wire Diagrams

Always refer to the wire diagram(s) included with the unit for most current version.

Warranty

Transportation Damage and Claims	Back Cover
Limited Warranty	Back Cover

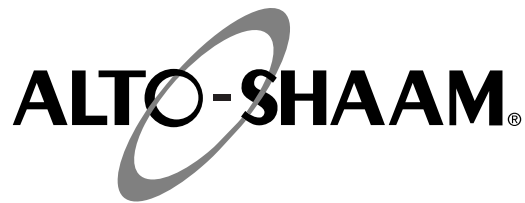

DELIVERY

This Alto-Shaam appliance has been thoroughly tested and inspected to ensure only the highest quality unit is provided. Upon receipt, check for any possible shipping damage and report it at once to the delivering carrier. *See Transportation Damage and Claims section located in this manual.*

This appliance, complete with unattached items and accessories, may have been delivered in one or more packages. Check to ensure that all standard items and options have been received with each model as ordered.

Save all the information and instructions packed with the appliance. Complete and return the warranty card to the factory as soon as possible to ensure prompt service in the event of a warranty parts and labor claim.

This manual must be read and understood by all people using or installing the equipment model. Contact the Alto-Shaam Tech Team Service Department if you have any questions concerning installation, operation, or maintenance.

NOTE: All claims for warranty must include the full model number and serial number of the unit.

UNPACKING

1. Carefully remove the appliance from the carton or crate.

NOTE: Do not discard the carton and other packaging material until you have inspected the unit for hidden damage and tested it for proper operation.

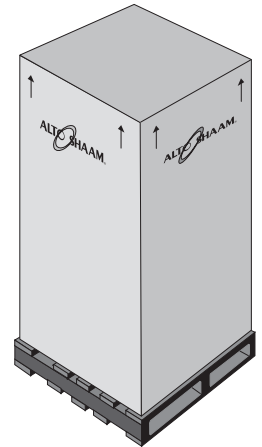

2. Read all instructions in this manual carefully before initiating the installation of this appliance.

DO NOT DISCARD THIS MANUAL.

This manual is considered to be part of the appliance and is to be provided to the owner or manager of the business or to the person responsible for training operators. *Additional manuals are available from the Alto-Shaam Tech Team Service Department.*

3. Remove all protective plastic film, packaging materials, and accessories from the appliance before connecting electrical power. Store any accessories in a convenient place for future use.

SAFETY PROCEDURES AND PRECAUTIONS

Knowledge of proper procedures is essential to the safe operation of electrically and/or gas energized equipment. In accordance with generally accepted product safety labeling guidelines for potential hazards, the following signal words and symbols may be used throughout this manual.

DANGER



Used to indicate the presence of a hazard that **WILL** cause severe personal injury, death, or substantial property damage if the warning included with this symbol is ignored.

WARNING



Used to indicate the presence of a hazard that **CAN** cause personal injury, possible death, or major property damage if the warning included with this symbol is ignored.

CAUTION



Used to indicate the presence of a hazard that can or will cause minor or moderate personal injury or property damage if the warning included with this symbol is ignored.

CAUTION

Used to indicate the presence of a hazard that can or will cause minor personal injury, property damage, or a potential unsafe practice if the warning included with this symbol is ignored.

NOTE: Used to notify personnel of installation, operation, or maintenance information that is important but not hazard related.

1. This appliance is intended to cook, hold or process foods for the purpose of human consumption. No other use for this appliance is authorized or recommended.
2. This appliance is intended for use in commercial establishments where all operators are familiar with the purpose, limitations, and associated hazards of this appliance. Operating instructions and warnings must be read and understood by all operators and users.
3. Any troubleshooting guides, component views, and parts lists included in this manual are for general reference only and are intended for use by qualified technical personnel.
4. This manual should be considered a permanent part of this appliance. This manual and all supplied instructions, diagrams, schematics, parts lists, notices, and labels must remain with the appliance if the item is sold or moved to another location.

NOTE

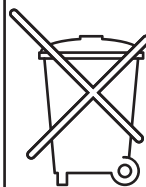

For equipment delivered for use in any location regulated by the following directive:

DO NOT DISPOSE OF ELECTRICAL OR ELECTRONIC EQUIPMENT WITH OTHER MUNICIPAL WASTE.

INSTALLATION

DANGER



IMPROPER INSTALLATION, ALTERATION, ADJUSTMENT, SERVICE, OR MAINTENANCE COULD RESULT IN SEVERE INJURY, DEATH, OR CAUSE PROPERTY DAMAGE.

READ THE INSTALLATION, OPERATING AND MAINTENANCE INSTRUCTIONS THOROUGHLY BEFORE INSTALLING OR SERVICING THIS EQUIPMENT.

CAUTION



TO PREVENT PERSONAL INJURY, USE CAUTION WHEN MOVING OR LEVELING THIS APPLIANCE.

CAUTION



METAL PARTS OF THIS EQUIPMENT BECOME EXTREMELY HOT WHEN IN OPERATION. TO AVOID BURNS, ALWAYS USE HAND PROTECTION WHEN OPERATING THIS APPLIANCE.



DANGER



DO NOT store or use gasoline or other flammable vapors or liquids in the vicinity of this or any other appliance.

SITE INSTALLATION

The Alto-Shaam cook and hold oven must be installed in a location that will permit the oven to function for its intended purpose and to allow adequate clearance for ventilation, proper cleaning, and maintenance access.

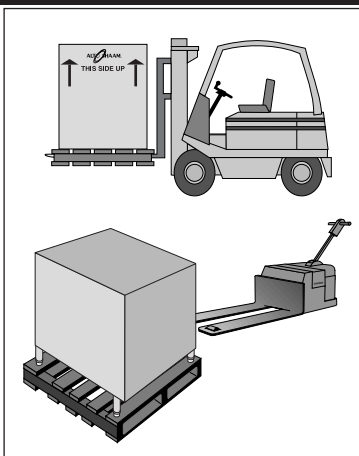

CLEARANCE REQUIREMENTS

18" (457mm) minimum clearance at the back from heat producing equipment. To protect the electronic control, maintain sufficient side clearance to prevent the control area from reaching any temperature at or above 140°F (60°C).

NOTE

If the appliance has been unplugged for an extended period of time, the Real Time Clock may require recharging. Turn main breaker to the unit off for 10 seconds and then restore power. For more information, see Error Code E-60 in the Troubleshooting section of this manual.

1. The oven must be installed on a stable and level surface.
2. **DO NOT** install this appliance in any area where it may be affected by any adverse conditions such as steam, grease, dripping water, high temperatures, or any other severely adverse conditions.
3. **DO NOT** store or use any flammable liquids or allow flammable vapors in the vicinity of this oven or any other appliance.
4. This appliance must be kept free and clear of any combustible materials.
5. This appliance must be kept free and clear of any obstructions blocking access for maintenance or service.

INSTALLATION

SITE INSTALLATION

767-SK/III

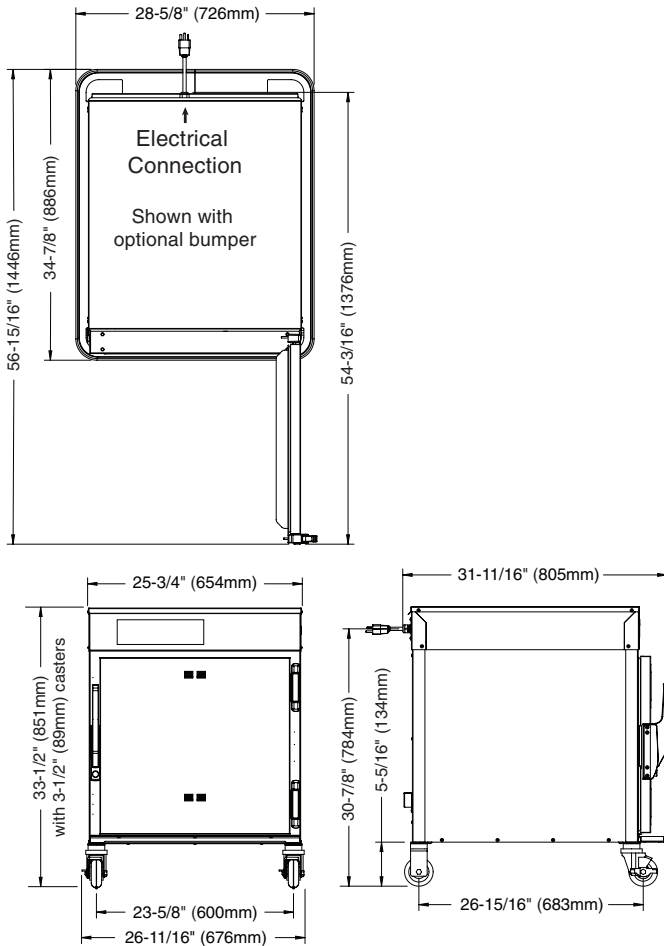

*31-11/16" (803mm) - with optional 2-1/2" (64mm) casters
 *35-1/4" (894mm) - with optional 5" (127mm) casters
 *33-13/16" (858mm) - with optional 6" (152mm) legs

1767-SK/III

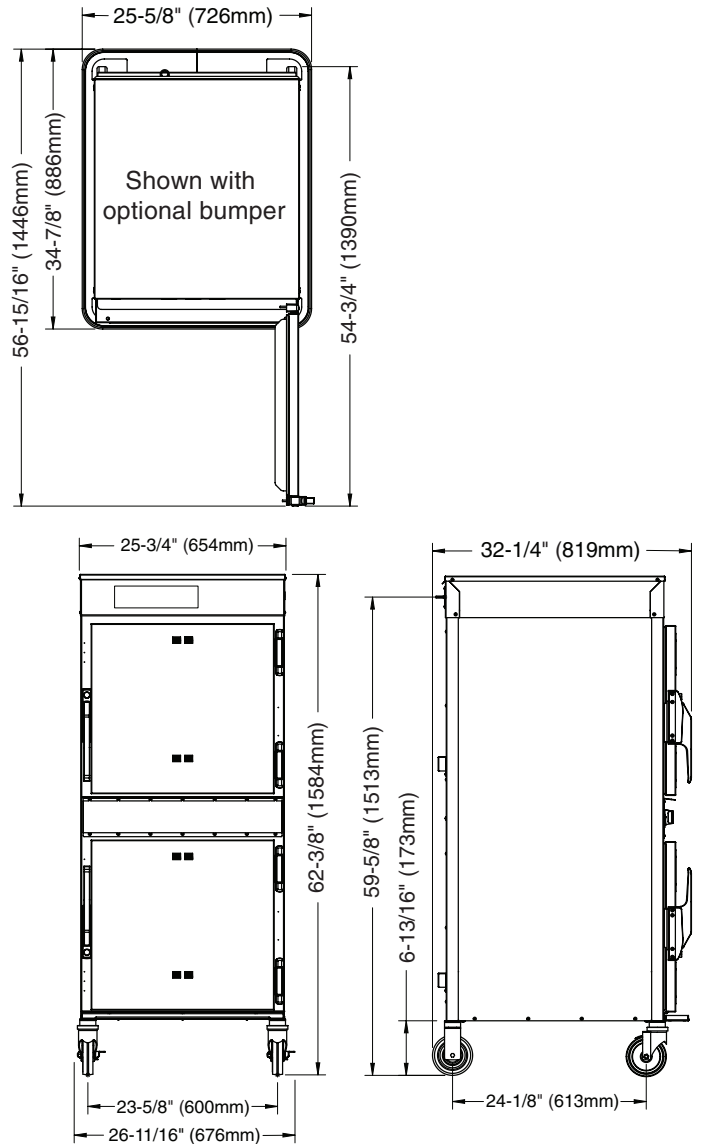

*60-11/16" (1540mm) - with optional 5" (127mm) casters
 *62-1/8" (1577mm) - with optional 6" (152mm) legs

WEIGHT

MODEL	NET WEIGHT	SHIP WEIGHT
767-SK/III	196 lb (89 kg)	225 lb (102 kg)
1767-SK/III	359 lb (163 kg) EST.	450 lb (204 kg)

CAPACITY PER COMPARTMENT

100 lb (45 kg) MAXIMUM
 VOLUME MAXIMUM: 53 QUARTS (67 LITERS)

INSTALLATION

SITE INSTALLATION

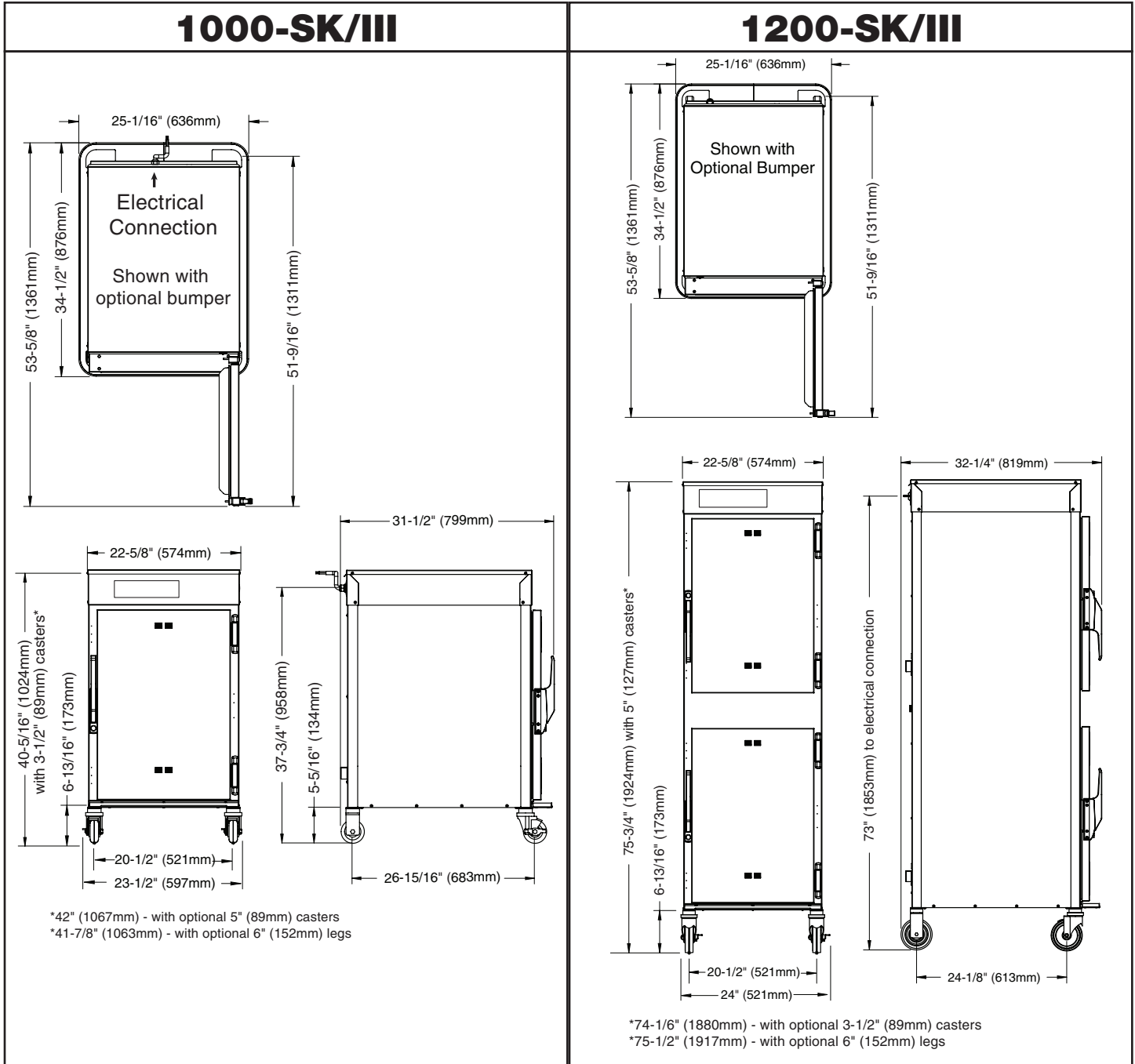

WEIGHT			CAPACITY PER COMPARTMENT
MODEL	NET WEIGHT	SHIP WEIGHT	
1000-SK/III	203 lb (92 kg) EST.	282 lb (128 kg) EST.	120lb (54 kg) MAXIMUM VOLUME MAXIMUM: 60 QUARTS (76 LITERS)
12000-SK/III	390 lb (177 kg) EST.	435 lb (197 kg) EST.	

INSTALLATION

OPTIONS AND ACCESSORIES

OPTIONS AND ACCESSORIES	767-SK/III	1767-SK/III	1000-SK/III	1200-SK/III
Bumper, Full Perimeter	5010371	5010371	5009767	5009767
Carving Holder PRIME RIB STEAMSHIP (CAFETERIA) ROUND	HL-2635 4459	HL-2635 4459	HL-2635 4459	HL-2635 4459
Casters - 2 RIGID, 2 SWIVEL W/BRAKE 5" (127mm) 3-1/2" (89mm) 2-1/2" (64mm)	5004862 STANDARD 5008022	STANDARD 5008017 —	5004862 STANDARD 5008022	STANDARD 5008017 —
Exterior Color Options STAINLESS STEEL BURGUNDY CUSTOM COLOR	STANDARD AVAILABLE AVAILABLE	STANDARD AVAILABLE AVAILABLE	STANDARD AVAILABLE AVAILABLE	STANDARD AVAILABLE AVAILABLE
Door Lock with Key	LK-22567	LK-22567	LK-22567	LK-22567
Door with Window RIGHT HAND LEFT HAND	5010406 5010409	5010406 5010409	15879R 15881R	15879R 15881R
Drip Pan, with Drain, 1-11/16" (43mm deep)	—	—	5005616	5005616
Drip Pan, without Drain, 1-7/8" (48mm deep)	14831	14831	11906	11906
Drip Pan, Extra Deep	—	—	15929	15929
Legs, Stemmed, 6" (152mm) - SET OF FOUR	5011149	5011149	5011149	5011149
Pan Grid, Wire - 18" x 26" PAN INSERT	PN-2115	PN-2115	PN-2115	PN-2115
Pan Slides (230V ONLY) - 2 PER CAVITY NEEDED	1010813	1010813	—	—
Shelf, Stainless Steel FLAT WIRE, REACH-IN RIB RACK	SH-2324 SH-2743	SH-2324 SH-2743	SH-2325 SH-29474	SH-2325 SH-29474
Stacking Hardware	5004864	—	5004864	—
Wood Chips, bulk pack Apple 20 lb (9 kg) Cherry 20 lb (9 kg) Hickory 20 lb (9 kg) Maple 20 lb (9 kg)	WC-22543 WC-22541 WC-2829 WC-22545	WC-22543 WC-22541 WC-2829 WC-22545	WC-22543 WC-22541 WC-2829 WC-22545	WC-22543 WC-22541 WC-2829 WC-22545

INSTALLATION

SITE INSTALLATION

STACKING INSTRUCTIONS

- 1) **If the two appliances were shipped together from the factory, the top unit will have the casters already removed. A stacking kit will be included with the shipment.**

If casters need to be removed: lay the unit on its back, and remove the set screw on each caster. Pull the casters out of the unit.

- 2) **While appliance is laid on its back, insert one stacking post in each of the four corners of the upper unit. Secure the stacking posts using one screw and two flat washers that come with the stacking kit.**

Note: The flange on the stacking posts must face the outside of the unit.

- 3) **Remove the four top mounting screws from the lower unit. Place the upper appliance, which has the stacking posts installed, on top of the bottom unit. Center the top unit from front to back. Re-install the four screws through the flange of the four stacking posts.**

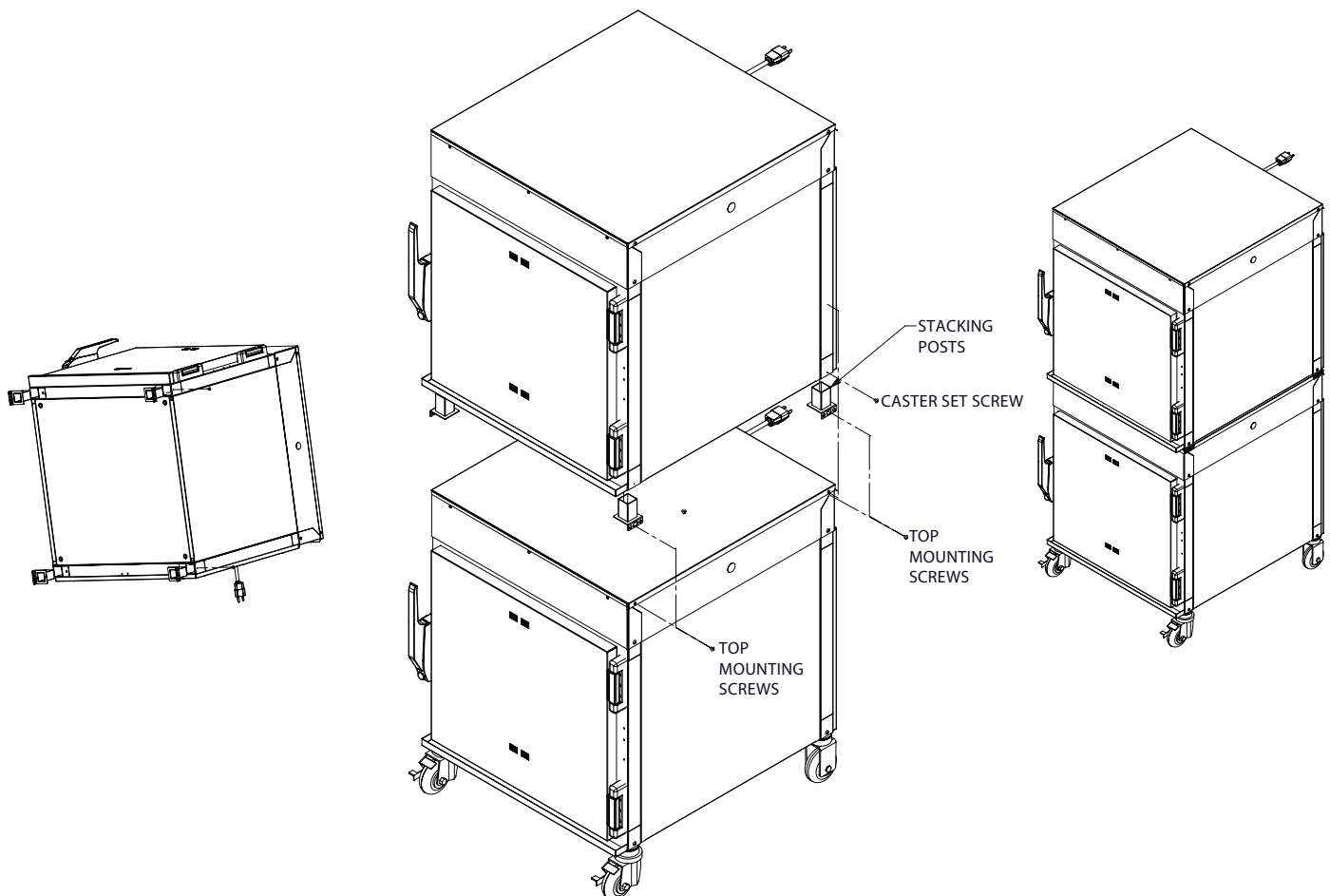

Stacking Configurations

767-SK/III with 767-SK/III, 750-TH/III,
750-TH-II, 767-SK, or 750-S

Stacking Configurations

1000-SK/III with 1000-SK/III,
1000-TH/III, or 1000-S

INSTALLATION

SITE INSTALLATION

A number of adjustments are associated with initial installation and start-up. It is important that these adjustments be conducted by a qualified service technician. Installation and start-up adjustments are the responsibility of the dealer or user. These adjustments include but are not limited to thermostat calibration, door adjustment, leveling, electrical hook-up and installation of optional casters or legs.

LEVELING

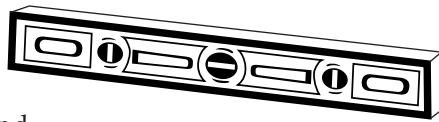

Level the oven from side-to-side and front-to-back with the use of a spirit level. For ovens installed with casters, it is important that the installation surface be level due to the probability of frequent oven repositioning.

We recommend checking the level of the oven periodically to make certain the floor has not shifted nor the oven moved.

NOTE: Failure to properly level this oven can cause improper function and will result in the uneven baking with products consisting of semi-liquid batter.

RESTRAINT REQUIREMENTS —MOBILE EQUIPMENT

 WARNING	
	RISK OF ELECTRIC SHOCK. Appliance must be secured to building structure.

Any appliance that is not furnished with a power supply cord but that includes a set of casters must be installed with a tether. Adequate means must be provided to limit the movement of this appliance without depending on or transmitting stress to the electrical conduit. The following requirements apply:

1. Maximum height of casters is 6" (152mm).
2. Two of the casters must be the locking type.
3. Such mobile appliances or appliances on mobile stands must be installed with the use of a flexible connector secured to the building structure.

A mounting connector for a restraining device is located on the upper back flange of the appliance. A flexible connector is not supplied by nor is it available from the factory.

INSTALLATION

SITE INSTALLATION

DRIP TRAY INSTALLATION INSTRUCTIONS

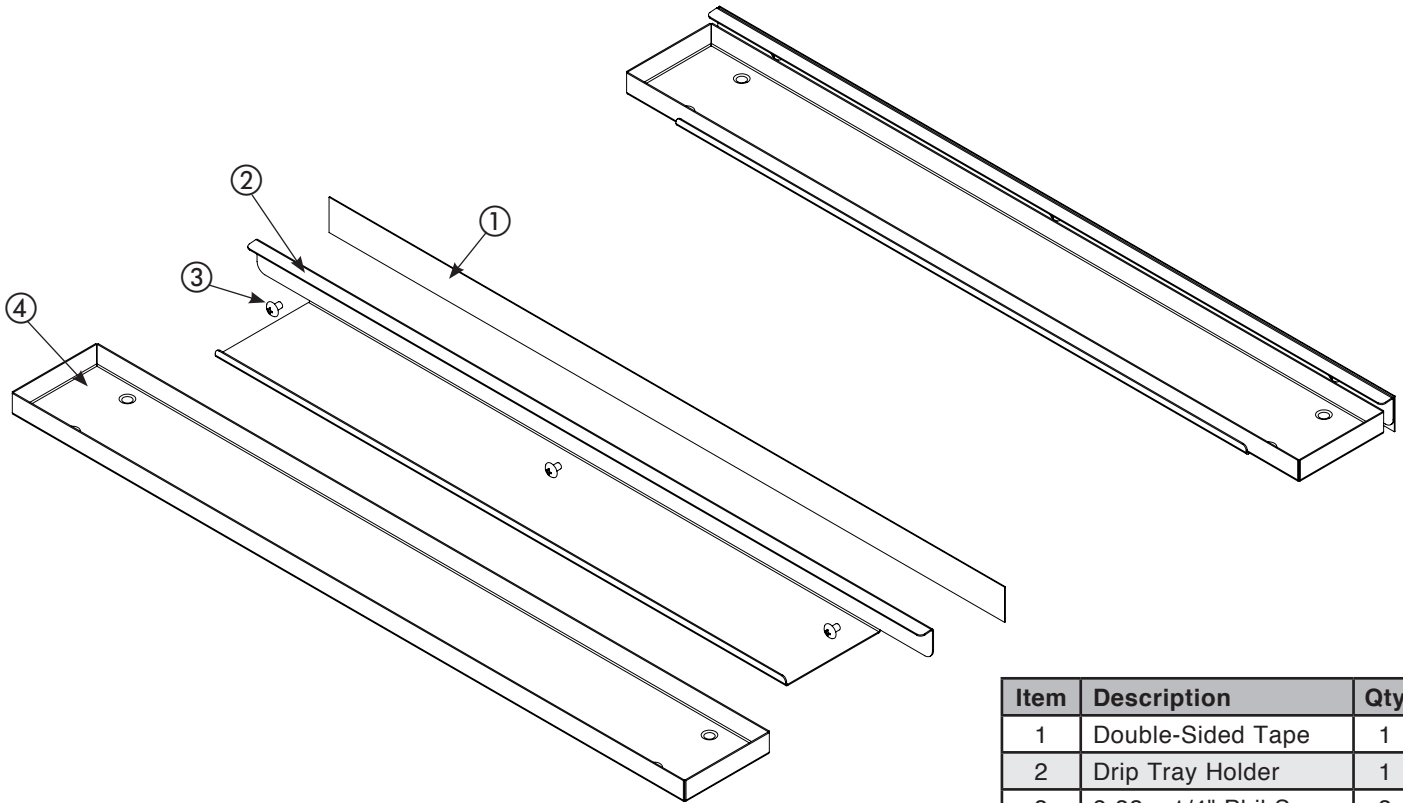

Item	Description	Qty
1	Double-Sided Tape	1
2	Drip Tray Holder	1
3	8-32 x 1/4" Phil Screw	3
4	Drip Tray	1

1. Poke holes through double-sided tape ① which is attached to the back of drip tray holder ②.
2. Remove backing on double-sided tape ①.
3. Put screws ③ through holes and attach drip tray holder ② to unit.
4. Optional - apply a line of food-grade silicone caulk along top edge of drip tray holder ② to seal.
5. Place drip tray ④ in drip tray holder ②.

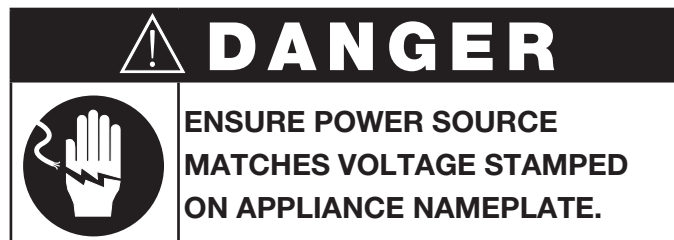

INSTALLATION

ELECTRICAL CONNECTION

The appliance must be installed by a qualified service technician. The oven must be properly grounded in accordance with the National Electrical Code and applicable local codes.

Plug the unit into a properly grounded receptacle **ONLY**, positioning the unit so that the plug is easily accessible in case of an emergency. Arcing will occur when connecting or disconnecting the unit unless all controls are in the "OFF" position.

Proper receptacle or outlet configuration or permanent wiring for this unit must be installed by a licensed electrician in accordance with applicable local electrical codes.

Supply cords used with this equipment shall be oil-resistant, sheathed flexible cable not lighter than ordinary polychloroprene or other equivalent synthetic elastomer-sheathed cord (Code designation 60245 IEC).

ELECTRICAL - 767-SK/III						
VOLTAGE	PHASE	CYCLE/HZ	AMPS	kW	AWG	
208-240 (AGCY)	1	60	16.0	3.9	CORD,	
at 208	1	60	15.5	3.2	NO PLUG	
at 240	1	60	17.9	4.3		
230	1	50/60	15.4	3.1		CEE 7/7 220-230V PLUG

ELECTRICAL - 1767-SK/III						
VOLTAGE	PHASE	CYCLE/HZ	AMPS	kW	AWG	
208-240 (AGCY)	1	60	32.0	7.7	NO CORD	
at 208	1	60	31.0	6.5	OR PLUG	
at 240	1	60	35.8	8.6		
230	1	50	29.1	6.1	NO CORD OR PLUG	

ELECTRICAL - 1000-SK/III						
VOLTAGE	PHASE	CYCLE/HZ	AMPS	kW	CORD & PLUG	
208-240 (AGCY)	1	60	15.8	3.8	NO CORD	
at 208	1	60	14.4	3.0	OR PLUG	
at 240	1	60	16.7	4.0		
230	1	50	14.0	2.8		CEE 7/7 220-230V PLUG

ELECTRICAL - 1200-SK/III						
VOLTAGE	PHASE	CYCLE/HZ	AMPS	kW	CORD & PLUG	
208-240 (AGCY)	1	60	33.3	8.0	NO CORD	
at 208	1	60	30.6	6.4	OR PLUG	
at 240	1	60	35.4	8.5		
230	1	50	31.5	7.2	NO CORD OR PLUG	

Wire diagrams are located inside the bonnet of the unit.



DANGER



ELECTRICAL CONNECTIONS MUST BE MADE BY A QUALIFIED SERVICE TECHNICIAN IN ACCORDANCE WITH APPLICABLE ELECTRICAL CODES.

REGARDING INTERNATIONAL STANDARD UNITS:

If the unit is not equipped with flexible cord and plug, an all-pole country approved disconnection device which has a contact separation of at least 3mm in all poles must be incorporated in the fixed wiring for disconnection. When using a cord without a plug, the green/yellow conductor shall be connected to the terminal which is marked with the ground symbol. If a plug is used, the socket outlet must be easily accessible. If the power cord needs replacement, use a similar one obtained from the distributor.

For CE approved units: To prevent an electrical shock hazard between the appliance and other appliances or metal parts in close vicinity, an equalization-bonding stud is provided. An equalization bonding lead must be connected to this stud and the other appliances / metal parts to provide sufficient protection against potential difference. The terminal is marked with the following symbol.



Hard wired models:

Hard wired models must be equipped with a country certified external allpole disconnection switch with sufficient contact separation.

If a power cord is used for the connection of the product an oil resistant cord like H05RN or H07RN or equivalent must be used.

NOTE: CE approved appliances must be connected to an electrical circuit that is protected by an external GFCI outlet.



DANGER



ENSURE POWER SOURCE MATCHES VOLTAGE STAMPED ON APPLIANCE NAMEPLATE.



DANGER



To avoid electrical shock, this appliance **MUST be adequately grounded in accordance with local electrical codes or, in the absence of local codes, with the current edition of the National Electrical Code ANSI/NFPA No. 70. In Canada, all electrical connections are to be made in accordance with CSA C22.1, Canadian Electrical Code Part 1 or local codes.**

OPERATING INSTRUCTIONS

USER SAFETY INFORMATION

CAUTION



METAL PARTS OF THIS EQUIPMENT BECOME EXTREMELY HOT WHEN IN OPERATION. TO AVOID BURNS, ALWAYS USE HAND PROTECTION WHEN OPERATING THIS APPLIANCE.

The Alto-Shaam cook and hold oven is intended for use in commercial establishments by qualified operating personnel where all operators are familiar with the purpose, limitations, and associated hazards of this appliance. Operating instructions and warnings must be read and understood by all operators and users.

START-UP OPERATION

BEFORE INITIAL USE:

Interior oven surfaces must be heated to remove surface oils and the accompanying odor produced during the first use of the oven.

1. Wipe all wire shelves, side racks and the full oven interior with a clean, damp cloth. Install the oven side racks, oven shelves, and external drip tray. Shelves are installed with the curved edge toward the back of the oven. Insert the drip pan on the interior bottom surface of the oven.
2. • Close the oven doors
• Press and release control ON/OFF key.
• Press the COOK key.
• Press the up and down arrows to set the cooking temperature to 300°F (149°C).
3. • Press the TIME key.
• Press the up and down arrows to set the cooking time to approximately 2 hours.
• Allow the oven to cycle for approximately 2 hours or until no odor is detected.

DANGER



AT NO TIME SHOULD THE INTERIOR OR EXTERIOR BE STEAM CLEANED, HOSED DOWN, OR FLOODED WITH WATER OR LIQUID SOLUTION OF ANY KIND. DO NOT USE WATER JET TO CLEAN.



SEVERE DAMAGE OR ELECTRICAL HAZARD COULD RESULT.

WARRANTY BECOMES VOID IF APPLIANCE IS FLOODED



DANGER



DISCONNECT UNIT FROM POWER SOURCE BEFORE CLEANING OR SERVICING.

AUDIBLE SIGNALS

OVEN BEEPING indicates a response, mode changes, and error conditions.

One brief beep - Response to a key being pressed.

Two brief beeps - Informative beep that indicates that something has been changed, such as the user entering a volume change, entering a temperature scale change, etc.

Three brief beeps - Indicates the oven is done preheating, the probe has exceeded set-point in cold smoking, the door has been open too long, or the control is unlocked.

Four brief beeps - Indicates an error. Refer to the Trouble Shooting section of this manual.

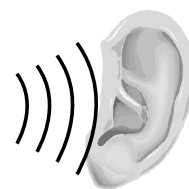

OPERATING INSTRUCTIONS

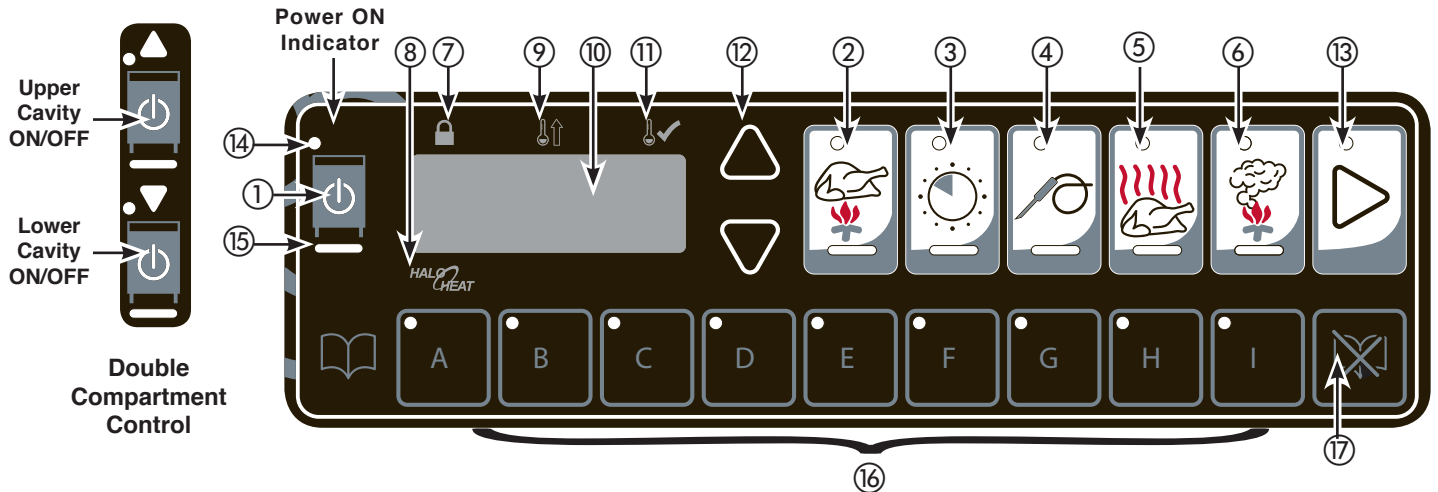

CONTROL FEATURES

- 1. ON/OFF Key**
The ON/OFF control system key operates the functions of the control panel. If there is any power loss during operation, the on/off indicator light will flash. To clear, push key and release.
- 2. COOK Key — Temperature range 200° to 325°F (93° to 162°C)**
Used to select cooking mode and to review the cook temperature setting.
- 3. TIME Key — Maximum time 24 hours**
Used to select cook time and to review set time.
- 4. PROBE Key — Temperature range 50° to 195°F (10° to 91°C)**
Used to select internal product probe temperature mode and to review probe temperature setting.
- 5. HOLD Key — Temperature range 60° to 205°F (15° to 96°C)**
Used to select food holding mode and to review set holding temperature.
- 6. SMOKER Key — Time range 0 to 4 hours**
Used to select warm smoke or cold smoke and to review the smoke time remaining.
- 7. Lock Indicator**
When illuminated, this symbol indicates settings used in the cooking sequence are locked and cannot be changed.
- 8. Halo Heat Indicator**
When the oven is preheating, the Halo Heat indicator will illuminate during preheating and remain steady until the oven reaches the set cooking temperature. When the temperature has stabilized, the indicator will illuminate periodically as the oven calls for heat.
- 9. Oven Preheat Light**
Illuminates until the oven is preheated or in ready mode.
- 10. LED Display**
Indicates interior oven air temperature, internal product probe temperature, time, or when used in conjunction with other keys, will review original cooking, holding and probe temperature settings. The display will also indicate various programming and diagnostic information.
- 11. Ready Indicator Light**
Illuminates when the oven has finished preheating.
- 12. UP and DOWN ARROWS**
Used to increase or decrease set time, including cooking, holding and probe temperature settings.
- 13. START Key**
Used to initiate a selected mode sequence when *pressed and released*. You may stop any mode of operation by *pressing and holding* the START Key until you hear a 2-second beep.
- 14. Green Indicator Lights**
Located within each function key, the green light functions as an operator prompt indicating additional operator action is required and also identifies current mode of operation.
- 15. Amber Indicator Lights**
Located below the COOK, TIME, PROBE and HOLD Keys, these indicators will illuminate to identify the current mode of operation and allows the operator to identify the information currently shown in the LED display.
- 16. Preset Program Keys**
Provides memory storage and operation of up to eight operator set cooking programs for specific products (A thru H). I enables locking abilities.
- 17. CANCEL Key**
Used to erase a program from memory storage.

IMPORTANT

Do not use the oven if the controls are not properly functioning. Refer to the Troubleshooting Guide located in this manual or call an authorized service technician.

OPERATING INSTRUCTIONS

OPERATING FEATURES & FUNCTIONS

To stop an operation at any time — Press and hold the START Key until the control beeps for two seconds, indicating the operation has been cancelled. The oven will remain in a power-on state.

To turn oven control panel off — Press and hold the ON/OFF Key until the oven beeps. The ON/OFF indicator light will go out.

Door open indicator — Display will flash “door” and a triple beep will alert the user. Press ON/OFF key to acknowledge error and disable triple beep.

Arrow Keys:

Cook, Hold and Probe Temperature, and the Time setting can be adjusted by pressing the Arrow keys. Pressing and releasing the Arrow key will increase settings in increments of one. To change a setting more rapidly, press and hold the Arrow key. Once the setting reaches a number divisible by 10, it will begin to increase in increments of 10.

Green and Amber Indicators:

Each program key includes a green light which indicates a requirement for additional programming by the operator or the current operational state of the oven.

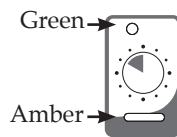

The COOK, TIME, PROBE, and HOLD keys include an amber indicator light to identify the information being displayed.

Power Fail Detect:

If the power were to fail for any reason while heating, the control will retain, in memory, the programmed operating conditions. When power is restored, the control will resume operating from the point where it was interrupted and the ON/OFF indicator light will flash, indicating that such an event did occur. The operator can acknowledge the power failure by pressing the ON/OFF key. Pressing the key will display the amount of time that the power has been off. The control will stop counting the amount of time the power has been off when it has been off for more than 24 hours.

NOTE: *If such an event has occurred, it is strongly recommended that you ensure the food is safe for consumption according to local health regulations.*

Display High/Low Probe Temperatures:

To observe the recorded maximum or minimum probe temperature when cooking by probe, press the following keys while the probe remains in the product:

Highest Temperature: Press PROBE Key and UP ARROW Key at same time.

Lowest Temperature: Press PROBE Key and DOWN ARROW Key at same time.

Probe Usage:

When the oven probe remains inserted in the probe bracket, the LED temperature display will indicate the ambient air temperature inside the oven. To use the probe for cooking remove it from the bracket and wipe the full length of the metal probe with a disposable alcohol pad to clean and sanitize before using.

Only the tip of the probe senses the internal product temperature; therefore, it is important the tip be placed correctly in the product for internal temperature accuracy. Push the probe tip halfway into the product, positioning the tip at the center of the food mass. When inserting the probe into solid foods such as meat roast or poultry breasts, push the probe in from a straight downward position or in from the side to the center position. If placing into a semi-liquid or liquid product, the probe cable must be secured to keep the probe positioned properly. Do not let the probe tip touch the edges, bottom or side of a container. Tape the probe cable to the lip or edge of the container.

NOTE: When cooking by probe, insert the probe into the raw product after the oven has been preheated.

WAIT ONE FULL MINUTE to allow the probe temperature to decrease to the internal temperature of the product. Press the start button to begin the cooking process after this probe temperature adjustment period. A false probe reading of the internal product temperature will cause the oven to default to a holding temperature.

Probe Calibration:



1. To verify product probe calibration, place the probe in a warm glass of water along with a quality independent digital thermometer and press the probe key for five (5) seconds. Compare readings.
2. If calibration is required, the unit must be in the power up hold mode. From the off state turn the unit on. The unit will begin to operate in the power up hold mode, press the probe key for eight (8) seconds until the unit beeps twice and a temperature is displayed. Adjust the probe temperature to match the independent probe by pressing the up or down arrows to increase or decrease the temperature. Repeat step 1 to verify.
3. Repeat steps 1 and 2 to verify the probe calibration as necessary.



OPERATING INSTRUCTIONS



Cook/Hold/Smoke Instructions



 **Press and release control ON/OFF key.** The oven will beep for one second and power to the unit will be indicated by an illuminated green indicator light located in the upper left corner of the ON/OFF key. The oven will begin operating in the hold mode. The amber HOLD indicator will be illuminated and the last set hold temperature will be displayed.

   **To set COOK temperature** — Press COOK Key. Oven preheat indicator will illuminate and the last set cooking temperature is displayed. To change the cook temperature, press the UP or DOWN ARROW Keys.

   **If cooking by time** — Press the TIME Key. The green TIME indicator will illuminate and the last set cooking time will be displayed. To change the set time, press the UP or DOWN ARROW Key. The display will alternate between the set temperature and the elapsed time.



   **If cooking by probe** — Press the PROBE Key. The green PROBE indicator will illuminate and the last set internal product temperature will be displayed. To change the set temperature, press the UP or DOWN ARROW Key. The display will alternate between the set temperature, the elapsed time, and the probe temperature.

   **To set HOLD temperature** — Press the HOLD Key. The green cook indicator light will remain illuminated. To change the hold temperature, press the UP or DOWN ARROW Key. The display will alternate between the set hold temperature and the amount of time the product has been in the hold mode. Oven will remain in the HOLD mode until the ON/OFF key is pressed.

   **To set Smoke time (hot smoke)** — Press SMOKER Key. To set the smoke time desired, use UP or DOWN ARROW key. The last set time will be displayed.

 **Press START key to begin cooking cycle.**

To Cook/Hold/Smoke using Preset Menu Keys

  **Press Desired PRESET Key (A through H).** PRESET Keys with stored cooking programs will have green indicator illuminated. The oven will automatically enter preheat mode. Oven will beep periodically when it has reached a preheat ready state, and both the Ready and Start indicator lights will flash. To program a preset menu key, see **Programming a Preset** in this manual.

 **Press START key to begin cooking cycle.**

CAUTION

TO MAINTAIN SAFE TEMPERATURE LEVELS, COLD FOOD FOR RETHERMALIZATION OR REHEATING MUST NEVER BE ADDED TO THE OVEN WHILE HOT FOODS ARE BEING HELD.

OPERATING INSTRUCTIONS

Programming a Preset



Select the product to be programmed and begin programming with the oven control power OFF.

Press and release control ON/OFF key. The oven will beep for one second and power to the unit will be indicated by an illuminated green indicator light located in the upper left corner of the ON/OFF key. The oven will begin operating in the hold mode. The amber HOLD indicator will be illuminated and the last set hold temperature will be displayed.



To set COOK temperature — Press COOK Key. Oven preheat indicator will illuminate and the last set cooking temperature is displayed. To change the cook temperature, press the UP or DOWN ARROW Keys.



If cooking by time — press the TIME Key. The green TIME indicator will illuminate and the last set cooking time will be displayed. To change the set time, press the UP or DOWN ARROW Key. The display will alternate between the set temperature and the elapsed time.



If cooking by probe — press the PROBE Key. The green PROBE indicator will illuminate and the last set internal product temperature will be displayed. To change the set temperature, press the UP or DOWN ARROW Key. The display will alternate between the set temperature, the elapsed time, and the probe temperature.



To set Hold temperature — Press the HOLD Key. The green cook indicator light will remain illuminated. To change the hold temperature, press the UP or DOWN ARROW Key. The display will alternate between the set hold temperature and the amount of time the product has been in the hold mode. Oven will remain in the HOLD mode until the ON/OFF key is pressed.



To set Smoke time — Press SMOKER Key. To set the smoke time desired, use UP or DOWN ARROW key. The last set time will be displayed.



Select a letter code for the product programmed by the previous steps. Press and hold the selected PRESET key for two seconds. When the preset has been saved, you will hear a one second beep and the preset light will illuminate.

Note: Only one preset can be programmed at a time. If programming an additional preset is desired, the unit must be started and stopped either by cycling the power to the cavity or by pressing the START/STOP key. The last PRESET Key used will be the oven cooking run sequence for the next product to be programmed. Settings can be manually changed for the next product and an alternate pre-programmed letter key selected.

Erasing a Preset

To erase a program, the oven must be in either the power-up hold mode or in the preheat mode. The oven cannot be running a PRESET Menu program.

When the oven is in the power-up hold mode or in the preheat mode, press and hold the CANCEL Key and then the appropriate letter PRESET Key to be erased for two seconds. When the preset has been erased the oven will beep for one second.

IMPORTANT - After programming a specific product into memory in a programmable preset key, it is very important to make a written permanent record of the product and the program letter assigned. Menu card (PE-23384) is provided for this purpose.

OPERATING INSTRUCTIONS

Preparation

Adjust the inside door vents per the individual cooking procedure selected. Always keep door vents closed when cooking with the smoking function. Insert drip pan on the bottom of the oven cavity.

Wood Chips

Soak one full tray of wood chips in water for 5 to 10 minutes. Shake off excess water, and place the moistened chips in the wood chip tray of the smoker oven. Replace the container in the oven.

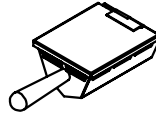

WARNING



THE USE OF IMPROPER MATERIALS FOR THE SMOKING FUNCTION COULD RESULT IN DAMAGE, HAZARD, EQUIPMENT FAILURE OR COULD REDUCE THE OVERALL LIFE OF THE OVEN.

DO NOT USE SAWDUST FOR SMOKING.

DO NOT USE WOOD CHIPS SMALLER THAN THUMBNAIL SIZE.

Hot Smoke Procedure



Press and release power switch ON/OFF Control Key.



Press and set COOK thermostat to required cooking temperature.



Press and set TIME or PROBE.



Press and set HOLD thermostat to required holding temperature.



The Oven is automatically programmed to preheat to the set cooking temperature. The oven will produce an audible signal when fully preheated.

Prepare product for cooking.
Load product on shelves.

To Set Smoking Time



Press the SMOKER Key.
Press the UP and DOWN ARROW Keys to select the smoke time in minutes.
Press START.



Note: The smoking timer activates the heating element located within the wood chip container when in either a cook or hold mode. The smoke element will not turn on during preheat or ready modes. A full wood chip container will produce smoke for a period of approximately 1 hour, even though the timer can go past one hour.

For maximum product tenderizing and to reduce labor during peak preparation hours, products can be cooked and held overnight.

These instructions are basic operational guidelines only. For complete instructions, see the HALO HEAT Guide to Low Temperature Cooking and Holding provided with the oven.

Cold Smoke Procedure



To Enter Cold Smoke Mode
Press and release power switch ON/OFF Control Key.



Press and hold the SMOKER Key for a period of 3 seconds.

To Set Cold Smoke Holding Temperature



The temperature will default to the last smoke holding temperature set by the user. The holding temperature range is 14°F to 205°F (-10°C to 96°C).



To increase this default temperature, press the HOLD Key and press the UP ARROW to set a higher default temperature.

To Set Smoking Verification Temperature (IF DESIRED)



Press the PROBE Key.
Press the UP and DOWN ARROW Keys to select the verification temperature. The probe range is 14°F to 195°F (-10°C to 91°C).

This will incorporate the probe into the cold-smoking process and the control will alarm if the temperature exceeds the probe set point.

To Set Smoking Time



Press the SMOKER Key.
Press the UP and DOWN ARROW Keys to select the smoke time in minutes.

Prepare product for smoking.
Place stainless steel tray filled with ice on shelf above the smoker tray.



Load product on shelves.
Press START.

Taste preference	Minimum Smoking time
Light Smoke Flavor	10 min.
Medium Smoke Flavor	30 min.
Heavy Smoke Flavor	40 min.
Very Heavy Smoke Flavor	60 min.
Extra Heavy Smoke Flavor	80 min.

OPERATING INSTRUCTIONS

USER OPTIONS

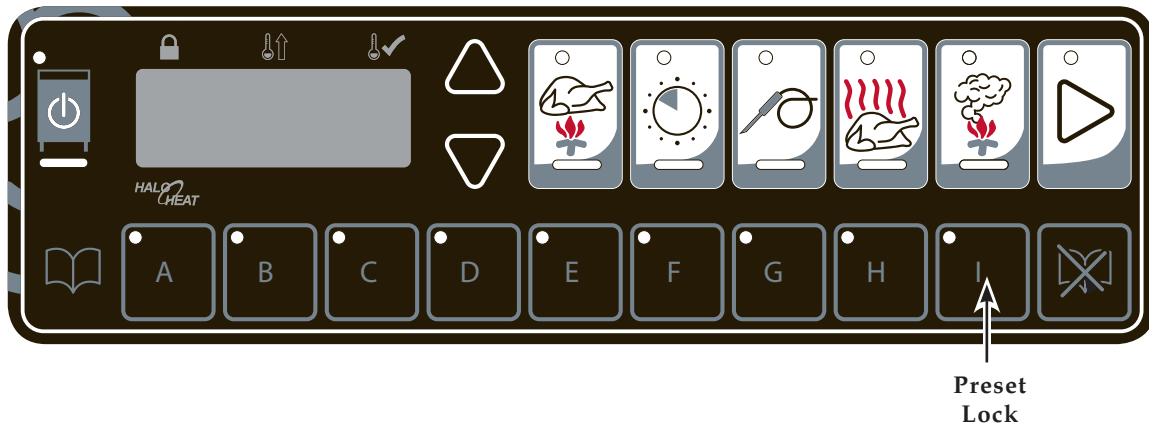

PRESET Keys Lock and Unlock

PRESET Keys A through H can be locked in order to prevent storing, altering or erasing a program.

To lock the PRESET Keys, press and hold the "I" Key until the oven beeps. Release the "I" key. The green indicator on the "I" key will illuminate. Oven PRESET Keys A through H are now locked.

Note: Only the oven PRESET keys A through H are affected by this lock-out in order to also allow the oven to be used with the unprogrammed Cook, Probe, or Hold modes.

To unlock the PRESET Keys, press and hold the CANCEL Key along with the "I" Key for two seconds until the "I" key light no longer illuminates. Release all keys. The oven preset keys are now unlocked.

Fahrenheit or Celsius Selection

With the control in the *off mode*, **press and hold** the UP ARROW Key until the display shows the current selection. Press the up or down buttons to toggle between the two options. After each change the button must be released. The display must clear before the procedure can be repeated.



Control Panel Lock and Unlock

The control panel can be locked at any time in order to prevent inadvertent or accidental setting changes.

To lock the control panel, **press and hold** the UP ARROW Key and then press the ON/OFF Key. You will hear a brief beep and the panel lock indicator will illuminate. Release all keys. The oven's control panel is now locked.



Note: The control panel is now fully locked with the exception of the ON/OFF Key and ARROW keys. You will be unable to turn the oven control off at this point.

To unlock the control panel, **press and hold** the DOWN ARROW Key and then press the ON/OFF Key. You will hear three beeps and the panel lock indicator will extinguish. Release all keys. The panel is now unlocked and ready for normal use.

Beeper Volume Selection

With the control in the *off mode*, **press and hold** the DOWN ARROW Key until the display shows the current control volume. Press the UP or DOWN ARROW Key to cycle through the four options (0 = Off, 1 = Low, 2 = Mid, 3 = High).



OPERATING INSTRUCTIONS

General Holding Guideline

Chefs, cooks and other specialized food service personnel employ varied methods of cooking. Proper holding temperatures for a specific food product must be based on the moisture content of the product, product density, volume, and proper serving temperatures. Safe holding temperatures must also be correlated with palatability in determining the length of holding time for a specific product.

Halo Heat maintains the maximum amount of product moisture content without the addition of water, water vapor, or steam. Maintaining maximum natural product moisture preserves the natural flavor of the product and provides a more genuine taste. In addition to product moisture retention, the gentle properties of Halo Heat maintain a consistent temperature throughout the cabinet without the necessity of a heat distribution fan, thereby preventing further moisture loss due to evaporation or dehydration.

When product is removed from a high temperature cooking environment for immediate transfer into equipment with the lower temperature required for hot food holding, condensation can form on the outside of the product and on the inside of plastic containers used in self-service applications. Allowing the product to release the initial steam and heat produced by high temperature cooking can alleviate this condition. To preserve the safety and quality of freshly cooked foods, however, a maximum of 1 to 2 minutes must be the only time period allowed for the initial heat to be released from the product.

Most Halo Heat Holding Equipment is provided with a thermostat control between 60° and 200°F (16° to 93°C). If the unit is equipped with vents, close the vents for moist holding and open the vents for crisp holding.

HOLDING TEMPERATURE RANGE		
MEAT	FAHRENHEIT	CELSIUS
BEEF ROAST — Rare	130°F	54°C
BEEF ROAST — Med/Well Done	155°F	68°C
BEEF BRISKET	160° — 175°F	71° — 79°C
CORN BEEF	160° — 175°F	71° — 79°C
PASTRAMI	160° — 175°F	71° — 79°C
PRIME RIB — Rare	130°F	54°C
STEAKS — Broiled/Fried	140° — 160°F	60° — 71°C
RIBS — Beef or Pork	160°F	71°C
VEAL	160° — 175°F	71° — 79°C
HAM	160° — 175°F	71° — 79°C
PORK	160° — 175°F	71° — 79°C
LAMB	160° — 175°F	71° — 79°C
POULTRY		
CHICKEN — Fried/Baked	160° — 175°F	71° — 79°C
DUCK	160° — 175°F	71° — 79°C
TURKEY	160° — 175°F	71° — 79°C
GENERAL	160° — 175°F	71° — 79°C
FISH/SEAFOOD		
FISH — Baked/Fried	160° — 175°F	71° — 79°C
LOBSTER	160° — 175°F	71° — 79°C
SHRIMP — Fried	160° — 175°F	71° — 79°C
BAKED GOODS		
BREADS/ROLLS	120° — 140°F	49° — 60°C
MISCELLANEOUS		
CASSEROLES	160° — 175°F	71° — 79°C
DOUGH — Proofing	80° — 100°F	27° — 38°C
EGGS — Fried	150° — 160°F	66° — 71°C
FROZEN ENTREES	160° — 175°F	71° — 79°C
HORS D'OEUVRES	160° — 180°F	71° — 82°C
PASTA	160° — 180°F	71° — 82°C
PIZZA	160° — 180°F	71° — 82°C
POTATOES	180°F	82°C
PLATED MEALS	140° — 165°F	60° — 74°C
SAUCES	140° — 200°F	60° — 93°C
SOUP	140° — 200°F	60° — 93°C
VEGETABLES	160° — 175°F	71° — 79°C
THE HOLDING TEMPERATURES LISTED ARE SUGGESTED GUIDELINES ONLY. ALL FOOD HOLDING SHOULD BE BASED ON INTERNAL PRODUCT TEMPERATURES. ALWAYS FOLLOW LOCAL HEALTH (HYGIENE) REGULATIONS FOR ALL INTERNAL TEMPERATURE REQUIREMENTS.		

CARE AND CLEANING

CLEANING AND PREVENTIVE MAINTENANCE

PROTECTING STAINLESS STEEL SURFACES



It is important to guard against corrosion in the care of stainless steel surfaces. Harsh, corrosive, or inappropriate chemicals can completely destroy the protective surface layer of stainless steel. Abrasive pads, steel wool, or metal implements will abrade surfaces causing damage to this protective coating and will eventually result in areas of corrosion. Even water, particularly hard water that contains high to moderate concentrations of chloride, will cause oxidation and pitting that result in rust and corrosion. In addition, many acidic foods spilled and left to remain on metal surfaces are contributing factors that will corrode surfaces.

Proper cleaning agents, materials, and methods are vital to maintaining the appearance and life of this appliance. Spilled foods should be removed and the area wiped as soon as possible but at the very least, a minimum of once a day. Always thoroughly rinse surfaces after using a cleaning agent and wipe standing water as quickly as possible after rinsing.

CLEANING AGENTS

Use non-abrasive cleaning products designed for use on stainless steel surfaces. Cleaning agents must be chloride-free compounds and must not contain quaternary salts. Never use hydrochloric acid (muriatic acid) on stainless steel surfaces. Always use the proper cleaning agent at the manufacturer's recommended strength. Contact your local cleaning supplier for product recommendations.

CLEANING MATERIALS

The cleaning function can usually be accomplished with the proper cleaning agent and a soft, clean cloth. When more aggressive methods must be employed, use a non-abrasive scouring pad on difficult areas and make certain to scrub with the visible grain of surface metal to avoid surface scratches. Never use wire brushes, metal scouring pads, or scrapers to remove food residue.

 CAUTION	
 NO SCRAPERS	TO PROTECT STAINLESS STEEL SURFACES, COMPLETELY AVOID THE USE OF ABRASIVE CLEANING COMPOUNDS, CHLORIDE BASED CLEANERS, OR CLEANERS CONTAINING QUATERNARY SALTS. NEVER USE HYDROCHLORIC ACID (MURIATIC ACID) ON STAINLESS STEEL. NEVER USE WIRE BRUSHES, METAL SCOURING PADS OR SCRAPERS.
 NO WIRE BRUSHES	
 NO STEEL PADS	

DAILY PRONG CLEANING

To ensure accurate internal product temperature readings the prongs on the removable probe must be cleaned daily.

1. Remove all food debris from prongs at the end of each production shift. Wipe the entire prong casing, and between each prong with a clean cloth and warm detergent solution.
2. Remove detergent by wiping with a cloth and clean rinse water.
3. Allow prongs to air dry before replacing detachable probe.



CARE AND CLEANING

EQUIPMENT CARE

Under normal circumstances, this oven should provide you with long and trouble-free service. There is no preventative maintenance required, however, the following Equipment Care Guide will maximize the potential life and trouble free operation of this oven.

The cleanliness and appearance of this equipment will contribute considerably to operating efficiency and savory, appetizing food. Good equipment that is kept clean works better and lasts longer.



CLEAN DAILY

1. Disconnect unit from power source and let cool.
2. Remove all detachable items such as wire shelves, side racks, and drip pans. Clean these items separately.
3. Wipe the interior metal surfaces of the oven with a paper towel to remove loose food debris.
4. Clean the interior metal surfaces of the cabinet with a damp clean cloth or sponge and any good commercial detergent.



- NOTE:** Avoid the use of abrasive cleaning compounds, chloride-based cleaners, or cleaners containing quaternary salts. Never use hydrochloric acid (muriatic acid) on stainless steel.
5. Spray heavily soiled areas with a water soluble degreaser and let stand for 10 minutes, then remove soil with a plastic scouring pad.
 6. Wipe control panel, door vents, door handles, and door gaskets thoroughly since these areas harbor food debris.
 7. Rinse surfaces by wiping with sponge and clean warm water.
 8. Remove excess water with sponge and wipe dry with a clean cloth or air dry. Leave doors open until interior is completely dry. Replace side racks and shelves.
 9. Wipe door gaskets and control panel dry with a clean, soft cloth.
 10. Interior can be wiped with a sanitizing solution after cleaning and rinsing. This solution must be approved for use on stainless steel food contact surfaces.

DANGER

DISCONNECT UNIT FROM POWER SOURCE BEFORE CLEANING OR SERVICING.

11. To help maintain the protective film coating on polished stainless steel, clean the exterior of the cabinet with a cleaner recommended for stainless steel surfaces. Spray the cleaning agent on a clean cloth and wipe with the grain of the stainless steel.

12. Clean any glass with a window cleaner.

Always follow appropriate state or local health (hygiene) regulations regarding all applicable cleaning and sanitation requirements for equipment.

CLEAN THE DOOR VENTS

Door vents need to be inspected and cleaned as required.

CLEAN THE PROBES DAILY

Remove all food soil from probes. Wipe entire probe and cable assembly with warm detergent solution and a clean cloth. Remove detergent by wiping each probe and cable with clean rinse water and a cloth. Wipe probes and probe brackets with disposable alcohol pad or sanitizing solution recommended for food contact surfaces. Allow probe and cable to air dry in probe holding bracket.

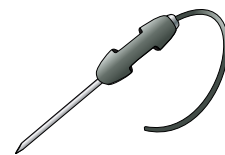

CHECK THE COOLING FAN IN THE OVEN CONTROL AREA

While the oven is warm, check that the cooling fan in the oven control area is functioning. The fan is located at the back of the unit, toward the top.

CHECK OVERALL CONDITION OF OVEN ONCE A MONTH

Check the oven once a month for physical damage and loose screws. Correct any problems before they begin to interfere with the operation of the oven.

DO NOT USE OVEN IF CONTROLS ARE NOT PROPERLY FUNCTIONING

Refer to the Troubleshooting Guide located in this manual or call an authorized service technician.

DANGER

AT NO TIME SHOULD THE INTERIOR OR EXTERIOR BE STEAM CLEANED, HOSED DOWN, OR FLOODED WITH WATER OR LIQUID SOLUTION OF ANY KIND. DO NOT USE WATER JET TO CLEAN.

SEVERE DAMAGE OR ELECTRICAL HAZARD COULD RESULT.

WARRANTY BECOMES VOID IF APPLIANCE IS FLOODED

SANITATION

Food flavor and aroma are usually so closely related that it is difficult, if not impossible, to separate them. There is also an important, inseparable relationship between cleanliness and food flavor. Cleanliness, top operating efficiency, and appearance of equipment contribute considerably to savory, appetizing foods. Good equipment that is kept clean, works better and lasts longer.

Most food imparts its own particular aroma and many foods also absorb existing odors. Unfortunately, during this absorption there is no distinction between GOOD and BAD odors. The majority of objectionable flavors and odors troubling food service operations are caused by bacteria growth. Sourness, rancidity, mustiness, stale or other OFF flavors are usually the result of germ activity.

The easiest way to insure full, natural food flavor is through comprehensive cleanliness. This means good control of both visible soil (dirt) and invisible soil (germs). A thorough approach to sanitation will provide essential cleanliness. It will assure an attractive appearance of equipment, along with maximum efficiency and utility. More importantly, a good sanitation program provides one of the key elements in the prevention of food-borne illnesses.

A controlled holding environment for prepared foods is just one of the important factors involved in the prevention of food-borne illnesses. Temperature monitoring and control during receiving, storage, preparation, and the service of foods are of equal importance.

The most accurate method of measuring safe temperatures of both hot and cold foods is by internal product temperature. A quality thermometer is an effective tool for this purpose, and should be routinely used on all products that require holding at a specific temperature.

A comprehensive sanitation program should focus on the training of staff in basic sanitation procedures. This includes personal hygiene, proper handling of raw foods, cooking to a safe internal product temperature, and the routine monitoring of internal temperatures from receiving through service.

Most food-borne illnesses can be prevented through proper temperature control and a comprehensive program of sanitation. Both these factors are important to build quality service as the foundation of customer satisfaction. Safe food handling practices to prevent food-borne illness is of critical importance to the health and safety of your customers.

HACCP, an acronym for Hazard Analysis (at) Critical Control Points, is a quality control program of operating procedures to assure food integrity, quality, and safety. Taking steps necessary to augment food safety practices is both cost effective and relatively simple. While HACCP guidelines go far beyond the scope of this manual, additional information is available by contacting:

**CENTER FOR FOOD SAFETY AND APPLIED
NUTRITION FOOD AND DRUG ADMINISTRATION
1-888-SAFEFOOD**

INTERNAL FOOD PRODUCT TEMPERATURES		
HOT FOODS		
DANGER ZONE	40° TO 140°F	(4° TO 60°C)
CRITICAL ZONE	70° TO 120°F	(21° TO 49°C)
SAFE ZONE	140° TO 165°F	(60° TO 74°C)
COLD FOODS		
DANGER ZONE	ABOVE 40°F	(ABOVE 4°C)
SAFE ZONE	36° TO 40°F	(2° TO 4°C)
FROZEN FOODS		
DANGER ZONE	ABOVE 32°F	(ABOVE 0°C)
CRITICAL ZONE	0° TO 32°F	(-18° TO 0°C)
SAFE ZONE	0°F or below	(-18°C or below)

SERVICE

TROUBLESHOOTING

Error Code	Description	Possible Cause
E-10	Cavity air sensor shorted	Cavity air sensor reading < 5°F. Verify sensor integrity. See sensor test instructions below.
E-11	Cavity air sensor open	Cavity air sensor reading > 517°F. Verify sensor integrity. See sensor test instructions below.
E-20	Product probe is shorted <i>Oven will cook in time only</i>	Product probe reading < 5°F. Verify sensor integrity. See sensor test instructions below.
E-21	Product probe is open <i>Oven will cook in time only</i>	Product Probe reading > 517°F. Verify sensor integrity. See sensor test instructions below.
E-30	Under temperature	Unit has not reached set-point for more than 90 minutes.
E-31	Over temperature	Unit has been higher than 25°F above the maximum cavity set-point for more than 2 minutes. Note: Holding Cabinets with this error code are more than 145°F higher than the maximum set-point.
E-50	Temp. measurement error	Contact factory.
E-51	Temp. measurement error	Contact factory.
E-60	Real time clock error	Data set to factory default. Ensure that date and time are correct if applicable.
E-61	Real time clock error	Contact factory.
E-78	Voltage low	Voltage below 90 VAC on a 125 VAC unit, or below 190 VAC on a 208-240 VAC unit. Correct voltage.
E-79	Voltage high	Voltage over 130 VAC on a 125 VAC unit, or over 250 VAC on a 208-240 VAC unit. Correct voltage.
E-80	EEPROM Error	Ensure that all temperatures and times are properly set. Contact factory if problem persists.
E-81	EEPROM Error	Contact factory.
E-82	EEPROM Error	Contact factory.
E-83	EEPROM Error	Contact factory.
E-85	EEPROM Error	All timers, if previously on, are now off. Possible bad EEPROM.
E-86	EEPROM Error	Stored HACCP memory corrupted. HACCP Address reset to 1. Possible bad EEPROM. Contact factory if problem persists.
E-87	EEPROM Error	Stored offsets corrupted. Offsets reset to 0. Control may need a recalibration. Possible bad EEPROM. Contact factory if problem persists.
E-88	EEPROM Error	All timer set-points are reset to 1 minute. Timers, if previously on, are now off. Possible bad EEPROM.
E-90	Button stuck	A button has been held down for >60 seconds. Adjust control. Error will reset when the problem has been resolved.
E-dS	Datakey error	Datakey digital signature incompatible. Cycle power, and install compatible Datakey if error persists.
E-dT	Datakey error	Datakey incompatible with control. Install compatible Datakey.
E-dU	Datakey unplugged	Install Datakey and cycle power to control to clear error.

Note: If in doubt, always cycle the power to the control and contact factory if the problem persists.

To test probe and air sensor:

Test probe and air sensor by placing sensor in ice water bath and using an ohmmeter set on the ohm scale. The reading should be 100 ohms resistance. If it is more than 2 ohms higher or lower, sensor needs to be replaced.

SERVICE

This section is provided for the assistance of qualified technicians only and is not intended for use by untrained or unauthorized service personnel. If your Alto-Shaam® unit is not operating properly, check the following before calling your Authorized Alto-Shaam Service Agent:

- Check that there is power flow to the unit and circuit breaker switch at back of unit is turned on.
Do not attempt to repair or service the Cook & Hold unit beyond this point. Contact Alto-Shaam for the nearest authorized service agent. Repairs made by any other service agents without prior authorization by Alto-Shaam will void the warranty on the unit.

TROUBLESHOOTING INTERNAL ELECTRICAL COMPONENTS

A. No power. Display will not light.

1. Verify that power is available at the outlet or junction box.
2. Verify that the circuit breaker switch on the back of the unit is turned on.
3. Verify that the power cord is not open. Check continuity with a VOM meter.
4. If the problem persists, call a qualified Alto-Shaam service technician at 1-800-558-8744.

B. Display is lit but unit is not heating.

Check to verify that the high limit switch located at the rear of the unit top has not been tripped. If it has been tripped, reset by pressing in the hit limit reset button at the rear of the oven.

After resetting, the cause of the high limit trip must be corrected. If the high limit switch will not reset, the high limit switch is defective and must be replaced. *This is a safety device and must not be bypassed or removed from the circuit.*



C. To test air sensor:

Test air sensor by placing sensor in ice water bath and using an ohmmeter set on the ohm scale. The reading should be 100 ohms resistance. If it is more than 2 ohms higher or lower, sensor needs to be replaced.

D. To test probe sensor:

Test food probe by placing in ice water bath and using an ohmmeter set on the ohm scale. The reading should be 100 ohms resistance.

	DANGER
	DISCONNECT UNIT FROM POWER SOURCE BEFORE CLEANING OR SERVICING.

	DANGER
	LOCK-OUT OR POST BREAKER PANEL UNTIL SERVICE WORK HAS BEEN COMPLETED.

NOTE
If the appliance has been unplugged for an extended period of time, the Real Time Clock may require recharging. Turn main breaker to the unit off for 10 seconds and then restore power. For more information, see Error Code E-60 in the Troubleshooting section of this manual.

CAUTION
THIS SECTION IS PROVIDED FOR THE ASSISTANCE OF QUALIFIED SERVICE TECHNICIANS ONLY AND IS NOT INTENDED FOR USE BY UNTRAINED OR UNAUTHORIZED SERVICE PERSONNEL.

SERVICE

EXTERIOR SERVICE VIEW (A)

767-SK/III Shown

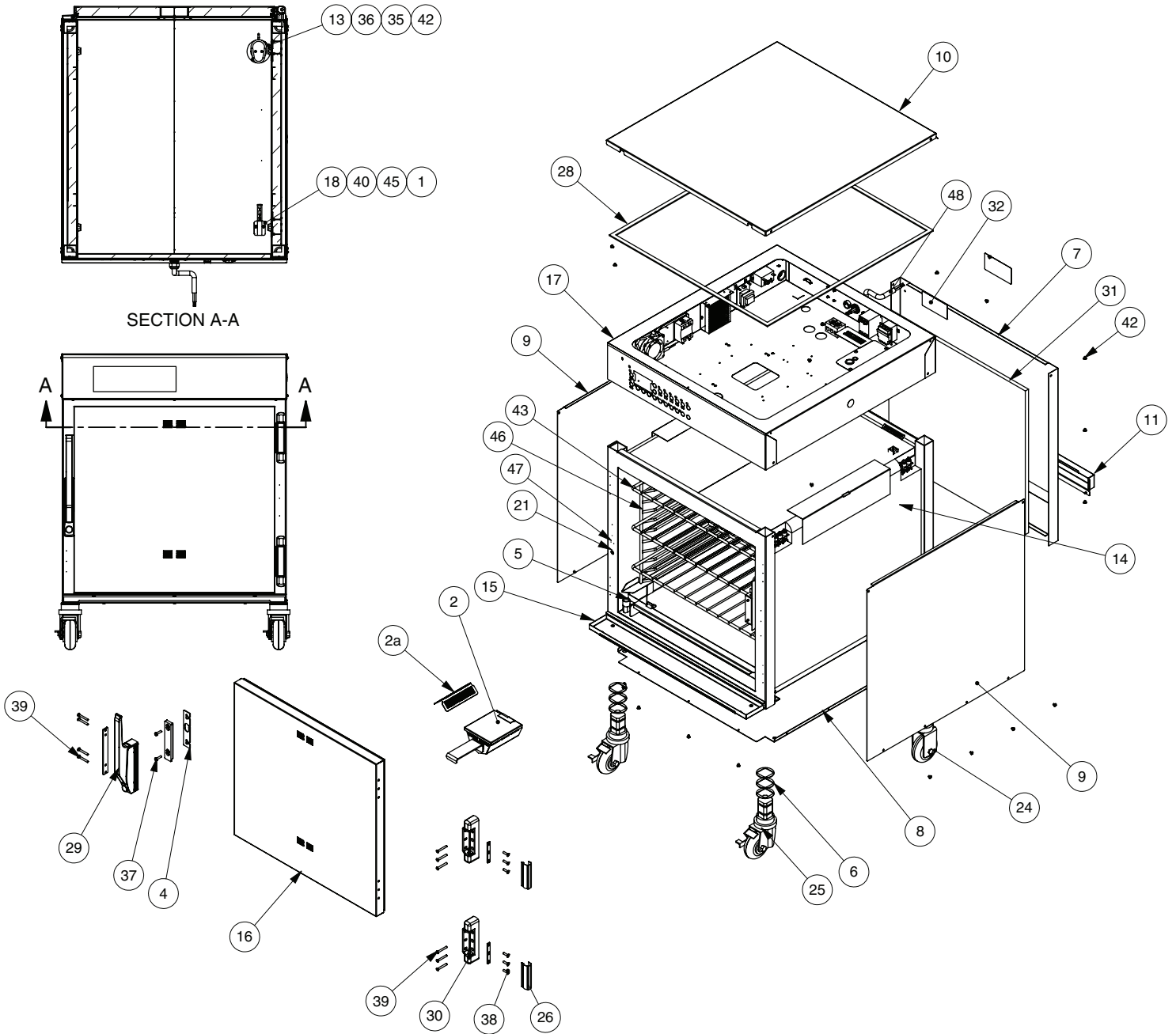

Part numbers and drawings are subject to change without notice.

⚠ DANGER

DISCONNECT UNIT FROM POWER SOURCE BEFORE CLEANING OR SERVICING.

⚠ DANGER

LOCK-OUT OR POST BREAKER PANEL UNTIL SERVICE WORK HAS BEEN COMPLETED.

SERVICE

EXTERIOR SERVICE PARTS LIST (A)

MODEL >		767-SK/III		1000-SK/III	
ITEM	DESCRIPTION	PART NO.	QTY	PART NO.	QTY
1	GUARD SENSOR	1493	1	1493	1
2	CHIP TRAY	4652R	1	4652R	1
2a	CHIP TRAY INSERT	1243	1	1243	1
3*	PROBE HOLDER	13239	1	13239	1
4	SHIM, LATCH	13947	1	13947	1
5	DRIP PAN	14831	1	5005616	1
6	CASTER SPACER	1007145	12	1007145	12
7	BACK CASING	1010393	1	1011878	1
8	BOTTOM PANEL	1010394	1	1009941	1
9	SIDE PANEL	1010395	2	1010575	2
10	BONNET, TOP COVER	1010401	1	1009951	1
11	ELEMENT COVER	1010409	1	1011813	1
12*	SMOKE HEATER PLATE WELD	5003782	1	5003782	1
13	PROBE COVER WELDMENT	5009712	1	5009712	1
14	INSULATION	IN-22364	1	IN-22364	1
15	DRIP TRAY KIT	5010391	1	5009716	1
	DRIP TRAY	1010584	1	1010188	1
	DRIP TRAY HOLDER	1010585	1	1010189	1
	SCREWS	SC-2459	3	SC-2459	3
16	DOOR ASSEMBLY, RH	5011828	1	5012859	1
	DOOR ASSEMBLY, LH	5011829	1	5012861	1
17	BONNET ASSBY, SPOT	5010047	1	5009280	1
18	BLOCK, MTG, SENSOR	BK-24427	1	BK-24427	1
19*	BLOCK, 2 TERMINAL, PORCELAIN	BK-33546	3	BK-33546	3
20*	BRACKET, CHIP TRAY	BT-29217	1	BT-29217	2
21	3/8" HOLE BUSHING, BLACK	BU-3419	1	BU-3419	1
22*	5/8" SNAP BUSHING, BLACK	BU-3611	1	BU-3611	1
23*	CABLE, SMOKE HEATER	EL-35022	1	EL-35022	1
24	CASTER, 3-1/2" RIGID	CS-25674	2	CS-25674	2
25	CASTER, 3-1/2" SWIVEL W/ BRAKE	CS-25675	2	CS-25675	2
26	COVER, HINGE	CV-22171	2	CV-22171	2
27*	GASKET ASSEMBLY, DOOR	GS-22951	1	GS-22952	1
28	GASKETS, ADHESIVE, .125 X .375 [lin ft]	GS-23622	1	GS-23622	1
29	HANDLE, OFFSET MAG LATCH	HD-27080	1	HD-27080	1
30	HINGE, 1-3/8 OFFSET, CHROME	HG-22338	1	HG-22338	1
31	INSULATION	IN-2003	1	IN-2003	1
32	RATING TAG LABEL	LA-26348	1	LA-26348	1
33*	NUT, 1/4-20 HEX S/S	NU-2437	4	NU-2437	4
34*	PANEL OVERLAY MENU CARD	PE-23384	1	PE-23384	1
35	PROBE ASSEMBLY	PR-34298	1	PR-34298	1
36	PROBE, RECEPTICAL	PR-34705	1	PR-34705	1
37	10-32 X 3/4 PHILLIPS PAN HD	SC-2071	2	SC-2071	2
38	SCREW, 10-32 X 3/4, NF, PHIL, FLAT M/S, #18-8 S/S	SC-2072	6	SC-2072	6
39	SCREW, 10-32 X 1-1/2, NF, PHIL, FLAT M/S, #18-8 S/S	SC-2073	10	SC-2073	10
40	SCREW, 6-32 X 1/2, NC PHIL, FLAT	SC-2239	2	SC-2239	2
41*	SCREW, 1/4-20 X 1/2, NC SLOT RND	SC-2332	4	SC-2332	4
42	8-32 x 1/4" PHIL SCREW	SC-2459	36	SC-2459	36
43	S/S WIRE SHELF	SH-2324	2	SH-2325	2
44*	S/S WIRE SHELF, RIB RACK	SH-2743	1	SH-29474	1
45	SENSOR, 1-3/4" L	SN-33541	1	SN-33541	1
46	SIDE RACK, STAINLESS STEEL	SR-28405	2	SR-2266	2
47	DOOR SWITCH, REED, SPST	SW-33559	1	SW-33559	1
48	CORD, 230V/50HZ ONLY	CD-3922	1	CD-3922	1

*NOT SHOWN

SERVICE

EXTERIOR SERVICE VIEW (B)

1767-SK/III Shown

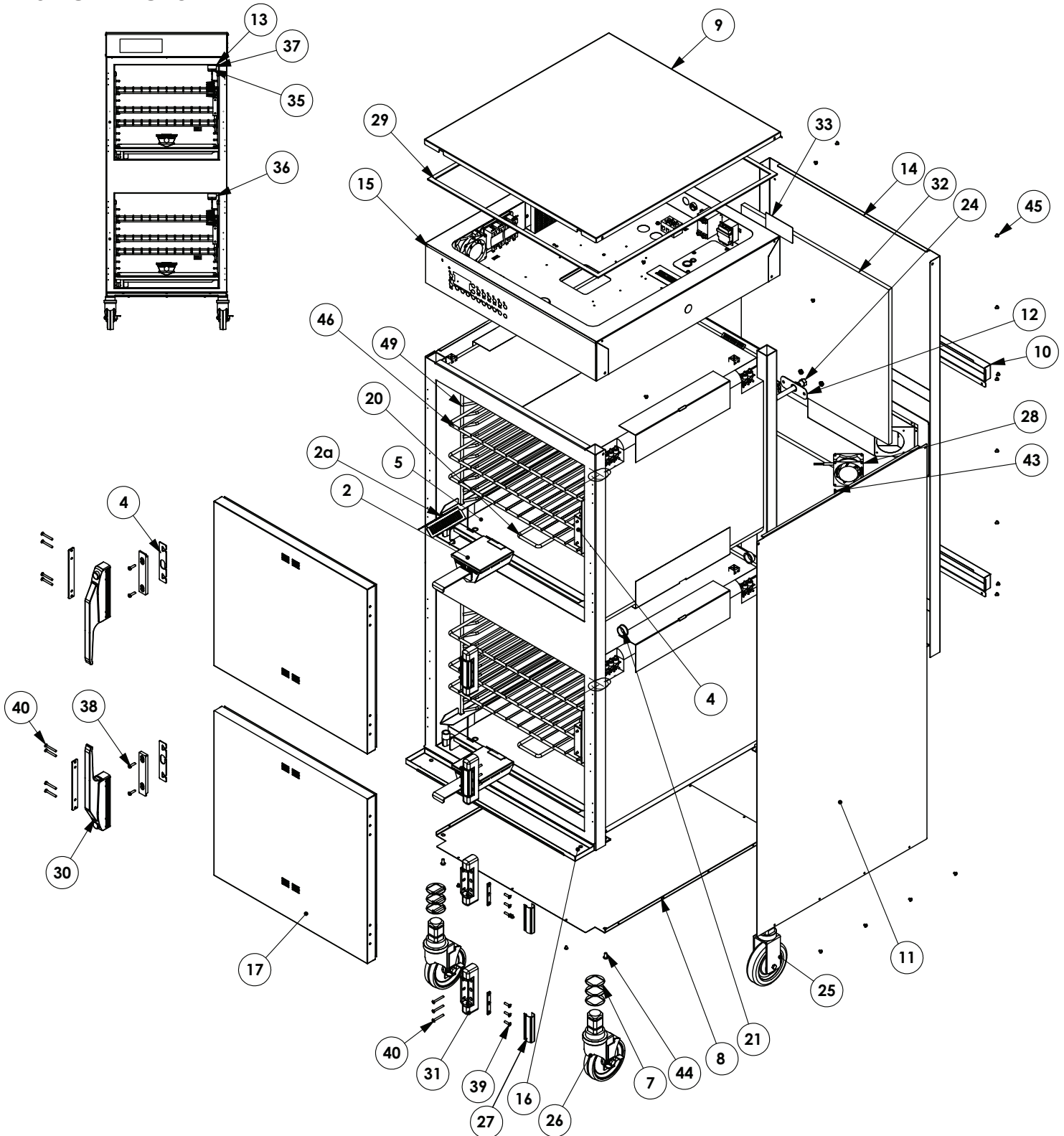

Part numbers and drawings are subject to change without notice.

SERVICE

EXTERIOR SERVICE PARTS LIST (B)

		MODEL >		1767-SK/III		1200-SK/III	
ITEM	DESCRIPTION	PART NO.	QTY	PART NO.	QTY		
1*	GUARD SENSOR	1493	2	1493	2		
2	CHIP TRAY	4652R	2	4652R	2		
2a	CHIP TRAY INSERT	1243	2	1243	2		
3*	PROBE HOLDER	13239	2	13239	2		
4	SHIM, LATCH	13947	2	13947	2		
5	DRIP PAN	14831	2	5005616	2		
6*	HI-LIMIT PROTECTION COVER	1003936	1	1003936	1		
7	CASTER SPACER	1007145	12	1007145	12		
8	BOTTOM PANEL	1010394	1	1009941	1		
9	BONNET, TOP COVER	1010401	1	1009951	1		
10	ELEMENT COVER	1010409	2	1011813	2		
11	SIDE PANEL	1010437	2	1011810	1		
12	SMOKE ELEMENT REPAIR KIT	5003782	2	5003782	2		
13	PROBE COVER WELDMENT	5009712	2	5009712	2		
14	BACK PANEL/ FAN TUNNEL ASSB	5009930	1	5012875	1		
15	BONNET ASSBY, SPOT	5010047	1	5009280	1		
16	DRIP TRAY KIT	5010391	1	5009716	1		
	DRIP TRAY	1010584	1	1010188	1		
	DRIP TRAY HOLDER	1010585	1	1010189	1		
	SCREWS	SC-2459	3	SC-2459	3		
17	DOOR ASSEMBLY	5011828	2	5012859	2		
18*	BLOCK, MTG, SNSR	BK-24427	2	BK-24427	2		
19*	BLOCK, 2 TERMINAL, PORCELAIN	BK-33546	6	BK-33546	6		
20	BRACKET, CHIP TRAY	BT-29217	2	BT-29217	2		
21	1-1/8" SNAP BUSHING	BU-3378	4	BU-3378	4		
22*	3/8" BLACK HOLE BUSHING	BU-3419	2	BU-3419	2		
23*	5/8" SNAP BUSHING, BLACK	BU-3611	2	BU-3611	2		
24	CABLE, SMOKE HEATER	EL-35022	2	EL-35022	2		
25	CASTER, 1.5" STEM, RIGID 5" WHL	CS-24874	2	CS-24874	2		
26	CASTER, 1.5" STEM, 5" SWIVEL, w/BRK-	CS-25875	2	CS-25875	2		
27	COVER, HINGE	CV-22171	4	CV-22171	4		
28	FAN, 3" BOX, 230V, THERMAL PROTECT	FA-34524	1	FA-34524	1		
29	GASKETS, ADHESIVE, .125X.375 [lin ft]	GS-23622	1	GS-23622	1		
30	HANDLE, OFFSET MAG LATCH	HD-27080	2	HD-27080	2		
31	HINGE, 1-3/8 OFFSET, CHROME	HG-22338	4	HG-22338	4		
32	INSULATION	IN-2003	2	IN-2003	2		
33	RATING TAG LABEL	LA-26348	2	LA-26348	2		
34*	NUT, 1/4-20 HEX S/S	NU-2437	4	NU-2437	4		
35	PROBE ASSEMBLY	PR-34298	2	PR-34298	2		
36	PROBE, RECEPTICAL, 2200MM WIRE	PR-34704	1	PR-34704	1		
37	PROBE, RECEPTICAL, 600MM WIRE	PR-34705	1	PR-34705	1		
38	10-32 X 3/4 PHILLIPS PAN HD	SC-2071	4	SC-2071	4		
39	SCREW, 10-32 X 3/4, NF PHIL, FLAT M/S, 18-8 S/S	SC-2072	12	SC-2072	12		
40	SCREW, 10-32 X 1-1/2, NF, PHIL, FLAT M/S, 18-8 S/S	SC-2073	20	SC-2073	20		
41*	SCREW, M4-0.7 X 6MM PHIL	SC-22271	2	SC-22271	2		
42*	SCREW, 6-32 X 1/2, NC PHIL, FLAT	SC-2239	4	SC-2239	4		
43	8-32 X 2 SLOT PAN HEAD 18-8 S.S.	SC-23154	2	SC-23154	2		
44	SCREW, 1/4-20 X 1/2, NC SLOT RND	SC-2332	6	SC-2332	6		
45*	8-32 x 1/4" PHIL SCREW	SC-2459	52	SC-2459	52		
46	S/S WIRE SHELF	SH-2324	4	SH-2325	4		
47*	S/S WIRE SHELF, RIB RACK	SH-2743	2	SH-29474	2		
48*	SENSOR, 1 3/4" L	SN-33541	2	SN-33541	2		
49	SIDE RACK, STAINLESS STEEL	SR-28405	4	SR-2266	4		
50*	DOOR SWITCH, REED, SPST	SW-33559	2	SW-33559	2		
52*	T-STAT, 300 F HI-LIMIT	TT-33476	1	TT-33476	1		



*NOT SHOWN

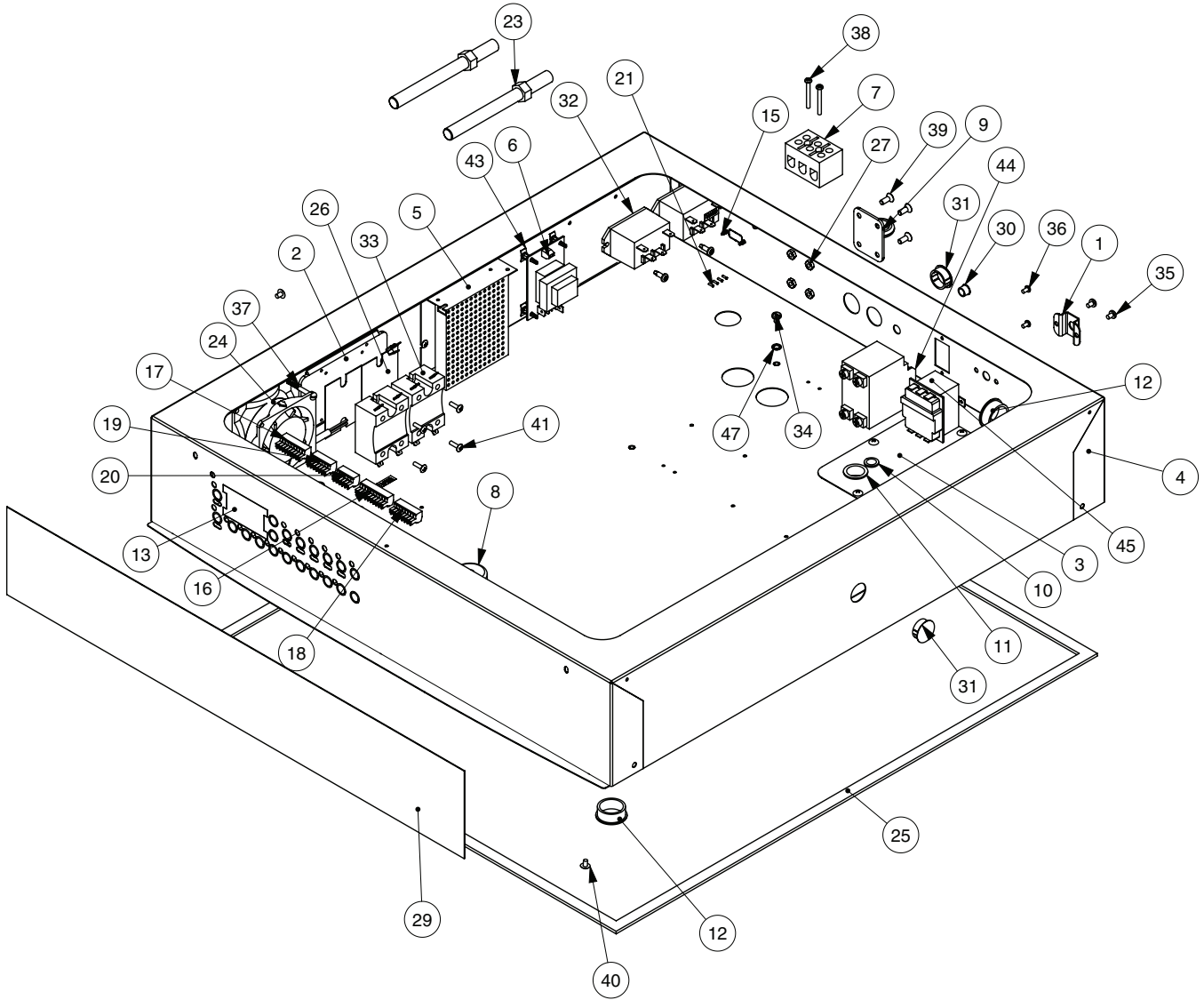

SERVICE

ELECTRONIC COMPONENTS (C)



Part numbers and drawings are subject to change without notice.

	
DANGER	
	DISCONNECT UNIT FROM POWER SOURCE BEFORE CLEANING OR SERVICING.

	
DANGER	
	LOCK-OUT OR POST BREAKER PANEL UNTIL SERVICE WORK HAS BEEN COMPLETED.

SERVICE

ELECTRONIC COMPONENTS PARTS LIST C

MODEL >		767, 1767, 1000, 1200-SK/III (QUANTITIES PER COMPARTMENT)					
ITEM	DESCRIPTION	PART NO.	QTY	ITEM	DESCRIPTION	PART NO.	QTY
1	HI-LIMIT PROTECTION COVER	1003936	1	26	HEATSINK, THERMALLY COND. PAD	HE-33926	2
2	HEAT SINK	1005836	1	27	NUT, 10-32, NF HEX MS, #18-8 S/S	NU-2215	4
3	ACCESS COVER	1009990	1	28*	NUT, HEX #8-32	NU-2296	4
4	BONNET SPOT ASSBY 767, 1767	5010047	1	29	CONTROL PANEL OVERLAY, 767	PE-27178	1
	BONNET SPOT ASSBY, 1000, 1200	5009280	1		CONTROL PANEL OVERLAY, 1767	PE-27181	1
5	BOARD, POWER SUPPLY	BA-33554	1		CONTROL PANEL OVERLAY, 1000	PE-29385	1
6	BOARD, ASSB, VOLTAGE MONITOR	BA-33764	1		CONTROL PANEL OVERLAY, 1200	PE-29386	1
7	T-BLOCK	BK-3019	1	30	3/8" HOLE PLUG	PG-25574	1
8	BEEPER	BP-3567	1	31	13/16" HOLE PLUG	PG-3589	2
9	BRACKET, TETHER	BT-26884	1	32	RELAY	RL-33558	2
10	1/2" HOLE BUSHING	BU-3006	2	33	RELAY, 230V, 25A, ZERO CROSSING	RL-33829	2
11	7/8" SNAP BUSHING, BLACK	BU-3007	1	34	10-32 X 1/4" PAN HD GROUND SCREW	SC-2190	1
12	1-1/8" SNAP BUSHING	BU-3378	6	35	SCREW, PAN HEAD M4 X 7MM	SC-22271	2
13	CONTROL, ASSB, COOK, HOLD	CC-34194	1	36	6-32 X 1/4" PAN HD	SC-22500	2
14*	CORDSET, 208-240V	CD-3607	1	37	8-32 X 2 SLOT PAN HEAD 18-8 S.S.	SC-23154	2
	CORDSET, 230V	CD-3922	1	38	6-32 X 1-1/4" ROUND HD	SC-2365	2
15	CANOE CLIP	CL-22820	2	39	10-32 X 1/2" FLAT HEAD	SC-23670	4
16	CONNECTOR, 10 PIN	CR-33717	1	40	8-32 X 1/4" PHIL SCREW	SC-2459	5
17	CONNECTOR, 9 PIN	CR-33718	1	41	SCREW, 6-32 X 1/2", NC PHIL TRUSS	SC-2472	8
18	CONNECTOR, 8 PIN	CR-33719	1	42*	SELF TAPPING 8-32 X 1/2"	SC-25849	8
19	CONNECTOR, 7 PIN	CR-33761	1	43	SPACER, LOCK MOUNT PANEL	SP-33832	4
20	CONNECTOR, 6 PIN	CR-33762	1	44	SWITCH, CIRCUIT BREAKER, 30A	SW-34076	1
21	CONNECTOR, FERRULE #18	CR-34827	4		SWITCH, CIRCUIT BREAKER, 20A	SW-34077	1
22*	DATAKEY FOR CONTROL	DS-34823	1	45	T-STAT, 300 F HI-LIMIT	TT-33476	1
23	ELEMENT, SMOKE	EL-35022	2	46*	WASHER, #8 EXT LOCK	WS-2333	4
24	FAN, BOX	FA-34524	1	47	STAR LOCK WASHER	WS-2467	1
25	GASKET, 1/2" SELF ADHESIVE	GS-2019	1				

*NOT SHOWN

CABLE HEATING KIT #4881 (ONE PER COMPARTMENT)

DESCRIPTION	PART NO.	QTY	DESCRIPTION	PART NO.	QTY
CABLE HEATING ELEMENT	CB-3045	210 FT	STUD	ST-2439	12
RING CONNECTOR	CR-3226	12	HEX NUT	NU-2215	24
INSULATION CORNER	IN-3488	1 FT	INSULATING SLEEVE	SL-3063	12
SHOULDER BUSHING	BU-3105	12	ELECTRICAL TAPE	TA-3540	1 ROLL
CUP BUSHING	BU-3106	12			

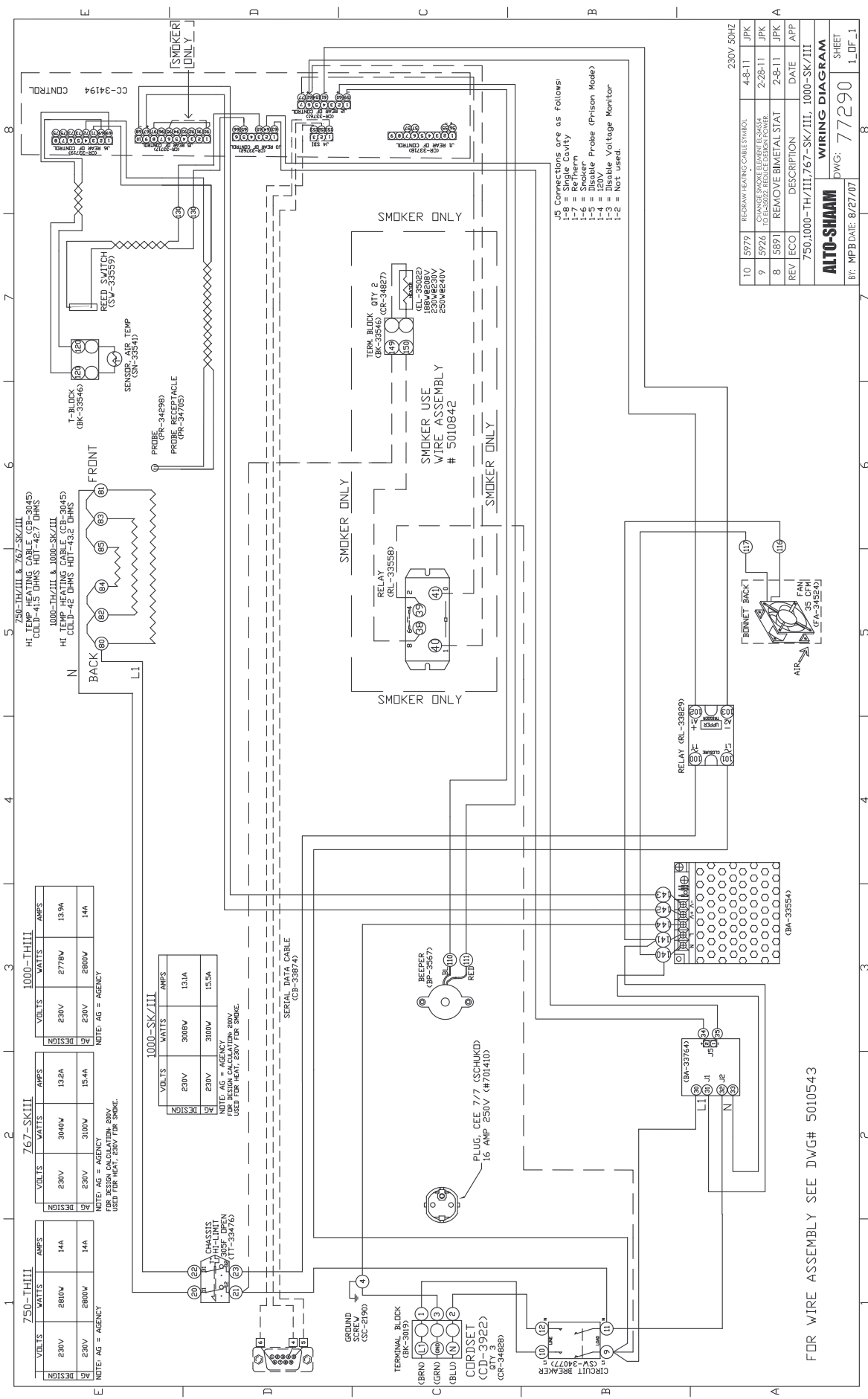

750-THIII			767-SKIII			1000-THIII		
VOLTS	WATTS	AMPS	VOLTS	WATTS	AMPS	VOLTS	WATTS	AMPS
230V	280W	14A	230V	304W	13.2A	230V	2776W	13.9A
230V	2800W	14A	230V	3100W	15.4A	230V	2800W	14A
NOTE: AG = AGENCY			NOTE: AG = AGENCY			NOTE: AG = AGENCY		

1000-SK/III		
VOLTS	WATTS	AMPS
230V	3008W	13.1A
230V	3100W	15.5A

NOTE: AG = AGENCY
FOR DESIGN CALCULATION: 800V
USED FOR HEAT: 230V FOR SMOKE

NOTE: AG = AGENCY
FOR DESIGN CALCULATION: 800V
USED FOR HEAT: 230V FOR SMOKE

REV	ECO	DESCRIPTION	DATE	APP
10	5979	RE-DRAW HEATING CABLE SYMBOL	4-8-11	JPK
9	5976	CHANGE PANE TO CHANGES 2464 TO CLASS 2; REDUCE BURN POWER	2-20-11	JPK
8	5891	REMOVE BIMETAL STAT	2-8-11	JPK
7	5891	REMOVE BIMETAL STAT	2-8-11	JPK
6	5891	REMOVE BIMETAL STAT	2-8-11	JPK
5	5891	REMOVE BIMETAL STAT	2-8-11	JPK
4	5891	REMOVE BIMETAL STAT	2-8-11	JPK
3	5891	REMOVE BIMETAL STAT	2-8-11	JPK
2	5891	REMOVE BIMETAL STAT	2-8-11	JPK
1	5891	REMOVE BIMETAL STAT	2-8-11	JPK

FOR WIRE ASSEMBLY SEE DWG# 5010543

ALTO-SHAAM
DWG: 77290
BY: MPB DATE: 8/27/07

- US Connector are as follows:
 1-8 = Single Conduit
 1-7 = Return
 1-6 = Smoker Probe (Prison Node)
 1-4 = 120V
 1-3 = Disable Voltage Monitor
 1-2 = Not used.

REV	ECO	DESCRIPTION	DATE	APP
10	5979	RE-DRAW HEATING CABLE SYMBOL	4-8-11	JPK
9	5976	CHANGE PANE TO CHANGES 2464 TO CLASS 2; REDUCE BURN POWER	2-20-11	JPK
8	5891	REMOVE BIMETAL STAT	2-8-11	JPK
7	5891	REMOVE BIMETAL STAT	2-8-11	JPK
6	5891	REMOVE BIMETAL STAT	2-8-11	JPK
5	5891	REMOVE BIMETAL STAT	2-8-11	JPK
4	5891	REMOVE BIMETAL STAT	2-8-11	JPK
3	5891	REMOVE BIMETAL STAT	2-8-11	JPK
2	5891	REMOVE BIMETAL STAT	2-8-11	JPK
1	5891	REMOVE BIMETAL STAT	2-8-11	JPK

ALTO-SHAAM
DWG: 77290
BY: MPB DATE: 8/27/07

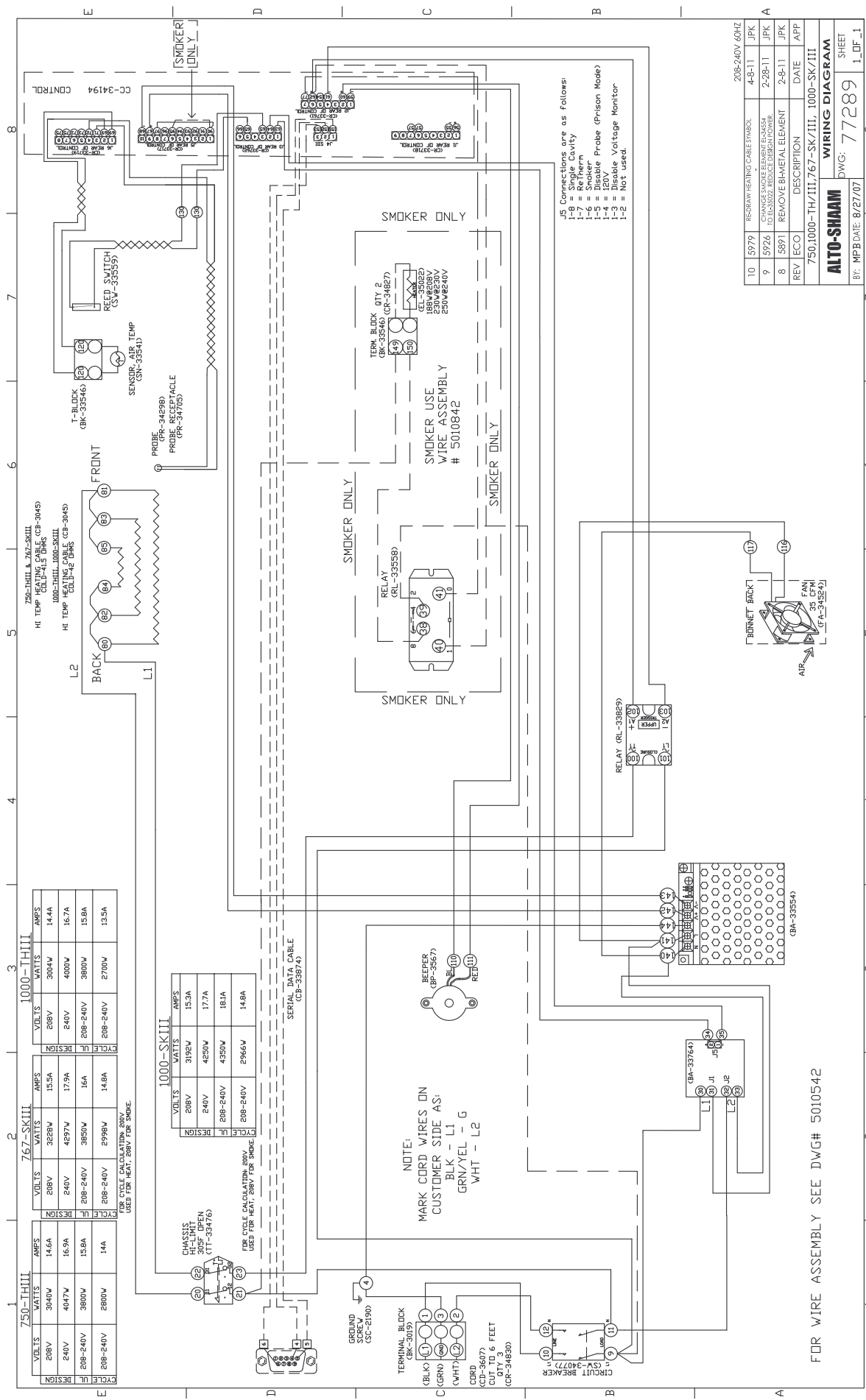

REV	ECO	DESCRIPTION	DATE	APP
10	15979	RE-DRAW HEATING CABLE SYMBOL	4-8-11	JPK
9	15926	CHANGE SMOKE ELEMENT NUMBER TO 11-3022, REDUCE RESISTANCE POWER.	2-28-11	JPK
8	5891	REMOVE BI-METAL ELEMENT	2-8-11	JPK
7	1000-TH/III, 767-SK/III, 1000-SK/III			APP

WIRING DIAGRAM
 BY: MPB DATE: 8/27/07
 DWG#: 77289
 SHEET 1_DF_1

FOR WIRE ASSEMBLY SEE DWG# 5010542

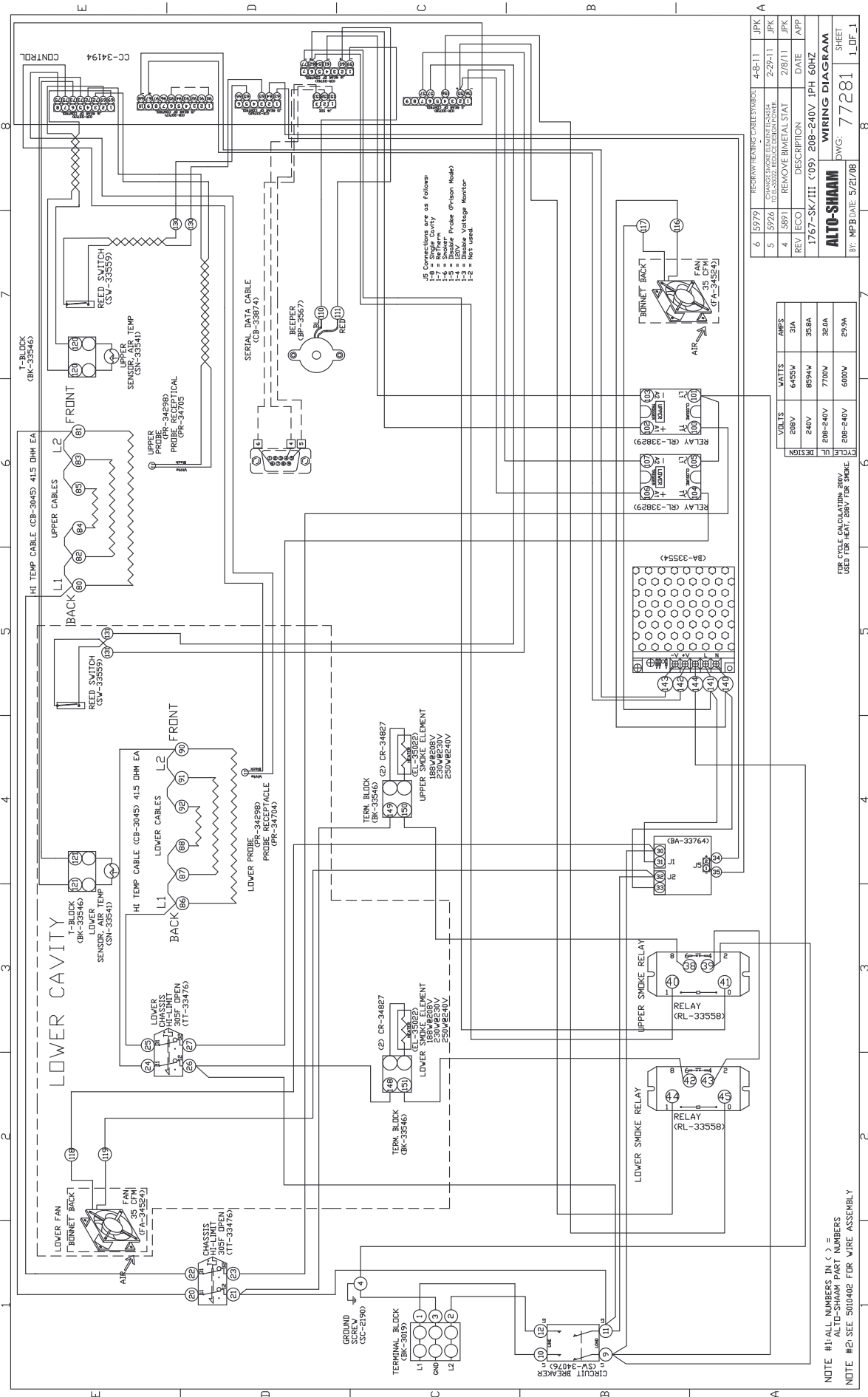

6	5979	REWORK PRINTING CABLE SYMBOL	4-8-11	JPK
5	5926	CHANGE ENGINE ELEMENT BA3454 TO EL3522 REDUCE FRESH POWER	2-29-11	JPK
4	5891	REMOVE BINETAL STAT	2/8/11	JPK
REV	ECO	DESCRIPTION	DATE	APP
1	1767	SK7III (09)	208-240V	IPH 60HZ

ALTO-SHAAM
 DWG: 77281
 BY: MPB DATE: 5/21/08

VOLTS	WATTS	AMPS
208V	6455W	31A
240V	8594W	35.8A
208-240V	7700W	36.0A
208-240V	6000W	29.9A

FOR CYCLE CALCULATION 200V
 USED FOR HEAT, 208V FOR SMOKE

NOTE #1: ALL NUMBERS IN () = ALTO-SHAAM PART NUMBERS
 NOTE #2: SEE 3010402 FOR WIRE ASSEMBLY

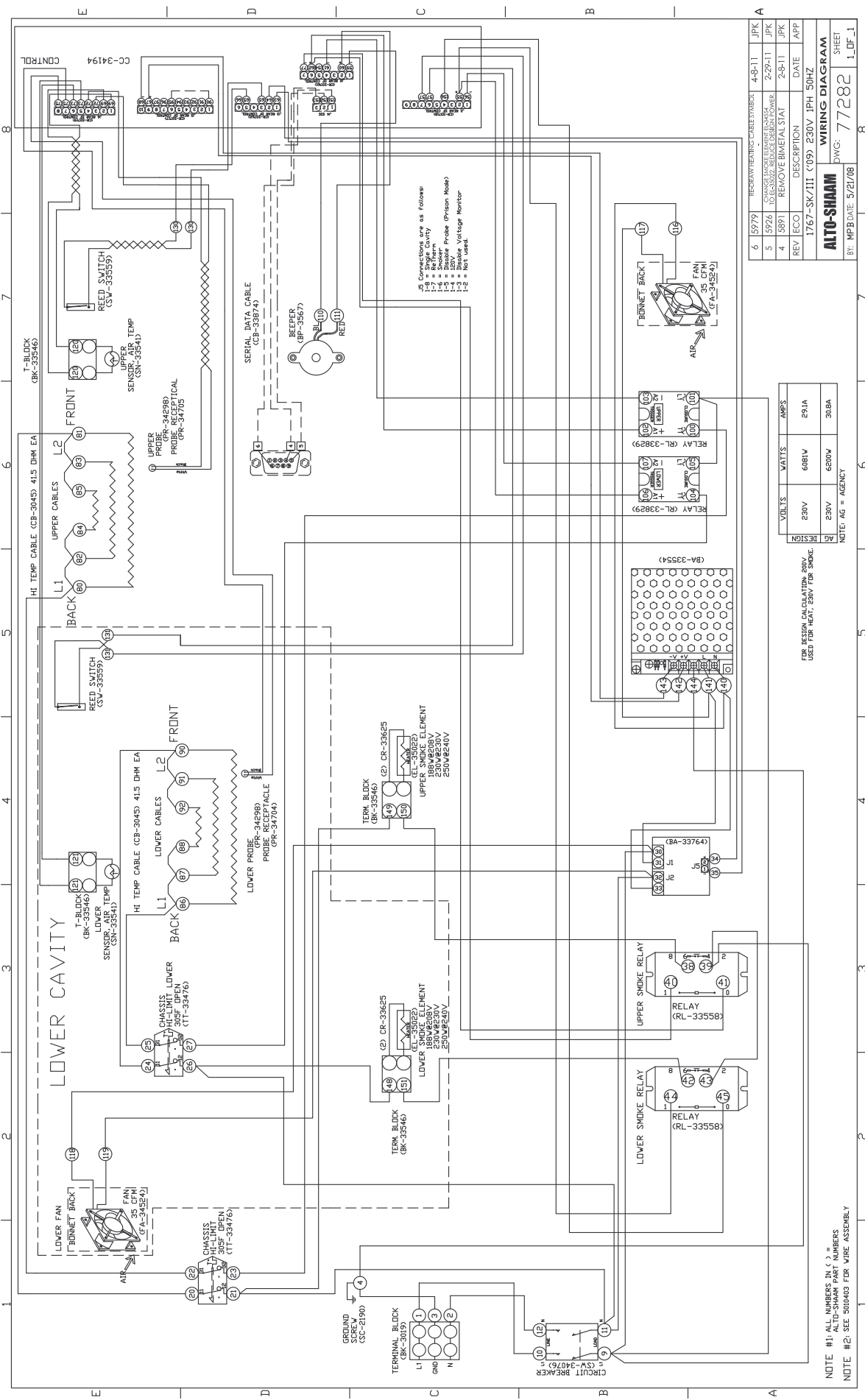

6	15779	REWORK WIRING-CABLE SYMBOLS	4-8-11	JPK
5	15926	ADD BUSHING RELAY DESIGN POWER	2-29-11	JPK
4	15891	REMOVE BIMETAL STAT	2-9-11	JPK
REV	1767-SK-III (09)	DESCRIPTION	DATE	APP
		230V 230V 1PH 50HZ		
WIRING DIAGRAM				
ALTO-SHAAM				
BY: MPB/DAE: 5/21/08				
				SHEET
				1 OF 1

VOLTS	WATTS	AMPS
230V	6081W	29.1A
230V	6200W	30.8A

NOTE: AG = AGENCY

FOR RESISTOR CALCULATION 200V USED FOR HEAT, 230V FOR SMOKE

NOTE #1: ALL NUMBERS IN () = ALTO-SHAAM PART NUMBERS
NOTE #2: SEE 300403 FOR WIRE ASSEMBLY

TRANSPORTATION DAMAGE and CLAIMS



All Alto-Shaam equipment is sold F.O.B. shipping point, and when accepted by the carrier, such shipments become the property of the consignee.

Should damage occur in shipment, it is a matter between the carrier and the consignee. In such cases, the carrier is assumed to be responsible for the safe delivery of the merchandise, unless negligence can be established on the part of the shipper.

1. Make an immediate inspection while the equipment is still in the truck or immediately after it is moved to the receiving area. Do not wait until after the material is moved to a storage area.
2. Do not sign a delivery receipt or a freight bill until you have made a proper count and inspection of all merchandise received.
3. Note all damage to packages directly on the carrier's delivery receipt.
4. Make certain the driver signs this receipt. If he refuses to sign, make a notation of this refusal on the receipt.
5. If the driver refuses to allow inspection, write the following on the delivery receipt:
Driver refuses to allow inspection of containers for visible damage.
6. Telephone the carrier's office immediately upon finding damage, and request an inspection. Mail a written confirmation of the time, date, and the person called.
7. Save any packages and packing material for further inspection by the carrier.
8. Promptly file a written claim with the carrier and attach copies of all supporting paperwork.

We will continue our policy of assisting our customers in collecting claims which have been properly filed and actively pursued. We cannot, however, file any damage claims for you, assume the responsibility of any claims, or accept deductions in payment for such claims.

LIMITED WARRANTY

Alto-Shaam, Inc. warrants to the original purchaser only that any original part that is found to be defective in material or workmanship will, at Alto-Shaam's option, subject to provisions hereinafter stated, be replaced with a new or rebuilt part.

The parts warranty period is as follows:

For the refrigeration compressor on Alto-Shaam Quickchillers™, five (5) years from the date of installation.

For the heating element on Halo Heat® cook/hold ovens, as long as the original purchaser owns the oven.

For all other parts, one (1) year from the date of installation or fifteen (15) months from the shipping date, whichever occurs first.

The labor warranty period is one (1) year from the date of installation or fifteen (15) months from the shipping date, whichever occurs first.

Alto-Shaam will bear normal labor charges performed during standard business hours, excluding overtime, holiday rates or any additional fees.

To be valid, a warranty claim must be asserted during the applicable warranty period. This warranty is not transferable.

THIS WARRANTY DOES NOT APPLY TO:

1. Calibration.
2. Replacement of light bulbs, door gaskets, and/or the replacement of glass due to damage of any kind.
3. Equipment damage caused by accident, shipping, improper installation or alteration.
4. Equipment used under conditions of abuse, misuse, carelessness or abnormal conditions, including but not limited to, equipment subjected to harsh or inappropriate chemicals, including but not limited to, compounds containing chloride or quaternary salts, poor water quality, or equipment with missing or altered serial numbers.
5. Damage incurred as a direct result of poor water quality, inadequate maintenance of steam generators and/or surfaces affected by water quality. Water quality and required maintenance of steam generating equipment is the responsibility of the owner/operator.
6. Damage caused by use of any cleaning agent other than Alto-Shaam's Combitherm® Cleaner, including but not limited to damage due to chlorine or other harmful chemicals. **Use of Alto-Shaam's Combitherm® Cleaner on Combitherm® ovens is highly recommended.**
7. Any losses or damage resulting from malfunction, including loss of product or consequential or incidental damages of any kind.
8. Equipment modified in any manner from original model, substitution of parts other than factory authorized parts, removal of any parts including legs, or addition of any parts.

This warranty is exclusive and is in lieu of all other warranties, express or implied, including the implied warranties of merchantability and fitness for a particular purpose. In no event shall Alto-Shaam be liable for loss of use, loss of revenue or profit, or loss of product, or for any indirect, special, incidental, or consequential damages. No person except an officer of Alto-Shaam, Inc. is authorized to modify this warranty or to incur on behalf of Alto-Shaam any other obligation or liability in connection with Alto-Shaam equipment.

Effective 09/10



RECORD THE MODEL AND SERIAL NUMBER OF THE APPLIANCE FOR EASY REFERENCE.

ALWAYS REFER TO BOTH MODEL AND SERIAL NUMBER IN ANY CONTACT WITH ALTO-SHAAM REGARDING THIS APPLIANCE.

Model: _____ Date Installed: _____
Voltage: _____ Purchased From: _____
Serial Number: _____

W164 N9221 Water Street • P.O. Box 450 • Menomonee Falls, Wisconsin 53052-0450 • U.S.A.

PHONE: 262.251.3800 • 800.558-8744 USA/CANADA FAX: 262.251.7067 • 800.329.8744 U.S.A. ONLY

www.alto-shaam.com

PRINTED IN U.S.A.

Free Manuals Download Website

<http://myh66.com>

<http://usermanuals.us>

<http://www.somanuals.com>

<http://www.4manuals.cc>

<http://www.manual-lib.com>

<http://www.404manual.com>

<http://www.luxmanual.com>

<http://aubethermostatmanual.com>

Golf course search by state

<http://golfingnear.com>

Email search by domain

<http://emailbydomain.com>

Auto manuals search

<http://auto.somanuals.com>

TV manuals search

<http://tv.somanuals.com>