



ALIENWARE® M18x MOBILE MANUAL

Notes, Cautions, and Warnings

 **NOTE:** A NOTE indicates important information that helps you make better use of your computer.

 **CAUTION:** A CAUTION indicates either potential damage to hardware or loss of data and tells you how to avoid the problem.

 **WARNING:** A WARNING indicates a potential for property damage, personal injury, or death.

The contents herein are subject to change without notice.

© 2011 Dell Inc. All rights reserved.

Reproduction of these materials in any manner whatsoever without the prior written permission of Dell Inc. is strictly prohibited.

Trademarks used in this manual: Alienware[®], AlienFX[®], and the AlienHead logo are trademarks or registered trademarks of Alienware Corporation; Dell[™] is a trademark of Dell Inc.; Microsoft[®], Windows[®], and the Windows start button logo  are either trademarks or registered trademarks of Microsoft Corporation in the United States and/or other countries; Intel[®] and SpeedStep[®] are registered trademarks and Core[™] is a trademark of Intel Corporation in the U.S. and other countries; Blu-ray Disc[™] is a trademark of the Blu-ray Disc Association; Bluetooth[®] is a registered trademark owned by Bluetooth SIG, Inc.

Other trademarks and trade names may be used in this manual to refer to either the entities claiming the marks and names or their products. Dell Inc. disclaims any proprietary interest in trademarks and trade names other than its own.

Regulatory Model: P12E

Regulatory Type: P12E001

P/N: P38V4

Rev. A00

February 2011

CONTENTS

CHAPTER 1: SETTING UP YOUR LAPTOP	7	CHAPTER 3: USING YOUR LAPTOP	25
Before Setting Up Your Laptop	8	Alienware Command Center	26
Connect the AC Adapter	9	Connecting External Displays	26
Press the Power Button	9	Using Removable Media and Cards	27
Connect the Network Cable (Optional)	10	Using the Optical Drive	28
Set Up Microsoft Windows	10	Using the Integrated Camera	28
Set Up WirelessHD (Optional)	11	Using the Wireless Control	28
Set Up Wireless Display (Optional)	11	Battery Pack	29
Connect to the Internet (Optional)	12	Power Management	29
CHAPTER 2: GETTING TO KNOW YOUR LAPTOP	15	Free Fall Sensor	30
Left View Features	16	Configuring the BIOS	31
Right View Features	17	CHAPTER 4: INSTALLING ADDITIONAL OR REPLACEMENT COMPONENTS	37
Back View Features	18	Before You Begin	38
Computer Base and Keyboard Features	20	Replacing the Battery Pack	40
Status Lights	21	Upgrading or Replacing Memory	41
Media Control Keys	21	Upgrading or Replacing the Hard Drive(s)	43
Power Button	22		
Function Keys	23		

CHAPTER 5: TROUBLESHOOTING	47
Basic Hints and Tips	48
Backup and General Maintenance	48
Software Diagnostic Tools	49
Answers to Common Problems	50
CHAPTER 6: SYSTEM RECOVERY	55
AlienRespawn	56
My Dell Downloads	58
CHAPTER 7: SPECIFICATIONS	59
APPENDIX	67
GENERAL AND ELECTRICAL SAFETY PRECAUTIONS	68
Contacting Alienware	70

Dear Valued Alienware Customer,

Welcome to the Alienware family. We are thrilled to include you among the growing number of savvy high-performance computer users.

The Alienware technicians who have crafted your computer have made certain that your high-performance computer is properly optimized and performs to its fullest potential. We build computers with a single unwavering purpose: Build It As If It Were Your Own. The technicians will not rest until your new computer meets or exceeds our very demanding criteria!

We have tested your computer extensively in order to ensure that you enjoy the highest levels of performance. In addition to a standard burn-in period, your computer has been evaluated using real-world tools such as synthetic performance benchmarks.

We invite you to share your experience with your new high-performance computer with us, so do not hesitate to either e-mail or call Alienware with any questions or concerns. The entire staff shares your enthusiasm for new technology and we hope that you enjoy using your new computer as much as Alienware enjoyed building it for you.

Sincerely,

Alienware Staff

~XVCXVI 8: ~OXXCX CV GCXI EVXCXC

CHAPTER 1: SETTING UP YOUR LAPTOP

Before Setting Up Your Laptop

Congratulations on the purchase of your Alienware M18x!

Read all safety and setup instructions before connecting your new laptop. Begin by carefully opening the box and removing all components that were shipped to you. Before setting up your laptop or components, be sure to inspect all items for any physical damage that may have occurred during shipment. Be sure to report any damaged items to customer service immediately upon receiving your shipment. You must report shipping damage within the first 5 days of receiving the shipment or your damage report will not be honored.

Before setting up your laptop or components, see the included invoice to verify that all items ordered are present. Report any missing components to customer service within 5 days of receiving the shipment. Anything reported missing after the first 5 days of receiving a shipment will not be honored. Some of the most common items to check for include:

- Laptop and AC adapter with power cable
- Microsoft CD-key located at the bottom of the laptop
- Monitor with power cable and video cable (if ordered)
- Keyboard (if ordered)
- Mouse (if ordered)
- Multimedia speakers and sub-woofer (if ordered)
- Joystick controllers (if ordered)

You may also need a small flathead and/or a Phillips head screwdriver for connecting peripheral cables to the laptop.

Product Documentation and Media

The documentation that ships with your Alienware laptop is designed to provide answers to many of the questions that may arise as you explore your new laptop's capabilities. You may see the documentation for technical information or general use as needed to answer questions in the future, or aid you in finding answers and solutions. The media included with your laptop is referenced in some sections of the documentation and may be needed to complete certain tasks. As always, our technical support staff is available to assist you.

Placing Your Laptop



WARNING: Do not place the laptop near or over a radiator or heating vent. If your laptop is placed in a cabinet, ensure that adequate ventilation is provided. Do not place the laptop in a humid location or in any area where the laptop may be exposed to rain or water. Be careful not to spill liquid of any kind on or into the laptop.

When placing your laptop, ensure that:

- It is placed on a surface that is both level and stable.
- The power and other cable connectors are not jammed between the laptop and a wall – or any other object.
- Nothing obstructs airflow in front of, behind, or below the laptop.
- The laptop has enough room so that optical drives and other external storage drives can be easily accessed.

Connect the AC Adapter



WARNING: The AC adapter works with electrical outlets worldwide. However, power connectors and power strips vary among countries. Using an incompatible cable or improperly connecting the cable to a power strip or electrical outlet may cause fire or equipment damage.

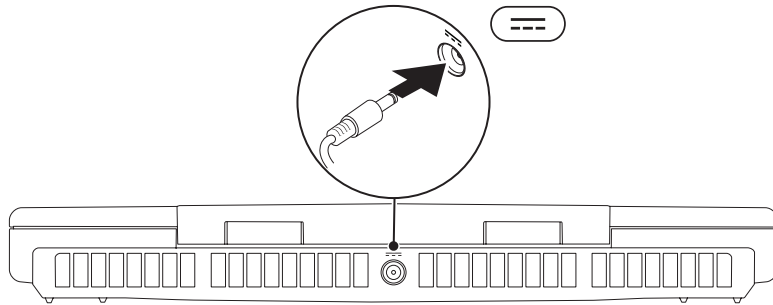

Press the Power Button

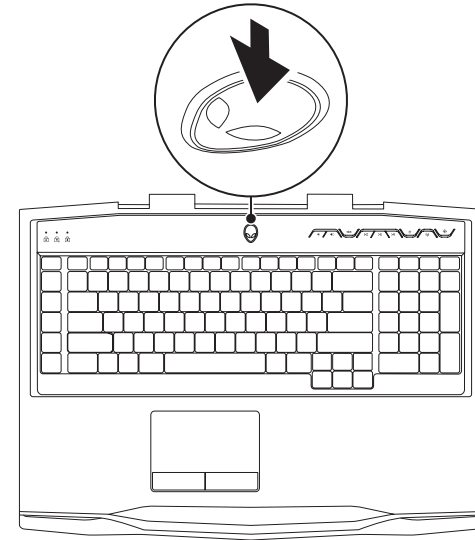

Connect the Network Cable (Optional)

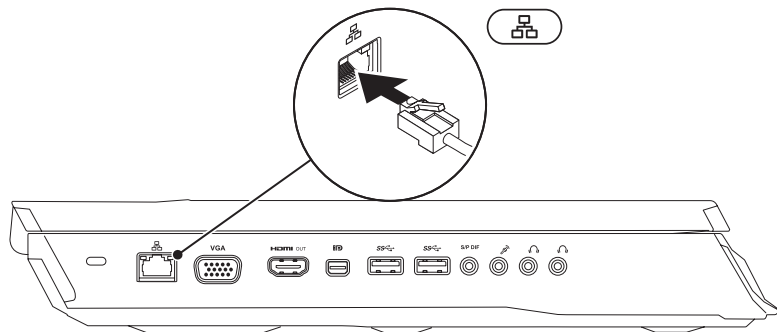

Set Up Microsoft Windows

Your computer is preconfigured with the Microsoft Windows operating system. To set up Windows for the first time, follow the instructions on the screen. These steps are mandatory and may take some time to complete. The Windows setup screens will take you through several procedures including accepting license agreements, setting preferences, and setting up an Internet connection.

CAUTION: Do not interrupt the operating system's setup process. Doing so may render your computer unusable and you will need to reinstall the operating system.

NOTE: For optimal performance of your computer, it is recommended that you download and install the latest BIOS and drivers for your computer available at support.dell.com.

NOTE: For more information on the operating system and features, see support.dell.com/MyNewDell.

NOTE: It is recommended that you create a full system backup as soon as you set up Microsoft Windows.

Set Up WirelessHD (Optional)

The WirelessHD feature allows you to share high-definition video from your computer display to a TV without the use of cables. To set up WirelessHD, use a WirelessHD kit. For instructions on setting up WirelessHD, see the document that shipped with your WirelessHD kit.



NOTE: The WirelessHD kit does not ship with your computer and must be purchased separately.

If your computer supports the WirelessHD feature, the WiHD Application Controller icon  will be available on the Windows desktop.



NOTE: You may have to set up WirelessHD kit before you set up WirelessHD. For more information on setting up the WirelessHD kit, see the document that shipped with the WirelessHD kit.

To set up WirelessHD:

1. Turn on your computer.
2. Ensure that wireless is enabled on your computer.
3. Double-click the WiHD Application Controller icon  on the desktop. The **WirelessHD Application Controller** window appears.
4. Follow the instructions on the screen.

Set Up Wireless Display (Optional)



NOTE: The wireless display feature may not be supported on all computers. For information about the hardware and software requirements for setting up wireless display, see intel.com.



NOTE: The wireless display feature is available on your computer only if you ordered an Intel Wi-Fi WLAN card and NVIDIA graphics card with Optimus technology or AMD Radeon graphics card at the time of purchase.



NOTE: It is recommended to use WirelessHD instead of wireless display for graphic-intensive applications such as high-definition gaming.

The Intel wireless display feature allows you to share your computer display to a TV without the use of cables. You must connect a wireless display adapter to your TV before setting up wireless display.



NOTE: The wireless display adapter does not ship with your computer and must be purchased separately.



NOTE: For information on setting up the wireless display, see the document that shipped with the wireless display adapter.

Connect to the Internet (Optional)

Setting Up a Wired Connection

- If you are using a dial-up connection, connect the telephone line to the optional external USB modem and to the telephone wall jack before you set up your Internet connection.
- If you are using a DSL or cable/satellite modem connection, contact your ISP or cellular telephone service for setup instructions.

To complete setting up your wired Internet connection, follow the instructions in “Setting Up Your Internet Connection” on page 13.

Setting Up a Wireless Connection



NOTE: To set up your wireless router, see the documentation that shipped with your router.

Before you can use your wireless Internet connection, you need to connect to your wireless router.

To set up your connection to a wireless router:

1. Ensure that wireless is enabled on your computer.
2. Save and close any open files, and exit any open programs.
3. Click **Start**  **→ Control Panel**.
4. In the search box, type `network`, and then click **Network and Sharing Center** **→ Connect to a network**.
5. Follow the instructions on the screen to complete the setup.

Setting Up Your Internet Connection

ISPs and ISP offerings vary by country. Contact your ISP for offerings available in your country.

If you cannot connect to the Internet but have successfully connected in the past, the Internet Service Provider (ISP) might have a service outage. Contact your ISP to check the service status, or try connecting again later.

Have your ISP information ready. If you do not have an ISP, the **Connect to the Internet** wizard can help you get one.

1. Save and close any open files, and exit any open programs.
2. Click **Start**  → **Control Panel**.
3. In the search box, type `network`, and then click **Network and Sharing Center** → **Set up a new connection or Network** → **Connect to the Internet**.

The **Connect to the Internet** window appears.



NOTE: If you do not know which type of connection to select, click **Help me choose** or contact your ISP.

4. Follow the instructions on the screen and use the setup information provided by your ISP to complete the setup.

አዲስ አበባ፣ ኢትዮጵያ፣ ጥቅምት ፳፻፲፭

CHAPTER 2: GETTING TO KNOW YOUR LAPTOP

This chapter provides information about your new laptop to familiarize you with its various features, and get you up and running quickly.

Left View Features

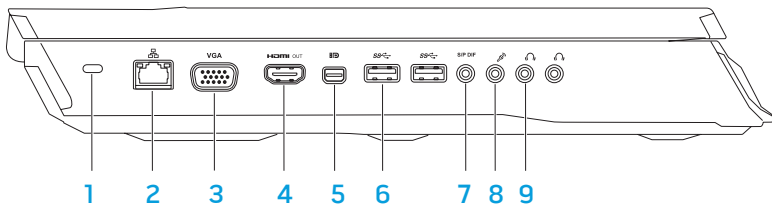

- 1 **Security cable slot** — Attaches a commercially available security cable to the computer.

NOTE: Before you buy a security cable, ensure that it fits into the security cable slot on your computer.

- 2 **Network connector** — Connects your computer to a network or broadband device.
- 3 **VGA connector** — Connects your computer to a monitor or projector.

- 4 **HDMI-output connector** — Connects to a TV for both multi-channel digital audio and video signals.



NOTE: For a monitor without built-in speakers, only the video signal will be read.

- 5 **Mini-DisplayPort connector** — Connects your computer to external DisplayPort monitors and projectors.
 - 6 **USB 3.0 connectors (2)** — Provide faster data transmission between your computer and USB devices.
 - 7 **Audio-out/Headphone/S/PDIF connector** — Connects to amplifiers, speakers, or TVs for digital audio output. Can also be used to connect to a pair of headphones, powered speakers, or sound system.
- NOTE:** Use the S/PDIF adapter that shipped with your computer, to connect a TOSLINK optical cable.
- 8 **Microphone connector** — Connects to a microphone or inputs signal for use with audio programs.
 - 9 **Headphone connectors (2)** — Connect to a pair of headphones or to a powered speaker or sound system.

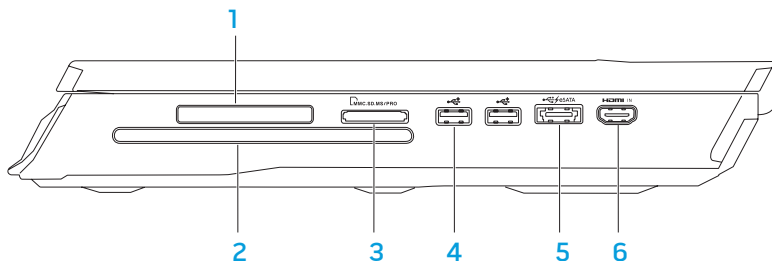
Right View Features



- 1 ExpressCard slot** — Provides support for additional memory, wired and wireless communications, multimedia, and security features. The slot supports 54 mm Express cards.
NOTE: The ExpressCard slot is designed only for ExpressCards. The slot does NOT support PC Cards.
- 2 Optical drive** — Plays or records only standard-size (12 cm) CDs, DVDs, and Blu-ray Discs (optional). Ensure that the side with print or writing is facing upward when inserting discs. For more information, see “Using the Optical Drive” on page 28.
- 3  9-in-1 Media Card Reader** — Provides a fast and convenient way to view and share digital photos, music, videos, and documents.

- 4  USB 2.0 connectors (2)** — Connect to USB devices, such as a mouse, keyboard, printer, external drive, or MP3 player.
- 5  eSATA/USB combo connector with USB PowerShare** — Connects to eSATA compatible storage devices (such as external hard drives or optical drives) or USB devices (such as a mouse, keyboard, printer, external drive, or MP3 player).
The USB Powershare feature allows you to charge USB devices when the computer is powered on/off or in sleep state.

NOTE: Certain USB devices may not charge when the computer is powered off or in sleep state. In such cases, turn on the computer to charge the device.

NOTE: You can enable or disable the option of charging the USB devices when the computer is powered off or in sleep mode through the BIOS settings.

NOTE: If you turn off your computer while charging a USB device, the device stops charging. To continue charging, disconnect the USB device and connect it again.

NOTE: The USB PowerShare is automatically shut off when only 10% of the total battery life remains.

- 6  HDMI-input connector** — Connects to the HDMI-output connector on your video device such as a DVD player, camcorder, or gaming device.
NOTE: The HDMI-input connector works only when the computer is on.

Back View Features

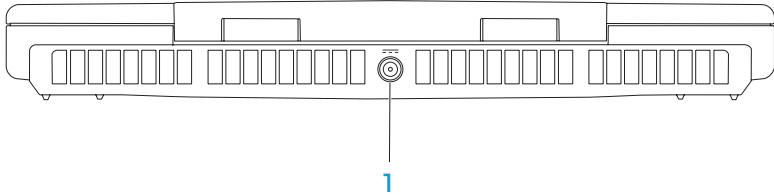

- 1  **AC adapter connector** — Connects to the AC adapter to power the computer and charge the battery.

Display Features

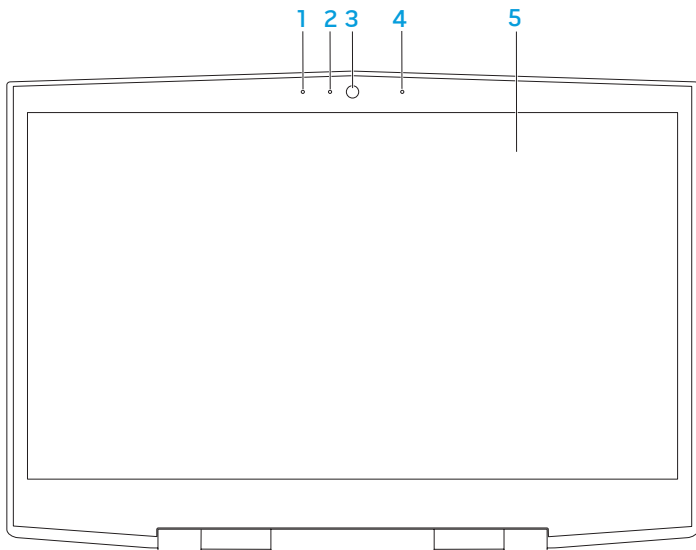

- 1 **Left digital-array microphone** — Combines with the right digital-array microphone to provide high quality sound for video chatting and voice recording.
- 2 **Camera activity indicator** — Indicates if the camera is on or off. A solid white light indicates camera activity.
- 3 **Camera** — Built-in camera for video capture, conferencing, and chat.
- 4 **Right digital-array microphone** — Combines with the left digital-array microphone to provide high quality sound for video chatting and voice recording.
- 5 **Display** — Your display can vary based on selections you made when purchasing your computer.

Computer Base and Keyboard Features

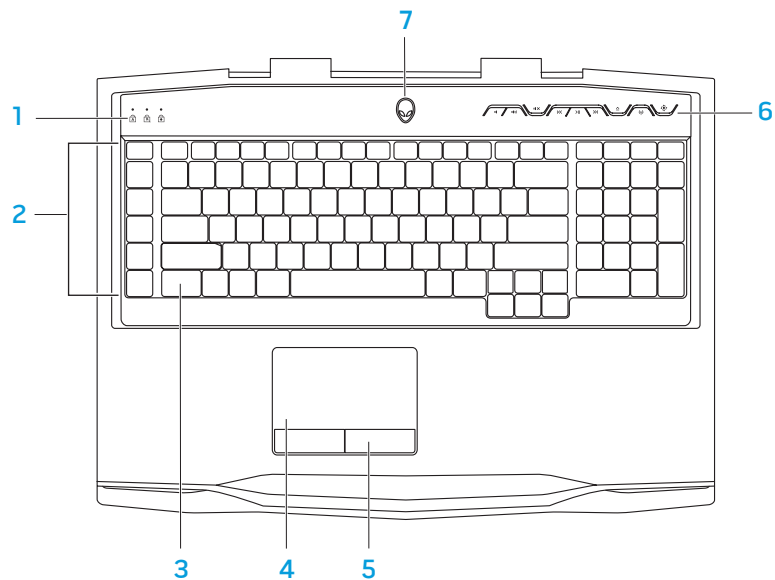

- 1 Status lights (3)** — Indicate if the Caps Lock, Number Lock, or Scroll Lock lights are turned on or off.
- 2 Macro keys** — You can assign keystrokes, predefined functions, macros, or shortcuts for your games using the TactX Macro Key Controls option available in the Alienware Command Center. For more information, see “Alienware Command Center” on page 26.
- 3 Backlit keyboard** — Illuminates to provide visibility in low lit or dark environments. You can customize the colors and effects of the backlight using the AlienFX software available in the Alienware Command Center. For more information on customizing the backlight, see “Alienware Command Center” on page 26.
- 4 Touch pad** — Provides the functionality of a mouse to move the cursor, drag or move selected items, and left-click by tapping the surface.
- 5 Touch pad buttons (2)** — Provide left- and right-click functions like those on a mouse.
- 6 Media control keys (9)** — Press the keys to perform the associated action. For more information, see “Media Control Keys” on page 21.
- 7 Power button** — Turns the computer on or off when pressed. For more information, see “Power Button” on page 22.

Status Lights

The three status lights are located at the top-left side of the keyboard. For the exact location, see “Computer Base and Keyboard Features” on page 20.



Caps Lock Light

Turns on when the keyboard is in Caps Lock mode. In this mode, all characters you type are in uppercase.



Number Lock Light

Turns on when the keyboard is in Num Lock mode. In this mode, the embedded numeric keypads can be used.



Scroll Lock Light

Turns on when the scroll lock option is on.

Media Control Keys

The media control keys are located at the top-right side of the keyboard. For the exact location, see “Computer Base and Keyboard Features” on page 20. To activate, press the desired keys. The keys will illuminate temporarily to confirm your selection.



Decrease volume



Increase volume



Mute the sound



Rewind or Play previous track



Play or Pause



Fast Forward or Play next track



Eject



Wireless Control - Switch wireless communications on/off

(for more information, see “Using the Wireless Control” on page 28)



Alienware Command Center

(for more information, see “Alienware Command Center” on page 26)

Power Button

You can program this button to perform actions like shutting down the operating system or entering the standby mode. For details on how to program this button, see **Power Options** in the control panel of Microsoft Windows operating system.

The power button is located in the center of the hinge cover. For the exact location, see “Computer Base and Keyboard Features” on page 20.

The color of the AlienHead rim indicates the power status. The color indicating the power status can be changed using the AlienFX software.



On AC adapter:

Blue or custom AC-color

The battery is fully charged.

Blue or custom AC-color fading into amber or custom battery-color

The computer is turned off or on and the battery is charging.

Blue or custom AC-color fading into black

The computer is in standby mode.

On battery:

Amber or custom battery-color

The battery is fully charged.

Amber or custom battery-color fading into black

The computer is in standby mode.

Blinking Amber or custom battery-color

The battery charge is low.

For more details on standby and hibernate mode, see **Power Options** in the control panel of your Microsoft Windows operating system.

Function Keys



NOTE: Depending on the configuration of the laptop you purchased, some of the function keys may have no associated tasks.

The <Fn> key is located at the bottom-left corner of the keyboard, and is used together with other keys to activate certain functions. Hold down the <Fn> key along with the key described below:



F1 – Suspend Mode

Press <Fn><F1> to enable the suspend mode. In the suspend mode, the display and selected devices will switch off for less energy consumption.



F2 – Check Battery Status

Press <Fn><F2> to display the Battery Status Meter.



F3 – Mute on/off

Press <Fn><F3> to enable or disable the mute function.



F4 – Increase Display Brightness

Press <Fn><F4> to increase the brightness of the display.



F5 – Decrease Display Brightness

Press <Fn><F5> to decrease the brightness of the display.



F6 – Display Mode

Press <Fn><F6> to toggle between the external displays connected.



F7 – Switchable Graphics Toggle

Press <Fn><F7> to switch between integrated and discrete graphics option.



F8 – External HDMI Input Toggle

Press <Fn><F8> to switch between external HDMI input source.



F9 – Camera on/off

Press <Fn><F9> to switch off or switch on the camera.



F10 – Microsoft Mobility Center on/off

Press <Fn><F10> to launch or close the Microsoft Mobility Center application.



F11 – AlienFX on/off

Press <Fn><F11> to enable or disable the AlienFX illumination.



F12 – Touch Pad on/off

Press <Fn><F12> to enable or disable the touch pad function and the illumination around the touch pad. When the touch pad function is switched off, the touch pad can still work temporarily for three to five seconds while the computer reboots into the Windows operating system, or resumes from standby or hibernate mode.

~XVCXOI 8: QXCV XEUI EVCXZC

CHAPTER 3: USING YOUR LAPTOP

Alienware Command Center

The Alienware Command Center gives you access to Alienware's exclusive software and is a continuously upgradable control panel. As Alienware releases new programs, they download directly into the Command Center allowing you to build a library of system management, optimization, and customization tools. You can access Alienware Command Center by pressing  on the media control keys. See "Media Control Keys" on page 21.







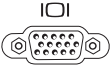
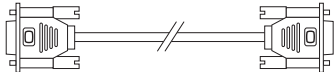
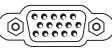

Connecting External Displays

If you want to enjoy your computing environment on a bigger scale visually, or extend your desktop area, you can connect an external display such as a standalone monitor, an LCD TV, or a projector.

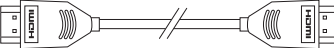
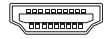
Connecting a Display

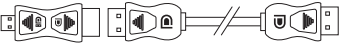
Use the appropriate cable based on the connectors available on your computer and display. Refer to the following table to identify the connectors on your computer and display.

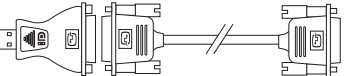
 **NOTE:** When connecting to a single display, connect the display to **ONLY ONE** of the connectors on your computer.

Connection Type	Computer	Cable	Display
VGA-to-VGA (VGA cable)			
HDMI-to-HDMI (HDMI cable)			
Mini-DisplayPort-to-DisplayPort (Mini-DisplayPort-to-DisplayPort adapter + DisplayPort Cable)			
Mini-DisplayPort-to-DVI (Mini-DisplayPort-to-DVI adapter + DVI cable)			

 **NOTE:** You can purchase the mini-DisplayPort-to-DisplayPort and mini-DisplayPort-to-DVI adapters at dell.com.

1. Turn off your laptop.
2. Turn off the display and disconnect it from the power supply.
3. Connect one end of the display cable to the VGA, mini-DisplayPort, or HDMI connector on your Alienware laptop.
4. Connect the other end of the cable to the same connector on your display.
5. If necessary, connect one end of the power cable to the display's power connector.
6. Connect the other end of the power cable to a grounded three-prong power strip or wall outlet.
7. Turn on your laptop, and then turn on your display.

Extending the Desktop

1. With the external display connected, right-click on the desktop and click **Screen resolution** or press <Fn><F7>.
2. Customize the following options:
 - a. **Display** — Select the display you would like to manage.
 - b. **Resolution** — Select the suitable display resolution.
 - c. **Orientation** — Select **Potrait** or **Landscape** depending on your display type.

- d. **Multiple Displays** — Select from the below options:
 - **Duplicate these displays**
 - **Extend these displays**
 - **Show desktop on display 1**
 - **Show desktop on display 2**
3. Click **Apply** to apply your changes and then click **OK** to exit.

Using Removable Media and Cards

Observe the safety measures below:

When no ExpressCard or Media Card (SD/MMC/MS cards) is inserted into the ExpressCard or Media Card slot, ensure that the blank cards that shipped with your laptop is inserted in the unused slot(s). The blank cards protect the unused slots from dust and other particles. When inserting a blank card, ensure that the correct side is on the top (indicated by an arrow mark on some blank cards). Inserting a blank card upside down may damage your laptop.

Using the Optical Drive

Your laptop has a slot load optical drive. Depending on the configuration ordered, your laptop may have one of the following drive types. These logos are used to indicate each drive's capabilities and media compatibility.

DVD±R/W Dual Layer Writer



DVD±R/W drive can read CD-ROM, CD-R, CD-R/W, DVD, DVD+R/W, and DVD-R/W media.

It can also record to CD-R, CD-RW, DVD+R/W, DVD-R/W, and DVD+R Dual Layer (DL) media.

Blu-ray Disc Reader/Writer



Blu-ray drive can read CD-ROM, CD-R, CD-R/W, DVD, DVD+R/W, DVD-R/W, DVD+R Dual Layer (DL), BD-ROM, BD-R, and BD-RE media.

It can also record to CD-R, CD-R/W, DVD+R/W, DVD-R/W, DVD+R Dual Layer (DL), BD-R, and BD-RE media.

Using the Integrated Camera

Turning the Camera On and Off

Press the key combination <Fn><F9> to switch on or switch off the camera. After switching on the camera, you need to activate its function through the Microsoft Windows operating system. In addition, you can also use Windows Movie Maker to create, edit, and share videos.

Using the Wireless Control

You can quickly switch on or switch off the wireless radios (Bluetooth and WLAN) using the wireless control . Gently pressing this control one time changes the state of the wireless radios.

Battery Pack

Your laptop is equipped with a high-energy rechargeable Lithium-ion (Li-ion) battery pack. Battery life varies depending on your laptop configuration, model, applications installed, power management settings, and features used. As with all batteries, the maximum capacity of this battery decreases with time and usage.

The battery-meter lights on the battery pack indicate the charge level of the battery. When you press the battery meter once, the charge level lights illuminate. Each of the five lights represent approximately 20 percent of the total battery charge. For example, if four lights turn on, there is approximately 60 percent to 80 percent of battery charge remaining and if no lights turn on, there is no charge remaining in the battery.

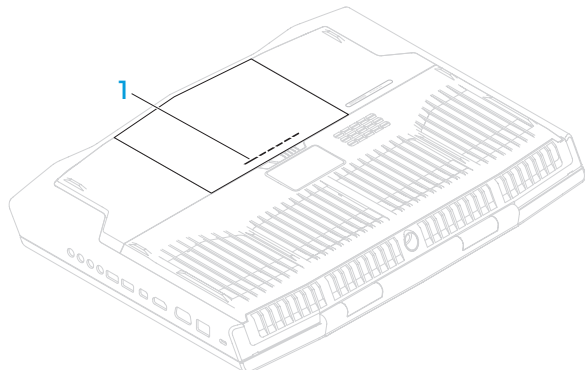

1 Battery Meter

Power Management

Understanding Power Consumption

In order to fully utilize the power of your battery, it would be a good idea for you to spend some time acquiring a basic understanding of the power management concept from your operating system.

You can use the power options in your operating system to configure the power settings on your computer. The Microsoft Windows operating system installed on your computer provides three default options:

- **Balanced** — Offers full performance when you need it and saves power during periods of inactivity.
- **Power Saver** — Saves power on your computer by reducing system performance to maximize the life of the computer and by reducing the amount of energy consumed by your computer over its lifetime.
- **High Performance** — Provides the highest level of system performance on your computer by adapting processor speed to your activity and by maximizing system performance.

Customizing Your Power Settings

1. Click **Start**  → **Control Panel**.
2. Click **All Control Panel Items**.
3. Double-click the **Power Options** icon.
4. Select a power plan from the options shown. To customize specific settings, click **Change plan settings** next to the selected power plan.

Reducing Power Consumption

Although your laptop (together with the operating system) is capable of power conservation, there are measures you can take to reduce the power consumption:

- Lower the intensity of the display backlight. A very bright screen translates to higher power usage.
- Use the **Go Dark** option in the Alienware Command Center.

You can also create application profiles for any application on your computer. This may be required for newly released games or applications that do not have a default application profile.

Changing the Application Profile Settings

1. Right-click on the desktop and select **NVIDIA Control Panel**.
2. In the **NVIDIA Control Panel** window, click **3D Settings** to expand the selection (if not already expanded) and then click **Manage 3D Settings**.
3. In the **Program Settings** tab, click **Add** and browse to select the application's executable file (.exe). Once added, you can change the settings for that application.

To change the settings for a specific application, locate the application in the **Select a program to customize:** list and make the desired changes.



NOTE: For more information on the NVIDIA control panel options and settings, click **Help**.

Free Fall Sensor

Free fall sensor protects your computer hard drive from possible damage, by detecting a free fall state caused by accidentally dropping the computer. When a free fall state is detected, the hard drive is placed in a safe state to protect against damage to the read/write head and possible data loss. Your hard drive returns to normal operation, when the free fall state is no longer detected.

Configuring the BIOS

System Setup

The System Setup options allow you to:

- Change the system configuration information after you add, change, or remove any hardware in your laptop.
- Set or change a user-selectable option.
- View the installed amount of memory or set the type of hard drive installed.

Before you use System Setup, it is recommended that you write down the current System Setup information for future reference.



CAUTION: Do not change the settings in System Setup unless you are an expert computer user. Certain changes can cause your computer to work incorrectly.

Entering System Setup

1. Turn on (or restart) your laptop.



NOTE: Keyboard failure may result when a key on the keyboard is held down for extended periods of time. To avoid possible keyboard failure, press and release <F2> in even intervals until the System Setup screen appears.

2. While the laptop is booting, press <F2> immediately before the operating system logo appears to access the **BIOS Setup Utility**. If an error occurs during POST (Power On Self Test), you may also enter the **BIOS Setup Utility** by pressing <F2> when prompted.



NOTE: If you wait too long and the operating system logo appears, continue to wait until you see the Microsoft® Windows® desktop, then shut down your laptop and try again.

System Setup Screens

The **BIOS Setup Utility** window displays current or changeable configuration information for your laptop. Information is divided into five menus: **Main**, **Advanced**, **Security**, **Boot**, and **Exit**.

Key functions appear at the bottom of the **BIOS Setup Utility** window and lists keys and their functions within the active field.

System Setup Options

 **NOTE:** Depending on your computer and installed devices, the items listed in this section may not appear, or may not appear exactly as listed.

 **NOTE:** For the updated system setup information, see the *Service Manual* at support.dell.com/manuals.

Main Menu

System Time (hh:mm:ss)	Displays the system time.
System Date (mm/dd/yyyy)	Displays the system date.
Alienware	Displays the model number of your computer.
Service Tag	Displays the service tag of your computer.
BIOS Version	Displays the BIOS version.
EC Version	Displays the EC firmware version.
ME Version	Displays the Intel ME firmware version.
CPU	Displays the type of processor installed.

Main Menu

CPU Frequency	Displays the speed of the processor.
CPU L3 Cache	Displays the processor cache size.
CPUID	Displays the ID of the processor.
Integrated Graphics	Displays the integrated graphics.
Discrete Graphics 1	Displays the primary discrete graphics.
Discrete Graphics 2	Displays the secondary discrete graphics.
Total Memory	Displays the total memory available in your computer.
Memory Bank 0	Displays the memory size installed in DIMM 0.
Memory Bank 1	Displays the memory size installed in DIMM 1.
Memory Bank 2	Displays the memory size installed in DIMM 2.
Memory Bank 3	Displays the memory size installed in DIMM 3.

Advanced Menu

Intel SpeedStep	Allows you to enable or disable the Intel SpeedStep technology. Disabling this feature may improve performance, but will greatly reduce battery life.
Virtualization	Allows you to enable or disable the Intel Virtualization technology.
USB Emulation	Allows you to enable or disable the USB emulation feature. This feature defines how the BIOS, in the absence of a USB-aware operating system, handles USB devices. USB emulation is always enabled during POST. NOTE: You cannot boot from any type of USB device (floppy, hard drive, or memory key) when this option is disabled.
USB Wake Support	Allows you to enable USB devices to wake the computer from standby or to disable the USB wake support feature. NOTE: If USB Powershare is enabled, a device connected to the USB Powershare connector may not wake the computer.

Advanced Menu

USB Power Share	Allows you to charge USB devices when the computer is turned off or in standby mode. <ul style="list-style-type: none">AC Only: Charge USB devices when connected to AC adapter only.AC and Battery: Charge USB devices when connected to AC adapter and when the computer is running on battery.Disabled: Disables USB PowerShare.
Integrated Network	Allows you to enable or disable the on-board LAN controller. <ul style="list-style-type: none">Disabled: Internal LAN is disabled and is not visible to the operating system.Enabled: Internal LAN is enabled.
High Definition Audio	Allows you to enable or disable the internal high definition audio device. <ul style="list-style-type: none">Disabled: The internal audio device is disabled and is not visible to the operating system.Enabled: The internal audio device is enabled.
SD-Card Reader	Allows you to enable or disable the internal SD card reader.
CPU Turbo Mode	Allows you to enable or disable the Intel CPU turbo mode performance option.

Advanced Menu

Performance Options	Allows you to configure fields in the Performance Options sub-menu (for more information, see "Advanced Menu – Performance Options" on page 34).
SATA Operation	Allows you to configure the operating mode of the integrated SATA hard drive controller. <ul style="list-style-type: none">AHCI: SATA is configured for AHCI mode.RAID: SATA is configured for RAID mode.
SATA HARD DRIVE 1	Displays the installed primary SATA hard drive model.
SATA HARD DRIVE 2	Displays the installed secondary SATA hard drive model.
Adapter Warnings	Allows you to choose if the computer should display warning messages when you use AC adapters that are not supported by your computer. <ul style="list-style-type: none">Disabled: BIOS will not detect unsupported AC adapters and will not display any message to screen.Enabled : BIOS will detect unsupported AC adapters and display an error to screen.
Charger Behavior	Allows you to enable or disable battery charging.
Primary Display	Allows you to choose a primary display.

Advanced Menu – Performance Options

Overclocking Feature	Allows you to enable or disable the global overclocking feature. <ul style="list-style-type: none">Disabled: The overclocking feature is disabled.Enabled: Displays additional overclocking options.
Non-Turbo Flex Support	Allows you to modify the CPU flex ratio with Turbo Mode disabled.
Flex Ratio Override	Appears when Non-Turbo Flex is enabled and allows you to specify the flex ratio for all CPU cores.
Extreme Edition	Allows Extreme Edition CPUs to adjust the flex ratio in a Turbo Mode environment that allows each individual core ratio to be modified.
Extreme Edition Core Ratio Limits	Allows you to modify the flex ratio of individual cores physically present in the CPU.
Memory Override Support	Allows you to enable or disable the memory override option support. <ul style="list-style-type: none">Disabled: The memory override support is disabled.Enabled: Displays additional memory override support options.
Memory Voltage	Allows you to modify memory voltage.
Memory Frequency	Allows you to modify memory frequency.

Advanced Menu – Performance Options

DIMM Profile (XMP)	Allows you to select different XMP options.
Override Turbo Settings	Allows you to override CPU Turbo Mode settings.
Long Duration PWR Limit	Allows you to specify the Turbo Mode power limit 1 in Watts. The value may vary from 0 to the fused value. A value of 0 programs this value to the fused limit. You cannot specify a value greater than the fused limit.
Long Duration Time Window	Power Limit 1 time value in seconds. Indicates the time window over which TDP value should be maintained. A value of 0 programs this value to the fused limit.
Short Duration PWR Limit	Allows you to enable or disable the Short Duration Power Limit.
Short Duration PWR Limit	Turbo Mode Power Limit 2 value in Watts.
Short Duration PWR Limit	A value of 0 programs this value to 1.25 x TDP.

Wireless Menu

Bluetooth	Allows you to enable or disable the internal Bluetooth device. <ul style="list-style-type: none">Disabled: The internal Bluetooth device is disabled and is not visible to the operating system.Enabled: The internal Bluetooth device is enabled.
Wireless Network	Allows you to enable or disable the internal wireless device. <ul style="list-style-type: none">Disabled: The internal wireless device is disabled and is not visible to the operating system.Enabled: The internal wireless device is enabled.
DMC	Allows you to enable or disable the internal DMC device.
Wireless Switch/Hotkey	Allows you to choose which wireless devices are controlled by the wireless switch/hotkey.

Security Menu

Supervisor Password	Displays if the supervisor password is clear or set.
User Password	Displays if the user password is clear or set.

Security Menu

Set Service Tag	Displays the service tag of the computer when the service tag is present.
	Displays a field to input the service tag manually when the service tag is absent.
Set Supervisor Password	Allows you to set the supervisor password. The supervisor password controls access to the system setup utility.
Set User Password	Allows you to set the user password. The user password controls access to the computer at boot.
Computrace	Allows you to enable or disable Computrace security feature.

Boot Menu

Use the up or down arrow keys to change the boot device priority. You can choose from:

- Hard Drive
- USB Storage
- CD/DVD/BD
- Removal Devices
- Network

Exit Menu

Exit Saving Changes	Allows you to exit System Setup and save your changes to CMOS.
Save Change Without Exit	Allows you remain in System Setup and save your changes to CMOS.
Exit Discarding Changes	Allows you to exit System Setup and load previous values from CMOS for all Setup items.
Load Optimal Defaults	Allows you to load default values for all Setup items.
Discard Changes	Allows you to load previous values from CMOS for all Setup items.

אֲנִי מְבַרְכֶיךָ יְיָ אֱלֹהֵינוּ
עַל כָּל הַמַּעֲשֵׂים אֲשֶׁר עָשִׂיתָ

CHAPTER 4: INSTALLING ADDITIONAL OR REPLACEMENT COMPONENTS

Before You Begin

This section provides procedures for removing and installing the components in your laptop. Unless otherwise noted, each procedure assumes that the following conditions exist:

- You have performed the steps in “Turning Off Your Computer” and “Before Working Inside Your Computer” in this section.
- You have read the safety information that shipped with your computer.
- A component can be replaced or—if purchased separately—installed by performing the removal procedure in reverse order.

Turning Off Your Computer





CAUTION: To avoid losing data, save and close all open files and exit all open programs before you turn off your laptop.

1. Save and close all open files and exit all open programs.
2. Click **Start**  → **Shut Down**.
The laptop turns off after the operating system shutdown process finishes.
3. Ensure that the computer is turned off. If your computer did not automatically turn off when you shut down your operating system, press and hold the power button until the computer turns off.

Before Working Inside Your Computer

Use the following safety guidelines to help protect your computer from potential damage and to help to ensure your own personal safety.

 **WARNING:** Before working inside your laptop, read the safety information that shipped with your computer. For additional safety best practices information, see the Regulatory Compliance Homepage at dell.com/regulatory_compliance.

 **CAUTION:** Handle components and cards with care. Do not touch the components or contacts on a card. Hold a card by its edges. Hold a component such as a processor by its edges, not by its pins.

 **CAUTION:** Only a certified service technician should perform repairs on your computer. Damage due to servicing that is not authorized by Dell is not covered by your warranty.

 **CAUTION:** To avoid electrostatic discharge, ground yourself by using a wrist grounding strap or by periodically touching an unpainted metal surface (such as a connector on the back of the computer).

 **CAUTION:** When you disconnect a cable, pull on its connector or on its pull-tab, not on the cable itself. Some cables have connectors with locking tabs; if you are disconnecting this type of cable, press in on the locking tabs before you disconnect the cable. As you pull connectors apart, keep them evenly aligned to avoid bending any connector pins. Also, before you connect a cable, ensure that both connectors are correctly oriented and aligned.

 **CAUTION:** To avoid damaging the computer, perform the following steps before you begin working inside the computer.

1. Ensure that the work surface is flat and clean to prevent the computer cover from being scratched.
2. Turn off your computer (see “Turning Off Your Computer” on page 38).

 **CAUTION:** To disconnect a network cable, first unplug the cable from your computer and then unplug the cable from the network device.

3. Disconnect all telephone or network cables from the laptop.
4. Press and eject any installed cards from the ExpressCard slot and the Media Card slot.
5. Disconnect your computer and all attached devices from their electrical outlets.

 **CAUTION:** To help prevent damage to the system board, you must remove the battery from the battery bay before you service the laptop.

6. Remove the battery from the battery bay (see “Replacing the Battery Pack” on page 40).
7. Press the power button to ground the system board.

Replacing the Battery Pack

This battery pack can easily be removed and replaced. Ensure that the laptop is properly shut down before changing the battery pack.

 **CAUTION:** To avoid damage to the laptop, use only the battery designed for this particular Alienware laptop. Do not use batteries designed for other Alienware or Dell laptops.

To remove the battery pack:

1. Follow the instructions in "Before You Begin" on page 38.
2. Shut down the laptop and turn it over.
3. Slide the battery latch to the unlock position as shown. The battery pack pops up.
4. Remove the battery pack.

To replace the battery pack, perform the removal steps in reverse order.

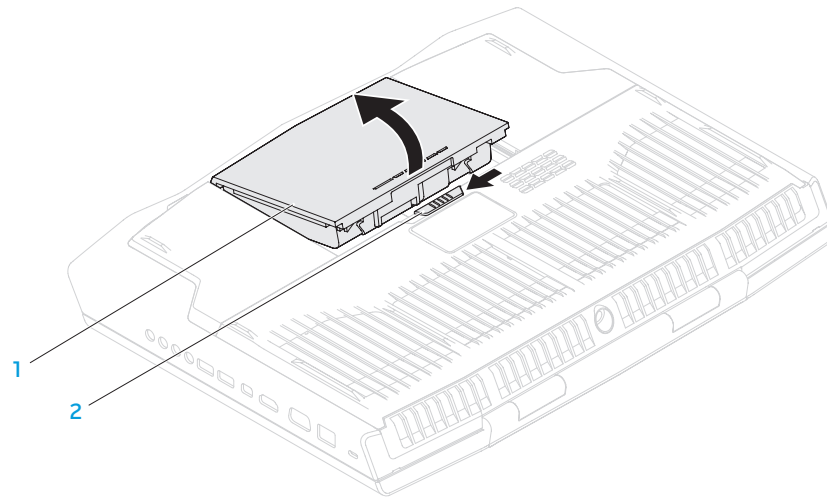

1 battery pack

2 battery latch

Upgrading or Replacing Memory

Your laptop is equipped with a configurable memory unit. The industry standard JEDEC PC3-12800 (DDR3-1600) SODIMM memory module connectors are available for memory upgrade.



NOTE: If you purchased a dual-core processor, your computer supports only memory module connectors DIMM A and DIMM B.



NOTE: The table below illustrates one possible way the system memory can be configured. You can also configure the system memory by installing memory modules in connectors DIMM C and DIMM D.

Memory connector DIMM A	Memory connector DIMM B	Memory connector DIMM C	Memory connector DIMM D	Total memory
2 GB	2 GB	—	—	4 GB
2 GB	4 GB	—	—	6 GB
4 GB	4 GB	—	—	8 GB
8 GB	8 GB	—	—	16 GB
8 GB	8 GB	8 GB	8 GB	32 GB

Removing the Memory Module(s)



NOTE: Your computer supports up to four memory module connectors. You can access connectors DIMM A and DIMM B by removing the compartment door at the bottom of your computer. To upgrade memory module(s) in connectors DIMM C and DIMM D, see the *Service Manual* at support.dell.com/manuals.

1. Follow the instructions in “Before You Begin” on page 38.
2. Remove the battery (see “Replacing the Battery Pack” on page 40).
3. Remove the four screws that secure the compartment door to the computer base.
4. Slide the compartment door towards the rear of the computer, lift it up, and then remove it from the computer.

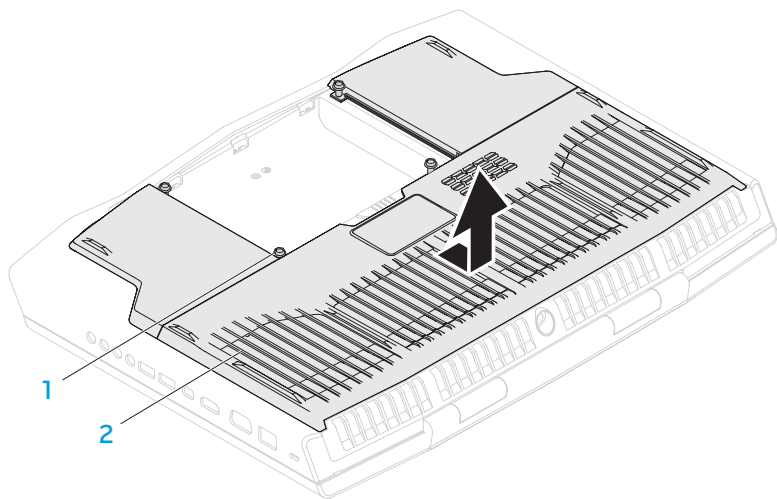

1 screws (4)

2 compartment door

5. Use your fingertips to carefully spread apart the memory-module connector's spring locks until the memory module pops up.
6. Remove the memory module.

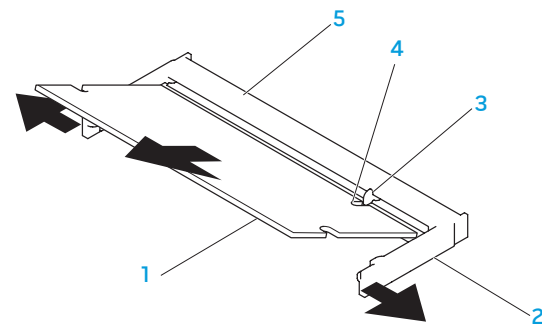

1 memory module

2 spring locks (2)

3 tab

4 notch

5 memory-module connector

To replace the memory modules, perform the removal steps in reverse order. While inserting the memory module into the connector align the notch on the memory module with the tab on the memory module connector.



NOTE: If you need to install memory modules in two connectors, install a memory module in the lower connector before you install a memory module in the upper connector.



NOTE: If the memory module is not installed properly, the computer may not boot.

Upgrading or Replacing the Hard Drive(s)

Your laptop is equipped with two hard drives.

Removing the Hard Drive(s)

1. Follow the instructions in "Before You Begin" on page 38.
2. Remove the battery pack (see "Replacing the Battery Pack" on page 40).
3. Remove the four screws that secure the compartment door to the computer base.
4. Slide the compartment door towards the rear of the computer, lift it up, and remove it from the computer.

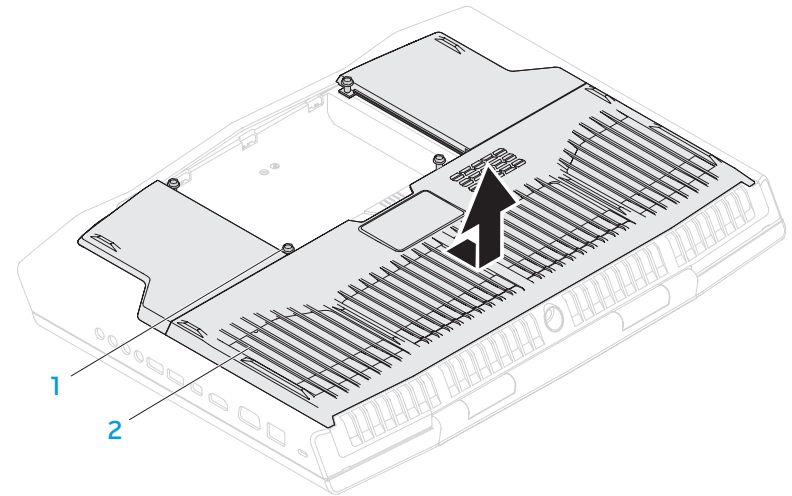

1 screws (4)

2 compartment door

5. Release the connector latch and disconnect the hard-drive cable from the connector on the system board.
6. Loosen the four captive screws that secure the hard-drive assembly.
7. Using the pull tab, lift the hard-drive assembly out of the computer base.

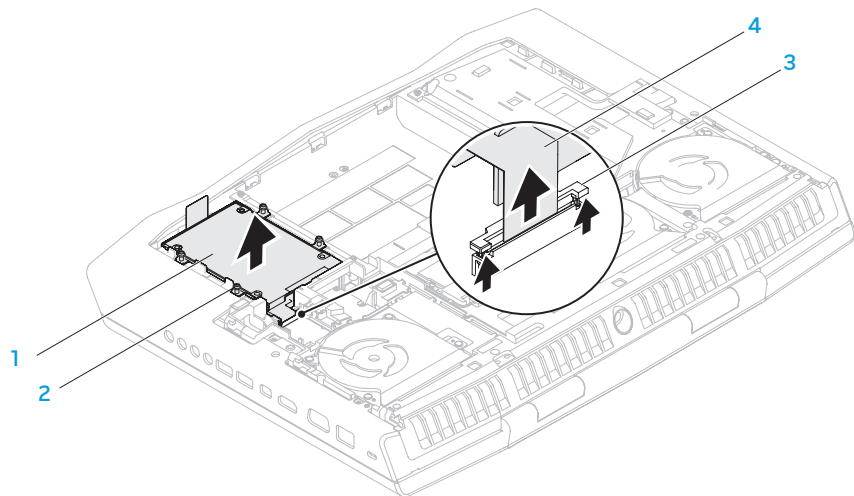

- 1 hard-drive assembly
- 2 captive screws (4)

- 3 connector latch
- 4 hard-drive cable

8. Disconnect the interposer from the hard drives.

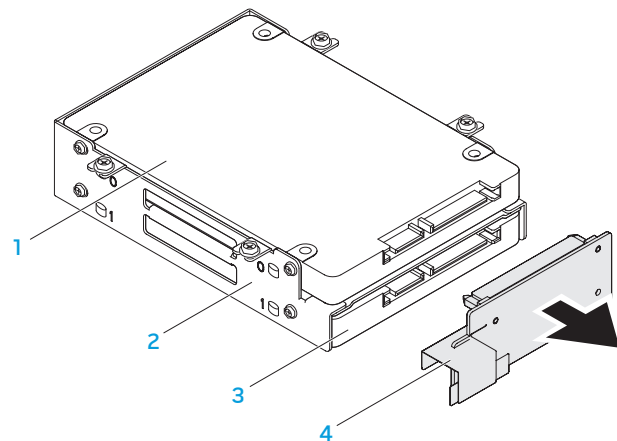

- 1 primary hard drive (HDD0)
- 2 hard-drive bracket

- 3 secondary hard drive (HDD1)
- 4 interposer

- Remove the four screws that secure the primary hard drive (HDD0) and lift the hard drive out of the hard-drive bracket.
- Remove the four screws that secure the secondary hard drive (HDD1) and slide the hard drive out of the hard-drive bracket.

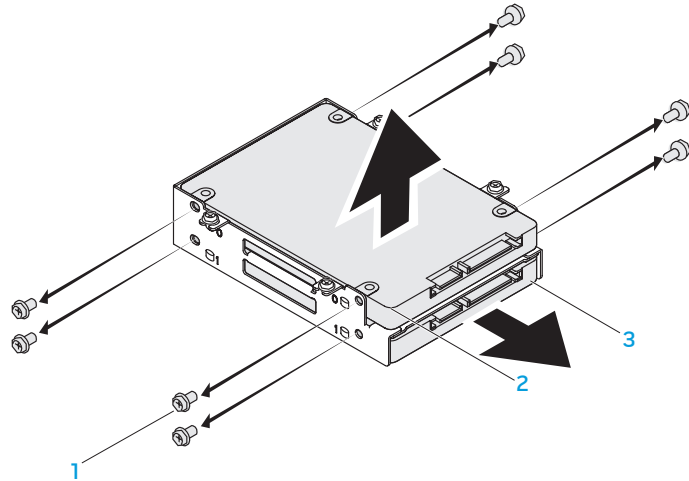

1 screws (8)

2 primary hard drive (HDD0)

3 secondary hard drive (HDD1)

To replace the hard drive(s), perform the removal steps in reverse order.

ሰጠኛ ለግብይት ስራ

CHAPTER 5: TROUBLESHOOTING

Basic Hints and Tips

- Computer does not power on: Is your AC adapter cable securely connected to a working electrical outlet? If connected to a power strip, ensure that the strip is actually working.
- Connections: Check all the cables to ensure that there are no loose connections anywhere.
- Power Savings: Ensure that your computer is not in hibernate or standby mode by pressing the power button for less than 4 seconds. The power status light will fade from blue to black while in standby mode; in hibernate mode it will be off.
- Brightness: Check and adjust the brightness of the display by pressing the key combinations <Fn><F4> or <Fn><F5>.
- Display Choice: Press the key combination <Fn><F6> to ensure that the computer is not set to "External Only" display.
- Use only the AC adapter that shipped with your laptop.

Backup and General Maintenance

- Always back up your important data on a regular basis and keep copies of your operating system and software safe. Do not forget to note the serial numbers if you are storing them outside of their original cases - for example, in a CD wallet.
- Run maintenance programs as often as you can. You may schedule these programs to run at times when you are not using your computer. You can use those provided with your operating system, or buy more powerful, dedicated programs to do so.
- Write down your passwords and keep them safe (away from your computer). This is especially important if you choose to password-protect your computer's BIOS and operating system.
- Document vital settings such as network, dialup, mail and Internet settings.

When troubleshooting your computer, remember the following safety guidelines:

- Before touching any of the computer's internal components, touch an unpainted portion of the chassis. Doing so will safely discharge any static electricity, which could damage your computer.
- Turn off your computer and any connected peripherals.
- Disconnect any peripherals from your computer.

Things to check:

- Ensure that the AC adapter cable is properly connected between your computer and a grounded, three-prong power outlet. Ensure that the power outlet is working.
- Ensure the UPS or power strip is turned on (if applicable).
- If your peripheral devices (for example keyboard, mouse, printer, and so on) are not working, ensure that all connections are secure.
- If any computer components were added or removed before the problem began, check to see if you performed the installation or removal procedures properly.
- If an error message appears on the screen, write down the exact error message prior to calling Alienware Technical Support to aid in diagnosing and resolving your issue.
- If an error occurs in a specific program, see the program's documentation.

Software Diagnostic Tools

Enhanced Pre-Boot System Assessment

The computer runs the Enhanced Pre-boot System Assessment (ePSA), a series of initial tests of your system board, keyboard, display, memory, hard drive, and so on.

To invoke ePSA:

1. Turn on (or restart) your computer.
2. When the Alienware logo appears, press <F12> immediately.



NOTE: If you wait too long and the operating system logo appears, continue to wait until you see the Microsoft Windows desktop; then, shut down your computer and try again.

3. Select **Diagnostics** from the menu and press <Enter>.
4. Follow the instructions on the screen. If a failure is detected, the diagnostics stop and the computer beeps.
 - To stop the assessment and restart the computer, press <n>.
 - To continue to the next test, press <y>.
 - To retest the component that failed, press <r>.

If failures are detected during ePSA, write down the error code(s) and contact Alienware (for more information, see "Contacting Alienware" on page 70).

If the ePSA completes successfully, the following message appears "Do you want to run the remaining memory tests? This will take about 30 minutes or more. Do you want to continue? (Recommended)."

If you are experiencing memory issues, press <y>, else press <n>. The following message appears: "Enhanced Pre-boot System Assessment complete." Press <o> to reboot your computer.

Answers to Common Problems

Computer Startup Problems

The computer fails the POST

The Power On Self Test (POST) ensures that the computer meets all the necessary system requirements and that all hardware is working properly before starting the remainder of the boot process. If the computer passes the POST, the computer will continue to start normally. However, if the computer fails the POST, the computer will generate a single beep to indicate a general failure and an error message will be displayed. For assistance, contact Alienware Technical Support (see "Contacting Alienware" on page 70).

The computer stops responding or a solid blue screen appears



CAUTION: You might lose data if you are unable to perform an operating system shutdown.

If you are unable to get a response by pressing a key on your keyboard or moving your mouse, press and hold the power button for at least 6 seconds to turn off your computer, and then restart it.



NOTE: The chkdsk program may run when you restart the computer. Follow the instructions on the screen.

Software Problems

A program stops responding or crashes repeatedly

End the program:

1. Press <Ctrl><Shift><Esc> simultaneously.
2. Click the **Applications** tab and select the program that is no longer responding.
3. Click **End Task**.

Check the software documentation.

If necessary, uninstall and then reinstall the program.

A program is designed for an earlier version of Microsoft Windows

Run the Program Compatibility Wizard:

The **Program Compatibility Wizard** configures a program so that it runs in an environment similar to an earlier version of Microsoft Windows operating system environments.

1. Click **Start**  → **Control Panel** → **Programs** → **Programs and Features** → **Use an older program with this version of Windows**.
2. In the welcome screen, click **Next**.
3. Follow the instructions on the screen.

Other software problems

Back up your files immediately.

Use a virus-scanning program to check the hard drive, or CDs.

Save and close any open files or programs and shut down your computer through the Start menu.

Scan the computer for spyware:

If you are experiencing slow computer performance, you frequently receive pop-up advertisements, or you are having problems connecting to the Internet, your computer might be infected with spyware. Use an anti-virus program that includes anti-spyware protection (your program may require an upgrade) to scan the computer and remove spyware.

Run the ePSA diagnostics:

If all tests run successfully, the error condition is related to a software problem.

Check the software documentation or contact the software manufacturer for troubleshooting information:

- Ensure that the program is compatible with the operating system installed on your computer.
- Ensure that your computer meets the minimum hardware requirements needed to run the software. See the software documentation for information.
- Ensure that the program is installed and configured properly.
- Verify that the device drivers do not conflict with the program.
- If necessary, uninstall and then reinstall the program.

Hard Drive Problems

Allow the computer to cool before turning it on

A hot hard drive may prevent the operating system from starting. Try allowing the computer to return to room temperature before turning it on.

Run Check Disk

1. Click **Start**  → **Computer**.
2. Right-click **Local Disk C:**.
3. Click **Properties** → **Tools** → **Check Now**.
If the **User Account Control** window appears, click **Continue**.
4. Follow the instructions on the screen.

Memory Problems

Memory errors detected on startup

- Check memory modules for correct seating and orientation. Reseat the memory modules if applicable (see “Upgrading or Replacing Memory” on page 41).
- Computers using a dual-channel memory configuration require that memory modules be installed in pairs. If you require assistance, contact Alienware Technical Support (for more information, see “Contacting Alienware” on page 70).

Display Problems

If the display is blank



NOTE: If you are using a program that requires a higher resolution than your computer supports, it is recommended that you attach an external monitor to your computer.

The computer may be in a power saving mode:

Press a key on the keyboard or press the power button to resume normal operation.

Switch the video image:

If your computer is attached to an external monitor, press <Fn><F6> to switch the video image to the display.

Power Problems

When you press the power button, the computer does not turn on

- If the AC adapter cable is connected to a surge protector or UPS, ensure that the surge protector or UPS is securely connected to an electrical outlet, is switched on and is working correctly.
- Check that the wall outlet is working properly by testing another device such as a radio or lamp that you know works. If the wall outlet is not working, contact an electrician or your power company for further assistance.
- If the problem persists, contact Alienware support (see “Contacting Alienware” on page 70).

אֲשֶׁר לֹא יִשָּׁחַד וְלֹא יִשָּׁחַד

CHAPTER 6: SYSTEM RECOVERY

AlienRespawn

 **CAUTION:** Using AlienRespawn permanently removes any programs or drivers installed after you received your computer. Create backup media of applications you need to install on your computer before using AlienRespawn. Use AlienRespawn only if System Restore did not resolve your operating system problem.

 **CAUTION:** Although AlienRespawn is designed to preserve the data files on your computer, it is recommended that you backup your data files before using AlienRespawn.

You can use AlienRespawn to restore your hard drive to the operating state it was in when you purchased your computer, while preserving the data files.

AlienRespawn allows you to backup and restore your computer to an earlier operating state.

AlienRespawn Basic

To restore the factory image while preserving the data files:

1. Turn off your computer.
2. Disconnect all the devices connected to the computer (such as USB drive, printer, and so on) and remove any recently added internal hardware.



NOTE: Do not disconnect the AC adapter cable.

3. Turn on your computer.
4. When the Alienware logo appears, press <F8> several times to access the **Advanced Boot Options** window.



NOTE: If you wait too long and the operating system logo appears, continue to wait until you see the Microsoft Windows desktop; then, shut down your computer and try again.

5. Select **Repair Your Computer**.
6. Select **AlienRespawn and Emergency Backup** from the **System Recovery Options** menu and follow the instructions on the screen.



NOTE: The restoration process may take an hour or more depending on the size of the data to be restored.



NOTE: For more information on AlienRespawn, see knowledge base article 353560 at support.dell.com.

Upgrading to AlienRespawn Professional

AlienRespawn provides additional features that allow you to:

- Backup and restore your computer based on file types
- Backup files to a local storage device
- Schedule automated backups

To upgrade to AlienRespawn Professional:

1. Double-click the AlienRespawn icon  in the notification area of your desktop.
2. Click **Upgrade Now!**
3. Follow the instructions on the screen.

Dell DataSafe Online Backup (Optional)



NOTE: Dell DataSafe Online is supported only on Windows operating systems.



NOTE: A broadband connection is recommended for fast upload or download speeds.

Dell DataSafe Online is an automated backup and recovery service that helps protect your data and other important files from catastrophic incidents like theft, fire, or natural disasters. You can access the service on your computer using a password-protected account.

For more information, go to delldatasafe.com.

To schedule backups:

1. Double-click the Dell DataSafe Online icon  on the taskbar.
2. Follow the instructions that appear on the screen.

My Dell Downloads



NOTE: My Dell Downloads may not be available in all regions.

Some of the software pre-installed on your new Alienware computer do not include a backup media. This software is available on the My Dell Downloads website. From this website, you can download available software for reinstallation or create your own backup media.

To register and use My Dell Downloads:

1. Go to **[DownloadStore.dell.com/media](https://www.dell.com/downloadstore/media)**.
2. Follow the instructions on the screen to register and download the software.
3. Reinstall the software or create a backup media for future use.

አዲስ አበባ፣ ኢትዮጵያ፡ የፌዴራል ገቢዎች ቢሮ

CHAPTER 7: SPECIFICATIONS

Computer Model

Alienware M18x

Dimensions

Height

Front 53.0 mm (2.09 inches)

Back 54.20 mm (2.13 inches)

Width 436.0 mm (17.17 inches)

Depth 322.0 mm (12.68 inches)

Weight with 12-cell battery and optical drive (starting at) 5.41 kg (11.93 lb)

NOTE: The weight of your laptop varies depending on the configuration ordered and the manufacturing variability.

Computer Information

Processor	<ul style="list-style-type: none">Intel Core i7 Extreme Edition (second generation)Intel Core i7 and i5 (second generation)
L2 cache	256 KB
L3 cache	up to 8 MB
Bus clock	100 MHz
System chipset	Mobile Intel HM67 Express Chipset
SDRAM bus width	one or two 64-bit channels of DDR3 memory up to 1600 MHz
Processor address bus width	32 bits
Processor data width	64 bits
BIOS SPI Flash Memory	32 Mbit
Graphics bus	PCIe x16 Gen2

Memory

Connectors	four internally accessible DDR3 using JEDEC SODIMM sockets
Capacities	2 GB, 4 GB, and 8 GB
Memory type	<ul style="list-style-type: none">up to 1600 MHz unbuffered non-ECC dual-channel DDR3 configurationExtreme Memory Profiles (XMP) 1600 and 1866
Memory configurations possible	4 GB, 6 GB, 8 GB, 16 GB, and 32 GB

Ports and Connectors

Network adapter	one RJ45 connector
USB	<ul style="list-style-type: none">two 4-pin USB 2.0 compliant connectorstwo 4-pin USB 3.0 compliant connectors
eSATA/USB combo	one 7-pin/4-pin eSATA/USB 2.0-compliant combo connector with PowerShare
HDMI input and output	one 19-pin connector
Mini-DisplayPort	one 20-pin connector
VGA	one 15-hole connector

Ports and Connectors

Audio	<ul style="list-style-type: none">two stereo headphones/speakers connectorone microphone-in connector
S/PDIF	one headphone/S/PDIF combo connector
Media Card Reader	one 9-in-1 slot
ExpressCard	one ExpressCard/54 connector

Communications

Network adapter	10/100/1000 Mbps Ethernet LAN on system board
Wireless	<ul style="list-style-type: none">one half Mini-Card slotBluetooth; Wireless Display (optional); WirelessHD (optional)

Video

Video controller	
Integrated	Intel HD Graphics 3000
Discrete	<ul style="list-style-type: none">NVIDIA GeForce GTX 460MAMD Radeon HD 6970M

Video

Video memory

- | | |
|------------|---|
| Integrated | 512 MB dedicated video memory (for total system memory greater than 4 GB) |
| Discrete | <ul style="list-style-type: none">1.5 GB GDDR5 for NVIDIA GeForce GTX 460M2.0 GB GDDR5 for AMD Radeon HD 6970M |

External display support HDMI, Mini DisplayPort, VGA, WiDi (optional), and WirelessHD (optional)

Audio

Type 2.1 channel internal speaker and subwoofer

Controller IDT 92HD73C codec

Speaker dual 4-ohms speakers in both the left and right speaker assembly

Subwoofer mono 4-ohms subwoofer

Internal speaker amplifier MAXIM MAX9736A

15W stereo/ 30W mono

Audio

Output power

Speaker up to 5 W average per channel; up to 2.5 W average total power

Subwoofer up to 10 W average per channel; up to 5 W average total power

Internal microphone support dual digital microphone in camera assembly

Volume controls program menus and keyboard media function keys

Hard-Drive Storage

Number of storage drives two

- Hard drive
- one 2.5 inch SATA 2.0 (3Gb/s) or SATA 3.0 (6Gb/s) hard drives
 - one solid-state drive

Media Card Reader

Cards supported	<ul style="list-style-type: none">Secure Digital (SD) memory cardSecure Digital Input/Output (SDIO) cardSecure Digital Extended Capacity (SDXC) cardMultiMedia Card (MMC)MultiMedia Card plus (MMC+)Memory StickMemory Stick PROxD-Picture Card (type - M and type - H)Hi Density-SD (SDHD)Hi Capacity-SD (SDHC)
-----------------	---

Display

Type	18.4 inch FHD WLED TrueLife
Maximum resolution	1920 x 1080
Dimensions (active area)	
Height	230.04 mm (9.06 inches)
Width	408.96 mm (16.10 inches)
Diagonal	469.22 mm (18.47 inches)
Refresh rate	60 Hz
Operating angle	0° (closed) to 135°
Pixel pitch	0.2550 mm
Controls	brightness can be controlled through keyboard shortcuts

Keyboard (Backlit)

Number of keys	<ul style="list-style-type: none">82 (Korea, U.S., and Canada)83 (Europe)86 (Japan)
Backlight color	RGB; colors can be changed by invoking the AlienFX application in the Alienware Command Center. For more information, see "Alienware Command Center" on page 26.

Touch Pad

X/Y position resolution (graphics table mode)	240 cpi
Size	
Height	56.00 mm (2.20 inches) sensor-active area
Width	99.5 mm (3.92 inches) rectangle

Camera

Camera resolution	3.0 megapixel
Video resolution	2048 x 1536
Diagonal viewing angle	60°

Battery

12-cell "smart" lithium ion (96 Whr)	
Height	30.2 mm (1.19 inches)
Width	174.0 mm (6.85 inches)
Depth	133.3 mm (5.25 inches)
Weight	0.65 kg maximum (1.43 lb)
Voltage	12 VDC - 16.8 VDC

Battery

Operating time	battery operating time varies depending on operating conditions and can be significantly reduced under certain power-intensive conditions.
Life span (approximate)	300 discharge/charge cycles
Temperature range	
Operating	0° to 50°C (32° to 122°F)
Storage	-20° to 60°C (-4° to 140°F)
Coin-cell battery	CR-2032

AC Adapter

Type	240 W/330 W
Input voltage	100-240 VAC
Input current (maximum)	
240 W	3.50 A
330 W	4.40 A
Input frequency	50 Hz-60 Hz

AC Adapter

Output current

240 W	12.30 A (continuous)
330 W	16.92 A

Output power

240 W	240 W
330 W	330 W

Rated output voltage 19.50 VDC

Temperature range

Operating

240 W	0 °C to 40 °C (32 °F to 104 °F)
330 W	10 °C to 35 °C (50 °F to 95 °F)
Storage	-40 °C to 70 °C (-40 °F to 158 °F)

Connector types

DC connector	3-pin, 7.4 mm plug
AC connector	3-pin — C13 (150 W) 3-pin — C13 (240 W)

Computer Environment

Temperature range

Operating	0 °C to 35 °C (32 °F to 95 °F)
Storage	-40 °C to 65 °C (-40 °F to 149 °F)

Relative humidity (maximum)

Operating	10% to 90% (non-condensing)
Storage	10% to 95% (non-condensing)

Maximum vibration (Using a random vibration spectrum that simulates user environment)

Operating	0.66 GRMS
Storage	1.3 GRMS

Maximum shock (Measured with hard drive in operating status and a 2-ms half-sine pulse for operating. Also measured with hard drive in head-parked position and a 2-ms half-sine pulse for storage)

Operating	110 G
Storage	160 G

Altitude (maximum)

Operating	-15.2 m to 3048 m (-50 ft to 10,000 ft)
Storage	-15.2 m to 10,668 m (-50 ft to 35,000 ft)

Airborne contaminant level G1 as defined by ISA-71.04-1985



APPENDIX

GENERAL AND ELECTRICAL SAFETY PRECAUTIONS

Computer Setup

- Read all instructions marked on the product and in the documentation before operating your computer.
- Retain all safety and operating instructions.
- Never use this product near water or a heat source.
- Only set-up the computer on a stable work surface.
- Only operate the computer using the power source type indicated on the rating label.
- Never block or cover any openings or fans in the computer case. These are required for ventilation.
- Never insert objects of any kind into the ventilation openings.
- Ensure that your computer is properly grounded when in use.
- Do not attempt to connect your computer into an outlet that is not properly grounded.
- If an extension cord is used with your computer, ensure that the total ampere rating on the computer does not exceed the maximum rating on the extension cord.

Computer Use

- Route the power cable and all cables away from where people might walk or trip over them. Do not allow anything to rest on the power cable.
- Do not spill anything on or into your computer.
- To avoid electrical shock, always disconnect all power, modem and any other cables from the wall outlets before handling the computer.

Electrostatic Discharge (ESD) Warning

Electrostatic Discharge (ESD) can cause damage to internal system components if precautions are not taken. ESD is caused by static electricity and the damage caused is usually permanent.

Computer technicians wear a special wrist-strap that grounds them to the computer's case to prevent ESD damage. You can reduce the chances of ESD damage by doing the following:

- Turn off your computer's power and wait several minutes before starting to work.
- Ground yourself by touching the case of the computer.
- Touch only those items which must be replaced.
- Avoid walking around while replacing items inside the case, especially if you are on a carpet or during low temperature and low humidity.
- If you have to remove peripheral cards for any reason, place them on the portion of the computer's case that was removed. Do not touch the edge connectors at the bottom of the card that connect to the system board.

General Safety Precautions

- Mechanical Shock: Your computer should never be subjected to severe mechanical shocks. Careless handling of your computer may cause damage. Mechanical Shock is not covered by the warranty.
- Electrical Shock: If you do not open up your computer, there is nothing to worry about. Your computer protects itself against most irregularities in the power source.

When You Should Contact Alienware

- The battery, power cable or connector is damaged.
- Your computer has had liquid spilled into it.
- Your computer was dropped or the case was damaged.
- Normal operation of the computer does not occur when the operating instructions are followed.

Replacement Components or Accessories

It is only advised to use replacement parts or accessories recommended by Alienware.

CONTACTING ALIENWARE

 **NOTE:** If you do not have an active Internet connection, you can find contact information on your purchase invoice, packing slip, bill, or Dell product catalog.

Dell provides several online and telephone-based support and service options. Because availability varies by country and product, some services may not be available in your area.

To contact Dell for sales, technical support, or customer service issues:

1. Visit **dell.com/contactdell**.
2. Select your country or region.
3. Select the appropriate service or support link based on your need.
4. Choose the method of contacting Dell that is convenient for you.

Websites

You can learn about Alienware products and services on the following websites:

- **dell.com**
- **dell.com/ap** (Asian/Pacific countries only)
- **dell.com/jp** (Japan only)
- **euro.dell.com** (Europe only)
- **dell.com/la** (Latin American and Caribbean countries)
- **dell.ca** (Canada only)

You can access Alienware Support through the following websites:

- **support.dell.com**
- **support.jp.dell.com** (Japan only)
- **support.euro.dell.com** (Europe only)
- **support.la.dell.com** (Argentina, Brazil, Chile, Mexico)

Information for NOM, or Official Mexican Standard (Only for Mexico)

The following information is provided in the device(s) described in this document in accordance with the requirements of the Official Mexican Standard (NOM):

Importer:

Dell México S.A. de C.V.
Paseo de la Reforma 2620 - Flat 11°
Col. Lomas Altas
11950 México, D.F.

Regulatory Model Number	Voltage	Frequency	Electricity Consumption	Output Voltage	Output Intensity
P12E	100-240 VAC	50–60 Hz	3.50 A/4.40 A	19.50 VDC	12.30 A/16.92 A

For details, read the safety information that shipped with your computer.

For additional safety best practices information, see [dell.com/regulatory_compliance](https://www.dell.com/regulatory_compliance).

Printed in China.



0P38V4A00

Free Manuals Download Website

<http://myh66.com>

<http://usermanuals.us>

<http://www.somanuals.com>

<http://www.4manuals.cc>

<http://www.manual-lib.com>

<http://www.404manual.com>

<http://www.luxmanual.com>

<http://aubethermostatmanual.com>

Golf course search by state

<http://golfingnear.com>

Email search by domain

<http://emailbydomain.com>

Auto manuals search

<http://auto.somanuals.com>

TV manuals search

<http://tv.somanuals.com>