

# ALESIS ADAT-XT

## Reference Manual

# INTRODUCTION

Thank you for purchasing the Alesis ADAT-XT Digital Multitrack Tape Recorder. To take full advantage of the XT's functions, and to enjoy long and trouble-free use, please read this user's manual carefully.

## HOW TO USE THIS MANUAL

This manual is divided into the following sections describing the various modes of the XT. Though we recommend you take time to read through the entire manual once carefully, those having general knowledge about multitrack recorders should use the table of contents and index to reference specific functions while using the XT.

**Chapter 1: Introduction.** Deals with the necessary preparation before recording and playing, including connections to external devices. This chapter also discusses the difference between "threaded" and "unthreaded" tapes.

**Chapter 2: Your First Session with the ADAT-XT.** This section provides a brief tour of the XT, shows you how to format a tape, record and playback, set locate points, auto punch-in and out, bounce tracks, and points out other various features.

**Chapter 3: Connections.** Details rear panel connections (like inputs and outputs, footswitches and the ADAT Optical Digital Interface), and proper hook-up procedures.

**Chapter 4: Basic Operations.** Covers the user interface of the XT and the way to use its basic control features, how to read the display, and how to navigate through and edit parameters.

**Chapter 5: Multiple ADAT Operation.** How to lock together multiple ADAT Compatible™ devices, and how to record and transfer digital audio between them.

**Chapter 6: Applications.** Describes several real-world examples of how the XT may be used.

**Appendices.** Features an explanation of digital audio recording concepts, troubleshooting, maintenance and service information, specifications, a Glossary and an Index.

## CONVENTIONS

All front panel buttons, LEDs, display icons and rear panel connectors are referred to in this manual just as their names appear on the XT, using all capital letters and in brackets (*Examples: [PLAY] button, [AUTO INPUT] button, EDIT icon, etc.*).



*When something important appears in the manual, an icon (like the one on the left) will appear in the left margin. This symbol indicates that this information is vital when operating the XT.*



## INTRODUCTION

Thank you for purchasing the Alesis ADAT-XT Digital Multitrack Tape Recorder. To take full advantage of the XT's functions, and to enjoy long and trouble-free use, please read this user's manual carefully.

## HOW TO USE THIS MANUAL

This manual is divided into the following sections describing the various modes of the XT. Though we recommend you take time to read through the entire manual once carefully, those having general knowledge about multitrack recorders should use the table of contents and index to reference specific functions while using the XT.

**Chapter 1: Introduction.** Deals with the necessary preparation before recording and playing, including connections to external devices. This chapter also discusses the difference between "threaded" and "unthreaded" tapes.

**Chapter 2: Your First Session with the ADAT-XT.** This section provides a brief tour of the XT, shows you how to format a tape, record and playback, set locate points, auto punch-in and out, bounce tracks, and points out other various features.

**Chapter 3: Connections.** Details rear panel connections (like inputs and outputs, footswitches and the ADAT Optical Digital Interface), and proper hook-up procedures.

**Chapter 4: Basic Operations.** Covers the user interface of the XT and the way to use its basic control features, how to read the display, and how to navigate through and edit parameters.

**Chapter 5: Multiple ADAT Operation.** How to lock together multiple ADAT Compatible™ devices, and how to record and transfer digital audio between them.

**Chapter 6: Applications.** Describes several real-world examples of how the XT may be used.

**Appendices.** Features an explanation of digital audio recording concepts, troubleshooting, maintenance and service information, specifications, a Glossary and an Index.

## CONVENTIONS

All front panel buttons, LEDs, display icons and rear panel connectors are referred to in this manual just as their names appear on the XT, using all capital letters and in brackets (*Examples: [PLAY] button, [AUTO INPUT] button, EDIT icon, etc.*).



*When something important appears in the manual, an icon (like the one on the left) will appear in the left margin. This symbol indicates that this information is vital when operating the XT.*



---

# CONTENTS

## **1: SETTING UP 7**

Unpacking and Inspection	7
AC Power	7
Avoiding Ground Loops	8
Line Conditioners and Protectors	9
About Audio Cables	9
Basic Audio Hookup	10
Input Normaling	10
“Threaded” vs. “Unthreaded”	11
A Word on ADAT’s S-VHS Cassette Tape	11
Operating Environment	12
Thermal Considerations in Rack Mounting	12
Mounting on a Shelf or Non-Rack Enclosure	12
Avoiding Electromagnetic Interference	12

## **2: YOUR FIRST SESSION WITH THE ADAT XT 13**

Power-up, and Tape Insertion	13
Formatting A Tape – A MUST!	14
Recording While Formatting	14
Making A Recording	15
Track Selection and Setting Levels	15
Time Counter	15
Transport Buttons	16
Recording	16
Playback	17
Reviewing and Cueing	17
Locating	18
Creating A Loop	19
Automated Recording	20
Rehearsing	20
Pitch Control	21
Track Delay	21
Track Copy	22
Display Brightness	22

## **3: CONNECTIONS 23**

Analog Audio – Unbalanced Inputs	23
Input jack characteristics	23
Typical input jack hookups	23
Analog Audio – Unbalanced Outputs	23
Analog Audio – Balanced Inputs and Outputs	24
Analog Audio – Input Mode	25
Sync In/Out	26
Digital Audio In/Out	27
Footswitches	28
The XT Remote	28

---

<b>4: BASIC OPERATIONS</b>	<b>29</b>
Tape Formatting	29
Formatting Considerations	29
Complete Format	30
Recording While Formatting	30
Format Extend	31
Write Protect Override	31
Reading The Display	32
Display Icons	33
TIME Counter & ABS/REL Button	35
Locate 0	35
Basic Editing	36
EDIT Value Button	36
▲ and ▼ Buttons	36
Entering Numeric Values	36
Editing Individual Digits	36
Input Select	37
Analog Input	37
Digital Input	37
Track Copy	38
Input Monitor	39
Auto Input Monitor	39
All Input Monitor	39
Meters	39
Peak Mode Button	40
Peak Clear Button	40
Fine Meter Mode	40
Recording a "Benchmark" Tape	40
Record Enable	41
Setting Levels	41
Transport Controls	42
Eject	42
Rewind/Review	42
Fast Forward/Cue	42
Play	43
Record/Punch In or Out	43
Stop	44
Sample Rate (Clock)	44
Record Crossfade Time	45
Displaying Frames vs. 100ths/Seconds	45
Pitch Control	46
About Pitch Changing	46
Track Delay	47
Autolocation Controls	48
Absolute (ABS) Time vs. Relative Time	48
Locate 0	48
Setting Locate Points	49
Locating	49
Auto Looping	50
Auto Return	50
Auto Play	50
Loop Limit	50
Auto Record	51

Looped Recording	51
Rehearsal	51
Tape Length	52
Footswitch Controls	53
Footswitch Controlled Punching	53
Footswitch Controlled Autolocating	53
Using the XT Remote	54
<b>5: MULTIPLE ADAT-XT OPERATION 55</b>	
Overview	55
Synchronizing Machines	56
Master/Slave Interaction	56
Achieving Lock	57
Independent Slave Mode	57
Formatting Multiple Tapes	57
Master Format Enabled, Complete Format	57
Master Format Enabled, Format Extend	57
Master Format Disabled	58
Master Format Disabled, Format Extend	58
Bouncing Tracks Between XTs	59
Reassigning Channels to Different Tracks	59
Making Digital Backups	60
Recording Digital Audio from Other Sources	61
Digital Clock Considerations	61
Tape Offset	62
Combining XTs and ADATs	63
XT Transport Speed	63
Sample rate vs. Pitch Control	63
Input Monitoring	63
Phase Inversion	64
Connections	65
<b>6: APPLICATIONS 67</b>	
Overview	67
Combined Multitrack/Mastering Deck	67
Computer Control	69
MIDI Systems: Virtual Tracking	69
MIDI Machine Control: Virtual Remote Control	69
Libraries and Archives	70
Modular Recording	70
Using Track Copy as a Digital Router	71
Calculating Tape Offset Using the Locates	71
<b>APPENDIX A: DIGITAL RECORDING CONCEPTS 73</b>	
Analog Recording Basics	73
Digital Recording Basics	73
Why S-VHS?	74
<b>APPENDIX B: TROUBLESHOOTING 75</b>	
Trouble-Shooting Index	75
Re-initializing	75
Checking Software Version	76
Error Rate Display	76
About Error Rate Readings	76
ADAT Head Life	76
ADAT Head Maintenance	77
Tape Maintenance: Safe Tape	78



Maintenance/Service 79  
Cleaning 79  
Maintenance 79  
Obtaining Repair Service 79  
**APPENDIX C: ERROR CODES 81**  
Steps To Take Before Calling For Help 83  
**APPENDIX D: SPECIFICATIONS 84**  
**GLOSSARY 86**  
**INDEX 91**

# CHAPTER 1

# SETTING UP

## UNPACKING AND INSPECTION

Your XT was packed carefully at the factory. The shipping carton was designed to protect the unit during shipping. Please retain this container in the highly unlikely event that you need to return the XT for servicing.

The shipping carton should contain the following items:

- ADAT-XT with the same serial number as shown on shipping carton
- Power Cable
- Optical Cable
- XT remote control unit
- This instruction manual
- Blank S-VHS ST-120 cassette
- Alesis warranty card

**J** *It is important to register your purchase; if you have not already filled out your warranty card and mailed it back to Alesis, please take the time to do so now.*

## AC POWER HOOKUP

With the XT off, plug the female end of the power cord into the XT's [POWER INPUT] socket and the male (plug) end into a source of AC power. It's good practice to not turn on the XT until all other cables are hooked up.

The XT works with *any* AC voltage from 90 to 250 volts, 50 to 60 Hz. This eliminates the need for transformers or voltage switches. Your XT was supplied with the correct power cord for your country or local area, however only the following alternative power cords are approved for use with ADAT:

- For 90-120 VAC 50/60 Hz operation in the US, Canada and/or Japan, use Alesis UL/CSA power cord #7-41-0001.
- For 240 VAC 50 Hz operation in England, use Alesis Power cord #7-41-0004.
- For 220 VAC 50 Hz operation in Europe and Scandinavia, use Alesis EU power cord #7-41-0002.
- For 240 VAC 50 Hz operation in Australia, use Alesis AS power cord #7-41-0003.

The XT's IEC-spec AC cord (do not substitute any other AC cord) is designed to feed an outlet that includes three pins, with the third, round pin connected to ground. The ground connection is an important safety feature designed to keep the chassis of electronic devices such as the Alesis ADAT - XT, BRC and AI-1 at ground potential. Unfortunately, the presence of a third ground pin does not always indicate that an outlet is properly grounded. Use an AC line tester to determine this. If the outlet is not grounded, consult with a licensed electrician. When AC currents are suspect of being highly unstable in VAC and Hz, a professional power conditioner should be used.

**J** *Alesis cannot be responsible for problems caused by using the XT or any associated equipment with improper AC wiring.*

## AVOIDING GROUND LOOPS

In today's studio, where it seems every piece of gear has a computer in it, there are many opportunities for ground loop problems to occur. These show up as hums,

buzzes, or sometimes radio reception and can occur if a piece of equipment “sees” two or more different paths to ground, as shown below.

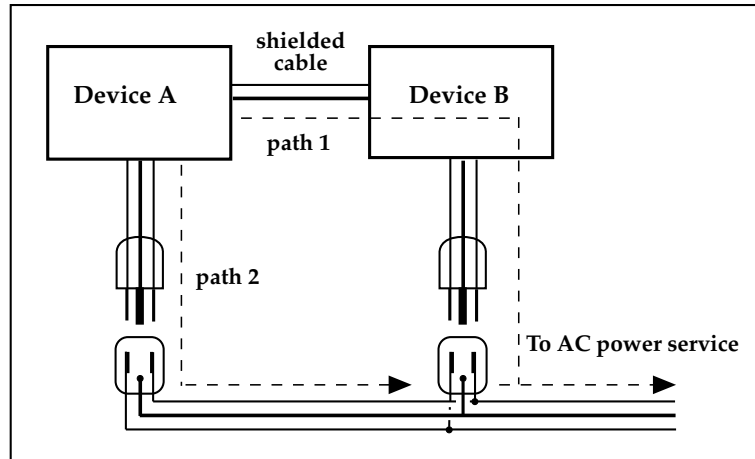

One path goes from device A to ground via the ground terminal of the three-conductor AC power cord, but A also sees a path to ground through the shielded cable and AC ground of device B. Because ground wires have a small amount of resistance, small amounts of current can flow through ground and generate a voltage along the cable shield. This signal may end up getting induced into the hot conductor.

The loop can also act like an antenna into which hum is induced, or can even pick up radio frequencies. Furthermore, many components in a circuit connect to ground. If that ground is “dirty” and contains noise, it might get picked up by the circuit. Ground loops cause the most problems with high-gain circuits, since massive amplification of even a couple millivolts of noise can give an audible signal.

Most ground loop problems can be solved by plugging all equipment into the same grounded AC source. However, it is important to make sure that the AC source is not overloaded and is properly rated to handle the gear plugged into it.

For really tough cases, you may need to break the connection that causes the loop condition. One way to do this is to simply break the shield **of the shielded audio cable** at some point, usually by disconnecting it from ground at one jack. (The other end should remain connected so that the shielding properties are retained, even if there is no direct path for ground.)

Please note that not all hums and buzzes are caused by ground loops; your cables must be of very high quality, particularly with -10 dBV setups. Refer to section 2.1 for more information.

## LINE CONDITIONERS AND PROTECTORS

Although the XT is designed to tolerate typical voltage variations, in today's world the voltage coming from the AC line may contain spikes or transients that can possibly stress your gear and, over time, cause a failure. There are three main ways to protect against this, listed in ascending order of cost and complexity:

- Line spike/surge protectors. Relatively inexpensive, these are designed to protect against strong surges and spikes, acting somewhat like fuses in that they need to be replaced if they've been hit by an extremely strong spike.
- Line filters. These generally combine spike/surge protection with filters that remove some line noise (dimmer hash, transients from other appliances, etc.).
- Uninterruptible power supply (UPS). This is the most sophisticated option. A UPS provides power even if the AC power line fails completely. Intended for computer applications, a UPS allows you to complete an orderly shutdown of a computer system in the event of a power outage, and the isolation it provides from the power line minimizes all forms of interference—spikes, noise, etc.

## ABOUT AUDIO CABLES

The connections between the XT and your studio are your music's lifeline, so use only high quality cables. These should be low-capacitance shielded cables with a stranded (not solid) internal conductor and a low-resistance shield. Although quality cables cost more, they do make a difference. Route cables to the XT correctly by observing the following precautions:

- Do not bundle audio cables with AC power cords.
- Avoid running audio cables near sources of electromagnetic interference such as transformers, monitors, computers, etc.
- Do not place cables where they can be stepped on. Stepping on a cable may not cause immediate damage, but it can compress the insulation between the center conductor and shield (degrading performance) or reduce the cable's reliability.
- Avoid twisting the cable or having it make sharp, right angle turns.
- Never unplug a cable by pulling on the wire itself. Always unplug by firmly grasping the body of the plug and pulling directly outward.
- Although Alesis does not endorse any specific product, chemicals such as Tweek and Cramolin, when applied to electrical connectors, are claimed to improve the electrical contact between connectors.

## BASIC AUDIO HOOKUP

**J** *When connecting audio cables and/or turning power on and off, make sure that all devices in your system are turned off and the volume controls are turned down.*

The XT provides eight -10dBV analog outputs via phono connectors. These should be connected to your mixer's tape or line inputs. Alternatively, a multi-pin connector can be used with the XT's +4dBu analog inputs and outputs (see Chapter 3).

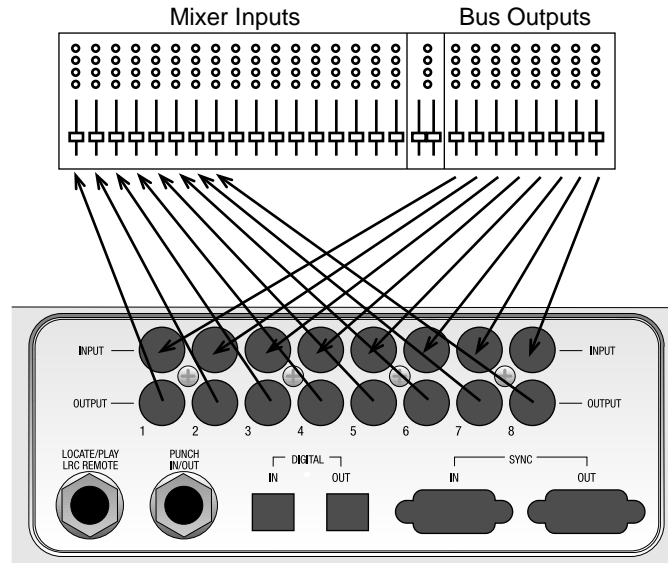

### INPUT NORMALING

The XT has eight -10 dBV analog inputs, but you can choose between three different Input Modes: 2-Input Mode, 4-Input Mode and 8-Input Mode. These can provide three different analog audio input hookup options, and are available for both -10 dBV and +4dBu analog inputs:

- **2 Bus Mixer.** Connect the mixer's two bus outputs to the XT's INPUTS [1] and [2]. Select 2-Input Mode on the XT by holding the [ANALOG INPUT] button and pressing either Track Select buttons [1] or [2]; notice that the INPUT LEDs for tracks 1 and 2 remain lit until you release the [ANALOG INPUT] button.
- **4 Bus Mixer.** Connect the mixer's four bus outputs to the XT's INPUTS [1] through [4]. Select 4-Input Mode by holding the [ANALOG INPUT] button and pressing either Track Select buttons [3] or [4]; notice that the INPUT LEDs for tracks 1 through 4 remain lit until you release the [ANALOG INPUT] button.
- **8 Bus Mixer/Direct Outputs.** Connect the mixer's eight bus outputs (or 8 direct outputs) to the XT's INPUTS [1] through [8]. Select 8-Input Mode by holding the [ANALOG INPUT] button and pressing any Track Select button from [5] - [8]; notice that the INPUT LEDs for tracks 1 through 8 remain lit until you release the [ANALOG INPUT] button.

## “THREADED” VS. “UNTHREADED”

Analog audio recorders typically move tape past the heads at anywhere from 1-7/8 to 30 inches per second. Higher speeds result in a higher *bandwidth*, or an ability to record high-frequency signals. The XT's digital audio signals require much higher bandwidth than analog audio signals. In addition to moving the tape faster than standard S-VHS VCRs, the XT increased the head/drum speed for increased bandwidth. In contrast to analog multi-track recorders, the tape and rotating heads of the XT remain in contact when the tape is stopped. This allows for going into play or record faster, as well as “cue” and “review” functions that let you monitor the tape audio in fast forward or rewind.

When the tape is unthreaded (the [STOP] LED will be flashing), the head is not spinning and it takes slightly longer to go into play or record. This is because the tape moves away from the head automatically after being stopped for 4 minutes, in order to prolong tape and head life. When a tape is threaded, rewinding or fast forwarding will operate 40 times faster than normal play speed. Cue and review functions are not possible while the tape is unthreaded.

When the tape is threaded and stopped (the [STOP] LED will remain lit), you can manually unthread it by pressing the [STOP] button. The [STOP] LED will flash, indicating the tape is now unthreaded. Pressing either [PLAY] or [STOP] will re-thread the tape (or by simultaneously pressing [PLAY] and [RECORD] to engage recording).

If the tape is threaded, and no transport activity (play, record, rewind, etc.) occurs for 4 minutes, the tape will automatically unthread itself to minimize tape wear.

## A WORD ON ADAT'S S-VHS CASSETTE TAPE

Alesis recommends you use only *premium quality, name brand* S-VHS cassettes. We cannot overemphasize the importance of this. We recommend using AMPEX 489 DM Digital Mastering Audio Tape, or Alesis ADAT Mastering Audio Cassettes. Other acceptable brands include Maxell XR-S Black, JVC XZ, 3M Master Broadcast and ASD 40+, and TDK SP Super Pro. The cassette shell, hubs, rollers and tape guides in S-VHS cassettes are precision devices that properly handle and protect the tape within them.

**J** *Do not use inexpensive, budget VHS tapes. ONLY USE S-VHS TAPES.*

We do not recommend that you use inexpensive, budget VHS cassettes. While they may work technically, their unpredictable quality and less than premium formulation will decrease the reliability of your recording. Inferior tapes not only jeopardize the recordings made on them, they may shed oxide and leave behind a coating of dirt that will interfere with future recordings, even if you switch back to premium quality tape. Defective tape may even clog the head, requiring service. Don't trust your work to anything less than premium quality S-VHS tape.

Accidents can happen – so, like computer floppy disks and hard disks, your XT tapes should be backed up to prevent loss. Back up your tapes to another XT or ADAT using the fiber optic digital connector (see *Making Backups* on page 60).

Treat your tapes as the precision, fragile components that they are. Do not expose them to extremes of heat, cold, or humidity (in other words, don't leave them in your car). Never place tapes near magnetic fields (such as power amps, TVs, monitors, magnets, etc.) and handle tapes gently.

## OPERATING ENVIRONMENT

### THERMAL CONSIDERATIONS IN RACK MOUNTING

The XT can be mounted in an equipment rack (taking up 3 rack spaces) or placed on a table or shelf. When you install it, keep in mind that *heat is the major enemy of electronic equipment*. Please observe the following:

- The XT is designed to perform properly over a range of ambient temperatures from 10 °C to +40 °C (50 °F to 104 °F), in up to 80% non-condensing humidity. These are not absolute limits, but Alesis cannot guarantee that the XT will meet its published specs or remain reliable if operated outside of these ranges.
- Always allow adequate ventilation behind the XT . Do not seal any enclosure that holds the XT . It is not necessary to leave an empty rack space above or below the XT unless it runs hot enough to affect equipment above or below it.
- You will need to remove the screw-on feet from the bottom of the XT if any equipment will be mounted directly below it.

### MOUNTING ON A SHELF OR NON-RACK ENCLOSURE

To mount the XT on a shelf or other flat surface, Alesis recommends using the attached screw-on feet to avoid scratching the shelf's surface with the deck's bottom. Please observe the general comments on thermal considerations given under "Thermal Considerations in Rack Mounting" no matter where or how the deck is mounted.

### AVOIDING ELECTROMAGNETIC INTERFERENCE

Like all tape machines, the XT uses magnetic tape that can be sensitive to electromagnetic interference. Generally this is not a problem, but avoid mounting the XT next to devices that generate strong magnetic fields such as power amplifiers, monitors and video display devices, speakers, etc.

## CHAPTER 2

# YOUR FIRST SESSION WITH THE ADAT-XT

## POWER-UP, AND TAPE INSERTION

Connect the power cord which accompanies the XT between the three-prong power socket on the back panel and an AC outlet receptacle. Please note that there are grounding considerations to be aware of. See pages 7–9 for more information.

**J** *The XT can produce a transient audio signal during power up and power down. When turning the XT on or off, be sure to keep monitor levels low.*

Turn the XT's power on by pressing the [POWER] button. At power-up the display will briefly look like this:

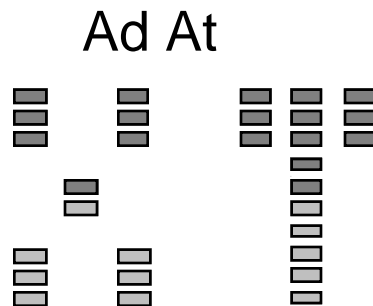

In a few seconds, the display will change depending on the status of the tape chamber.

- If a formatted tape is present, the TIME counter will show the elapsed time since the beginning of the tape (unless it is somewhere in the first two minutes of tape, called the “lead” and “data” sections):

ABS 0<sub>H</sub> 15<sub>M</sub> 48<sub>S</sub> 21

- If an unformatted tape is present, the FORMAT icon will flash and the TIME counter will read:

ABS n0 F0

- If there is no tape, the display shows:

ABS -- -- -- --

Insert the tape with the hinged door end first, label side up, until you encounter a slight bit of resistance. Push gently on the center of the tape cassette until the XT draws the tape inward; never force the tape into the cassette door.



## FORMATTING A TAPE – A MUST!

Formatting prepares a tape for 8 channels of audio, and adds a master timecode reference and sample rate information to the data section. Similar to formatting a floppy disk to use on a computer or sampler, formatting an XT tape time-stamps the tape to single-sample accuracy so that audio is referenced to an accurate time base. This makes the synchronization process between XT and ADAT compatible machines possible and provides both accurate tape counter readings and intelligent autolocation functions. For more information, see *Tape Formatting* in Chapter 4. After completing the following exercise, we recommend you perform a complete format.

**J** *Formatting a tape erases audio on all eight tracks. Be sure to check that the tape is either blank or contains unwanted material before formatting. We recommend that you format your tapes completely from beginning to end.*

### SAMPLE RATE SELECTION

Before formatting, select the sample rate you will be using (either 48 kHz or 44.1 kHz). This is done by pressing the [CLOCK SELECT] button. Each time [CLOCK SELECT] is pressed, the XT will cycle between INT 48K, INT 44.1K and DIG (the section on the right side of the display labeled CLOCK will indicate the currently selected sample rate). *Note:* For more information about the DIG option (Digital Audio Clock), see page 44.

### FORMATTING A NEW TAPE

#### **To Format a new tape:**

- ⌘ Insert a fresh, blank tape.  
*The XT will acknowledge that this is an unformatted tape; the FORMAT icon will flash in the display while the counter display reads “noFO.”*
- ⌘ Press the [FORMAT] button.  
*The word [FORMAT] in the display will stop flashing and remain lit. The [RECORD] LEDs for tracks 1 through 8 will now be flashing.*
- ⌘ Hold [RECORD], and then press [PLAY].  
*If the tape was not completely rewound, the XT will automatically rewind it to the beginning. The XT then performs a complete format by recording 15 seconds of leader (the LED display will read “LEAd”), followed by two minutes of data (the display will read “dAtA”), then timecode starting at 0:00:00.00 and continuing to the end of the tape.*

### RECORDING WHILE FORMATTING

You can record onto tape *while* formatting. Simply press any of the RECORD ENABLE buttons [1]–[8] for any track(s) you wish to record on before pressing the [FORMAT] button. Prepare your source material to start playback at 0:00:00.00 on the XT or later (do not begin recording before 0:00:00.00). See next section for more information on setting levels and recording.

## MAKING A RECORDING

Recording on the XT is very similar to most multitrack tape machines. The process involves formatting a tape (see previous tutorial), putting one or more tracks into record-ready, adjusting record levels on your mixer, setting the input monitor mode, locating to the start tape address and engaging record. In this tutorial, we will be recording from the analog audio inputs at the start of the audio portion of the tape (0:00:00.00). For more information on this and recording from the digital bus, see pages 37 through 41 of chapter 4.

### TRACK SELECTION AND SETTING LEVELS

You'll find the RECORD ENABLE buttons ([1]–[8]) for all eight tracks on the left side of the front panel, beneath the display. A track is considered “safe” when its [REC] LED is off, in “record-ready” when its [REC] LED is flashing, and in record when its [REC] LED is lit solid.

#### To record-enable a track:

- ¿ Choose a track to record on, and press the track's associated RECORD ENABLE button [1]–[8]. *The selected track's [REC] LED will flash to indicate it is in record-ready.*
- j Send an audio signal to the track(s) you have placed into record-ready. *Adjust the levels on your mixer so that the “average” level is at -15 dB on the peak meters of the XT and the loudest section never goes beyond 0 dB. Digital audio recording is different from analog recording, and therefore requires a different method when setting levels. For more information, see Setting Levels on page 41 of chapter 4.*
- ↵ To take a track out of record-ready (safe), press its associated RECORD ENABLE button again. *The selected track's [REC] LED will turn off to indicate it is safe.*

### TIME COUNTER

Before recording, you should familiarize yourself with the transport buttons, and the 7-segment TIME counter in the top left corner of the display. Ordinarily, the TIME counter will show Absolute (ABS) time, which is the exact time reference being read directly off of the formatted tape. The tape position is displayed as hours:minutes:seconds.hundredths-of-a-second. (This counter may be changed to show 30 frames per second, see page 45 for more information.)

ABS 0<sub>H</sub> 15<sub>M</sub> 48<sub>S</sub> 21

Pressing the [ABS/REL] button will toggle the display between ABS Time and Relative Time. The display will either indicate ABS or REL to the left of the TIME counter.

REL 0<sub>H</sub> 01<sub>M</sub> 29<sub>S</sub> 03

Relative Time reflects the current tape position *relative* to where you set the Relative 0:00:00.00 position. This is similar to resetting the tape counter on a cassette deck. However, the XT gives you the option of reading the actual tape position (ABS Time) or the tape position relative to the location you marked as 0:00:00.00 (Relative Time).

- J *Before you start recording, for the first time be sure the TIME counter is set to ABS Time to avoid confusion. For more information, see page 35.*

## TRANSPORT BUTTONS

During recording and playback, the following transport buttons are used frequently. Get familiar with them by using them while watching the TIME counter.

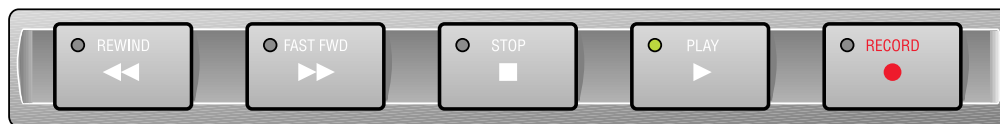

REWIND	High speed reverse. Press with [PLAY] to initiate <i>review</i> mode.
FAST FWD	High speed forward. Press with [PLAY] to initiate <i>cue</i> mode.
STOP	Stops transport and disables recording. While the transport is stopped, this button toggles between threaded (LED is lit) and unthreaded modes (LED is flashing).
PLAY	Starts playback. Initiates recording when pressed with [RECORD]. Stops recording when in record mode while continuing to play. Press with [FAST FWD] to initiate <i>Cue</i> mode. Press with [REWIND] to initiate <i>Review</i> mode.
RECORD	Press with [PLAY] to initiate recording.

## RECORDING

Recording takes place only on tracks that are in record-ready. When you start recording, the [RECORD] LED lights, and the [REC] LEDs for those tracks in record-ready will stop flashing and remain lit. If no tracks are in record-ready when recording takes place, the [RECORD] LED will flash to indicate that pressing any of the RECORD ENABLE buttons will initiate recording on the selected track.

### To make a recording:

- ¿ Use the [REWIND] or [FAST FWD] button to locate to the desired tape position  
*Either the [REWIND] or [FAST FWD] LED will light (depending on which button was pressed), indicating that the transport is moving in that direction. The TIME counter will indicate the current tape location status while the transport is in motion.*
- j When you've arrived at the desired tape address, press the [STOP] button.  
*The [STOP] LED lights.*
- ↪ Hold [PLAY], and then press [RECORD].  
*Both the [PLAY] and [RECORD] LEDs will light to indicate you are recording.*
- ÷ To go in and out of record on the individual tracks while record mode is engaged, press any of the RECORD ENABLE buttons [1] – [8].  
*Record-enabled tracks will have their REC LED lit. If no tracks are record-enabled during recording, the [RECORD] LED will flash.*
- f To punch out without stopping, press [PLAY].  
*The [RECORD] LED turns off, while the [PLAY] LED remains lit.*
- a To punch out and stop the transport, press [STOP]  
*The [RECORD] and [PLAY] LEDs turn off; the [STOP] LED lights.*

*Note:* When recording for the first time, be sure the Auto Input function is off. When recording over previous material (also known as punching), turn the Auto Input function on. Use the [AUTO INPUT] button to turn Auto Input on and off. The AUTO INPUT icon will light in the display when Auto Input is on. See page 39 for more info.

## PLAYBACK

There are several ways to quickly play back your recording. You'll use the transport buttons first.

### **To play back a recording:**

- ⌘ Press [REWIND] to locate back to a tape position before you engaged recording.  
*The [REWIND] LED will light and the TIME counter will roll backward to indicate the current tape location status while the transport is in motion.*
- ⌘ Once you have arrived at the desired tape address, press the [STOP] button.  
*The [REWIND] LED will turn off and the [STOP] LED will light.*
- ⌘ Press [PLAY].  
*The [PLAY] LED will flash briefly, and then will light to indicate play mode has been engaged.*
- ⌘ Press [STOP] to stop playback.  
*The [PLAY] LED will turn off and the [STOP] LED will light.*

## REVIEWING AND CUEING

When you are trying to locate a particular section of a recording, it is often helpful to use the *review* and *cue* modes on the XT. Review mode lets you play the tape in reverse at a speed 3 times faster than play while hearing “fragments” of audio. Cue mode, on the other hand, plays forward at a speed 3 times faster than Play mode while also letting you hear “chunks” of audio. By listening to the audio in either mode, you can quickly find the section you are looking for.

### **To engage Review mode:**

- ⌘ Simultaneously press [REWIND] and [PLAY].  
*The [PLAY] LED will light and the [REWIND] LED will flash.*
- ⌘ Press [PLAY] to resume Play mode.  
*The [PLAY] LED will remain lit while the [REWIND] LED will turn off.*
- ⌘ Alternatively, you can press [STOP] to stop the transport.  
*Both the [PLAY] and [REWIND] LEDs will turn off, and the [STOP] LED will turn on.*

### **To engage Cue mode:**

- ⌘ Simultaneously press [FAST FWD] and [PLAY].  
*The [PLAY] LED will light and the [FAST FWD] LED will flash.*
- ⌘ Press [PLAY] to resume Play mode.  
*The [PLAY] LED will remain lit while the [FAST FWD] LED will turn off.*
- ⌘ Alternatively, you can press [STOP] to stop the transport.  
*Both the [PLAY] and [FAST FWD] LEDs will turn off, and the [STOP] LED will turn on.*

## LOCATING

Up to 10 tape positions can be stored for easy recall. These are called *Locate Points*, and can be stored either “on the fly” while the transport is engaged, or when the transport is stopped. Once a Locate Point is stored, its corresponding tape position can be edited. For more info about locating and editing Locate Points, see page 48.

**J** *Each Locate Points’ tape position will be shown in either ABS Time or Relative Time, depending on which is selected. The tape positions themselves, however, do not move when switching between these modes.*

### **To store locate points “on the fly”:**

- ¿ Press [PLAY], [FAST FWD] or [REWIND] to set the tape transport in motion.
- i Press or hold [SET LOCATE].  
*The LOCATE icon will appear in the display immediately followed by a flashing dash (–).*
- ↪ While holding [SET LOCATE] (or within two seconds after releasing [SET LOCATE]), press one of the [LOCATE 1] through [LOCATE 9] buttons.  
*The current tape position is transferred into the selected Locate Point.*

### **To edit locate points:**

- ¿ Press the [EDIT VALUE] button.  
*The EDIT icon will appear in the display along with one of three icons appearing below it: LOCATE, TAPE OFFSET or TRACK DELAY.*
- i Use [LOCATE 0] through [LOCATE 9] buttons to select a Locate Point Memory.  
*The LOCATE icon will appear (if not already present) and a number from 0 to 9 will appear to its right to reflect the button you have pressed.*
- ↪ Hold [EDIT VALUE] and use the [LOCATE 0] – [LOCATE 9] buttons as a numeric key-pad (0-9) to enter the tape position you wish to set for the selected Locate Point.  
*Enter the tape position from left to right. Example: To enter 0:05:00.00, you would hold [EDIT VALUE] and type [LOCATE 5], [LOCATE 0], [LOCATE 0], [LOCATE 0], [LOCATE 0].*
- ÷ Use the [s] and [t] buttons to fine adjust the Locate Point address as desired.

### **To recall a locate point:**

- ¿ Press one of the [LOCATE 1] through [LOCATE 9] buttons.  
*Either fast forward or rewind will engage, as indicated by either button’s LED. When the locate function is complete, the transport will stop, and the [STOP] LED will light. If you wish the transport to automatically go into play after the locate function is complete, turn on Auto Play (see next section).*

### **To set the Relative 0:00:00.00 position (Locate 0):**

- ¿ Press [PLAY], [FAST FWD] or [REWIND] as required to move the tape to the position you wish to regard as “0:00:00.00” (Relative Time).  
*Remember, ABS Time is the timecode being read from tape. Setting the Locate 0 position is always done in Relative Time.*
- i Press [SET LOCATE], immediately followed by pressing [LOCATE 0].  
*The current tape position is stored into Locate 0, and the TIME counter will display :*

REL 0<sub>H</sub> 00<sub>M</sub> 00<sub>S</sub> 00



## CREATING A LOOP

The Auto Return function causes the XT to automatically rewind back to a specified tape position (Locate 1) when playback or recording has reached a specified position (Locate 4). Both Locates 1 and 4 are assignable to any tape position using the methods described in the previous section.

The Auto Play function is used to automatically engage playback whenever a locate function is completed. By using both the Auto Return and Auto Play functions, a loop can be created whereby the same region of tape is repeatedly played back. For more information on related functions, see the section entitled *Autolocation Controls* in Chapter 4.

### **To loop a section of tape:**

- ⌘ Store the tape position where you want the loop to begin into [LOCATE 1].  
*Refer to the previous section for instructions.*
  - ⌘ Store the tape position where you want the loop to end into [LOCATE 4].
  - ⌘ Press [AUTO RETURN] to enable Auto Return.  
*In the right side of the display, the AUTO-RETURN icon will appear indicating that Auto Return is enabled. The XT will now automatically rewind back to the tape position stored in Locate 1 upon reaching the tape position stored in Locate 4.*
  - ⌘ Press [AUTO PLAY] to enable Auto Play.  
*In the right side of the display, the AUTO-PLAY icon will appear indicating that Auto Play is enabled. The XT will now automatically engage playback upon completing a locate.*
  - f* If necessary, press [REWIND] to rewind the tape to a location that is before Locate 4's position.
  - a* Alternatively, you can press [LOCATE 1] to locate directly to its stored tape position.
  - D** Press [PLAY] to engage playback.  
*The [PLAY] LED will light and the transport will go into Play mode. When Locate 4's position is reached, the tape will automatically rewind back to Locate 1's position and then automatically go back into Play mode.*
- J** *If the current Locate 1 position is set beyond the current Locate 4 position and Auto Return is turned on, the AUTO-RTN icon in the display will flash to indicate that Locate 1 or 4 will have to be set properly before this function will operate.*

## AUTOMATED RECORDING

So far, all of your recording has been done manually — you pressed the transport buttons when you wanted to start and stop recording. Auto recording stops and starts recording automatically at predetermined times. This is useful when you want to precisely punch in to a specific place on one or more tracks.

In this section, we will be storing the punch points (called Punch In and Punch Out) “on the fly” while playback is engaged. You can, however, manually modify the precise Punch In and Out points. Auto Return and Auto Play (described in the previous section) help make Auto Recording more functional. For more information, see page 51.

### **To automatically punch in and out:**

- ⌘ Store the tape position where you want to begin recording into [LOCATE 2].  
*Refer to page 18 for instructions.*
  - ⌘ Store the tape position where you want to end recording into [LOCATE 3].
  - ⌘ Press [AUTO RECORD] to enable Auto Record  
*In the right side of the display, the AUTO-REC icon will appear indicating that Auto Record is enabled. Note: If Locate 2's position is past Locate 3's position, the TIME counter will temporarily read “invALid”.*
    - ÷ Press [REWIND] to rewind the tape before Locate 2's position.
  - f Record enable the track(s) you wish to record on.  
*The selected tracks' [REC] LEDs flashes.*
  - a Simultaneously press [PLAY] and [RECORD].  
*The [PLAY] LED lights, the [RECORD] LED flashes and the transport will engage Play mode. When Locate 2's position is reached, the XT will automatically punch-in ([PLAY], [RECORD] and track [REC] LED(s) stop flashing and remain lit). Recording will continue until Locate 3's position is reached, at which point the XT will automatically punch-out, returning to play mode ([PLAY] LED lit, [RECORD] LED off, track [REC] LEDs flashing).*
  - D Press [STOP] to stop the transport.
- J** *If none of the tracks are in record-ready (all eight [REC] LEDs off) when the punch-in point is reached, the [RECORD] LED will continue flashing instead of lighting solid.*
- J** *If a record is initiated past Locate 2's position, but before Locate 3's position, then record is entered immediately. If the record is initiated after Locate 3's position, then the record command is ignored and the transport is left in play mode.*

## REHEARSING

By pressing the [REHEARSE] button (the REHEARSE icon will light in the display), you can run through the Auto-Record process without actually recording anything. However, the input monitors on the tracks that enabled for recording will switch from tape to input when the punch-in occurs, and back to tape when the punch-out occurs (this requires that the Auto Input function be turned on, see page 39). The [RECORD] LED will continue flashing throughout the punch in and out. This way you can try out your punch locations first without recording over anything. In other words, you can measure twice (or more), and cut only once!



## PITCH CONTROL

The Pitch function controls the speed of the tape, and thus the pitch of the audio recorded on tape. The XT's Pitch control has a range of -300 to +100 cents when using a sample rate of 48kHz, and a range of -200 to +200 cents when using 44.1kHz. Use the PITCH [s] and [t] buttons to control the amount of pitch change. When either button is pressed once, the PITCH icon lights in the display, and the TIME counter immediately displays the current amount of Pitch change. The Pitch amount is displayed both as a percentage (%) and as cents.

ABS    00.00%    00.00<sup>C</sup>  
                   (Percentage)    /    (Cents)

### **To set the Pitch amount:**

- ⌘ Press and hold either PITCH [s] or [t].  
*After holding for more than two seconds, the Pitch amount will start either increasing or decreasing, depending on which button was pressed.*

## TRACK DELAY

The XT allows you to delay the playback of any track in relation to the other tracks (and the TIME counter) by a maximum of 170 milliseconds. This can be very useful when some tracks are slightly "off", or when you need to move a particular instrument to get it "in the pocket", or when you just want to create an interesting effect (like copying a track and delaying the copy).

### **To delay a track:**

- ⌘ Press [EDIT VALUE].  
*The EDIT icon will light in the display.*
- ⌘ Press [TRACK DELAY].  
*The TRACK DELAY icon will light, just below the EDIT icon.*
- ⌘ Choose a track to edit by pressing one of the RECORD ENABLE buttons [1]–[8].  
*A number will appear to the left of the EDIT icon representing the track you are editing.*
- ÷ Use the [s] and [t] buttons to adjust the delay amount in .1 ms increments.
- f Hold the [EDIT VALUE] button and enter a specific delay value using the [LOCATE 0] through [LOCATE 9] buttons.  
*The TIME counter will display the selected track's delay amount.*

1 70.0 mS

*Simultaneously, the peak meter for the selected track will rise to indicate the amount of track delay you have selected.*

- a Repeat steps 3 and 4 for any other tracks you wish to delay.
- D Press [EDIT VALUE] to exit Edit mode.  
*The EDIT icon will turn off.*
- « Press [TRACK DELAY] to enable the Track Delay feature.  
*The TRACK DELAY icon will light, indicating that track delays are now in effect.*
- » If necessary, repeat steps ⌘ through f to edit the delay value of any track.

## TRACK COPY

It is possible to copy the audio material from one track to another on the same tape within the XT without leaving the digital domain and without the need for any audio cables. In fact, you can copy up to 4 tracks at a time using the Track Copy feature. For more information on using the Track Copy function, see page 38.

### **To bounce audio from one track to another:**

- ⌘ Press and hold [TRACK COPY].  
*The TRK COPY icon will light in the display.*
- ⌘ While holding [TRACK COPY], select a source track (up to 4) by pressing any of the RECORD ENABLE buttons [1]–[8].  
*The INPUT LEDs for the selected track(s) will light. Note: You can't select a track that is already in record-ready (REC LED lit) as a source track; if its RECORD ENABLE is pressed, its INPUT LED won't light while holding the [TRACK COPY] button.*
- ↵ Release [TRACK COPY], and choose a destination track (up to 4) by pressing one of the RECORD ENABLE buttons [1]–[8].  
*The REC LEDs for the selected track(s) will light. Note: You cannot select a source track as a destination track; if its RECORD ENABLE is pressed, its REC LED won't light.*
- ÷ Use the [REWIND], [FAST FWD] or [LOCATE 0] through [LOCATE 9] buttons to move to the section of tape which holds the audio you wish to copy.
- f Simultaneously press [RECORD] and [PLAY] to initiate recording.  
*The [RECORD] and [PLAY] LEDs will light and recording will begin.*
- a When you are finished, press [STOP].  
*The [STOP] LED will light and the transport will stop.*

**J** While the TRK COPY icon is lit (indicating that Track Copy mode is selected) you will not be able to record any audio being fed to the analog or digital inputs. To record from the analog inputs, you must press the [ANALOG INPUT] button (the ANALOG icon will light in the display).

## DISPLAY BRIGHTNESS

If necessary, the brightness of the XT's display may be adjusted to allow more suitable viewing under various lighting conditions.

### **To adjust the display brightness:**

- ⌘ Hold the [PEAK CLEAR] button.
- ⌘ While still holding [PEAK CLEAR], press either PITCH [s] or [t] to dim or brighten.  
*The display will immediately respond by either dimming or brightening, depending on which button was pressed.*

## CHAPTER 3

# CONNECTIONS

## ANALOG AUDIO – UNBALANCED INPUTS

### INPUT JACK CHARACTERISTICS

The XT includes eight unbalanced, phono jack inputs. These are compatible with low-impedance, unbalanced, -10 dBV outputs typical of equipment such as mixers, synthesizers, samplers, direct boxes, etc.

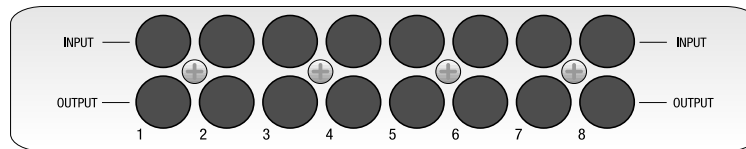

The unbalanced input jack wiring convention is as follows:

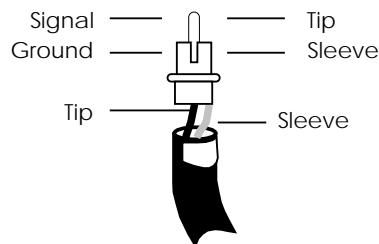

### TYPICAL INPUT JACK HOOKUPS

The input jacks are typically hooked up in one of three ways:

- **To the console's direct tape outs (these patch a single channel directly to tape, bypassing most mixer circuitry).** This is preferred when the signals going to tape require none of the mixer's features (effects, grouping, routing, etc.).
- **To eight mixer bus outputs.** You can use the mixer for grouping, premixing, effects, etc. This puts more circuitry between the input signals and XT, although since most routing can be done at the mixer, you'll seldom need to do any repatching.
- **To a combination of direct outputs and bus outputs.** Some situations require a combination of the two approaches. *Example:* Consider a live gig you want to record with two vocal mics, four mics on drums, two direct feeds from guitar and bass amps, and one direct feed from keyboards. The vocals, bass, guitar, and keyboards could be taken direct and go to five XT tracks. The four drum mics can be mixed to stereo within your mixer sent to the submix outs, then go to two XT tracks. The remaining XT track could be used to record audience sounds or capture one of the instruments in stereo, if applicable.

## ANALOG AUDIO – UNBALANCED OUTPUTS

The -10 dBV outputs use RCA jacks, and carry signals at a nominal -10 dBV level. These should be connected to your mixer's channel line inputs or tape returns. The unbalanced outputs wiring scheme is similar to that of the unbalanced inputs (see previous section).

## ANALOG AUDIO – BALANCED INPUTS AND OUTPUTS

The +4 dBu balanced line inputs and outputs use an ELCO® multipin connector. The balanced in/out connector wiring scheme is as follows:

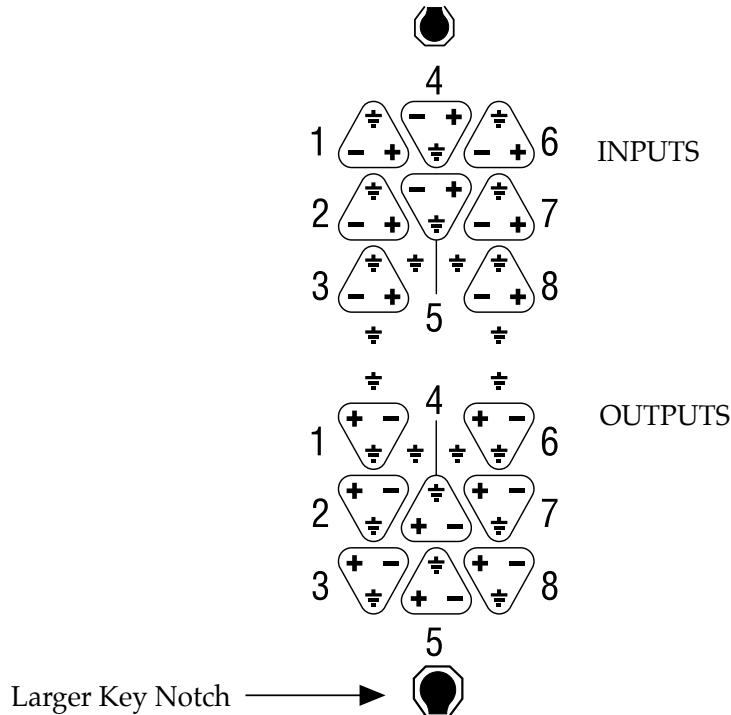

*Note:* The larger of the two outer key notches is at the bottom.

**J** *Both the unbalanced and balanced inputs and outputs may be used simultaneously.*

Pin out letters are referenced to the alphabetical designation on a standard 56-pin ELCO connector.

Channel	GND	NEG	POS	Channel	GND	NEG	POS
In 1	NN	JJ	HH	Out 1	Z	c	d
In 2	CC	y	x	Out 2	P	U	V
In 3	t	n	m	Out 3	D	J	K
In 4	FF	MM	LL	Out 4	T	M	N
In 5	w	BB	AA	Out 5	H	B	C
In 6	KK	EE	DD	Out 6	W	a	b
In 7	z	v	u	Out 7	L	R	S
In 8	p	l	k	Out 8	A	E	F

**Additional grounds:** r, s, h, j, e, f, X, and Y.

®ELCO is a registered trademark of Elco Corporation - a Kyocera Group Company

## ANALOG AUDIO – INPUT MODE

The XT lets you choose one of three Input Modes for both the Unbalanced and Balanced inputs:

<b>2-Input Mode</b>	Input 1 feeds Tracks 1, 3, 5 and 7. Input 2 feeds Tracks 2, 4, 6 and 8.
<b>4-Input Mode</b>	Input 1 feeds Tracks 1 and 5. Input 2 feeds Tracks 2 and 6. Input 3 feeds tracks 3 and 7. Input 4 feeds tracks 4 and 8.
<b>8-Input Mode</b>	Each Input feeds its own track.

The reason for these three modes is to take equal advantage of 2, 4 and 8 bus mixing consoles. If you have two buses, connect them to inputs 1 and 2. If using four buses, connect them to inputs 1 through 4.

To select the appropriate Input Mode, hold the [ANALOG INPUT] button and press one of the RECORD ENABLE buttons ([1]–[8]). The [INPUT] LEDs, located along the bottom of the display below the VU meters, will light up to indicate the Input Mode you have selected.

While holding [ANALOG INPUT]	Result	[INPUT] LEDs lit for...
Press [1] or [2]...	...to select 2-Input Mode.	Tracks 1 and 2
Press [3] or [4]...	...to select 4-Input Mode.	Tracks 1 through 4
Press [5], [6], [7] or [8]...	...to select 8-Input Mode.	All Tracks (1 – 8)

When using a 2 bus mixer, connect its two outputs to the XT's unbalanced inputs 1 and 2 and select 2-Input Mode. Anytime you want to record on an odd number track you will route the signal(s) to bus #1 or left. Likewise, to record onto an even number track, route the signal(s) to bus #2 or right. By simply putting the desired track into record, the proper signal will get there, although not directly connected to the track's input jack.

When using a 4 bus mixer, connect its four outputs to the XT's unbalanced inputs 1 through 4 and select 4-Input Mode. Anytime you want to record on tracks 1 or 5 you will route the signal(s) to bus #1. Likewise, to record onto tracks 2 or 6, route the signal(s) to bus #2, and so on.

## SYNC IN/OUT

The two DB 9 connectors marked [SYNC IN] and [SYNC OUT] are used for synchronizing two or more XT's together, or a combination of XT's and ADATs. This requires a male-to-male, 9-pin D connector cable for each additional machine in the chain. In such a system, you are basically treating all connected machines as though they were a large multitrack unit. The first XT or ADAT in the chain is called the "master", and all other connected units are referred to as "slaves". However, each slave can also be used independently when the master machine is stopped.

For more information about using multiple XT's and/or ADATs, refer to chapter 5.

### **To synchronize multiple XT's and/or ADATs:**

1. Locate the [SYNC IN] and [SYNC OUT] connectors.
2. Connect one end of a male-to-male, 9 pin connector cable to the master's [SYNC OUT] jack.
3. Connect the other end of the cable to the first slave's [SYNC IN] jack.
4. For additional slaves, connect one end of a male-to-male, 9 pin D connector cable to the first slave's [SYNC OUT] jack, and the other end to the second slave's [SYNC IN] jack. Its [SYNC OUT] jack then connects to the third slave's [SYNC IN] jack, and so on.

The following illustration depicts two XT's synchronized together.

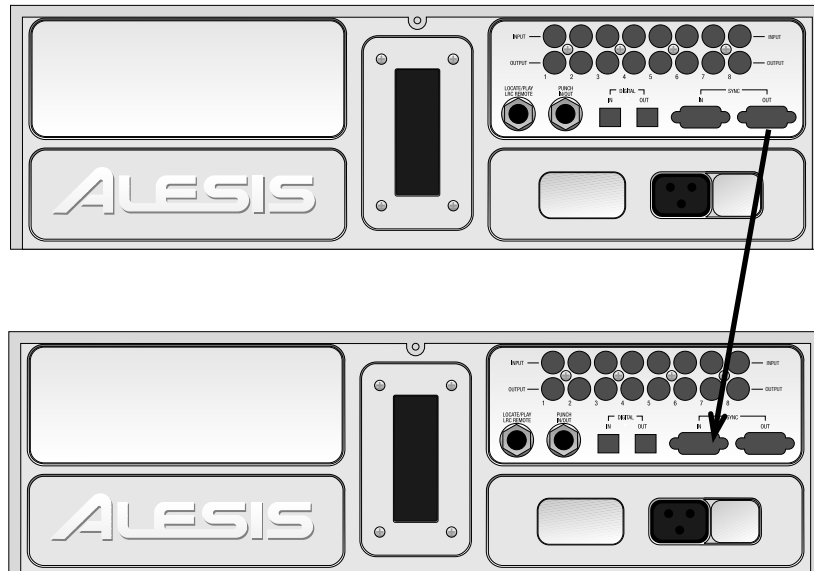

## DIGITAL AUDIO IN/OUT

The Digital input and output carries all eight tracks on a single fiber optical cable. This allows you to bounce audio between multiple machines within the digital domain. This also lets you route digital audio between multiple XT's and ADATs, and to ADAT Compatible™ products such as the QuadraVerb 2. Since the fiber optic connector carries the digital information for all 8 tracks, it is also useful for backing up all tracks in one pass (see Chapter 6 for more on digital audio).

Digital bussing requires a fiber optical cable (included) for each XT in the system (or any other ADAT compatible product). This connection can be made while power is on or off, and the machines do not need to be turned on in any particular order. *Note:* To bounce tracks within a single XT, it is not necessary to connect the optical network.

### **To connect the digital optical network:**

- i Locate the [DIGITAL IN] and [DIGITAL OUT] connectors.  
*Remove the connectors' plugs (if present) and store for later use.*
- j Connect one end of the fiber optic cable into the [DIGITAL OUT] jack of the first machine in the system.  
*Remove the clear, plastic tube covering each end of the cable (if present). The cable is non-polarized, so either end can be inserted into the optical output.*
- Connect the other end of the fiber optic cable to the [DIGITAL IN] of the second machine in the system.
- ÷ For each additional machine, connect one end of an additional fiber optic cable to the second machine's [DIGITAL OUT] jack, and the other end to the third machine's [DIGITAL IN] jack. Its [DIGITAL OUT] jack then connects to the fourth machine's [DIGITAL IN] jack, and so on.
- f Finally, connect one end of a fiber optic cable to the last machine's [DIGITAL OUT] jack, and the other end to the first machine's [DIGITAL IN] jack.  
*This last step creates a loop, and thus makes the digital bus accessible to all machines that are connected to it.*

**J** *When connecting more than two machines, always connect the optical cables in the same order as the sync cables (1 to 2, 2 to 3, etc.), so that the digital routing will work correctly.*

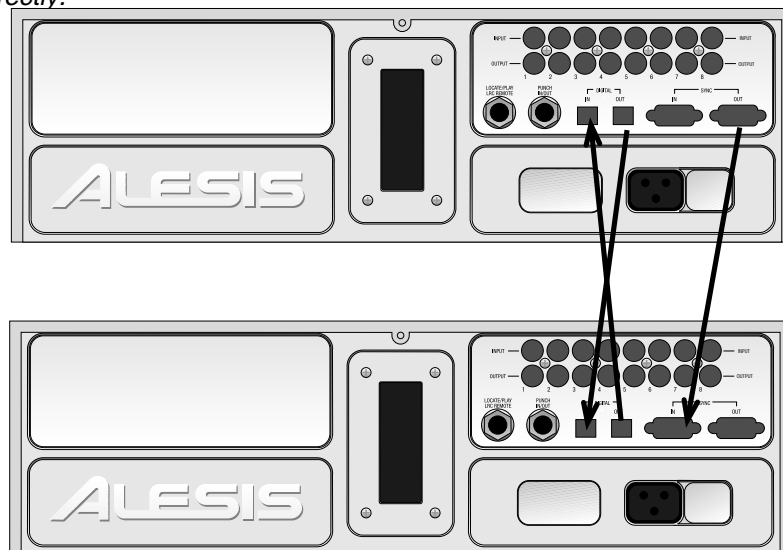

## FOOTSWITCHES

The XT provides two footswitch connectors using 1/4" mono (T/S) jacks. One, labeled [LOCATE/PLAY/LRC REMOTE], allows locate and play commands; the other, labeled [PUNCH IN/OUT], is for punch in/out control.

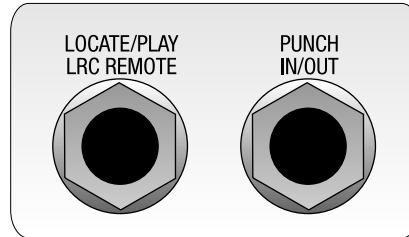

The two footswitch jack functions are designed to be used with any momentary single-pole/single-throw footswitch (either normally open or normally closed). These should be plugged in prior to power-up so that the XT can configure itself for the type of footswitch being used.

**J** *The Punch In/Out footswitch and XT Remote both work in conjunction with the Rehearse and Auto Record features.*

## THE XT REMOTE

Both the [LOCATE/PLAY/LRC REMOTE] and [PUNCH IN/OUT] footswitch connectors can be used to connect the hand-held XT remote control unit to provide remote access of transport functions. You can even connect two XT remote controls into the XT, one in each footswitch jack.

**J** *If using a normally open footswitch, the footswitch and remote control can be interchanged, or used simultaneously with a Y-cord, without restarting the XT (powering down and powering up). However, if using a normally closed footswitch, the XT should be restarted after switching from footswitch to remote control or vice-versa.*



## CHAPTER 4

# BASIC OPERATIONS

This chapter is designed for operators who may not have experience working with digital audio. All functions of the XT (with the exception of synchronization and digital audio) are explained here in detail. If you are already familiar with multitrack recording concepts, you may not need to read this chapter. Instead, use the *Operational Reference* chapter to look up specific functions and how to access them.

## TAPE FORMATTING

Formatting a tape is a simple yet necessary operation before recording can begin. This process involves recording sample rate information in the data section, and time-stamping the tape with a highly accurate time reference which, because of its single-sample resolution, has greater resolution than SMPTE timecode. Formatting a tape is what allows for accurate synchronization, autolocation and auto recording functions, as well as accurate TIME counter readings. You can either format a tape completely before recording, or format while you are recording for only as long as you need to, or you can extend the format of a tape that was not completely formatted to begin with.

**J** *Formatting a tape erases the audio on all 8 tracks. Be sure to label your tapes clearly, so you don't accidentally erase something valuable. We recommend that you completely format your tapes from beginning to end.*

### FORMATTING CONSIDERATIONS

- Blank tapes will automatically be rewound to the beginning before formatting.
- Before formatting, select the sample rate that you will be using (either 48 kHz or 44.1 kHz). See page 44 for more information.
- To record on or erase/format a S-VHS cassette, the write protect tab (located on the spine of the cassette) must be intact. If you try to record on a tape that has had the write protect tab broken off, the PROTECT icon in the display will light and the XT will not record on the tape. This prevents accidental erasure of valuable recordings. To record on a tape that has had the tab broken off, use the Write Protect Override feature (see page 31).

**J** **Caution:** *If you re-format over a previously formatted tape, **do not stop in the middle of re-formatting**. Reason: When the tape transitions from the newly-formatted section to the previously formatted section, there will be timing discontinuities and the audio will do unpleasant things. Also, during that transition the tape will be non-functional and you will not be able to record anything over it. When in doubt, either re-format the entire tape, from beginning to end, or back up a bit and perform a format extend (see page 31).*

- The only way to stop formatting is to press [STOP]—punching out is not sufficient.
- Tapes can be bulk-erased with a video tape eraser.
- In a multiple XT setup where one is the master and the other XTs are slaves, there are a few other considerations. See *Multiple ADAT Operation* in chapter 6.

### COMPLETE FORMAT

#### To format or reformat/erase an entire tape:

- ¿ Insert a fresh, blank tape.

*Be sure the tape is completely rewound.*

- i Press the [FORMAT] button.  
*If the tape was unformatted, the FORMAT icon will have been flashing prior to pressing it. Once pressed, the FORMAT icon will stop flashing and remain lit to indicate that formatting will begin if the XT enters record mode. Also, all eight REC LEDs will flash to indicate all eight tracks will be recorded. Pressing the eight RECORD ENABLE buttons ([1] – [8]) has no effect while the FORMAT icon is lit.*
- ↪ Hold [RECORD] and press [PLAY].  
*The XT briefly enters play mode to achieve proper speed and check if the tape is formatted. The XT performs a complete format by recording 15 seconds of leader (the LED display will read “LEAd”), followed by two minutes of data (the LED display will read “data”), then time reference starting at -0:00:05.00 and continuing to the end of the tape.*

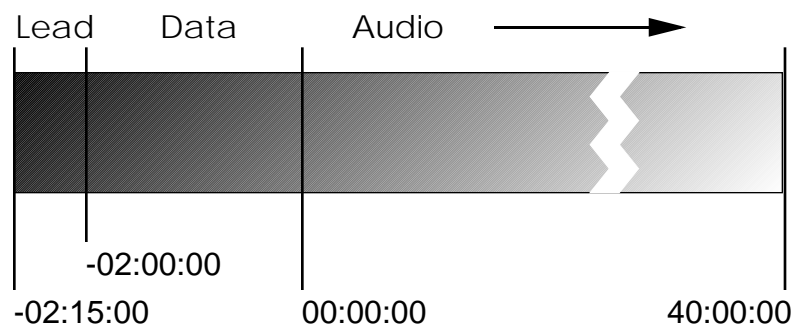

**J** *If an unformatted tape is not at the very beginning, it will automatically be rewound to the beginning. However, if any formatting is detected while rewinding, the transport will stop rewinding and leave the tape at this position, ready for a format extension (see next page).*

- *If the tape has been previously formatted and is in the data portion (before 0:00:00.00), the tape will be automatically rewound to the beginning of the tape and the XT performs a complete format.*
- *If the tape has been previously formatted and is in the audio portion of tape (past 0:00:00.00), the tape will be formatted from that point upon entering record mode (this is called Format Extend; see page 31).*

## RECORDING WHILE FORMATTING

Audio can be recorded while formatting a tape, just in case you need to record something immediately and have no formatted tapes available. To place a track into record-ready, press the RECORD ENABLE button(s) [1] – [8] for the track(s) to be recorded **before** turning on the Format function. When a RECORD ENABLE button is pressed, the INPUT LEDs for the selected track(s) will light and the REC LEDs will flash. Pressing RECORD ENABLE again takes the track(s) out of record-ready. While formatting, record-ready tracks will be recorded with audio from the inputs (analog or digital, depending on the Input Select setting; see page 37). However, audio will not be recorded until the audio portion of tape is reached (0:00:00.00). Tracks not in record-ready (safe) will be recorded with silence while formatting.

## FORMAT EXTEND

It is possible to extend the formatting on a tape that has only been partially formatted. When performing a format extend, you must enter format mode before the end of the previously formatted section by “punching-in”. The XT begins “time-stamping” from

the last valid time-stamp it reads from tape. This insures continuous time-stamping when a tape plays from beginning to end.

**To extend the format on a partially formatted tape:**

- ↻ Use [FAST FWD], [REWIND] and/or [PLAY] to locate to the section of tape just before where formatting was discontinued.
- ⌋ Press [FORMAT].  
*The FORMAT icon lights.*
- ↵ Press [PLAY] to engage playback.
- ÷ When the LOCKED icon appears in the display, hold [PLAY] and press [RECORD].  
*The EXT icon lights. The XT reads the time reference from tape from the formatted portion and begins formatting starting from that time onward.*

*Exception:* If the tape is already formatted but is in the leader or data sections of the tape (i.e., prior to time 0:00:00.00), entering format mode will automatically rewind the tape to the beginning and start reformatting. While rewinding, the TIME counter will read "FO" (which means "format over") and the [REWIND] LED will flash. This indication is telling you that the XT must format over from the *lead* (beginning) portion of the tape.

## WRITE PROTECT OVERRIDE

If necessary, you can still record on a tape which has had its write-protect tab removed or damaged. The write-protect tab (located on the cassette spine) can be removed when you want to protect the information on an important tape from accidental erasure. The XT scans for the presence of a write-protect tab when a tape is inserted. If no tab exists, recording is prevented. You can, however, tell the XT to ignore the absence of a write-protect tab, and permit recording to take place anyway.

**To override the Write Protect function:**

- ↻ Hold the [SET LOCATE] button and press RECORD ENABLE [1];  
*The TIME counter will briefly display:*

ABS Pr 0t 0 FF

*The PROTECT icon will turn off indicating that Write-Protect is being overridden.*

- ⌋ Repeat step 1 to switch Write-Protect Tab Check back on;  
*The TIME counter will briefly display:*

ABS Pr 0t 0 n

*The PROTECT icon will turn on indicating that Write-Protect is in effect.*

*Note:* This override will automatically be deactivated when you eject a tape, or turn the power off.

## READING THE DISPLAY

The XT's display serves many functions. It shows the current level of each of the eight audio tracks, it shows the current tape position numerically in hours, minutes, seconds, and 100ths of seconds, and shows the current modes of the many parameters available. It also is used as a window for editing parameters such as pitch, track delay, tape offset, and locate points. With all segments lit (which would not happen in normal operation), the display looks as follows:

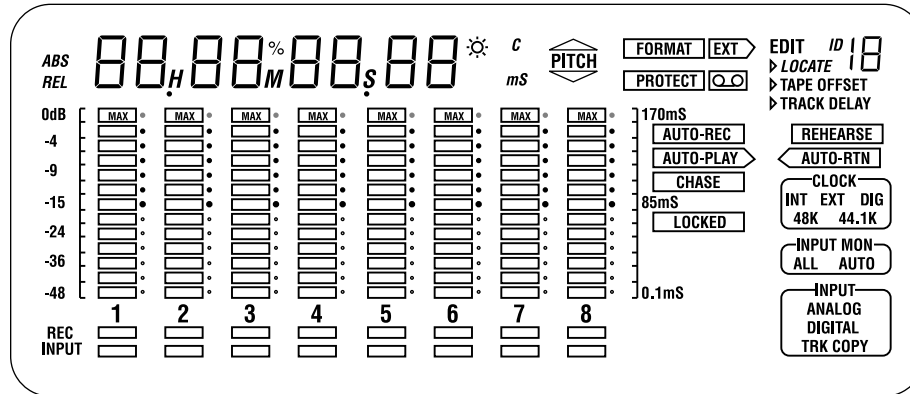

When in a typical play situation, the display may look like this:

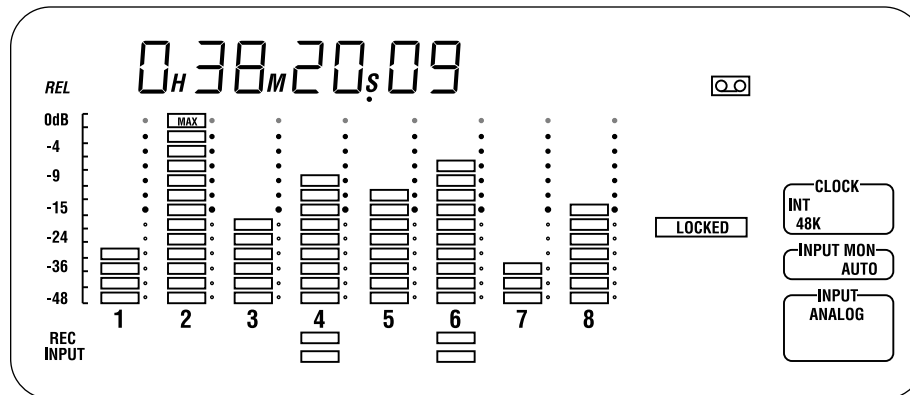

The meters show the current level of each playback track. Tracks 4 and 6 are both in record (as indicated by the REC LEDs) and monitoring their inputs (as indicated by the INPUT LEDs). The TIME counter (directly above the meters) shows the current tape position, in this case relative to the user-defined 0:00:00.00 point (RELATIVE Time). The display example above indicates that the CLOCK is currently set to INTERNAL and 48KHz, the AUTO INPUT MONitor is on, and the Analog input is selected. The  icon indicates that a tape is detected, and the LOCKED icon tells us that playback is engaged.

## DISPLAY ICONS

The following icons appear in the display at different times. They indicate that the parameter for which they are named has been selected or turned on. These icons are:

**ABS** This icon lights whenever Absolute Time mode is selected (by pressing the [ABS/REL] button).

**REL** This icon lights whenever Relative Time mode is selected (by pressing the [ABS/REL] button).



The PITCH group of icons relates information regarding pitch change. Whenever the Pitch setting is above 0, the upper triangle will appear. Whenever the Pitch setting is below 0, the lower triangle will appear. When either PITCH buttons ([s] or [t]) are pressed, the PITCH icon will appear indicating that the TIME counter is now displaying the current Pitch setting using two values: Percentage (%) and Cents (C). See page

45.



Indicates whether Format mode is turned on or off. The FORMAT icon will flash whenever an unformatted tape is inserted. If the [FORMAT] button is pressed, the FORMAT icon will light. If the [FORMAT] button is pressed again, the FORMAT icon will turn off. See page 29.



This icon will light when performing a *format extend*. See page 31.



This icon will light whenever a tape is inserted which has its write-protect tab removed, indicating it cannot be recorded on. This, however, can be overridden using the Protect Overwrite function. See page 31.



This icon will light whenever a tape is inserted.

**ID** If connected to a multiple ADAT system, the ID icon lights when the XT is turned on. The number appearing to the right of the ID icon will indicate the ID number of the unit (1–16). You can check the unit's ID without turning the unit on and off by holding [SET LOCATE] and pressing [PLAY]. See chapter 5.



**EDIT** This icon will light whenever edit mode is selected (by pressing the [EDIT VALUE] button). See page 36.



Indicates that the transport is shuttling to a Locate Point (0–9). When in Edit mode, this icon indicates that you are editing a Locate Point's address, which will appear in the TIME counter. A number (from 0 to 9) will appear next to the EDIT icon to indicate which Locate Point is being edited. See page 47.



This icon indicates that you have the Tape Offset function turned on with a value that is not equal to 0:00:00.00. This function is only available when the XT is used as a slave within a multiple ADAT/XT system. When in Edit Mode, this icon indicates that you are editing the Tape Offset amount, which will appear in the TIME counter. See chapter 5.

- ▶ TRACK DELAY This icon indicates that you have the Track Delay function turned on. When in Edit Mode, this icon indicates that you are editing a tracks delay amount, which will appear in the TIME counter. A number (from 1 to 8) will appear next to the EDIT icon to indicate which track is being edited. The VU meters will also show a bar-graph representation of the current delay values for all eight tracks. See page 46.
- ▢ AUTO-REC When this icon appears, it indicates that the Auto Record function has been turned on. See page 48.
- ▢ REHEARSE This icon indicates that the Rehearse function is turned on. See page 50.
- ▶ AUTO-PLAY This icon indicates that the Auto Play function is turned on. See page 48.
- ◀ AUTO-RTN This icon indicates that the Auto Return function is turned on. See page 48.
- ▢ CHASE When this icon appears, it indicates that the XT is slaving to an external timecode source coming from the master ADAT in a multiple ADAT system. See Chapter 5.
- ▢ LOCKED When this icon appears, it indicates that the transport is properly engaged in either playback or recording. When the XT is a slave in a multiple ADAT system, this icon will light to indicate that the tape is properly synchronized and the audio is sample locked to the timecode of the master ADAT machine. See chapter 5.
- 
 The CLOCK group of icons indicates which clock source is being used. The [CLOCK SELECT] button lets you toggle through the various options, including: INT 48K (internal clock at 48kHz), INT 44.1K (internal clock at 44.1 kHz) and DIG (external clock source connected to the [DIGITAL IN] connector on the rear panel). Additionally, if the XT is being used as a slave in a multi-ADAT system, the EXT icon will light, indicating that the XT is deriving its clock from the master ADAT in the system. See page 44.
- 
 The INPUT MON group includes two icons: ALL and AUTO. The ALL icon will light whenever the All Input function is enabled (by pressing the [ALL INPUT] button). The AUTO icon will light whenever the Auto Input function is enabled (by pressing the [AUTO INPUT] button). See page 39.
- 
 The INPUT group of icons indicates which input source is being used. The ANALOG icon will light whenever the Analog Inputs are selected (by pressing the [ANALOG INPUT] button). The DIGITAL icon will light whenever the Digital Inputs are selected (by pressing the [DIGITAL INPUT] button). The TRK COPY icon will light whenever the Track Copy function is selected (by pressing the [TRACK COPY] button). See page 37 & 38.
- ☼ This is the Interpolation Indicator. When it flashes, it indicates that errors have been detected and corrected using an interpolation scheme. It is a good idea to clean the tape heads and/or make a backup copy of your tape if you ever see this icon light. See Appendix C for more information.

## TIME COUNTER & ABS/REL BUTTON

The TIME Counter (found at the top left section of the display) is used to indicate the current tape position.

ABS 0<sub>H</sub> 15<sub>M</sub> 48<sub>S</sub> 21

The [ABS/REL] button toggles the TIME counter between Absolute Time mode and Relative Time mode. The XT will indicate which Time mode is selected by either displaying ABS (for Absolute Time) or REL (for Relative Time) just to the left of the TIME counter.

REL 0<sub>H</sub> 01<sub>M</sub> 29<sub>S</sub> 03

**ABS Absolute Time:** This is the XT's time reference, which is created when a tape is formatted.

**REL Relative Time:** This is based on the XT's time reference of a formatted tape, but is relative to where the tape was positioned when LOCATE 0 was stored.

J

*The Locate Points ' addresses are displayed in the format of the display mode you've selected.*

See the *Autolocation* section later in this chapter for more information about the difference between ABS Time and Relative Time.

- When no tape is present the counter will display "-- -- -- --".
- When an unformatted tape is played, the display will read "noFo" and the FORMAT icon will flash.

The TIME counter (in either Absolute Time or Relative Time modes) indicates time code in hours:minutes:seconds.100ths-of-seconds.

minutes      seconds  
 |            |  
 hours — 0 : 03 : 28 : 15 — 100ths-of-seconds

## LOCATE 0

Pressing the [LOCATE 0] button will take you either to the absolute 0:00:00.00 position (if ABS Time mode is selected) or to the relative 0:00:00.00 position (if Relative Time mode is selected). The Absolute 0:00:00.00 position never changes, since it is derived from the timecode that was written onto tape during the formatting process. The Relative 0:00:00.00 position is user-definable.

You can set the Relative 0:00:00.00 position at any time by pressing the [SET LOCATE] button followed by the [LOCATE 0] button. This automatically switches the TIME counter to Relative Time mode (if not already selected); the REL icon appears to the left of the TIME counter. The counter will now read:

REL 0<sub>H</sub> 00<sub>M</sub> 00<sub>S</sub> 00

## BASIC EDITING

### EDIT VALUE BUTTON

The [EDIT VALUE] button is used to turn Edit mode on and off. When turned on, the EDIT icon will light indicating you are now in Edit mode. At this point, you can press any one of the [LOCATE 0] - [LOCATE 9], [TAPE OFFSET] or [TRACK DELAY] Function buttons to view and/or edit their respective parameter settings in the display. The icons just below the EDIT icon in the display will indicate which feature is currently selected for editing (when in Edit mode), and which features are on or off (when not in Edit mode). When Edit mode is selected, the TIME counter provides a display of the selected parameter's current setting.

The first time [EDIT VALUE] is pressed, Locate 0 will be selected. While the EDIT icon is still on, you can press another Function button to access its parameter(s). Press [EDIT VALUE] again to exit Edit mode; the EDIT icon will turn off. Pressing a Function button now will toggle that function on or off. The next time Edit mode is turned on, the display will return to the last function you were editing before exiting Edit mode.

Function Button	When Edit Mode is on...	When Edit Mode is off...
[LOCATE 0]–[LOCATE 9]	Edit Locate Point address	Execute a locate
[TAPE OFFSET]	Edit Tape Offset amount	Tape Offset on/off
[TRACK DELAY]	Edit Track Delay settings	Track Delay on/off

### s AND t BUTTONS

Once a function is selected, the s and t buttons are used to increment or decrement its setting by single values. By holding either button, the increment or decrement value increases its speed. By simultaneously pressing both buttons, the selected parameter is reset to 0.

### ENTERING NUMERIC VALUES

If [EDIT VALUE] is held while in Edit mode, you may use the [LOCATE 0] – [LOCATE 9] buttons as a 10-digit keypad (from 0 to 9) to enter a specific numerical value for the currently selected parameter in the display. Numbers are entered from left to right.

*Examples:* If [LOCATE 1] is pressed using this method to edit Track Delay time (displayed as XXX.X ms), the display would show .1 ms. If a [LOCATE 5] is now entered, the display shows 1.5 ms. If the [EDIT VALUE] button is released at this time, the display shows 001.5 ms and that would be the new Track Delay value. Likewise, if this method is used to edit a Locate Point (X:XX:XX.XX) and the sequence of numbers were entered as follows: [LOCATE 1] – [LOCATE 2] – [LOCATE 3], the display would successively show . 1, .12, 1.23. If the [EDIT VALUE] button is then released, the display would show 0:00:01.23 and that would be the Locate Point's value.

### EDITING INDIVIDUAL DIGITS

You can also select a specific digit in the display to edit, by holding the [EDIT VALUE] button and pressing either [s] or [t]; the currently selected digit will flash. While still holding the [EDIT VALUE] button you may press any of the [LOCATE 0] – [LOCATE 9] buttons to enter a specific numerical value for the currently selected digit. The selected digit will replace the previous one and will stop flashing, and the next digit to its right will be selected (flashing) so you may continue entering digits using the [LOCATE 0] – [LOCATE 9] buttons.



## INPUT SELECT

There are three buttons for input select options. These three buttons are labeled [ANALOG INPUT], [DIGITAL INPUT], and [TRACK COPY]. These determine what signals will be recorded on the XT. The currently selected input mode is indicated in the lower right corner of the display: ANALOG, DIGITAL or TRK COPY.



While any of the Input Select buttons are being held, the channel record and input status indicators no longer indicate the current record or input status, and the REC icon turns off. As long as one of these buttons is being held, the tracks' INPUT LED is used to indicate channel selection for that particular function, and the RECORD ENABLE buttons [1] – [8] are used to select and de-select channels (see page 41).

### ANALOG INPUT

Pressing the [ANALOG INPUT] button once selects the analog inputs (both unbalanced and balanced) for recording and monitoring; the ANALOG icon will light in the INPUT icon group in the display. While holding the [ANALOG INPUT] button, the channel input indicators will show the number of analog inputs that are currently selected. There are three selections possible: Two inputs, four inputs, or eight inputs. This allows you to record from a 2 or 4 bus mixing console without repatching.

- To choose 2-input mode: Press either the channel 1 or 2 RECORD ENABLE buttons while holding [ANALOG INPUT]. This will cause both the channel 1 and 2 input lights to light up, indicating that only input channels 1 and 2 will be used. If any of tracks 1, 3, 5, or 7 are record enabled, they will receive their input signal from the analog input of channel 1. If any of tracks 2, 4, 6, or 8 are record enabled, they will receive their input signal from the analog input of channel 2.
- To choose 4-input mode: Press RECORD ENABLE button 3 or 4 while holding the [ANALOG INPUT] button. This will cause channels 1 through 4 INPUT LEDs to light up, indicating that only input channels 1 thru 4 will be used. In this case, channels 5 through 8 receive their input from channels 1 through 4, respectively.
- To choose 8-input (the most common) mode: Press RECORD ENABLE button 5 thru 8 while holding the [ANALOG INPUT] button. This will cause all eight track INPUT LEDs to light. In this mode, each track receives its signal from its own input.

**J** *In 2-input mode, inputs 3-8 are disconnected and cannot be recorded or heard. In 4-input mode, inputs 5-8 are similarly disconnected. To use all inputs, 8-input mode must be selected.*

### DIGITAL INPUT

To record from the digital input, press the [DIGITAL INPUT] button; the DIGITAL icon in the INPUT icon group will light. The digital input can be used to record from another XT or ADAT-compatible optical signal. All eight channels will be received via the fiber optic connection (see *Digital In/Out* in Chapter 3) and the analog inputs will be ignored. However, by holding the [DIGITAL INPUT] button, you may reroute incoming channels to record on different tracks; *Example:* Digital audio received on channels 1 and 2 can be rerouted and recorded onto tracks 3 and 4. For more information about recording from the digital input and digital track bouncing, see chapter 5, page 59.

### TRACK COPY

The [TRACK COPY] button is used to digitally bounce tracks within a single XT. To digitally bounce tracks, you must first press [TRACK COPY]; the TRK COPY icon in the INPUT icon group will light. Next, select the source tracks, select (record enable) the destination tracks, and initiate recording. The track copies will be an exact duplicate of the original (i.e. it is exactly aligned with the original and is an exact clone).

While holding the [TRACK COPY] button, the track's INPUT LEDs will indicate the selected source channel(s). While still holding the [TRACK COPY] button, the source tracks may be selected and de-selected by pressing the RECORD ENABLE buttons [1] – [8]. Releasing the [TRACK COPY] button will return the channel REC and INPUT indicators and RECORD ENABLE buttons to their normal status. At this point, you may record-enable the destination tracks (see next section).

When copying tracks:

- The source tracks will be recorded onto the destination tracks in ascending order. *Example:* If source tracks 1 and 3 are selected and tracks 5 and 6 are record enabled, then track 1 will be copied to track 5 and track 3 to track 6.
- If more destination tracks are selected than source tracks, the source tracks will repeat (cycle). *Example:* If tracks 7 and 8 were added to the destination tracks of the previous example, then track 1 would be copied to tracks 5 and 7 and track 3 would be copied to tracks 6 and 8. This scheme also allows for copying a single track to multiple tracks.
- Since no more than 4 tracks may be copied within a single machine, a maximum of 4 source tracks will be allowed. This means that if 4 source tracks are already selected, then no other tracks can be selected until one of the 4 tracks is de-selected.
- A digital source track cannot be selected as a digital destination track (i.e. digital source tracks will not be allowed to be record enabled when Track Copy is enabled).
- If no source tracks are selected, you will not be able to place any tracks into record-ready. If user attempt to record enable a track, the track will not be enabled (REC LED will not light) and “noSovrcE” will be temporarily displayed in the TIME counter.
- When Track Copy mode is enabled (TRK COPY icon lit), the All Input Monitor will not function. If the All Input Monitor is on when Track Copy is enabled, it will automatically be turned off (ALL icon in the INPUT MON icon group will turn off). See page 39 for more information about the All Input Monitor.
- Any track delays that you have programmed will be in effect.

## INPUT MONITOR

The Input Monitor controls consist of two buttons: [ALL INPUT] and [AUTO INPUT].

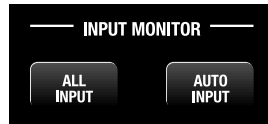

### AUTO INPUT MONITOR

This feature determines what you will hear from the XT's output jacks when a track is record-enabled (REC LED flashing): tape, or source. The [AUTO INPUT] button toggles the Auto Input Monitor on and off. When a track is monitoring its input signal, its INPUT LED will be lit.

- When the Auto Input Monitor is off (AUTO icon in the INPUT MON icon group is off), all record-enabled tracks will monitor the input signal and all other tracks will monitor the taped signal.
- When the Auto Input Monitor is on (AUTO icon is lit), it allows input monitoring of record enabled tracks while in record, stop, rewind or fast fwd; but not in play.

The reason for having these two options is to accommodate different stages of the recording process. Leaving the Auto Input Monitor off is the “normal” option and is what you would use when first recording tracks. When performing punch-ins and overdubs, you will probably want to turn the Auto Input Monitor on so that you can hear what was recorded on tape for a given track right up to the point you want to punch in. As soon as the XT punches into record mode, the tape signal is replaced by the input signal so you can hear what's being recorded to tape. After you punch-out, the monitor reverts to tape.

Typically, Auto Input should be on when the Rehearse feature is used (see page 52).

### ALL INPUT MONITOR

When the [ALL INPUT] button is on (ALL icon in the INPUT MON icon group is lit), the Auto Input Monitor setting is overridden so that all tracks monitor their input signals regardless of their record enable status. All eight track INPUT LEDs will be lit. When All Input Monitor is off (ALL icon is off), the Auto Input Monitor setting determines track monitoring.

The All Input Monitor will automatically be turned off if Track Copy mode is enabled (by pressing the [TRACK COPY] button (see page 38).

The following table indicates the status of tracks that are record-enabled and tracks that are not depending on the status of the [AUTO INPUT] and [ALL INPUT] buttons.

Record-enabled tracks = ■ ; Tracks not record-enabled = □

Transport Function	Auto = Off All = Off	Auto = On All = Off	Auto = Off/On All = On
Stop, Pause, Rew., F.Fwd	■ = Input □ = Tape	■ = Input □ = Tape	■ = Input □ = Input
Play	■ = Input □ = Tape	■ = Tape □ = Tape	■ = Input □ = Input
Record	■ = Input □ = Tape	■ = Input □ = Tape	■ = Input □ = Input

## METERS

The XT provides two buttons for meter display options: [PEAK MODE] and [PEAK CLEAR].

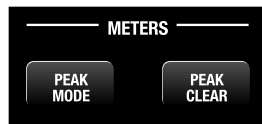

### PEAK MODE BUTTON

The [PEAK MODE] button selects the peak hold mode of the eight level meters. Each time the [PEAK MODE] button is pressed, the peak meters switch between three possible Peak Hold modes: Continuous, Momentary and Off. The currently selected mode may be determined by observing the peak meters themselves.

- **Continuous:** Each track's peak LED indicator will remain lit, until the [PEAK CLEAR] button is pressed, or the Peak Mode is changed.
- **Momentary:** Each track's peak LED indicator will remain lit for about two seconds.
- **Off:** No peak indicators will be held on any tracks.

### PEAK CLEAR BUTTON

The [PEAK CLEAR] button is used to remove any track peak LED indicators which remain lit while either Continuous or Momentary Peak Mode is selected (see above). This button will have no effect if the Peak Mode is turned Off.

### FINE METER MODE

The XT provides a special mode which rescales the peak meters for more specific readings. This is necessary when making very fine level adjustments, such as when recording test tones. When Fine Meter mode is enabled, the meters are rescaled around a center point of -15 dB (middle point of the meters) and goes plus and minus from there in .5 dB increments. This means the -15 dB icon will be the only level marking that is correct in this mode. The meters' actual range will be from -18.0 dB to -12.5 dB. However, the MAX icon at the top of each meter will still indicate clipping.

#### To activate Fine Meter mode:

- ¿ Simultaneously press both [PEAK MODE] and [PEAK CLEAR] buttons.  
*The TIME counter will momentarily display "FinE db" and the dB stepped markings will appear on the left side of the meters.*
- ¡ To exit Fine Meter mode, press either [PEAK MODE] or [PEAK CLEAR].  
*The dB stepped markings will turn off.*

*Note:* The Peak Hold function is disabled (off) when Fine Meter mode is enabled.

## RECORDING A "BENCHMARK" TAPE

We recommend that you format and record a new tape with any signal, such as a test tone, in a single pass with no overdubs during the first week of operation. Store this tape in a safe, dry location and don't use it for any other purpose. Such a "benchmark" tape is useful to determine if the error correction rate is increasing over time because the heads need to be cleaned, or if a tape is defective (see page 75).

## RECORD ENABLE

To record enable a track, press the track's RECORD ENABLE button.

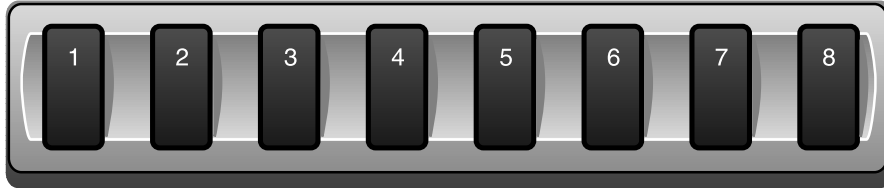

When you press a track's RECORD ENABLE button for the first time, the track's red REC LED will flash, indicating the track is in record-ready, and its INPUT LED will light (unless Auto Input is on and the transport is in play), indicating you will be able to monitor that track's input. If the transport is put into record mode (see *Transport Controls* in this chapter), recording will begin on this track; the track's REC LED will stop flashing and remain lit. To disable record-ready, press the track's RECORD ENABLE button once again. The track's REC LED will turn off.

RECORD ENABLE buttons can be turned on or off while you are in record mode.

## SETTING LEVELS

Unlike analog tape recorders, where signals routinely exceed 0 dB with no apparent ill effects, 0 dB on the XT represents the maximum possible signal level. Signals above 0 dB will be clipped and lead to digital distortion.

Because of the limitations of analog tape, there is always a tradeoff between noise, level and distortion. More level improves the signal-to-noise ratio, but also increases distortion. This distortion increases linearly, which is why signal-to-noise is often specified for a certain amount of distortion (typically 3%). You can always record with hotter levels or softer levels, but either more distortion or more noise will result—with analog, you can't have low noise, high levels and low distortion.

With digital recording, there is a much wider dynamic range, and distortion does not increase with increasing level. Yet once a digital system runs out of headroom and hits 0 dB, that's it—the onset of distortion is immediate and very noticeable if the signal is sustained several dB above the limit. Even though very short peaks above 0 may not last long enough to cause audible distortion, you aren't capturing the signal in its original form. As a result, because of the XT's signal to noise characteristics, it's better to err on the side of setting levels not quite high enough rather than having them distort, especially during live recording when you don't get a second chance. In the studio, where you have more control over levels or are using compressor/limiters, it's OK to light up the MAX LED on the meter on the very loudest peaks, as long as you're sure that signals aren't going beyond that point (by using the meters on your console, if they go beyond +15 dB).

However, since 0 dB on the XT equals the maximum level, the input reference level is set below 0 VU. With the XT, a 0 VU signal on a +4 dBu mixer plugged into the XT's +4 dBu connectors (or a 0 VU signal on a -10 dBV mixer plugged into the XT's -10 dBV connectors) will register -15 dB on the XT's meters. Therefore, you can run the mixer over 0 VU and still have 15 dB of headroom on the XT before distortion occurs. Just remember that no matter what, if the XT's meters indicate over 0 dB, distortion is occurring or is on the verge of occurring.

**J**

*Be sure the output level of your mixer matches the inputs connected to the XT (+4 or -10).*

## TRANSPORT CONTROLS

The XT's six transport control buttons resemble those of a conventional tape recorder, although there are several extra features.



### EJECT

Press the [EJECT] button to eject the tape from the XT. If the tape is moving, it will stop before ejecting. In a multiple XT system where there is one master and one or more slave XTs and/or ADATs, pressing [EJECT] on the master will eject the tapes on all machines; pressing [EJECT] on a slave machine will only eject the tape on that machine.

**J** *The [EJECT] button will not operate while recording or formatting to avoid interrupting these processes.*

### REWIND/REVIEW

Press the [REWIND] button to rewind the tape; the [REWIND] LED lights. When fully rewound, the [REWIND] LED turns off and the [STOP] LED lights.

- Pressing [REWIND] while recording punches out before rewinding.
- Threaded tapes rewind at about 40 times normal play speed. Unthreaded tapes rewind slightly faster.
- Pressing [REWIND] while holding the [PLAY] button initiates "Review" mode. The tape rewinds at about 3 times normal play speed, and you can hear chunks of attenuated audio so you know where you are on the tape. The [PLAY] LED will be lit, and the [REWIND] LED will be flashing. Pressing the [PLAY] button alone returns the transport to normal play mode.

### FAST FORWARD/CUE

Press the [FAST FWD] button to fast forward the tape; the [FAST FWD] LED lights. Upon reaching the tape's end, the [FAST FWD] LED turns off, and the [STOP] LED lights.

- Pressing [FAST FWD] while recording punches out before fast forwarding.
- Threaded tapes fast forward at about 40 times normal play speed. Unthreaded tapes fast forward slightly faster.
- Pressing [FAST FWD] while holding the [PLAY] button initiates "Cue" mode. The tape fast forwards at about 3 times normal play speed, and you can hear chunks of attenuated audio so you know where you are on the tape. The [PLAY] LED will be lit, and the [FAST FWD] LED will be flashing. Pressing the [PLAY] button alone returns the transport to normal play mode.

### PLAY

Press the [PLAY] button to play the tape ([PLAY] LED will light). The [PLAY] button by itself has no effect while playing, but it will terminate recording. While locating,

pressing [PLAY] will cause the XT to start playing after it arrives at the corresponding tape location ([PLAY] LED will flash to indicate *deferred* play mode).

Pressing [PLAY] while recording causes the XT to punch out (recording stops and playback continues). Pressing [PLAY] in any mode other than locating causes the transport to enter play mode, and the [PLAY] LED lights.

**J** *What occurs when you press [PLAY] after inserting a tape in the XT depends on whether the tape being played is formatted or not.*

- **Formatted.** The tape plays normally and the tape counter shows elapsed time since the beginning of the tape.
- **Unformatted tape.** The XT will detect the lack of a format and flash the FORMAT icon while reading “noFO” in the TIME counter.
- **Tape transitions from a formatted to unformatted section while playing back.** The XT will detect the lack of a format and flash the FORMAT icon while reading “noFO” in the TIME counter.
- **Tape transitions from a formatted to unformatted section while recording.** The XT will detect the lack of a format and stop.

## RECORD/PUNCH IN OR OUT

Use the [RECORD] button to enter or exit record mode, and to format a tape. There are two methods of entering record mode. You can first enable the tracks you wish to record on and then engage recording using the [PLAY] and [RECORD] buttons. Or you can engage record mode and then use the RECORD ENABLE buttons to place tracks in or out of record. If no tracks are enabled for recording and record mode is engaged, the [RECORD] LED will flash to indicate that pressing any RECORD ENABLE button will immediately initiate recording on that track.

### To start recording:

- Hold [PLAY] and press [RECORD] to cause any record-enabled track to enter record mode. This is recommended for punching “on the fly.”
- Hold [RECORD] and press [PLAY] to cause any record-enabled track to enter record mode. This is recommended for initiating recording when the tape is stopped, or for punching “on the fly.”

To punch out and stop the transport, simply press [STOP]. There are three ways to exit record mode (punch out) yet have the transport continue to play; use whichever method is most natural to you.

- Press [PLAY].
- Hold [RECORD] , and then press [PLAY].
- Use the RECORD ENABLE buttons [1] – [8] to take tracks out of record.

## STOP

The [STOP] button performs three functions.

- **Stop the transport.** Push [STOP] to stop any function involving tape motion. A lit [STOP] LED indicates that the tape is not moving and is threaded. A flashing [STOP] LED indicates that the tape is not moving and is unthreaded.
- **Thread/Unthread the tape.** While the [STOP] LED is lit, press [STOP] to unthread the tape ([STOP] LED flashes). While the [STOP] LED is flashing, press

[STOP] to thread the tape ([STOP] LED is lit). Entering play or record more will also thread the tape, if it was previously unthreaded.

- **Punch out.** When recording, pressing [STOP] will exit record mode and stop the transport.

## SAMPLE RATE (CLOCK)

The XT records digital audio in a similar manner as a DAT recorder or digital sampler. You may select between two sample rates when using the XT's internal clock: 48 kHz and 44.1 kHz. Select the sample rate to match the balance of the recording system you are connected to.

The currently selected sample rate is indicated by the CLOCK group of icons in the display. When the INT and 44.1K icons are lit, the XT is set to an internal 44.1 kHz clock. When the INT and 48K icons are lit, the internal 48 kHz clock setting is in use. The default setting is internal 48 kHz (INT 48K).

**J** *Changing the clock from 48kHz to 44.1 kHz, or vice-versa, will change the reference point upon which the Pitch controls are based. This will also cause the TIME counter to change; the Locate Points (see pages 48 & 49) will be referenced to different time positions (when viewed), although they still correspond to the same physical tape positions as before.*

### To select the sample rate:

- ¿ Press the [CLOCK SELECT] button.  
*Each time the [CLOCK SELECT] button is pressed, the right side of the display will cycle through the following settings: INT 48K, INT 44.1K, DIG 48K, and DIG 44.1K.*

For more info on DIG and EXT clock settings, see chapter 5.

It is recommended that you select the sample rate you want to use *before* you format a tape. During the formatting process, the sample rate information is written onto the tape. This information allows the XT to know what sample rate the tape was originally formatted at. When inserting a tape that was formatted at 48 kHz, the XT reads the timecode from tape for a moment and automatically selects the 48 kHz clock setting. If the clock is then manually changed to 44.1 kHz, the 44.1K icon will flash, to indicate that you are using 44.1 kHz but it isn't the original sample rate used when the tape was formatted. The same goes when you play a tape formatted using 44.1 kHz with the clock set to 48 kHz; the 48K icon will flash.

If you play back a tape that was formatted on an original ADAT, it will not have any sample rate information written on it (since this is a new feature not found on the ADAT). In this case, the XT will assume the tape was formatted at 48 kHz. Therefore, if you had been pitching-down such a tape on an ADAT to play at 44.1 kHz, you must press the [CLOCK SELECT] button to manually change the clock to 44.1 kHz.

## RECORD CROSSFADE TIME

Crossfading is the process of fading out the original audio on tape while fading in the new audio when punching in (or vice-versa when punching out). Whenever recording begins or ends, the XT provides a smooth transition between the audio on tape and the audio being recorded. This prevents gaps and/or noises when punching in and out of record.

The Record Crossfade Time setting determines how long it takes for the audio to completely transition from the previous audio to the current audio when recording. The default is 11 milliseconds but can be increased to 43 ms. The faster crossfade time allows you to punch in and out quicker, and is best used when the audio on tape



is similar to the audio you are recording. The longer crossfade time allows for a smoother transition and is more useful when punching in new material that is very different from what is already on tape, or when punching in low-frequency signals. Crossfading always begins at the punch point and continues for the amount of time you have specified.

**To set the Crossfade Time:**

- ↻ Press and hold the [SET LOCATE] button.
- ⌋ While holding the [SET LOCATE] button, press the [RECORD] button. This will advance Crossfade setting to its next value, in this case it is 21 ms. The TIME counter will briefly read:

FA dE 2 1

- ↪ While still holding [SET LOCATE], each time you press [RECORD] will advance the Crossfade setting to the next value. *Select either 11 ms, 21 ms, 32 ms and 43 ms. These time values assume a playback rate of 48kHz, and are therefore not exact if the Pitch amount is changed, or an external clock source is used. If the Clock is set to 44.1 kHz, the available crossfade times are actually 12 ms, 23 ms, 35 ms and 46 ms (although they will not be labeled this way). To select the sample rate (48 kHz or 44.1 kHz), see previous section.*

## DISPLAYING FRAMES VS. 100THS/SECONDS

If you are using the XT with the BRC, you will notice that the BRC's TIME display uses the "hours:minutes:seconds:frames" format, while the XT normally uses the "hours:minutes:seconds:100ths/second" format. This may cause some confusion when locating to a specific position on the BRC, since the XT will show a slightly different value when looking at the last two digits of the TIME counter. The XT will locate to the same physical position that the BRC displays, it is simply displaying 100ths/second instead of frames.

It is possible, however, to switch the XT's TIME display so that it counts in a 30 FPS format, instead of 100ths/second. This is done by holding [SET LOCATE] and pressing RECORD ENABLE [4]. Repeat this process to toggle back and forth between these two modes. When set to "frames-per-second" mode, the TIME counter will briefly read "d1SP FPS". When switched back to "100ths-of-a-second" mode, the TIME counter will briefly read "d1SP rEG". This feature is designed for the sole purpose of aligning the displays of the XT and the BRC. The selected mode also affects how the Locate Points are displayed and edited on the XT.

## PITCH CONTROL

The Pitch function controls the speed of the tape, and thus the pitch of the audio recorded on tape. It displays speed as percentage and as cents. A cent is 1/100th of a semitone. For example, if a song is originally recorded in the key of C, then played back with the pitch raised 100 cents, it will be in the key of C#. The XT's Pitch control has a range of -300 to +100 cents when using a sample rate of 48 kHz, and a range of -200 to +200 when using 44.1 kHz. The Pitch controls will not function while locking to an external clock (i.e. while the XT is slaved to another ADAT or is locking to an external digital clock).

The PITCH [s] and [t] buttons control the amount of pitch change. When either button is pressed once, the PITCH icon lights in the display, and the TIME counter immediately displays the current amount of Pitch change. The Pitch amount is displayed both as a percentage (%) and as cents. After a few seconds, the TIME counter reverts back to its normal mode.

ABS    00. 00<sup>%</sup>    00. 00<sup>C</sup>  
           (Percentage)    /    (Cents)

### **To set the Pitch amount:**

- ⌘ If Edit mode is currently on (EDIT icon lit), press [EDIT VALUE] to exit Edit mode. *The EDIT icon should be off.*
- ⌘ Press and hold either PITCH [s] or [t]. *After holding for more than .5 seconds, the Pitch amount will start either increasing or decreasing, depending on which button was pressed.*
- ⌘ To immediately set the Pitch amount to +100, hold [SET LOCATE] and press [s].
- ⌘ To immediately set the Pitch amount to -300, hold [SET LOCATE] and press [t].
- f* To reset the Pitch amount to 0, simultaneously press both [s] and [t]. *Note: This is not possible while recording.*

### ABOUT PITCH CHANGING

Here are a few things to consider when changing the XT's pitch:



- One of the PITCH arrow icons will remain lit in the display to remind you that the pitch has been changed from standard pitch.
- The counter will not elapse in real time when the pitch is set to a value other than zero.
- When you change the pitch on ADAT-XT, the sampling rate will also change. The lowest sampling rate is 40.4 kHz, the highest is 50.8 kHz.
- If the internal clock is set to 48 kHz, but the pitch is lowered -147 cents, the sampling rate is 44.1 kHz. However, for accurate TIME counter display it is better to set the pitch to 0 and change the clock rate (see page 44).

## TRACK DELAY

Track Delay lets you delay individual tracks up to 170 ms, in order to achieve a more desirable “feel.” For example, if the bass track is anticipating the beat, you can push it back so it’s “in the pocket” by delaying it a few milliseconds. If you need one track to play back earlier than the others, try offsetting all other tracks by the same amount. This will make the remaining track appear to be playing ahead of the others.

Track Delay times are set individually per track (or for a group of tracks) in the Track Delay Edit page. Track Delay for all eight tracks may be turned on and off without altering the Track Delay settings of each track.

### **To turn Track Delay on and off:**

- ↻ If Edit mode is currently on (EDIT icon lit), press [EDIT VALUE] to exit Edit mode.  
*The EDIT icon should be off.*
- ⌋ Press the [TRACK DELAY] button.  
*The TRACK DELAY icon will light, indicating that Track Delay values are in effect.*
- ↵ Press [TRACK DELAY] again.  
*The TRACK DELAY icon will turn off, indicating that Track Delay values are disabled.*

### **To set the Track Delay amount:**

- ↻ Press [EDIT VALUE], to turn on Edit mode.  
*The EDIT icon will light.*
- ⌋ Press [TRACK DELAY].  
*The TRACK DELAY icon will light (if not already turned on).*
- ↵ Press one of the eight RECORD ENABLE buttons [1]–[8].  
*The selected track’s REC LED will light and the display will indicate the current Track Delay amount for the selected track. Press a different RECORD ENABLE button to select another track (1–8) to edit.*

ABS                    **1 10.3**                    mS

- ÷ Use the [s] and [t] buttons to adjust the amount of delay for the selected track.
- f Alternatively, you may select a specific digit by holding [EDIT VALUE] and using the [s] and [t] buttons.  
*The selected digit will flash.*
- a While holding [EDIT VALUE], press any [LOCATE] button to enter a value.  
*The next digit to the right is automatically selected, so that you may continue entering digits in this way. Releasing the [EDIT VALUE] button deselects the digit, and the selected digit will stop flashing.*
- D To reset the Track Delay time to 000.0 ms, press both the [s] and [t] buttons simultaneously; or, hold [EDIT VALUE] and press [LOCATE 0].
- « Repeat steps ↵ through D to edit the Track Delay times of any other tracks.

### **To set multiple tracks to the same Track Delay value:**

If you need to “advance” a single track, you can set all other tracks to the same delay value by selecting multiple tracks in step ↵ above. Simply press and hold one RECORD ENABLE button while pressing others you wish to adjust to the same amount, then proceed with steps ÷ through D.

## AUTOLOCATION CONTROLS

The XT's autolocation controls consist of 10 Locate Point memories which can be set either manually or "on the fly", and recalled instantly.

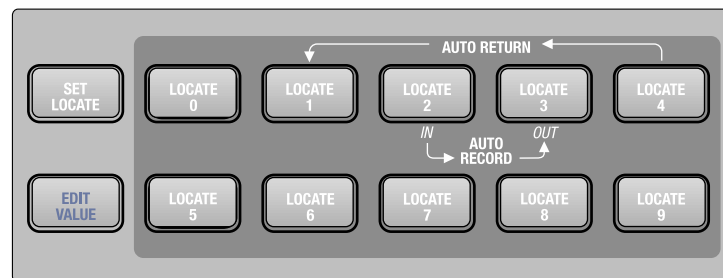

**J** Each Locate Point's address can be displayed and set using either Absolute or Relative Time.

Generally, Absolute Time and Relative Time will differ in their values. The XT, however, maintains a constant offset between them. This makes it possible to locate to various tape positions using either time reference.

### ABSOLUTE (ABS) TIME VS. RELATIVE TIME

The TIME counter indicates where you are on the tape by using a time reference. There are two ways of displaying the time reference off tape: Absolute (ABS), the actual time reference, or Relative, the same time reference but relative to a different zero point. The Relative Time 0:00:00.00 point is set by holding the [SET LOCATE] button and pressing [LOCATE 0], or by editing the Locate 0 point.

Use the [ABS/REL] button to select between Absolute Time and Relative Time modes; one of two icons (ABS or REL) will appear to the left of the TIME counter. When the display is in Absolute Time Mode (ABS icon lit), the display reflects the actual tape time. When in Relative Mode (REL icon lit), the display reflects the tape's time reference relative to the 0:00:00.00 position. Once you hold the [SET LOCATE] button and press [LOCATE 0] to establish a new 0:00:00.00 position on tape (see below), Absolute and Relative times will be offset from one another. However, that offset will remain constant until the next time the relative zero position is reset.

### LOCATE 0

If the [LOCATE 0] button is pressed, the transport will immediately begin locating to the 0:00:00.00 time location of the tape. If the TIME counter is in ABS mode when [LOCATE 0] is pressed, the absolute 0:00:00.00 position is located. If the TIME counter is in Relative mode when [LOCATE 0] is pressed, then the relative 0:00:00.00 position is located. [LOCATE 0] is different from the other [LOCATE] buttons in this respect: it may wind the tape to different locations, depending whether the TIME counter is in ABS or REL mode. All the other locate points represent the same actual (physical) position on tape, regardless of whether the display is in ABS or REL mode.

The [LOCATE 0] button is also used to set the relative zero time. When this button is pressed while holding [SET LOCATE], the relative tape counter is reset to zero (0:00:00.00). Once this occurs, you have changed the Relative Time zero point, and the display will automatically change to Relative Time mode (REL icon lit).

## SETTING LOCATE POINTS

There are two ways of storing Locate Point memories: manually or “on the fly.”

### **To store a Locate Point memory “on the fly”:**

- ⌘ Press [PLAY] to engage playback.  
*Alternatively, the transport may be engaged in either Rewind, Review, Fast Forward, Cue, Record or Stop mode (i.e. the transport does not have to be in Play mode to store Locate Points in the following manner; it is simply the most practical way to do it).*
- ⌘ Press and/or hold the [SET LOCATE] button.  
*The LOCATE icon will light and a dash (–) will begin flashing to its right.*
- ↪ Immediately press one of the [LOCATE 0] – [LOCATE 9] buttons.  
*The current tape location will be stored into the Locate Point memory you selected. If [LOCATE] button is not pressed within 2 seconds after releasing [SET LOCATE], the flashing dash will disappear and none of the Locate Point memories will be changed.*
- ÷ To store multiple Locate Points, you may continue holding the [SET LOCATE] button and press any of the [LOCATE] buttons when the desired tape positions are reached.

### **To edit a Locate Point memory:**

- ⌘ Press [EDIT VALUE] to enter Edit mode.  
*The EDIT icon will light.*
- ⌘ Press one of the [LOCATE 0] – [LOCATE 9] buttons to select a Locate Point address.  
*The LOCATE icon will light, the selected Locate Point’s number (0-9) will appear next to it, and the address of the selected Locate Point will be displayed in the TIME counter.*
- ↪ Use [s] and [t] buttons to fine tune the Locate Point’s address.
- ÷ Alternatively, you may select a specific digit by holding [EDIT VALUE] and using the [s] and [t] buttons.  
*The selected digit will flash.*
- f While still holding [EDIT VALUE], press any of the [LOCATE 0] – [LOCATE 9] buttons to replace the selected digit with.  
*The next digit to the right is automatically selected, so you may continue entering digits.*

## LOCATING

Once you have stored one or more tape positions into the Locate Point memories, pressing any of the [LOCATE 0] – [LOCATE 9] buttons while Edit mode is *not* selected will initiate a locate to its respective address. The TIME counter will momentarily display the selected Locate Point’s address and the Locate Point’s number (0–9) will appear in the upper-right corner of the display; the transport will either fast forward or rewind to the selected Locate Point’s address.

## AUTO LOOPING

Auto Looping is not a feature in and of itself, but is made up of two important features that, when used together, provide a very useful tool. These two features are: Auto Return and Auto Play. When both are enabled, and set correctly, a section of tape of any length may be continuously repeated.

### AUTO RETURN

When Auto Return is enabled, and the transport reaches the Locate 4 point (the end of the loop), it will automatically rewind to the Locate 1 point (the start of the loop). Notice the arrow on the front panel connecting the [LOCATE 1] and [LOCATE 4] buttons.

To turn Auto Return on or off, press the [AUTO RETURN] button. The AUTO-RTN icon will light when turned on. If Locate 1's position is after Locate 4, the AUTO-RTN icon will flash, and the transport won't rewind as it passes through Locate 4. For Auto Return to work, Locate 1 must be before Locate 4.

### AUTO PLAY

The Auto Play function determines whether or not the transport will automatically go into play when a locate function is completed. This function can also be used in conjunction with the Auto Return function (see above) to create a "loop", whereby a section of tape is played over and over.

To turn Auto Play on or off, press the [AUTO PLAY] button. The AUTO PLAY icon will light when turned on.

### LOOP LIMIT

There is, however, a built-in safeguard that protects the tape and the XT's heads and transport from unnecessary wear and tear by automatically disabling the Auto Loop feature after completing 100 consecutive loops. If this is not to your liking, this safeguard may be disabled. This is done by holding the [SET LOCATE] button and pressing [AUTO RETURN]. However, Alesis recommends doing so *only* when you absolutely have no other alternative. The 100 loop limit will be enabled again once [STOP] is pressed.

While the Auto Loop feature is engaged, you may have a "loop count" displayed temporarily by holding the [SET LOCATE] button and pressing [AUTO PLAY].

## AUTO RECORD

The Auto Record function lets you determine exactly where recording should begin and end beforehand, so that the machine automatically takes you in and out of record. Locate Points 2 and 3 determine the in and out points.

After setting both Locate Points 2 and 3, press the [AUTO REC] button to enable this function; the AUTO REC icon will light. To execute a "take", rewind to a position *before* Locate Point 2, then hold [RECORD] and press [PLAY], just as you would to record normally. When the Locate 2 position is reached, recording will begin. When the Locate 3 position is reached, recording stops while the transport continues.

### **To execute an Auto Record take:**

- ⌘ Record-enable the track(s) you wish to record on (see page 41).
- j Press [AUTO RECORD].  
*The AUTO REC icon will light.*

**J** *If [AUTO REC] is pressed when the Locate 2 position is set beyond or at the same position as the Locate 3 position, the TIME counter will momentarily read "invALid" indicating that this is not possible, and you will not be able to enable the Auto Record function until you change either Locate 2 or 3's position.*

- ↶ Rewind the tape to a position prior to the Locate 2 position.
- ÷ Hold [PLAY] and then press [RECORD].  
*The [PLAY] LED will light, and the [RECORD] LED will flash.*

*Upon reaching the Locate 2 position, recording will begin on any record enabled tracks and the [RECORD] LED will light solid. If no tracks are record enabled when the Locate 2 position is reached, the [RECORD] LED will continue flashing and no recording will take place. At any time before the Locate 3 position, a track may be record enabled, which will cause the track to immediately enter record and the [RECORD] LED will light solid. Upon reaching the Locate 3 position, recording will cease and the [RECORD] LED will turn off.*

**J** *Whenever the XT is put into play, it requires a brief moment to locate the timecode reference on tape and "lock." If the Locate 2 position is reached while the AUTO REC icon is lit before the XT establishes a lock, the punch in will not take place until a lock has been established (after the LOCKED icon turns on).*

## LOOPED RECORDING

The Auto Return and Auto Play functions can be used along with Auto Record to create a recording loop. So, you can record a take over and over until you get it right. Simply set Locate 1 to a position several seconds before Locate 2, and Locate 4 to a position after Locate 3. Refer to page 50 for more information.

## REHEARSAL

With Auto Record turned on, you can rehearse before actually recording (or erasing what's already on tape). If you engage Auto Record while Rehearse and Auto Input are enabled, when the Locate Point 2 position is reached, any tracks that are in record-ready will be in input monitor mode and the [RECORD] LED will continue flashing. When the Locate Point 3 position is reached, any tracks that are in record-ready may return to tape monitor mode. The [REHEARSE] button turns Rehearse mode on and off; the REHEARSE icon will light when enabled. Note that if Auto Input is not enabled, Rehearse will have no effect on what you hear in your monitor mix.

## TAPE LENGTH

The XT can take advantage of the extra recording time on tapes longer than the standard ST-120 length. You can use ST-180 tapes, for over one full hour of recording time. ST-60 tapes can also be used for shorter projects; the XT

automatically recognizes the shorter length of the ST-60 because the hubs used in the cassette are larger. However, there is no way for the XT to tell apart a ST-120, ST-160 or ST-180 tape, since these all use the same, smaller size hubs. In this situation, the XT assumes the tape length to be that of a ST-120 tape. Therefore, when using either ST-160 or ST-180 length tape, you should set the tape length on the XT.

**To set the tape length:**

- ⌘ Hold the [SET LOCATE] button and press the [FORMAT] button;  
*This display will briefly read "St-60".*
- ⌘ Repeat step ⌘ to advance through the available tape length choices.  
*The display will cycle through the following choices:  
"St-120", "St-60", "St-160" and "St-180".*
- The tape length setting is not reset when a tape is ejected. However, if you power down and up again, the tape length setting will revert to T-120.
- If connected to a BRC, and you set the tape length from the BRC, the XT "remembers" the tape length setting, even after power down.
- If you insert a tape while the Tape Length setting is set to something other than "St-120", the display will briefly flash the selected Tape Length setting. This is to remind you that you are using a non-standard setting.
- If using more than one XT/ADAT, you must make sure all connected XTs/ADATs are loaded with tapes of the same length.

**J** *It is important that the Tape Length setting and the actual tape's length are the same. Never use a shorter tape length than what you have indicated on the XT.*

Below is a list of the four S-VHS tapes which can be used with the XT, with their European equivalents and approximate recording times:

Type	Euro	Rec. Time
ST-60	n/a	22 min.
ST-120	SE-180	40 min.
ST-160	SE-240	54 min.
ST-180	SE-260	62 min.

*Note:* European tapes are actually slightly longer than their US equivalents. Therefore, you may get a few more minutes of recording time if using European tape.

**J** *If using tapes longer than the standard ST-120, when locating for the first time past the 39 minute position, the transport will slow down (but not stop) and then speed up again. Each time thereafter that you locate beyond this point, the transport will not slow down. This safeguard is suited for the unlikely event that a longer tape length is erroneously selected, to avoid damage to the tape.*

**J** *If the XT is connected to a BRC, and the tape length is set from the BRC, the individual XT slaves will retain their tape length setting after power down.*



## FOOTSWITCH CONTROLS

The XT provides two footswitch jacks: [LOCATE/PLAY/LRC REMOTE] and [PUNCH IN/OUT]. Both accept any momentary, single pole/single throw, 1/4-inch mono (T/S) footswitch. During power-up, the XT checks the footswitch to determine whether it is normally open or normally closed type, and calibrates itself accordingly. If you use a footswitch and its operation seems “reversed,” make sure it is firmly plugged into the jack, then turn off the XT, wait a few seconds, and turn the XT on again. It will calibrate itself to work with the footswitch.

Either the [PUNCH IN/OUT] or [LOCATE/PLAY/LRC REMOTE] jack can also be used for connecting an LRC Remote Control. The PUNCH footswitch and the LRC cannot be used at the same time, since they occupy the same jack, unless you connect them with a Y-cord. However, you can interchange them if you observe certain precautions (see next section).

### FOOTSWITCH CONTROLLED PUNCHING

The [PUNCH IN/OUT] footswitch is used to enable and disable recording.

- If a track (or tracks) is record-enabled, and the tape is playing, pressing the punch footswitch puts the track(s) into record mode at the instant you punch. This is equivalent to pressing [PLAY] and [RECORD] to enter record mode.
- If the XT is already in record mode, pressing the footswitch punches out of record (the track(s) will remain record-enabled should you need to punch in again later on) and the tape will continue to play. This is equivalent to pressing [PLAY].

### FOOTSWITCH CONTROLLED AUTOLOCATING

The [LOCATE/PLAY] footswitch has three functions:

- If the transport is currently stopped, pressing the Locate/Play footswitch is the equivalent to pressing the [PLAY] button.
- If the transport is currently playing or recording, pressing the Locate/Play footswitch causes the transport to punch out of record, fast wind to the Locate 1 point (this may be entered by pressing [SET LOCATE] followed by the [LOCATE 1] button; see page 47), and then either Stop or Play, depending on the setting of the Auto-Play function.
- If the XT is in the process of locating, pressing the Locate/Play footswitch will stop the transport.

## USING THE XT REMOTE

The XT hand-held remote provides the following functions:

- **Transport functions:** Rewind, Fast Forward, Stop, Play and Record.
- **Autolocation functions:** Locate 1, Locate 2, Locate 3, Locate 4, Set Locate and Auto Loop
- **Track functions:** Auto Record and Rehearse.

All buttons function as if pressed from the XT's front panel.

The [AUTO LOOP] button, which does not exist on the XT front panel, toggles both Auto Play and Auto Return functions on and off simultaneously with one button press.

*Note:* If you wish to enable the Auto Play function without the Auto Return function being enabled (i.e. without looping), you can initiate a deferred play with the Play button — that is, press any of the [LOCATE 1] – [LOCATE 4] buttons followed by the [PLAY] button.

To use the XT Remote, plug it into the [LOCATE/PLAY/LRC] jack or the [PUNCH IN/OUT] jack, depending on which one is not being used. If connected to the master XT in a multiple ADAT system, the XT Remote can control the entire chain of ADATs.

**J** *If using a normally open footswitch, the footswitch and remote control can be interchanged, or used simultaneously with a Y-cord, without restarting the XT (powering down and powering up). However, if using a normally closed footswitch, the XT should be restarted after switching from footswitch to remote control or vice-versa.*

## CHAPTER 5

# MULTIPLE ADAT-XT OPERATION

### OVERVIEW

By itself, a single XT provides a lot of flexibility. However, in a multiple ADAT system presents a whole new set of possibilities. Keep in mind that since the XT is an ADAT-compatible machine, you can intermingle any number of XTs and ADATs together—up to 16 machines total for 128 tracks (see the section entitled *Combining XTs and ADATs* on page 63). When linking multiple XTs and/or ADATs together, the first ADAT in the chain is referred to as the “master”, and the rest are called “slaves”. Each slave is locked to the master, and relies on the time reference from the master machine to keep the system synchronized.

Connections are easy to make; one 9 pin D connector for each slave. A slave will automatically detect a master and go into slave mode.

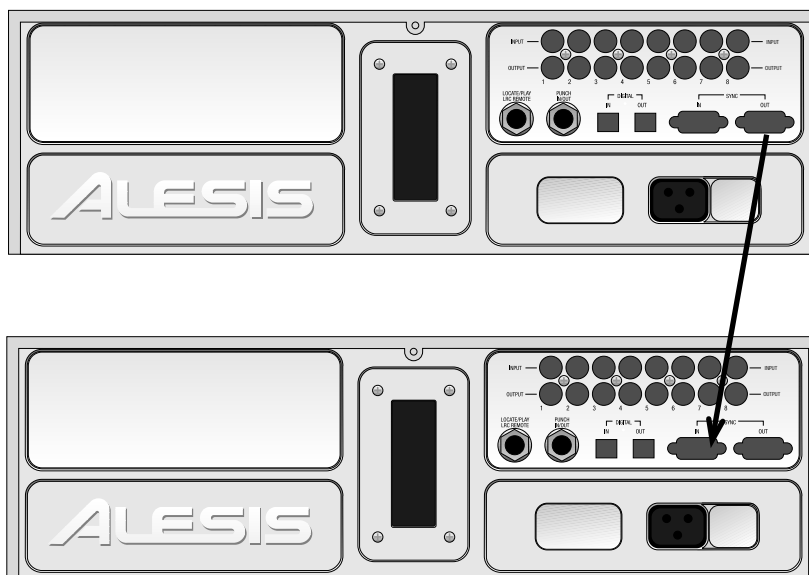

Using the 8-channel proprietary digital bus, you can also bounce tracks between machines in the digital realm. Not only does this result in a perfect copy, but one that is perfectly synchronized with the original. This means you can make perfect safety backups and archives of recordings. One creative way of using a multiple ADAT system (though it can be done with just one XT) is to dedicate two tracks of one machine for stereo mix-down. Since these mix tracks are always in sync with the rest of the system, you can execute a seamless punch at any time. For example, you could mix-down different sections of a recording independent from one another, making changes in the mix as you go along.

Each slave XT can have its own tape offset, with respect to the master machine. Combine this feature with the ability to bounce tracks in the digital domain, and you have the ability to perform cut-and-paste style assembly editing.

### SYNCHRONIZING MACHINES

Synchronization requires a dual male, 9 pin D connector cable for each slave to be synchronized. Use only Alesis cables. Alesis Sync Cables are available in three different lengths: 8", 30", and 30' from your dealer. Other types of cables may cause incorrect commands to be received, and erratic sync performance. This connection should be made while power is off, but the machines do not need to be turned on in any particular order. For more about connections, refer to the section entitled *Sync In/Out* in Chapter 3.

After you've connected multiple XT's and/or ADATS together and turned them on, the master's display will show "ID 1" (identifying itself as the number 1 machine in the system). The second machine will display ID 2, the third ID 3, and so on. The ID order is automatically assigned according to how the cables are hooked up. You can re-check a machine's ID at any time by holding [SET LOCATE] and pressing [PLAY].

**J** *If a slave does not display an ID number on power-up, then it does not see anything connected to the [SYNC IN] jack. Check the cables and connections.*

If needed, the machines will renumber their IDs if more XT's or ADAT's are connected later. *Example:* Suppose you have three XT's hooked up so that machine 1 is the master, and machines 2 and 3 are slaves. If you turn on only machines 2 and 3, machine 1 will not be active so machine 2 decides it's the master (ID 1) and machine three the only slave (ID 2). If you then turn on machine 1, the machines will renumber themselves so that machine 1 becomes the master (ID 1), and machines 2 and 3 become the slaves (ID 2 and 3, respectively). Note that in this example, if machines 1 and 3 are turned on but machine 2 is turned off, machine 3 will not slave to machine 1 because machine 2 is turned off, so the sync signal cannot pass through it from 1 to 3.

All slave XT's will automatically be placed in External Clock mode (the EXT icon will be lit in the CLOCK icon group). The [CLOCK SELECT] button will not function on the slave XT's since External Clock is their only option. Simultaneously, each slave's CHASE icon will light whenever it is *chasing* the location of the master.

## MASTER/SLAVE INTERACTION

Pressing any of the transport buttons ([PLAY], [STOP], etc.), or [AUTO REC], [LOCATE 0] – [LOCATE 9], [ALL INPUT], [AUTO INPUT], PITCH [s] or [t] will automatically trigger the same functions on the slave machine(s) as well. Alesis recommends that you always initiate operations from the master, including all transport control functions, to minimize confusion. When you press [PLAY] on the master, the slave(s) will locate to the same timecode point and begin playing once sync is achieved (indicated by the LOCKED icon being lit). Pressing [EJECT] on the master ejects all slave's tapes as well. To eject only the master's tape, hold [SET LOCATE] and press [EJECT] on the master.

When recording or punching in on the slaves, initiate recording on the master *but do not have any master tracks record-enabled* (unless, of course, you need to record tracks on the master). Any tracks that are record-enabled on the slaves will go into record, while the master will simply *play*. This is why record enable is an independent function for each slave. There are two other functions when the slave(s) act independently. Formatting is initiated independently on each slave for a number of reasons, as detailed in the next section; however, simultaneous formatting on all slaves is possible. Digital Input can also be set independently for the slave(s) since you may want to record via the analog inputs on some machines and via the digital inputs on others.

## ACHIEVING LOCK

In a multiple ADAT system, the slaves will “chase” the master (CHASE icon will light on the XT) and can only enter record once they are in perfect sample-lock. Audio will not appear at the outputs of an ADAT until sample-lock sync is achieved. When an XT is in lock, the LOCKED icon will light. To achieve the fastest chase-lock performance from a multi-ADAT system, use the Locate points whenever possible.

## INDEPENDENT SLAVE MODE

If the master XT is stopped, each of the slaves will function independently. For example, press [PLAY] on one of the slaves and it will go into play mode (or press the [AUTO INPUT] button on a slave, etc.); the other slaves and the master will not respond to this command. However, any time you press [PLAY] on the master or initiate any transport function, it will take over and control all the slaves.

## FORMATTING MULTIPLE TAPES

Formatting works similarly to formatting on a single ADAT. However, it is necessary to consider what the slave does when formatting is initiated on the master. See the section entitled *Tape Formatting* in Chapter 4 for more information.

### MASTER FORMAT ENABLED, COMPLETE FORMAT

If the master's FORMAT icon is on, performing a complete start-to-finish format, and the slave tape *is not* already formatted:

- If the slave's FORMAT icon is on, the slave rewinds to the start of the tape and does a complete format along with the master.
- If the slave's FORMAT icon is off, the slave rewinds to the start of the tape and plays, but the TIME counter reads “noFO” (no format) while flashing the FORMAT icon.

If the master's FORMAT icon is on, performing a complete start-to-finish format, and the slave tape *is* already formatted:

- If the slave's FORMAT icon is on, the slave rewinds to the start of the tape and does a complete format with the master.
- If the slave's FORMAT icon is off, the slave rewinds to the start of the tape and plays in sync with the master.

**J** *If any channels are record-enabled, they will start recording at time 0:00:00.00.*

### MASTER FORMAT ENABLED, FORMAT EXTEND

If the master's FORMAT icon is on, and you are extending the format, and the slave tape *is not* formatted:

- The slave plays, but the TIME counter reads “noFO” (no format) while flashing the FORMAT icon.

If the master's FORMAT icon is on, and you are extending the format, and the slave tape *is* formatted:

- If the slave's FORMAT icon is on, the slave autolocates to the same time as the master, then format extension begins with the master.
- If the slave's FORMAT icon is off, the slave autolocates to the same time as the master and plays or records in sync.

**J**

*To properly extend the format, the master and slaves should be playing in sync before punching into format record.*

## MASTER FORMAT DISABLED

If the master's FORMAT icon is off and initiates a RECORD command anywhere in the tape and the slave's FORMAT icon is off:

- If the slave tape is unformatted, the slave plays, but the TIME counter reads "noFO" (no format) while flashing the FORMAT icon.
- If the slave tape is formatted, the slave autolocates to the same time as the master and plays or records in sync,

To properly punch in, the master and slave should be in sync before punching. Otherwise, the master will punch in immediately, but the slaves won't punch in until sync is achieved.

## MASTER FORMAT DISABLED, FORMAT EXTEND

If the master initiates recording from the audio portion of the tape and the slave's FORMAT icon is on:

- If the slave tape is unformatted, the slave plays, but the TIME counter reads "noFO" (no format) while flashing the FORMAT icon.
- If the slave's tape is formatted, the slave autolocates to the same time as the master and then format extension begins.

If the master initiates recording from the start of the tape and the slave's FORMAT icon is on, start-to-finish formatting begins regardless of whether the slave tape is formatted or not.

## RECORDING DIGITAL AUDIO

### BOUNCING TRACKS BETWEEN ADATS

Tracks can be bounced between machines in a multiple ADAT system by using the digital bus. The digital bus is connected in much the same way as the sync cables, and should be done in the same order. Refer to the section entitled *Digital In/Out* on page 27 in chapter 3 for more information on connecting the digital bus. It is also possible to bounce tracks within a single XT *without* the need for connecting the digital bus. See page 38 in chapter 4 for more information.

If the [DIGITAL INPUT] button is pressed, the XT will record from the [DIGITAL IN] connector, and the analog inputs will be ignored (both balanced and unbalanced). Alesis' proprietary multi-channel digital bus carries the 8 tracks of a source XT or ADAT. These 8 channels are routed in a one-to-one relationship to the 8 tracks of the target XT which can record the digital audio.

Note that to create an *exact* (sample-accurate) digital copy from a master to a slave, *both* master and slave machines must have their [DIGITAL INPUT] button's enabled. This is necessary so that the master knows you are making a digital copy and will offset its digital output so that it matches that of the slave machine.

**J** If [DIGITAL INPUT] is selected and there is no optical input, the DIGITAL icon (located in the INPUT icon group) will flash.

When bouncing audio from a master XT to a slave XT, the slave does not need to have its Clock set to DIG since it is already getting accurate clock information from the master, so it is sample-locked to the digital audio it is recording.

### REASSIGNING CHANNELS TO DIFFERENT TRACKS

It is possible to reroute the channel/track assignments so that any incoming channel of digital audio can be recorded onto any track, or multiple tracks. This is done by first holding the [DIGITAL INPUT] button and pressing any of the RECORD ENABLE buttons [1] – [8] to select which source channels you wish to record (while holding the [DIGITAL INPUT] button, the blue INPUT LEDs will light to indicate the selected source channels; by default, all eight INPUT LEDs will be lit). Then, after releasing the [DIGITAL INPUT] button, use the RECORD ENABLE buttons to select the tracks you wish to record the source channels onto (the INPUT LEDs return to their normal status).

- The selected source channels are re-routed to the record-enabled destination tracks, in ascending order. *Example:* If source channels 1 and 5 are selected and tracks 3 and 4 are record enabled, then incoming audio on channel 1 will be routed to track 3 and incoming audio on channel 5 will be routed to track 4.
- If more destination tracks are selected than source tracks, the source tracks will repeat (cycle). *Example:* If tracks 7 and 8 were added to the destination tracks of the previous example, then incoming track 1 would be routed to tracks 3 and 7 and incoming track 5 would be routed to tracks 4 and 8. This scheme allows for copying a single incoming channel to multiple tracks.
- If all 8 channels are selected as source tracks, no digital routing will occur as this gives a one-to-one relationship (and is the power-on default). If no source channels are selected, then digital silence will be input to any record-enabled tracks.

### MAKING DIGITAL BACKUPS

XT tapes can be backed up for safety by copying all eight tracks to another XT (or ADAT compatible machine) via the digital bus. The result is a perfect digital duplication of the original. It's a good idea to make backups on a regular basis, whenever you finish work for the day, or complete a project. The backup can either be sample accurate to the time reference or not. This depends on whether or not the two machines are synchronized together via a 9-pin connector cable. It is recommended, however, that you do have the Sync cables connected between the machines, as described in the section entitled *Synchronizing Machines* on page 56.

When making a backup, the tape you are backing up is normally inserted into the master machine. The tape you are backing up to is inserted into one of the slave machines. This is recommended since the slave machine comes after the master machine in the system chain. NOTE: [TRACK COPY] is not used to make digital tape backups from machine to machine. Track Copy is only used to copy between tracks on the same machine.

#### **To make a backup tape:**

- ⌘ Connect a male/male, 9-pin D connector cable between the [SYNC OUT] of the master XT and the [SYNC IN] of the slave XT.  
*This synchronizes the two machines; the master XT becomes the master (ID 1) and the slave machine becomes the slave (ID 2).*
- ⌘ Connect a fiber optic cable between the [DIGITAL OUT] of the master XT and the [DIGITAL IN] of the slave XT.  
*This routes the digital audio from the master XT to the slave machine.*
- ↔ Connect a fiber optic cable between the [DIGITAL OUT] of the slave XT and the [DIGITAL IN] of the master XT.  
*This routes the digital audio back from the slave XT to the master machine.*
- ÷ Insert the tape to be backed up into the master XT.
- f Insert a blank tape into the slave machine.
- a Press the [DIGITAL INPUT] button on both the master XT and the slave XT.  
*The DIGITAL icon will be lit on both machines.*
- D Press all RECORD ENABLE buttons [1] – [8] on the slave XT.  
The RECORD LEDs for tracks 9–16 (all eight of the slave machine's tracks) will flash. *Be sure that the RECORD ENABLE buttons are switched **off** for tracks 1–8 of the master XT and the write-protect tab (or record tab) is removed (open).*
- « Press both [PLAY] and [RECORD] on the master XT.  
*Since this is the master machine (ID 1), it will simply enter play (since none of its tracks are in record-ready) while engaging record on the slave machine.*
- » Press [STOP] on the master XT after backing up is complete.  
*Both machines will stop.*

If a tape is in very bad condition, you may have difficulty copying it from the master XT to a slave. If the error count is so high that the XT momentarily loses sync during playback, all following slaves will be taken out of record automatically. In this case, put the new tape into the master, and the damaged tape in the slave, and copy from the slave to the master.

## **RECORDING DIGITAL AUDIO FROM OTHER SOURCES**

Recording digital audio onto the XT from a source other than an ADAT Compatible device requires a digital audio interface, like the Alesis AI-1. The AI-1 converts either AES/EBU or S/PDIF digital audio protocols into the Alesis Multichannel Optical



protocol which the XT uses, and vice-versa. Refer to the User's Manual of the digital interface you are using for more information.

When recording digital audio into the XT from another XT or ADAT in a multiple ADAT system, the XT recording the audio is already synchronized with the other machines, so the digital audio is sample-locked when recorded. This is because all slave machines are automatically set to External Clock mode (EXT icon lights in the CLOCK icon group). However, when recording digital audio from some other source, it is necessary to have the XT synchronize to the incoming digital audio. This can be done differently depending on whether you are using a single XT by itself or a multiple ADAT system.

If using a single XT, you must connect the AI-1's ADAT OPTICAL [OUT] to the XT's [DIGITAL IN] using a single fiber optic connector. Press the [DIGITAL INPUT] button on the XT, and set its Clock Source to Digital (press [CLOCK SELECT] until the DIG icon lights in the CLOCK icon group). Now the XT will synchronize to the clock information which accompanies the digital audio coming from the AI-1, which is originating from the digital audio device connected to the DIGITAL [IN] of the AI-1.

In a multiple ADAT system, you have two choices: synchronize the digital audio source to the ADAT system, or sync the ADAT system to the digital audio source.

If the source does not have any kind of clock input (i.e., it cannot be synchronized to an external clock), you have little choice but to choose the later option. This means you must connect the AI-1's ADAT OPTICAL [OUT] to the [DIGITAL IN] of the master ADAT, which of course has its [DIGITAL OUT] already connected to the next slave, and so on. You must then set the master's Clock Source to Digital (press [CLOCK SELECT] until the DIG icon lights in the CLOCK icon group). If no digital audio clock is detected (i.e. when no digital audio is being received by the AI-1), the master XT's DIG icon will flash and it will continue using its own internal clock. When digital audio is sent through the AI-1 (and consequently, a digital clock is received by the master XT), the master XT will synchronize to the incoming digital clock (the XT's DIG clock will stop flashing and remain lit).

If your digital audio source does provide a means for synchronizing to an external clock, you must connect the last slave ADAT's [SYNC OUT] to the AI-1's [SYNC IN]. Next, you must connect the AI-1's [WORD CLOCK OUT] connector to the digital audio source's [WORD CLOCK IN] connector, and adjust its *clock* parameter so that it is synchronizing to the incoming word clock derived from the ADAT system.

## DIGITAL CLOCK CONSIDERATIONS

When switching between the XT's two internal clock sample rates (48 kHz and 44.1 kHz), the reference base used for computing tape location is changed. The result is that the same tape location will appear to have two different time addresses depending on the sample rate (CLOCK) you are using. Since the XT cannot detect the sample rate of an external clock, it is therefore necessary that you select between DIG 48K and DIG 44.1K to choose which reference base the XT should use to calculate tape positions by while syncing to the digital clock. This is done by pressing the [CLOCK SELECT] button. See page 44 for more information.

## TAPE OFFSET

When synchronizing multiple XTs, it is possible to offset any of the slave units from the master. The main reason for doing this would be for cut-and-paste style editing. By bouncing audio over the digital bus to a slave machine which is offset from the master, you can copy portions of audio to different sections of tape without having to re-record the audio. In addition, the Tape Offset feature can be used even if the XT is the master machine in a multiple ADAT system. This is important especially when using the XT with one or more original ADATs as slaves. When offsetting the XT's

tape location, the value is displayed and edited within a + or - 1 hour range, since this is the maximum length of the XT's tape.

*Example:* If you wanted to use the same take of the background vocals of a song from the first chorus for chorus 2 and 3, you could bounce those track(s) to another machine. Then, by offsetting the original machine the track(s) came from, you could bounce back the vocals at the positions corresponding to the other choruses. A good analogy is the type of cut-and-paste editing available on most computer-based sequencers and word-processors; you copy a selection to an invisible "clipboard", and then paste it from the clipboard to any number of locations. In the example above, the first time you bounce audio you are using the track(s) on another machine as a sort of "clipboard". You can then bounce the material back from the clipboard track(s) onto the original tracks at any number of other positions on the tape.

### **Setting the Machine Offset**

- ↻ Press [EDIT VALUE] to enter Edit mode.  
*The EDIT icon will light.*
- j Press [TAPE OFFSET].  
*The TAPE OFFSET icon will light and the TIME counter will display the machine's current Tape Offset value.*

ABS    0<sub>H</sub> 00<sub>M</sub> 00<sub>S</sub> 00

- ↵ Use [s] and [t] buttons to fine tune the Tape Offset value.
- ÷ Alternatively, you may select a specific digit by holding [EDIT VALUE] and using the [s] and [t] buttons.  
*The selected digit will flash.*
- f While still holding [EDIT VALUE], press any of the [LOCATE 0] – [LOCATE 9] buttons to replace the selected digit with.  
*The next digit to the right is automatically selected, so you may continue entering digits.*
- a To change the current value from a positive offset to a negative offset (-), hold [EDIT VALUE] and press [SET LOCATE].  
*The offset digits will remain exactly the same. However, this step will toggle between positive and negative values by either displaying a "-" or not.*
- D To reset the Tape Offset amount to 0:00:00.00, press both [s] and [t] simultaneously.

## COMBINING XTs AND ADATs

### XT TRANSPORT SPEED

The XT's transport speed has been improved to be four times faster in engaged mode than the original ADAT. Because of this and other unique features, it is recommended that you make the XT the master (ID 1) in your system and your ADAT(s) should be the slave(s). Until you need more than 8 tracks, you may want to avoid inserting tape(s) into the slave unit(s). This is because when locating, the ADATs will move slower than the XT. The result is the XT will locate to a specific tape position, stop and wait for the ADAT(s) to get there before going into play.

### SAMPLE RATE VS. PITCH CONTROL

The Clock Select function on the XT is another addition not found on the original ADAT. This function allows you to instantly choose between 48 kHz or 44.1 kHz sampling rates, as well as lets you select a digital clock for applications involving the recording of digital audio from a non-ADAT source). The XT also writes sample rate information when formatting a tape. This way, the XT automatically knows which sample rate a tape was formatted with although either sample rate may be used.

*Example:* When playing back a tape that was formatted at 48 kHz and the Clock is set to 44.1 kHz, the 44.1K icon will flash, to indicate that you are using 44.1 kHz but it isn't the original sample rate used when the tape was formatted. The same goes when you playback a tape formatted using 44.1 kHz with the Clock set to 48 kHz; the 48K icon will flash.

It is important to remember that on the XT, the Pitch Controls are supplemental to sample rate selection. With the original ADAT, you had to pitch down a tape in order to playback at a 44.1 kHz sample rate. This is no longer necessary on the XT due to the addition of the Clock Select function.

If you play back a tape that was formatted on an original ADAT, it will not have any sample rate information written on it (since this is a new feature not found in the original ADAT). The XT will automatically select the 48 kHz setting in this case. Therefore, if you had been pitching-down such a tape to play at 44.1 kHz, you must press the [CLOCK SELECT] button to manually change the XT's Clock to 44.1 kHz.

### INPUT MONITORING

The original ADAT was designed so that when you were monitoring a track's input signal, what you heard was the actual analog input being fed directly to the analog output—the signal did not pass through the A/D and D/A converters. There was an advanced feature whereby, if you held [SET LOCATE] and pressed [ALL INPUT], it would then allow you to monitor the input *after* the converters, so as to hear exactly how the signal would sound when played back from tape.

The ADAT XT lets you monitor the input signals through the converters at all times. Because of this, there is an extremely minimal delay as the digital audio passes through the converters' buffers. If you were to listen to both the original signal on your mixer and the tape return of the same signal coming back from the XT, the delay of the signal coming from the XT would cause some phase cancellation when combined with the original signal. Therefore, it is important that you either monitor the original signal or the tape's input signal on your mixer, but not both.

## POLARITY DIFFERENCES

The original ADAT was designed to invert its analog input signal internally before the audio was sent through the A/D (analog-to-digital) converter and recorded onto tape. The digital representation of the data (as stored on tape) was therefore inverted relative to the analog input (i.e., a positive voltage at the analog input is stored as a negative number on the tape). When this digital signal was played back from tape, the data was sent to a D/A (digital-to-analog) converter, and the analog signal output of the D/A was inverted once again before going to the output jacks. This resulted in the input to output phase being correct, and no phase problems were experienced when using a single ADAT or a multiple ADAT system.

However, neither the digital input nor the digital output was inverted. Therefore, if one transfers the ADAT's digital audio data to a DAT machine or hard disk recording system (using the AI-1 or a similar digital interface), the audio output from the other device would likely be out of phase with the ADAT, since it probably does not invert the analog signal after its D/A converters. Although this in and of itself will not usually be a problem, it may cause some confusion if multiple correlated audio signals are combined from multiple sources since there is a possibility that signals could become out of phase.

To prevent this from occurring, the XT design has been improved so that the polarity remains constant from the analog to digital, and back to analog, domain. Like the original ADAT, the result from one machine, or multiples of the same machine, is the same: The input to output phase is correct. However, if two cloned tapes (copied digitally either with ADATs, ADAT XTs, or both) are played back in sync on both an ADAT and an XT, the outputs of the two machines will be out of phase relative to each other. Since it does not usually serve any practical purpose to play the same signal from two different tapes with two different model machines simultaneously, this should not present a problem for you. This design improvement is only mentioned here to explain this possible situation should you happen to experience it.

*Possible problem:* Let's say you had been using a multiple ADAT system and you recorded a stereo signal across two machines (a stereo drum recording on tracks 8 and 9), where there is a common element to each track (i.e. center signal). If you replace one of these machines with an XT, the result would be that the track being played back on the XT will be out of phase from the track played on the ADAT, canceling the center signal.

*Here are some possible solutions:*

- Use a phase switch on your mixer (if your mixing board provides this) to invert the phase of the problem track to compensate.
- Wire your patchbay or ELCO cable to reverse the input and output polarity of the XTs in the system, but use standard cables on the ADATs in the system. This is recommended only for studios where master tapes will be exchanged between units or sent out of house.
- Digitally bounce one of the stereo tracks to the other ADAT so that both sides play back from the same machine.
- Most importantly, it is better to plan recording sessions so that stereo tracks reside on the same physical tape in a multiple ADAT system.

## CONNECTIONS

If you are replacing one or more of your ADATs with XTs and have been using the short, 8" sync cables, you will need to use 1 meter cables (or longer) to make the connection between ADATs and XTs. This is because the [SYNC IN] and [SYNC OUT] connectors have been moved on the XT rear panel to the opposite side, and the shorter cables will no longer reach.



## CHAPTER 6

# APPLICATIONS

### OVERVIEW

This chapter is designed to give you an idea of the multitude of applications for the XT. These applications are not broken down into great detail. Therefore, where applicable you will need to refer to other sections of this manual for instructions on how to setup the XT for a particular job.

### COMBINED MULTITRACK/MASTERING DECK

The XT can serve as a combination 6-track multitrack recorder and 2-track mastering deck. Record your audio onto tracks 1–6, then run them through a mixer, using the sub or group outs to send them back to tracks 7 and 8. Tracks 7 and 8 will contain the stereo master recording; their outputs should then be connected back to the mixer's 2-track playback inputs.

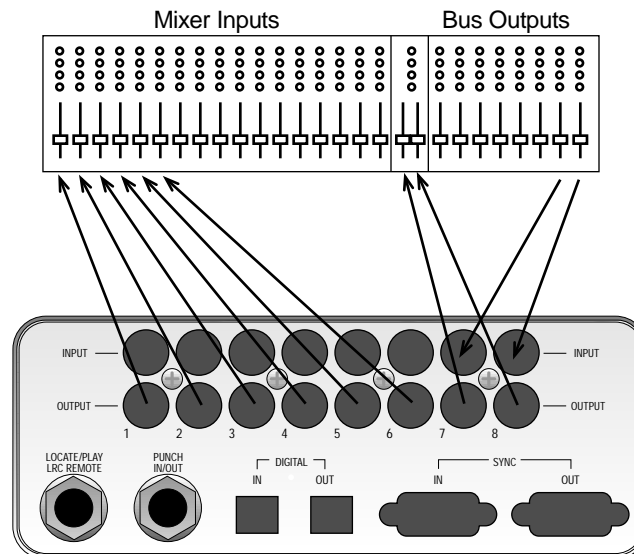

In addition, an external synchronizer connected to the XT's [SYNC OUT] can output SMPTE or MTC to simultaneously synchronize a MIDI sequencer to tape. This way, you can mix down not only the first 6 tracks from the XT but your "virtual" tracks on the sequencer as well, all onto tracks 7 and 8.

If you are using a multiple machine system (with one or more XTs and/or ADATs), you can dedicate any two tracks in the system for a stereo mix. Because all machines are perfectly synchronized to one another, you can punch-in and -out of the mix itself. This opens up all sorts of possibilities, like changing the EQ, effects and other mix settings for different sections of the mix.

## LIVE/LONG-TERM RECORDING

The XT is excellent for live recording because of its compact size and easy operation. Eight tracks allow for recording audience sounds, ambience, and individual soloists as well as a stereo mix of the PA. Of course, multiple machines may be interconnected and synchronized to allow for more tracks.

When using more than one XT, you can increase the recording time by manually placing the second machine into record just before the first machine is at the end of its tape. Naturally, the audio signals would need to be split and connected to both sets of inputs.

If you are using an Alesis BRC with a multiple ADAT system, you can take advantage of a feature called *continuous recording*. By splitting the system into two (or into two sets of machines), you can offset the second set by a specific amount of time.

*Example:* A 35 minute offset would provide 5 minutes of overlap. The second set of machines would automatically kick into record just before the first set's tape ran out. Refer to chapter 5 for more details on connecting multiple ADATs; refer to the BRC Reference Manual for more information about continuous recording.

Besides the typical 120 minute type of S-VHS tapes (which provide 40 minutes of digital audio recording time), 160 minute tapes are also available (which provide over 53 minutes recording time). And the new 3-hour (180 minute) tapes provide over an hour of digital recording time. The XT must be setup for the length of tape being used. This is done within the Main Function Menu.

### **To set the tape length:**

- i Hold the [SET LOCATE] button and press the [FORMAT] button;  
*This display will briefly read "St-60".*
- j Repeat step 1 to advance through the available tape length choices.  
*The display will briefly read: "St-120", "St-60", "St-160" and "St-180".*

Below is a list of the four S-VHS tapes which can be used with ADAT, with their European equivalents and approximate recording times:

Type	Euro	Rec. Time
ST-60	n/a	22 min.
ST-120	SE-180	40 min.
ST-160	SE-240	54 min.
ST-180	SE-260	62 min.

*Note:* European tapes are actually slightly longer than their US equivalents. Therefore, you may get a few more minutes if using European tape.

Refer to page 52 for more information about tape length.



## LOCKING TO VIDEO: CODE ONLY MASTER

A common application in the audio post-production environment is locking to video using the timecode on the video tape as a locate reference and the video signal itself as a clock source. This requires a synchronizer interface, such as the Alesis AI-2 or BRC. The connections consist of running a balanced 1/4" TRS cable between the AI-2's [SMPTE IN] connector and the VTR's SMPTE OUT (if timecode is recorded onto either the left or right audio track of the tape, connect the cable to the proper channel's output connector) and a BNC connector from the house sync being provided to the VTR (such as a black-burst generator), or the VTR's video out to the AI-2 [VIDEO IN]. The AI-2's [SYNC OUT] to the XT's [SYNC IN] connector.

When the XT detects an on-line AI-2, it will ID itself as a slave (ID 1) and the Clock will automatically switch to External (the EXT icon will light in the CLOCK icon group). Refer to your AI-2 Reference Manual for more information.

## COMPUTER CONTROL

### MIDI SYSTEMS: VIRTUAL TRACKING

Lately, many sequencing software manufacturers have been integrating digital audio hard disk recording and playback into their sequencers. However, the XT can offer much of the same flexibility without the added expense of a new program (or upgrade) or the hardware that accompanies a hard disk recording system. This requires a timecode interface, such as Steinberg's ACI or JCooper's DataSync 2, which will convert the XT's timecode (which is recorded when a tape is formatted) into MIDI Timecode (MTC) which a sequencer can synchronize to.

Connect the [SYNC OUT] from the XT (or from the last slave in a multiple ADAT system) to the [SYNC IN] of the timecode interface you are using. Connect the timecode interface's [MIDI OUT] to the [MIDI IN] of your sequencer. Set your sequencer to synchronize to the MTC being received from the timecode interface. As you control the XT's tape motion with the transport controls, the sequencer will automatically follow along, letting you mix digital recordings with virtual MIDI tracks on a MIDI sequencer.

### MIDI MACHINE CONTROL: VIRTUAL REMOTE CONTROL

Many of the computer-based sequencing software programs today have implemented MIDI Machine Control (MMC) into their sequencers. MMC is a specification implemented by the MIDI Manufacturers Association (MMA) and the Japan MIDI Standards Committee (JMISC) which details a set of messages that provide a universal way of having sequencers and tape machines speak to one another (not to mention tape machines talking to each other). These messages include: basic transport functions (like Play, Stop and Record), Locate functions (go to a specific tape location), Track functions (record-enable, input monitor, track delay), and many other types of messages. However, not all sequencers send out all these messages; some even send only basic transport commands. The total amount of control you have over your XT depends entirely on how much of the MMC specification has been implemented in the software you use.

First, make sure your sequencer is receiving MTC from the XT (see previous section). In addition, connect the [MIDI OUT] from your computer's MIDI interface to the [MIDI IN] of the timecode interface; then connect the [SYNC OUT] of the timecode interface to the [SYNC IN] of the XT (of the master in a multiple ADAT system). Refer to the manuals for the timecode interface and your computer-based sequencer for instructions on how to set them up for MMC applications.

If your sequencer generates MMC commands, you should be able to put your sequencer into play and have the XT follow along. However, don't be surprised if the XT does not immediately go into play. When a PLAY command is sent from the sequencer, the XT is issued a locate command, telling it where the sequencer is positioned (in timecode). The XT may first have to fast forward or rewind to get to the same location as the sequencer. Once this is done, the XT should resume playback which is when timecode is sent to the timecode interface, which converts it into MTC, which causes the sequencer to go into play. In essence, the sequencer is always locking to the XT's timecode, while the transport commands you issue from the sequencer act as remote functions.

## LIBRARIES AND ARCHIVES

The XT is superb for archiving purposes, such as speeches and broadcasts, stereo mixes or libraries of stereo samples. The XT can record over eight hours of mono material by recording approx. 60 minutes on each track (using ST-180 tape). Over four hours of stereo mixes or samples can be recorded by mixing down to four sets of stereo pairs (1/2, 3/4, 5/6, and 7/8).

## MODULAR RECORDING

Collaborations work particularly well with a system of two or more XTs (and/or ADATs). You can record your tracks onto the master machine, then do a premix onto two tracks of a slave machine, which is of course perfectly synchronized to the master. Send this tape to your partner, who adds parts on the other tracks. When the tape comes back, just pop it into one of your machines, and your partner's parts will be in sync with the original tracks you laid down.

You may wish to include documentation with your tape which indicates the Track Delays values, Tape Offset amount and/or Locate Point positions, so your partner can recreate the same parameter settings you were using. Or, if you're both using BRC remotes, save your setup to the "data" section of tape (this is called saving the Table of Contents, or TOC). This way, your partner can pick up right where you left off.

## USING TRACK COPY AS A DIGITAL ROUTER

In a multiple ADAT system which combines one or more XTs and one or more original ADATs, you can use the XT's Track Copy function as a way to reroute its digital output to different tracks on the ADATs.

Let's say you have one XT which is the master, and one ADAT which is the slave. When you normally record the digital output of the XT to the ADAT, the tracks are transferred on a one-to-one basis. In other words, track 1 of the XT is recorded onto track 1 (9) of the ADAT, track 2 goes to track 2 (10), and so on. By using the Track Copy function on the XT, any track on the XT can be sent on a different channel. For example, you could have track 1 transmitted as channel 8, which means you can record it onto track 8 (16) of the ADAT.

In the following steps, we will illustrate how to accomplish the above example:

- ¿ On the XT, press and hold [TRACK COPY].
- ¡ Press RECORD ENABLE [1] to select track #1 as the source track.
- ↪ Release the [TRACK COPY] button.
- ÷ Press RECORD ENABLE [8] to record enable track #8 on the XT.
- f Press [DIGITAL IN] on the ADAT and press RECORD ENABLE [8] to record enable track #8 (16) on the ADAT.
- a Press [PLAY] on the XT.
- D Press [PLAY] and [RECORD] on the slave ADAT.

## CALCULATING TAPE OFFSET USING THE LOCATES

The Alesis BRC provides a way of setting tape offsets using any of the 20 Locate memories in a song. This means you can set a Locate at one point, another Locate at another position, then have one of the slave ADATs offset by the amount of time between those two Locate positions.

The XT allows you to set a Tape Offset by entering a time reference. For example, if you were to set a Tape Offset of 5 minutes (0:05:00.00) and the rest of the ADATs were at 0:03:23.15, the XT would be at 0:08:23.15.

But let's say you don't know the time difference (i.e. the offset amount) between two sections of music. For example, let's say you wanted to bounce the vocals from the chorus 1 section of a song on an XT to a slave ADAT, then bounce them back to the XT while it was offset to the second chorus. To do this, the XT needs the exact offset time between these two positions in the song. So how many minutes, seconds and hundredths-of-a-second away is chorus 2 from chorus 1? Here's a way to find out by using the Locate Points.

- ¿ Play the tape(s) back from just before chorus #1.
- ¡ Press and hold [SET LOCATE].
- ↪ When you get to the downbeat of chorus #1, press [LOCATE 0].  
*This sets the TIME counter to 0:00:00.00, and automatically selects Relative Time mode (the REL icon will light to the left of the TIME counter).*
- ÷ While still holding [SET LOCATE], press [LOCATE 5] when you get to the downbeat of chorus #2.
- f Press [STOP].

- a Press [EDIT VALUE], then press [LOCATE 5].  
*Edit Mode will now be selected. The TIME counter will display a time for Locate 5 (like 0:00:47.30). Write this number down or memorize it.*
- D Press [TAPE OFFSET] (while still in Edit Mode) and enter the value that was displayed for Locate 5 (0:00:47.30).  
*To do this, press and hold the [EDIT VALUE] button and press [LOCATE 4], [LOCATE 7], [LOCATE 3] then [LOCATE 0]; then release [EDIT VALUE].*
- « Press [EDIT VALUE] to exit Edit Mode.
- » Press [TAPE OFFSET] to turn the Tape Offset function on.

## APPENDIX A

# DIGITAL RECORDING CONCEPTS

## ANALOG RECORDING BASICS

Digital recording works very differently from analog recording. With analog recording, tape containing millions of tiny magnetizable particles move past a record head. The magnetic field around this head fluctuates according to the audio signal present at the tape recorder's input. These fluctuations permanently rearrange the particles on the tape to form a pattern that is analogous to the original audio signal.

On playback, the patterns on tape are read by a separate playback head (or from the record head, set up to read instead of record signals) that converts the magnetic fluctuations back into an audio signal.

The biggest problem with analog recording is that the tape itself alters the sound originally recorded on tape. Tape hiss is one problem; it superimposes a low-level rushing noise onto the audio signal. Although there are ways to minimize noise, such as noise reduction circuitry, this colors the sound in the process of masking the noise. Tape's frequency response is also an issue. Tape has a hard time "absorbing" higher frequencies, which can dullen the sound. Moving tape faster allows the heads to magnetize more particles and extends the high frequency response, but the tradeoff is increased tape costs, and heftier transports to move bigger reels of tape.

## DIGITAL RECORDING BASICS

With digital recording, the technology is very similar — tape moves past a record head, and plays back through a playback head. However, the signal recorded on tape is very different.

Audio signals entering each channel of the XT first pass through an analog-to-digital (A/D) converter, a device that takes 48,000 samples or "snapshots" of the signal level every second<sup>1</sup>. Each sample is assigned a specific numeric value that corresponds to its level.

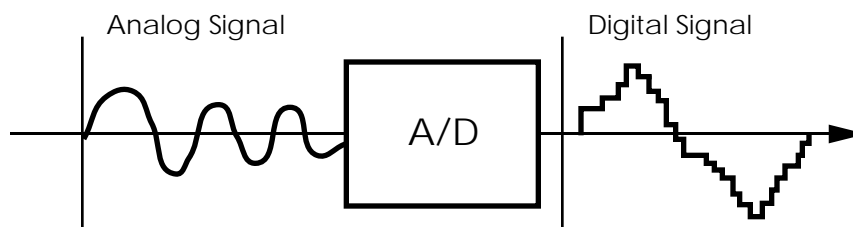

These numbers, which represent coded audio, are then converted into an audio signal that can be recorded on tape. Fortunately, recording a number on tape doesn't degrade the signal.

During playback, a digital-to-analog (D/A) converter reads the numbers from tape and outputs a corresponding level. This creates a "stairstep" reconstruction of the original signal, which is close to (but not exactly) the same as the original signal. To complete the process, this stairstep signal is smoothed by a low pass filter. The result is natural-sounding audio that sounds virtually unchanged from what was originally recorded.

<sup>1</sup>48,000 samples are taken per second at a sampling rate of 48 kHz; 44,100 samples are taken per second at a sampling rate of 44.1 kHz.

Digital audio requires lots of numbers to represent an analog version of the same sound. Analog signals may require at least 20kHz frequency response to reproduce audio faithfully. Digital signals for the same 20 kHz audio requires a frequency response of several million Hertz. Due to the way individual numbers are transmitted, digital audio requires a wide bandwidth recording medium<sup>2</sup>.

## WHY S-VHS?

S-VHS recording technology offers more than enough bandwidth to record eight tracks of digital audio. S-VHS tapes are built to higher standards than standard VHS tapes, and can take the tape shuttling required by professional audio applications. S-VHS tape cassettes are also inexpensive compared to reel-to-reel tape, readily available, compact, and easy to transport and store.

<sup>2</sup>.Bandwidth is a measure of the lowest to highest frequency a signal path can handle.

## APPENDIX B

# TROUBLESHOOTING

## TROUBLE-SHOOTING INDEX

If you are experience problems while operating the XT, please use the following table to locate possible causes and solutions before contacting Alesis customer service for assistance.

Symptom	Cause	Solution
The display does not light when the [POWER] switch is turned on.	No power.	Check that the power cable is plugged in properly.
FORMAT icon flashes.	Tape is not formatted.	Format the tape, or reinsert.
The record-enabled tracks' meters do not indicate input levels.	Cables are not connected properly or are shorted.	Check your audio cables.
	DIGITAL INPUT is selected.	Press [ANALOG INPUT].
Can't change the sample rate/clock source.	If slave in a multiple ADAT system, EXT clock is selected automatically.	Set the sample rate/clock source on the master XT.
Pressing [AUTO REC] displays "invALid".	Locate Point 3's position is before Locate Point 2.	Set Locate Point 3 past Locate Point 2.
AUTO RETURN icon flashes.	Locate Point 4's position is before Locate Point 1.	Set Locate Point 4 past Locate Point 1.
When used as a slave in a multiple ADAT system, doesn't follow the master.	No ADAT master is detected.	Check sync cables. Power down the Master only, then restart.
TIME counter does not show tape position.	Edit mode is turned on.	Press [EDIT VALUE] to turn Edit mode off.
Interpolation indicator (☼) lights/flashes.	One or more errors have been detected/corrected	Clean the tape heads. Make a backup copy of your tape.
48K or 44.1K icon flashes.	Tape was formatted at different sample rate than currently selected.	If desired, press [CLOCK SELECT] to use original sample rate.
Error Message in display	Several possible	See Appendix C: Error Codes

## RE-INITIALIZING

If your unit behaves erratically or "freezes", the first step is to power down the unit and power it back up again. If this steps do not solve the problem, you must re-initialize the software.

To re-initialize the XT, hold down both [RECORD] and [PLAY] while turning on the [POWER] switch. This will reset all parameters to their default settings

## CHECKING SOFTWARE VERSION

The current software version may be determined by holding [SET LOCATE] and pressing [FAST FWD]. The XT will momentarily indicate the current operating software version installed in the TIME counter.

## ERROR RATE DISPLAY

The TIME counter has a secondary mode which, when selected, will display only the minutes and seconds of the tape position, and the *error rate* while the transport is engaged in play or record. This error rate is viewed as a count of the number of sync block errors per 14 drum revolutions (every 280ms). Since there are 30 sync blocks per sector, 8 sectors per track, and two tracks per revolution, the maximum number is 6720. If this display mode is selected during any other mode than play or record, the number will always read "0000".

### **To view the error rate display:**

- 1 Hold [SET LOCATE] and press RECORD ENABLE [3].  
*The TIME counter will briefly read:*

ABS    d1   SP   E rr

*When PLAY or RECORD are engaged, the TIME counter will change to show minutes and seconds on the left, and a 4-digit error rate counter on the rate.*

- 2 Repeat step 1 to return the TIME display to its normal state.  
*The TIME counter will briefly read:*

ABS    d1   SP   r E9

*...and will then change back to show hours, minutes, seconds and 100ths-of-a-second.*

## ABOUT ERROR RATE READINGS

A new, perfect tape on a clean machine will normally read "0000" with occasional flashes up to "0005" or "0010". Errors of 3 or below are 100% correctable, and the odds are that significantly higher readings will also be 100% correctable. Many new tapes out of the box from some manufacturers have readings up to 100. Readings above 1000, however, are guaranteed to cause some interpolation to take place.

Therefore, readings up to about 10-15 aren't anything to worry about unless accompanied by the Interpolation indicator; but they do show you that there is something less than ideal about current conditions. If readings rise above 20, you should take action (see page 75). If your brand of tape has a typical error rate above 20, that's acceptable, but you want to look out for increases above the usual.

## ADAT HEAD LIFE

The expected head life for each ADAT varies according to a number of factors. Given optimum conditions, tape quality, tape care, and operating environment head life for the average ADAT will always be better than if your ADAT is abused, placed in bad environmental conditions and used with badly maintained tapes. Properly cared for, your heads should last for thousands of hours.

You should not subject your ADAT to environmental extremes, humidity or moisture of any kind, dust, dirt, extreme temperatures, extreme temperature fluctuations or any kind of physical abuse (drops, shocks).

Under no circumstances should you remove the top or bottom cover of the ADAT. You already know that there are NO user serviceable parts inside. However, you



should also be aware that it is extremely easy to damage your heads and other sensitive parts of your ADAT. Do not open up your ADAT to clean the heads. What it comes to is this: ADAT is a very sophisticated piece of digital technology. It is going to be used for your important projects so take the best care of your ADAT and your ADAT heads possible.

## ADAT HEAD MAINTENANCE

The heads of each ADAT are pre-aligned at Alesis. No user adjustment is necessary. Over the course of time, depending on the quality of the tapes used and the environmental conditions where the ADAT and its tapes are stored, head cleaning may become necessary. Unlike analog or even video tape recorders, the actual sound quality of an ADAT recording will not be affected until there is quite a bit of dirt on the drum and heads. When the Interpolation Indicator (the sunburst at the end of the location display) starts appearing frequently, even on brand new tapes, we recommend that you bring your ADAT to an authorized Alesis Service Center for cleaning. If the indicator is not appearing and the unit is performing normally, there is no reason to clean the heads. Periodic or preventative maintenance should not be over done to prevent premature wear on the headstack.

If head cleaning is necessary and you are unable to bring your ADAT to a service center, you may try using a DRY VHS head cleaning cassette. We recommend 3M VSHHC Black Watch Head Cleaner Video Cassette or 3M ASD HC Digital Audio Head Cleaning Cassette.

- Do NOT use any other type of head cleaning cassette. They are abrasive and will damage or wear out your heads.
- Do NOT use head cleaning cassettes that require any kind of liquid.
- Do not use the Black Watch cassette any more often than necessary. Over-cleaning the heads wears them down, reducing their life span.
- Do NOT attempt to clean the heads yourself unless you are a skilled technician experienced in the maintenance of video cassette recorders. Information for such technicians is available from Alesis Product Support. ADAT head cleaning requires different materials and procedures from analog head cleaning, similar to VCR maintenance. **Cleaning the heads with a cotton swab, or rubbing in the wrong direction, will destroy them. Opening the case of your ADAT will void the warranty.**

Maintenance of the ADAT should be based on the Interpolation Indicator (or Error Count Display, see p. 74) or if the unit begins to behave erratically. To determine if these symptoms are caused by dirty heads, (not a defective or worn tape), keep a "benchmark" tape from the first weeks of operation set aside in a safe place (see page 40). If the Interpolation Indicator lights frequently when playing back this tape, it is likely that head cleaning is needed, particularly if several hundred drum-on hours have elapsed since the last cleaning (see page 74).

Call Alesis Product Support for more information about head cleaning and authorized Alesis Service Centers.

## DRUM TIME DISPLAY

The XT keeps track of how long the head has been actively spinning against tape (i.e., threaded in stop, or play, or cue/review). This can help determine how long it has been since the last time it was serviced or cleaned.

### **To display the head time counter:**

- 1 Hold [SET LOCATE] and press [STOP]:  
*The number of drum hours will briefly appear in the TIME counter.*

## TAPE MAINTENANCE: SAFE TAPE

ADAT tapes are no different than any standard tape: they must be treated with care. Never expose ADAT tapes to temperature extremes, strong magnetic fields (such as speakers), high humidity, dust and so on.

You should always practice SAFE TAPE:

- At the end of every session you should rewind the tape all the way to the leader, stop, eject the tape, remove it from the ADAT and place it in its protective case. This cuts down on the amount of dust that can enter the transport and keeps wear on the tape at a minimum.
- Don't leave your tapes near speakers, power amps or other potential magnetic fields such as televisions or electrical devices.
- Don't subject your tapes to extreme temperatures or wild temperature fluctuations.
- Don't expose your tapes to high humidity, moisture or high dust levels.
- Don't leave your tapes on the dashboard of your car. (In fact, never leave ADAT tapes in a car EVER. Keep them with you at all times!)
- Certainly, no matter how tempted you are to open the shutter to see what is inside, NEVER TOUCH THE TAPE. The magnetic particles on your ADAT tape need to be preserved in the condition in which they were recorded. The oils from your fingers WILL damage your tapes as well as get on the heads and damage them.
- Never turn off the ADAT power while the tape is threaded. This leaves the tape bent around the rollers and head. Press [STOP] until the tape is unthreaded before turning off power.

Practice "safe tape" at all times because you can never retrieve lost data.

If you are archiving your tapes, make sure they are stored in environmentally stable conditions, i.e. a cool dry place. If you do archive your tapes, you need to check them once a year. Run each tape through your ADAT from end to end. This will prevent buildup that can occur when a tape is left simply "sitting".

Of course, for your super sensitive or important material, nothing beats making multiple digital backups. Every year or so, simply do another digital backup onto a brand new tape.

## MAINTENANCE/SERVICE

### CLEANING

Disconnect the AC cord, then use a damp cloth to clean the keyboard's metal and plastic surfaces. For heavy dirt, use a non-abrasive household cleaner such as

Formula 409 or Fantastik. DO NOT SPRAY THE CLEANER DIRECTLY ONTO THE FRONT OF THE UNIT AS IT MAY DESTROY THE LUBRICANTS USED IN THE SWITCHES AND CONTROLS! Spray onto a cloth, then use the cloth to clean the unit.

## MAINTENANCE

Here are some tips for preventive maintenance.

- Periodically check the AC cord for signs of fraying or damage.
- Unplug the XT when not in use for extended periods of time.
- Do not leave tapes inserted halfway into the XT when not in use, as this allows dust to enter the transport chamber. Always leave tapes either fully inserted, or remove them completely.

## REFER ALL SERVICING TO ALESIS

We believe that the XT is one of the most reliable digital recorders that can be made using current technology, and should provide years of trouble-free use. However, should problems occur, DO NOT attempt to service the unit yourself. The full AC line voltage, as well as high voltage/high current DC voltages, are present at several points within the chassis. Service on this product should be performed only by qualified technicians. THERE ARE NO USER-SERVICEABLE PARTS INSIDE.

## OBTAINING REPAIR SERVICE

Before contacting Alesis, check over all your connections, and make sure you've read the manual.

### **Customers in the USA:**

If the problem persists, call Alesis USA at 1-310-841-2272 and request the Product Support department. Talk the problem over with one of our technicians; if necessary, you will be given a repair order (RO) number and instructions on how to return the unit. All units must be shipped prepaid and COD shipments will not be accepted.

For prompt service, indicate the RO number on the shipping label. If you do not have the original packing, ship the XT in a sturdy carton, with shock-absorbing materials such as styrofoam pellets (the kind without CFCs, please) or "bubble-pack" surrounding the unit. Shipping damage caused by inadequate packing is not covered by the Alesis warranty.

Tape a note to the top of the unit describing the problem, include your name and a phone number where Alesis can contact you if necessary, as well as instructions on where you want the product returned. Alesis will pay for standard one-way shipping back to you on any repair covered under the terms of this warranty. Next day service is available for a surcharge.

Field repairs are not normally authorized during the warranty period, and repair attempts by unqualified personnel may invalidate the warranty.

Service address for customers in the USA:

Alesis Product Support  
3630 Holdrege Avenue  
Los Angeles, CA 90016

### **Customers outside the USA:**

Contact your local Alesis dealer for warranty assistance. The Alesis Limited Warranty applies only to products sold to users in the USA and Canada. Customers outside the USA and Canada are not covered by this Limited Warranty and may or may not be covered by independent distributor warranty in the county of sale. Do not return products to the factory unless you have been given specific instructions to do so.

## APPENDIX C

# ERROR CODES

The following errors codes may appear from time to time in the TIME counter display. Use this reference to learn the possible cause of the error code before attempting to contact Alesis Product Support.

- dv**                    **Dew Sensor:** The unit has been subjected to overly high humidity. Do not operate the unit. Turn on the power without installing a tape. This will allow the unit to warm up and disperse the moisture. If the “dv” message does not go out after 2 hours contact Alesis for service.
- noFo**                **No Format:** The tape is located at a point that has not been formatted. Rewind the tape to the beginning. Press play. If the tape is formatted the message will change to “LEAd” for 15 seconds then “dAtA” for 2 minutes prior to the beginning of the audio section. If these messages do not appear, the tape should be formatted.
- FULL**                **Serial Buffer Full:** Not seen very often. “FULL” occurs when a slave XT is slow to sync to the master XT. The serial buffer within the micro controller has become full of data. This could be the result of unlike versions of software within each unit. Sometimes the problem is related to the sync cable itself. It is recommended that only shielded and grounded cables be used as sync cables.
- Finally, this error may occur in slave machines that are playing damaged tapes. The edges of the tape have become damaged. If only one tape is found to cause this problem, don't use it. If the problem is seen with several tapes, the machine should be taken in for service. Contact Alesis for service.
- Er 0**                **Tape Load Error:** This may be a problem with the TAPE LOAD or (insert) switch. This can be caused by labels that have been applied to the cassette outside of the designated area. If this error message is displayed with only one tape, the cassette may be at fault. If the message is displayed with several tapes, with and without labels, you should contact Alesis for service.
- Er 1 – Er 4**        **Tape Threading:** These error codes are usually related to tape threading. Eject the tape and load it again. If this error message is displayed with only one tape, the cassette may be at fault. If the message is displayed with several tapes, with and without labels, you should contact Alesis for service.
- Er 5**                **Drum/Capstan:** This error points to the head drum and capstan servos. The problem is caused by anything creating extra resistance in the tape path, an unevenly wound cassette or a misaligned cassette shell. You should fast forward and rewind the cassette from end to end to flex the tape then try the tape again. If this error message is displayed with only one tape the cassette may be at fault. If the message is displayed with several tapes, with and without labels, you should contact Alesis for service.

Er 7	<b>Clean Heads:</b> If this error message is seen, it may indicate that the heads are in need of cleaning. See page 75 for information about cleaning your heads.
Er 8	<b>Sync Lost:</b> Error message 8 normally occurs when the tape reaches the end while formatting or recording. It is caused by the fact that the XT cannot read timing data from the leader. The error is caused by the unit losing sync. If the unit is being run in the slave mode check the sync cable connection. It is recommended that only shielded and grounded cables be used as sync cables.
Er 9	<b>Take-up Reel.</b> This error indicates that the take-up reel didn't move after PLAY or RECORD was engaged. This can spool tape out of the cassette, so the XT stops the tape immediately. It's possible that the take up reel of the tape is jammed; try a blank or unimportant tape to see if the error recurs. The idler wheel that turns the take-up reel may need cleaning or replacement.
no 9ood tc	<b>No Time Code.</b> The XT is reading control track pulses, but no helical scan time code. Usually, a video tape has been inserted into the XT. Format the tape in the ADAT format.  (Error 10 through 13 and 16 are not used)
Error 14-15	<b>Crossfade buffer, state or channel error.</b> This indicates a problem with the RAM buffer used for crossfading. Reinitialize the XT using the procedure on p. 75. If the problem recurs, the unit must be serviced.
Error 17	<b>End sensor error.</b> One of the optical sensors used to detect the clear leader at the head and tail of the tape cartridge is not working or is blocked temporarily. If the error recurs on other tapes, the unit needs to be serviced.
CAL PG	This error message may appear when you turn on power to the XT. If the display also reads "CAL brAC", there may be something wrong with the battery backup of RAM, or the RAM was accidentally scrambled. If no other error messages occur during operation, and the Interpolation Indicator (see p. 34) is not flashing, playback and recording are still possible. However, do not format any blank tapes on the XT until the PG is reset .
CAL brAc	If this message appears during the turn-on cycle, the brake settings have been set to the default settings due to a problem with RAM memory or the backup battery. Perform the automatic brake calibration (see below). If this message appears in the midst of normal operation more than once in every ten hours of operation, perform the automatic brake calibration (see "Automatic Brake Calibration Procedure", below).

### Automatic Brake Calibration Procedure

If the "CAL brAc" error message appears, the internal braking system of the XT may need to be adjusted. The intelligent transport software is capable of calibrating the XT's brakes automatically in a self-test procedure. This procedure may be performed as a regular maintenance procedure every 250 hours of head drum operation (to see the hours on your unit, hold SET LOCATE and press FAST FORWARD).

1. Obtain a standard ST-126 length tape (preferably an Ampex 489 such as that was shipped with your unit) that has already been completely formatted from beginning to end. Use a non-essential tape (i.e., don't insert your only copy of a master tape). Do not use other lengths of tape such as ST-180 or ST-60.

2. Turn off the POWER switch. Hold REWIND and FAST FORWARD while turning the power back on again. The display will read "CALibrAt".
3. Insert the tape into the transport.
4. At this time the unit will adjust the brake tension automatically. The transport will shuttle back and forth for about 5 minutes. During the operation, the tape will half-eject twice. This is normal.
5. The display should briefly read "PaSS" before ejecting the tape fully and returning to the "ADAT-XT" start-up screen. The brakes have now been recalibrated.

If the "CAL brAc" message appears again shortly after a brake calibration has been performed, there may be something wrong with the tape being used. Check operation with another tape. If the message persists, the unit must be professionally serviced.

**Note:** If these errors occur only with a certain tape, or display once in a while, it's probably not cause for concern. Errors 1 through 3 and 9 can indicate conditions that may damage a tape; the other errors won't damage the tape or the machine. Backup the data from that tape to another machine, if possible, and continue working from the backup copy.

## STEPS TO TAKE BEFORE CALLING FOR HELP

If an error message is displayed or if an ADAT starts behaving strangely, then please follow the suggested steps below:

- 1 Stop the tape playing (or recording). Does the error go away?
- 2 Rewind the tape a minute or two. Press [PLAY]. Does the error recur?
- 3 Eject the tape. Place it back in the XT and press [PLAY]. Does the error recur?
- 4 Turn down the volume of any mixer or amplifier you have connected to the outputs of the XT. Turn the power of the XT off, wait a minute and then re-power the XT. Repeat steps 1 to 3. Does the error come back?
- 5 If it does, then try a different tape. Repeat steps 1 to 3. Does the problem recur?
- 6 Try the tape in a different XT or ADAT. (If you are using a single ADAT system, see if you can visit your dealer.) It does not make sense to send your XT in for service when there may be only a problem with, for example, some tapes that you are using. If the same problems occur in another XT or ADAT, then either the tape is faulty or it was formatted on an out of alignment XT or ADAT. At this point, you should call Alesis Product Support. If the problem does not occur, and the tape works fine, then we need to look at your XT. You need to call Alesis Product Support.

Whatever happens, the answers to all these questions are useful information for our Product Support representatives. The more we know, the faster we can discover the cause of your problems. You will help us isolate whether the problem lies in the XT, the tape or somewhere else.

### APPENDIX D

# SPECIFICATIONS

## Transport

Recording Format:	ADAT Rotary head digital recording
Tape Format:	S-VHS cartridge

Heads:	4 (2 Read, 2 Write); Read before Write
Approximate Recording Times:	
ST-60:	22 minutes
ST-120/SE-180:	40 minutes
ST-160/SE-240:	54 minutes
ST-180/SE-260:	62 minutes
Fast Wind Rate:	40 x play speed (Threaded)

## Audio

Number of Audio Channels:	Eight
Audio Conversion:	
Record (A/D):	18 bit linear audio, 128 times oversampling, single converter per chan.
Playback (D/A):	20 bit linear, 8 times oversampling, single converter per chan.
Sample Rate:	44.1 /48kHz, Selectable
Vari Speed Range:	+100/-300 cents (48kHz), $\pm 200$ cents (44.1kHz)
Frequency Response:	20Hz– 20 kHz, $\pm 0.5$ dB
Dynamic Range:	92 dB, A weighted
Distortion:	.009% THD
Channel Crosstalk:	Better than -90 dB @ 1kHz
Wow and Flutter:	Unmeasurable
Reference Level:	-15dB

## Analog Inputs/Outputs

Connectors:	
Balanced:	One ELCO <sup>®</sup> connector (in/out)
Unbalanced:	Sixteen RCA jacks (8 input, 8 output)
Input Impedance:	
Balanced:	10kW
Unbalanced:	10kW
Output Impedance:	
Balanced:	150W into 600W Nominal
Unbalanced:	150W into 10k W Nominal
Nominal Input levels:	
Balanced:	+4 dBu (1.23V)
Unbalanced:	-10 dBV (3.17V)
Maximum Input levels:	
Balanced:	+19 dBu (6.90V)
Unbalanced:	+5 dBV (1.78V)



**Digital Inputs/Outputs**

Connectors:	Two EIAJ fiber optical jacks (1 in, 1 out)
Communications Protocol:	8-Channel Serial Communication

**General**

Power Requirements:	90V–250V AC, 50/60 Hz
Power Consumption:	80W
Operating Temperature:	10–40 °C for specified performance
Operating Humidity:	80% maximum with no dew condensation for specified performance
Dimensions (H x W x D):	5.25" x 19" x 11" (133.3 x 482 x 279.5mm)
Weight:	20 lbs. (9 kg)

**CAUTION:** Danger of explosion if battery is incorrectly replaced. Replace only with the same or equivalent type.

**AVERTISSEMENT:** Risque d'explosion si cette pile est mal utilisée tel que introduite faussement dans l'appareil ou remplacé par une pile non-equivalent.

# GLOSSARY

## A

### *A/D or Analog-to-Digital Converter*

The device that converts an analog audio signal to digital audio. Once encoded, all audio is stored or processed as a series of numbers rather than as the audio itself.

### *AES/EBU Interface*

A two-channel, digital audio hardware/software standard. The AES/EBU interface allows for data communication between professionally-oriented digital devices (such as digital signal processors, hard disk recording systems, synthesizers with AES/EBU outputs, digital audio workstations, etc.).

### *Autolocation*

The process of automatically rewinding or fast forwarding, as necessary, to find a specific point on tape. Autolocation is usually initiated by pressing a button that tells the machine the point to which you want it to autolocate.

### *Automation*

Generally, automation means using a machine or computer to perform or repeat one or more tasks. In recording systems, automation refers to the process of recording and playing back mixer movements such as faders and mute buttons. In many sophisticated systems, all controls can be automated.

### *Auto Loop*

A combination of two functions, *Auto Return* and *Auto Play*, which allows a specific section of tape to be played over and over again; particularly useful for *looped recording* when used along with the *Auto Record* function.

### *Auto Play*

A function whereby playback is automatically engaged upon completing a locate.

### *Auto Record*

A function whereby recording is carried out automatically. The point where recording begins is determined by the Mark In point. The point where recording ends is determined by the Mark Out point.

### *Auto Return*

A function whereby the transport automatically begins to rewind once reaching a certain point, and returns to an earlier point. The point at which rewinding begins is called the Auto Return End point. The point that is returned to is called the Auto Return Start point.

## B

### *Balanced Audio Signals*

Signals that are carried on three-conductor cables, with two of the conductors carrying the same signal 180° out of phase and third as ground. Balanced connections usually cost more than unbalanced connections, but are less susceptible to picking up hum and interference with low-level signals.

### *Bounce*

Bouncing means taking audio from one track and placing it on another. The term, sometimes called "bouncing down," also describes the process of mixing several tracks onto one or two.

### *Bus*

A bus generally refers to any common signal pathway. In a mixer, a bus is usually a wire that is or can be made common to the outputs of any or all channels in the mixer. Examples of buses include the main stereo mix, sub-mixes, monitor buses and aux sends.

## C

### *Channel*

In audio, a channel is an internal audio path maintained separately from other audio paths of identical function. Mixer input strips are examples of channels, but an audio snake also has channels.

### *Chase/Lock*

Chase/Lock refers to a tape machine's ability to read incoming timecode, locate its tape to the position indicated by the timecode, and synchronize playback to the incoming timecode.

### *Clip*

In the analog world, clipping occurs when the input to a circuit exceeds the gain of the circuit. The circuit passes the signal at its maximum value. All input values exceeding the maximum value are "clipped." The result is audio distortion. In digital audio, clipping occurs when the input to an A/D exceeds the voltage represented by the maximum number the A/D is capable of transmitting.

### *Crossfade*

A crossfade is a gradual "dissolve" between two portions of audio; one segment of audio fades out while the other fades in. When punching in on the XT, the audio on tape is faded out while the new audio which is being recorded is faded in.

## D

### *DAT*

Digital Audio Tape. This term has come to mean specific digital audio tape recorders that use cartridges smaller than those of a standard cassette, and which record two tracks of digital audio (and sometimes timecode).

### *Digital I/O*

Input and output connections where signals passed from one stage to another remain in the digital domain. The XT has digital I/O connectors that carry digital data for all eight tracks.

### *D/A or Digital-to-Analog Converter*

The device that converts digital signals back into an analog format so that they can be heard.

E  
F

*Fiber Optical Connector*

A device that transmits signals through light instead of conventional wire. Advantages include higher speed and the ability to carry multiple channels of information over a single, thin cable.

G  
H

*House Sync*

A video signal distributed to any device that requires a reference to maintain proper sync relationship with other devices. The signal comes in several forms: Blackburst results in a black video screen when fed to a video monitor; Color bars are the standard reference for adjusting video equipment. Color bars can be seen on many stations just before they come on the air.

I

*Input*

An input is a path through which audio passes from one electronic device into another. types of inputs vary in connector type, level, use (send, monitor, mix), and electrical characteristics (impedance, balanced or unbalanced). They can be analog or digital.

J  
K  
L  
M

*MIDI*

Musical Instrument Digital Interface (MIDI). A protocol whereby various MIDI-compatible products can communicate various musical and non-musical messages (such as notes, controls, etc.).

*MMC*

MIDI Machine Control (MMC). A subset of MIDI messages which correspond to tape machine's transport controls and other functions.

*Mute*

Used as a verb, to "mute a channel" means to turn off the audio for that channel. Used as a noun, "mutes" are the buttons which turn off a particular channel. Mutes are usually non-destructive, though not always. Mutes are often automated as part of mixer automation systems.

N  
O***Output***

A path through which audio passes from one device to another. Types of outputs vary in connector type, level, use (send, monitor, mix), and electrical characteristics (impedance, balanced or unbalanced). They can be analog or digital.

***Oversampling***

The process of taking more samples than is required in order to more accurately reconstruct a digitized signal back into analog audio.

## P

***Post-production***

Begins after the film or video location shoot and is the process of combining, editing and processing audio elements into a final product to be married with the picture.

***Punching***

The process of entering and/or exiting the record function while the tape is playing. This allows recording over specific pieces of tape, such as recording over a section with bad notes, as opposed to recording over the entire length of the track.

Q  
R***Record-Ready***

A track mode, often called "armed." When you want to record on a track, you "ready" or "arm" the track. When you push the record button, all tracks that are ready or armed will go into record mode.

***Rotary Head***

A type of tape head, as used in the XT, that spins at a high rate of speed in order to create the same effect as having the tape moving by at rates not physically possible with today's tapes and transports.

## S

***Safe***

A track mode. When a track is safe, it is *not* ready for recording.

***Sample Rate***

A digital representation of an analog signal created by checking, or sampling, the analog voltage a fixed number of times per second. The greater the number of samples, the more accurate the representation of the analog signal. The CD uses a sampling rate of 44.1 kHz; it checks the analog signal 44,100 times per second.

***Sample Rate Conversion***

Sample rate conversion is the process by which audio originally recorded at one sample rate is converted to another sample rate. The audio is converted by shifting its pitch up or down, and then played back at the new sample rate.

***SMPTE/LTC***

Society of Motion Picture and Television Engineers (SMPTE and Longitudinal Time Code (LTC). A standard for LTC was specified by the SMPTE, and has been adopted

by the motion picture and television industries. A complete description of LTC can be found in *The Time Code Handbook*, by Walter Hickman. SMPTE timecode is the standard sync reference for professional audio and video post-production.

### *S/PDIF Interface*

Similar to the AES/EBU interface, but created by Sony and Philips with consumer applications in mind. The optional AI-1 from Alesis offers both the consumer S/PDIF interface and professional AES/EBU format for use with the XT.

### *S-VHS*

Acronym for Super Video Home System, an improved version of VHS with greater resolution and dubbing capabilities, as well as improved sound.

## T

### *Track*

An area of tape on which audio is recorded. A track can be thought of as a picture of an output over time.

## U

### *Unbalanced Audio Signals*

Signals that are carried on two-conductor cables, one "hot" and one ground. Unbalanced connections save costs, but are more prone to picking up hum and interference with low-level signals.

## V

### *VHS*

Acronym for Video Home System, a video recording system introduced for consumer use and using standardized cartridges.

### *VITC*

Vertical Interval Time Code (VITC) is timecode information encoded in the vertical retrace interval of the video signal (this is the time when the beam is getting back to the top of the screen). The advantage of VITC is that the timecode value can be read when the video deck is paused, and is accurate to the frame.

## W

## X

## Y

## Z

# INDEX

- ABS/REL Button 15, 35
- Absolute Time 35, 48
- ADAT 55, 59, 63-65
- AI-1 61
- AI-2 69
- All Input 39
- Analog Recording 71
- Auto Input 39
- Auto Play 19, 50
- Auto Record 20, 50-51
- Auto Return 19, 50
- Autolocation 48
- Backup 60
- Bandwidth 72
- BRC 52, 68
- Chase 34
- Clock 44, 61, 69
- Copying Tapes 60
- Crossfade Time 45
- Cue 42
- Data 30
- Digital Clock 61
- Digital Input 59
- Digital Recording 41, 71
- Display 32
  - Icons 33
- Drum Time 75
- Edit Value 36
- Eject 42
- Error Codes 79
- Error Rate 74
- Fast Forward 42
- Footswitches 28, 53
- Formatting 14, 29-31
  - Complete 30
  - Extend 31
  - Recording while 30
- Head Cleaning 74-76
- ID 34, 56
- Inputs
  - Balanced 24
  - Digital 27
  - Monitor 39
  - Select 37-38
  - Unbalanced 23
- Lead 30
- Locate 48
- Locate Reference 69
- Locked 34, 57
- Loop 19
- LRC Remote 28
- Meters 40
- MIDI 69
- Multiple ADAT System
  - Formatting 56
    - Master 55
    - Slave 55
  - Optical 27
  - Outputs
    - Balanced 24
    - Digital 27
    - Unbalanced 23
  - Peak Clear 40
  - Peak Mode 40
  - Phase 64
  - Pitch 21, 45-46
  - Play 17, 43
  - Power 7, 13
  - Punch In/Out 43, 44
  - Record 43
  - Re-initializing 74
  - Record Crossfade Time 45
  - RECORD ENABLE Buttons 15, 41
  - Recording 16
    - Analog 37, 71
    - Bouncing 38, 59
    - Digital 37, 41, 71
    - Live 68
    - Track Copy 38
    - While formatting 30
  - Rehearse 51
  - Relative Time 35, 48
  - Review/Rewind 42
  - S-VHS 11, 68, 72
  - Sample Rate 44, 69
  - Set Locate 35
  - Signal Level 41
  - Software Version 75
  - Stop 44
  - Sync 26, 55
  - Tape Length 47, 68
  - Threaded 11, 42, 44
  - TIME Counter 13, 15
  - Track Copy 38
  - Track Delay 47
  - Transport 15, 42-44, 63
  - Unthreaded 11, 42, 44
  - Video 69
  - Write protect 29
    - s and t buttons 36





## Free Manuals Download Website

<http://myh66.com>

<http://usermanuals.us>

<http://www.somanuals.com>

<http://www.4manuals.cc>

<http://www.manual-lib.com>

<http://www.404manual.com>

<http://www.luxmanual.com>

<http://aubethermostatmanual.com>

Golf course search by state

<http://golfingnear.com>

Email search by domain

<http://emailbydomain.com>

Auto manuals search

<http://auto.somanuals.com>

TV manuals search

<http://tv.somanuals.com>