

FPM-3150G Series

**15" XGA TFT LCD Industrial
Monitor with VGA and DVI Inputs**

User Manual

Copyright Notice

This document is copyrighted by Advantech Co., Ltd. All rights are reserved. Advantech Co., Ltd. reserves the right to make improvements to the products described in this manual at any time.

Specifications are thus subject to change without notice.

No part of this manual may be reproduced, copied, translated, or transmitted in any form or by any means without the prior written permission of Advantech Co., Ltd. Information provided in this manual is intended to be accurate and reliable. However, Advantech Co., Ltd., assumes no responsibility for its use, nor for any infringements upon the rights of third parties which may result from its use.

All brand and product names mentioned herein are trademarks or registered trademarks of their respective holders.

This Manual Covers the Following Models

- FPM-3150G-XCE
- FPM-3150G-RCE

Part Number: 2003315010

Edition 2 September 2007

Product Warranty (2 years)

Advantech warrants to you, the original purchaser, that each of its products will be free from defects in materials and workmanship for two years from the date of purchase.

This warranty does not apply to any products which have been repaired or altered by persons other than repair personnel authorized by Advantech, or which have been subject to misuse, abuse, accident or improper installation. Advantech assumes no liability under the terms of this warranty as a consequence of such events.

All defective products under normal / standard operation will be serviced by Advantech's global RMA system. If an Advantech product is defective, it will be repaired or replaced at no charge during the warranty period. For out-of-warranty repairs, you will be billed according to the cost of replacement materials, service time and freight. Please consult your dealer for more details.

If you think you have a defective product, follow these steps:

1. Collect all the information about the problem encountered. (For example, CPU speed, Advantech products used, other hardware and software used, etc.) Note anything abnormal and list any onscreen messages you get when the problem occurs.
2. Call your dealer and describe the problem. Please have your manual, product, and any helpful information readily available.
3. If your product is diagnosed as defective, obtain an RMA (return merchandise authorization) number from your dealer. This allows us to process your return more quickly.
4. Carefully pack the defective product, a fully-completed Repair and Replacement Order Card and a photocopy proof of purchase date (such as your sales receipt) in a shippable container. A product returned without proof of the purchase date is not eligible for warranty service.
5. Write the RMA number visibly on the outside of the package and ship it prepaid to your dealer.

FCC Class B

This equipment has been tested and found to comply with the limits for a Class B digital device, pursuant to Part 15 of the FCC Rules. These limits are designed to provide reasonable protection against harmful interference when the equipment is operated in a residential environment. This equipment generates, uses and can radiate radio frequency energy. If not installed and used in accordance with this user's manual, it may cause harmful interference to radio communications. Note that even when this equipment is installed and used in accordance with this user's manual, there is still no guarantee that interference will not occur. If this equipment is believed to be causing harmful interference to radio or television reception, this can be determined by turning the equipment on and off. If the interference is occurring, the user is encouraged to try to correct the interference by one or more of the following measures:

- Reorient or relocate the receiving antenna
- Increase the separation between the equipment and the receiver
- Connect the equipment to a power outlet on a circuit different from that to which the receiver is connected
- Consult the dealer or an experienced radio/TV technician for help

警告使用者

這是甲類的資訊產品，在居住的環境中使用時，可能會造成射頻干擾，在這種情況下，使用者會被要求採取某些適當的對策。

Packing List

Before installing your equipment, make sure that the following materials have been received:

- FPM-3150G Series flat panel monitor
- Accessory pack, including:
 - AC/DC adapter
 - AC/DC power adapter bracket
 - DC in Power Cord Bracket x 1 piece
 - Video Signal Cable, 1.8m
 - Panel/Wall mount bracket x 2
 - Panel sponge x 4
 - RS-232 cable, 1.8m (FPM-3150G-R only)
 - Screw Bag (M6x35mm screws with spring by 4 pieces)
 - Driver / Manual CD-ROM

If any of these items are missing or damaged, contact your distributor or sales representative immediately.

Additional Information and Assistance

1. Visit the Advantech web site at www.advantech.com where you can find the latest information about the product.
2. Contact your distributor, sales representative, or Advantech's customer service center for technical support if you need additional assistance. Please have the following information ready before you call:
 - Product name and serial number
 - Description of your peripheral attachments
 - Description of your software (operating system, version, application software, etc.)
 - A complete description of the problem
 - The exact wording of any error messages

Safety Instructions

1. Read these safety instructions carefully.
2. Keep this User's Manual for later reference.
3. Disconnect this equipment from any AC outlet before cleaning. Use a damp cloth. Do not use liquid or spray detergents for cleaning.
4. For plug-in equipment, the power outlet socket must be located near the equipment and must be easily accessible.
5. Keep this equipment away from humidity.
6. Put this equipment on a reliable surface during installation. Dropping it or letting it fall may cause damage.
7. The openings on the enclosure are for air convection. Protect the equipment from overheating. **DO NOT COVER THE OPENINGS.**
8. Make sure the voltage of the power source is correct before connecting the equipment to the power outlet.
9. Position the power cord so that people cannot step on it. Do not place anything over the power cord.
10. All cautions and warnings on the equipment should be noted.
11. If the equipment is not used for a long time, disconnect it from the power source to avoid damage by transient overvoltage.
12. Never pour any liquid into an opening. This may cause fire or electrical shock.
13. Never open the equipment. For safety reasons, the equipment should be opened only by qualified service personnel.
14. If one of the following situations arises, get the equipment checked by service personnel:
 - a. The power cord or plug is damaged.
 - b. Liquid has penetrated into the equipment.
 - c. The equipment has been exposed to moisture.
 - d. The equipment does not work well, or you cannot get it to work according to the user's manual.
 - e. The equipment has been dropped and damaged.
 - f. The equipment has obvious signs of breakage.

15. DO NOT LEAVE THIS EQUIPMENT IN AN UNCONTROLLED ENVIRONMENT WHERE THE STORAGE TEMPERATURE IS BELOW -20° C (-4° F) OR ABOVE 60° C (140° F). THIS MAY DAMAGE THE EQUIPMENT.

The sound pressure level at the operator's position according to IEC 704-1:1982 is no more than 70dB(A).

DISCLAIMER: This set of instructions is given according to IEC 704-1. Advantech disclaims all responsibility for the accuracy of any statements contained herein.

Wichtige Sicherheitshinweise

1. Bitte lesen sie Sich diese Hinweise sorgfältig durch.
2. Heben Sie diese Anleitung für den späteren Gebrauch auf.
3. Vor jedem Reinigen ist das Gerät vom Stromnetz zu trennen. Verwenden Sie Keine Flüssig-oder Aerosolreiniger. Am besten dient ein angefeuchtetes Tuch zur Reinigung.
4. Die NetzanschlusBsteckdose soll nahe dem Gerät angebracht und leicht zugänglich sein.
5. Das Gerät ist vor Feuchtigkeit zu schützen.
6. Bei der Aufstellung des Gerätes ist auf sicheren Stand zu achten. Ein Kippen oder Fallen könnte Verletzungen hervorrufen.
7. Die Belüftungsöffnungen dienen zur Luftzirkulation die das Gerät vor überhitzung schützt. Sorgen Sie dafür, daB diese Öffnungen nicht abgedeckt werden.
8. Beachten Sie beim. AnschluB an das Stromnetz die AnschluBwerte.
9. Verlegen Sie die NetzanschlusBleitung so, daB niemand darüber fallen kann. Es sollte auch nichts auf der Leitung abgestellt werden.
10. Alle Hinweise und Warnungen die sich am Geräten befinden sind zu beachten.
11. Wird das Gerät über einen längeren Zeitraum nicht benutzt, sollten Sie es vom Stromnetz trennen. Somit wird im Falle einer Überspannung eine Beschädigung vermieden.

12. Durch die Lüftungsöffnungen dürfen niemals Gegenstände oder Flüssigkeiten in das Gerät gelangen. Dies könnte einen Brand bzw. elektrischen Schlag auslösen.
13. Öffnen Sie niemals das Gerät. Das Gerät darf aus Gründen der elektrischen Sicherheit nur von autorisiertem Servicepersonal geöffnet werden.
14. Wenn folgende Situationen auftreten ist das Gerät vom Stromnetz zu trennen und von einer qualifizierten Servicestelle zu überprüfen:
 - a - Netzkabel oder Netzstecker sind beschädigt.
 - b - Flüssigkeit ist in das Gerät eingedrungen.
 - c - Das Gerät war Feuchtigkeit ausgesetzt.
 - d - Wenn das Gerät nicht der Bedienungsanleitung entsprechend funktioniert oder Sie mit Hilfe dieser Anleitung keine Verbesserung erzielen.
 - e - Das Gerät ist gefallen und/oder das Gehäuse ist beschädigt.
 - f - Wenn das Gerät deutliche Anzeichen eines Defektes aufweist.
15. **VORSICHT:** Explosionsgefahr bei unsachgemäßen Austausch der Batterie. Ersatz nur durch denselben oder einem vom Hersteller empfohlenen ähnlichen Typ. Entsorgung gebrauchter Batterien nach Angaben des Herstellers.
16. **ACHTUNG:** Es besteht die Explosionsgefahr, falls die Batterie auf nicht fachmännische Weise gewechselt wird. Verfangen Sie die Batterie nur gleicher oder entsprechender Type, wie vom Hersteller empfohlen. Entsorgen Sie Batterien nach Anweisung des Herstellers.

Der arbeitsplatzbezogene Schalldruckpegel nach DIN 45 635 Teil 1000 beträgt 70dB(A) oder weniger.

Haftungsausschluss: Die Bedienungsanleitungen wurden entsprechend der IEC-704-1 erstellt. Advantech lehnt jegliche Verantwortung für die Richtigkeit der in diesem Zusammenhang getätigten Aussagen ab.

DISCLAIMER: This set of instructions is given according to IEC704-1.

Advantech disclaims all responsibility for the accuracy of any statements contained herein.

Contents

Chapter 1	Introduction	2
1.1	Introduction	2
1.2	Specifications	2
1.3	LCD Specification	3
1.4	Power Consumption	3
1.5	Connectors	4
1.6	Dimensions	5
	Figure 1.1:FPM-3150G Dimensions	5
Chapter 2	Mounting.....	8
2.1	Mounting the Monitor	8
2.1.1	Wall Mounting	8
	Figure 2.1:Wallmounting	8
2.1.2	Panel Mounting	9
	Figure 2.2:Panel Mounting (396 x 296 mm)	9
2.1.3	Rack Mounting (Optional)	10
	Figure 2.3:Rack Mounting Brackets	10
2.2	Desktop, Swing-ARM for FPM-3150G	11
2.2.1	Desktop Stand	11
	Figure 2.4:Desktop Stand for FPM-3150G	11
2.2.2	Swing-ARM (VESA Compliant)	12
	Figure 2.5:Swing-ARM for FPM-3150G	12
Appendix A	Touchscreen	14
A.1	Introduction	14
A.2	Touchscreen Specifications	14
A.3	Installing Driver for Windows OS	16
Appendix B	Setting Serial Data for Expansion	18
B.1	Setting Serial Data for Expansion	18
Appendix C	OSD Operation Keypad.....	20
C.1	OSD Board Overview	20
C.1.1	OSD Button Description	20
C.1.2	LED Function	20
C.2	OSD Key Functions	21
C.2.1	Menu Start	21
C.2.2	Input Source Select	22
C.2.3	Contrast/ Brightness Setting	23
C.2.4	Geometry Menu – For DVI Input	24
C.2.5	Color Temperature Menu	26
C.2.6	RGB Color Menu	27
C.2.7	Language Menu	28
C.2.8	OSD Manager	29
C.2.9	Auto Configuration Menu	30

C.2.10 Mode Information Menu	31
C.2.11 Memory Recall Menu	32
C.2.12 Exit Menu	33
C.2.13 Hot Keys	34

Introduction

This chapter includes:

- Introduction
- Specifications
- LCD Specification
- Power Consumption
- Connectors
- Dimensions

Chapter 1 Introduction

1.1 Introduction

Advantech's FPM-3150G is a 15" color TFT LCD flat panel monitor built specifically for industrial applications. With the optional touchscreen, FPM-3150G is an excellent and user-friendly system control interface.

In addition to its usual application as an LCD panel monitor, FPM-3150G comes standard with direct VGA control signal input, making it compatible with Industrial PCs and Workstations. Its OSD (On Screen Display) function allows you to adjust display factors such as brightness, contrast, colors and VGA signal information. Functions that are more and more critical as HMI users become aware of the benefits of flat panel monitors. The whole chassis is of stainless steel, and the front panel is of aluminum with NEMA4/IP65 compliance.

FPM-3150G also comes in a touch screen version (FPM-3150G-R). With an 8-wire resistive type touchscreen, this monitor can be immediately transformed into a remote control system. The Advantech FPM-3150G is the ultimate HMI solution for your industrial application.

1.2 Specifications

General

- **Construction:** Heavy-duty aluminum and steel chassis
- **Front panel:** Aluminum, NEMA4 / IP65 Compliant
- **Control:** OSD (On Screen Display) control pad on front side
- **Mounting:** Panel, wall, desktop, VESA ARM or rack (with rackmount)
- **Dimensions (W x H x D):** 422 x 310 x 86 mm (16.6" x 12.2" x 3.4")
- **Weight:** 6.2 kg (13.7 lb)

Touchscreen (Optional)

- **Type:** 8 wire, analog resistive
- **Resolution:** 1024 x 1024
- **Light Transmission:** >80% (Gouge Hardness is greater than 4H per ASTM D3363-92 for HCC01, HCG10 and HCG12)
- **Operating Pressure:** 30 ~ 45 gram for stylus pen
contact bounce < 10 ms
- **Controller:** USB & RS-232 interface
- **Power Consumption:** +5 V @ 200 mA
- **OS Support:** Win 95/98/ME/2000/XP/CE/NT/Vista, Linux, MS-DOS
- **Life Span:** 100 million activation (typical) at a single point with a 5/8" diameter silicone finger with a 350 g load at 2 touches per second

1.3 LCD Specification

- **Display Type:** XGA TFT LCD
- **Display Size:** 15"
- **Max. Colors:** 16.2 M (6 bit + FRC) Full Color
- **Max. Resolution:** 1024 x 768
- **Dot Pitch:** 0.297 x 0.297 mm
- **View Angle:** 140° (V), 120° (H)
- **Luminance:** 550 cd/m²
- **Storage Temperature:** -20 ~ 60 ° C
- **Operating Temperature:** 0 ~ 50 ° C
- **Contrast Ratio:** 500:1 (typ)
- **Lamp Life Time (MTBF):** 50,000 hrs.

1.4 Power Consumption

- **Max. Output Power:** 48 W
- **AC Input Voltage:** 100-240 V_{AC}
- **Output Voltage:** + 12 V @ 4 A
- **Safety Standards:** CE/CCC/FCC/CB

1.5 Connectors

The following connectors are situated on the left hand side of the FPM-3150G Series:

VGA Port (DB-15)

This DB-15 connector can be connected to the system via the external 15-pin DB-15 connector located on the left side of the system unit.

DVI Port (DVI-D)

Connected with a standard DVI connector thru I/O port of this unit. Only supports digital signals

Touchscreen Connector (DB-9) (optional)

This connector will be present only if a touchscreen is installed. It must be connected to the RS-232 port of the PC. The touchscreen cable is included with all orders which include the touchscreen option.

Touchscreen Connector (USB) (Optional)

This connector will be present only if a touchscreen is installed. It must be connected to the USB port of the PC. The touchscreen cable is included with all orders which include the USB touchscreen option.

Note: RS-232 & USB touch screen interface not allow to connect into the system at the same time.

DC 12V Power In

This connector will be connected to the DC 12V Switching Power Supply.

1.6 Dimensions

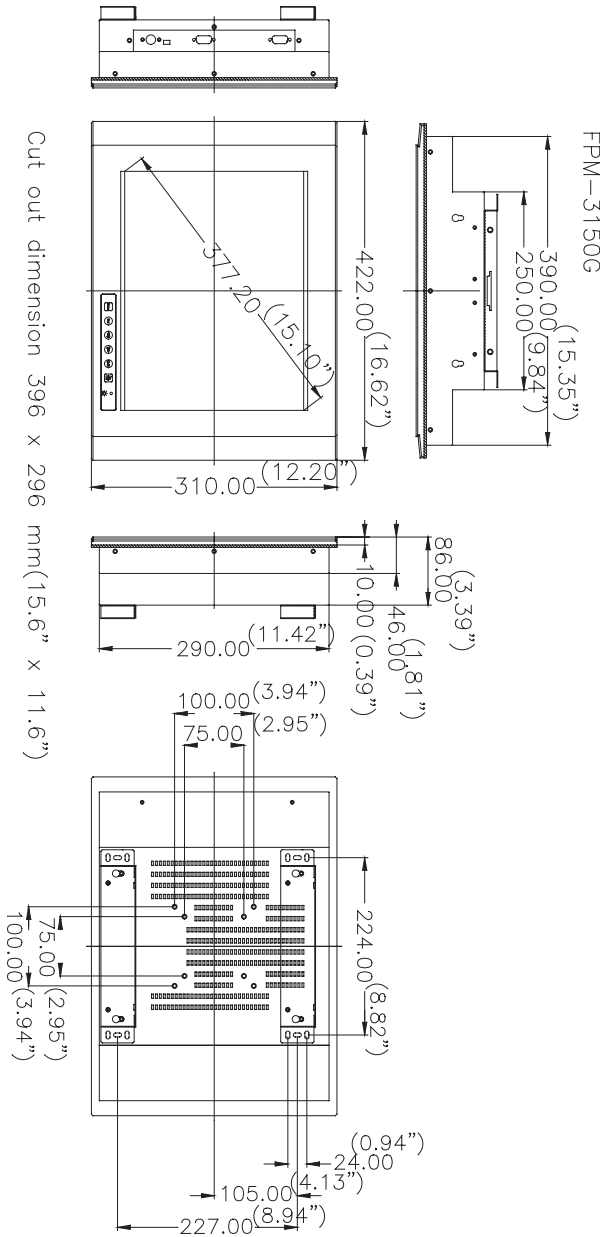

Figure 1.1: FPM-3150G Dimensions

Mounting

- Wallmounting
- Panel Mounting
- Rack Mounting
- Desktop Mounting
- Swing Arm Mounting

Chapter 2 Mounting

2.1 Mounting the Monitor

The FPM-3150G Series can be mounted in many different ways. The versatility of the FPM-3150G mounts enable it to be mounted on your desk or anywhere else.

2.1.1 Wall Mounting

FPM-3150G can be mounted directly on a wall with panel mounting brackets. Please refer to figure 2-1 and follow the following steps to mount FPM-3150G on a wall:

1. Screw the hook and panel-mount brackets on the wall.
2. Place the FPM-3150G in the brackets.
3. Fix FPM-3150G on the hook and panel-mount bracket..

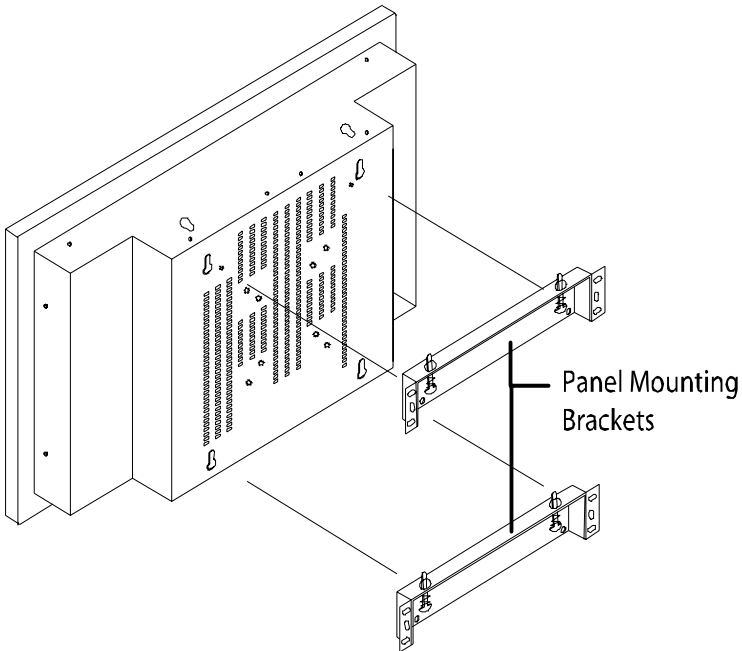

Figure 2.1: Wallmounting

2.1.2 Panel Mounting

If you need to install the FPM-3150G series in a panel, please release the mounting brackets by detaching four screws on rear side and fix them on the top and bottom with screws.

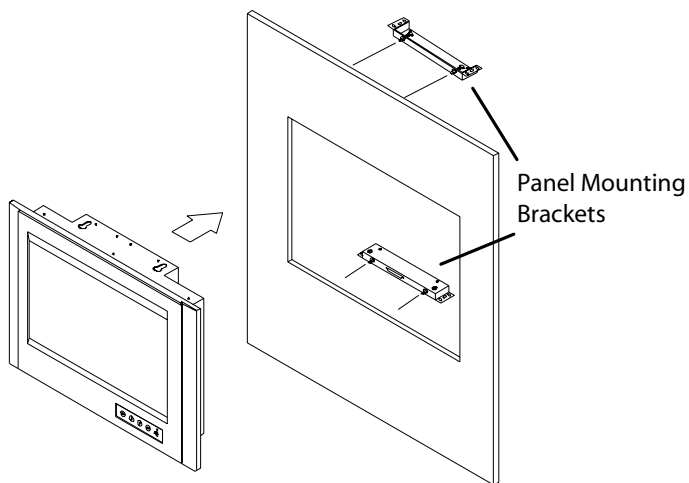

Figure 2.2: Panel Mounting (396 x 296 mm)

2.1.3 Rack Mounting (Optional)

If you need to install the FPM-3150G on a rack, you must order the rack mount kit for FPM-3150G (Part Number is FPM-3150G-RMKE). Attach the two rack mounting brackets on each side of FPM-3150G with 12 screws, then affix the monitor in the rack.

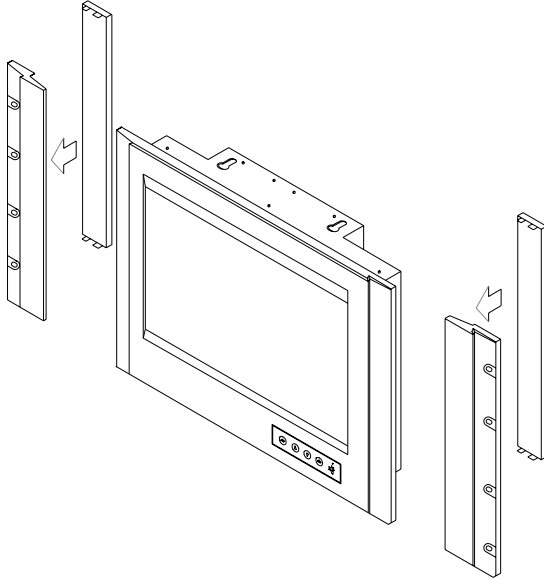

Figure 2.3: Rack Mounting Brackets

2.2 Desktop, Swing-ARM for FPM-3150G

The FPM-3150G Series can be mounted in other ways. These is a desktop stand for desktop use and it can also be attached to a swing-arm bracket.

2.2.1 Desktop Stand

The panel-mount bracket is attached to the rear of the FPM-3150G to become a desktop stand. (Refer to figure 2.4) Simply detach the small bracket at the top of the monitor by unscrewing the two screws. The lower bracket now becomes a desktop stand bracket.

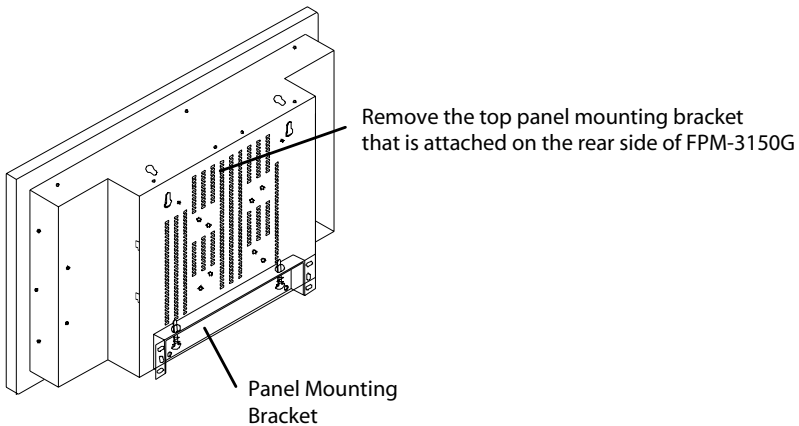

Figure 2.4: Desktop Stand for FPM-3150G

2.2.2 Swing-ARM (VESA Compliant)

FPM-3150G has been designed with support for the VESA Arm standard. Refer to figure 2.5. Detach the mounting brackets on the rear side, and attach the FPM-3150G onto the VESA ARM Mount.

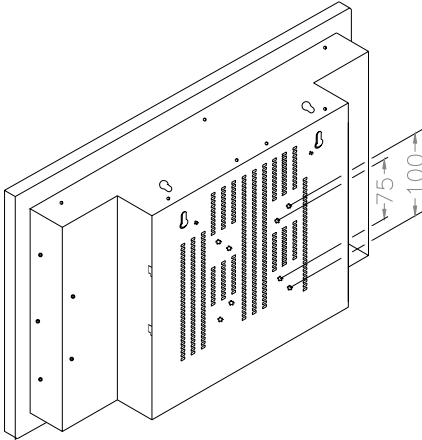

Figure 2.5: Swing-ARM for FPM-3150G

APPENDIX
A

Touchscreen

Appendix A Touchscreen

A.1 Introduction

The FPM-3150G Series optional touchscreen uses advanced 8-wire resistive technology. It provides more accurate sensing capacity than other technologies. The touchscreen is specially designed for tough industrial environments, and has been approved to FCC Class B standards.

Note: RS-232 & USB touch screen interface not allow to connect into the system at the same time.

A.2 Touchscreen Specifications

1. Input Method and Activation Force

1.6mm dia. Delrin stylus : 0.10~0.70N

16mm dia. Silicon "finger" : 0.10~0.80N

2. Typical Optical Characteristics

2.1 Visible Light Transmission: >80%

2.2 Haze: < 13%

3. Electrical Specifications

3.1 Operating Voltage: 5.5V or less

3.2 Contact current: 20mA (maximum)

3.3 Circuit close resistance: X :300~1000

Y :200~700

3.4 Circuit open resistance: > 10M at 25VDC

3.5 Contact bounce: < 10ms

3.6 Linear Test : <1.5 %

3.7 Capacitance: 100nF(maximum)

3.8 Electrostatic Discharge Protection : (per EN 61000-4-2)

The touch screen withstands of 15KV air discharge and 8KV contact discharge.

4. Linearity

4.1 Linear Test Specifications

Direction X: <1.5 %

Direction Y: <1.5 %

4.2 Linearity Test

Apply voltage (DC5V) to upper (or lower) electrodes, output voltage V_x or V_y on the other electrodes is measured at every regular intervals.

Linearity is the value of max. error voltage

5. Environment Specifications

5.1 Operating Temperature: $-10 \sim +60^\circ \text{C}$

5.2 Storage Temperature: $-40 \sim +80^\circ \text{C}$

5.3 Humidity: if 40°C , humidity <80% RH

if 40°C , humidity < 90% RH No dew condensation

A.3 Installing Driver for Windows OS

The touchscreen has drivers for Windows 2000 /XP/2003/Vista. You should read the instructions in CD-ROM Disk Touchscreen section carefully before you attempt installation. The FPM-3150G-XCE, RCE need to install Penmount 6000 driver. Please find Penmount 6000 folder and install the driver into your system.

Note 1: The driver manual are examples only. You must follow the flow chart instructions and pay attention to the instructions which then appear on your screen.

Note 2: The USB & RS-232 cable not allow to connect to system at the same time.

Note 3: USB & RS-232 interface driver is different, uninstall previous driver before installing a different driver.

:Note 4: If there is any others OS driver need, could download at the web site: <http://www.penmount.com.tw> (Penmount 6000)

APPENDIX
B

Setting Serial Data for Expansion

Appendix B Setting Serial Data for Expansion

B.1 Setting Serial Data for Expansion

The twelve kinds of timings below are already programmed in this module. The input synchronous signals are automatically recognized.

Resolution	Vertical Frequencies									
	56 Hz		60 Hz		70 Hz		72 Hz		75 Hz	
	Pass	Fail	Pass	Fail	Pass	Fail	Pass	Fail	Pass	Fail
640 x 480			V				V		V	
800 x 600	V		V		V		V		V	
1024 x 768			V		V		V		V	

Note 1: *Even if the preset timing is entered, a little adjustment of the functions such as Horizontal period, CLK-delay and display position, are required. The adjusted values are memorized in every preset number.*

Note 2: *This module recognizes the synchronous signals with near preset timing of the frequency of the HS and Vsync, even in the case that the signals other than the preset timing that were entered.*

Note 3: *Because adjustments may not fit, such as differing magnifying ratios or, in the case that you use it except for the display timing that was pre-set.*

APPENDIX

C

OSD Operation Keypad

Appendix C OSD Operation Keypad

C.1 OSD Board Overview

The OSD keypad, including six keys and a two color indicator, is designed as the OSD operation interface

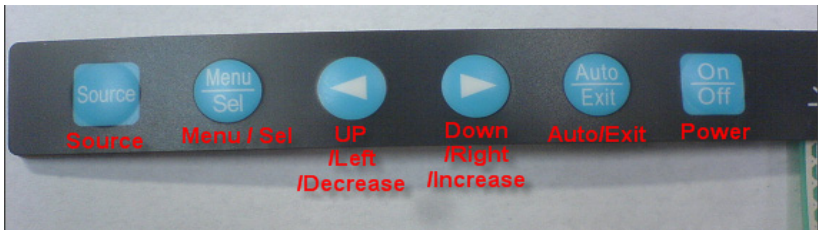

C.1.1 OSD Button Description

Buttons	Descriptions
Power	Turn the monitor power ON or OFF.
Auto/Exit	Automatically adjust the clock, phase, H-position and V-position. Exit menu.
Down/Right/ Increase	Activate the volume control. Move the selector to the next option. Increase the gauge value of the selected option.
Up/Left/ Decrease	Active volume control. Move the selector to the previous option. Decrease the gauge value of the selected option.
Menu/Sel	Activate the OSD menu. Enter/confirm the selected option.
Source	Changes Input video source

C.1.2 LED Function

ON	Green
StandBy/OFF	Green Blinking
No Signals	Orange

C.2 OSD Key Functions

Each selected value is stored into LCD memory after SEL signal input or time out. The stored values are not affected if the power is turned off. But the selected value is not available in case a selected mode is changed before time out or power is turned off before time out. TIME OUT → 5-6 seconds (Can be set in OSD Manager) The default definition of input keys is shown as following:

C.2.1 Menu Start





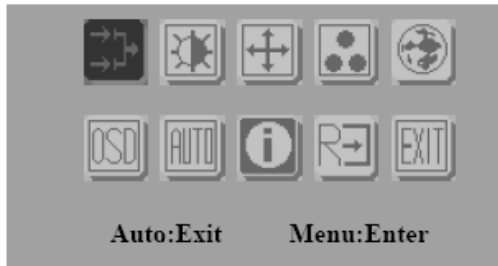

Generate Main Menu

Press MENU Button in OSD function key

- Main Menu -- DISPLAY IN SCREEN



- Sub-Menu – DISPLAY IN SCREEN
- N/A
- Available Key Functions

	N/A		N/A
	Select to exit menu or wait for time out		N/A
	N/A		N/A

C.2.2 Input Source Select

- Generate Main Menu



Select  by **Left** and **Right** Button, press **Menu** Button for selection confirmation



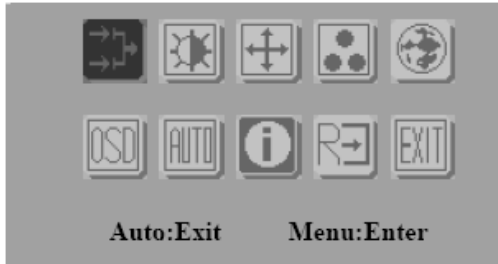

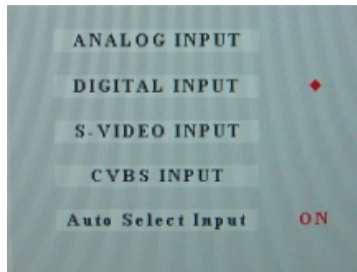

- Main Menu -- DISPLAY IN SCREEN



- Sub-Menu – DISPLAY IN SCREEN



- Available Key Functions

	Power Off the LCD Monitor		Increase the gauge value of the selected option.
	Return to last menu		Selected to confirm
	Decrease the gauge value of the selected option.		N/A

4. Auto Select Input

- ON → start from default setting and scan the inputs by following sequence from ANALOG INPUT, DIGITAL INPUT, S-VIDEO INPUT, and CVBS INPUT.
- OFF → start from default setting

C.2.3 Contrast/ Brightness Setting

- Generate Main Menu



Select  by **Left** and **Right** Button, press **Menu** Button for selection confirmation



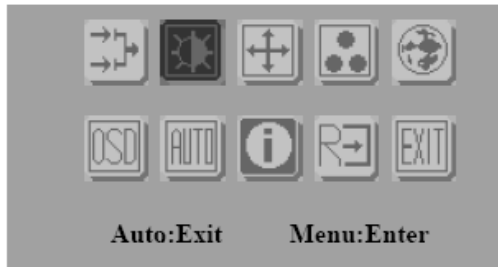

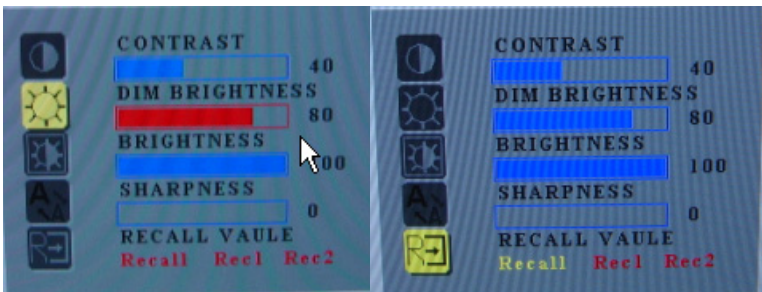

- Main Menu -- DISPLAY IN SCREEN



n Sub-Menu – DISPLAY IN SCREEN



- Available Key Functions

	Power Off the LCD Monitor		Increase the gauge value of the selected option.
	Return to last menu		Selected to confirm
	Decrease the gauge value of the selected option.		N/A

RECALL VALUE – User Define

- Rec1 → Pressed to record 1st setting as recall value followed by current screen setting
- Rec2 → Pressed to record 2nd setting as recall value followed by current screen setting
- Recall → Switch the setting change by Rec1 and Rec2 while pressed

C.2.4 Geometry Menu – For DVI Input

- Generate Main Menu





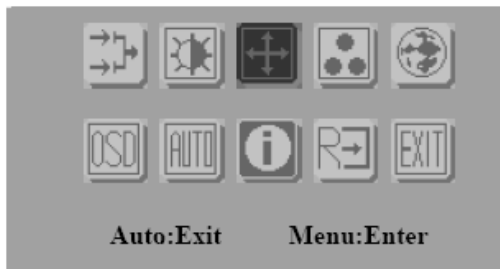

Select  by **Left** and **Right** Button, press **Menu** Button for selection confirmation







- Main Menu -- DISPLAY IN SCREEN



- Sub-Menu – DISPLAY IN SCREEN

	FOCUS <input type="text"/>	0~100
	CLOCK <input type="text"/>	0~100
	H.POSITION <input type="text"/>	0~100
	V.POSITION <input type="text"/>	0~100

- Available Key Functions

	Power Off the LCD Monitor		Increase the gauge value of the selected option.
	Return to last menu		Selected to confirm
	Decrease the gauge value of the selected option.		N/A

C.2.5 Color Temperature Menu

- Generate Main Menu

Select  by **Left** and **Right** Button, press **Menu** Button for selection confirmation



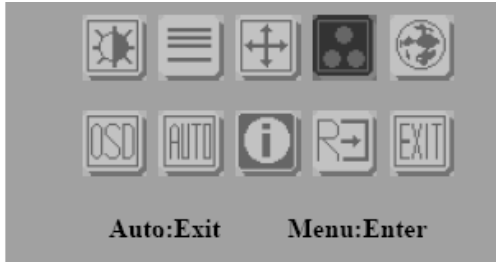

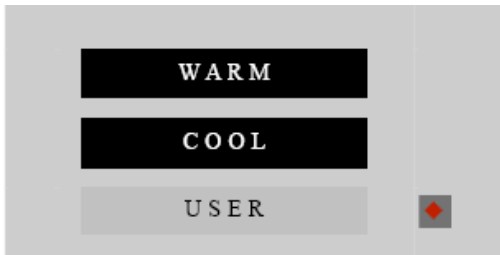

- Main Menu -- DISPLAY IN SCREEN



- Sub-Menu – DISPLAY IN SCREEN



- Available Key Functions

	Power Off the LCD Monitor		Increase the gauge value of the selected option.
	Return to last menu		Selected to confirm
	Decrease the gauge value of the selected option.		N/A

C.2.6 RGB Color Menu

- Generate Main Menu

Select  by **Left** and **Right** Button, press **Menu** Button for selection confirmation

Select  by **Left** and **Right** Button, Press **Menu** Button for selection confirmation

- Main Menu -- DISPLAY IN SCREEN

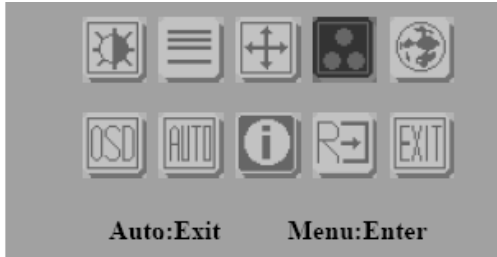



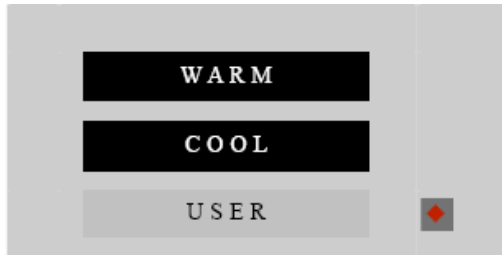

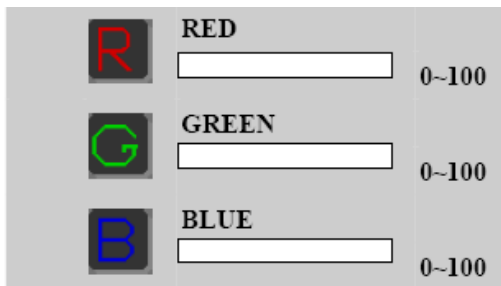

- Sub-Menu – DISPLAY IN SCREEN



- Sub-Menu – DISPLAY IN SCREEN



- Available Key Functions

	Power Off the LCD Monitor		Increase the gauge value of the selected option.
	Return to last menu		Selected to confirm
	Decrease the gauge value of the selected option.		N/A

Customization setting for RGB colors

C.2.7 Language Menu

- Generate Main Menu



Select  by **Left** and **Right** Button, press **Menu** Button for selection confirmation



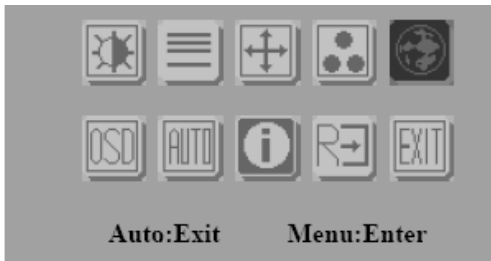



- Main Menu -- DISPLAY IN SCREEN



- Sub-Menu – DISPLAY IN SCREEN



- Available Key Functions

	Power Off the LCD Monitor		Increase the gauge value of the selected option.
	Return to last menu		Selected to confirm
	Decrease the gauge value of the selected option.		N/A

C.2.8 OSD Manager

- Generate Main Menu

Select  by **Left** and **Right** Button, press **Menu** Button for selection confirmation



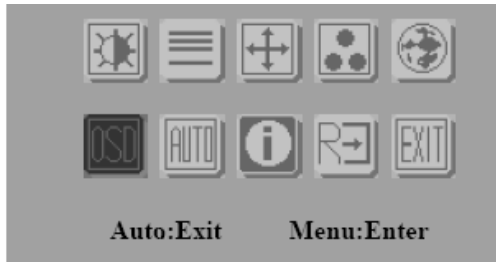

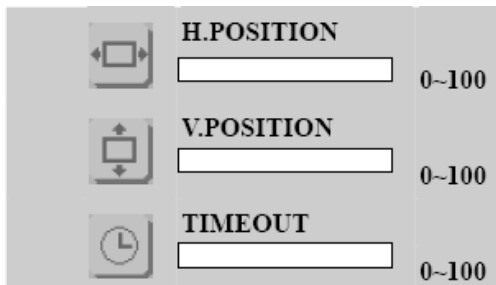

- Main Menu -- DISPLAY IN SCREEN



- Sub-Menu – DISPLAY IN SCREEN



- Available Key Functions

	Power Off the LCD Monitor		Increase the gauge value of the selected option.
	Return to last menu		Selected to confirm
	Decrease the gauge value of the selected option.		N/A

C.2.9 Auto Configuration Menu

- Generate Main Menu

Select  by **Left** and **Right** Button, press **Menu** Button for selection confirmation



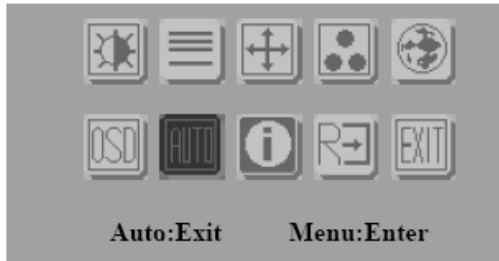



- Main Menu -- DISPLAY IN SCREEN



- Sub-Menu – DISPLAY IN SCREEN



- Available Key Functions

	Power Off the LCD Monitor		Increase the gauge value of the selected option.
	Return to last menu		Selected to confirm
	Decrease the gauge value of the selected option.		N/A

Auto configuration can be set in menu and also can press the  without any menu indication.

C.2.10 Mode Information Menu

- Generate Main Menu

Select  by **Left** and **Right** Button, press **Menu** Button for selection confirmation



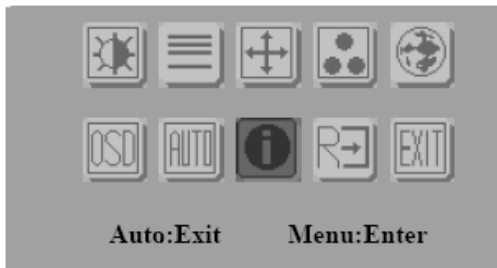

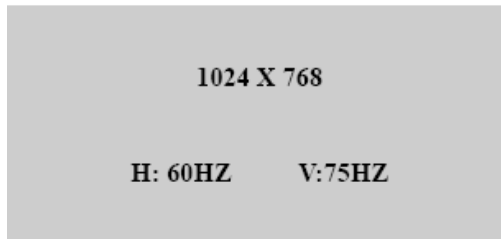

- Main Menu -- DISPLAY IN SCREEN



- Sub-Menu – DISPLAY IN SCREEN



- Available Key Functions

	Power Off the LCD Monitor		Increase the gauge value of the selected option.
	Return to last menu		Selected to confirm
	Decrease the gauge value of the selected option.		N/A

C.2.11 Memory Recall Menu

- Generate Main Menu



Select  by **Left** and **Right** Button, press **Menu** Button for selection confirmation



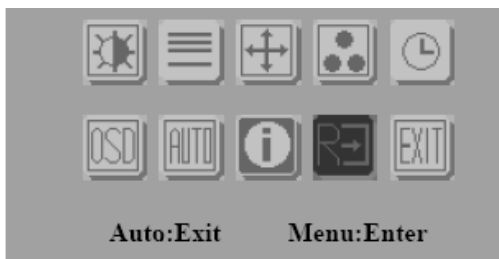

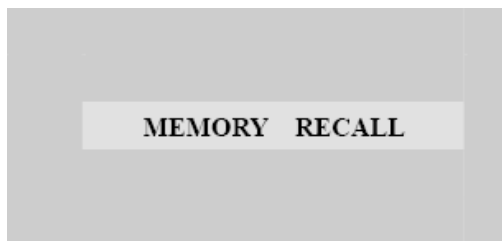

- Main Menu -- DISPLAY IN SCREEN



- Sub-Menu – DISPLAY IN SCREEN



- Available Key Functions

	Power Off the LCD Monitor		Increase the gauge value of the selected option.
	Return to last menu		Selected to confirm
	Decrease the gauge value of the selected option.		N/A

C.2.12 Exit Menu

- Generate Main Menu

Select  by **Left** and **Right** Button, press **Menu** Button for selection confirmation



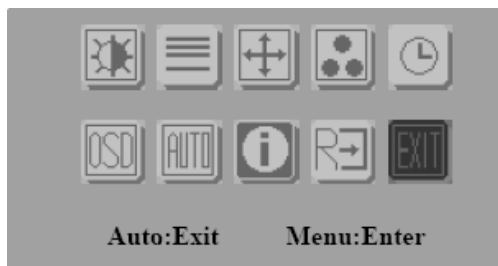

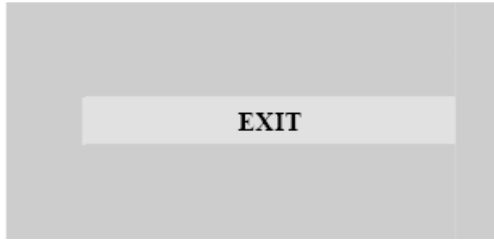

- Main Menu -- DISPLAY IN SCREEN



- Sub-Menu – DISPLAY IN SCREEN



- Available Key Functions

	Power Off the LCD Monitor		Increase the gauge value of the selected option.
	Return to last menu		Selected to confirm
	Decrease the gauge value of the selected option.		N/A

C.2.13 Hot Keys

OSD LOCK/UNLOCK

HOT KEYS

Press  first then press  for change this setting, Followed this sequence for the button press so that you can have OSD LOCK and UNLOCK setting

Entry OSD LOCK MODE

Press HOT KEY, the screen will show this action first

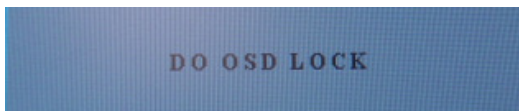

- Don't remove the HOT KEY until the screen indicated this task is finished.

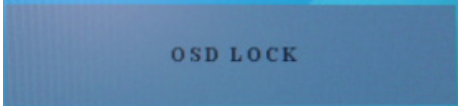

OSD LOCK

- Entry OSD UNLOCK MODE
- Press HOT KEY, the screen will show this action first

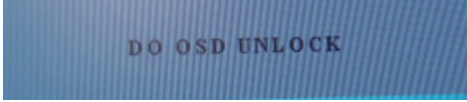

DO OSD UNLOCK

- Don't remove the HOT KEY until the screen indicated this task is finished.



OSD UNLOCK

Free Manuals Download Website

<http://myh66.com>

<http://usermanuals.us>

<http://www.somanuals.com>

<http://www.4manuals.cc>

<http://www.manual-lib.com>

<http://www.404manual.com>

<http://www.luxmanual.com>

<http://aubethermostatmanual.com>

Golf course search by state

<http://golfingnear.com>

Email search by domain

<http://emailbydomain.com>

Auto manuals search

<http://auto.somanuals.com>

TV manuals search

<http://tv.somanuals.com>