

# LAVAMAT L 14840



User Manual

Washer-dryer

**AEG**

PERFEKT IN FORM UND FUNKTION

 Electrolux

Download from [www.Somanuals.com](http://www.Somanuals.com). All Manuals Search And Download.

## Dear Customer

Thank you for choosing one of our high-quality products.

With this appliance you will experience the perfect combination of functional design and cutting edge technology.

Convince yourself that our appliances are engineered to deliver the best performance and control - indeed we are setting the highest standards of excellence.

In addition to this you find environmental and energy saving aspects as an integral part of our products.

To ensure optimal and regular performance of your appliance please read this instruction manual carefully. It will enable you to navigate all processes perfectly and most efficiently. To refer to this manual any time you need to, we recommend you to keep it in a safe place. And please pass it to any future owner of the appliance.

We wish you much joy with your new appliance.

The following symbols are used in this manual:



Important information concerning your personal safety and information on how to avoid damaging the appliance



General information and tips



Environmental information

---

# Contents

---

Instruction booklet	6
Safety information	6
Product Description	9
Detergent dispenser drawer	9
Control panel	10
Display	11
First use	13
Personalization	13
Acoustic signal	13
Child safety lock	13
Daily use - Washing	14
Load the laundry	14
Measure out the detergent and the fabric softener	14
Select the required programme by turning the programme selector dial	14
Select the SPIN speed or RINSE HOLD option	15
Programme option button	15
Select the STAIN option	16
Select the TIME option	16
Select an additional rinse	16
Select the START/PAUSE	16
Select the DELAY START	17
Altering an option or a running programme	17
Interrupting a programme	17
Cancelling a programme	18
Opening the door after the programme has started	18
At the end of the programme	18

<b>Drying only</b>	<b>19</b>
Select the drying programme by turning the programme selector dial	19
Select the automatic drying	19
Select the timed drying	19
At the end of the programme	19
Automatic washing and drying	20
<b>Washing programmes</b>	<b>21</b>
<b>Programme information</b>	<b>23</b>
<b>Automatic drying programmes</b>	<b>24</b>
<b>Drying Time</b>	<b>24</b>
<b>Preparing the wash cycle</b>	<b>25</b>
Sorting the laundry	25
Temperatures	25
Before loading the laundry	25
Maximum loads	25
Laundry weights	26
Removing stains	26
Detergents and additives	27
Quantity of detergent to be used	27
Degrees of water hardness	28
<b>Preparing the drying cycle</b>	<b>28</b>
Laundry not suitable for drying	28
Drying symbols label	29
Drying cycle duration	29
Additional drying	29
<b>Care and cleaning</b>	<b>30</b>
Descaling	30
After each wash	30

---

Maintenance wash	30
External cleaning	30
Detergent dispenser drawer	30
Washing drum	31
Door seal	31
Drain pump	31
Water inlet filter	33
Frost precautions	34
Emergency emptying out	34
<b>What to do if...</b>	<b>35</b>
<hr/>	
<b>Technical Data</b>	<b>38</b>
<hr/>	
<b>Consumption value</b>	<b>39</b>
<hr/>	
<b>Installation</b>	<b>40</b>
<hr/>	
Unpacking	40
Positioning and levelling	42
Water inlet	42
Water drainage	43
In the interest of the environment	45
Electrical connection	45
Permanent connection	46
<b>Environment concerns</b>	<b>47</b>
<hr/>	
Packaging materials	47
Old machine	47
Ecological hints	47

# Instruction booklet

## Safety information

### Prior to using for the first time

- The safety of AEG/ELECTROLUX appliances complies with the industry standards and with legal requirements on the safety of appliances. However, as manufacturers, we feel it is our duty to provide the following safety notes. You **MUST** read them carefully before installing or using the appliance.
- It is most important that this instruction book should be retained with the appliance for future reference. Should the appliance be sold or transferred to another owner, or should you move house and leave the appliance, always ensure that the book is supplied with the appliance in order that the new owner can get to know the functioning of the appliance and the relevant warnings.
- You **MUST** read them carefully before installing or using the appliance.
- Before first starting up, check the machine for any damage incurred during transport. Never connect up a damaged machine. If parts are damaged, contact your supplier.
- If the appliance is delivered in the winter months when there are minus temperatures: Store the washer-dryer at room temperature for 24 hours before using for the first time.

### General safety

- It is dangerous to alter the specifications or attempt to modify this product in any way.
- During high temperature washing and drying programmes the door glass may get hot. Do not touch it!
- Make sure that small pets do not climb into the drum. To avoid this, please check into the drum before using.
- Any objects such as coins, safety pins, nails, screws, stones or any other hard, sharp material can cause extensive damage and must not be placed into the machine.
- Only use the advised quantities of fabric softener and detergent. Damage to the fabric can ensue if you over-fill. Refer to the manufacturer's recommendations of quantities.
- Wash small items such as socks, laces, washable belts etc in a washing bag or pillow case as it is possible for such items to slip down between the tub and the inner drum.
- Do not use your washer-dryer to wash and dry articles with whalebones,

material without hems or torn material.

- Always unplug the appliance and turn off the water supply after use, clean and maintenance.
- Under no circumstances should you attempt to repair the machine yourself. Repairs carried out by inexperienced persons may cause injury or serious malfunctioning. Contact your local Service Centre. Always insist on genuine spare parts.

## Installation

- When unpacking the appliance, check that it is not damaged. If in doubt, do not use it and contact the Service Centre.
- All packing and transit bolts must be removed before use. Serious damage can occur to the product and to property if this is not adhered to. See relevant section in the user manual.
- After having installed the appliance, check that it is not pressing or standing on its electrical supply cable, inlet hose and drain hose.
- If the machine is situated on a carpeted floor, please adjust the feet in order to allow air to circulate freely
- Always be sure, that there is no water leakage from hoses and their connections after the installation.
- If the appliance is installed in a location subject to frost, please read the **dangers of freezing** chapter.
- Any plumbing work required to install this appliance should be carried out by a qualified plumber or competent person.
- Any electrical work required to install this appliance should be carried out by a qualified electrician or competent person.

## Use

- This appliance is designed for domestic use. It must not be used for purposes other than those for which it was designed.
- Only wash and dry fabrics which are designed to be machine washed. Follow the instructions on each garment label.
- Do not overload the appliance. See the relevant section in the user manual.
- Before washing, ensure that all pockets are empty and buttons and zips are fastened. Avoid washing frayed or torn articles and treat stains such as paint, ink, rust, and grass before washing. Underwired bras must NOT be machine washed.
- Garments which have been in contact with volatile petroleum products should not be machine washed. If volatile cleaning fluids are used, care should be taken to ensure that the fluid is removed from the garment before placing in the machine.

- As some duvets and eiderdowns should be washed/dried in large commercial machines because of their bulk, please check with the manufacturer of the item before washing in a domestic machine.
- The users should always check that they have not left their gas lighters (disposable or otherwise) in their clothing.
- Never dry items that have had contact with chemicals such as dry cleaning fluid. These are of a volatile nature and could cause an explosion. Only dry items which have been washed in water or require airing.
- Plastic detergent dispensers should not remain in the drum during the drying cycle, as the plastic used is not designed to withstand the heat. If you wish to wash-through-to-dry you should use the conventional detergent dispenser drawer.
- Never pull the power supply cable to remove the plug from the socket; always take hold of the plug itself.
- Never use the washer-dryer if the power supply cable, the control panel, the working surface or the base are damaged so that the inside of the washer-dryer is accessible.

## Child Safety

- This appliance is not intended for use by persons (including children) with reduced physical sensory or mental capabilities or lack of experience and knowledge unless they have been given supervision or instruction concerning use of the appliance by a person responsible for their safety.
- This washer-dryer is not intended for use by young children or infirm persons without supervision.
- Young children should be supervised to ensure that they do not play with the appliance.
- The packaging components (e.g. plastic film, polystyrene) can be dangerous to children - danger of suffocation! Keep them out of children's reach.
- Keep all detergents in a safe place out of children's reach.
- Make sure that children or pets do not climb into the drum. To avoid that they could remain closed inside the drum, the machine incorporates special feature. To activate this device, rotate the button (without pressing it) inside the door clockwise until the groove is horizontal. If necessary use a coin. To disable this device and restore the possibility of closing the door, rotate the button anti-clockwise until the groove is vertical.

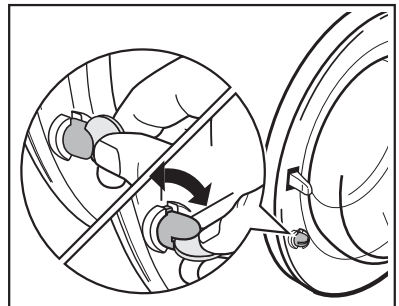



## Product description

Your new appliance meets all modern requirements for effective treatment of laundry with low water, energy and detergent consumption.

The **ECO valve** system allows total use of detergent and reduces water consumption so saving energy.

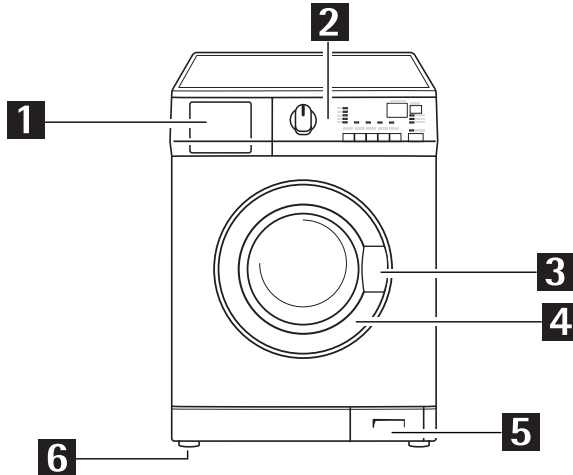

**1** Detergent dispenser drawer

**2** Control panel

**3** Door opening handle

**4** Rating plate



**5** Drain pump

**6** Adjustable feet

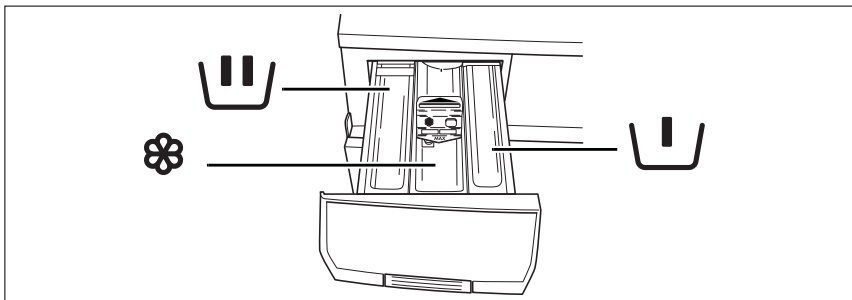
## Detergent dispenser drawer



 Compartment for detergent or stain remover used for **prewash** or **STAIN-Action phase**. The prewash detergent is added at the beginning of the wash programme. The stain remover is added during the **STAIN-Action phase**.

-  Compartment for powder or liquid detergent used for **main wash**.
-  Compartment for **liquid additives** (fabric softener, starch).

## Control panel

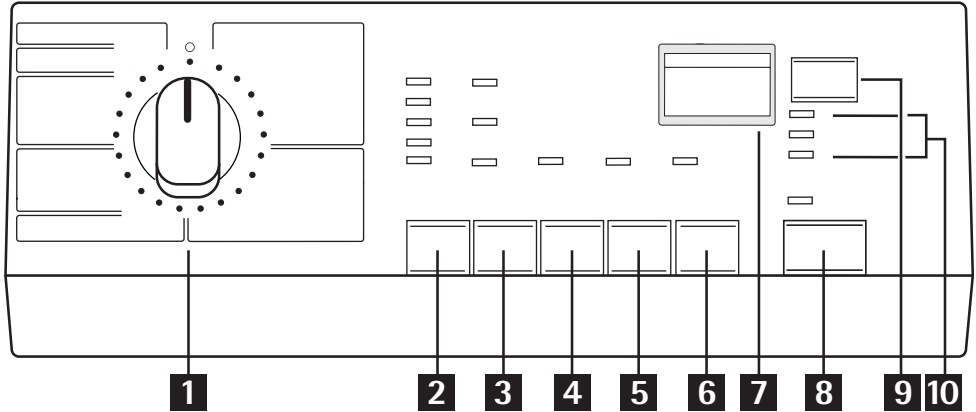

**i** The control panel is illustrated above. It shows the programme selector dial as well as the different buttons, the pilot lights and the display. These are represented by relevant numbers which are explained in the table below.

- 1** Programme selector dial
- 2** SPIN reduction button
- 3** AUTODRY button
- 4** DRYING TIME button
- 5** STAIN button
- 6** TIME button
- 7** Display
- 8** START/PAUSE button
- 9** DELAY START button
- 10** Indicator pilot lights

### Symbols key:

-  = Hand wash
-  = Rinse hold
-  = Extra dry
-  = Store dry
-  = Iron dry
-  = Cold

## Display (7)

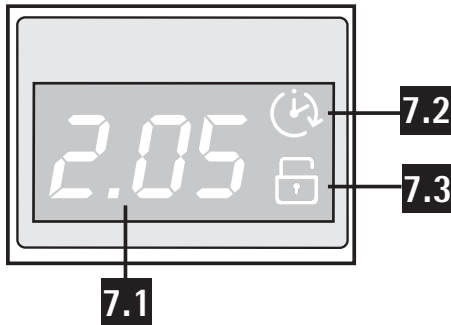

### 7.1 Duration of selected programme:

After selecting a programme, the duration is displayed in hours and minutes (for example **2.05**). The duration is calculated automatically on the basis of the maximum recommended load for each type of fabric. After the programme has started, the time remaining is updated every minute.

### Selected drying time

After selecting a drying programme, the drying time is displayed in minutes and/or hours (see paragraph «Drying only»).

After the programme has started the time remaining is updated every minute.

### Alarm codes

In the event of operating problems, some alarm codes can be displayed, for example **E20** (see chapter «What to do if...»).

### End of programme

When the programme has finished a blinking zero **0** is displayed, the FUNCTIONING pilot light (**10.1**) and the pilot light of button **8** go out and the door can be opened.

### Incorrect option selection

If an option which is not compatible with the set wash programme is selected, the message **Err** is displayed for a few seconds and the yellow pilot light of button **8** light starts blinking.

## 7.2 Delay Start (7.2)

The selected delay (20 hours max) set by means of the relevant button appears on the display for about 3 seconds, then the duration of the previously selected programme is displayed.

The symbol **7.2** will appear on the display. The delay time value decreases by one unit every hour. When only 1 hour remains, the time decreases every minute.

## 7.3 Child safety lock (7.3)

 If your laundry is not removed during 10 minutes after the programme is finished, the backlight of the display switches off and the energy saving system will be enabled.

Only the pilot light of the button **8** is blinking to indicate that the appliance has to be switched off.

By pressing any buttons the appliance will come out from the energy saving status and you could set another washing programme or switch off the appliance.



## Indicator pilot lights (10)

When selecting a washing programme, the WASHING pilot light (**10.1**) illuminates.

When selecting a drying programme the DRY pilot light (**10.2**) illuminates and stays on during the drying phase.

When the appliance is performing additional rinses the EXTRA RINSE pilot light (**10.3**) is on. To add an additional rinse, please see chapter «Select an additional rinse».

## First Use

-  Ensure that the electrical and water connections comply with the installation instructions.
-  Remove the polystyrene block and any material from the drum.
-  Pour 2 litres of water into the main wash compartment **III** of the detergent drawer in order to activate the ECO valve. Then run a cotton cycle at 90° or 95°C, without any laundry in the machine, to remove any manufacturing residue from the drum and tub. Pour 1/2 a measure of detergent into the main wash compartment and start the machine.

## Personalization

### Acoustic signals

The machine is provided with the acoustic device, which sounds in the following cases:

- at the end of the cycle
- in the event of operating problems

By pressing the **3** and **4** buttons simultaneously for about 6 seconds, the acoustic signal is deactivated (except for the events of operating problems).

By pressing the same buttons again, the acoustic signal is reactivated.

### Child safety lock

This device permits you to leave the appliance unsupervised without having the worry that children might be injured by or cause damage to the appliance.

This function remains able also when the washer-dryer is not working.

There are two different ways to set this option:

- before pressing button **8**: it will be impossible to start the machine.
- after pressing button **8** it will be impossible to change any other programme or option.

To enable (disable) this option press simultaneously for about 6 seconds **4** and **5** buttons until the **7.3** symbol appears (disappears) on (from) the display.

## Daily Use

### Load the laundry

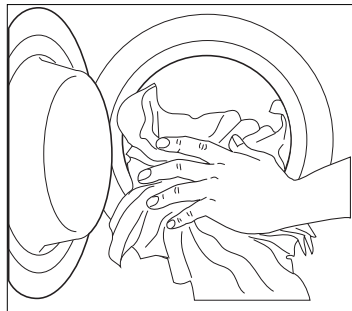

1. Open the door by carefully pulling the door handle outwards. Place the laundry in the drum, one item at a time, shaking them out as much as possible.
2. Close firmly the door. You must hear a click during closing.

**Attention!** Do not embed the laundry between the door and the rubber joint.



### Measure out the detergent and the fabric softener

Your new appliance was designed to reduce water, energy and detergent consumption.

1. Pull out the dispenser drawer until it stops. Measure out the amount of detergent required, pour it into the main wash compartment  and, if you wish to carry out the **prewash** phase or **STAIN** action, pour the detergent or the stain remover into the compartment marked .
2. If required, pour fabric softener into the compartment marked  (the amount used must not exceed the **MAX** mark in the drawer). Close the drawer gently.

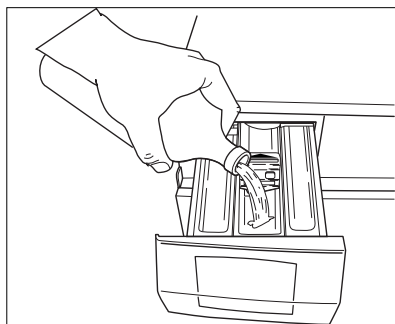
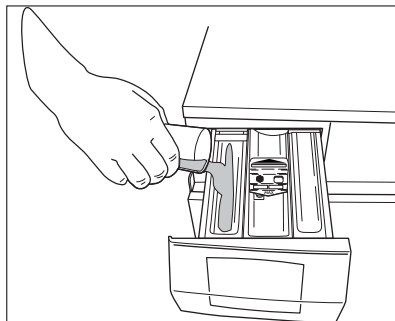

## WASHING

### Select the required programme by turning the programme selector dial (1)

You can choose the right programme for any type of laundry following the descriptions on the washing programme tables (see «Washing Programmes»).

Turn the programme selector dial to the required programme. The programme selector determines the type of washing cycle (e.g. water level, drum movement,

number of rinses) and the washing temperature according to the type of laundry. The pilot light of button **8** starts blinking and the display shows the duration of the selected programme.

The selector dial can be turned either clockwise or anticlockwise. Position **0** corresponds to Reset programme/Switching OFF of the machine.

**At the end of the programme the selector dial must be turned to position **0**, to switch the machine off.**

 For the description of each washing programmes of the selector dial, consult the chapter «Washing programmes».

### **Attention!**

If you turn the programme selector dial to another programme when the machine is working, the yellow pilot light of button **8** will blink 3 times and the message **Err** is displayed on the display to indicate a wrong selection. The machine will not perform the new selected programme.

## Select the SPIN speed or RINSE HOLD option by pressing button 2

When the required programme has been selected, your appliance automatically proposes the maximum spin speed provided for that programme.

Press this button repeatedly to change the spin speed, if you want your laundry to be spun at a speed different from the one proposed by the washer-dryer.

**RINSE HOLD:** by selecting this option the water of the last rinse is not emptied out to prevent the fabrics from creasing. At the end of the programme, a blinking «**0**» is displayed, the light of the Rinse Hold option is on, the pilot lights **10.1** and the pilot light of button **8** go off and the door is locked to indicate that the water must be emptied out.

 RINSE HOLD is not selectable with a NON -STOP programme (see Drying section).

**To empty out the water, please read chapter «At the end of the programme».**

## Programme option buttons

Depending on the programme, different functions can be combined. These must be selected after choosing the desired programme and before pressing button **8**.

When these buttons are pressed, the corresponding pilot lights come on. When they are pressed again, the pilot lights go out.

If an incorrect option is selected, the yellow pilot light of the button **8** flashes for 3 times and the **Err** message appears on the display for some seconds.

 For the compatibility between this option and washing programmes consult the chapter «Washing programmes».

## STAIN option by pressing button 5

Select this option to treat heavily soiled or stained laundry with stain remover (extended main wash with time optimised stain action phase).

This option **is not** available with a temperature lower than 40°C.

**Attention!** If you wish to perform a programme with the stain option, pour stain remover into compartment . STAIN option is not selectable with a prewash phase.

## Select the TIME option by pressing button 6

This option allows you to modify the washing time, automatically proposed by the washer-dryer.

DAILY: by pressing this button once, the corresponding pilot light illuminates and the washing duration will be reduced to wash daily soiled laundry.

SUPER QUICK: by pressing this button twice, the corresponding pilot light remains lit, the washing duration will be reduced to wash lightly soiled laundry or items that have been used or worn for a short time. On the display will be visualized the decreased washing time.

## Select an additional rinse (EXTRA RINSE)

This appliance is designed for saving water. However, for people with a very delicate skin (allergic to detergents) it may be necessary to rinse the laundry using an extra quantity of water (extra rinse).



If you wish to activate this option permanently for every washing cycle, depress simultaneously **2** and **3** for some seconds: the pilot light **10.3** illuminates.

This function stays permanently on. To remove it press the same buttons again until the pilot light **10.3** goes off.

## Select the START/PAUSE by pressing button 8

To start the selected programme, press this button, the corresponding red pilot light stops blinking. The pilot light **10.1** or **10.2** is on to indicate that the appliance is operating.

To interrupt a programme which is running, press button **8**: the corresponding red pilot light starts blinking.

To restart the programme from the point at which it was interrupted, **press** button **8** **again**. If you have chosen a delayed start, the machine will begin the countdown. If an incorrect option is selected, the yellow pilot light of the button **8** blinks for 3 times the message **Err** is displayed for a few seconds.



## Select the DELAY START by pressing button 9

**Before you start the programme**, if you wish to delay the start, press button **9** repeatedly, to select the desired delay. The corresponding symbol will appear on the display.

The washing programme can be delayed from 30 min - 60 min - 90 min, 2 hours and then by 1 hour up to a maximum of 20 hours by pressing this button.

The selected delay time value will appear on the display for a few seconds, then the duration of the programme will appear again.

You must select this option after you have set the programme and before you press button **8**. You can modify or cancel the delay time at any moment, before you press this button.

If you wish to add laundry in the machine during the delay time, press button **8** to set the machine to pause. After a few minutes the door can be opened. Add the laundry, close the door and press button **8** again.

### SELECTING THE DELAYED START:

- Select the programme and the required options;
- Select the delay start;
- Press button **8**: the machine starts its hourly countdown. The programme will start after the selected delay has expired.

### CANCELLING THE DELAYED START AFTER HAVING STARTED THE PROGRAMME

- set the washing machine to PAUSE by pressing button **8**;
- press button **9** once until the symbol **U'** is displayed;
- press button **8** again to start the programme.

### Important!

The Delay start cannot be selected with DRAIN programme.

## Altering an option or a running programme

It is possible to change some option before the programme carries it out. Before you make any change, you must pause the machine by pressing the button **8**. Changing a running programme is possible **only by resetting it**. Turn the programme selector dial to **○** and then to the new programme position. Start the new programme by depressing button **8** again. The washing water in the tub will be not emptied out.

## Interrupting a programme

Press button **8** to interrupt a programme which is running, the corresponding light starts blinking. Press this button again to restart the programme.

## Cancelling a programme

Turn the selector dial to  to cancel a programme which is running. Now you can select a new programme.

## Opening the door after the programme has started

First set the machine to pause by pressing button **8**. After a few minutes the door can be opened.

If the door remains locked, this means that the machine is already heating or that the water level is too high.



If you cannot open the door but you need to open it you have to switch the machine off by turning the selector dial to . After a few minutes the door can be opened (**pay attention to the water level and temperature!**). After closing the door, it is necessary to select the programme and options again and to press button **8**.

## At the end of the programme

The machine stops automatically, the pilot light of button **8**, the pilot light **10.1** or **10.2** go off and a blinking  will appear on the display. Some acoustic signals sound. The door can be opened.

If a programme or an option that ends with water still in the tub has been selected, the light of the Rinse Hold option is lit and the the door remains locked to indicate that the water must be emptied out before opening the door.

Obey the instructions below to empty out the water:

- turn the programme selector dial to 
- select the DRAIN or SPIN programme
- reduce the spin speed if needed, by pressing the relevant button
- press button **8**
- when the programme has finished the display shows a blinking . The door can now be opened.

Turn the programme selector dial to  to switch the machine off. Remove the laundry from the drum and carefully check that the drum is empty. If you do not intend to carry out another wash, close the water tap. Leave the door open to prevent the formation of mildew and unpleasant smells.

## DRYING only

The recommended loads size is 3 kg for cottons and linen, and 2 kg for synthetics (Easy Cares).

**Note!** Only with the timed drying, it is possible also to dry up to 4 kg of cotton items (see the drying time table). The water tap must be open and the drain hose must be positioned in the sink or connected to the drain pipe.

### Select the drying programme by turning the programme selector dial (1)

Turn the programme selector dial to the required programme for Cottons or Synthetics in the Drying sector. The pilot light **10.2** illuminates.

### Select the automatic drying by pressing button 3

With this button you can select the degree of dryness by an electronic drying. The machine adapts automatically the duration of the drying cycle to the selected degree of dryness. The light corresponding to the selected degree illuminates. The display shows the drying cycle duration, calculated by the appliance. The pilot light of button **8** starts blinking. Press then button **8** to start the programme. After the programme has started, the time remaining is updated every minute.

### Select the timed drying by pressing button 4

With this button is possible to select the duration of the drying cycle according to the type of fabric (cotton or synthetic). Press button **4**, until the time you want appears on the display. For **Cottons** you can select a drying time from 10 minutes to 250 minutes (**4.10**). For **Synthetics** you can select a drying time from 10 minutes to 130 minutes (**2.10**). Every time you press this button the drying time increases by 5 mins. Press then button **8** to start the programme. The selected drying time on the display decreases by one unit every minute.



#### **Note!**

The programme time will automatically increase by up to 2 minutes, this is quite normal.





**Note!** The different type of cottons (towelling, sheets, shirts, and so on) or eventual laundry rolling up during spinning phase may cause a not uniform dryness. So, in the exceptional case that at the end of the cycle the laundry remains slightly wet, we suggest you to stretch the items rolled up out, to redistribute evenly the laundry in the drum and to select an additional drying cycle of 20-30 minutes.

## At the end of the programme

At the end of the drying programme, some acoustic signals sound. A blinking «» appears on the display and the pilot light **10.2** and the light of the button **8** go off. At this point, begins an anti-crease phase which lasts about 10 minutes. During this time the door is locked.



### Note!

If you wish to open the door before or during the anti-crease phase or to interrupt it, press any button or turn the programme selector dial to any programme position (except «»), in a few minutes the door can be opened. Turn the selector dial to the «» position to switch the machine off. Remove the laundry.

## Automatic washing and drying (NON-STOP programme)

For NON-STOP programmes, the recommended load size is 3 kg for cotton and 2 kg for synthetics (Easy Cares).

**Note! Only with the timed drying, it is possible also to dry up to 4 kg of cotton items (see the drying time table).** Do not use a dosing device/ball when carrying out a washing and drying programme.

## Select the washing and the drying programme by turning the programme selector dial (1) and buttons 3 and 4

Switch the machine on by turning the selector dial to the selected washing programme/temperature and press the buttons corresponding to the required options. When selecting an «autodrying programme» the pilot lights **10.1** and **10.2** illuminate. If you press button **3**, the display shows the entire duration of the washing and the selected drying cycle. If you press button **4** the DRYING TIME value appears on the display for a few seconds, then the entire duration of the washing and drying cycle appears again.



If possible, do not select a spin speed lower than that proposed by the appliance to avoid a too long drying time so saving energy.

**In any case the reduction of the spin speed is only possible after selecting drying.** The lowest values you can select are the following: with automatic drying 900 r.p.m. for cottons and synthetics; with timed drying 900 r.p.m. for cottons and 700 r.p.m. for synthetics. Select the drying time or dryness degree suitable to your laundry and start the programme by pressing button **8**. **At the end of the programme, follow the instructions given in the corresponding previous chapter.**

## Washing programmes

Programme/ Temperature	Type of laundry	Options	Description of the programme
<b>COTTON / LINEN</b> <b>95° - 60°</b>	<b>White cotton</b> (normally soiled cotton items)	SPIN REDUCTION/ RINSE HOLD TIME (**), STAIN, EXTRA RINSE	Main wash, Rinses Long spin at maximum speed Max Load: Kg 6 **Reduced Load: Kg 3
<b>40 ECO</b> <b>40°</b>	<b>White and coloured cotton or mixed fabrics</b> normally soiled	SPIN REDUCTION/ RINSE HOLD, STAIN, EXTRA RINSE	Main wash, Rinses Long spin at maximum speed Max Load: Kg 6
<b>COTTON COLOUR</b> <b>60° - 40° - 30°</b>	<b>White and coloured cotton</b> (normally soiled cotton items)	SPIN REDUCTION/ RINSE HOLD TIME (**), STAIN (*), EXTRA RINSE	Main wash, Rinses Long spin at maximum speed Max Load: Kg 6 **Reduced Load: Kg 3
<b>COTTON + PREWASHING</b> <b>95° - 60° - 40°</b>	<b>White and cotton colour</b> (heavily soiled cotton items)	SPIN REDUCTION/ RINSE HOLD TIME (**), EXTRA RINSE	Prewash, Main wash, Rinses Long spin at maximum speed Max Load Kg 6 **Reduced Load: Kg 3
<b>EASY-CARES (Synthetics)</b> <b>60° - 50° - 40° - 30°</b>	<b>Synthetic or mixed fabrics</b>	SPIN REDUCTION/ RINSE HOLD TIME (**), STAIN (*), EXTRA RINSE	Main wash Rinses Short spin Max Load Kg 3 **Reduced Load: Kg 1.5
<b>EASY IRON PLUS</b> <b>40°</b>	<b>Synthetic or mixed fabrics</b> to be ironed	SPIN REDUCTION/ RINSE HOLD EXTRA RINSE	Main wash Rinses Short spin Max Load Kg 1



\* Stain option can be selected only at the temperature of 40°C or higher.

\*\* If you select the SUPER QUICK option by pressing the button **6** we recommend you to reduce the maximum load as indicated in the table above. Full loading possible however with somewhat reduced cleaning results.

## Washing programmes

Programme/ Temperature	Type of laundry	Options	Description of the programme
<b>DELICATES</b> 40° – 30°	<b>Delicate fabrics:</b> for example curtains	SPIN REDUCTION/ RINSE HOLD TIME (**), STAIN(*), EXTRA RINSE	Main wash Rinses Short spin Max Load Kg 3 ** Red. Load Kg 1.5
<b>WOOL PLUS</b>  30° – Cold	Garments bearing the «Pure new wool, non-shrink, machine washable» or «Handwash» label	SPIN REDUCTION/ RINSE HOLD	Main wash Rinses Short spin Max Load Kg 2
<b>DELICATE RINSES</b>	Separate rinse cycle for hand washed items	SPIN REDUCTION/ RINSE HOLD EXTRA RINSE	Rinses Short spin Max Load Kg 6
<b>DRAIN</b>	For emptying out the water		Drain Max Load Kg 6
<b>SPIN</b>	Separate spin for cottons	SPIN REDUCTION	Drain and long spin at maximum speed Max Load Kg 6
<b>SUPERQUICK</b> 30°	For slightly soiled fabrics, except wool	SPIN REDUCTION	Main wash Rinses Short spin Max Load Kg 2
<b>ECONOMY</b> 60°	<b>White and fast coloured cotton – economy,</b> lightly-normally soiled items	SPIN REDUCTION/ RINSE HOLD STAIN, EXTRA RINSE	Main wash Rinses Long spin at maximum speed Max Load Kg 6
<b>O/OFF</b>	For cancelling the programme which is running or to switch the machine off		

## Programme information

<b>40 ECO</b>	Special programme for white and coloured cotton suitable for different washing temperatures. This programme can be used for laundry, which should be washed at 40°C or 60°C separately. So, you can put into the drum the maximum load capacity in order to save energy and water. You will obtain the same good washing result as a normal programme at 60°C.
<b>EASY IRON PLUS</b>	Selecting this programme the laundry is gently washed and spun to avoid any creasing. In this way ironing is easier. Furthermore the machine will perform additional rinses.
<b>WOOL/ SILK HANDWASH</b>	Washing programme for machine washable wool as well as for hand washable woollens and delicate fabrics with the «hand washing» care symbol  .
<b>SUPERQUICK</b>	Special program at 30°C, duration - approx. 30 minutes, ideal for laundry to be refreshed: e.g. a sport jacket worn only once or slightly soiled or new garments.
<b>ECONOMY</b>	This programme can be selected for slightly or normally soiled cotton items. The temperature will decrease and the washing time will be extended. This allows to obtain a good washing efficiency by saving energy.
<b>DELICATE RINSES</b>	With this programme it is possible to rinse and spin garments which have been washed by hand. The machine performs 3 rinses, followed by a final short spin. The spin speed can be reduced by relevant button.
<b>DRAIN</b>	For emptying out the water of the last rinse in programmes with the RINSE HOLD option. Before selecting this programme the selector dial must be turned to  .
<b>SPIN</b>	Separate spin for hand washed cotton items and after programmes with the RINSE HOLD option. Before selecting this programme the selector dial must be turned to  . You can choose the speed by pressing the relevant button to adapt it to the fabrics to be spun.

## Automatic drying programmes

Degree of drying	Type of fabric	Max Load
<b>Extra dry</b> Ideal for towelling materials	<b>Cotton and linen</b> (bathrobes, bath towels, etc)	3 kg
<b>Store dry</b> Suitable for items to put away without ironing	<b>Cotton and linen</b> (bathrobes, bath towels, etc)	3 kg
	<b>Synthetics (Easy Cares) and mixed fabrics</b> (jumpers, blouses, underwear, household linen)	2 kg
<b>Iron dry</b> Suitable for ironing	<b>Cotton and linen</b> (sheets, tablecloths, shirts, etc.)	3 kg

## Drying time

Degree of drying	Type of fabric	Max load	Spin Speed	Suggested drying time in mins	
<b>Suitable for items to put away without ironing</b>	<b>Cotton and linen</b> (bathrobes, bath towels, etc)	4 kg	<b>1200</b>	150 - 170	
			<b>1400</b>	140 - 160	
		3 kg	<b>1200</b>	85 - 95	
			<b>1400</b>	80 - 90	
		1.5 kg	<b>1200</b>	45 - 55	
			<b>1400</b>	40 - 50	
<b>Suitable for ironing</b>	<b>Synthetics (Easy Cares) and mixed fabrics</b>	2 kg	<b>900</b>	65 - 75	
			<b>900</b>	30 - 40	
		<b>Cotton and linen</b> (sheets, tablecloths, shirts, etc.)	4 kg	<b>1200</b>	120 - 140
				<b>1400</b>	110 - 130
			3 kg	<b>1200</b>	70 - 80
				<b>1400</b>	65 - 75
1.5 kg	<b>1200</b>		40 - 50		
	<b>1400</b>		35 - 45		

**In compliance with EC directive EN 50229** the cotton reference programme for the data entered in the Energy Label must be tested dividing the maximum washing load by two equal parts and drying with TIMED DRYING each of them.



## Preparing the wash cycle

### Sorting out the laundry

Follow the wash code symbols on each garment label and the manufacturer's washing instructions. Sort the laundry as follows: whites, coloureds, synthetics, delicates, woollens.

### Temperatures

<b>95° or 90°</b>	for normally soiled white cottons and linen (e.g. tea cloths, towels, tablecloths, sheets...).
<b>60°/50°</b>	for normally soiled, colour fast garments (e.g. shirts, night dresses, pyjamas...) in linen, cotton or synthetic fibres and for lightly soiled white cotton (e.g. underwear).
<b>40°-30°- Cold</b>	for delicate items (e.g. net curtains), mixed laundry including synthetic fibres and woollens bearing the label «pure new wool, machine washable, non-shrink».

### Before loading the laundry

Never wash whites and coloureds together. Whites may lose their "whiteness" in the wash.

New coloured items may run in the first wash; they should therefore be washed separately the first time.

**Make sure that no metal objects are left in the laundry (e.g. hair clips, safety pins, pins).**

Button up pillowcases, close zip fasteners, hooks and poppers. Tie any belts or long tapes.

Remove persistent stains before washing.

Rub particularly soiled areas with a special detergent or detergent paste.

Treat curtains with special care. Remove hooks or tie them up in a bag or net.

### Maximum loads

Recommended loads are indicated in the washing programme charts.

General rules:

**Cotton, linen:** drum full but not too tightly packed;

**Synthetics:** drum no more than half full;

**Delicate fabrics and woollens:** drum no more than one third full.

Washing a maximum load makes the most efficient use of water and energy.

For heavily soiled laundry, reduce the load size.

Washing a maximum load makes the most efficient use of water and energy. For heavily soiled laundry, reduce the load size.

## Laundry weights

The following weights are indicative:

bathrobe	1200 g
napkin	100 g
quilt cover	700 g
sheet	500 g
pillow case	200 g
tablecloth	250 g
towelling towel	200 g
tea cloth	100 g
night dress	200 g
ladies' briefs	100 g
man's work shirt	600 g
man's shirt	200 g
man's pyjamas	500 g
blouse	100 g
men's underpants	100 g

## Removing stains

Stubborn stains may not be removed by just water and detergent. It is therefore advisable to treat them prior to washing.

**Blood:** treat fresh stains with cold water. For dried stains, soak overnight in water with a special detergent then rub in the soap and water.

**Oil based paint:** moisten with benzine stain remover, lay the garment on a soft cloth and dab the stain; treat several times.

**Dried grease stains:** moisten with turpentine, lay the garment on a soft surface and dab the stain with the fingertips and a cotton cloth.

**Rust:** oxalic acid dissolved in hot water or a rust removing product used cold. Be careful with rust stains which are not recent since the cellulose structure will already have been damaged and the fabric tends to hole.

**Mould stains:** treat with bleach, rinse well (whites and fast coloureds only).

**Grass:** soap lightly and treat with bleach (whites and fast coloureds only).

**Ball point pen and glue:** moisten with acetone (\*), lay the garment on a soft cloth and dab the stain.

**Lipstick:** moisten with acetone as above, then treat stains with methylated spirits. Treat any residual marks with bleach.

**Red wine:** soak in water and detergent, rinse and treat with acetic or citric acid, then rinse. Treat any residual marks with bleach.

**Ink:** depending on the type of ink, moisten the fabric first with acetone (\*), then with acetic acid; treat any residual marks on white fabrics with bleach and then rinse thoroughly.

**Tar stains:** first treat with stain remover, methylated spirits or benzine, then rub with detergent paste.

(\*) do not use acetone on artificial silk.

## Detergents and additives

Good washing results also depend on the choice of detergent and use of the correct quantities to avoid waste and protect the environment.

Although biodegradable, detergents contain substances which, in large quantities, can upset the delicate balance of nature.

The choice of detergent will depend on the type of fabric (delicates, woollens, cottons, etc.), the colour, washing temperature and degree of soiling.

All commonly available washer-dryer detergents may be used in this appliance:

- powder detergents for all types of fabric,
- powder detergents for delicate fabrics (60°C max) and woollens,
- liquid detergents, preferably for low temperature wash programmes (60°C max) for all types of fabric, or special for woollens only.

The detergent and any additives must be placed in the appropriate compartments of the dispenser drawer before starting the wash programme.

If using concentrated powder or liquid detergents, a programme **without** prewash must be selected.

The washer-dryer incorporates a recirculation system which allows an optimal use of the concentrated detergent.

Pour liquid detergent into the dispenser drawer compartment marked  **just before** starting the programme.

Any fabric softener or starching additives must be poured into the compartment marked  before starting the wash programme.

Follow the product manufacturers' recommendations on quantities to use and **do not exceed the «MAX» mark in the detergent dispenser drawer.**

## Quantity of detergent to be used

The type and quantity of detergent will depend on the type of fabric, load size,

degree of soiling and hardness of the water used.

Follow the product manufacturers' instructions on quantities to use.

Use less detergent if:

- you are washing a small load,
- the laundry is lightly soiled,
- large amounts of foam form during washing. For the stain treatment before the washing cycle, follow the product manufacturers' instructions on detergent quantities. If you use any specific product to remove the stains, you must start the cycle of washing immediately .

## Degrees of water hardness

Water hardness is classified in so-called "degrees" of hardness. Information on hardness of the water in your area can be obtained from the relevant water supply company, or from your local authority.

Level	Characteristic	Degrees of water hardness	
		German °dH	French °T.H.
1	soft	0-7	0-15
2	medium	8-14	16-25
3	hard	15-21	26-37
4	very hard	> 21	> 37

**Note:** A water softener must be added when water has a medium-high degree of hardness (from degree of hardness II). Follow the manufacturer's instructions. The quantity of detergent can then always be adjusted to degree of hardness I (= soft).

## Preparing the drying cycle

As a dryer, the machine works on the condensation principle.

**Therefore, the water tap must be open and the drain hose must drain water into a sink or into the drain pipe, even during the drying cycle.**

Attention!

Before starting the drying programme, reduce the loads of washed laundry, in order to obtain good performances.

## Laundry not suitable for drying

- Particularly delicate items such as synthetic curtains, woollen and silk, garments with metal inserts, nylon stockings, bulky garments such as anoraks, bedcovers, quilts, sleeping bags and duvets must not be machine dried.

- Avoid drying dark clothes with light coloured fluffy items such as towels as these can attract the fluff.
- Remove the laundry when the appliance has finished drying.
- To avoid a static charge when drying is completed, use either a fabric softener when you are washing the laundry or a fabric conditioner specifically for tumble dryers.
- Garments padded with foam-rubber or materials similar to foam-rubber must not be machine dried; they represent a fire hazard.
- Also, fabrics containing residues of setting lotions or hair sprays, nail solvents or similar solutions must not be machine dried in order to avoid the formation of harmful vapours.

## Garment's labels

For drying, follow the indications given on the manufacturer's labels:

- May be tumble dried
- Drying at high temperature
- Drying at reduced temperature
- Do not tumble dry.

## Drying cycle duration

The drying time may vary depending on:

- speed of the final spin
- dryness degree required (extra dry, iron dry, store dry)
- type of laundry
- weight of the load size

The average drying time for a timed drying are indicated in the «Drying programmes» chapter. The experience will help you to dry your laundry in a more suitable way, according to the different fabrics. Take note of the duration drying time of the already performed cycles.

## Additional drying

If the laundry is still damp at the end of the drying programme, select again a short drying.



**Attention! Do not over dry the laundry in order to avoid creasing of fabrics or garment's shrinking .**

## Care and cleaning

You must DISCONNECT the appliance from the electricity supply, before you can carry out any cleaning or maintenance work.

### Descaling

The water we use normally contains lime. It is a good idea to periodically use a water softening powder in the machine. Do this separately from any laundry washing, and according to the softening powder manufacturer's instructions.

This will help to prevent the formation of lime deposits.

### After each wash

Leave the door open for a while. This helps to prevent mould and stagnant smells forming inside the appliance. Keeping the door open after a wash will also help to preserve the door seal.

### Maintenance wash

With the use of low temperature washes it is possible to get a build up of residues inside the drum.

We recommend that a maintenance wash be performed on a regular basis.

To run a maintenance wash:

- The drum should be empty of laundry.
- Select the hottest cotton wash programme.
- Use a normal measure of detergent, must be a powder with biological properties.

### External cleaning

Clean the exterior cabinet of the appliance with soap and water only, and then dry thoroughly.

**Important!** Do not use methylated spirits, solvents or similar products to clean the cabinet.

### Detergent dispenser drawer

The detergent dispenser drawer should be cleaned regularly.

1. Remove the detergent dispenser drawer by pulling it firmly.

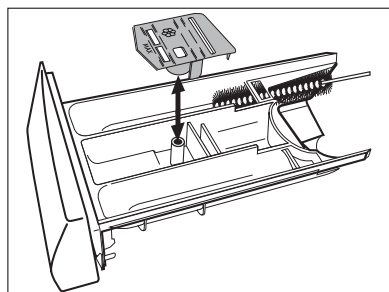

2. Remove the conditioner insert from the middle compartment.
3. Clean all parts with water.
4. Put the conditioner insert in as far as it will go, so that it is firmly in place.
5. Clean all parts of the washing machine, especially the nozzles in the top of the washing-in chamber, with a brush.
6. Insert the detergent dispenser drawer in the guide rails and push it in.

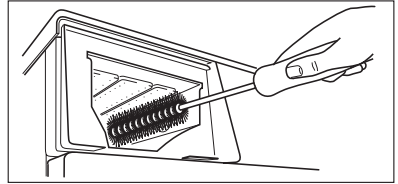

## Washing drum

Rust deposits in the drum may occur due to rusting foreign bodies in the washing or tap water containing iron.

**Important!** Do not clean the drum with acidic descaling agents, scouring agents containing chlorine or iron or steel wool.

1. Remove any rust deposits on the drum with a cleaning agent for stainless steel.
2. Run a washing cycle without any washing to clean off any cleaning agent residues. Programme: COTTONS/LINEN 90° or 95°C, press button **8**, add approx. 1/4 measuring cup of detergent.

## Door seal

Check from time to time the door seal and eliminate eventual possible objects that could be trapped in the fold.

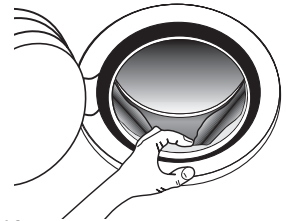

## Drain pump

The pump should be inspected regularly and particularly if

- the machine does not empty and/or spin
- the machine makes an unusual noise during draining due to objects such as safety pins, coins etc. blocking the pump.

Proceed as follows:

1. Disconnect the appliance.
2. If necessary wait until the water has cooled down.
3. Open the pump door.

4. Place a container close to the pump to collect any spillage.

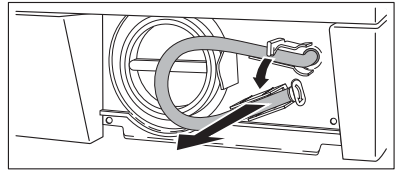
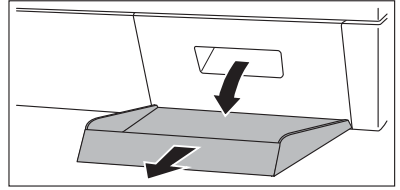

5. Release the emergency emptying hose, place it in the container and remove its cap.

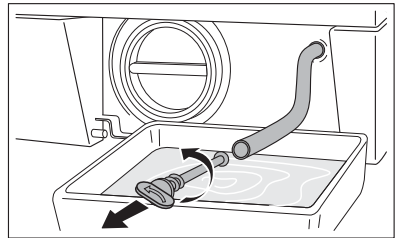

6. When no more water comes out, unscrew the pump and remove it. Always keep a rag nearby to dry up spillage of water when removing the pump.

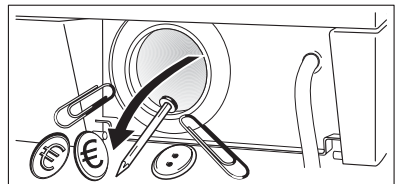
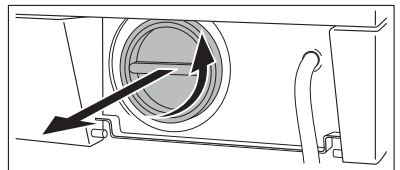



7. Remove any objects from the pump impeller by rotating it.

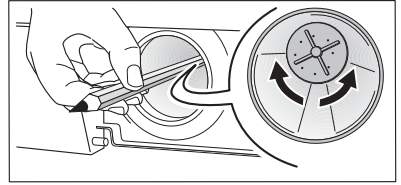

8. Put the cap back on the emergency emptying hose and place the latter back in its seat.
9. Screw the pump fully in.
10. Close the pump door.

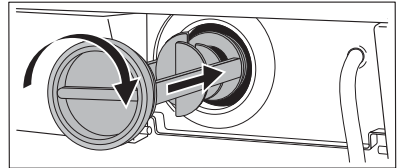

### Warning!

When the appliance is in use and depending on the programme selected there can be hot water in the pump. Never remove the pump cover during a wash cycle, always wait until the appliance has finished the cycle, and is empty. When replacing the cover, ensure it is securely retightened so as to stop leaks and young children being able to remove it.

## Water inlet filter

If you notice that the machine is taking longer to fill, check that the filter in the water inlet hose is not blocked.

1. Turn off the water tap.
2. Unscrew the hose from the tap.
3. Clean the filter in the hose with a stiff brush.
4. Screw the hose back onto the tap.

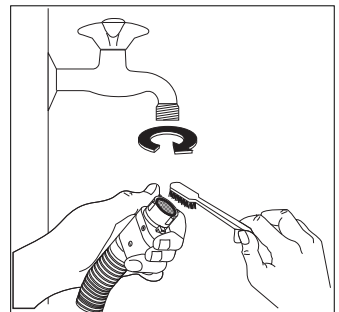

## Frost precautions

If the machine is installed in a place where the temperature could drop below 0°C, proceed as follows:

1. Close the water tap and unscrew the water inlet hose from the tap.
2. Place the end of the emergency emptying hose and that of the inlet hose in a bowl placed on the floor and let water drain out.
3. Screw the water inlet hose back on and reposition the emergency emptying hose after having put the cap on again.

By doing this, any water remaining in the machine is removed, avoiding ice forming and consequently damage to the appliance.

When you use the machine again, make sure that the ambient temperature is above 0°C.

**Important!** Every time you drain the water through the emergency emptying hose you must pour 2 litres of water into the main wash compartment of the detergent drawer and then run the drain programme. This will activate the ECO VALVE device avoiding that part of the detergent remains unused at next washing.

## Emergency emptying out

If the water is not discharged, proceed as follows to empty out the machine:

1. pull out the plug from the power socket;
2. close the water tap;
3. if necessary, wait until the water has cooled down;
4. open the pump door;
5. place a bowl on the floor and place the end of the emergency emptying hose into the bowl. Remove its cap. The water should drain by gravity into the bowl. When the bowl is full, put the cap back on the hose. Empty the bowl. Repeat the procedure until water stops flowing out;
6. clean the pump if necessary as previously described;
7. replace the emergency emptying hose in its seat after having plugged it;
8. screw the pump again and close the door.

## What to do if...

Certain problems are due to lack of simple maintenance or oversights, which can be solved easily without calling out an engineer. Before contacting your local Service Centre, please carry out the checks listed below.

During machine operation it is possible that the yellow pilot light of button **8** blinks, one of the following alarm codes appears on the display and at the same time some acoustic signals sound every 20 seconds to indicate that the machine is not working:

- *E10* : problem with the water supply
- *E20* : problem with the water draining
- *E40* : door open.

Once the problem has been eliminated, press button **8** to restart the programme. If after all checks, the problem persists, contact your local Service Centre.

Problem	Possible cause/Solution
<p><b>The washer-dryer does not start:</b></p>	<p>The door has not been closed. <i>E40</i></p> <ul style="list-style-type: none"> <li>• Close firmly the door.</li> </ul> <p>The plug is not properly inserted in the power socket.</p> <ul style="list-style-type: none"> <li>• Insert the plug into the power socket.</li> </ul> <p>There is no power at the socket.</p> <ul style="list-style-type: none"> <li>• Please check your domestic electrical installation.</li> </ul> <p>The main fuse or the fuse in the plug has blown.</p> <ul style="list-style-type: none"> <li>• Replace the fuse.</li> </ul> <p>The selector dial is not correctly positioned and the button <b>8</b> has not been depressed.</p> <ul style="list-style-type: none"> <li>• Please turn the selector dial and press button <b>8</b> again.</li> </ul> <p>The delay start has been selected.</p> <ul style="list-style-type: none"> <li>• If the laundry is to be washed immediately, cancel the delay start.</li> </ul> <p>The Child safety lock has been activated.</p> <ul style="list-style-type: none"> <li>• Deactivated this device.</li> </ul>
<p><b>The machine does not fill:</b></p>	<p>The water tap is closed. <i>E10</i></p> <ul style="list-style-type: none"> <li>• Open the water tap.</li> </ul> <p>The inlet hose is squashed or kinked. <i>E10</i></p> <ul style="list-style-type: none"> <li>• Check the inlet hose connection.</li> </ul> <p>The filter in the inlet hose is blocked. <i>E10</i></p> <ul style="list-style-type: none"> <li>• Clean the water inlet hose filter.</li> </ul> <p>The door is not properly closed. <i>E40</i></p> <ul style="list-style-type: none"> <li>• Close firmly the door.</li> </ul>

Problem	Possible cause/Solution
<b>The machine fills then empties immediately:</b>	<p>The end of the drain hose is too low.</p> <ul style="list-style-type: none"> <li>• Refer to relevant paragraph in «water drainage» section.</li> </ul>
<b>The machine does not empty and/or does not spin:</b>	<p>The drain hose is squashed or kinked. <i>E20</i></p> <ul style="list-style-type: none"> <li>• Check the drain hose connection.</li> </ul> <p>The drain filter is clogged. <i>E20</i></p> <ul style="list-style-type: none"> <li>• Clean the drain filter.</li> </ul> <p>An option/programme that ends with the water still in the tub or eliminates all the spinning phases has been selected.</p> <ul style="list-style-type: none"> <li>• Select the draining or the spinning programme.</li> </ul> <p>The laundry is not evenly distributed in the drum.</p> <ul style="list-style-type: none"> <li>• Redistribute the laundry.</li> </ul>
<b>There is water on the floor:</b>	<p>Too much detergent or unsuitable detergent (creates too much foam) has been used.</p> <ul style="list-style-type: none"> <li>• Reduce the detergent quantity or use another one.</li> </ul> <p>Check whether there are any leaks from one of the inlet hose fittings. It is not always easy to see this as the water runs down the hose; check to see if it is damp.</p> <ul style="list-style-type: none"> <li>• Check the water inlet hose connection.</li> </ul> <p>The drain hose is damaged.</p> <ul style="list-style-type: none"> <li>• Replace it with a new one.</li> </ul> <p>The cap on the emergency emptying hose has not been replaced or the filter has not been properly screwed in after cleaning action.</p> <ul style="list-style-type: none"> <li>• Refit the cap on the emergency emptying hose or screw the filter fully in.</li> </ul>
<b>Unsatisfactory washing results:</b>	<p>Too little detergent or unsuitable detergent has been used.</p> <ul style="list-style-type: none"> <li>• Increase the detergent quantity or use another one.</li> </ul> <p>Stubborn stains have not been treated prior to washing.</p> <ul style="list-style-type: none"> <li>• Use commercial products to treat the stubborn stains.</li> </ul> <p>The correct temperature was not selected.</p> <ul style="list-style-type: none"> <li>• Check if you have selected the correct temperature.</li> </ul> <p>Excessive laundry load.</p> <ul style="list-style-type: none"> <li>• Reduce the laundry load.</li> </ul>

Problem	Cause possible/Solution
<b>The door will not open:</b>	<p>The programme is still running.</p> <ul style="list-style-type: none"> <li>• Wait the end of washing cycle.</li> </ul> <p>The door lock has not been released.</p> <ul style="list-style-type: none"> <li>• Wait until «D» appears on the display.</li> </ul> <p>There is water in the drum.</p> <ul style="list-style-type: none"> <li>• Select drain or spin programme to empty out the water.</li> </ul>
<b>The machine vibrates or is noisy:</b>	<p>The transit bolts and packing have not been removed.</p> <ul style="list-style-type: none"> <li>• Check the correct installation of the appliance.</li> </ul> <p>The support feet have not been adjusted</p> <ul style="list-style-type: none"> <li>• Check the correct levelling of the appliance.</li> </ul> <p>The laundry is not evenly distributed in the drum.</p> <ul style="list-style-type: none"> <li>• Redistribute the laundry.</li> </ul> <p>Maybe there is very little laundry in the drum.</p> <ul style="list-style-type: none"> <li>• Load more laundry.</li> </ul>
<b>Spinning starts late or the machine does not spin:</b>	<p>The electronic unbalance detection device has cut in because the laundry is not evenly distributed in the drum. The laundry is redistributed by reverse rotation of the drum. This may happen several times before the unbalance disappears and normal spinning can resume. If, after some minutes, the laundry is still not evenly distributed in the drum, the machine will not spin.</p> <ul style="list-style-type: none"> <li>• Redistribute the laundry.</li> </ul>
<b>The machine does not dry or does not dry properly</b>	<p>The drying time or the dryness degree has not been selected .</p> <ul style="list-style-type: none"> <li>• Select the drying time or the dryness degree</li> </ul> <p>The water tap is not turned on (E10)</p> <ul style="list-style-type: none"> <li>• Open the water tap.</li> </ul> <p>The drain filter is clogged (E20)</p> <ul style="list-style-type: none"> <li>• Clean the drain filter.</li> </ul> <p>The machine is overloaded.</p> <ul style="list-style-type: none"> <li>• Introduce into the drum less laundry.</li> </ul> <p>The selected drying programme, time or dryness degree was not suitable for the laundry</p> <ul style="list-style-type: none"> <li>• Select the suitable drying programme, time or dryness degree for the laundry.</li> </ul>
<b>No water is visible in the drum:</b>	<p>Machines based on modern technology operate very economically using very little water without affecting performance.</p>

If you are unable to identify or solve the problem, contact our service centre. Before telephoning, make a note of the model, serial number and purchase date of your machine: the Service Centre will require this information.

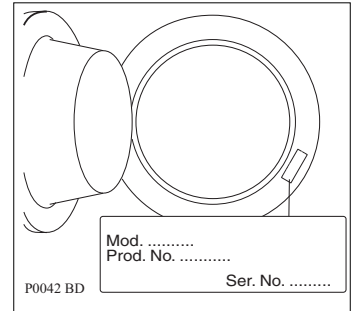

## Technical Data

Dimensions	Width	60 cm
	Height	85 cm
	Depth (door included)	63 cm
Electrical connection	Power supply voltage/frequency	230-240 V/50 Hz
	Total power absorbed	2050 W
	Minimum fuse protection	10 A
Water supply pressure	Minimum	0,05 MPa
	Maximum	0,8 MPa
Maximum Load	Cottons	6 kg
Maximum Dry Load	Cotton	3 kg
	Cotton Big capacity	4 kg
	Synthetics	2 kg
Spin Speed	Maximum	1400 rpm



## Consumption value

Programme	Water consumption (litres)	Energy consumption (KWh)	Programme duration (Minutes)
White Cottons 95°	61	2.0	For the duration of the programmes, please refer to the display on the control panel.
Cottons 60°	58	1.3	
(*)Cotton ECONOMY 60°	46	1.02	
Cottons 40°	58	0.7	
Synthetics (Easy Cares) 60°	54	1.0	
Delicates 40°	54	0.5	
Wool ( Handwash) 30°	53	0.25	



The consumption data shown on this chart is to be considered purely indicative, as it may vary depending on the quantity and type of laundry, on the inlet water temperature and on the ambient temperature.



(\*) «Economy 60°C» with a load of 6 kg is the reference programme for the data entered in the energy label, in compliance with EEC 92/75 standards.

# Installation

## Unpacking

All transit bolts and packing must be removed before using the appliance.

You are advised to keep all transit devices so that they can be refitted if the machine ever has to be transported again.

1. After removing all the packaging, carefully lay machine on it's back to remove the polystyrene base from the bottom.

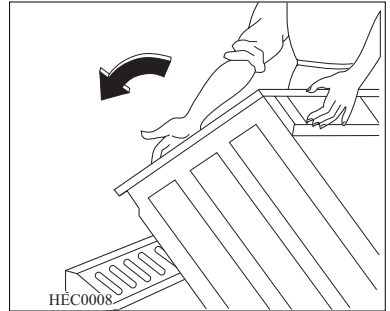

2. Remove the power supply cable and the draining hose from the hose holders on the rear of the appliance.

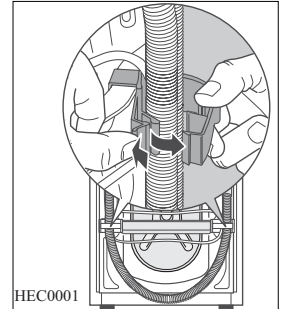

3. With a suitable spanner unscrew and remove the central rear bolt **A**.

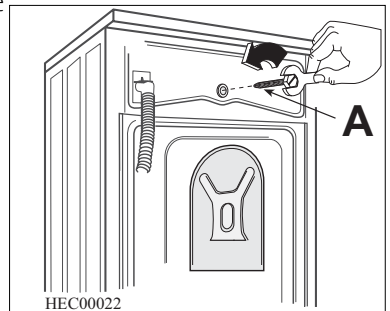



4. Unscrew and remove the two large rear bolts **B** and the six smaller bolts **C**.

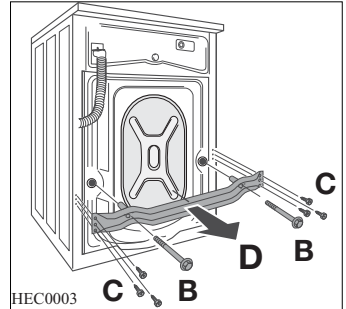

5. Remove the bracket **D** and tighten up the six smaller bolts **C**. Slide out the relevant plastic spacer **E**.

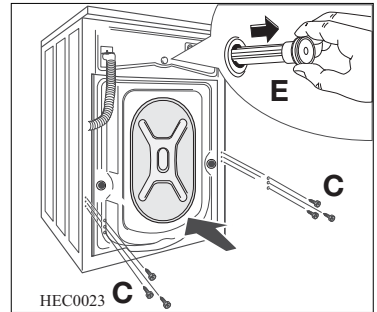

6. Open the porthole, take out the inlet hose from the drum and remove the polystyrene block fitted on the door seal.

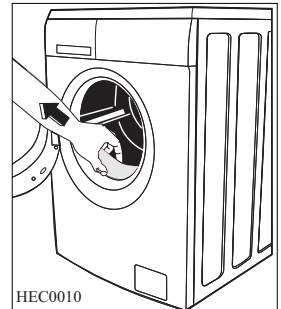

7. Fill the smaller upper hole and the two large ones with the corresponding plastic plug caps supplied in the bag containing the instruction booklet.
8. Connect the water inlet hose as described under the paragraph «Water inlet».

All the different plug caps are supplied with the appliance in the plastic bag containing the instruction booklet.

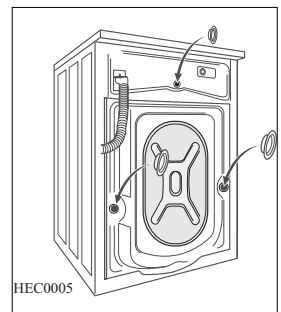

## Positioning and levelling

Install the machine on a flat hard floor.

Make sure that air circulation around the machine is not impeded by carpets, rugs etc.

Before placing it on small tiles, apply a rubber coating.

Never try to correct any unevenness in the floor by putting pieces of wood, cardboard or similar materials under the machine.

If it is impossible to avoid positioning the machine next to a gas cooker or coal-burning stove, an insulating panel covered with aluminium foil on the side facing the cooker or stove, must be inserted between the two appliances.

The machine must not be installed in rooms where the temperature can drop below 0.

The water inlet hose and the drain hose must not be kinked.

Please ensure that when the appliance is installed, it is easily accessible for the engineer in the event of a breakdown.

Carefully level by screwing the adjustable feet in or out. Never place cardboard, wood or similar materials under the machine to compensate for any unevenness in the floor.

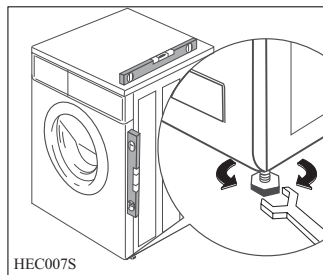

## Water inlet

An inlet hose is supplied and can be found inside the machine drum.

**Do not use the hose from your previous machine to connect to the water supply.**

**This appliance must be connected to a cold water supply.**

1. Open the porthole and extract the inlet hose.
2. Connect the hose with the angled connection to the machine.



**Do not place the inlet hose downwards. Angle the hose to the left or right depending on the position of your water tap.**

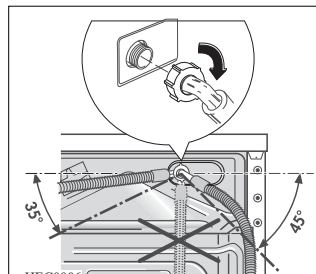

3. Set the hose correctly by loosening the ring nut.

After positioning the inlet hose, be sure to tighten the ring nut again to prevent leaks.

4. Connect the hose to a tap with a 3/4" thread. Always use the hose supplied with the appliance.

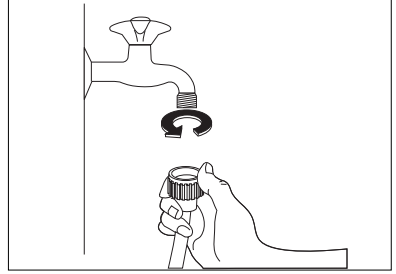

Installation should comply with local water authority and building regulations requirements. A minimum water pressure of 0.05 MPa is required for safe operation of the appliance.

If you cannot make the cold water connection direct from the rising mains, you may be able to operate the appliance from your cold water storage system. There should be a minimum distance of between the appliance's inlet and the bottom of the water storage tank.

The inlet hose must not be lengthened. If it is too short and you do not wish to move the tap, you will have to purchase a new, longer hose specially designed for this type of use.

## Water drainage

This appliance is designed to be permanently plumbed into your home's drainage system using one of the following methods.

### 1. Into a drainage standpipe.

Firstly form a hook in the end of the drain hose using the "U" piece supplied.



Place the drain hose into your standpipe, which should have an internal diameter of approximately 38mm thus ensuring there is an air break between the drain hose and standpipe.

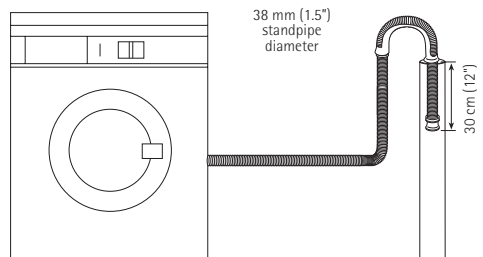

When discharging into a standpipe ensure that the top of the standpipe is no more than 90 cm (35.4") and no less than 60 cm (23.6") above floor level.

The drain hose may be extended to a maximum of 4 metres. An additional drain hose and joining piece is available from your local Service Force Centre. The joining piece must have an internal diameter of 18 mm.

If your drain hose looks like this (see the relevant picture) you do not require the "U" piece. Just push the hose firmly into the standpipe.

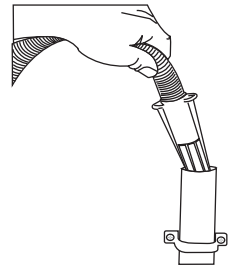
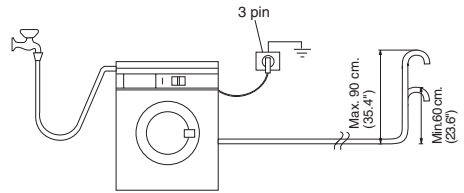

## 2. Onto a sink outlet spigot.

If the outlet spigot has not been used before, remove any blanking plug that may be in place.

Push the drain hose onto the spigot and secure with a clip if required, ensure a loop is formed in the drain hose (see diagram) to prevent waste from the sink entering the washing machine.

The drain hose may be extended to a maximum of 4 metres. An additional drain hose and joining piece is available from your local Service Force Centre. The joining piece must have an internal diameter of 18 mm.

If you intend the drain hose from the machine to empty into a sink, make sure that the sink is empty and the plug hole is not blocked. Use the plastic "U -Piece" supplied.

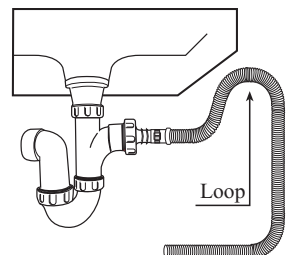
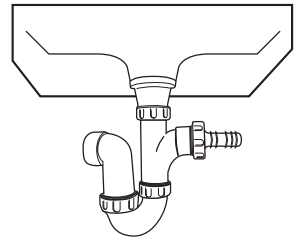

## In the interest of the environment

Washing machines and dishwashers should be connected to the FOUL drainage system, the water will then be taken to a sewage works for treatment before being discharged safely into a river.

It is essential that these appliances are not connected to the surface water drainage system as this water is discharged directly into a river or stream and may cause pollution.

If you require any further advice please contact your local water authority.

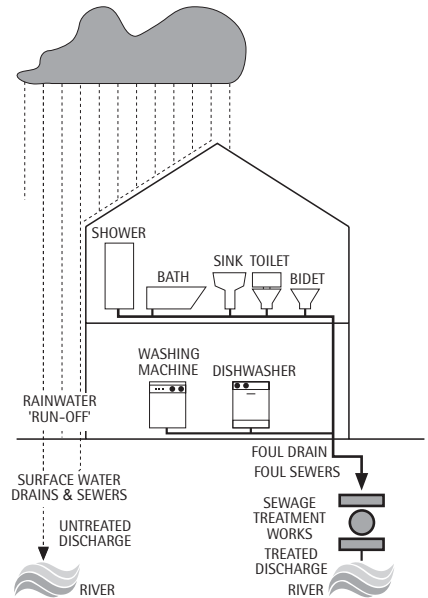

## Electrical connection



**WARNING: THIS APPLIANCE MUST BE EARTHED.**



**The manufacturer does not accept any responsibility for damage or injury through failure to comply with the above safety precaution.**

If the plug that is fitted to your appliance is not suitable for your socket outlet, it must be cut off and the appropriate plug fitted.

Remove the fuse from the cut off plug.

The cut off plug should then be disposed of to prevent the hazard of shocks in case it should be plugged into a 13 Amp socket in another part of your home.

### Important

The wires in the mains lead are coloured in accordance with the following code:

- |                  |           |
|------------------|-----------|
| Green and Yellow | - Earth   |
| Blue             | - Neutral |
| Brown            | - Live    |

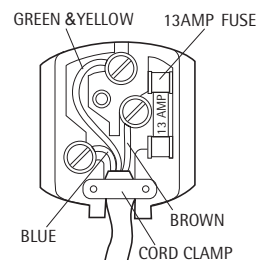

If you fit your own plug, the colours of the wires in the mains lead of your appliance may not correspond with the markings identifying the terminals in your plug, proceed as follows:

Connect the green and yellow (earth) wire to the terminal in the plug which is marked with the letter «E» or the earth symbol  $\perp$  or coloured green and yellow.

Connect the blue (neutral) wire to the terminal in the plug which is marked with the letter «N» or coloured black.

Connect the brown (live) wire to the terminal in the plug which is marked with the letter «L» or coloured red.

The plug moulded on to the lead incorporates a fuse. For replacement, use a 13 Amp BS1363/A fuse. Only ASTA or BSI approved fuses should be used.

The plug must not be used if the fuse cover/carrier is lost. The cover/carrier is indicated by the coloured insert at the base of the plug.

A replacement cover/carrier must be obtained from your local AEG/ELECTROLUX Service Centre.



**The power supply cable must be easily accessible after installing the machine.**



**Should the appliance power supply cable need to be replaced, this MUST be carried out by a Service Centre.**

## Permanent connection

In the case of a permanent connection it is necessary that you install a double pole switch between the appliance and the electricity supply (mains), with a minimum gap of 3 mm between the switch contacts and of a type suitable for the required load in compliance with the current electrical regulations.

The switch must not break the yellow and green earth cable at any point.

This operation must be performed by a qualified electrician.

## Environment concerns

### Packaging materials

The materials marked with the symbol  are recyclable.

>PE<=polyethylene

>PS<=polystyrene

>PP<=polypropylene

This means that they can be recycled by disposing of them properly in appropriate collection containers.

### Old machine

Use authorised disposal sites for your old appliance. Help to keep your country tidy!

The symbol  on the product or on its packaging indicates that this product may not be treated as household waste. Instead it shall be handed over to the applicable collection point for the recycling of electrical and electronic equipment. By ensuring this product is disposed of correctly, you will help prevent potential negative consequences for the environment and human health, which could otherwise be caused by inappropriate waste handling of this product. For more detailed information about recycling of this product, please contact your local city office, your household waste disposal service or the shop where you purchased the product.

### Ecological hints

To save water, energy and to help protect the environment, we recommend that you follow these tips:

- Normally soiled laundry may be washed without prewashing in order to save detergent, water and time (the environment is protected too!).
- The machine works more economically if it is fully loaded.
- With adequate pre-treatment, stains and limited soiling can be removed; the laundry can then be washed at a lower temperature.
- Measure out detergent according to the water hardness, the degree of soiling and the quantity of laundry being washed.

[www.electrolux.com](http://www.electrolux.com)

[www.aeg-electrolux.uk](http://www.aeg-electrolux.uk)

Subject to change without notice

132 962 861-01-222008

PERFEKT IN FORM UND FUNKTION





## Free Manuals Download Website

<http://myh66.com>

<http://usermanuals.us>

<http://www.somanuals.com>

<http://www.4manuals.cc>

<http://www.manual-lib.com>

<http://www.404manual.com>

<http://www.luxmanual.com>

<http://aubethermostatmanual.com>

Golf course search by state

<http://golfingnear.com>

Email search by domain

<http://emailbydomain.com>

Auto manuals search

<http://auto.somanuals.com>

TV manuals search

<http://tv.somanuals.com>