

**AEG**

# ÖKO-LAVAMAT 1263 TURBO

The ecological washer-dryer

**AEG**

AEG Hausgeräte AG  
Postfach 1036  
D 90429 Nürnberg

Copyright by ALG

H 249 201000

**ERFAHRUNG**

12498.31/70

 B 1168

User Instruction Book

Download from [Www.Somanuals.com](http://www.Somanuals.com). All Manuals Search And Download.

**AUS**  
**ERFAHRUNG**  
**GUT**

## Allow me to introduce myself

I am AEG's ÖKO LAVAMAT washer-dryer. I'm very economical with electricity, gentle with your laundry, particularly quiet when I'm working, simple to use and easy to care for.

**If, before using me, you read and carefully follow the instructions in this book, you are sure to be very happy with the way I wash and dry your laundry!**



Printed on recycled paper—  
Ecological in practice, not just theory

## Technical specifications

### Dimensions:

With worktop:  
Height 85.0 cm  
Width 60.0 cm  
Depth 60.0 cm

Without worktop:  
Height 82.0 cm  
Width 59.5 cm  
Depth 57.0 cm

### Connection

Details concerning electrical connection are given on the rating plate.

When connecting the appliance, make sure that the mains supply voltage and type of current shown on the rating plate are the same as those in the location where it is being installed.

### Drum speed

Washing max. 55 rev/min  
Spinning max. 1200 rev/min (cottons)  
max. 850 rev/min (easy cares, delicates, wool)  
selectable: 850 rev/min (cottons, linens)

### Water pressure:

0.5 - 10 bar (= 5 - 100 N/cm<sup>2</sup> = 0.05 - 1.0 MPa)

### Net weight:

approx. 83 kg

## Customer service

If you are unable to identify or resolve the problem by reading the instruction book, contact our Service Department. Always start by quoting the product code (E-Nr.) and the batch number (F-Nr) shown on the rating plate.

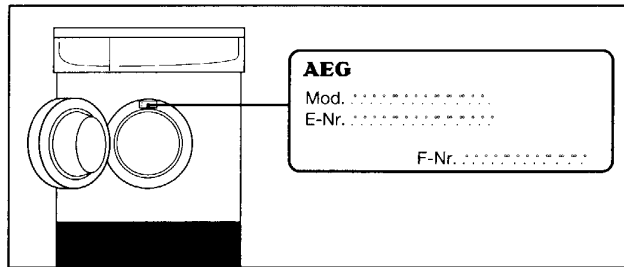

For convenience, you are advised to note these details below.

E-Nr. ....

F-Nr. ....

## Contents

<b>Warnings</b>	4
Before installing	4
Warnings (washing)	4
Warnings (drying)	5
<b>The AEG Öko-System / Ecological hints</b>	7
<b>Installation instructions</b>	9
Removing the transit devices	9
Positioning	10
<b>Connection</b>	12
Electrical connection	12
Connection to the mains water supply	12
Water drainage	13
Door reversal	14
Panelling the door	15
<b>Brief instructions</b>	16
<b>Preliminary operations for washing</b>	17
Sorting and selecting garments	17
Pre-treatment	17
Precautions	18
Load sizes	18
<b>Selecting the programme</b>	19
Programme selector	19
Option buttons and functions	20
<b>Detergents</b>	22
Choice of detergent	22
Amount of detergent	23
Using the detergent	23
<b>Programme chart (washing)</b>	24
<b>Special programmes</b>	26
<b>End of programme</b>	28
<b>Preliminary operations for tumble drying</b>	29
Protect the environment	29
Preparation for tumble drying	29
Items not suitable for tumble drying	30
Drying code symbols	30
<b>Selecting the drying programme</b>	31
Drying only	31
Automatic washing and drying	33
<b>Drying time chart</b>	34
<b>Maintenance and cleaning</b>	36
Detergent dispenser drawer	36
Cleaning the filter/Emergency emptying	37
Other	38
<b>How to deal with problems...</b>	39
<b>Customer service</b>	42
<b>Technical specifications</b>	43

## Warnings

### Before installing...

- Follow the instructions for installation and electrical connection.
- Do not connect the appliance if it is damaged (for example during transport).
- Any water found in the detergent dispenser drawer is there as a result of factory testing.
- To remove any manufacturing residues from the drum and detergent dispenser drawer, carry out a wash cycle without any laundry, with the machine set on the 60°C coloureds programme and with 1/2 a measure of detergent.

### Warnings (washing)

AEG household electrical appliances comply with general technical safety manufacturing standards and with all safety regulations on the use of electrical appliances. However, the manufacturer is obliged to bring the following safety points to the attention of the user:

- Before using the appliance, make sure that the voltage and type of current indicated on its rating plate correspond to the mains voltage and type of current in the place where it is to be installed. The rating plate also gives details of the electrical protection required.
- If the appliance is installed in a location which is not insulated against frost, the emergency emptying procedure (see "Emergency emptying") should be used whenever there is any risk of the temperature dropping below zero.
- Always disconnect the appliance before cleaning it or carrying out any maintenance. To be absolutely safe, check that the plug is removed from the socket or that the mains switch or safety circuit breaker are in the OFF position (see instructions for installation and electrical connection).
- Avoid spraying the appliance with water.
- Never remove the plug from the socket by pulling the cable; always take hold of the plug itself!
- Never start the appliance if:
  - the power supply cable is damaged
  - there are obvious signs of damage in the control panel area, to the top or along the base.
- **Repairs must only be carried out by qualified persons. Inexperienced repairs can seriously endanger the user.** Always contact the Service Centre or an authorized dealer. Only genuine AEG spares comply with all standards!

### ... the fabric softener has left marks on the laundry:

- In this case the fabric softener, especially if of the concentrated type, has come into direct contact with the laundry. Wash out these marks immediately.

### ... detergent residue is left after the wash cycle:

- This is most probably due to non soluble components contained in modern detergents. It is not a sign of inadequate rinsing. Brush or shake the garments and, if necessary, wash them again.

### ... the fabric softener has not been introduced in the tub or there is water left in the compartment marked with the symbol:

- The drawer was pulled out whilst the machine was filling, or the drawer was not fully inserted.

### ... foam remains after the last rinse:

- Modern detergents can produce foam even after rinsing, but this will not affect the quality of the wash.

### ... no water is visible in the drum:

- Machines based on modern technology operate very economically using very little water. Their performance however is excellent.

### ... the laundry is not sufficiently spun and there is still water in the drum:

- Check whether the drain hose is kinked.
- Check whether the filter is blocked.

### ... the machine does not dry:

- Check that the drying time has been selected.
- Check that the tap is open.
- Check that the filter is not blocked.
- Check that the drum has not been over-filled.
- Check that the correct drying time has been selected.

**If the Service Centre is called out for one of the faults listed above, or as a result of incorrect usage of the machine, repairs will not be carried out free of charge, even if the guarantee has not yet expired.**

**... the machine does not empty or does not spin:**

- Check whether the drain hose is kinked.
- Check whether the filter is blocked.
- You have selected a programme for synthetics, delicates or wool which ends "with the water left in the drum". You have to select the "drain" or "short spin" programme to empty the machine.

**... the machine makes strange noises:**

- The machine is fitted with a modern starting system which makes an unusual whistling or hissing noise, compared with other machines.  
This new system allows spinning to be started more gently and provides better control of gradual increase in spin speed. This improves machine performance and reduces water consumption.

**... too much foam forms during washing:**

- Too much detergent is being used or the detergent is of the wrong type. Check the amounts required.

**... water is leaking from the bottom of the machine:**

- Check whether the inlet hose is leaking.
- Check whether the drain hose clip has worked loose.
- Check whether the drain hose is damaged.
- Check that the filter is fully screwed in and properly fitted.

**... washing results are poor:**

- Too little detergent has been used or detergent is of the wrong type.  
If insufficient detergent is used, the laundry will look grey and lime deposits will be left in the machine. Use the correct amount of detergent.
- Check whether stains were adequately treated prior to washing.
- Check whether the programme and temperature selected were correct.

**... stains remain even though they have been treated before washing:**

- Probably the stains are indelible. Check with an expert.

**... there are grey marks on the laundry:**

- Laundry stained with grease, creams or oil has been washed with insufficient detergent. The detergent was not strong enough to shift these stains.
- Check whether the temperature selected was too low.

- If the appliance is to be installed under a worktop in a fitted kitchen or laundry room, the appliance cover must first be removed and a protective plate must then be fitted, as described in the installation instructions.
- Do not allow children to play with the appliance and keep pets well away from it.
- For safety, when disposing of the appliance make sure that the door catch is inoperative and cut off the power supply cable.
- The Manufacturer accepts no liability for damage caused by incorrect or improper use of the appliance for purposes for which it was not originally designed.
- Never put your hands in the drum whilst it is still rotating.
- Never touch the glass in the porthole door when the appliance is being used on a high-temperature programme; the glass gets very hot and can cause burns.
- There is a danger of scalding if the porthole door or filter cover are opened during operation.
- The water drain hose must be properly fixed to avoid any risk of scalding or flooding.
- In the event of a fault, close the mains water tap and disconnect the appliance from the power supply by pulling out the plug or switching the safety circuit breaker (or breakers) to the OFF position.
- Keep packaging materials away from children, especially cellophane which is particularly dangerous.
- If washing garments which have previously been dry cleaned, first make sure that any remaining inflammable solvents have completely evaporated.
- If the appliance is to be connected to a rainwater or other similar source of water instead of the mains water supply, follow the Water Board regulations.
- The appliance must only be used to tumble dry normal household laundry.
- Dry only laundry which has previously been washed in water.
- It is quite normal for the sides of the appliance to get hot during drying. Avoid touching them!

**Warnings  
(drying)**

- Never tumble dry quilted garments containing foam rubber or similar materials; they could catch fire.
- Never tumble dry fabrics stained with hair lacquer, nail varnish remover or other similar substances which would give off toxic fumes.
- Laundry dried in a tumble dryer comes out soft to the touch. This means you can help protect the environment by using less fabric softener in the wash.
- If so-called "ecological" or "perfume-free" detergents are used, tumble-dried laundry may not have the typical "smell of freshness". This is not due to a fault in your appliance, but simply to the natural smell of the fabric which is not neutralised during washing because the detergent contains no deodorants.

**The Manufacturer accepts no responsibility for accidents resulting from failure to observe the above safety recommendations.**

## How to deal with problems...

### ... the machine does not start:

- Check that the appliance is plugged in.
- Check that a programme has been selected.
- Check that the ON/OFF button has been pressed.
- Check that the porthole door is firmly shut.
- Check that the fuse has not blown.

### ... the door will not open:

- the safety device has locked it.  
Wait 1-2 minutes after the end of the programme to give the safety device time to release the door.

### ... the machine does not fill:

- Check that the tap is on.
- Check whether the filter in the inlet hose is blocked.  
If the machine takes longer than usual to fill with water, check whether the filter in the inlet hose is blocked.  
To do this, shut the water tap. Unscrew the hose from the tap and remove the filter. Clean it with an old toothbrush then refit it.  
Tighten up the inlet hose.

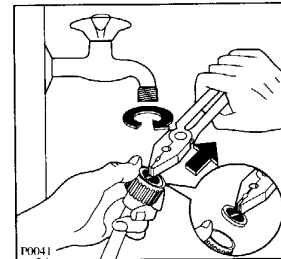

### ... the machine vibrates or is noisy:

- With very small loads (for example just one bathrobe) the machine may start to vibrate. This does not however affect performance.
- Check that the support feet are correctly adjusted. Refer to the installation instructions.
- Check that all the transit bolts and packing have been removed. Refer to the installation instructions.

**Problems you can solve yourself**

## The AEG ÖKO-System / Ecological hints



<b>The drum</b>	The drum is made of stainless steel. Any rusty items left in the laundry (see "Preliminary operations for washing") could leave rust stains on the surface of the drum. These stains can be removed with a suitable stainless steel cleaner, available from the Service Centre.
<b>Porthole door</b>	Remove any deposits or foreign objects from the rubber seal on the porthole door. Never close the porthole door immediately after washing; leave it open to allow the drum to dry and ensure that the machine is properly aired.
<b>Descaling</b>	If the correct amount of detergent is used, descaling should not be necessary. If, however, it does become necessary, use only branded, non-corrosive descalers suitable for washing machines. These are available from the Service Centre.
<b>Control panel</b>	If necessary, clean the control panel with warm water only.

This new machine is part of AEG's ÖKO-System range, which meets all requirements for modern handling of laundry with reduced consumption of water, energy and detergent.

The automatic metering device automatically regulates the amount of water used according to the size of load and type of fabric.

The drum is fitted with special paddles which keep the water moving upwards. In this way, the laundry is soaked more evenly and faster.

All the materials used for packaging are non-polluting! They may be disposed of quite safely.  
Plastic materials can be recycled and are marked with the following symbols:

- >PE< polyethylene
- >PS< polystyrene
- >PP< polypropylene

You are advised to dispose of all cardboard packaging in special paper collection containers so that it can be recycled.

**Automatic metering**

**Drum paddles**

**Packaging information**

**Ecological suggestions for economical washing**

- For medium soiling, use programmes without prewash. This will save detergent and water.
- Make full use of all the advantages offered by two-part detergents.
- Always wash full loads for maximum savings.
- Use the "ENERGY SAVING" (Economy) programme for normally or lightly soiled cottons and coloureds.
- For best results, even at low temperatures, remove individual stains from laundry before washing.
- Use minimum amounts of detergent. Follow the instructions on the pack.

The filter collects fluff and any small objects which may accidentally have been left in the laundry. If this filter gets clogged, the programmes will not function properly. The filter should therefore be cleaned from time to time. Hot water remaining in the filter can scald! Allow it to cool before cleaning.

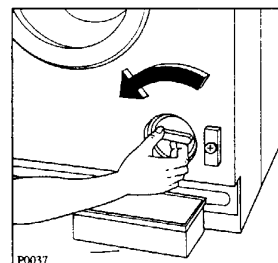

Place a basin under the filter and unscrew it in order to remove it.

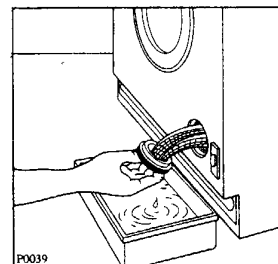

Clean it under a running tap

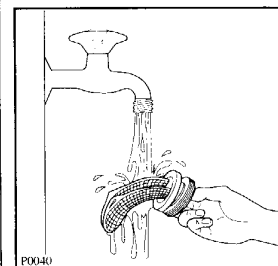

**Cleaning the filter / Emergency emptying**



## Maintenance and cleaning

### Detergent dispenser drawer

From time to time, clean off any detergent residue remaining in the bottom of the drawer compartments.

- To do this, pull out and remove the drawer by pressing down the catch.

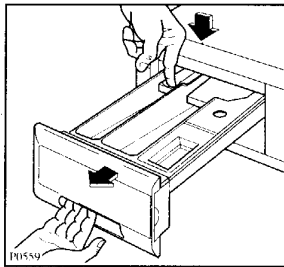

The upper part of the liquid additive compartment can also be removed for easy cleaning.

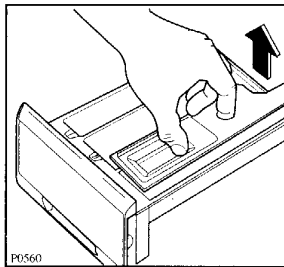

### Drawer recess

Detergent residue can also accumulate inside the drawer recess, which should be cleaned occasionally with an old toothbrush.

After cleaning, refit the drawer and push it fully in.

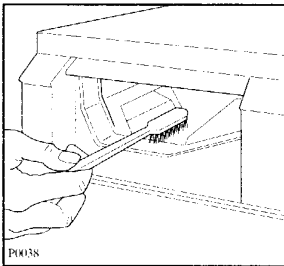

- After each wash programme, partially pull out the detergent drawer to let it dry.

## Installation instructions

**All transit devices must be removed before installing and connecting the appliance.**

### Removing the transit devices

Proceed as follows:

Using a spanner, remove the bolt on the right at the back of the machine.

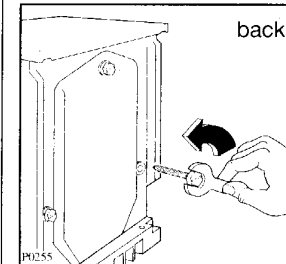

Gently lay the machine on its back, taking care not to squash the hoses.

This can be done more easily by placing one of the corner packing pieces between the machine and the floor.

Remove the polystyrene packing piece.

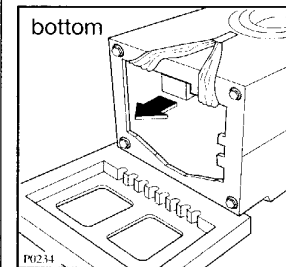

Peel off the adhesive strip and carefully remove the right-hand polythene bag (1), then the left-hand bag (2) by pulling both towards the centre of the machine.

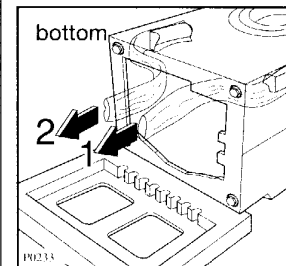

Set the machine upright and unscrew the remaining two bolts on the back.

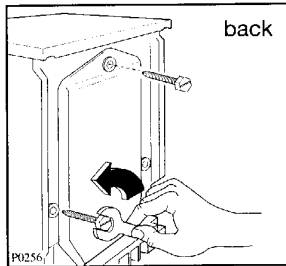

Remove the three plastic pins from the holes in which the bolts were fitted.

Blank off the holes with the plastic plugs supplied, which you will find in the bag with the instruction book.

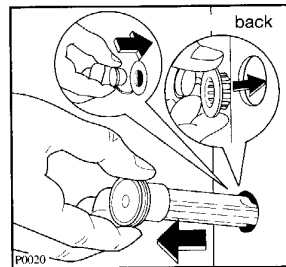

**Hint:**

Keep all transit devices for re-use in case you move house.

**Positioning**

The machine stands on four adjustable rubber feet which can be used to compensate any unevenness in the floor or to adjust the machine to the correct height.

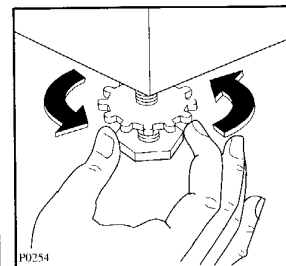

Load kg	Spin speed rpm	Cycle duration mins
3	1200	90-100
2	1200	55-65
1	1200	35-40
2	850	80-95
1	850	55-65
0.5	850	30-35
3	1200	65-75
2	1200	35-45
1	1200	30-40

## Drying time chart

### Indicative values for dry clothing

Degree of drying	Type of fabric	Examples of laundry/ clothing
Cupboard dry	Cottons to be completely dried	Towels, T-shirts, fully dried sheets, tea-cloths, bathrobes
	Easy care, synthetic and mixed fabrics which do not need ironing	Synthetic mix jumpers, blouses, household linen, baby clothes, socks, underwear
Iron dry	Cottons and linens which need ironing	Sheets, tablecloths, tea-cloths

Lock the feet in position by fully tightening up the locknuts.

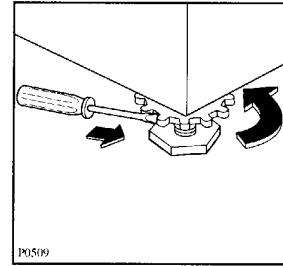

The appliance must be level and resting on all four feet. It must not tilt when pressure is exerted on one side only. If necessary, use a spirit level to check that it is perfectly level.

The floor must be clean, dry and free of any wax residue or other polish to prevent any risk of sliding. Never use viscous substances to move the appliance by sliding it across the floor!

It is inadvisable to stand the appliance on long pile carpet or rugs or on layers of foam rubber, as this could make it unstable. Place a rubber mat beneath the appliance if the floor is made of very small tiles.

If the appliance is to be placed on non-solid flooring, especially made of wooden joists and flexible boards, a waterproof wood panel, 15 mm thick, must be secured with screws to at least two of the floor joists. If possible, the machine should be placed in a corner of the room, as this is where the joists are most firmly fixed and have less tendency to flex.

Never use wedges of wood, cardboard or other similar materials to compensate for unevenness in the floor.

If space is tight and you cannot avoid placing the machine next to a gas oven or coal burning stove, a sheet of insulating material (85 x 57 cm), covered with aluminium foil on the side facing the oven or stove, must be fitted between the two appliances.

Before building the machine in under a fitted kitchen worktop, remove the cover and install a special protective plate, which is available from your local Service Centre.

## Connection

### Electrical connection

Details of the mains voltage, type of current and protection required are given on the appliance rating plate which can be found on the frame, after opening the porthole door.

**WARNING: THIS APPLIANCE MUST BE EARTHED.**

**The manufacturer declines any liability should this safety measure not be observed.**

If the appliance is to be permanently connected to the power supply you must install a circuit breaker with a gap of at least 3 mm between the contacts, which enables the appliance to be completely isolated from the mains supply.

The mains supply cable must not be extended. If it is not long enough, replace it with a new, longer cable or move the appliance closer to the power socket.

### Connection to the mains water supply

Before connecting the hose be sure to fit the mesh filter supplied.

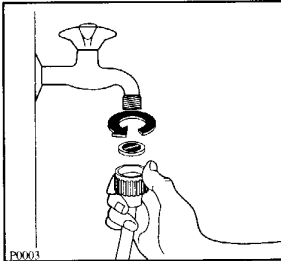

The inlet hose must not be extended. If it is too short and you do not wish to move the tap, replace it completely with a longer high pressure hose specifically designed to solve problems of this type.

The end of the hose connected to the back of the machine can be turned in any direction. Simply slacken the connector fitting, position the hose as required and fully tighten the connector to avoid leakage of water.

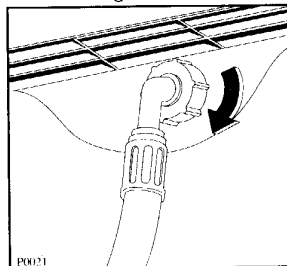

NON-STOP operation can be used for

cottons

synthetics

It cannot be used for delicate fabrics and wool.

**Warning:** When using NON-STOP operation for washing plus drying, it is essential to keep to the following maximum loads:

Cottons	max. 3 kg
Easy cares	max. 2 kg

The drying time must be selected at the same time as the wash programme.

The drying for cotton fabrics is carried out at full heating power, for easy cares at reduced heating power.

If you wish to change the selected drying time during washing turn the time selector knob **clockwise** to the required time.

### Automatic washing and drying (NON-STOP operation)

### Duration of drying cycle

The duration can vary according to:

- the speed of the final spin;
- the required degree of drying (cupboard dry or iron dry)
- the type of laundry
- the size of load.

The chart on pages 34-35 shows normal drying times. With a little experience, you will soon come to know the most suitable drying times for your own laundry requirements.

### Porthole door lock

After having started the required drying programme, the door stays locked throughout the whole cycle.

### Changing the drying time

If you wish to change the drying time during the cycle, this can be done by turning the programme selector knob **clockwise**.

### Fibre residues

After drying fabrics which lose bits of fibre, for example new towels, it is advisable to carry out a delicate drying cycle to ensure that any residue left in the drum is completely eliminated and does not stick to laundry in the next load.

You should check the filter after each drying cycle and clean it if necessary.

### Additional drying

If, at the end of the programme, the laundry is still too damp, an additional drying cycle may be selected.

**Warning: Do not over-dry, so as to avoid creasing or shrinking of garments.**

## Water drainage

Every appliance is fitted with a pump for discharging the wash and rinse water. This pump is controlled by the programme selector mechanism and is capable of pumping water through the drain hose to a height of up to 1 m above the surface on which the machine is standing.

The curved end of the drain hose can be positioned in two ways:

**Hooked over the edge of the sink.** In view of the speed with which the water comes out during the discharge phase, it is important to ensure that the curved end of the hose cannot slip off the edge of the sink. It should therefore be tied to the tap with a piece of string or secured to the wall with a hook, by inserting the hook into the hole provided in the curved part of the hose.

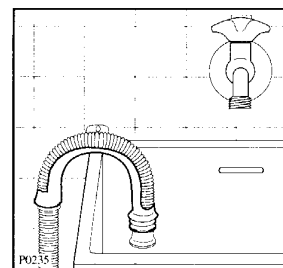

**Joined into a branch of the sink waste pipe.** The branch must be above the sink trap and at least 60 cm above the floor.

The drain hose may be extended up to a maximum length of 180 cm. Use an extension with an internal diameter the same as that of the original hose. Use a suitable connector.

The hose extension must rest on the floor and only the part near the drainage point must be raised.

## Door reversal

The appliance is supplied with the door opening from right to left. If you wish to change the opening direction, proceed as follows:

- 1) Disengage the end of the opening stop (1) from the door and turn it through 90° to remove it from its seat (Fig. A).
- 2) Using a screwdriver, turn plastic plug (2) through 90° to remove it from its seat (Fig. A).
- 3) Fit plug (2) in the hole left free by opening stop (1) and turn it through 90° to lock it in place (Fig. B).
- 4) Fit opening stop (1) into the hole from which plug (2) was removed and turn it through 90°, making sure that the latching tooth is facing towards the right (Fig. B).
- 5) Remove the door by unscrewing the screws securing it to the bottom hinge (3-Fig. A).
- 6) Unscrew the two plastic screws (4-Fig. A) and fit them on the opposite side (4-Fig. B).
- 7) Remove the catch hook (5-Fig. A) by inserting a screwdriver into the upper hole and pushing downwards.
- 8) Remove plate (6) by inserting a screwdriver into the bottom hole and pushing upwards (Fig. A).
- 9) Refit the catch hook (5) and plate (6) on the opposite sides (Fig. B).
- 10) Remove the door catch (7) and plate (8) as explained in paragraph 7.
- 11) Turn the door through 180°.
- 12) Refit the door catch (7) and plate (8), reversing their position and pressing firmly to engage the hook (Fig. B).
- 13) Fit the door onto the machine. Insert the top pin first, then the bottom pin into the hinge (3-Fig. B); finally screw the hinge onto the machine.
- 14) Check that the door is aligned with the appliance. To do this loosen screw (9-Fig. B) by a couple of turns and re-tighten when alignment is correct.
- 15) Fit the flexible end of the door opening stop into the location provided in the door (1-Fig. B).

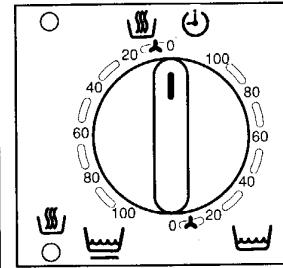

## Selecting the drying programme



If you wish to carry out a drying cycle on its own, turn the programme selector knob clockwise to DRYING: programme 6 for cottons, linens or programme 9 for synthetics.

### Drying only

#### DRYING TIME selector knob

With this knob, the drying time can be adjusted, up to a maximum of 100 minutes for cottons (section ) and synthetics (section ) .

**Never attempt to turn the knob in an anticlockwise direction.**

When selecting the drying time, take into account the type of fabric to be dried (cottons, synthetics) and the degree of drying required (cupboard dry, iron dry).

Refer to the chart.

When selecting the drying time, you should also remember that it includes a 8 minute cooling phase.

For example, if you select a drying time of 60 minutes, the machine will dry for 52 minutes and will then cool for the remaining 8 minutes.

As soon as the drying programme is started, the pilot light «Drying»  comes on.

#### Cooling phase

8 minutes before the end of the cycle, an automatic cooling phase is carried out to cool the laundry.

This phase cannot be shortened, stopped or avoided, as this could cause skin burns or damages to the laundry.

**Items not suitable for tumble drying**

Particularly delicate fabrics such as synthetic net curtains, garments made of wool or silk or with metal inserts, nylon stockings, bulky items such as anoraks, bed covers, quilts, sleeping bags should not be tumble dried.

**Drying code symbols**

Always check whether garments are suitable for tumble drying. This information is given on the label. The following symbols are for drying:



May be tumble dried



Normal drying (normal temperature)



Delicate drying (reduced temperature)



Do not tumble dry

Garments marked with the  symbol must never be tumble dried.

**Before door reversal**

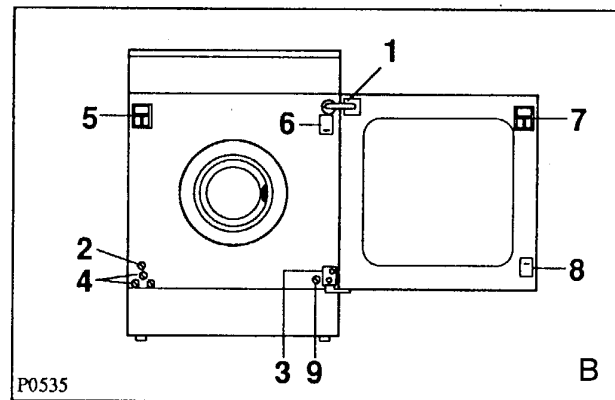
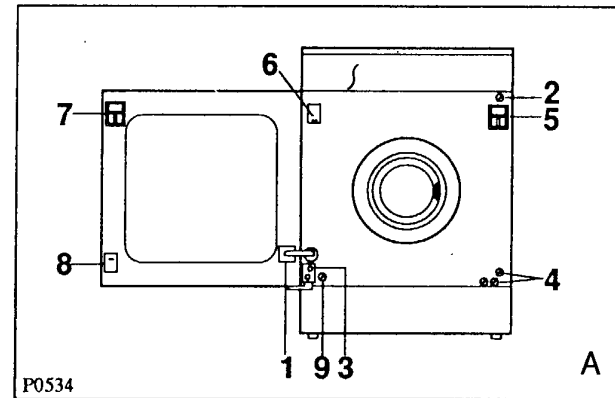

**After door reversal**

**Panelling the door**

The door of this machine is provided with frames for fitting decor panels (kitchen laminates etc.) to match the machine appearance with that of the kitchen furniture.

The overall dimensions of the decor panel should be as follows:

Width	588 mm
Height	588 mm
Max thickness	4 mm

To fit the decor panel, it is necessary to release the decor frames by removing the fastening screws.

Fit the decor panel and reassemble all the parts, ensuring that the decor panel is secured within the frames.

## Brief instructions

- **Prepare the laundry**  
Sort and select garments, carry out any pre-treatment.
- **Select the programme**  
Turn the selector to the required programme  
Press any option buttons required
- **Select the temperature and drying time (if required)**
- **Open the porthole door**
- **Load the laundry into the machine**
- **Close the porthole door**
- **Measure out the detergent**
- **Press the ON/OFF button**
- **At the end of the programme**  
Open the porthole door and remove the laundry.
- **Release the ON/OFF button**

## Preliminary operations for tumble drying

All washer-dryers consume power to dry laundry. The machine will operate most economically if the advice below is followed:

- **Remove as much water as possible from the laundry!**  
The machine will use less energy **if the laundry is thoroughly spun** before drying. A good spin reduces power consumption, shortens the drying time and enables the machine to operate more economically.

- **Use optimum loads!**  
**Keep to the loads recommended in the programme chart** to ensure economical drying. The following list may be used as a guide to estimate the weight of common laundry items:

### Weight

Approximate dry weights of cotton items:

Bathrobe	1200 g
Work shirt	300-600 g
Quilt cover	700 g
Sheet	500 g
Blouse	100 g
Towelling towel	200 g
Tea-cloth	100 g
Man's shirt	200 g
Pillowcase	200 g
Nightdress/pyjamas	200-250 g
Tablecloth	200-300 g
Underwear	250 g

As a dryer, the machine operates on the condensation principle. However, **even during the drying cycle, the water tap must be left open and the water drain hose must discharge into a sink or into a drain connection.**

<b>Load</b>	
Cottons/linens	max. 3 kg
Synthetics	max. 2 kg

**Warning:**  
**Washing loads which exceed these weights must be split for drying, otherwise good results will not be achieved.**

**Protect the environment...**

**Preparation for tumble drying**



## End of programme

### Opening the porthole door - Switching off

At the end of the programme, open the porthole door and empty the machine.

Check that the drum has been completely emptied to avoid any items accidentally left there being damaged in a subsequent wash (e.g. shrinking), or their colour running into the next laundry load.

Clean the filter, especially after a drying programme.

### Attention!

The door is controlled by a safety device which releases 2 minutes after the end of the programme.

Before opening the door check that there is no water in the drum. After programmes 7-10-11-12-13 the machine stops without draining the water of the last rinse. Select programme "8" or "14" to empty the machine, before opening the door.

## Preliminary operations for washing

- Check that garments are machine-washable by looking at the international wash code symbols on the label.

Whites



Coloureds

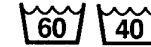

Synthetics



Delicate fabrics

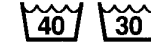

Wool

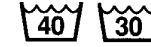

- Sort clothing according to type of fabric, degree of soiling and wash temperature.
- Wool garments marked with only the  symbol should not be washed in your machine, but those on which the symbol is accompanied by the words "non felting" or "machine-washable" may be machine-washed.
- **Never** machine-wash garments labelled with the following symbols:

Hand wash only



Do not wash in water



Dry clean only



Do not dry clean



May be bleached



Do not use bleach



- Always follow the instruction "Wash separately".
- New coloured items often contain excess dye which could run and stain other, lighter items in the wash. It is advisable to wash these items separately the first time.

If possible, treat stains when they are still new. Use water, soap or suitable detergents (stain remover spray, stick, paste, etc.).

## Sorting and selecting garments

## Pre-treatment



## Special programmes

Fabrics	Programme selector	Max. load
Cottons, linen	<b>3 Rinses</b>	6 kg
	<b>4 Conditioner rinse</b>	
	<b>5 Spin only</b>	
Easy cares, delicates	<b>12 Rinses</b>	2 kg
Wool		1 kg
Easy cares, delicates	<b>13 Conditioner rinse</b>	2 kg
Wool		1 kg
Easy cares, delicates	<b>8 Short spin</b>	2 kg
Wool		1 kg
Easy cares, delicates	<b>14 Drain</b>	2 kg
Wool		1 kg
All fabrics (except wool)	<b>15 Extra prewash 40 30</b>	6 kg for cotton 2 kg for synthetics/ delicates

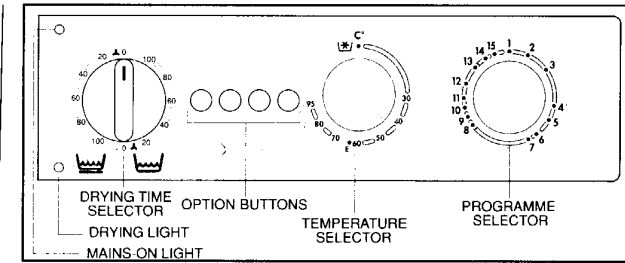

The programme selector knob can be turned only **clockwise**.

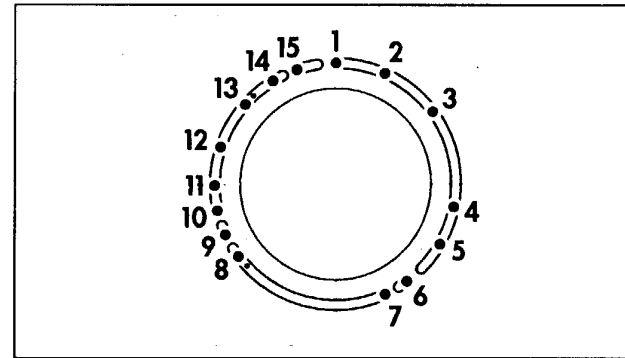

You may select normal washing and drying programmes, or the following special programmes:

For heavily soiled fabrics (except wool), the PREWASH programme may be selected. The cycle is performed up to 40°C max. and ends with a short spin.

This programme allows you to rinse separately items which have been washed by hand.

The rinse cycle for cottons ends with a long spin, the rinse cycle for easy cares, delicates and wool with the water in the drum.

This programme is for garments which have just been washed and need softening. Pour the liquid additive into the dispenser compartment marked with the  symbol.

Water may be pumped out at the end of a programme, without spinning (for synthetics, delicates and wool).

Spin for cotton items.

## Selecting the programme

### Programme selector

#### EXTRA PREWASH

#### RINSES

#### CONDITIONER RINSE

#### DRAIN

#### SPIN ONLY

**SHORT SPIN**

Spin for easy care/delicate fabrics and for woolens.

**Temperature selector knob**

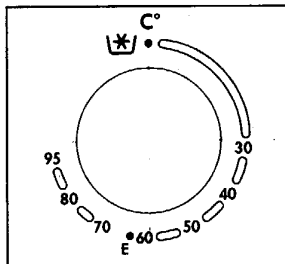

❄ = Cold wash  
 E = Economy programme  
 (for cotton & linen items)

The knob may be turned clockwise or anti-clockwise.

**Option buttons and functions**

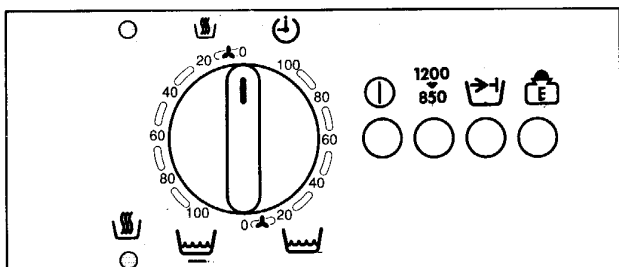

**ON/OFF**

■ **ON/OFF button** ①

When this button is pressed, the machine starts.  
 The MAINS-ON light comes on.  
 When the button is pressed again, the machine switches off and the light goes out.  
 Before selecting a programme or changing an ongoing programme the machine must be switched off by depressing the ON/OFF-button.

**QUICK WASH**









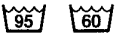

■ **Quick wash**

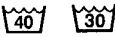
The quick wash option may be selected with programmes for cotton, synthetics and delicates. It is particularly suitable for lightly soiled loads. The washing time is reduced. It cannot be used together with the ECONOMY button.

**Suitable option buttons**

	▼	850
ECONOMY	▼	850
	▼	850
	▼	850
QUICK WASH	▼	850
ECONOMY		
QUICK WASH		

## Programme chart (Washing)

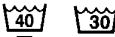
Washing symbols used on fabric labels	Programme selector	Temp. selector	Max. load
 Cottons/linen	<b>1 Whites</b>	<b>60 95</b>	6 kg
 Cottons/linen	<b>1 Whites Economy</b> <b>Energy saving programme</b>	<b>60 E</b>	
 Cottons/linen	<b>1 Fast coloureds</b>	<b>60</b>	
 Cottons/linen	<b>1 Non-fast coloureds</b>	<b>40 30</b>	
 Cottons/linen	<b>2 Whites</b> <b>Coloureds</b> <b>Quick wash</b>	<b>60 40 30</b>	
 Easy cares (synthetics, mixed fabrics)	<b>7 Whites</b>	<b>60 50 40</b>	2 kg
 Easy cares (synthetics, mixed fabrics)	<b>7 Whites Economy</b> <b>Energy saving programme</b>	<b>40</b>	
 Woollens, silk	<b>10 Woollens</b>	<b>40 30</b> <b>COLD</b> 	1 kg
 Delicates (acrylics, wool mixes, acetate)	<b>11 Silk, Delicates</b>	<b>40 30</b> <b>COLD</b> 	2 kg
 Easy cares (synthetics, mixed fabrics)	<b>11 Synthetics</b> <b>Delicates</b> <b>Quick wash</b>	<b>40 30</b>	

### ■ Economy

By depressing this button on programmes 1 and 7 and selecting 60E instead of 95° for cottons and 40° instead of 60° for synthetics the washing time will be prolonged by approx. 20 mins on programme 1 and 10 mins on programme 7.

This will allow you to obtain a substantial saving in electricity consumption by obtaining at the same time good washing results.

To be used for normal soiled laundry without stubborn stains.

### ■ Spin 1200 ▼ 850

This button allows you to select a slower spin speed than normal. If this button is not pressed spinning will automatically be performed at the maximum speed for the programme selected.

**This is important when wishing to dry laundry in the machine because it allows you to save time and energy.**

The spin speed can be reduced from 1200 to 850 rpm for cotton items.

### ECONOMY

### SPIN 1200 ▼ 850

## Detergents

### Choice of detergent

Any of the modern, commercially available detergents made for use in domestic washing machines may be used. The type of detergent used depends on the type of fabric and soiling.

The various types of soiling are:

- **Dirt**, e.g. dust, soot, sweat, organic stains, etc.
- **Stains which respond to bleach**, e.g. red wine, fruit, vegetables, etc.
- **Protein stains**, e.g. blood, milk etc.

Detergents are available in the following forms:

- **Powder detergent**, with bleaching agent
- **Liquid detergent**, without bleaching agent
- **Colour-safe detergents for delicate fabrics and coloureds**, without bleaching agent and often also without whiteners
- **Detergents for wool**, without bleach or enzymes, which will not damage wool fibres.
- **Detergents for net curtains**, with optical whiteners and substances which prevent the curtains from yellowing in sunlight.
- **Building-block-system detergents** which allow separate dosing of the basic detergent, water softener and bleaching agent.
- **Water softening agents** to reduce the hardness of tap water.
- **Bleaching agents or stain removing salts**, for concentrated use on stains or as an additive with bleach-free detergents.
- **Pre-treatment agents**, for removing stains prior to washing.
- **Fabric softeners**, to eliminate static charge for easy cares and to make fabrics feel soft.
- **Starches and dressing agents**, to make garments hold their shape and make them easier to iron.
- **Dyes and colour removers** may be used in the washing machine only if indicated on the product pack.

The amount of detergent used depends on the size of load, water hardness and degree of soiling. Refer to the instructions on the products. Information on the hardness of water in residential areas can be obtained from the Local Water Authorities.

### Amount of detergent

Water hardness		
Level of hardness	Clarke degrees	°T.H. (French degrees)
I - soft	less than 8	less than 13
II - medium	8-14	13-24
III - hard	15-21	25-36
IV - very hard	more than 21	more than 36

If the detergent manufacturer gives no indication of how much detergent to use for a part load, we recommend that you reduce the detergent measure by 1/3rd for a half load and that you use a half measure of detergent for a minimum load.

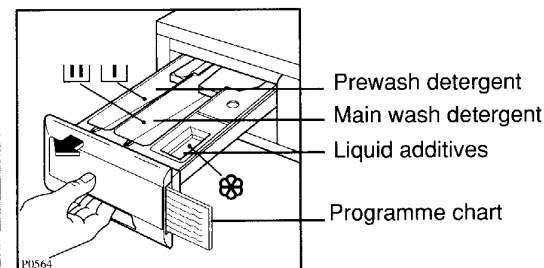

### Using the detergent

- The **washing powder** should be placed in the appropriate compartments of the drawer.
- If you prefer **liquid detergents**, use the dispenser supplied with the product.
- The measure of liquid additive used **must not exceed the 'MAX' level mark on the dispenser drawer**.
- If **thick fabric softeners or concentrated starches** are used, it is advisable to dilute them by pouring water into the dispenser compartment, up to the 'MAX' level mark.
- On the programme chart you will find the main washing and drying programmes.

### Powder detergents

### Liquid detergents

### Liquid additives

### Programme chart

## Free Manuals Download Website

<http://myh66.com>

<http://usermanuals.us>

<http://www.somanuals.com>

<http://www.4manuals.cc>

<http://www.manual-lib.com>

<http://www.404manual.com>

<http://www.luxmanual.com>

<http://aubethermostatmanual.com>

Golf course search by state

<http://golfingnear.com>

Email search by domain

<http://emailbydomain.com>

Auto manuals search

<http://auto.somanuals.com>

TV manuals search

<http://tv.somanuals.com>